

IGNITION

EPS-IGN22Q1

• ACCENSIONE • ALLUMAGE • ZÜNDUNG • ENCENDIDO

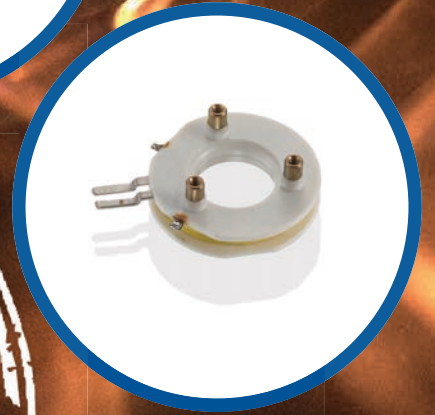

IATF 16949

*Manufacturer of
automobile spare parts*



catalogo.facet.eu/eps



Facet srl © Copyright 2015













Automotive spare parts manufacturer since 1946















INDEX

•INDICE •CONTENU •INHALT •CONTENIDO

EPS-IGN22Q1

CATALOGUES BY PRODUCT CATEGORY		PAGE
	-CATALOGHI PER LINEE DI PRODOTTO -CATALOGUES PAR FAMILLE PRODUIT -KATALOGE NACH PRODUKTENGRUPPEN -CATALOGOS POR FAMILIA PRODUCTO	4
PRODUCT CATEGORIES BY CATALOGUE		
	-LINEE PRODOTTI PER CATALOGO -FAMILLES PRODUIT PAR CATALOGUE -PRODUKTENGRUPPE NACH KATALOG -FAMILIAS PRODUCTO POR CATALOGO	5
NEW ITEMS AND THEIR AVAILABILITY		
	-NUOVI ARTICOLI E LORO DISPONIBILITÀ -NOUVEAUX PRODUITS ET LEURS DISPONIBILITÉ -NEUE TEILE UND IHRE VERFÜGBARKEIT -NOVEDADES Y SU DISPONIBILIDAD	6
APPLICATION LIST		
EXPLICATION TO APPLICATION LIST		
	-SPIEGAZIONE ALLA GUIDA APPLICAZIONI -EXPLICATION À LA LISTE D'APPLICATIONS -ERKLÄRUNG ZUR ANWENDUNGSTABELLE -EXPLICACIÓN A LA LISTA DE APLICACIONES	12
VEHICLE MANUFACTURERS INDEX		
	-INDICE COSTRUTTORI VEICOLI -LISTE DES FABRICANTS VEHICULES -INHALTSVERZEICHNIS DER FAHRZEUGHERSTELLER -LISTA DE FABRICANTES DE VEHICULOS	13
BODY DESIGN		
	-TIPI DI CARROZZERIA -TYPES DE CARROSSERIE -KAROSSERIETYPEN -TIPOS DE CARROCERIA	15
APPLICATION LIST		
	-GUIDA APPLICAZIONI -LISTE D'APPLICATIONS -ANWENDUNGSTABELLE -LISTA DE APLICACIONES	16
GLOSSARY OF FUNCTIONS ON THE VEHICLE		
	-GLOSSARIO PER FUNZIONI SU VETTURA -GLOSSAIRE DES FONCTIONS SUR LE VÉHICULE -GLOSSAR NACH FUNKTION IN AUTO -GLOSSARIO DE LAS FUNCIONES EN LOS VEHICULOS	957
PRODUCTS BY VEHICLE MANUFACTURER		
	-ELENCO PRODOTTI PER MARCA -PRODUITS PAR FABRICANT VEHICULE -LISTE DER PRODUKTE JE NACH FAHRZEUGMARKE -PRODUCTOS POR FABRICANTE VEHÍCULO	958
APPLICATION LIST GLOSSARY		
	-GLOSSARIO GUIDA APPLICAZIONI -GLOSSAIRE LISTE D'APPLICATIONS -GLOSSAR DER VERWENDUNGSLISTE -GLOSSARIO LISTA DE APLICACIONES	974

ILLUSTRATED SECTION		
	CONDENSERS -CONDENSATORI -CONDENSATEURS -KONDENSATOREN -CONDENSADORES	980
	CONTACT SETS -COPPIE CONTATTI -RUPTEURS -KONTAKTSÄTZE -PLATINOS	985
	DISTRIBUTOR CAPS -CALOTTE -TETES D'ALLUMEUR -VERTEILERKAPPEN -TAPAS DEL DISTRIBUIDOR	999
	ROTORS -DISTRIBUTORI -DISRUPTEURS -VERTEILERLÄUFER -ROTORES DEL DISTRIBUIDOR	1045
	DIFFERENTIAL PRESSURE SENSORS -SENSORI DI PRESSIONE ARIA DIFFERENZIALE -CAPTEURS DE PRESSION D'AIR DIFFERENTIEL -DIFFERENZDRUCKSENSOREN -SENSORES DE PRESIÓN DIFERENCIAL (DPS)	1082
	PICK-UPS -IMPULSORI -CAPTEURS -IMPULSGEBER -CAPTADORES	1137
	IGNITION MODULES -MODULI DI ACCENSIONE -MODULES D'ALLUMAGE -ZÜNDMODULE -MÓDULOS DE ENCENDIDO	1146
	IGNITION COILS -BOBINE DI ACCENSIONE -BOBINES D'ALLUMAGE -ZÜNDSPULEN -BOBINAS DE ENCENDIDO	1153
CROSS REFERENCE LIST OEM/OES		
	-TABELLA COMPARATIVA OEM/OES -TABLE COMPARAISON OEM/OES -VERGLEICHSTABELLE OEM/OES -TABLA DE EQUIVALENCIAS OEM/OES	1244
CROSS REFERENCE LIST OTHER MANUFACTURERS		
	-TABELLA COMPARATIVA ALTRI COSTRUTTORI -TABLE COMPARAISON D'AUTRES FABRICANTS -VERGLEICHSTABELLE ANDERE HERSTELLER -TABLA DE EQUIVALENCIAS OTRAS FABRICANTES	1272
VARIATIONS COMPARED TO PREVIOUS CATALOGUE EDITION		
	-VARIAZIONI RISPETTO AI PRECEDENTI CATALOGHI -VARIATIONS RAPPORTÉES AUX CATALOGUES PRÉCÉDENTS -ÄNDERUNGEN IM VERGLEICH ZU FRÜHERE KATALOGAUSGABEN -VARIACIONES CON RESPECTO A CATALOGOS ANTERIORES	1292
GENERAL SALES TERMS		
	-CONDIZIONI GENERALI DI VENDITA -CONDITIONS GÉNÉRALES DE VENTE -ALLGEMEINE VERKAUFSBEDINGUNGEN -CONDICIONES GENERALES DE VENTA	1298
OUR PACKAGING UNITS		
	-LE NOSTRE CONFEZIONI -NOS UNITÉS DE CONDITIONNEMENT -UNSERE ABPACKENTYPEN -NUESTROS ENVASES	1303



PRODUCT CATEGORIES BY CATALOGUE

EPS-IGN22Q1

-LINEE PRODOTTI PER CATALOGO -FAMILLES PRODUIT PAR CATALOGUE -PRODUKTENGRUPPE NACH KATALOG -FAMILIAS PRODUCTO POR CATALOGO











Code	PICTURE	Catalogue	Description
1.1xx.xxx		●	CONDENSERS -CONDENSATORI -CONDENSATEURS -KONDENSATOREN -CONDENSADORES
1.2xx.xxx		●	CONTACT SETS -COPPIE CONTATTI -RUPTEURS -KONTAKTSÄTZE -PLATINOS
1.3xx.xxx		●	DISTRIBUTOR CAPS -CALOTTE -TETES D'ALLUMEUR -VERTEILERKAPPEN -TAPAS DEL DISTRIBUIDOR
1.4xx.xxx		●	ROTORS -DISTRIBUTORI -DISRUPTEURS -VERTEILERLÄUFER -ROTORES DEL DISTRIBUIDOR
1.499.xxx		●	IGNITION CABLE SETS -SERIE CAVI ACCENSIONE COMPLETA -JEUX CABLES D'ALLUMAGE -ZÜNDKABELSÄTZE -JUEGOS DE CABLES DE ENCENDIDO
1.800.xxx		●	ENGINE OIL PRESSURE WARNING LIGHT SWITCHES -INTERRUTTORI SPIA PRESSIONE OLIO -MANOCONTACTS POUR TEMOIN DE PRESSION D'HUILE -ÖLDRUCKKONTROLLSCHALTER -MANOCONTACTO LUZ TESTIGO DE PRESIÓN DE ACEITE
1.800.6xx		●	OIL PRESSURE SENSORS -TRASMETTITORI PRESSIONE OLIO -TRANSMETTEURS DE PRESSION D'HUILE -ÖLDRUCK-IMPULSGEBER -TRANSMISORES DE PRESSION DE ACEITE
1.810.xxx		●	BRAKE/CLUTCH PEDAL SWITCHES -INTERRUTTORI PEDALI FRENO/FRIZIONE -CONTACTEURS DE FEUX STOP -BREMS-/ KUPPLUNGSPEDALSCHALTER -INTERRUPTORES PEDAL DE FRENO/EMBRAGUE
1.830.xxx		●	COOLANT/OIL/FUEL TEMPERATURE SENDERS -SENSORI DI TEMPERATURA REFRIGERANTE/OLIO/CARBURANTE -CAPTEURS DE TEMPERATURE REFRIGERANT/HUILE/CARBURANTS -TEMPERATURESENSOR FÜR KÜHLMITTEL/ÖL/KRAFTSTOFF -SENSORES DE TEMPERATURA REFRIGERANTE/ACEITE/COMBUSTIBLE
1.830.xxx		●	WATER TEMPERATURE SENDERS WITH WARNING LIGHT SWITCH -TRASMETTITORI CON SPIA TEMPERATURA ACQUA -THERMORESISTANCES AVEC CONTACTEUR POUR TEMOIN TEMPERATURE D'EAU -WASSERTEMPERATUR- IMPULSGEBER MIT KONTROLLICHTSCHALTER -SENSORES DE TEMPERATURA REFRIGERANTE CON INTERRUPTOR PARA LUZ TESTIGO
1.840.xxx		●	WATER TEMPERATURE WARNING LIGHT SWITCHES -INTERRUTTORI COMANDO SPIA TEMPERATURA ACQUA -THERMOCONTACTS POUR TEMOIN TEMPERATURE D'EAU -WASSERTEMPERATUR-KONTROLLICHTSCHALTER -THERMOCONTACTOS LUZ TESTIGO TEMPERATURA DEL AGUA
1.850.xxx		●	THERMO-SWITCHES FOR ELECTRIC FANS -THERMOINTERRUTTORI PER ELETTROVENTILATORI -THERMOCONTACTS D'ELECTROVENTILATEURS -THERMO-SCHALTER FÜR LÜFTERMOTOR -THERMOCONTACTOS PARA ELECTROVENTILADORES
1.850.6xx		●	THERMO-SWITCHES FOR DOUBLE FAN OR TWO SPEEDS -THERMOINTERRUTTORI PER ELETTROVENTILATORE DOPPIO O A DUE VELOCITÀ -THERMOCONTACTS POUR DOUBLE VENTILATEUR OU A DEUX VITESSES -THERMO-SCHALTER FÜR DOPPELBEFÜHRER ODER FÜR ZWEIFANG-LÜFTERMOTOR -THERMOCONTACTOS PARA DOBLE VENTILADOR O DE DOS VELOCIDADES
1.860.xxx		●	REVERSING LIGHT SWITCHES -INTERRUTTORI LUCI RETROMARCIA -CONTACTEURS FEUX DE REcul -RÜCKFAHR-SCHWERTWERFER-SCHALTER -INTERRUPTORES DE LUZ MARCHA ATRAS
1.880.xxx		●	THERMOSTATS -THERMOSTATI -THERMOSTATS -THERMOSTATE -THERMOSTATOS
1.890.xxx		●	GASKETS FOR THERMOSTATS -GUARNIZIONI PER THERMOSTATI -JOINTS POUR THERMOSTATS -DICHTUNGEN FÜR THERMOSTATEN -JUNTAS POR THERMOSTATOS
1.9xx.xxx		●	PICK-UPS -IMPULSORI -CAPTEURS -IMPULSGEBER -CAPTADORES
1.953.xxx		●	REVOLUTION AND TIMING (CKP AND CMP) SENSORS -SENSORI GIRI MOTORE E TRASMISSIONE -CAPTEURS DE REGIME ET DE POSITION -DREHZAHL- UND GETRIEBESSENSOREN -SENSORES DE REVOLUCIONES Y POSICIÓN DE CIGÜENAL Y ÁRBOL DE LEVAS
1.957.xxx		●	KNOCK SENSORS -SENSORI DI DETONAZIONE -CAPTEURS DE CLIQUETIS -KLOPFSENSOREN -SENSORES DE PICADO
1.96x.xxx		●	IGNITION MODULES -MODULI DI ACCENSIONE -MODULES D'ALLUMAGE -ZÜNDMODULE -MÓDULOS DE ENCENDIDO
1.970.xxx		●	IGNITION COILS -BOBINE DI ACCENSIONE -BOBINES D'ALLUMAGE -ZÜNDSPULEN -BOBINAS DE ENCENDIDO
1.990.xxx		●	ELECTRONIC IGNITION KITS -KIT PER ACCENSIONE ELETTRONICA -KIT POUR ALLUMAGE ELECTRONIQUES -ELEKTRONISCHE ZÜNDUNGSSATZ -JUEGOS DE ENCENDIDO ELECTRÓNICO
1.991.xxx		●	MASS AIR FLOW METERS (MAF) -SENSORI DI PORTATA ARIA (MAF) -CAPTEURS DE MASSE D'AIR -LUFTMASSENMESSER -CAUDALIMETROS
1.993.xxx		●	AIR PRESSURE SENSORS -SENSORI DI PRESSIONE ARIA -CAPTEURS DE PRESSION D'AIR -DRUCKSENSOREN -SENSORES DE PRESIÓN DEL AIRE
1.994.xxx		●	AIR TEMPERATURE SENSORS -SENSORI DI TEMPERATURA DELL'ARIA -CAPTEURS DE TEMPERATURE D'AIR -LUFTTEMPERATUR-SENSOREN -THERMORESISTENCIAS PARA TEMPERATURA DE AIRE
1.995.xxx		●	THROTTLE POSITION SENSORS -SENSORI DI POSIZIONE FARFALLA -SONDES DE POSITION DU PAPILLON -DROSSELKLAPPEN-POSITIONS-SENSOREN -SENSORES DE POSICION DE LA MARIPOSA
1.997.xxx 1.998.xxx		●	OXYGEN SENSORS -SONDE LAMBDA -SONDES DE RICHESSE -LAMBDA-SONDEN -SONDAS LAMBDA
1.960.xxx		●	WHEEL SPEED SENSORS -SENSORI DI NUMERO DI GIRI RUOTA -CAPTEURS ABS -RADDREHZAHLSSENSOR -SENSORES DE REVOLUCIONES DE RUEDA
1.220.xxx		●	EXHAUST GAS TEMPERATURE SENSORS (EGT) -SENSORI DI TEMPERATURA GAS DI SCARICO (EGT) -CAPTEURS DE TEMPERATURE GAS D'ECHAPPEMENT (EGT) -ABGASTEMPÉRATURSENSOREN (EGT) -SENSORES DE TEMPERATURA GASES DE ESCAPE (EGT)
1.963.xxx		●	EGR VALVES -VALVOLE EGR -EGR VALVES -ABGASRÜCKFÜHRUNGVENTILE -VALVULAS EGR



PRODUCT CATEGORIES BY CATALOGUE

EPS-IGN22Q1

•LINEE PRODOTTI PER CATALOGO •FAMILLES PRODUIT PAR CATALOGUE •PRODUKTENGRUPPE NACH KATALOG •FAMILIAS PRODUCTO POR CATALOGO

CATALOGUE •Catalogo •Catalogue •Katalog •Catalogo			Code
	<p>EPS-IGNxxxx</p> <p>Ignition •Accensione •Allumage •Zündung •Encendido</p>		<p>1.1xx.xxx</p> <p>1.2xx.xxx</p> <p>1.3xx.xxx</p> <p>1.4xx.xxx</p> <p>1.499.xxx</p> <p>1.9xx.xxx</p> <p>1.96x.xxx</p> <p>1.970.xxx</p> <p>1.990.xxx</p>
	<p>EPS-SWxxxx</p> <p>Switches •Interruttori •Interrupteurs •Schalter •Interruptores</p>		<p>1.800.xxx</p> <p>1.800.6xx</p> <p>1.810.xxx</p> <p>1.860.xxx</p>
	<p>EPS-TMxxxx</p> <p>Thermal management •Gestione termica •Gestion thermique •Thermo-management •Gestió tèrmica</p>		<p>1.830.xxx</p> <p>1.830.5xx</p> <p>1.840.xxx</p> <p>1.850.xxx</p> <p>1.850.6xx</p> <p>1.880.xxx</p> <p>1.890.xxx</p>
	<p>EPS-SENxxxx</p> <p>Sensors •Sensori •Capteurs •Sensoren •Sensores</p>		<p>1.953.xxx</p> <p>1.957.xxx</p> <p>1.991.xxx</p> <p>1.993.xxx</p> <p>1.994.xxx</p> <p>1.995.xxx</p> <p>1.960.xxx</p>
	<p>EPS-EMxxxx</p> <p>Exhaust management •Gestione gas di scarico •Gestion des gaz d'échappement •Abgas-management •Gestió de gas de escape</p>		<p>1.993.xxx</p> <p>1.997.xxx</p> <p>1.998.xxx</p> <p>1.220.xxx</p> <p>1.963.xxx</p>

NEW ITEMS AND THEIR AVAILABILITY

EPS-IGN22Q1

-Nuovi articoli e loro disponibilità -Nouveaux produits et leur disponibilité -Neue Teile und vorläufige Verfügbarkeit -Novedades y su disponibilidad

CONDENSERS

CONDENSATORI
CONDENSATEURS
KONDENSATOREN
CONDENSADORES



Products listed by date of availability

-Articoli raggruppati per data di **disponibilità**
-Produits groupés par date de **disponibilité**
-Produkte je nach **Verfügbarkeitsdatum** aufgelistet
-Artículos agrupados se gún fecha de **disponibilidad**

AVAILABILITY	CODE

CONTACT SETS

COPPIE CONTATTI
RUPTEURS
KONTAKTSÄTZE
PLATINOS

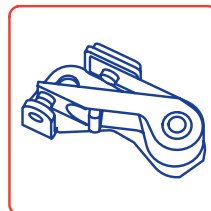

Products listed by date of availability

-Articoli raggruppati per data di **disponibilità**
-Produits groupés par date de **disponibilité**
-Produkte je nach **Verfügbarkeitsdatum** aufgelistet
-Artículos agrupados se gún fecha de **disponibilidad**

AVAILABILITY	CODE

Products listed by code sequence

-Articoli in ordine di **codice**
-Articles en sequence de **réf.**
-Produkte je nach **Artikel-Nr.**
-Artículos en secuencia de **codigo**

CODE	AVAILABILITY

Products listed by code sequence

-Articoli in ordine di **codice**
-Articles en sequence de **réf.**
-Produkte je nach **Artikel-Nr.**
-Artículos en secuencia de **codigo**

CODE	AVAILABILITY



AVAILABLE

NEW ITEMS AND THEIR AVAILABILITY

EPS-IGN22Q1

-Nuovi articoli e loro disponibilità -Nouveaux produits et leur disponibilité -Neue Teile und vorläufige Verfügbarkeit -Novedades y su disponibilidad

DISTRIBUTOR CAPS

CALOTTE
TETES D'ALLUMEUR
VERTEILERKAPPEN
TAPAS DEL DISTRIBUIDOR

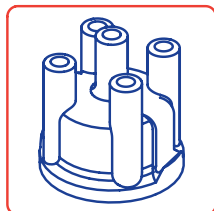

Products listed by date of availability

-Articoli raggruppati per data di **disponibilità**
-Produits groupés par date de **disponibilité**
-Produkte je nach **Verfügbarkeitsdatum** aufgelistet
-Artículos agrupados se gún fecha de **disponibilidad**

AVAILABILITY	CODE

ROTORS

DISTRIBUTORI
DISRUPTEURS
VERTEILERLÄUFER
ROTORES DEL DISTRIBUIDOR

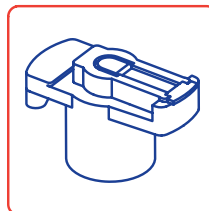

Products listed by date of availability

-Articoli raggruppati per data di **disponibilità**
-Produits groupés par date de **disponibilité**
-Produkte je nach **Verfügbarkeitsdatum** aufgelistet
-Artículos agrupados se gún fecha de **disponibilidad**

AVAILABILITY	CODE

Products listed by code sequence

-Articoli in ordine di **codice**
-Articles en sequence de **réf.**
-Produkte je nach **Artikel-Nr.**
-Artículos en secuencia de **codigo**

CODE	AVAILABILITY

Products listed by code sequence

-Articoli in ordine di **codice**
-Articles en sequence de **réf.**
-Produkte je nach **Artikel-Nr.**
-Artículos en secuencia de **codigo**

CODE	AVAILABILITY



AVAILABLE

NEW ITEMS AND THEIR AVAILABILITY

EPS-IGN22Q1

-Nuovi articoli e loro disponibilità -Nouveaux produits et leur disponibilité -Neue Teile und vorläufige Verfügbarkeit -Novedades y su disponibilidad

IGNITION KIT

KIT ACCENSIONE
KIT ALLUMAGE
ZÜNDUNGSÄTZE
JUEGOS DE ENCENDIDO

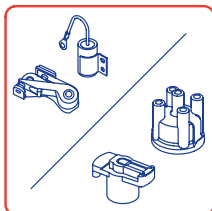

Products listed by date of availability

-Articoli raggruppati per data di **disponibilità**
-Produits groupés par date de **disponibilité**
-Produkte je nach **Verfügbarkeitsdatum** aufgelistet
-Artículos agrupados se gún fecha de **disponibilidad**

AVAILABILITY	CODE

IGNITION CABLE SETS

SERIE CAVI ACCENSIONE COMPLETA
JEUX CABLES D'ALLUMAGE
ZÜNDKABELSÄTZE
JUEGOS DE CABLES DE ENCENDIDO

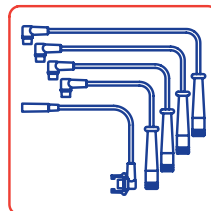

Products listed by date of availability

-Articoli raggruppati per data di **disponibilità**
-Produits groupés par date de **disponibilité**
-Produkte je nach **Verfügbarkeitsdatum** aufgelistet
-Artículos agrupados se gún fecha de **disponibilidad**

AVAILABILITY	CODE

Products listed by code sequence

-Articoli in ordine di **codice**
-Articles en sequence de **réf.**
-Produkte je nach **Artikel-Nr.**
-Artículos en secuencia de **codigo**

CODE	AVAILABILITY

Products listed by code sequence

-Articoli in ordine di **codice**
-Articles en sequence de **réf.**
-Produkte je nach **Artikel-Nr.**
-Artículos en secuencia de **codigo**

CODE	AVAILABILITY



AVAILABLE

NEW ITEMS AND THEIR AVAILABILITY

EPS-IGN22Q1

-Nuovi articoli e loro disponibilità -Nouveaux produits et leur disponibilité -Neue Teile und vorläufige Verfügbarkeit -Novedades y su disponibilidad

PICK-UPS

IMPULSORI
CAPTEURS
IMPULSGEBER
CAPTADORES

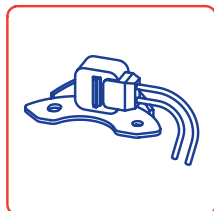

Products listed by date of availability

-Articoli raggruppati per data di **disponibilità**
-Produits groupés par date de **disponibilité**
-Produkte je nach **Verfügbarkeitsdatum** aufgelistet
-Artículos agrupados se gún fecha de **disponibilidad**

AVAILABILITY	CODE

IGNITION MODULES

MODULI DI ACCENSIONE
MODULES D'ALLUMAGE
ZÜNDMODULE
MÓDULOS DE ENCENDIDO

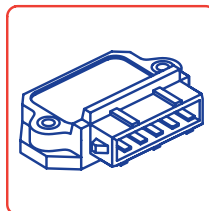

Products listed by date of availability

-Articoli raggruppati per data di **disponibilità**
-Produits groupés par date de **disponibilité**
-Produkte je nach **Verfügbarkeitsdatum** aufgelistet
-Artículos agrupados se gún fecha de **disponibilidad**

AVAILABILITY	CODE

Products listed by code sequence

-Articoli in ordine di **codice**
-Articles en sequence de **réf.**
-Produkte je nach **Artikel-Nr.**
-Artículos en secuencia de **codigo**

CODE	AVAILABILITY

Products listed by code sequence

-Articoli in ordine di **codice**
-Articles en sequence de **réf.**
-Produkte je nach **Artikel-Nr.**
-Artículos en secuencia de **codigo**

CODE	AVAILABILITY



AVAILABLE

NEW ITEMS AND THEIR AVAILABILITY

EPS-IGN22Q1

-Nuovi articoli e loro disponibilità -Nouveaux produits et leur disponibilité -Neue Teile und vorläufige Verfügbarkeit -Novedades y su disponibilidad

IGNITION COILS

BOBINE DI ACCENSIONE
BOBINES D'ALLUMAGE
ZÜNDSPULEN
BOBINAS DE ENCENDIDO

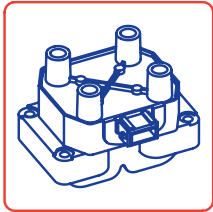

Products listed by code sequence

-Articoli in ordine di **codice**
-Articles en sequence de **réf.**
-Produkte je nach **Artikel-Nr.**
-Artículos en secuencia de **codigo**

CODE	AVAILABILITY
1.970.536	😊
1.970.538	😊
1.970.545	22/04
1.970.547	😊
1.970.549	😊
1.970.551	😊
1.970.596	😊
1.970.599	😊
1.970.602	😊
1.970.609	😊
1.970.613	😊
1.970.619	😊
1.970.620	😊
1.970.621	😊
1.970.622	😊
1.970.623	😊
1.970.626	😊
1.970.627	😊
1.970.631	😊
1.970.632	😊
1.970.636	😊
1.970.638	😊
1.970.645	😊
1.970.647	😊

Products listed by date of availability

-Articoli raggruppati per data di **disponibilità**
-Produits groupés par date de **disponibilité**
-Produkte je nach **Verfügbarkeitsdatum** aufgelistet
-Artículos agrupados se gún fecha de **disponibilidad**

AVAILABILITY	CODE
😊	1.970.536
😊	1.970.538
😊	1.970.547
😊	1.970.549
😊	1.970.551
😊	1.970.596
😊	1.970.599
😊	1.970.602
😊	1.970.609
😊	1.970.613
😊	1.970.619
😊	1.970.620
😊	1.970.621
😊	1.970.622
😊	1.970.623
😊	1.970.626
😊	1.970.627
😊	1.970.631
😊	1.970.632
😊	1.970.636
😊	1.970.638
😊	1.970.645
😊	1.970.647
22/04	1.970.545



AVAILABLE

APPLICATION LIST

EPS-IGN22Q1

·GUIDA APPLICAZIONI ·LISTE D'APPLICATIONS ·ANWENDUNGSTABELLE ·LISTA DE APLICACIONES

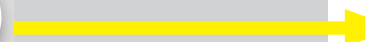
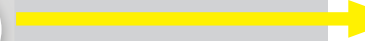



EXPLICATION TO APPLICATION LIST

EPS-IGN22Q1

-SPIEGAZIONE ALLA GUIDA APPLICAZIONI -EXPLICATION À LA LISTE D'APPLICATIONS -ERKLÄRUNG ZUR ANWENDUNGSTABELLE -EXPLICACIÓN DE LA LISTA APLICACIONES

Fuel type

- Tipo carburante
- Carburant
- Kraftstoffart
- Tipo combustible

Vehicle production date

- Date di produzione del veicolo
- Date de production du véhicule
- Fahrzeugherstelldatum
- Fecha de producción del vehículo

Manufacturer

- Fabricante
- Constructeur
- Hersteller
- Fabricante

Car Models

- Modelli
- Modèles
- Modellen
- Modelos

Capacity

- Cilindrata
- Cilindrée
- Hubraum
- Cilindrada

Engine

- Motore
- Moteur
- Motor
- Motor

kW

- kW
- kW
- kW
- kW

Differentiation

- Variante
- Variante
- Abänderungsangabe
- Variación

EPS

Function on the vehicle

- Funzione su vettura
- Fonction sur le véhicule
- Funktion im Auto
- Funciones en los vehículos

Vehicle	a. im.	kW	Date	Engine	FUNCTIONS ON THE VEHICLE													
					A10	A20	A40	A50	A70	C10 - C30	C20	E01						
100 II																		
1.6	Petrol	63	08/76-07/82	ENGINE YV														
Engine Information					A10	A20	A40	A50	A70	C10 - C30	C20	E01						
All engines						1.206.069												
100 III																		
1.8	Petrol	55	08/82-12/87	ENGINE DR, RS														
Engine Information					A10	A20	A40	A50	A70	C10 - C30	C20	E01						
All engines						1.206.069												
Eng. DR							1.306.079	1.406.055R										
Eng. DR										1.970.132	C10	1.965.004						
1.8																		
1.8	Petrol	65	02/86-07/90	ENGINE SH														
Engine Information					A10	A20	A40	A50	A70	C10 - C30	C20	E01						
All engines							1.306.266	1.406.055R	1.906.219									
version Bosch										1.970.127	C10	1.965.007	1.500.768					
All engines																		
1.8																		
1.8	Petrol	66	08/83-12/90	ENGINE DS, JW, NP														
Engine Information					A10	A20	A40	A50	A70	C10 - C30	C20	E01						
All engines						1.206.069				1.970.127	C10	1.965.007	1.500.768					
All engines							1.306.129	1.406.055R	1.906.219									
Eng. NP							1.306.266											
Eng. DS, NP							1.315.068	1.415.099R										
version Ducellier																		
1.8 Cat																		
1.8 Cat	Petrol	66	03/85-11/90	ENGINE 4B, PH														
Engine Information					A10	A20	A40	A50	A70	C10 - C30	C20	E01						
All engines							1.306.266	1.406.055R	1.906.219									
All engines										1.970.127	C10	1.965.007	1.500.768					
version Bosch																		

A10 CONDENSER	A20 CONTACT SET	A40 DISTRIBUTOR CAP	A50 ROTOR	A70 PICK-UP
C10 COIL	C20 IGNITION MODULE	C30 ELECTRONIC IGNITION KIT	E01 IGNITION CABLE SET	

The present application list is a brief version. For the detailed information about the possibility of installation on a specific vehicle, please refer to our web-catalogue <http://catalogo.facet.eu/>



VEHICLE MANUFACTURERS INDEX

EPS-IGN22Q1

-INDICE COSTRUTTORI VEICOLI -LISTE DES FABRICANTS VEHICULES -INHALVERZEICHNIS DER FAHRZEUGHERSTELLER -LISTA DE FABRICANTES DE VEHICULOS

Manufacturer	Page	Manufacturer	Page	Manufacturer	Page	Manufacturer	Page
A		G		O		Z	
ABARTH	16	GINETTA	314	OPEL	556	ZASTAVA	956
ACURA	17	H		P			
ALFA ROMEO	18	HOLDEN	315	PEUGEOT	597		
ALPINA	35	HONDA	322	PIAGGIO	635		
ALPINE	36	HYUNDAI	344	PORSCHE	636		
ASTON MARTIN	37	I		PUCH	643		
AUDI	38	INFINITI	372	R			
AUSTIN	84	INNOCENTI	375	RELIANT	644		
AUSTIN-HEALEY	86	ISUZU	376	RENAULT	645		
B		IVECO	377	RILEY	703		
BEDFORD	87	J		ROLLS-ROYCE	704		
BENTLEY	88	JAGUAR	379	ROVER	705		
BMW	89	JEEP	382	S			
BOND	148	JENSEN	384	SAAB	714		
BORGWARD	149	K		SEAT	718		
C		KIA	385	SKODA	740		
CHEVROLET	150	L		SMART	754		
CHRYSLER	158	LADA	405	SSANGYONG	758		
CITROËN	162	LANCIA	406	SUBARU	760		
CUPRA	199	LAND ROVER	417	SUZUKI	767		
D		LEXUS	420	T			
DACIA	200	LOTUS	427	TALBOT	782		
DAEWOO	210	M		TOYOTA	783		
DAIHATSU	215	MAN	428	TRIUMPH	822		
DAIMLER	219	MARUTI	429	TVR	825		
DS	220	MASERATI	430	V			
F		MAZDA	431	VAUXHALL	826		
FIAT	222	MERCEDES-BENZ	454	VOLKSWAGEN (BR)	850		
FIAT (BR)	266	MG	507	VOLVO	852		
FORD	269	MINI	510	VW	886		
FORD (BR)	309	MITSUBISHI	514	W			
FORD AUSTRALIA	310	MORRIS	532	WOLSELEY	954		
FORD USA	312	N		Y			
FSO	313	NISSAN	533	YUGO	955		
		NSU	555				



BODY DESIGN

EPS-IGN22Q1

-TIPI DI CARROZZERIA -TYPES DE CARROSSERIE -KAROSSERIETYPEN -TIPOS DE CARROCERIA



Hatchback

- Coda spiovente
- Fastback
- Schräger
- Fastback



Station Wagon

- Familiare
- Break
- Kombi
- Ranchera familiar



MPV

- Monovolume
- Monospace
- Großraumlimousine
- Limusina



Closed off-road vehicle

- Fuori strada chiuso
- Véhicule tout terrain à carrosserie fermée
- Geländewagen geschlossen
- Todo terreno, cerrada



Bus

- Autobus
- Autobus/Autocar
- Bus
- Autobús



Flatbed/Chassis

- Pianale piatto/Autotelaio
- Camion plate-forme/Chassis
- Pritsche/Fahrgestell
- Caja/Chasis



Saloon

- Tre volumi
- A trois volumes
- Stufenheck
- Sedan



Convertible

- Cabriolet
- Décapotable
- Cabriolet
- Descapotable



Coupe

- Coupé
- Coupé
- Coupe
- Coupé



Open off-road vehicle

- Fuori strada aperto
- Véhicule tout terrain à carrosserie ouverte
- Geländewagen offen
- Todo terreno, abierta



Box

- Furgonato
- Camionette
- Kasten
- Furgón

Vehicle	alim.	kW	Date	Engine	FUNCTIONS ON THE VEHICLE							
					A10	A20	A40	A50	A70	C10 - C30	C20	E01

PUNTO

1.4	Petrol	120	03/12->	ENGINE
				955 A8.000

Engine	Information	A10	A20	A40	A50	A70	C10 - C30	C20	E01
All engines	x 4, COIL ON PLUG						1.970.549	C10	

1.4 SUPERSPORT	Petrol	132	03/12->	ENGINE
				199 A8.000, 955 A8.000

Engine	Information	A10	A20	A40	A50	A70	C10 - C30	C20	E01
Eng. 199 A8.000	Qty: 4						1.970.549	C10	
Eng. 955 A8.000	x 4, COIL ON PLUG						1.970.549	C10	

PUNTO EVO

1.4	Petrol	120	10/09-02/12	ENGINE
				955 A8.000

Engine	Information	A10	A20	A40	A50	A70	C10 - C30	C20	E01
All engines	x 4, COIL ON PLUG						1.970.549	C10	

RITMO

125 TC 2.0	Petrol	92	11/81-12/87	ENGINE
				138 AR1.000

Engine	Information	A10	A20	A40	A50	A70	C10 - C30	C20	E01
All engines	version Marelli				1.430.054R	1.930.161/1			

A10	CONDENSER	A20	CONTACT SET	A40	DISTRIBUTOR CAP	A50	ROTOR	A70	PICK-UP
C10	COIL	C20	IGNITION MODULE	C30	ELECTRONIC IGNITION KIT	E01	IGNITION CABLE SET		

Vehicle	alim.	kW	Date	Engine	FUNCTIONS ON THE VEHICLE							
					A10	A20	A40	A50	A70	C10 - C30	C20	E01

INTEGRA I

				ENGINE
1.6	Petrol	74	01/85-12/90	D16A1, D16A3

Engine	Information	A10	A20	A40	A50	A70	C10 - C30	C20	E01
All engines	->year 31/01/88, version Hitachi			1.322.069					
All engines	->year 31/12/87, version Hitachi				1.422.056				
All engines	01/01/88 ->, ->year 31/12/88, version Hitachi				1.422.082				
All engines	->year 31/12/87						1.970.212	C10	
All engines	01/01/88 ->						1.970.213	C10	1.965.052

				ENGINE
1.6i	Petrol	88	01/85-12/90	D16A8

Engine	Information	A10	A20	A40	A50	A70	C10 - C30	C20	E01
All engines	->year 31/01/88, version Hitachi			1.322.069					
All engines	->year 31/12/87, version Hitachi				1.422.056				
All engines	01/01/88 ->, ->year 31/12/88, version Hitachi				1.422.082				
All engines	->year 31/12/87						1.970.212	C10	
All engines	01/01/88 ->						1.970.213	C10	1.965.052

INTEGRA II

				ENGINE
1.8	Petrol	77	10/90-09/93	F18A2

Engine	Information	A10	A20	A40	A50	A70	C10 - C30	C20	E01
All engines	01/01/92 ->, version Hitachi			1.322.068					
All engines	version Hitachi, no specific info conc. application available				1.422.095, 1.422.097R				
All engines	01/01/92 ->						1.970.214	C10	
All engines	->year 31/12/91						1.970.215	C10	
All engines									1.965.052

INTEGRA III

				ENGINE
1.8 GS-R	Petrol	147	10/93-09/01	F18C2

Engine	Information	A10	A20	A40	A50	A70	C10 - C30	C20	E01
All engines	version Hitachi				1.422.095				
All engines							1.970.214	C10	

				ENGINE
1.8 LS	Petrol	125	10/93-09/01	F18C1

Engine	Information	A10	A20	A40	A50	A70	C10 - C30	C20	E01
All engines	01/01/92 ->, version Hitachi			1.322.068					
All engines	version Hitachi, no specific info conc. application available				1.422.095, 1.422.097R				
All engines	01/01/92 ->						1.970.214	C10	

				ENGINE
1.8 Sport	Petrol	125	10/93-09/01	F18C1









Engine	Information	A10	A20	A40	A50	A70	C10 - C30	C20	E01
All engines	01/01/92 ->, version Hitachi			1.322.068					
All engines	version Hitachi, no specific info conc. application available				1.422.095, 1.422.097R				
All engines	01/01/92 ->						1.970.214	C10	

VIGOR

				ENGINE
2.5	Petrol	140	09/91->	G25A, G25A2

Engine	Information	A10	A20	A40	A50	A70	C10 - C30	C20	E01
All engines	version Hitachi			1.322.084					

A10 CONDENSER	A20 CONTACT SET	A40 DISTRIBUTOR CAP	A50 ROTOR	A70 PICK-UP
C10 COIL	C20 IGNITION MODULE	C30 ELECTRONIC IGNITION KIT	E01 IGNITION CABLE SET	









					FUNCTIONS ON THE VEHICLE								
Vehicle	alim.	kW	Date	Engine	 A10	 A20	 A40	 A50	 A70	 C10 - C30	 C20	 E01	
145													
1.4 i.e.													
	Petrol	66	07/94-12/96	AR 33501									
Engine	Information				A10	A20	A40	A50	A70	C10 - C30	C20	E01	
All engines	x 1, D.I.S., connector type DIN									1.970.146	C10		
1.4 i.e. 16V T.S.													
	Petrol	76	12/96-01/01	AR 33503									
Engine	Information				A10	A20	A40	A50	A70	C10 - C30	C20	E01	
All engines	->VET. 3174687, x 4, SEMI-DIRECT									1.970.386	C10		
All engines	VET. 3174688 ->, x 4, SEMI-DIRECT									1.970.387	C10		
All engines												1.501.608	
1.6 16V T.S.													
	Petrol	82	09/97-12/00	AR 32102									
Engine	Information				A10	A20	A40	A50	A70	C10 - C30	C20	E01	
All engines	x 4, SEMI-DIRECT									1.970.387	C10		
All engines												1.501.608	
1.6 i.e.													
	Petrol	76	10/94-12/96	AR 33201									
Engine	Information				A10	A20	A40	A50	A70	C10 - C30	C20	E01	
All engines	->VET. 3014142, x 1, D.I.S., connector type, saw teeth									1.970.168	C10		
1.6 i.e. 16V T.S.													
	Petrol	88	12/96-01/01	AR 32102, AR 67601									
Engine	Information				A10	A20	A40	A50	A70	C10 - C30	C20	E01	
All engines	->VET. 3174687, x 4, SEMI-DIRECT									1.970.386	C10		
All engines	VET. 3174688 ->, x 4, SEMI-DIRECT									1.970.387	C10		
1.6 LPG													
	LPG	88	01/98-01/01	AR 32102									
Engine	Information				A10	A20	A40	A50	A70	C10 - C30	C20	E01	
All engines	->VET. 3174687, x 4, SEMI-DIRECT									1.970.386	C10		
All engines	VET. 3174688 ->, x 4, SEMI-DIRECT									1.970.387	C10		
1.7 i.e. 16V													
	Petrol	95	10/94-12/96	AR 33401									
Engine	Information				A10	A20	A40	A50	A70	C10 - C30	C20	E01	
All engines	x 1, D.I.S., connector type, saw teeth									1.970.168	C10		
1.8 i.e. 16V													
	Petrol	106	03/98-01/01	AR 32201									
Engine	Information				A10	A20	A40	A50	A70	C10 - C30	C20	E01	
All engines	x 4, SEMI-DIRECT									1.970.387	C10		
All engines												1.501.608	
1.8 i.e. 16V T.S.													
	Petrol	103	12/96-12/98	AR 67106									
Engine	Information				A10	A20	A40	A50	A70	C10 - C30	C20	E01	
All engines	x 2, SEMI-DIRECT									1.970.386	C10		
All engines												1.501.608	
1.8 i.e. 16V T.S. [BRA]													
	Petrol	110	10/96-02/99	AR 67199									
Engine	Information				A10	A20	A40	A50	A70	C10 - C30	C20	E01	
All engines	Qty: 4, without spark plug connector									1.970.386	C10		
All engines	incl. spark plug connector, Qty: 4									1.970.386K	C10		
All engines												1.501.608	
2.0 16V													
	Petrol	114	03/98-01/01	AR 32301									
Engine	Information				A10	A20	A40	A50	A70	C10 - C30	C20	E01	
All engines	x 4, SEMI-DIRECT									1.970.387	C10		
All engines												1.501.608	
2.0 16V T.S.													
	Petrol	110	10/95-01/01	AR 67204									
Engine	Information				A10	A20	A40	A50	A70	C10 - C30	C20	E01	
All engines	x 2, SEMI-DIRECT									1.970.386	C10		
All engines												1.501.608	

A10 CONDENSER	A20 CONTACT SET	A40 DISTRIBUTOR CAP	A50 ROTOR	A70 PICK-UP
C10 COIL	C20 IGNITION MODULE	C30 ELECTRONIC IGNITION KIT	E01 IGNITION CABLE SET	

Vehicle	alim.	kW	Date	Engine	FUNCTIONS ON THE VEHICLE									
					A10	A20	A40	A50	A70	C10 - C30	C20	E01		
ENGINE														
2.0 16V T.SPARK [BRA]	Petrol	110	10/96-02/99	AR 67299										
Engine	Information				A10	A20	A40	A50	A70	C10 - C30	C20	E01		
All engines	without spark plug connector, Qty: 4									1.970.386	C10			
All engines	incl. spark plug connector, Qty: 4									1.970.386K	C10			
All engines													1.501.608	
ENGINE														
2.0 16V T.SPARK Q.V. [BRA]	Petrol	110	10/95-09/96	AR 67299										
Engine	Information				A10	A20	A40	A50	A70	C10 - C30	C20	E01		
All engines	Qty: 4									1.970.386K	C10			
146														
ENGINE														
1.4 i.e.	Petrol	66	12/94-12/96	AR 33501										
Engine	Information				A10	A20	A40	A50	A70	C10 - C30	C20	E01		
All engines	x 1, D.I.S., connector type DIN									1.970.146	C10			
ENGINE														
1.4 i.e. 16V T.S.	Petrol	76	11/96-01/01	AR 33503										
Engine	Information				A10	A20	A40	A50	A70	C10 - C30	C20	E01		
All engines	-> VET. 165088, x 4, SEMI-DIRECT									1.970.386	C10			
All engines	VET. 165089 ->, x 4, SEMI-DIRECT									1.970.387	C10			
All engines													1.501.608	
ENGINE														
1.6 16V T.S.	Petrol	82	09/97-12/00	AR 32102										
Engine	Information				A10	A20	A40	A50	A70	C10 - C30	C20	E01		
All engines	x 4, SEMI-DIRECT									1.970.387	C10			
All engines													1.501.608	
ENGINE														
1.6 i.e. 16V T.S.	Petrol	88	11/96-10/01	AR 32102, AR 67601										
Engine	Information				A10	A20	A40	A50	A70	C10 - C30	C20	E01		
All engines	-> VET. 165088, x 4, SEMI-DIRECT									1.970.386	C10			
All engines	VET. 165089 ->, x 4, SEMI-DIRECT									1.970.387	C10			
Eng. AR 67601													1.501.608	
ENGINE														
1.7 i.e. 16V	Petrol	95	12/94-12/96	AR 33401										
Engine	Information				A10	A20	A40	A50	A70	C10 - C30	C20	E01		
All engines	x 1, D.I.S., connector type, saw teeth									1.970.168	C10			
ENGINE														
1.8 i.e. 16V T.S.	Petrol	103	11/96-01/01	AR 67106										
Engine	Information				A10	A20	A40	A50	A70	C10 - C30	C20	E01		
All engines	x 2, SEMI-DIRECT									1.970.386	C10			
All engines													1.501.608	
ENGINE														
1.8 i.e. 16V T.S.	Petrol	106	03/98-01/01	AR 32201										
Engine	Information				A10	A20	A40	A50	A70	C10 - C30	C20	E01		
All engines	x 4, SEMI-DIRECT									1.970.387	C10			
All engines													1.501.608	
ENGINE														
2.0 16V	Petrol	114	03/97-10/01	AR 32301										
Engine	Information				A10	A20	A40	A50	A70	C10 - C30	C20	E01		
All engines	x 4, SEMI-DIRECT									1.970.387	C10			
All engines													1.501.608	
ENGINE														
2.0 16V T.S.	Petrol	110	10/95-01/01	AR 67204										
Engine	Information				A10	A20	A40	A50	A70	C10 - C30	C20	E01		
All engines	-> year 01/12/96, x 4, SEMI-DIRECT									1.970.386	C10			
All engines	01/03/99 ->, x 4, SEMI-DIRECT									1.970.387	C10			
All engines	01/01/97 ->, -> year 01/02/99, x 4, SEMI-DIRECT												1.501.608	

A10	CONDENSER	A20	CONTACT SET	A40	DISTRIBUTOR CAP	A50	ROTOR	A70	PICK-UP
C10	COIL	C20	IGNITION MODULE	C30	ELECTRONIC IGNITION KIT	E01	IGNITION CABLE SET		

The present application list is a brief version. For the detailed information about the possibility of installation on a specific vehicle, please refer to our web-catalogue <http://catalogo.facet.eu/>

					FUNCTIONS ON THE VEHICLE							
Vehicle	alim.	kW	Date	Engine								
147												
1.6 16V T.SPARK	Petrol	88	01/01-03/10	ENGINE AR 32104								
Engine					A10	A20	A40	A50	A70	C10 - C30	C20	E01
All engines										1.970.397	C10	
All engines												1.501.607
1.6 16V T.SPARK ECO												
Petrol	77	01/01-03/10	ENGINE AR 37203									
Engine					A10	A20	A40	A50	A70	C10 - C30	C20	E01
All engines										1.970.397	C10	
All engines												1.501.607
1.6 LPG												
Petrol/ Liquified Petroleum Gas (LPG)	77	01/09-03/10	ENGINE AR 37203									
Engine					A10	A20	A40	A50	A70	C10 - C30	C20	E01
All engines										1.970.397	C10	
All engines												1.501.607
1.6 LPG												
Petrol/ Liquified Petroleum Gas (LPG)	88	03/01-12/09	ENGINE AR 32104									
Engine					A10	A20	A40	A50	A70	C10 - C30	C20	E01
All engines										1.970.397	C10	
All engines												1.501.607
2.0 16V T.SPARK												
Petrol	110	01/01-03/10	ENGINE AR 32310									
Engine					A10	A20	A40	A50	A70	C10 - C30	C20	E01
All engines										1.970.397	C10	
All engines												1.501.607
3.2 GTA												
Petrol	184	02/03-03/10	ENGINE 932 A.000									
Engine					A10	A20	A40	A50	A70	C10 - C30	C20	E01
All engines										1.970.313	C10	
All engines												1.501.607
155												
1.6 16V T.S.	Petrol	88	05/96-12/97	ENGINE AR 67601								
Engine					A10	A20	A40	A50	A70	C10 - C30	C20	E01
All engines										1.970.386	C10	
All engines										1.970.386K	C10	
All engines												1.501.608
1.7 T.S.												
Petrol	83	04/93-04/96	ENGINE AR 67103									
Engine					A10	A20	A40	A50	A70	C10 - C30	C20	E01
All engines										1.970.168	C10	
All engines												1.500.623
1.7 T.S.												
Petrol	85	04/93-04/96	ENGINE AR 67105									
Engine					A10	A20	A40	A50	A70	C10 - C30	C20	E01
All engines										1.970.168	C10	
All engines												1.500.623
1.7 T.S. 16V												
Petrol	103	05/96-12/97	ENGINE AR 67106									
Engine					A10	A20	A40	A50	A70	C10 - C30	C20	E01
All engines										1.970.386	C10	
All engines										1.970.386K	C10	
All engines												1.501.608
1.8 T.S.												
Petrol	95	02/92-05/94	ENGINE AR 67101									
Engine					A10	A20	A40	A50	A70	C10 - C30	C20	E01
All engines										1.970.168	C10	
All engines												1.500.623

A10 CONDENSER	A20 CONTACT SET	A40 DISTRIBUTOR CAP	A50 ROTOR	A70 PICK-UP
C10 COIL	C20 IGNITION MODULE	C30 ELECTRONIC IGNITION KIT	E01 IGNITION CABLE SET	

Vehicle	alim.	kW	Date	Engine	FUNCTIONS ON THE VEHICLE												
					A10	A20	A40	A50	A70	C10 - C30	C20	E01					
ENGINE																	
1.8 T.S. Sport	Petrol	93	03/92-12/96	AR 67101, AR 67102													
Engine	Information				A10	A20	A40	A50	A70	C10 - C30	C20	E01					
All engines	Qty: 2									1.970.168	C10						
All engines													1.500.623				
ENGINE																	
2.0 16V Turbo Q4	Petrol	137	01/92-12/97	AR 67203													
Engine	Information				A10	A20	A40	A50	A70	C10 - C30	C20	E01					
All engines	Qty: 2									1.970.146	C10						
ENGINE																	
2.0 16V Turbo Q4	Petrol	140	03/92-12/97	AR 67203													
Engine	Information				A10	A20	A40	A50	A70	C10 - C30	C20	E01					
All engines	Qty: 2									1.970.146	C10						
ENGINE																	
2.0 T.S.	Petrol	104	02/92-05/95	AR 67201, AR 67202													
Engine	Information				A10	A20	A40	A50	A70	C10 - C30	C20	E01					
All engines	Qty: 2									1.970.168	C10						
All engines													1.500.623				
ENGINE																	
2.0 T.S.	Petrol	106	02/92-01/95	AR 67201, AR 67202													
Engine	Information				A10	A20	A40	A50	A70	C10 - C30	C20	E01					
All engines	Qty: 2									1.970.168	C10						
All engines													1.500.623				
ENGINE																	
2.0 T.S. 16V	Petrol	110	03/95-12/97	AR 67204, AR 67299													
Engine	Information				A10	A20	A40	A50	A70	C10 - C30	C20	E01					
All engines	without spark plug connector, Qty: 4									1.970.386	C10						
All engines	incl. spark plug connector, Qty: 4									1.970.386K	C10						
All engines													1.501.608				
156																	
ENGINE																	
1.6 16V T.SPARK	Petrol	82	09/97-09/05	AR 32102													
Engine	Information				A10	A20	A40	A50	A70	C10 - C30	C20	E01					
All engines	x 4, SEMI-DIRECT									1.970.387	C10						
All engines													1.501.608				
ENGINE																	
1.6 16V T.SPARK	Petrol	88	09/97-09/05	AR 32102, AR 32103, AR 32104, AR 67601													
Engine	Information				A10	A20	A40	A50	A70	C10 - C30	C20	E01					
Eng. AR 67601	-> VET. 0084340, x 4, SEMI-DIRECT									1.970.386	C10						
Eng. AR 32102, AR 67601	VET. 0084341 ->, x 4, SEMI-DIRECT									1.970.387	C10						
Eng. AR 32103, AR 32104	x 4, COIL ON PLUG									1.970.397	C10						
Eng. AR 32103, AR 32104													1.501.607				
Eng. AR 32102, AR 67601													1.501.608				
ENGINE																	
1.6 16V T.SPARK.	Petrol	81	07/00-07/05	AR 32103													
Engine	Information				A10	A20	A40	A50	A70	C10 - C30	C20	E01					
All engines	without spark plug connector, Qty: 4									1.970.397	C10						
All engines	incl. spark plug connector, Qty: 4									1.970.397K	C10						
All engines													1.501.607				
ENGINE																	
1.6 16V T.SPARK.	Petrol	88	05/00-05/06	AR 32102, AR 32103, AR 32104, AR 67601													
Engine	Information				A10	A20	A40	A50	A70	C10 - C30	C20	E01					
Eng. AR 67601	-> VET. 0084340, x 4, SEMI-DIRECT									1.970.386	C10						
Eng. AR 32102	without spark plug connector, Qty: 4									1.970.387	C10						
Eng. AR 67601	VET. 0084341 ->, x 4, SEMI-DIRECT									1.970.387	C10						
Eng. AR 32102	incl. spark plug connector, Qty: 4									1.970.387K	C10						
Eng. AR 32103	without spark plug connector, Qty: 4									1.970.397	C10						
Eng. AR 32104	x 4, COIL ON PLUG									1.970.397	C10						
Eng. AR 32103	incl. spark plug connector, Qty: 4									1.970.397K	C10						
Eng. AR 32103, AR 32104													1.501.607				
Eng. AR 32102, AR 67601													1.501.608				
A10	CONDENSER	A20	CONTACT SET	A40	DISTRIBUTOR CAP	A50	ROTOR	A70	PICK-UP	C10	COIL	C20	IGNITION MODULE	C30	ELECTRONIC IGNITION KIT	E01	IGNITION CABLE SET

Vehicle	alim.	kW	Date	Engine	FUNCTIONS ON THE VEHICLE									
					A10	A20	A40	A50	A70	C10 - C30	C20	E01		
ENGINE														
1.8 16V T.SPARK	Petrol	103	02/97-05/06	AR 32205										
Engine	Information				A10	A20	A40	A50	A70	C10 - C30	C20	E01		
All engines	euro 2, x 4, SEMI-DIRECT									1.970.387	C10			
All engines	euro 3, x 4, COIL ON PLUG									1.970.397	C10			
ENGINE														
1.8 16V T.SPARK	Petrol	106	09/97-10/00	AR 32201										
Engine	Information				A10	A20	A40	A50	A70	C10 - C30	C20	E01		
All engines	euro 2, x 4, SEMI-DIRECT									1.970.387	C10			
All engines	euro 3, x 4, COIL ON PLUG									1.970.397	C10			
All engines													1.501.608	
ENGINE														
2.0 16V T.SPARK	Petrol	110	10/00-03/02	AR 32310										
Engine	Information				A10	A20	A40	A50	A70	C10 - C30	C20	E01		
All engines	euro 2, x 4, SEMI-DIRECT									1.970.387	C10			
All engines	euro 3, x 4, COIL ON PLUG									1.970.397	C10			
All engines													1.501.607	
ENGINE														
2.0 16V T.SPARK	Petrol	114	09/97-06/02	AR 32301, AR 32310										
Engine	Information				A10	A20	A40	A50	A70	C10 - C30	C20	E01		
Eng. AR 32301	euro 2, x 4, SEMI-DIRECT									1.970.387	C10			
Eng. AR 32301	euro 3, x 4, COIL ON PLUG									1.970.397	C10			
Eng. AR 32310	without spark plug connector, Qty: 4									1.970.397	C10			
Eng. AR 32310	incl. spark plug connector, Qty: 4									1.970.397K	C10			
Eng. AR 32310													1.501.607	
Eng. AR 32301													1.501.608	
ENGINE														
2.0 Twin Spark	Petrol	118	11/97-04/00	AR 32303										
Engine	Information				A10	A20	A40	A50	A70	C10 - C30	C20	E01		
All engines	euro 2, x 4, SEMI-DIRECT									1.970.387	C10			
All engines	euro 3, x 4, COIL ON PLUG									1.970.397	C10			
ENGINE														
2.5 V6 24V	Petrol	140	02/97-08/03	AR 32401										
Engine	Information				A10	A20	A40	A50	A70	C10 - C30	C20	E01		
All engines	x 6, COIL ON PLUG									1.970.313	C10			
ENGINE														
2.5 V6 24V	Petrol	141	02/97-05/06	AR 32405										
Engine	Information				A10	A20	A40	A50	A70	C10 - C30	C20	E01		
All engines	x 6, COIL ON PLUG									1.970.313	C10			
ENGINE														
2.5 V6 24V [BRA]	Petrol	140	10/97-12/01	AR 32402										
Engine	Information				A10	A20	A40	A50	A70	C10 - C30	C20	E01		
All engines	Qty: 6									1.970.313	C10			
ENGINE														
3.2 GTA	Petrol	184	03/02-05/06	932 A.000										
Engine	Information				A10	A20	A40	A50	A70	C10 - C30	C20	E01		
All engines	x 6, COIL ON PLUG									1.970.313	C10			
159														
ENGINE														
1.8 MPI	Petrol	103	06/05-11/11	939 A4.000										
Engine	Information				A10	A20	A40	A50	A70	C10 - C30	C20	E01		
All engines	x 4, COIL ON PLUG									1.970.450	C10			
ENGINE														
1.8 TBi	Petrol	147	05/09-12/12	939 B1.000										
Engine	Information				A10	A20	A40	A50	A70	C10 - C30	C20	E01		
All engines	x 4, COIL ON PLUG									1.970.549	C10			
164														
ENGINE														
2.0 T.S.	Petrol	105	06/87-09/92	AR 06416										
Engine	Information				A10	A20	A40	A50	A70	C10 - C30	C20	E01		
All engines	Qty: 2, version Bosch						1.306.079							

A10 CONDENSER	A20 CONTACT SET	A40 DISTRIBUTOR CAP	A50 ROTOR	A70 PICK-UP
C10 COIL	C20 IGNITION MODULE	C30 ELECTRONIC IGNITION KIT	E01 IGNITION CABLE SET	

Vehicle	alim.	kW	Date	Engine	FUNCTIONS ON THE VEHICLE									
					A10	A20	A40	A50	A70	C10 - C30	C20	E01		
ENGINE														
2.0 T.S.	Petrol	106	09/92-09/98	AR 64103										
ENGINE														
All engines					Information	A10	A20	A40	A50	A70	C10 - C30	C20	E01	
All engines					Qty: 2						1.970.168	C10		
2.0 T.S.	Petrol	109	06/87-09/92	AR 06420										
ENGINE														
All engines					Information	A10	A20	A40	A50	A70	C10 - C30	C20	E01	
All engines					Qty: 2, version Bosch			1.306.079						
2.0 Turbo	Petrol	128	10/87-09/98	AR 06476										
ENGINE														
All engines					Information	A10	A20	A40	A50	A70	C10 - C30	C20	E01	
All engines					version Marelli			1.330.115						
All engines					->year 01/07/90, version Marelli				1.430.055R					
All engines					01/07/90 ->, version Marelli				1.430.059					
2.0 Turbo	Petrol	129	02/88-10/92	AR 06476										
ENGINE														
All engines					Information	A10	A20	A40	A50	A70	C10 - C30	C20	E01	
All engines					version Marelli			1.330.115						
All engines					->year 01/07/90, version Marelli				1.430.055R					
All engines					01/07/90 ->, version Marelli				1.430.059					
2.0 Turbo	Petrol	148	07/90-10/92	AR 64102										
ENGINE														
All engines					Information	A10	A20	A40	A50	A70	C10 - C30	C20	E01	
All engines					version Bosch			1.306.236	1.406.119R					
All engines													1.500.666	
2.0 Twin Spark	Petrol	109	06/87-09/92	AR 06420										
ENGINE														
All engines					Information	A10	A20	A40	A50	A70	C10 - C30	C20	E01	
All engines					Qty: 2, version Bosch			1.306.079						
2.0 V6 Turbo	Petrol	148	09/92-09/98	AR 64102										
ENGINE														
All engines					Information	A10	A20	A40	A50	A70	C10 - C30	C20	E01	
All engines					version Bosch			1.306.236						
2.0 V6 Turbo	Petrol	150	03/91-09/92	AR 64101										
ENGINE														
All engines					Information	A10	A20	A40	A50	A70	C10 - C30	C20	E01	
All engines					version Bosch			1.306.236	1.406.119R					
All engines													1.500.666	
3.0	Petrol	138	11/87-09/91	AR 06410										
ENGINE														
All engines					Information	A10	A20	A40	A50	A70	C10 - C30	C20	E01	
All engines					version Bosch			1.306.236	1.406.119R					
3.0	Petrol	168	04/93-02/95	AR 64304										
ENGINE														
All engines					Information	A10	A20	A40	A50	A70	C10 - C30	C20	E01	
All engines					Qty: 6						1.970.313	C10		
3.0 24V	Petrol	154	03/95-10/97	AR 66302										
ENGINE														
All engines					Information	A10	A20	A40	A50	A70	C10 - C30	C20	E01	
All engines					Qty: 6						1.970.313	C10		
3.0 24V	Petrol	155	09/92-09/98	AR 66301, AR 66302										
ENGINE														
All engines					Information	A10	A20	A40	A50	A70	C10 - C30	C20	E01	
All engines					Qty: 6						1.970.313	C10		
3.0 24V Q4	Petrol	170	02/94-09/98	AR 64307, AR 64308										
ENGINE														
All engines					Information	A10	A20	A40	A50	A70	C10 - C30	C20	E01	
All engines					Qty: 6						1.970.313	C10		

A10	CONDENSER	A20	CONTACT SET	A40	DISTRIBUTOR CAP	A50	ROTOR	A70	PICK-UP
C10	COIL	C20	IGNITION MODULE	C30	ELECTRONIC IGNITION KIT	E01	IGNITION CABLE SET		

The present application list is a brief version. For the detailed information about the possibility of installation on a specific vehicle, please refer to our web-catalogue <http://catalogo.facet.eu/>

Vehicle	alim.	kW	Date	Engine	FUNCTIONS ON THE VEHICLE								
					A10	A20	A40	A50	A70	C10 - C30	C20	E01	
ENGINE													
3.0 24V Q4	Petrol	171	09/92-10/98	AR 66304									
Engine	Information				A10	A20	A40	A50	A70	C10 - C30	C20	E01	
All engines	Qty: 6									1.970.313	C10		
ENGINE													
3.0 24V QV	Petrol	171	09/92-09/98	AR 64304									
Engine	Information				A10	A20	A40	A50	A70	C10 - C30	C20	E01	
All engines	Qty: 6									1.970.313	C10		
ENGINE													
3.0 24V QV [USA]	Petrol	170	04/93-02/95	AR 64308									
Engine	Information				A10	A20	A40	A50	A70	C10 - C30	C20	E01	
All engines	Qty: 6									1.970.313	C10		
ENGINE													
3.0 24V QV Trazione integrale	Petrol	171	11/92-10/97	AR 64307									
Engine	Information				A10	A20	A40	A50	A70	C10 - C30	C20	E01	
All engines	Qty: 6									1.970.313	C10		
ENGINE													
3.0 i.e. QV	Petrol	147	09/90-09/92	AR 64301									
Engine	Information				A10	A20	A40	A50	A70	C10 - C30	C20	E01	
All engines	version Bosch						1.306.236	1.406.119R					
ENGINE													
3.0 Lusso [USA] [CAN]	Petrol	135	10/91-03/93	AR 06412									
Engine	Information				A10	A20	A40	A50	A70	C10 - C30	C20	E01	
All engines	version Bosch						1.306.236	1.406.119R					
ENGINE													
3.0 Sport [CAN] [USA]	Petrol	147	11/90-03/92	AR 64301									
Engine	Information				A10	A20	A40	A50	A70	C10 - C30	C20	E01	
All engines	version Bosch						1.306.236	1.406.119R					
ENGINE													
3.0 V6	Petrol	135	06/87-09/92	AR 06412									
Engine	Information				A10	A20	A40	A50	A70	C10 - C30	C20	E01	
All engines	version Bosch						1.306.236	1.406.119R					
ENGINE													
3.0 V6	Petrol	141	06/87-09/92	AR 06410									
Engine	Information				A10	A20	A40	A50	A70	C10 - C30	C20	E01	
All engines	version Bosch						1.306.236	1.406.119R					
ENGINE													
3.0i 24V Super [BRA]	Petrol	155	09/92-10/98	64306									
Engine	Information				A10	A20	A40	A50	A70	C10 - C30	C20	E01	
All engines	Qty: 6									1.970.313	C10		
ENGINE													
3.0i 24V Super Q4	Petrol	171	03/95-12/98	AR 66304									
Engine	Information				A10	A20	A40	A50	A70	C10 - C30	C20	E01	
All engines	Qty: 6									1.970.313	C10		
166													
ENGINE													
2.0 T.Spark	Petrol	110	10/00-06/07	AR 36301									
Engine	Information				A10	A20	A40	A50	A70	C10 - C30	C20	E01	
All engines	x 4, COIL ON PLUG									1.970.397	C10		
All engines												1.501.607	
ENGINE													
2.0 T.Spark	Petrol	114	09/98-10/00	AR 34103									
Engine	Information				A10	A20	A40	A50	A70	C10 - C30	C20	E01	
All engines	x 4, SEMI-DIRECT									1.970.387	C10		
All engines												1.501.608	
ENGINE													
2.5 V6 24V	Petrol	138	10/00-06/07	AR 36201									
Engine	Information				A10	A20	A40	A50	A70	C10 - C30	C20	E01	
All engines	x 6, COIL ON PLUG									1.970.313	C10		

A10 CONDENSER	A20 CONTACT SET	A40 DISTRIBUTOR CAP	A50 ROTOR	A70 PICK-UP
C10 COIL	C20 IGNITION MODULE	C30 ELECTRONIC IGNITION KIT	E01 IGNITION CABLE SET	

Vehicle	alim.	kW	Date	Engine	FUNCTIONS ON THE VEHICLE									
					A10	A20	A40	A50	A70	C10 - C30	C20	E01		
ENGINE														
2.5 V6 24V	Petrol	140	09/98-12/06	AR 34201										
Engine	Information				A10	A20	A40	A50	A70	C10 - C30	C20	E01		
All engines	x 6, COIL ON PLUG									1.970.313	C10			
ENGINE														
3.0 V6 24V	Petrol	162	10/00-06/07	AR 36101										
Engine	Information				A10	A20	A40	A50	A70	C10 - C30	C20	E01		
All engines	x 6, COIL ON PLUG									1.970.313	C10			
ENGINE														
3.0 V6 24V	Petrol	166	09/98-06/07	AR 34301										
Engine	Information				A10	A20	A40	A50	A70	C10 - C30	C20	E01		
All engines	x 6, COIL ON PLUG									1.970.313	C10			
ENGINE														
3.2 V6 24V	Petrol	176	10/03-06/07	936 A.000										
Engine	Information				A10	A20	A40	A50	A70	C10 - C30	C20	E01		
All engines	x 6, COIL ON PLUG									1.970.313	C10			
1750-2000														
ENGINE														
1.7	Petrol	80	04/68-11/71	AR 10525										
Engine	Information				A10	A20	A40	A50	A70	C10 - C30	C20	E01		
All engines						1.206.047								
ENGINE														
1750	Petrol	83	03/68-10/72	AR 00548										
Engine	Information				A10	A20	A40	A50	A70	C10 - C30	C20	E01		
All engines						1.206.047								
33 I														
ENGINE														
1.2	Petrol	50	06/83-12/89	AR 30585										
Engine	Information				A10	A20	A40	A50	A70	C10 - C30	C20	E01		
All engines	version Bosch						1.306.079	1.406.061R						
All engines	version Ducellier						1.315.054							
ENGINE														
1.3	Petrol	55	06/83-12/89	AR 30586										
Engine	Information				A10	A20	A40	A50	A70	C10 - C30	C20	E01		
All engines	version Bosch						1.306.079	1.406.061R						
All engines	version Ducellier						1.315.054							
ENGINE														
1.3	Petrol	63	10/84-12/89	AR 30168, AR 30587										
Engine	Information				A10	A20	A40	A50	A70	C10 - C30	C20	E01		
All engines	version Bosch						1.306.079	1.406.061R						
All engines	version Ducellier						1.315.054							
Eng. AR 30168	version Marelli							1.430.051R						
Eng. AR 30168	version Bosch								1.906.153					
Eng. AR 30168											1.965.005			
ENGINE														
1.3 i.e.	Petrol	66	05/83-12/89	AR 30168										
Engine	Information				A10	A20	A40	A50	A70	C10 - C30	C20	E01		
All engines	version Bosch						1.306.079	1.406.061R	1.906.153					
All engines	version Ducellier						1.315.054							
All engines	version Marelli							1.430.051R						
All engines											1.965.005			
ENGINE														
1.4	Petrol	66	01/84-12/88	AR 30587										
Engine	Information				A10	A20	A40	A50	A70	C10 - C30	C20	E01		
All engines	version Bosch						1.306.079	1.406.061R						
All engines	version Ducellier						1.315.054							
ENGINE														
1.5	Petrol	75	07/86-12/89	AR 30588										
Engine	Information				A10	A20	A40	A50	A70	C10 - C30	C20	E01		
All engines	version Bosch						1.306.079	1.406.061R						
All engines	version Ducellier						1.315.054							

A10 CONDENSER	A20 CONTACT SET	A40 DISTRIBUTOR CAP	A50 ROTOR	A70 PICK-UP
C10 COIL	C20 IGNITION MODULE	C30 ELECTRONIC IGNITION KIT	E01 IGNITION CABLE SET	

The present application list is a brief version. For the detailed information about the possibility of installation on a specific vehicle, please refer to our web-catalogue <http://catalogo.facet.eu/>

Vehicle	alim.	kW	Date	Engine	FUNCTIONS ON THE VEHICLE								
					A10	A20	A40	A50	A70	C10 - C30	C20	E01	
1.4 i.e.	Petrol	65	06/91-09/94	ENGINE AR 30753, AR 30755									
Engine	Information			A10	A20	A40	A50	A70	C10 - C30	C20	E01		
Eng. AR 30755	version Bosch					1.306.079	1.406.121R						
Eng. AR 30753	Qty: 2								1.970.146	C10			
1.4 i.e.	Petrol	66	06/91-09/94	ENGINE AR 30753, AR 30755									
Engine	Information			A10	A20	A40	A50	A70	C10 - C30	C20	E01		
Eng. AR 30755	version Bosch					1.306.079	1.406.121R						
Eng. AR 30753	Qty: 2								1.970.146	C10			
1.4 i.e. 4x4	Petrol	66	07/90-09/94	ENGINE AR 30755									
Engine	Information			A10	A20	A40	A50	A70	C10 - C30	C20	E01		
All engines	version Bosch					1.306.079	1.406.121R						
1.5	Petrol	77	01/90-04/93	ENGINE AR 30734									
Engine	Information			A10	A20	A40	A50	A70	C10 - C30	C20	E01		
All engines	version Bosch					1.306.079	1.406.061R						
1.5 i.e.	Petrol	71	01/90-09/94	ENGINE AR 30751									
Engine	Information			A10	A20	A40	A50	A70	C10 - C30	C20	E01		
All engines	version Bosch					1.306.079	1.406.121R						
1.5 i.e.	Petrol	70	09/91-12/95	ENGINE AR 30738									
Engine	Information			A10	A20	A40	A50	A70	C10 - C30	C20	E01		
All engines									1.970.168	C10			
1.5 i.e.	Petrol	74	07/90-08/91	ENGINE AR 30750									
Engine	Information			A10	A20	A40	A50	A70	C10 - C30	C20	E01		
All engines	version Bosch					1.306.079	1.406.121R						
1.7 16V	Petrol	101	01/90-09/94	ENGINE AR 30746									
Engine	Information			A10	A20	A40	A50	A70	C10 - C30	C20	E01		
All engines	version Bosch					1.306.079	1.406.123R						
1.7 16V	Petrol	95	01/90-09/94	ENGINE AR 30747									
Engine	Information			A10	A20	A40	A50	A70	C10 - C30	C20	E01		
All engines	version Bosch					1.306.079	1.406.123R						
1.7 16V	Petrol	97	01/90-09/94	ENGINE AR 30747									
Engine	Information			A10	A20	A40	A50	A70	C10 - C30	C20	E01		
All engines	version Bosch					1.306.079	1.406.123R						
1.7 16V 4x4	Petrol	101	01/90-09/94	ENGINE AR 30746									
Engine	Information			A10	A20	A40	A50	A70	C10 - C30	C20	E01		
All engines	version Bosch					1.306.079	1.406.123R						
1.7 16V 4x4	Petrol	95	01/90-09/94	ENGINE AR 30747									
Engine	Information			A10	A20	A40	A50	A70	C10 - C30	C20	E01		
All engines	version Bosch					1.306.079	1.406.123R						
1.7 16V 4x4	Petrol	97	01/90-09/94	ENGINE AR 30747									
Engine	Information			A10	A20	A40	A50	A70	C10 - C30	C20	E01		
All engines	version Bosch					1.306.079	1.406.123R						
1.7 i.e.	Petrol	77	09/91-12/95	ENGINE AR 30737, AR 30740									
Engine	Information			A10	A20	A40	A50	A70	C10 - C30	C20	E01		
Eng. AR 30737	version Bosch					1.306.079	1.406.121R						
Eng. AR 30740									1.970.168	C10			

A10 CONDENSER	A20 CONTACT SET	A40 DISTRIBUTOR CAP	A50 ROTOR	A70 PICK-UP
C10 COIL	C20 IGNITION MODULE	C30 ELECTRONIC IGNITION KIT	E01 IGNITION CABLE SET	

The present application list is a brief version. For the detailed information about the possibility of installation on a specific vehicle, please refer to our web-catalogue <http://catalogo.facet.eu/>

Vehicle	alim.	kW	Date	Engine	FUNCTIONS ON THE VEHICLE												
					A10	A20	A40	A50	A70	C10 - C30	C20	E01					
ENGINE																	
1.7 i.e.	Petrol	79	01/90-09/94	AR 30736, AR 30737													
Engine	Information				A10	A20	A40	A50	A70	C10 - C30	C20	E01					
All engines	version Bosch						1.306.079	1.406.121R									
ENGINE																	
1.7 i.e. 4x4	Petrol	79	01/90-09/94	AR 30736, AR 30737													
Engine	Information				A10	A20	A40	A50	A70	C10 - C30	C20	E01					
All engines	version Bosch						1.306.079	1.406.121R									
4C																	
ENGINE																	
1.8	Petrol	177	03/13-12/20	960 A1.000													
Engine	Information				A10	A20	A40	A50	A70	C10 - C30	C20	E01					
All engines	x 4, COIL ON PLUG, x 4, COIL ON PLUG									1.970.549	C10						
6																	
ENGINE																	
2.0	Petrol	99	07/81-12/86	AR 01932													
Engine	Information				A10	A20	A40	A50	A70	C10 - C30	C20	E01					
All engines	version Bosch						1.306.081	1.406.024R									
75																	
ENGINE																	
1.6	Petrol	81	05/85-09/89	AR 06100													
Engine	Information				A10	A20	A40	A50	A70	C10 - C30	C20	E01					
All engines	version Bosch						1.306.079	1.406.055R	1.906.153								
All engines													1.500.716				
ENGINE																	
1.6 Cat	Petrol	81	05/89-02/92	AR 61101													
Engine	Information				A10	A20	A40	A50	A70	C10 - C30	C20	E01					
All engines	version Bosch						1.306.079										
ENGINE																	
1.8	Petrol	85	09/85-06/89	AR 06202													
Engine	Information				A10	A20	A40	A50	A70	C10 - C30	C20	E01					
All engines	version Bosch						1.306.079		1.906.153								
All engines	LHD, version Bosch							1.406.061R									
All engines	RHD, version Bosch							1.406.121R									
All engines	version Marelli							1.430.054R									
All engines													1.500.716				
ENGINE																	
1.8	Petrol	88	09/88-02/92	AR 06168, AR 61102													
Engine	Information				A10	A20	A40	A50	A70	C10 - C30	C20	E01					
All engines	version Bosch						1.306.079										
Eng. AR 06168	version Bosch							1.406.055R									
ENGINE																	
1.8	Petrol	90	08/89-02/92	AR 61201													
Engine	Information				A10	A20	A40	A50	A70	C10 - C30	C20	E01					
All engines	version Bosch						1.306.079										
ENGINE																	
1.8 i.e.	Petrol	88	08/89-02/92	61202													
Engine	Information				A10	A20	A40	A50	A70	C10 - C30	C20	E01					
All engines	version Bosch						1.306.079										
ENGINE																	
1.8 i.e. Turbo America	Petrol	118	02/86-01/90	61203													
Engine	Information				A10	A20	A40	A50	A70	C10 - C30	C20	E01					
All engines	version Bosch						1.306.079	1.406.121R									
ENGINE																	
1.8 Turbo	Petrol	110	09/86-02/92	AR 06134													
Engine	Information				A10	A20	A40	A50	A70	C10 - C30	C20	E01					
All engines	version Bosch						1.306.079	1.406.121R									
ENGINE																	
2.0 T.S Cat	Petrol	109	05/85-02/92	AR 06224													
Engine	Information				A10	A20	A40	A50	A70	C10 - C30	C20	E01					
All engines	Qty: 2, version Bosch						1.306.079										
A10	CONDENSER	A20	CONTACT SET	A40	DISTRIBUTOR CAP	A50	ROTOR	A70	PICK-UP	C10	COIL	C20	IGNITION MODULE	C30	ELECTRONIC IGNITION KIT	E01	IGNITION CABLE SET

Vehicle	alim.	kW	Date	Engine	FUNCTIONS ON THE VEHICLE									
					A10	A20	A40	A50	A70	C10 - C30	C20	E01		
ENGINE														
2.0 T.S.	Petrol	107	01/87-02/92	AR 06166, AR 06224										
Engine		Information			A10	A20	A40	A50	A70	C10 - C30	C20	E01		
All engines		Qty: 2, version Bosch					1.306.079							
ENGINE														
2.0 T.S.	Petrol	109	01/87-12/88	AR 06224										
Engine		Information			A10	A20	A40	A50	A70	C10 - C30	C20	E01		
All engines		Qty: 2, version Bosch					1.306.079							
ENGINE														
2.5 V6	Petrol	110	05/85-08/86	AR 01646, AR 01648, AR 01911										
Engine		Information			A10	A20	A40	A50	A70	C10 - C30	C20	E01		
All engines		version Bosch					1.306.081							
Eng. AR 01911		version Bosch						1.406.113R						
All engines													1.500.660	
ENGINE														
3.0 V6	Petrol	136	01/87-12/90	AR 06120										
Engine		Information			A10	A20	A40	A50	A70	C10 - C30	C20	E01		
All engines		version Bosch					1.306.081	1.406.113R						
All engines													1.500.660	
ENGINE														
3.0 V6	Petrol	141	02/90-02/92	AR 61503										
Engine		Information			A10	A20	A40	A50	A70	C10 - C30	C20	E01		
All engines		version Bosch					1.306.081	1.406.113R						
All engines													1.500.660	
ENGINE														
3.0 V6 Cat	Petrol	136	01/87-02/92	AR 06124										
Engine		Information			A10	A20	A40	A50	A70	C10 - C30	C20	E01		
All engines		version Bosch					1.306.081	1.406.113R						
All engines													1.500.660	
90														
ENGINE														
1.8	Petrol	85	10/84-07/87	AR 06202										
Engine		Information			A10	A20	A40	A50	A70	C10 - C30	C20	E01		
All engines		version Bosch					1.306.079	1.406.061R	1.906.153					
All engines		FOR: (CH), version Bosch						1.406.121R						
All engines		version Marelli						1.430.054R						
ENGINE														
1.8	Petrol	89	10/84-07/87	AR 06202										
Engine		Information			A10	A20	A40	A50	A70	C10 - C30	C20	E01		
All engines		version Bosch					1.306.079	1.406.061R	1.906.153					
All engines		FOR: (CH), version Bosch						1.406.121R						
All engines		version Marelli						1.430.054R						
ENGINE														
2.0 i.e.	Petrol	97	10/84-07/87	AR 06210										
Engine		Information			A10	A20	A40	A50	A70	C10 - C30	C20	E01		
All engines		version Bosch					1.306.079	1.406.061R	1.906.153					
All engines		FOR: (CH), version Bosch						1.406.121R						
All engines		version Marelli						1.430.054R						
ENGINE														
2.5 i.e. V6	Petrol	110	10/84-07/87	AR 01646										
Engine		Information			A10	A20	A40	A50	A70	C10 - C30	C20	E01		
All engines		version Bosch					1.306.081							
ALFASUD														
ENGINE														
1.2	Petrol	46	06/72-09/84	AR 30102										
Engine		Information			A10	A20	A40	A50	A70	C10 - C30	C20	E01		
All engines		version Duellier			1.115.034		1.315.049							
All engines		version Marelli			1.130.117									
All engines		version Bosch				1.206.034HVS	1.306.079							
All engines										1.970.101D	C10			

A10	CONDENSER	A20	CONTACT SET	A40	DISTRIBUTOR CAP	A50	ROTOR	A70	PICK-UP
C10	COIL	C20	IGNITION MODULE	C30	ELECTRONIC IGNITION KIT	E01	IGNITION CABLE SET		

The present application list is a brief version. For the detailed information about the possibility of installation on a specific vehicle, please refer to our web-catalogue <http://catalogo.facet.eu/>









				FUNCTIONS ON THE VEHICLE								
Vehicle	alim.	kW	Date	Engine								
				ENGINE								
1.5 ti	Petrol	70	05/80-06/84	AR 30128								
Engine	Information			A10	A20	A40	A50	A70	C10 - C30	C20	E01	
All engines	version Bosch					1.306.079		1.906.153				
All engines	version Ducellier					1.315.054						
All engines	version Marelli						1.430.051R					
				ALFETTA								
				ENGINE								
1.6	Petrol	79	01/75-12/84	AR 01600								
Engine	Information			A10	A20	A40	A50	A70	C10 - C30	C20	E01	
All engines	version Bosch					1.306.079	1.406.061R	1.906.153				
All engines	version Marelli						1.430.054R					
				ENGINE								
1.8	Petrol	85	07/74-04/82	AR 01608 X								
Engine	Information			A10	A20	A40	A50	A70	C10 - C30	C20	E01	
All engines	version Marelli			1.130.117			1.430.042R					
All engines	version Bosch				1.206.034HVS	1.306.079	1.406.025R					
All engines									1.970.101D	C10		
				ENGINE								
1.8	Petrol	89	10/79-12/84	AR 01608								
Engine	Information			A10	A20	A40	A50	A70	C10 - C30	C20	E01	
All engines	version Bosch					1.306.079	1.406.061R	1.906.153				
All engines	version Marelli						1.430.054R					
				BRERA								
				ENGINE								
1.8 TBi	Petrol	147	05/09-06/10	939 B1.000								
Engine	Information			A10	A20	A40	A50	A70	C10 - C30	C20	E01	
All engines	x 4, COIL ON PLUG								1.970.549	C10		
				GIULIA								
				ENGINE								
1300 Super	Petrol	64	01/74-12/78	AR 00530								
Engine	Information			A10	A20	A40	A50	A70	C10 - C30	C20	E01	
All engines					1.206.029HV							
				ENGINE								
1300 TI	Petrol	62	04/69-07/75	--								
Engine	Information			A10	A20	A40	A50	A70	C10 - C30	C20	E01	
All engines					1.206.029HV							
				ENGINE								
1600 Super	Petrol	71	06/64-08/69	AR 00526								
Engine	Information			A10	A20	A40	A50	A70	C10 - C30	C20	E01	
All engines					1.206.047							
				GIULIETTA I								
				ENGINE								
1.3	Petrol	66	10/77-06/83	AR 01644								
Engine	Information			A10	A20	A40	A50	A70	C10 - C30	C20	E01	
All engines	version Marelli			1.130.117			1.430.042R					
All engines	version Bosch				1.206.034HVS	1.306.079	1.406.025R					
All engines									1.970.101D	C10		
				ENGINE								
1.6	Petrol	79	10/77-04/85	AR 01600								
Engine	Information			A10	A20	A40	A50	A70	C10 - C30	C20	E01	
All engines	version Bosch					1.306.079	1.406.061R	1.906.153				
All engines	version Marelli						1.430.054R					
				ENGINE								
1.8	Petrol	90	04/79-04/85	AR 01678								
Engine	Information			A10	A20	A40	A50	A70	C10 - C30	C20	E01	
All engines	version Bosch					1.306.079	1.406.061R	1.906.153				
All engines	version Marelli						1.430.054R					
				ENGINE								
2.0	Petrol	96	06/80-04/85	AR 01655								
Engine	Information			A10	A20	A40	A50	A70	C10 - C30	C20	E01	
All engines	version Bosch					1.306.079	1.406.061R	1.906.153				

A10 CONDENSER	A20 CONTACT SET	A40 DISTRIBUTOR CAP	A50 ROTOR	A70 PICK-UP
C10 COIL	C20 IGNITION MODULE	C30 ELECTRONIC IGNITION KIT	E01 IGNITION CABLE SET	

Vehicle	alim.	kW	Date	Engine	FUNCTIONS ON THE VEHICLE									
					A10	A20	A40	A50	A70	C10 - C30	C20	E01		
ENGINE														
2.0	Petrol	96	06/80-04/85	AR 01655										
Engine		Information			A10	A20	A40	A50	A70	C10 - C30	C20	E01		
All engines		version Marelli						1.430.054R						
GIULIETTA II														
ENGINE														
1.4	Petrol	125	04/11-12/20	940 A2.000										
Engine		Information			A10	A20	A40	A50	A70	C10 - C30	C20	E01		
All engines		x 4, COIL ON PLUG								1.970.549	C10			
ENGINE														
1.4 TB	Petrol	110	09/14-10/18	940 C2.000										
Engine		Information			A10	A20	A40	A50	A70	C10 - C30	C20	E01		
All engines		euro 5, x 4, COIL ON PLUG ----- euro 6, x 4, COIL ON PLUG								1.970.549	C10			
ENGINE														
1.4 TB	Petrol	120	04/10-10/18	955 A8.000										
Engine		Information			A10	A20	A40	A50	A70	C10 - C30	C20	E01		
All engines		x 4, COIL ON PLUG								1.970.549	C10			
ENGINE														
1.4 TB	Petrol	125	04/10-10/18	940 A2.000										
Engine		Information			A10	A20	A40	A50	A70	C10 - C30	C20	E01		
All engines		x 4, COIL ON PLUG								1.970.549	C10			
ENGINE														
1.8	Petrol	173	04/11-02/16	940 A1.000										
Engine		Information			A10	A20	A40	A50	A70	C10 - C30	C20	E01		
All engines		x 4, COIL ON PLUG								1.970.549	C10			
ENGINE														
1.8 TBi	Petrol	169	04/10-09/13	940 A1.000										
Engine		Information			A10	A20	A40	A50	A70	C10 - C30	C20	E01		
All engines		x 4, COIL ON PLUG								1.970.549	C10			
ENGINE														
1.8 TBi	Petrol	173	04/10-02/16	940 A1.000										
Engine		Information			A10	A20	A40	A50	A70	C10 - C30	C20	E01		
All engines		x 4, COIL ON PLUG								1.970.549	C10			
ENGINE														
1.8 TBi	Petrol	177	09/13-10/18	940 B2.000, 960 A1.000										
Engine		Information			A10	A20	A40	A50	A70	C10 - C30	C20	E01		
Eng. 940 B2.000		x 4, COIL ON PLUG								1.970.549	C10			
Eng. 960 A1.000		Qty: 4								1.970.549	C10			
GT														
ENGINE														
1.8	Petrol	80	04/68-11/71	AR 10525										
Engine		Information			A10	A20	A40	A50	A70	C10 - C30	C20	E01		
All engines						1.206.047								
ENGINE														
1.8 TS	Petrol	103	11/03-09/10	AR 32205										
Engine		Information			A10	A20	A40	A50	A70	C10 - C30	C20	E01		
All engines		x 4, COIL ON PLUG								1.970.397	C10			
All engines													1.501.607	
ENGINE														
1300 Junior	Petrol	64	01/66-12/77	AR 00530										
Engine		Information			A10	A20	A40	A50	A70	C10 - C30	C20	E01		
All engines						1.206.047	1.306.062							
All engines		version BOSCH					1.306.076							
ENGINE														
1600	Petrol	75	03/63-12/66	AR 00526 S										
Engine		Information			A10	A20	A40	A50	A70	C10 - C30	C20	E01		
All engines		version BOSCH					1.306.076							

A10	CONDENSER	A20	CONTACT SET	A40	DISTRIBUTOR CAP	A50	ROTOR	A70	PICK-UP
C10	COIL	C20	IGNITION MODULE	C30	ELECTRONIC IGNITION KIT	E01	IGNITION CABLE SET		

The present application list is a brief version. For the detailed information about the possibility of installation on a specific vehicle, please refer to our web-catalogue <http://catalogo.facet.eu/>

					FUNCTIONS ON THE VEHICLE							
Vehicle	alim.	kW	Date	Engine	 A10	 A20	 A40	 A50	 A70	 C10 - C30	 C20	 E01
3.2 GTA												
	Petrol	176	11/03-09/10	ENGINE 936 A.000								
Engine	Information				A10	A20	A40	A50	A70	C10 - C30	C20	E01
All engines	x 6, COIL ON PLUG									1.970.313	C10	
A 1600												
	Petrol	83	01/65-12/70	ENGINE AR 10538								
Engine	Information				A10	A20	A40	A50	A70	C10 - C30	C20	E01
All engines	version BOSCH						1.306.076					
V 1750												
	Petrol	83	01/67-12/72	ENGINE AR 00548								
Engine	Information				A10	A20	A40	A50	A70	C10 - C30	C20	E01
All engines						1.206.047						
GTV												
1.8 16V												
	Petrol	106	05/98-10/05	ENGINE AR 32201								
Engine	Information				A10	A20	A40	A50	A70	C10 - C30	C20	E01
All engines	x 4, SEMI-DIRECT									1.970.387	C10	
All engines												1.501.608
2.0 T.SPARK 16V												
	Petrol	110	06/95-10/05	ENGINE AR 16201, AR 32310								
Engine	Information				A10	A20	A40	A50	A70	C10 - C30	C20	E01
Eng. AR 16201	->year 01/08/98, x 4, SEMI-DIRECT									1.970.386	C10	
Eng. AR 16201	01/09/98 ->, x 4, SEMI-DIRECT									1.970.387	C10	
Eng. AR 32310	x 4, COIL ON PLUG									1.970.397	C10	
Eng. AR 32310												1.501.607
Eng. AR 16201												1.501.608
2.0 T.SPARK 16V												
	Petrol	114	09/97-03/03	ENGINE AR 32301								
Engine	Information				A10	A20	A40	A50	A70	C10 - C30	C20	E01
All engines	x 4, SEMI-DIRECT									1.970.387	C10	
All engines												1.501.608
2.0 V6 Turbo												
	Petrol	148	06/95-09/98	ENGINE AR 16202								
Engine	Information				A10	A20	A40	A50	A70	C10 - C30	C20	E01
All engines	version Bosch						1.306.236	1.406.119R				
3.0 V6 24V												
	Petrol	160	10/00-10/05	ENGINE AR 16105								
Engine	Information				A10	A20	A40	A50	A70	C10 - C30	C20	E01
All engines	x 6, COIL ON PLUG									1.970.313	C10	
3.0 V6 24V												
	Petrol	162	10/96-10/00	ENGINE AR 16102								
Engine	Information				A10	A20	A40	A50	A70	C10 - C30	C20	E01
All engines	x 6, COIL ON PLUG									1.970.313	C10	
3.2 V6 24V												
	Petrol	176	04/03-10/05	ENGINE 936 A6.000								
Engine	Information				A10	A20	A40	A50	A70	C10 - C30	C20	E01
All engines	x 6, COIL ON PLUG									1.970.313	C10	
MITO												
1.4												
	Petrol	51	05/11-10/18	ENGINE 955 A9.000								
Engine	Information				A10	A20	A40	A50	A70	C10 - C30	C20	E01
All engines	x 1, D.I.S.									1.970.423	C10	
All engines												1.499.170
1.4												
	Petrol	57	03/11->	ENGINE 04Y, 350 A1.000								
Engine	Information				A10	A20	A40	A50	A70	C10 - C30	C20	E01
Eng. 350 A1.000	x 1, D.I.S.									1.970.423	C10	
All engines												1.499.170

A10 CONDENSER	A20 CONTACT SET	A40 DISTRIBUTOR CAP	A50 ROTOR	A70 PICK-UP
C10 COIL	C20 IGNITION MODULE	C30 ELECTRONIC IGNITION KIT	E01 IGNITION CABLE SET	

Vehicle	alim.	kW	Date	Engine	FUNCTIONS ON THE VEHICLE									
					A10	A20	A40	A50	A70	C10 - C30	C20	E01		
ENGINE														
1.4	Petrol	58	08/08-08/13	04Y, 955A1000										
Engine					A10	A20	A40	A50	A70	C10 - C30	C20	E01		
Eng. 955A1000										1.970.442	C10			
Eng. 04Y													1.499.170	
ENGINE														
1.4	Petrol	70	09/08-08/13	199 A6.000										
Engine					A10	A20	A40	A50	A70	C10 - C30	C20	E01		
All engines										1.970.442	C10			
ENGINE														
1.4 MultiAir	Petrol	125	09/09-10/18	940 A2.000										
Engine					A10	A20	A40	A50	A70	C10 - C30	C20	E01		
All engines										1.970.549	C10			
ENGINE														
1.4 TB	Petrol	103	12/13-10/18	955 B1.000										
Engine					A10	A20	A40	A50	A70	C10 - C30	C20	E01		
All engines										1.970.549	C10			
ENGINE														
1.4 Turbo MultiAir	Petrol	120	10/09-10/18	955 A8.000										
Engine					A10	A20	A40	A50	A70	C10 - C30	C20	E01		
All engines										1.970.549	C10			
ENGINE														
1.4 Turbo MultiAir	Petrol	99	10/09-12/14	955 A2.000, 955 A7.000										
Engine					A10	A20	A40	A50	A70	C10 - C30	C20	E01		
All engines										1.970.549	C10			
SPIDER I														
ENGINE														
1.7	Petrol	80	04/68-11/71	AR 10525										
Engine					A10	A20	A40	A50	A70	C10 - C30	C20	E01		
All engines						1.206.047								
ENGINE														
1300	Petrol	64	01/68-12/77	AR 00530										
Engine					A10	A20	A40	A50	A70	C10 - C30	C20	E01		
All engines						1.206.047								
ENGINE														
1600	Petrol	76	03/76-12/90	AR 00526										
Engine					A10	A20	A40	A50	A70	C10 - C30	C20	E01		
All engines							1.306.079	1.406.055R	1.906.153					
ENGINE														
1600	Petrol	79	01/90-12/93	AR 01563										
Engine					A10	A20	A40	A50	A70	C10 - C30	C20	E01		
All engines							1.306.079	1.406.055R	1.906.153					
ENGINE														
1600	Petrol	80	03/66-12/68	AR 00526, AR 00536, AR 01600										
Engine					A10	A20	A40	A50	A70	C10 - C30	C20	E01		
All engines						1.206.047								
ENGINE														
1750	Petrol	83	01/67-12/71	AR 00548										
Engine					A10	A20	A40	A50	A70	C10 - C30	C20	E01		
All engines						1.206.047								
ENGINE														
2.0i [CAN]	Petrol	88	09/90-10/93	AR 01588										
Engine					A10	A20	A40	A50	A70	C10 - C30	C20	E01		
All engines							1.306.079	1.406.123R						
ENGINE														
2.0i [USA]	Petrol	88	09/90-10/93	AR 01588										
Engine					A10	A20	A40	A50	A70	C10 - C30	C20	E01		
All engines							1.306.079	1.406.123R						

A10	CONDENSER	A20	CONTACT SET	A40	DISTRIBUTOR CAP	A50	ROTOR	A70	PICK-UP
C10	COIL	C20	IGNITION MODULE	C30	ELECTRONIC IGNITION KIT	E01	IGNITION CABLE SET		

The present application list is a brief version. For the detailed information about the possibility of installation on a specific vehicle, please refer to our web-catalogue <http://catalogo.facet.eu/>

Vehicle	alim.	kW	Date	Engine	FUNCTIONS ON THE VEHICLE									
					A10	A20	A40	A50	A70	C10 - C30	C20	E01		
ENGINE														
2.0i Veloce [CAN]	Petrol	88	09/90-10/93	AR 01588										
Engine	Information				A10	A20	A40	A50	A70	C10 - C30	C20	E01		
All engines	version Bosch						1.306.079	1.406.123R						
ENGINE														
2.0i Veloce [USA]	Petrol	88	09/90-10/93	AR 01588										
Engine	Information				A10	A20	A40	A50	A70	C10 - C30	C20	E01		
All engines	version Bosch						1.306.079	1.406.123R						
ENGINE														
2000	Petrol	85	08/86-12/90	AR 01544										
Engine	Information				A10	A20	A40	A50	A70	C10 - C30	C20	E01		
All engines	version Bosch						1.306.079	1.406.055R						
ENGINE														
2000	Petrol	88	01/90-12/93	AR 01588										
Engine	Information				A10	A20	A40	A50	A70	C10 - C30	C20	E01		
All engines	version Bosch						1.306.079							
ENGINE														
2000	Petrol	93	01/77-12/93	AR 01590										
Engine	Information				A10	A20	A40	A50	A70	C10 - C30	C20	E01		
All engines	version Bosch						1.306.079							
SPIDER II														
ENGINE														
1.8 16V	Petrol	106	05/98-04/05	AR 32201										
Engine	Information				A10	A20	A40	A50	A70	C10 - C30	C20	E01		
All engines	x 4, SEMI-DIRECT									1.970.387	C10			
All engines													1.501.608	
ENGINE														
2.0 T.SPARK 16V	Petrol	110	06/95-04/05	AR 16201, AR 32310										
Engine	Information				A10	A20	A40	A50	A70	C10 - C30	C20	E01		
Eng. AR 16201	x 2, SEMI-DIRECT									1.970.386	C10			
Eng. AR 32310	x 4, COIL ON PLUG									1.970.397	C10			
Eng. AR 32310													1.501.607	
Eng. AR 16201													1.501.608	
ENGINE														
2.0 T.SPARK 16V	Petrol	114	05/98-08/00	AR 32301										
Engine	Information				A10	A20	A40	A50	A70	C10 - C30	C20	E01		
All engines	x 4, SEMI-DIRECT									1.970.387	C10			
All engines													1.501.608	
ENGINE														
2.0 V6 Turbo	Petrol	148	05/98-04/05	AR 16202										
Engine	Information				A10	A20	A40	A50	A70	C10 - C30	C20	E01		
All engines	version Bosch						1.306.236	1.406.119R						
ENGINE														
3.0 V6	Petrol	160	09/94-04/05	AR 16105										
Engine	Information				A10	A20	A40	A50	A70	C10 - C30	C20	E01		
All engines	x 6, COIL ON PLUG									1.970.313	C10			
ENGINE														
3.0 V6 24V	Petrol	162	01/99-10/03	AR 16102										
Engine	Information				A10	A20	A40	A50	A70	C10 - C30	C20	E01		
All engines	x 6, COIL ON PLUG									1.970.313	C10			
ENGINE														
3.2 V6 24V	Petrol	176	04/03-04/05	936 A6.000										
Engine	Information				A10	A20	A40	A50	A70	C10 - C30	C20	E01		
All engines	x 6, COIL ON PLUG									1.970.313	C10			
SPIDER III														
ENGINE														
1.8 TBi	Petrol	147	05/09-03/11	939 B1.000										
Engine	Information				A10	A20	A40	A50	A70	C10 - C30	C20	E01		
All engines	x 4, COIL ON PLUG									1.970.549	C10			

A10 CONDENSER	A20 CONTACT SET	A40 DISTRIBUTOR CAP	A50 ROTOR	A70 PICK-UP
C10 COIL	C20 IGNITION MODULE	C30 ELECTRONIC IGNITION KIT	E01 IGNITION CABLE SET	

Vehicle	alim.	kW	Date	Engine	FUNCTIONS ON THE VEHICLE							
					A10	A20	A40	A50	A70	C10 - C30	C20	E01

B6

				ENGINE
4.4 Biturbo 4x4 [USA]	Petrol	441	03/14->	N63 M20 A

Engine	Information	A10	A20	A40	A50	A70	C10 - C30	C20	E01
All engines	Qty: 8						1.970.475	C10	

B7

				ENGINE
4.4 BiTurbo [USA]	Petrol	441	01/11->	N63 M20 A

Engine	Information	A10	A20	A40	A50	A70	C10 - C30	C20	E01
All engines	Qty: 8						1.970.475	C10	

				ENGINE
4.4 BiTurbo 4x4 [USA]	Petrol	441	01/12->	N63 M20 A

Engine	Information	A10	A20	A40	A50	A70	C10 - C30	C20	E01
All engines	Qty: 8						1.970.475	C10	

				ENGINE
BITURBO	Petrol	373	03/09-06/12	N63 M10 A







Engine	Information	A10	A20	A40	A50	A70	C10 - C30	C20	E01
All engines	Qty: 8						1.970.475	C10	

				ENGINE
BITURBO Trazione integrale	Petrol	373	09/10-06/12	N63 M10 A

Engine	Information	A10	A20	A40	A50	A70	C10 - C30	C20	E01
All engines	Qty: 8						1.970.475	C10	

A10	CONDENSER	A20	CONTACT SET	A40	DISTRIBUTOR CAP	A50	ROTOR	A70	PICK-UP
C10	COIL	C20	IGNITION MODULE	C30	ELECTRONIC IGNITION KIT	E01	IGNITION CABLE SET		

The present application list is a brief version. For the detailed information about the possibility of installation on a specific vehicle, please refer to our web-catalogue <http://catalogo.facet.eu/>

					FUNCTIONS ON THE VEHICLE							
Vehicle	alim.	kW	Date	Engine								
					A10	A20	A40	A50	A70	C10 - C30	C20	E01

V6

				ENGINE
GT	Petrol	116	01/85-12/90	Z6W

Engine	Information	A10	A20	A40	A50	A70	C10 - C30	C20	E01
All engines	version Bosch				1.406.023R				

				ENGINE
TURBO	Petrol	147	01/88-12/90	Z7U 730, Z7U 732, Z7U 734

Engine	Information	A10	A20	A40	A50	A70	C10 - C30	C20	E01
All engines	version Bosch			1.306.236	1.406.119R				
All engines							1.970.107	C10	

A10	CONDENSER	A20	CONTACT SET	A40	DISTRIBUTOR CAP	A50	ROTOR	A70	PICK-UP
C10	COIL	C20	IGNITION MODULE	C30	ELECTRONIC IGNITION KIT	E01	IGNITION CABLE SET		

Vehicle	alim.	kW	Date	Engine	FUNCTIONS ON THE VEHICLE							
					A10	A20	A40	A50	A70	C10 - C30	C20	E01

CYGNET

				ENGINE
1.3	Petrol	72	04/11-10/13	1NR-FE

Engine	Information	A10	A20	A40	A50	A70	C10 - C30	C20	E01
All engines	x 4, COIL ON PLUG						1.970.537	C10	

DB6

				ENGINE
4.0	Petrol	210	10/64-12/70	--, AJ6

Engine	Information	A10	A20	A40	A50	A70	C10 - C30	C20	E01
All engines			1.228.083MHV		1.428.007				

				ENGINE
4.0	Petrol	243	10/64-12/70	--, AJ6

Engine	Information	A10	A20	A40	A50	A70	C10 - C30	C20	E01
All engines			1.228.083MHV		1.428.007				

DBS

				ENGINE
4.0	Petrol	210	01/66-12/72	--, AJ6

Engine	Information	A10	A20	A40	A50	A70	C10 - C30	C20	E01
All engines					1.428.007				

A10	CONDENSER	A20	CONTACT SET	A40	DISTRIBUTOR CAP	A50	ROTOR	A70	PICK-UP
C10	COIL	C20	IGNITION MODULE	C30	ELECTRONIC IGNITION KIT	E01	IGNITION CABLE SET		

The present application list is a brief version. For the detailed information about the possibility of installation on a specific vehicle, please refer to our web-catalogue <http://catalogo.facet.eu/>

FUNCTIONS ON THE VEHICLE

Vehicle	alim.	kW	Date	Engine								
---------	-------	----	------	--------	---	---	---	--	---	---	---	---

100 III

				ENGINE
1.8	Petrol	55	08/82-12/87	DR, RS

Engine	Information	A10	A20	A40	A50	A70	C10 - C30	C20	E01
Eng. DR	version Bosch			1.306.079	1.406.055R				
All engines					1.406.021R				
Eng. DR							1.970.132	C10	1.965.004

				ENGINE
1.8	Petrol	65	02/86-07/90	SH

Engine	Information	A10	A20	A40	A50	A70	C10 - C30	C20	E01
All engines	version Bosch			1.306.266	1.406.055R	1.906.219			
All engines							1.970.127	C10	1.965.007
									1.500.768

				ENGINE
1.8	Petrol	66	08/83-12/90	DS, JW, NP

Engine	Information	A10	A20	A40	A50	A70	C10 - C30	C20	E01
All engines	version Bosch			1.306.129	1.406.055R	1.906.219			
Eng. NP	version Bosch			1.306.266					
Eng. DS, NP	version Ducellier			1.315.068	1.415.099R				
All engines					1.406.021R		1.970.127	C10	1.965.007
									1.500.768

				ENGINE
1.8 Cat	Petrol	66	03/85-11/90	4B, PH

Engine	Information	A10	A20	A40	A50	A70	C10 - C30	C20	E01
All engines	version Bosch			1.306.266	1.406.055R	1.906.219			
All engines							1.970.127	C10	1.965.007
									1.500.768

				ENGINE
1.8 Cat quattro	Petrol	66	08/85-11/90	4B, PH

Engine	Information	A10	A20	A40	A50	A70	C10 - C30	C20	E01
Eng. 4B	version Bosch			1.306.129	1.406.055R	1.906.219			
All engines							1.970.127	C10	1.500.768
Eng. 4B									1.965.007

				ENGINE
1.8 quattro	Petrol	65	08/86-07/90	SH

Engine	Information	A10	A20	A40	A50	A70	C10 - C30	C20	E01
All engines	version Bosch			1.306.129	1.406.055R	1.906.219			
All engines	version Ducellier			1.315.068	1.415.099R				
All engines							1.970.127	C10	1.965.007
									1.500.768

				ENGINE
1.8 quattro	Petrol	66	10/84-07/88	JW, NP

Engine	Information	A10	A20	A40	A50	A70	C10 - C30	C20	E01
Eng. NP	version Bosch			1.306.129	1.406.055R	1.906.219			
Eng. NP	version Ducellier			1.315.068	1.415.099R				
All engines					1.406.021R				
Eng. NP							1.970.127	C10	1.965.007
									1.500.768

				ENGINE
1.9	Petrol	74	08/82-07/84	WH

Engine	Information	A10	A20	A40	A50	A70	C10 - C30	C20	E01
All engines	version Bosch			1.306.093	1.406.059R				
All engines							1.970.132	C10	1.965.004

				ENGINE
2.0	Petrol	85	08/84-12/87	KP

Engine	Information	A10	A20	A40	A50	A70	C10 - C30	C20	E01
All engines	version Bosch			1.306.231					
All engines	ch. 44-G-000 001 ->, version Bosch				1.406.055R				
All engines	->ch. 44-F-300 000, version Bosch				1.406.116R				
All engines	->ch. 44-F-300 000						1.970.125	C10	
All engines	ch. 44-G-000 001 ->						1.970.127	C10	
All engines									1.965.007
									1.501.682

				ENGINE
2.0 Cat	Petrol	85	01/88-11/90	RT

Engine	Information	A10	A20	A40	A50	A70	C10 - C30	C20	E01
All engines	version Bosch			1.306.231					
All engines	version Bosch, distr. num. 034 905 206				1.406.055R	1.906.219			

A10	CONDENSER	A20	CONTACT SET	A40	DISTRIBUTOR CAP	A50	ROTOR	A70	PICK-UP
C10	COIL	C20	IGNITION MODULE	C30	ELECTRONIC IGNITION KIT	E01	IGNITION CABLE SET		

Vehicle	alim.	kW	Date	Engine	FUNCTIONS ON THE VEHICLE									
					A10	A20	A40	A50	A70	C10 - C30	C20	E01		
ENGINE														
2.0 Cat	Petrol	85	01/88-11/90	RT										
Engine	Information				A10	A20	A40	A50	A70	C10 - C30	C20	E01		
All engines	version Bosch, distr. num. 034 905 205 H							1.406.121R						
All engines													1.501.682	
ENGINE														
2.0 E	Petrol	85	01/85-12/87	KP										
Engine	Information				A10	A20	A40	A50	A70	C10 - C30	C20	E01		
All engines	version Bosch						1.306.231							
All engines	ch. 44-G-000 001 ->, version Bosch							1.406.055R						
All engines	->ch. 44-F-300 000, version Bosch							1.406.116R						
All engines	->ch. 44-F-300 000									1.970.125	C10			
All engines	ch. 44-G-000 001 ->									1.970.127	C10			
All engines											1.965.007		1.501.682	
ENGINE														
2.0 E Cat	Petrol	85	01/88-11/90	RT										
Engine	Information				A10	A20	A40	A50	A70	C10 - C30	C20	E01		
All engines	version Bosch						1.306.231							
All engines	version Bosch, distr. num. 034 905 206							1.406.055R	1.906.219					
All engines	version Bosch, distr. num. 034 905 205 H							1.406.121R						
All engines													1.501.682	
ENGINE														
2.2	Petrol	85	10/84-09/86	KZ										
Engine	Information				A10	A20	A40	A50	A70	C10 - C30	C20	E01		
All engines	version Bosch						1.306.093							
All engines	01/01/84 ->, version Bosch							1.406.059R						
All engines	->year 01/01/84, version Bosch							1.406.116R						
All engines										1.970.125	C10	1.965.004		
ENGINE														
2.2 Cat	Petrol	101	06/89-11/90	KU										
Engine	Information				A10	A20	A40	A50	A70	C10 - C30	C20	E01		
All engines	version Bosch						1.306.231	1.406.055R						
All engines										1.970.127	C10	1.965.007	1.501.682	
ENGINE														
2.2 Cat quattro	Petrol	101	06/89-11/90	KU										
Engine	Information				A10	A20	A40	A50	A70	C10 - C30	C20	E01		
All engines	version Bosch						1.306.231	1.406.055R						
All engines										1.970.127	C10	1.965.007	1.501.682	
ENGINE														
2.2 E Turbo quattro	Petrol	121	08/86-11/90	MC										
Engine	Information				A10	A20	A40	A50	A70	C10 - C30	C20	E01		
All engines	version Bosch						1.306.231	1.406.121R						
All engines													1.501.682	
ENGINE														
2.2 Turbo	Petrol	121	08/86-11/90	MC										
Engine	Information				A10	A20	A40	A50	A70	C10 - C30	C20	E01		
All engines	version Bosch						1.306.231	1.406.121R						
All engines													1.501.682	
ENGINE														
2.2 Turbo quattro	Petrol	121	08/86-11/90	MC										
Engine	Information				A10	A20	A40	A50	A70	C10 - C30	C20	E01		
All engines													1.501.682	
ENGINE														
2.3	Petrol	100	08/86-11/90	NF										
Engine	Information				A10	A20	A40	A50	A70	C10 - C30	C20	E01		
All engines	version Bosch						1.306.231	1.406.121R						
All engines													1.501.682	
ENGINE														
2.3	Petrol	98	03/90-11/90	NF										
Engine	Information				A10	A20	A40	A50	A70	C10 - C30	C20	E01		
All engines	version Bosch						1.306.231	1.406.121R						
All engines													1.501.682	
ENGINE														
A10	CONDENSER		A20	CONTACT SET		A40	DISTRIBUTOR CAP		A50	ROTOR		A70	PICK-UP	
C10	COIL		C20	IGNITION MODULE		C30	ELECTRONIC IGNITION KIT		E01	IGNITION CABLE SET				

Vehicle	alim.	kW	Date	Engine	FUNCTIONS ON THE VEHICLE									
					A10	A20	A40	A50	A70	C10 - C30	C20	E01		
ENGINE														
2.3 E quattro	Petrol	98	12/90-07/94	7M15A-FKS										
Engine	Information				A10	A20	A40	A50	A70	C10 - C30	C20	E01		
All engines	version Bosch						1.306.231	1.406.121R						
All engines													1.501.682	
ENGINE														
2.6	Petrol	102	07/93-07/94	ACZ										
Engine	Information				A10	A20	A40	A50	A70	C10 - C30	C20	E01		
All engines											1.965.051			
ENGINE														
2.6	Petrol	110	03/92-07/94	ABC										
Engine	Information				A10	A20	A40	A50	A70	C10 - C30	C20	E01		
All engines											1.965.051			
ENGINE														
2.6 E quattro	Petrol	102	08/93-07/94	ACZ										
Engine	Information				A10	A20	A40	A50	A70	C10 - C30	C20	E01		
All engines											1.965.051			
ENGINE														
2.6 quattro	Petrol	110	04/92-07/94	ABC										
Engine	Information				A10	A20	A40	A50	A70	C10 - C30	C20	E01		
All engines											1.965.051			
ENGINE														
2.8 E	Petrol	128	12/90-07/94	AAH										
Engine	Information				A10	A20	A40	A50	A70	C10 - C30	C20	E01		
All engines											1.965.051			
ENGINE														
2.8 E quattro	Petrol	128	12/90-07/94	AAH										
Engine	Information				A10	A20	A40	A50	A70	C10 - C30	C20	E01		
All engines											1.965.051			
200 II														
ENGINE														
2.2	Petrol	101	08/84-07/85	KU										
Engine	Information				A10	A20	A40	A50	A70	C10 - C30	C20	E01		
All engines	version Bosch						1.306.231	1.406.059R						
All engines										1.970.125	C10	1.965.004		
ENGINE														
2.2 Turbo	Petrol	121	08/85-09/91	MC										
Engine	Information				A10	A20	A40	A50	A70	C10 - C30	C20	E01		
All engines	version Bosch						1.306.231	1.406.121R						
ENGINE														
2.2 Turbo	Petrol	147	02/88-12/90	1B										
Engine	Information				A10	A20	A40	A50	A70	C10 - C30	C20	E01		
All engines	version Bosch						1.306.231	1.406.121R						
ENGINE														
2.2 Turbo quattro	Petrol	121	01/85-12/91	MC										
Engine	Information				A10	A20	A40	A50	A70	C10 - C30	C20	E01		
All engines	version Bosch						1.306.231							
All engines	01/01/86 ->, version Bosch							1.406.055R						
All engines	->year 01/01/86, version Bosch							1.406.059R						
All engines										1.970.126	C10			
ENGINE														
2.2 Turbo quattro	Petrol	147	02/88-11/90	1B										
Engine	Information				A10	A20	A40	A50	A70	C10 - C30	C20	E01		
All engines	version Bosch						1.306.231	1.406.121R						
80 II														
ENGINE														
1.3	Petrol	44	09/78-07/86	EP										
Engine	Information				A10	A20	A40	A50	A70	C10 - C30	C20	E01		
All engines	version Bosch						1.306.094	1.406.055R	1.906.219					
All engines	->ch. 81-F-220 000									1.970.125	C10			
All engines	ch. 81-G-000 001 ->									1.970.127	C10			

A10	CONDENSER	A20	CONTACT SET	A40	DISTRIBUTOR CAP	A50	ROTOR	A70	PICK-UP
C10	COIL	C20	IGNITION MODULE	C30	ELECTRONIC IGNITION KIT	E01	IGNITION CABLE SET		

The present application list is a brief version. For the detailed information about the possibility of installation on a specific vehicle, please refer to our web-catalogue <http://catalogo.facet.eu/>

FUNCTIONS ON THE VEHICLE

Vehicle	alim.	kW	Date	Engine								
---------	-------	----	------	--------	---	---	---	--	---	---	---	---

80 II

				ENGINE
1.3	Petrol	44	09/78-07/86	EP

Engine	Information	A10	A20	A40	A50	A70	C10 - C30	C20	E01
All engines								1.965.007	1.500.768

				ENGINE
1.6	Petrol	54	02/86-07/86	SA

Engine	Information	A10	A20	A40	A50	A70	C10 - C30	C20	E01
All engines	version Bosch			1.306.266	1.406.055R	1.906.219			
All engines	->ch. 81-F-220 000						1.970.125	C10	
All engines	ch. 81-G-000 001 ->						1.970.127	C10	
All engines								1.965.007	1.500.768

				ENGINE
1.6	Petrol	55	08/78-03/87	DT, JU, WV

Engine	Information	A10	A20	A40	A50	A70	C10 - C30	C20	E01
Eng. WV	version Bosch, ->year 01/01/85			1.306.079					
All engines	version Bosch, 01/01/85 ->			1.306.094					
Eng. DT	version Ducellier			1.315.068	1.415.099R				
All engines	version Bosch				1.406.055R				
All engines	version Bosch, 01/01/83 ->, ->year 01/01/85					1.906.219			
Eng. WV	version Bosch, 01/01/85 ->					1.906.231			
All engines	01/01/85 ->, ->ch. 81-F-220 000						1.970.125	C10	
Eng. DT, JU	ch. 81-G-000 001 ->						1.970.127	C10	
Eng. WV	->year 01/01/85						1.970.132	C10	
Eng. WV								1.965.004	
Eng. DT, JU								1.965.007	
All engines									1.500.768

				ENGINE
1.8	Petrol	65	02/86-07/86	SF

Engine	Information	A10	A20	A40	A50	A70	C10 - C30	C20	E01
All engines	version Bosch			1.306.266	1.406.055R	1.906.219			
All engines	->ch. 81-F-220 000						1.970.125	C10	
All engines	ch. 81-G-000 001 ->						1.970.127	C10	
All engines								1.965.007	1.500.768

				ENGINE
1.8	Petrol	66	01/83-08/86	DS

Engine	Information	A10	A20	A40	A50	A70	C10 - C30	C20	E01
All engines	version Bosch			1.306.094	1.406.055R	1.906.219			
All engines	version Ducellier			1.315.068	1.415.099R				
All engines	->ch. 81-F-220 000						1.970.125	C10	
All engines	ch. 81-G-000 001 ->						1.970.127	C10	
All engines								1.965.007	1.500.768

				ENGINE
1.8	Petrol	68	08/83-08/86	JN

Engine	Information	A10	A20	A40	A50	A70	C10 - C30	C20	E01
All engines	version Bosch			1.306.094	1.406.055R	1.906.219			
All engines	->ch. 81-F-220 000						1.970.125	C10	
All engines	ch. 81-G-000 001 ->						1.970.127	C10	
All engines								1.965.007	1.500.768

				ENGINE
1.8 CC quattro	Petrol	66	08/84-08/86	JV

Engine	Information	A10	A20	A40	A50	A70	C10 - C30	C20	E01
All engines	ch. 81-G-000 001 ->, version Bosch			1.306.094					
All engines	->ch. 81-F-220 000, version Bosch				1.406.055R				
All engines	version Bosch					1.906.219			
All engines	->ch. 81-F-220 000						1.970.125	C10	
All engines	ch. 81-G-000 001 ->						1.970.127	C10	
All engines								1.965.007	1.500.768

				ENGINE
1.8 CC quattro	Petrol	68	08/85-08/86	JN









Engine	Information	A10	A20	A40	A50	A70	C10 - C30	C20	E01
All engines	version Bosch			1.306.094	1.406.055R	1.906.219			
All engines	->ch. 81-F-220 000						1.970.125	C10	

A10	CONDENSER	A20	CONTACT SET	A40	DISTRIBUTOR CAP	A50	ROTOR	A70	PICK-UP
C10	COIL	C20	IGNITION MODULE	C30	ELECTRONIC IGNITION KIT	E01	IGNITION CABLE SET		

Vehicle	alim.	kW	Date	Engine	FUNCTIONS ON THE VEHICLE									
					A10	A20	A40	A50	A70	C10 - C30	C20	E01		
ENGINE														
1.8 CC quattro	Petrol	68	08/85-08/86	JN										
Engine	Information				A10	A20	A40	A50	A70	C10 - C30	C20	E01		
All engines	ch. 81-G-000 001 ->									1.970.127	C10			
All engines											1.965.007	1.500.768		
ENGINE														
1.8 GTE	Petrol	81	08/85-07/86	PV										
Engine	Information				A10	A20	A40	A50	A70	C10 - C30	C20	E01		
All engines	version Bosch						1.306.266	1.406.121R						
All engines	->ch. 81-F-220 000									1.970.125	C10			
All engines	ch. 81-G-000 001 ->									1.970.127	C10			
All engines											1.965.007	1.500.768		
ENGINE														
1.8 GTE	Petrol	82	06/84-03/87	DZ, MU										
Engine	Information				A10	A20	A40	A50	A70	C10 - C30	C20	E01		
Eng. DZ	->ch. 81-F-220 000, version Bosch						1.306.094	1.406.116R						
All engines	ch. 81-G-000 001 ->, version Bosch						1.306.266	1.406.055R	1.906.219					
All engines	->ch. 81-F-220 000									1.970.125	C10			
All engines	ch. 81-G-000 001 ->									1.970.127	C10			
All engines											1.965.007	1.500.768		
ENGINE														
2.0	Petrol	85	10/83-09/84	HP, JS										
Engine	Information				A10	A20	A40	A50	A70	C10 - C30	C20	E01		
All engines	version Bosch						1.306.231							
All engines	ch. 81-G-000 001 ->, version Bosch							1.406.055R						
All engines	->ch. 81-F-220 000, version Bosch							1.406.116R						
Eng. JS	version Bosch								1.906.219					
All engines	->ch. 81-F-220 000									1.970.125	C10			
All engines	ch. 81-G-000 001 ->									1.970.127	C10			
All engines											1.965.007	1.501.682		
ENGINE														
2.0 quattro	Petrol	85	10/83-09/84	JS										
Engine	Information				A10	A20	A40	A50	A70	C10 - C30	C20	E01		
All engines	version Bosch						1.306.231		1.906.219					
All engines	ch. 81-G-000 001 ->, version Bosch							1.406.055R						
All engines	->ch. 81-F-220 000, version Bosch							1.406.116R						
All engines	->ch. 81-F-220 000									1.970.125	C10			
All engines	ch. 81-G-000 001 ->									1.970.127	C10			
All engines											1.965.007	1.501.682		
ENGINE														
80 III														
ENGINE														
1.4	Petrol	48	08/86-07/88	SE										
Engine	Information				A10	A20	A40	A50	A70	C10 - C30	C20	E01		
All engines	version Bosch						1.306.266	1.406.055R	1.906.219					
All engines	version Ducellier						1.315.068	1.415.099R						
All engines										1.970.127	C10	1.965.007	1.500.768	
ENGINE														
1.6	Petrol	51	09/86-09/91	PP, RNA										
Engine	Information				A10	A20	A40	A50	A70	C10 - C30	C20	E01		
All engines	version Bosch						1.306.266	1.406.055R	1.906.219					
All engines	version Ducellier						1.315.068	1.415.099R						
All engines										1.970.127	C10	1.965.007	1.500.768	
ENGINE														
1.6	Petrol	55	09/86-08/91	RN										
Engine	Information				A10	A20	A40	A50	A70	C10 - C30	C20	E01		
All engines	version Bosch						1.306.266	1.406.055R	1.906.219					
All engines	version Ducellier						1.315.068	1.415.099R						
All engines										1.970.127	C10	1.965.007	1.500.768	
ENGINE														
1.6	Petrol	75	08/90-10/91	ABB										
Engine	Information				A10	A20	A40	A50	A70	C10 - C30	C20	E01		
All engines	version Bosch						1.306.266	1.406.055R						

A10	CONDENSER	A20	CONTACT SET	A40	DISTRIBUTOR CAP	A50	ROTOR	A70	PICK-UP
C10	COIL	C20	IGNITION MODULE	C30	ELECTRONIC IGNITION KIT	E01	IGNITION CABLE SET		

The present application list is a brief version. For the detailed information about the possibility of installation on a specific vehicle, please refer to our web-catalogue <http://catalogo.facet.eu/>



				FUNCTIONS ON THE VEHICLE									
Vehicle	alim.	kW	Date	Engine	 A10	 A20	 A40	 A50	 A70	 C10 - C30	 C20	 E01	
				ENGINE									
1.6	Petrol	75	08/90-10/91	ABB									
				ENGINE									
Engine		Information		A10	A20	A40	A50	A70	C10 - C30	C20	E01		
All engines		version Bosch, MODEL TO: 1991						1.906.219					
All engines									1.970.127	C10	1.965.007	1.500.768	
				ENGINE									
1.8	Petrol	55	10/86-01/90	RU									
				ENGINE									
Engine		Information		A10	A20	A40	A50	A70	C10 - C30	C20	E01		
All engines		version Bosch				1.306.266	1.406.055R	1.906.219					
All engines		version Ducellier				1.315.068	1.415.099R						
All engines									1.970.127	C10	1.965.007	1.500.768	
				ENGINE									
1.8	Petrol	83	09/86-07/88	SD									
				ENGINE									
Engine		Information		A10	A20	A40	A50	A70	C10 - C30	C20	E01		
All engines		version Bosch				1.306.266	1.406.121R						
All engines									1.970.127	C10	1.965.007	1.500.768	
				ENGINE									
1.8 E	Petrol	82	06/86-08/91	DZ									
				ENGINE									
Engine		Information		A10	A20	A40	A50	A70	C10 - C30	C20	E01		
All engines		version Bosch				1.306.266	1.406.055R	1.906.219					
All engines									1.970.127	C10	1.965.007	1.500.768	
				ENGINE									
1.8 E quattro	Petrol	82	09/86-08/91	DZ									
				ENGINE									
Engine		Information		A10	A20	A40	A50	A70	C10 - C30	C20	E01		
All engines									1.970.127	C10		1.500.768	
				ENGINE									
1.8 quattro	Petrol	83	09/86-08/90	SD									
				ENGINE									
Engine		Information		A10	A20	A40	A50	A70	C10 - C30	C20	E01		
All engines		version Bosch				1.306.129	1.406.121R	1.906.231					
All engines									1.970.127	C10	1.965.004	1.500.768	
				ENGINE									
1.8 S	Petrol	65	08/86-01/90	SF									
				ENGINE									
Engine		Information		A10	A20	A40	A50	A70	C10 - C30	C20	E01		
All engines		version Bosch				1.306.266	1.406.055R	1.906.219					
All engines									1.970.127	C10	1.965.007	1.500.768	
				ENGINE									
1.8 S	Petrol	66	09/86-10/91	JN, JV, NE, PM									
				ENGINE									
Engine		Information		A10	A20	A40	A50	A70	C10 - C30	C20	E01		
All engines		version Bosch				1.306.266							
Eng. NE		version Ducellier				1.315.068	1.415.099R						
All engines		->ch. 8A-L-500000, version Bosch					1.406.055R	1.906.219					
Eng. PM		ch. 8A-M-000001 ->, version Bosch					1.406.121R						
All engines		->ch. 8A-L-500000							1.970.127	C10			
All engines											1.965.007	1.500.768	
				ENGINE									
1.8 S quattro	Petrol	65	09/86-07/90	SF									
				ENGINE									
Engine		Information		A10	A20	A40	A50	A70	C10 - C30	C20	E01		
All engines									1.970.127	C10		1.500.768	
				ENGINE									
1.8 S quattro	Petrol	66	09/86-09/91	JN, NE, PM									
				ENGINE									
Engine		Information		A10	A20	A40	A50	A70	C10 - C30	C20	E01		
Eng. JN		version Bosch				1.306.129	1.406.055R	1.906.231					
All engines									1.970.127	C10		1.500.768	
Eng. JN											1.965.004		
				ENGINE									
2.0	Petrol	82	10/90-08/91	AAD									
				ENGINE									
Engine		Information		A10	A20	A40	A50	A70	C10 - C30	C20	E01		
All engines		version Bosch				1.306.266	1.406.121R						
All engines									1.970.127	C10	1.965.007	1.500.768	

A10 CONDENSER	A20 CONTACT SET	A40 DISTRIBUTOR CAP	A50 ROTOR	A70 PICK-UP
C10 COIL	C20 IGNITION MODULE	C30 ELECTRONIC IGNITION KIT	E01 IGNITION CABLE SET	

Vehicle	alim.	kW	Date	Engine	FUNCTIONS ON THE VEHICLE									
					A10	A20	A40	A50	A70	C10 - C30	C20	E01		
ENGINE														
2.0 E	Petrol	83	08/88-10/90	3A										
Engine	Information				A10	A20	A40	A50	A70	C10 - C30	C20	E01		
All engines	version Bosch						1.306.266	1.406.121R						
All engines											1.965.007	1.500.768		
ENGINE														
2.0 E 16V	Petrol	101	03/90-09/91	6A										
Engine	Information				A10	A20	A40	A50	A70	C10 - C30	C20	E01		
All engines	version Bosch						1.306.248							
All engines											1.965.007			
ENGINE														
2.0 E 16V quattro	Petrol	101	03/90-08/91	6A										
Engine	Information				A10	A20	A40	A50	A70	C10 - C30	C20	E01		
All engines	version Bosch						1.306.248							
ENGINE														
2.0 E quattro	Petrol	83	08/88-09/90	3A										
Engine	Information				A10	A20	A40	A50	A70	C10 - C30	C20	E01		
All engines	version Bosch						1.306.129	1.406.121R						
All engines												1.500.768		
ENGINE														
2.0 quattro	Petrol	82	08/88-07/90	3A										
Engine	Information				A10	A20	A40	A50	A70	C10 - C30	C20	E01		
All engines												1.500.768		
ENGINE														
2.0 quattro	Petrol	85	10/90-08/91	AA0										
Engine	Information				A10	A20	A40	A50	A70	C10 - C30	C20	E01		
All engines												1.500.768		
ENGINE														
80 IV														
1.6	Petrol	52	09/91-12/94	ABM										
Engine	Information				A10	A20	A40	A50	A70	C10 - C30	C20	E01		
All engines	version Bosch						1.306.266	1.406.121R						
All engines												1.500.768		
ENGINE														
1.6	Petrol	75	03/92-05/93	ABB										
Engine	Information				A10	A20	A40	A50	A70	C10 - C30	C20	E01		
All engines	version Bosch						1.306.266	1.406.055R						
All engines										1.970.127	C10	1.965.007	1.500.768	
ENGINE														
1.6 E	Petrol	74	06/93-01/96	ADA										
Engine	Information				A10	A20	A40	A50	A70	C10 - C30	C20	E01		
All engines	version Bosch						1.306.266	1.406.121R	1.906.223					
All engines												1.500.768		
ENGINE														
2.0	Petrol	66	09/91-01/96	ABT										
Engine	Information				A10	A20	A40	A50	A70	C10 - C30	C20	E01		
All engines	version Bosch						1.306.266	1.406.121R						
All engines												1.500.768		
ENGINE														
2.0 E	Petrol	85	09/91-01/96	ABK										
Engine	Information				A10	A20	A40	A50	A70	C10 - C30	C20	E01		
All engines	version Bosch						1.306.266	1.406.121R						
All engines	->year 01/07/93									1.990.414	C30			
All engines												1.500.768		
ENGINE														
2.0 E 16V	Petrol	101	09/91-07/92	6A										
Engine	Information				A10	A20	A40	A50	A70	C10 - C30	C20	E01		
All engines	version Bosch						1.306.248							

A10	CONDENSER	A20	CONTACT SET	A40	DISTRIBUTOR CAP	A50	ROTOR	A70	PICK-UP
C10	COIL	C20	IGNITION MODULE	C30	ELECTRONIC IGNITION KIT	E01	IGNITION CABLE SET		

The present application list is a brief version. For the detailed information about the possibility of installation on a specific vehicle, please refer to our web-catalogue <http://catalogo.facet.eu/>

				FUNCTIONS ON THE VEHICLE									
Vehicle	alim.	kW	Date	Engine	 A10	 A20	 A40	 A50	 A70	 C10 - C30	 C20	 E01	
				ENGINE									
2.0 E 16V	Petrol	103	08/92-01/96	ACE									
Engine		Information			A10	A20	A40	A50	A70	C10 - C30	C20	E01	
All engines		version Bosch					1.306.248						
				ENGINE									
2.0 E quattro	Petrol	85	09/91-12/94	ABK									
Engine		Information			A10	A20	A40	A50	A70	C10 - C30	C20	E01	
All engines		version Bosch					1.306.094	1.406.121R					
All engines		->ch. 8C-P-300 000								1.990.414	C30		
All engines												1.500.768	
				ENGINE									
2.0 quattro	Petrol	79	11/93-01/96	ADW									
Engine		Information			A10	A20	A40	A50	A70	C10 - C30	C20	E01	
All engines		version Bosch					1.306.266	1.406.121R					
All engines												1.500.768	
				ENGINE									
2.3 E	Petrol	98	09/91-01/96	NG									
Engine		Information			A10	A20	A40	A50	A70	C10 - C30	C20	E01	
All engines		version Bosch					1.306.231	1.406.121R					
All engines												1.501.682	
				ENGINE									
2.3 E quattro	Petrol	98	09/91-12/94	NG									
Engine		Information			A10	A20	A40	A50	A70	C10 - C30	C20	E01	
All engines							1.306.231	1.406.121R				1.501.682	
				ENGINE									
2.6	Petrol	110	07/92-01/96	ABC									
Engine		Information			A10	A20	A40	A50	A70	C10 - C30	C20	E01	
All engines											1.965.051		
				ENGINE									
2.6 E	Petrol	102	05/93-05/95	ACZ									
Engine		Information			A10	A20	A40	A50	A70	C10 - C30	C20	E01	
All engines											1.965.051		
				ENGINE									
2.6 E quattro	Petrol	102	11/93-05/95	ACZ									
Engine		Information			A10	A20	A40	A50	A70	C10 - C30	C20	E01	
All engines											1.965.051		
				ENGINE									
2.6 quattro	Petrol	102	08/94-01/96	ACZ									
Engine		Information			A10	A20	A40	A50	A70	C10 - C30	C20	E01	
All engines											1.965.051		
				ENGINE									
2.6 quattro	Petrol	110	06/92-07/95	ABC									
Engine		Information			A10	A20	A40	A50	A70	C10 - C30	C20	E01	
All engines											1.965.051		
				ENGINE									
2.8	Petrol	128	09/91-01/96	AAH									
Engine		Information			A10	A20	A40	A50	A70	C10 - C30	C20	E01	
All engines											1.965.051		
				ENGINE									
2.8 quattro	Petrol	128	09/91-07/95	AAH									
Engine		Information			A10	A20	A40	A50	A70	C10 - C30	C20	E01	
All engines											1.965.051		
				ENGINE									
				90 I									
1.8	Petrol	66	06/84-03/87	JN									
Engine		Information			A10	A20	A40	A50	A70	C10 - C30	C20	E01	
All engines		version Bosch					1.306.094	1.406.055R	1.906.219				
All engines		->ch. 81-F-220 000								1.970.125	C10		
All engines		ch. 81-G-000 001 ->								1.970.127	C10		
All engines											1.965.007	1.500.768	

A10 CONDENSER	A20 CONTACT SET	A40 DISTRIBUTOR CAP	A50 ROTOR	A70 PICK-UP
C10 COIL	C20 IGNITION MODULE	C30 ELECTRONIC IGNITION KIT	E01 IGNITION CABLE SET	

Vehicle	alim.	kW	Date	Engine	FUNCTIONS ON THE VEHICLE							
					A10	A20	A40	A50	A70	C10 - C30	C20	E01

ENGINE				
2.0	Petrol	81	10/84-03/87	JL

Engine	Information	A10	A20	A40	A50	A70	C10 - C30	C20	E01
All engines	version Bosch			1.306.231	1.406.055R	1.906.219			
All engines	->ch. 81-F-220 000						1.970.125	C10	
All engines	ch. 81-G-000 001 ->						1.970.127	C10	
All engines								1.965.007	1.501.682

ENGINE				
2.0	Petrol	83	03/86-03/87	SK

Engine	Information	A10	A20	A40	A50	A70	C10 - C30	C20	E01
All engines	version Bosch			1.306.231	1.406.121R				
All engines	->ch. 81-F-220 000						1.970.125	C10	
All engines	ch. 81-G-000 001 ->						1.970.127	C10	
All engines								1.965.007	1.501.682

ENGINE				
2.0	Petrol	85	10/84-03/87	HP, JS

Engine	Information	A10	A20	A40	A50	A70	C10 - C30	C20	E01
All engines	version Bosch			1.306.231					
All engines	ch. 81-G-000 001 ->, version Bosch				1.406.055R				
All engines	->ch. 81-F-220 000, version Bosch				1.406.116R				
Eng. JS	version Bosch					1.906.219			
All engines	->ch. 81-F-220 000						1.970.125	C10	
All engines	ch. 81-G-000 001 ->						1.970.127	C10	
All engines								1.965.007	1.501.682

ENGINE				
2.0 quattro	Petrol	85	08/84-08/86	JS

Engine	Information	A10	A20	A40	A50	A70	C10 - C30	C20	E01
All engines	version Bosch			1.306.231		1.906.219			
All engines	ch. 81-G-000 001 ->, version Bosch				1.406.055R				
All engines	->ch. 81-F-220 000, version Bosch				1.406.116R				
All engines	->ch. 81-F-220 000						1.970.125	C10	
All engines	ch. 81-G-000 001 ->						1.970.127	C10	
All engines								1.965.007	1.501.682

ENGINE				
2.2	Petrol	100	10/84-03/87	9C54, HY

Engine	Information	A10	A20	A40	A50	A70	C10 - C30	C20	E01
All engines	version Bosch			1.306.231	1.406.116R				
Eng. 9C54	version Bosch					1.906.219			
All engines	->ch. 81-F-220 000						1.970.125	C10	
All engines	ch. 81-G-000 001 ->						1.970.127	C10	
All engines								1.965.007	1.501.682

ENGINE				
2.2	Petrol	85	01/85-03/87	KX

Engine	Information	A10	A20	A40	A50	A70	C10 - C30	C20	E01
All engines	version Bosch			1.306.231	1.406.055R	1.906.219			
All engines	->ch. 81-F-220 000						1.970.125	C10	
All engines	ch. 81-G-000 001 ->						1.970.127	C10	
All engines								1.965.007	









ENGINE				
2.2 E quattro	Petrol	100	11/84-03/87	9C54

Engine	Information	A10	A20	A40	A50	A70	C10 - C30	C20	E01
All engines	version Bosch			1.306.231	1.406.116R	1.906.219			
All engines	->ch. 81-F-220 000						1.970.125	C10	
All engines	ch. 81-G-000 001 ->						1.970.127	C10	
All engines								1.965.007	1.501.682

ENGINE				
2.0	Petrol	85	07/88-09/91	PS

Engine	Information	A10	A20	A40	A50	A70	C10 - C30	C20	E01
All engines	version Bosch			1.306.231					
All engines	version Bosch, distr. num. 034 905 206				1.406.055R	1.906.219			
All engines	version Bosch, distr. num. 034 905 205 H				1.406.121R				
All engines	-catalytic converter						1.970.127	C10	

A10	CONDENSER	A20	CONTACT SET	A40	DISTRIBUTOR CAP	A50	ROTOR	A70	PICK-UP
C10	COIL	C20	IGNITION MODULE	C30	ELECTRONIC IGNITION KIT	E01	IGNITION CABLE SET		









					FUNCTIONS ON THE VEHICLE								
Vehicle	alim.	kW	Date	Engine	 A10	 A20	 A40	 A50	 A70	 C10 - C30	 C20	 E01	
90 II													
2.0	Petrol	85	07/88-09/91	PS									
Engine	Information				A10	A20	A40	A50	A70	C10 - C30	C20	E01	
All engines											1.965.007	1.501.682	
2.0 20 V													
2.0 20 V	Petrol	118	08/89-07/91	NM									
Engine	Information				A10	A20	A40	A50	A70	C10 - C30	C20	E01	
All engines											1.965.007		
2.0 20 V quattro													
2.0 20 V quattro	Petrol	118	08/88-09/91	NM									
Engine	Information				A10	A20	A40	A50	A70	C10 - C30	C20	E01	
All engines	version Bosch						1.306.231						
2.2 E													
2.2 E	Petrol	100	04/87-07/91	9C54									
Engine	Information				A10	A20	A40	A50	A70	C10 - C30	C20	E01	
All engines	version Bosch						1.306.231	1.406.055R	1.906.219				
All engines										1.970.127	C10	1.965.007	
All engines												1.501.682	
2.2 E quattro													
2.2 E quattro	Petrol	100	04/87-09/91	9C54									
Engine	Information				A10	A20	A40	A50	A70	C10 - C30	C20	E01	
All engines	version Bosch						1.306.231	1.406.055R	1.906.219				
All engines	->ch. 81-F-220 000									1.970.125	C10		
All engines	ch. 81-G-000 001 ->									1.970.127	C10		
All engines											1.965.004	1.501.682	
2.3 E													
2.3 E	Petrol	100	04/87-07/91	NG									
Engine	Information				A10	A20	A40	A50	A70	C10 - C30	C20	E01	
All engines	version Bosch						1.306.231	1.406.121R					
All engines											1.965.007	1.501.682	
2.3 E													
2.3 E	Petrol	98	04/87-09/91	NG									
Engine	Information				A10	A20	A40	A50	A70	C10 - C30	C20	E01	
All engines	version Bosch						1.306.231	1.406.121R					
All engines											1.965.007	1.501.682	
2.3 E 20V													
2.3 E 20V	Petrol	123	04/90-07/91	7A									
Engine	Information				A10	A20	A40	A50	A70	C10 - C30	C20	E01	
All engines											1.965.007		
2.3 E 20V													
2.3 E 20V	Petrol	125	08/88-07/91	7A									
Engine	Information				A10	A20	A40	A50	A70	C10 - C30	C20	E01	
All engines											1.965.007		
2.3 E 20V quattro													
2.3 E 20V quattro	Petrol	125	06/88-09/91	7A									
Engine	Information				A10	A20	A40	A50	A70	C10 - C30	C20	E01	
All engines	version Bosch						1.306.231	1.406.121R					
2.3 E quattro													
2.3 E quattro	Petrol	100	04/87-07/91	NG									
Engine	Information				A10	A20	A40	A50	A70	C10 - C30	C20	E01	
All engines												1.501.682	
2.3 E quattro													
2.3 E quattro	Petrol	98	04/87-09/91	NG									
Engine	Information				A10	A20	A40	A50	A70	C10 - C30	C20	E01	
All engines	version Bosch						1.306.231	1.406.121R					
All engines												1.501.682	
90 SUPER													
1.8	Petrol	66	09/66-08/71	21, 8921									
Engine	Information				A10	A20	A40	A50	A70	C10 - C30	C20	E01	
All engines						1.206.029HV							

A10 CONDENSER	A20 CONTACT SET	A40 DISTRIBUTOR CAP	A50 ROTOR	A70 PICK-UP
C10 COIL	C20 IGNITION MODULE	C30 ELECTRONIC IGNITION KIT	E01 IGNITION CABLE SET	

Vehicle	alim.	kW	Date	Engine	FUNCTIONS ON THE VEHICLE							
					A10	A20	A40	A50	A70	C10 - C30	C20	E01
A1												
1.0 TFSI	Petrol	60	01/16-10/18	CHZE								
Engine	Information				A10	A20	A40	A50	A70	C10 - C30	C20	E01
All engines	x 3, BERU, ELDOR, COIL ON PLUG, incl. spark plug connector, Number of pins:4, incl. spark plug connector									1.970.599	C10	
1.0 TFSI	Petrol	70	03/15-10/18	CHZB, DKLD								
Engine	Information				A10	A20	A40	A50	A70	C10 - C30	C20	E01
All engines	x 3, BERU, ELDOR, COIL ON PLUG, incl. spark plug connector, Number of pins:4, incl. spark plug connector									1.970.599	C10	
1.2 TFSI	Petrol	63	05/10-04/15	CBZA								
Engine	Information				A10	A20	A40	A50	A70	C10 - C30	C20	E01
All engines										1.990.420	C30	1.499.248
1.4 TFSI	Petrol	103	04/12-04/15	CPTA								
Engine	Information				A10	A20	A40	A50	A70	C10 - C30	C20	E01
All engines	x 4, BERU, ELDOR, COIL ON PLUG, incl. spark plug connector, Number of pins:4, incl. spark plug connector									1.970.599	C10	
1.4 TFSI	Petrol	136	01/11-04/15	CAVG, CTHG								
Engine	Information				A10	A20	A40	A50	A70	C10 - C30	C20	E01
All engines	x 4, COIL ON PLUG, incl. spark plug connector									1.970.474	C10	
1.4 TFSI	Petrol	90	05/10-04/15	CAXA, CNVA								
Engine	Information				A10	A20	A40	A50	A70	C10 - C30	C20	E01
All engines	x 4, COIL ON PLUG, incl. spark plug connector									1.970.474	C10	
1.4 TFSI	Petrol	92	11/14-10/18	CZCA, CZDD								
Engine	Information				A10	A20	A40	A50	A70	C10 - C30	C20	E01
All engines	x 4, BERU, ELDOR, COIL ON PLUG, incl. spark plug connector, Number of pins:4, incl. spark plug connector									1.970.599	C10	
1.4 TSI	Petrol	110	11/14-10/18	CZEA								
Engine	Information				A10	A20	A40	A50	A70	C10 - C30	C20	E01
All engines	x 4, BERU, ELDOR, COIL ON PLUG, incl. spark plug connector, Number of pins:4, incl. spark plug connector									1.970.599	C10	
1.8 TFSI	Petrol	141	02/15-10/18	DAJB								
Engine	Information				A10	A20	A40	A50	A70	C10 - C30	C20	E01
All engines	x 4, HITACHI, COIL ON PLUG, incl. spark plug connector									1.970.636	C10	
2.0 TFSI quattro	Petrol	188	03/12-11/12	COLH								
Engine	Information				A10	A20	A40	A50	A70	C10 - C30	C20	E01
All engines	x 4, ELDOR, Housing Colour:Black, COIL ON PLUG, incl. spark plug connector									1.970.426	C10	
25 TFSI	Petrol	70	11/18->	DKLA, DLAC								
Engine	Information				A10	A20	A40	A50	A70	C10 - C30	C20	E01
All engines	x 3, BERU, ELDOR, COIL ON PLUG, incl. spark plug connector, Number of pins:4, incl. spark plug connector									1.970.599	C10	
30 TFSI	Petrol	81	09/20->	DLAA								
Engine	Information				A10	A20	A40	A50	A70	C10 - C30	C20	E01
All engines	x 3, ELDOR, COIL ON PLUG, incl. spark plug connector, Number of pins:4, incl. spark plug connector									1.970.599	C10	
30 TFSI	Petrol	85	07/18->	DKJA, DKRF								
Engine	Information				A10	A20	A40	A50	A70	C10 - C30	C20	E01
All engines	x 3, ELDOR, COIL ON PLUG, incl. spark plug connector, Number of pins:4, incl. spark plug connector									1.970.599	C10	
40 TFSI	Petrol	147	09/18->	CZPC, DKZC								
Engine	Information				A10	A20	A40	A50	A70	C10 - C30	C20	E01
All engines	x 4, HITACHI, COIL ON PLUG, incl. spark plug connector									1.970.636	C10	

A10 CONDENSER	A20 CONTACT SET	A40 DISTRIBUTOR CAP	A50 ROTOR	A70 PICK-UP
C10 COIL	C20 IGNITION MODULE	C30 ELECTRONIC IGNITION KIT	E01 IGNITION CABLE SET	

The present application list is a brief version. For the detailed information about the possibility of installation on a specific vehicle, please refer to our web-catalogue <http://catalogo.facet.eu/>









					FUNCTIONS ON THE VEHICLE							
Vehicle	alim.	kW	Date	Engine	 A10	 A20	 A40	 A50	 A70	 C10 - C30	 C20	 E01
ENGINE												
40 TFSI	Petrol	152	04/21->	DNND								
Engine	Information				A10	A20	A40	A50	A70	C10 - C30	C20	E01
All engines	x 4, HITACHI, COIL ON PLUG, incl. spark plug connector									1.970.636	C10	
A2												
1.4	Petrol	55	02/00-08/05	AUA, BBY								
Engine	Information				A10	A20	A40	A50	A70	C10 - C30	C20	E01
Eng. BBY	x 4, COIL ON PLUG, incl. spark plug connector									1.970.474	C10	
Eng. AUA										1.990.420	C30	1.501.575
ENGINE												
1.6 FSI	Petrol	81	05/02-08/05	BAD								
Engine	Information				A10	A20	A40	A50	A70	C10 - C30	C20	E01
All engines	x 4, COIL ON PLUG, incl. spark plug connector									1.970.474	C10	
A3 I												
1.6	Petrol	74	09/96-05/03	AEH, AKL, APF								
Engine	Information				A10	A20	A40	A50	A70	C10 - C30	C20	E01
All engines										1.990.420	C30	
Eng. AEH, AKL	ch. 8L-V-080 001 ->, ->ch. 8L-W-070 000											1.501.479
All engines	ch. 8L-W-070 001 ->											1.501.484
Eng. AEH	->ch. 8L-V-080 000											1.501.585
ENGINE												
1.6	Petrol	75	08/00-05/03	AVU, BFQ								
Engine	Information				A10	A20	A40	A50	A70	C10 - C30	C20	E01
All engines										1.990.420	C30	1.501.585
ENGINE												
1.8	Petrol	92	09/96-05/03	AGN, APG								
Engine	Information				A10	A20	A40	A50	A70	C10 - C30	C20	E01
All engines										1.990.420	C30	
All engines	ch. 8L-V-140 001 ->											1.501.489
ENGINE												
1.8 T	Petrol	110	12/96-05/03	AGU, ARZ, AUM								
Engine	Information				A10	A20	A40	A50	A70	C10 - C30	C20	E01
Eng. AGU	x 4, COIL ON PLUG									1.970.354S	C10	
Eng. AGU, AUM	x 4, COIL ON PLUG, incl. spark plug connector									1.970.429	C10	
Eng. ARZ	x 4, COIL ON PLUG, incl. spark plug connector									1.970.445	C10	
Eng. AGU											1.965.076	
ENGINE												
1.8 T	Petrol	132	12/98-05/03	AJQ, APP, ARY, AUQ								
Engine	Information				A10	A20	A40	A50	A70	C10 - C30	C20	E01
Eng. ARY, AUQ	x 4, COIL ON PLUG, incl. spark plug connector									1.970.429	C10	
Eng. AJQ, APP	x 4, COIL ON PLUG, incl. spark plug connector									1.970.445	C10	
ENGINE												
1.8 T quattro	Petrol	110	12/96-05/03	AGU, AQA, ARX								
Engine	Information				A10	A20	A40	A50	A70	C10 - C30	C20	E01
Eng. AGU	x 4, COIL ON PLUG									1.970.354S	C10	
Eng. ARX	x 4, COIL ON PLUG, incl. spark plug connector									1.970.429	C10	
Eng. AQA	x 4, COIL ON PLUG, incl. spark plug connector									1.970.445	C10	
Eng. AGU											1.965.076	
ENGINE												
1.8 T quattro	Petrol	132	10/98-05/03	AJQ, ARY								
Engine	Information				A10	A20	A40	A50	A70	C10 - C30	C20	E01
Eng. ARY	x 4, COIL ON PLUG, incl. spark plug connector									1.970.429	C10	
Eng. AJQ	x 4, COIL ON PLUG, incl. spark plug connector									1.970.445	C10	
ENGINE												
S3 quattro	Petrol	154	03/99-04/02	AMK, APY, AUL								
Engine	Information				A10	A20	A40	A50	A70	C10 - C30	C20	E01
All engines	S3 Quattro, 01/01/01 ->, x 4, COIL ON PLUG, incl. spark plug connector									1.970.429	C10	
All engines	S3 Quattro, ->year 01/12/00, x 4, COIL ON PLUG, incl. spark plug connector									1.970.445	C10	

A10 CONDENSER	A20 CONTACT SET	A40 DISTRIBUTOR CAP	A50 ROTOR	A70 PICK-UP
C10 COIL	C20 IGNITION MODULE	C30 ELECTRONIC IGNITION KIT	E01 IGNITION CABLE SET	

Vehicle	alim.	kW	Date	Engine	FUNCTIONS ON THE VEHICLE							
					A10	A20	A40	A50	A70	C10 - C30	C20	E01
S3 quattro												
ENGINE												
BAM												
Engine Information					A10	A20	A40	A50	A70	C10 - C30	C20	E01
All engines S3 Quattro, x 4, COIL ON PLUG, incl. spark plug connector										1.970.429	C10	
A3 II												
1.2 TFSI												
ENGINE												
CBZB												
Engine Information					A10	A20	A40	A50	A70	C10 - C30	C20	E01
All engines										1.990.420	C30	1.499.248
1.2 TSI												
ENGINE												
CBZB												
Engine Information					A10	A20	A40	A50	A70	C10 - C30	C20	E01
All engines										1.990.420	C30	1.499.248
1.4 TFSI												
ENGINE												
CAXC, CMSA												
Engine Information					A10	A20	A40	A50	A70	C10 - C30	C20	E01
All engines x 4, COIL ON PLUG, incl. spark plug connector										1.970.474	C10	
1.6												
ENGINE												
BGU, BSE, BSF, CCSA												
Engine Information					A10	A20	A40	A50	A70	C10 - C30	C20	E01
All engines Eng. BGU, BSE, BSF										1.990.420	C30	1.501.585
1.6 E-Power												
ENGINE												
CCSA, CMXA												
Engine Information					A10	A20	A40	A50	A70	C10 - C30	C20	E01
All engines										1.990.420	C30	1.501.585
1.6 FSI												
ENGINE												
BAG, BLF, BLP												
Engine Information					A10	A20	A40	A50	A70	C10 - C30	C20	E01
All engines x 4, COIL ON PLUG, incl. spark plug connector										1.970.474	C10	
1.8 TFSI												
ENGINE												
BYT, BZB, CDAA												
Engine Information					A10	A20	A40	A50	A70	C10 - C30	C20	E01
All engines x 4, ELDOR, Housing Colour:Black, COIL ON PLUG, incl. spark plug connector										1.970.426	C10	
1.8 TFSI quattro												
ENGINE												
CDAA												
Engine Information					A10	A20	A40	A50	A70	C10 - C30	C20	E01
All engines x 4, ELDOR, Housing Colour:Black, COIL ON PLUG, incl. spark plug connector										1.970.426	C10	
2.0 FSI												
ENGINE												
AXW, BLR, BLX, BLY, BMB, BVY, BVZ												
Engine Information					A10	A20	A40	A50	A70	C10 - C30	C20	E01
All engines x 4, ELDOR, Housing Colour:Black, COIL ON PLUG, incl. spark plug connector										1.970.426	C10	
2.0 TFSI												
ENGINE												
AXX, BPY, BWA, CAWB, CBFA, CCZA												
Engine Information					A10	A20	A40	A50	A70	C10 - C30	C20	E01
All engines x 4, ELDOR, Housing Colour:Black, COIL ON PLUG, incl. spark plug connector										1.970.426	C10	
2.0 TFSI quattro												
ENGINE												
AXX, BPY, BWA, CCTA, CCZA												
Engine Information					A10	A20	A40	A50	A70	C10 - C30	C20	E01
Eng. AXX, BPY, BWA, CCZA										1.970.426	C10	
Eng. CCTA										1.970.426	C10	
Qty: 4												
3.2 V6 quattro												
ENGINE												
BDB, BMJ, BUB												
Engine Information					A10	A20	A40	A50	A70	C10 - C30	C20	E01
All engines x 6, COIL ON PLUG										1.970.434	C10	

A10 CONDENSER	A20 CONTACT SET	A40 DISTRIBUTOR CAP	A50 ROTOR	A70 PICK-UP
C10 COIL	C20 IGNITION MODULE	C30 ELECTRONIC IGNITION KIT	E01 IGNITION CABLE SET	

The present application list is a brief version. For the detailed information about the possibility of installation on a specific vehicle, please refer to our web-catalogue <http://catalogo.facet.eu/>

					FUNCTIONS ON THE VEHICLE							
Vehicle	alim.	kW	Date	Engine	 A10	 A20	 A40	 A50	 A70	 C10 - C30	 C20	 E01
ENGINE												
RS3 quattro	Petrol	250	01/11-12/12	CEPA								
Engine	Information				A10	A20	A40	A50	A70	C10 - C30	C20	E01
All engines	RS3 Sportback Quattro, x 5, ELDOR, Housing Colour:-Black, COIL ON PLUG, incl. spark plug connector									1.970.426	C10	
ENGINE												
S3 quattro	Petrol	188	02/07-03/13	BZC, CDLC								
Engine	Information				A10	A20	A40	A50	A70	C10 - C30	C20	E01
All engines	S3 Quattro, S3 Sportback Quattro, x 4, ELDOR, Housing Colour:Black, COIL ON PLUG, incl. spark plug connector									1.970.426	C10	
ENGINE												
S3 quattro	Petrol	195	11/06-03/13	BHZ, CDLA								
Engine	Information				A10	A20	A40	A50	A70	C10 - C30	C20	E01
All engines	S3 Quattro, S3 Sportback Quattro, x 4, ELDOR, Housing Colour:Black, COIL ON PLUG, incl. spark plug connector									1.970.426	C10	
Eng. BHZ	Qty: 4									1.970.426	C10	
A3 III												
ENGINE												
1.0 TFSI	Petrol	85	07/16-10/20	CHZD, DKRF								
Engine	Information				A10	A20	A40	A50	A70	C10 - C30	C20	E01
All engines	x 3, BERU, ELDOR, COIL ON PLUG, incl. spark plug connector, Number of pins:4, incl. spark plug connector									1.970.599	C10	
ENGINE												
1.2 TFSI	Petrol	77	02/13->	CJZA								
Engine	Information				A10	A20	A40	A50	A70	C10 - C30	C20	E01
All engines	x 4, BERU, ELDOR, COIL ON PLUG, incl. spark plug connector, Number of pins:4, incl. spark plug connector									1.970.599	C10	
ENGINE												
1.2 TFSI	Petrol	81	05/14->	CVVB								
Engine	Information				A10	A20	A40	A50	A70	C10 - C30	C20	E01
All engines	x 4, BERU, ELDOR, HITACHI, COIL ON PLUG, incl. spark plug connector, Number of pins:4, incl. spark plug connector									1.970.599	C10	
ENGINE												
1.4 TFSI	Petrol	103	03/13->	CPTA								
Engine	Information				A10	A20	A40	A50	A70	C10 - C30	C20	E01
All engines	x 4, BERU, ELDOR, COIL ON PLUG, incl. spark plug connector, Number of pins:4, incl. spark plug connector									1.970.599	C10	
ENGINE												
1.4 TFSI	Petrol	85	02/16-10/20	CZCC								
Engine	Information				A10	A20	A40	A50	A70	C10 - C30	C20	E01
All engines	x 4, BERU, ELDOR, COIL ON PLUG, incl. spark plug connector, Number of pins:4, incl. spark plug connector									1.970.599	C10	
ENGINE												
1.4 TFSI	Petrol	90	04/12-10/20	CMBA, CXSA								
Engine	Information				A10	A20	A40	A50	A70	C10 - C30	C20	E01
All engines	x 4, BERU, ELDOR, COIL ON PLUG, incl. spark plug connector, Number of pins:4, incl. spark plug connector									1.970.599	C10	
Eng. CMBA	Qty: 4									1.970.599	C10	
ENGINE												
1.4 TFSI	Petrol	92	09/13->	CXSB, CZCA								
Engine	Information				A10	A20	A40	A50	A70	C10 - C30	C20	E01
All engines	x 4, BERU, ELDOR, COIL ON PLUG, incl. spark plug connector, Number of pins:4, incl. spark plug connector									1.970.599	C10	
ENGINE												
1.4 TFSI e-tron	Petrol/ Electric	110	05/14-10/20	CUKB, CXUA, DGEA								
Engine	Information				A10	A20	A40	A50	A70	C10 - C30	C20	E01
All engines	x 4, BERU, ELDOR, COIL ON PLUG, incl. spark plug connector, Number of pins:4, incl. spark plug connector									1.970.599	C10	
ENGINE												
1.4 TFSI g-tron	Petrol/ Com- pressed Natural Gas (CNG)	81	11/13-10/20	CPWA								
Engine	Information				A10	A20	A40	A50	A70	C10 - C30	C20	E01
All engines	x 4, BERU, ELDOR, COIL ON PLUG, incl. spark plug connector, Number of pins:4, incl. spark plug connector									1.970.599	C10	

A10 CONDENSER	A20 CONTACT SET	A40 DISTRIBUTOR CAP	A50 ROTOR	A70 PICK-UP
C10 COIL	C20 IGNITION MODULE	C30 ELECTRONIC IGNITION KIT	E01 IGNITION CABLE SET	

Vehicle	alim.	kW	Date	Engine	FUNCTIONS ON THE VEHICLE							
					A10	A20	A40	A50	A70	C10 - C30	C20	E01
ENGINE												
1.4 TFSI	Petrol	110	05/14-10/20	CZEA								
Engine	Information				A10	A20	A40	A50	A70	C10 - C30	C20	E01
All engines	x 4, BERU, ELDOR, HITACHI, COIL ON PLUG, incl. spark plug connector, Number of pins:4, incl. spark plug connector									1.970.599	C10	
ENGINE												
1.8 TFSI	Petrol	125	11/13-10/20	CNSB								
Engine	Information				A10	A20	A40	A50	A70	C10 - C30	C20	E01
All engines	x 4, HITACHI, COIL ON PLUG, incl. spark plug connector									1.970.636	C10	
ENGINE												
1.8 TFSI	Petrol	132	04/12->	CJSA, CJSB								
Engine	Information				A10	A20	A40	A50	A70	C10 - C30	C20	E01
All engines	x 4, HITACHI, COIL ON PLUG, incl. spark plug connector									1.970.636	C10	
ENGINE												
1.8 TFSI quattro	Petrol	132	08/12->	CJSB								
Engine	Information				A10	A20	A40	A50	A70	C10 - C30	C20	E01
All engines	x 4, HITACHI, COIL ON PLUG, incl. spark plug connector									1.970.636	C10	
ENGINE												
2.0 TFSI	Petrol	140	05/16-10/20	CZPB, DKZA								
Engine	Information				A10	A20	A40	A50	A70	C10 - C30	C20	E01
All engines	01/11/18 ->, x 4, HITACHI, x 4, COIL ON PLUG, HITACHI, COIL ON PLUG, incl. spark plug connector, incl. spark plug connector									1.970.636	C10	
ENGINE												
2.0 TFSI quattro	Petrol	140	05/16-10/20	CZPB, DKZA								
Engine	Information				A10	A20	A40	A50	A70	C10 - C30	C20	E01
All engines	01/11/18 ->, x 4, HITACHI, x 4, COIL ON PLUG, HITACHI, COIL ON PLUG, incl. spark plug connector, incl. spark plug connector									1.970.636	C10	
ENGINE												
30 TFSI	Petrol	85	07/18-10/20	CHZD, DKRF								
Engine	Information				A10	A20	A40	A50	A70	C10 - C30	C20	E01
All engines	x 3, BERU, ELDOR, COIL ON PLUG, incl. spark plug connector, Number of pins:4, incl. spark plug connector									1.970.599	C10	
ENGINE												
40 TFSI	Petrol	140	07/18-10/20	CZPB, DKZA								
Engine	Information				A10	A20	A40	A50	A70	C10 - C30	C20	E01
All engines	01/11/18 ->, x 4, HITACHI, COIL ON PLUG, incl. spark plug connector									1.970.636	C10	
ENGINE												
40 TFSI quattro	Petrol	140	07/18-10/20	CZPB, DKZA								
Engine	Information				A10	A20	A40	A50	A70	C10 - C30	C20	E01
All engines	x 4, HITACHI, x 4, COIL ON PLUG, HITACHI, COIL ON PLUG, incl. spark plug connector, incl. spark plug connector									1.970.636	C10	
ENGINE												
RS3 quattro	Petrol	270	03/15->	CZGB								
Engine	Information				A10	A20	A40	A50	A70	C10 - C30	C20	E01
All engines	RS3 Sportback Quattro, x 5, ELDOR, Housing Colour:-Black, COIL ON PLUG, incl. spark plug connector									1.970.426	C10	
ENGINE												
S3 quattro	Petrol	213	07/16-10/20	CJXD, DJHB								
Engine	Information				A10	A20	A40	A50	A70	C10 - C30	C20	E01
All engines	S3 Cabrio Quattro, S3 Quattro, S3 Sportback Quattro, x 4, HITACHI, COIL ON PLUG, incl. spark plug connector									1.970.636	C10	
ENGINE												
S3 quattro	Petrol	221	11/12-10/20	DNUE								
Engine	Information				A10	A20	A40	A50	A70	C10 - C30	C20	E01
All engines	S3 Cabrio Quattro, S3 Quattro, S3 Sportback Quattro, 01/12/19 ->, x 4, HITACHI, COIL ON PLUG, incl. spark plug connector									1.970.636	C10	
ENGINE												
S3 quattro	Petrol	228	06/16-10/20	CJXG, DJHA								
Engine	Information				A10	A20	A40	A50	A70	C10 - C30	C20	E01
All engines	S3 Cabrio Quattro, S3 Quattro, S3 Sportback Quattro, x 4, HITACHI, COIL ON PLUG, incl. spark plug connector									1.970.636	C10	









A10 CONDENSER	A20 CONTACT SET	A40 DISTRIBUTOR CAP	A50 ROTOR	A70 PICK-UP
C10 COIL	C20 IGNITION MODULE	C30 ELECTRONIC IGNITION KIT	E01 IGNITION CABLE SET	

The present application list is a brief version. For the detailed information about the possibility of installation on a specific vehicle, please refer to our web-catalogue <http://catalogo.facet.eu/>

				FUNCTIONS ON THE VEHICLE								
Vehicle	alim.	kW	Date	Engine	 A10	 A20	 A40	 A50	 A70	 C10 - C30	 C20	 E01
A3 IV												
30 TFSI	Petrol	81	06/20->	DLAA								
Engine	Information				A10	A20	A40	A50	A70	C10 - C30	C20	E01
All engines	x 3, ELDOR, COIL ON PLUG, Number of pins:4, incl. spark plug connector									1.970.599	C10	
30 TFSI Mild Hybrid												
30 TFSI Mild Hybrid	Petrol/ Electric	81	06/20->	DLAA								
Engine	Information				A10	A20	A40	A50	A70	C10 - C30	C20	E01
All engines	x 3, ELDOR, COIL ON PLUG, Number of pins:4, incl. spark plug connector									1.970.599	C10	
40 TFSIe												
40 TFSIe	Petrol/ Electric	110	06/20->	DGEA								
Engine	Information				A10	A20	A40	A50	A70	C10 - C30	C20	E01
All engines	x 4, ELDOR, COIL ON PLUG, Number of pins:4, incl. spark plug connector									1.970.599	C10	
45 TFSIe												
45 TFSIe	Petrol/ Electric	110	07/21->	DGEA								
Engine	Information				A10	A20	A40	A50	A70	C10 - C30	C20	E01
All engines	x 4, ELDOR, COIL ON PLUG, Number of pins:4, incl. spark plug connector									1.970.599	C10	
S3 quattro												
S3 quattro	Petrol	228	06/20->	DNFB								
Engine	Information				A10	A20	A40	A50	A70	C10 - C30	C20	E01
All engines	S3 Quattro, S3 Sportback Quattro, x 4, HITACHI, COIL ON PLUG, incl. spark plug connector									1.970.636	C10	
A4 I												
1.6	Petrol	74	11/94-09/01	0D6-280 I-A, ADP, AHL, ANA, ARM								
Engine	Information				A10	A20	A40	A50	A70	C10 - C30	C20	E01
Eng. ADP	version Bosch						1.306.266	1.406.121R				
Eng. ADP	version Ducellier						1.315.068	1.415.099R				
Eng. ADP								1.906.223				1.501.353
Eng. AHL, ANA, ARM										1.990.420	C30	
Eng. 0D6-280 I-A, AHL, ANA												1.501.585
1.6												
1.6	Petrol	75	07/00-09/01	ALZ								
Engine	Information				A10	A20	A40	A50	A70	C10 - C30	C20	E01
All engines										1.990.420	C30	1.501.585
1.8												
1.8	Petrol	85	04/95-09/01	AFY								
Engine	Information				A10	A20	A40	A50	A70	C10 - C30	C20	E01
All engines												1.501.491
1.8												
1.8	Petrol	92	11/94-09/01	ADR, APT, ARG, AVV								
Engine	Information				A10	A20	A40	A50	A70	C10 - C30	C20	E01
All engines												1.501.491
1.8 quattro												
1.8 quattro	Petrol	85	07/95-09/01	AFY								
Engine	Information				A10	A20	A40	A50	A70	C10 - C30	C20	E01
All engines												1.501.491
1.8 quattro												
1.8 quattro	Petrol	92	01/95-09/01	ADR, APT, ARG								
Engine	Information				A10	A20	A40	A50	A70	C10 - C30	C20	E01
All engines												1.501.491
1.8 T												
1.8 T	Petrol	110	01/95-09/01	1HN9, AEB, ANB, APU, ARK, AWT								
Engine	Information				A10	A20	A40	A50	A70	C10 - C30	C20	E01
Eng. AEB, ANB, APU, ARK	x 4, COIL ON PLUG									1.970.354S	C10	
Eng. AWT	x 4, COIL ON PLUG, incl. spark plug connector									1.970.429	C10	
Eng. 1HN9, ANB, APU, ARK	ch. 8D-V-244 484 ->											1.965.072

A10 CONDENSER	A20 CONTACT SET	A40 DISTRIBUTOR CAP	A50 ROTOR	A70 PICK-UP
C10 COIL	C20 IGNITION MODULE	C30 ELECTRONIC IGNITION KIT	E01 IGNITION CABLE SET	

Vehicle	alim.	kW	Date	Engine	FUNCTIONS ON THE VEHICLE												
					A10	A20	A40	A50	A70	C10 - C30	C20	E01					
1.8 T	Petrol	110	01/95-09/01	ENGINE 1HN9, AEB, ANB, APU, ARK, AWT													
Engine	Information				A10	A20	A40	A50	A70	C10 - C30	C20	E01					
Eng. 1HN9	->ch. 8D-V-244 483										1.965.076						
1.8 T	Petrol	132	12/97-09/01	ENGINE AJL													
Engine	Information				A10	A20	A40	A50	A70	C10 - C30	C20	E01					
All engines	x 4, COIL ON PLUG									1.970.354S	C10						
All engines											1.965.072						
1.8 T quattro	Petrol	110	01/95-09/01	ENGINE 1HN9, AEB, ANB, APU, ARK, AWT													
Engine	Information				A10	A20	A40	A50	A70	C10 - C30	C20	E01					
Eng. AEB, ANB, APU, ARK, AWT	x 4, COIL ON PLUG									1.970.354S	C10						
Eng. AWT	Qty: 4									1.970.429	C10						
Eng. 1HN9, ANB, APU, ARK	ch. 8D-V-244 484 ->										1.965.072						
Eng. 1HN9	->ch. 8D-V-244 483										1.965.076						
1.8 T quattro	Petrol	132	12/97-09/01	ENGINE AJL													
Engine	Information				A10	A20	A40	A50	A70	C10 - C30	C20	E01					
All engines	x 4, COIL ON PLUG									1.970.354S	C10						
All engines											1.965.072						
2.4	Petrol	110	07/95-07/97	ENGINE AFM													
Engine	Information				A10	A20	A40	A50	A70	C10 - C30	C20	E01					
All engines											1.965.051						
2.6	Petrol	110	01/95-09/01	ENGINE ABC													
Engine	Information				A10	A20	A40	A50	A70	C10 - C30	C20	E01					
All engines											1.965.051						
2.6 quattro	Petrol	110	01/95-09/01	ENGINE ABC													
Engine	Information				A10	A20	A40	A50	A70	C10 - C30	C20	E01					
All engines											1.965.051						
2.8	Petrol	128	09/95-07/97	ENGINE AAH													
Engine	Information				A10	A20	A40	A50	A70	C10 - C30	C20	E01					
All engines											1.965.051						
2.8 quattro	Petrol	128	01/95-07/97	ENGINE AAH													
Engine	Information				A10	A20	A40	A50	A70	C10 - C30	C20	E01					
All engines											1.965.051						
RS4 quattro	Petrol	280	05/00-09/01	ENGINE ASJ, AZR													
Engine	Information				A10	A20	A40	A50	A70	C10 - C30	C20	E01					
All engines	RS4 Quattro, x 6, COIL ON PLUG									1.970.354S	C10						
Eng. AZR												1.500.768					
S4 quattro	Petrol	195	09/97-09/01	ENGINE AGB, AZB													
Engine	Information				A10	A20	A40	A50	A70	C10 - C30	C20	E01					
All engines	S4 Quattro, x 6, COIL ON PLUG									1.970.354S	C10						
A4 II																	
1.6	Petrol	75	11/00-12/04	ENGINE ALZ													
Engine	Information				A10	A20	A40	A50	A70	C10 - C30	C20	E01					
All engines										1.990.420	C30	1.501.585					
1.8 T	Petrol	110	11/00-07/02	ENGINE AVJ													
Engine	Information				A10	A20	A40	A50	A70	C10 - C30	C20	E01					
All engines	x 4, COIL ON PLUG, incl. spark plug connector									1.970.429	C10						
All engines											1.965.076						
A10	CONDENSER	A20	CONTACT SET	A40	DISTRIBUTOR CAP	A50	ROTOR	A70	PICK-UP	C10	COIL	C20	IGNITION MODULE	C30	ELECTRONIC IGNITION KIT	E01	IGNITION CABLE SET









				FUNCTIONS ON THE VEHICLE								
Vehicle	alim.	kW	Date	Engine	 A10	 A20	 A40	 A50	 A70	 C10 - C30	 C20	 E01
				ENGINE								
1.8 T	Petrol	120	07/02-12/04	BFB								
				ENGINE								
Engine	Information				A10	A20	A40	A50	A70	C10 - C30	C20	E01
All engines	x 4, COIL ON PLUG, incl. spark plug connector									1.970.429	C10	
1.8 T	Petrol	125	07/01-12/04	AMB								
				ENGINE								
Engine	Information				A10	A20	A40	A50	A70	C10 - C30	C20	E01
All engines	x 4, COIL ON PLUG, incl. spark plug connector									1.970.429	C10	
1.8 T	Petrol	140	11/02-12/04	BEX								
				ENGINE								
Engine	Information				A10	A20	A40	A50	A70	C10 - C30	C20	E01
All engines	x 4, COIL ON PLUG, incl. spark plug connector									1.970.429	C10	
1.8 T quattro	Petrol	110	11/00-07/02	AVJ								
				ENGINE								
Engine	Information				A10	A20	A40	A50	A70	C10 - C30	C20	E01
All engines	x 4, COIL ON PLUG, incl. spark plug connector									1.970.429	C10	
All engines											1.965.076	
1.8 T quattro	Petrol	120	07/02-12/04	BFB								
				ENGINE								
Engine	Information				A10	A20	A40	A50	A70	C10 - C30	C20	E01
All engines	x 4, COIL ON PLUG, incl. spark plug connector									1.970.429	C10	
1.8 T quattro	Petrol	125	07/01-12/04	AMB								
				ENGINE								
Engine	Information				A10	A20	A40	A50	A70	C10 - C30	C20	E01
All engines	x 4, COIL ON PLUG, incl. spark plug connector									1.970.429	C10	
1.8 T quattro	Petrol	140	11/02-12/04	BEX								
				ENGINE								
Engine	Information				A10	A20	A40	A50	A70	C10 - C30	C20	E01
All engines	x 4, COIL ON PLUG, incl. spark plug connector									1.970.429	C10	
2.0	Petrol	96	11/00-12/04	ALT								
				ENGINE								
Engine	Information				A10	A20	A40	A50	A70	C10 - C30	C20	E01
All engines	x 4, Colour:Red, COIL ON PLUG, incl. spark plug connector									1.970.436	C10	
2.0 FSI	Petrol	110	07/02-12/04	AWA								
				ENGINE								
Engine	Information				A10	A20	A40	A50	A70	C10 - C30	C20	E01
All engines	x 4, Colour:Red, COIL ON PLUG, incl. spark plug connector									1.970.427	C10	
3.0	Petrol	160	04/01-12/04	BBJ								
				ENGINE								
Engine	Information				A10	A20	A40	A50	A70	C10 - C30	C20	E01
All engines	x 6, Colour:Red, COIL ON PLUG, incl. spark plug connector									1.970.436	C10	
3.0	Petrol	162	11/00-12/04	ASN, AVK								
				ENGINE								
Engine	Information				A10	A20	A40	A50	A70	C10 - C30	C20	E01
Eng. ASN	x 6, Colour:Red, COIL ON PLUG, incl. spark plug connector									1.970.436	C10	
Eng. AVK	Qty: 6									1.970.436	C10	
3.0 quattro	Petrol	160	04/01-12/04	BBJ								
				ENGINE								
Engine	Information				A10	A20	A40	A50	A70	C10 - C30	C20	E01
All engines	x 6, Colour:Red, COIL ON PLUG, incl. spark plug connector									1.970.436	C10	
3.0 quattro	Petrol	162	11/00-12/04	ASN, AVK								
				ENGINE								
Engine	Information				A10	A20	A40	A50	A70	C10 - C30	C20	E01
All engines	x 6, Colour:Red, COIL ON PLUG, incl. spark plug connector									1.970.436	C10	
Eng. AVK	Qty: 6									1.970.436	C10	
S4 quattro	Petrol	253	03/03-12/04	BBK								
				ENGINE								
Engine	Information				A10	A20	A40	A50	A70	C10 - C30	C20	E01
All engines	S4 Quattro, x 8, Colour:Red, COIL ON PLUG, incl. spark plug connector									1.970.433	C10	

A10 CONDENSER	A20 CONTACT SET	A40 DISTRIBUTOR CAP	A50 ROTOR	A70 PICK-UP
C10 COIL	C20 IGNITION MODULE	C30 ELECTRONIC IGNITION KIT	E01 IGNITION CABLE SET	

Vehicle	alim.	kW	Date	Engine	FUNCTIONS ON THE VEHICLE							
					A10	A20	A40	A50	A70	C10 - C30	C20	E01
A4 III												
1.6	Petrol	75	11/04-06/08	ALZ								
ENGINE												
Engine	Information				A10	A20	A40	A50	A70	C10 - C30	C20	E01
All engines										1.990.420	C30	1.501.585
1.8 T	Petrol	120	07/02-03/09	BFB								
ENGINE												
Engine	Information				A10	A20	A40	A50	A70	C10 - C30	C20	E01
All engines	x 4, COIL ON PLUG, incl. spark plug connector									1.970.429	C10	
1.8 T quattro	Petrol	120	05/03-06/08	BFB								
ENGINE												
Engine	Information				A10	A20	A40	A50	A70	C10 - C30	C20	E01
All engines	x 4, COIL ON PLUG, incl. spark plug connector									1.970.429	C10	
2.0	Petrol	96	09/04-06/08	ALT								
ENGINE												
Engine	Information				A10	A20	A40	A50	A70	C10 - C30	C20	E01
All engines	x 4, COIL ON PLUG, incl. spark plug connector									1.970.429	C10	
All engines	x 4, Colour:Red, COIL ON PLUG, incl. spark plug connector									1.970.436	C10	
2.0 TFSI	Petrol	125	10/06-06/08	BPJ, BYK								
ENGINE												
Engine	Information				A10	A20	A40	A50	A70	C10 - C30	C20	E01
Eng. BPJ	x 4, ELDOR, Housing Colour:Black, COIL ON PLUG, incl. spark plug connector									1.970.426	C10	
Eng. BYK	Qty: 4									1.970.426	C10	
2.0 TFSI	Petrol	147	11/04-06/08	BGB, BPG, BWE, BWT								
ENGINE												
Engine	Information				A10	A20	A40	A50	A70	C10 - C30	C20	E01
All engines	x 4, ELDOR, Housing Colour:Black, COIL ON PLUG, incl. spark plug connector									1.970.426	C10	
2.0 TFSI	Petrol	162	06/05-06/08	BUL								
ENGINE												
Engine	Information				A10	A20	A40	A50	A70	C10 - C30	C20	E01
All engines	x 4, ELDOR, Housing Colour:Black, COIL ON PLUG, incl. spark plug connector									1.970.426	C10	
2.0 TFSI 16V	Petrol	147	01/06-03/09	BWE, BWT								
ENGINE												
Engine	Information				A10	A20	A40	A50	A70	C10 - C30	C20	E01
All engines	x 4, ELDOR, Housing Colour:Black, COIL ON PLUG, incl. spark plug connector									1.970.426	C10	
2.0 TFSI quattro	Petrol	147	11/04-03/09	BGB, BWE, BWT								
ENGINE												
Engine	Information				A10	A20	A40	A50	A70	C10 - C30	C20	E01
All engines	x 4, ELDOR, Housing Colour:Black, COIL ON PLUG, incl. spark plug connector									1.970.426	C10	
Eng. BWT	Qty: 4									1.970.426	C10	
2.0 TFSI quattro	Petrol	162	06/05-06/08	BUL								
ENGINE												
Engine	Information				A10	A20	A40	A50	A70	C10 - C30	C20	E01
All engines	x 4, ELDOR, Housing Colour:Black, COIL ON PLUG, incl. spark plug connector									1.970.426	C10	
3.0	Petrol	160	04/02-05/06	BBJ								
ENGINE												
Engine	Information				A10	A20	A40	A50	A70	C10 - C30	C20	E01
All engines	x 6, Colour:Red, COIL ON PLUG, incl. spark plug connector									1.970.436	C10	
3.0	Petrol	162	04/02-12/05	ASN								
ENGINE												
Engine	Information				A10	A20	A40	A50	A70	C10 - C30	C20	E01
All engines	x 6, Colour:Red, COIL ON PLUG, incl. spark plug connector									1.970.436	C10	
3.0 quattro	Petrol	160	11/04-07/06	BBJ								
ENGINE												
Engine	Information				A10	A20	A40	A50	A70	C10 - C30	C20	E01
All engines	x 6, Colour:Red, COIL ON PLUG, incl. spark plug connector									1.970.436	C10	

A10 CONDENSER	A20 CONTACT SET	A40 DISTRIBUTOR CAP	A50 ROTOR	A70 PICK-UP
C10 COIL	C20 IGNITION MODULE	C30 ELECTRONIC IGNITION KIT	E01 IGNITION CABLE SET	

The present application list is a brief version. For the detailed information about the possibility of installation on a specific vehicle, please refer to our web-catalogue <http://catalogo.facet.eu/>









				FUNCTIONS ON THE VEHICLE								
Vehicle	alim.	kW	Date	Engine								
				ENGINE								
3.0 quattro	Petrol	162	05/03-12/05	ASN								
Engine	Information				A10	A20	A40	A50	A70	C10 - C30	C20	E01
All engines	x 6, Colour:Red, COIL ON PLUG, incl. spark plug connector									1.970.436	C10	
				ENGINE								
3.2 FSI	Petrol	188	01/05-03/09	AUK								
Engine	Information				A10	A20	A40	A50	A70	C10 - C30	C20	E01
All engines	x 6, Colour:Red, COIL ON PLUG, incl. spark plug connector									1.970.427	C10	
				ENGINE								
3.2 FSI quattro	Petrol	188	01/05-03/09	AUK, BKH								
Engine	Information				A10	A20	A40	A50	A70	C10 - C30	C20	E01
Eng. AUK	x 6, Colour:Red, COIL ON PLUG, incl. spark plug connector									1.970.427	C10	
Eng. BKH	Qty: 6									1.970.427	C10	
				ENGINE								
RS4 quattro	Petrol	309	09/05-12/08	BNS								
Engine	Information				A10	A20	A40	A50	A70	C10 - C30	C20	E01
All engines	RS4 Cabrio Quattro, RS4 Quattro, x 8, ELDOR, Housing Colour:Black, COIL ON PLUG, incl. spark plug connector									1.970.426	C10	
				ENGINE								
S4 quattro	Petrol	253	03/04-03/09	BBK, BHF								
Engine	Information				A10	A20	A40	A50	A70	C10 - C30	C20	E01
All engines	S4 Cabrio Quattro, S4 Quattro, x 8, Colour:Red, x 8, COIL ON PLUG, Colour:Red, COIL ON PLUG, incl. spark plug connector, incl. spark plug connector									1.970.433	C10	
				ENGINE								
A4 IV				ENGINE								
1.8 TFSI	Petrol	118	11/07-03/12	CABB, CDHB								
Engine	Information				A10	A20	A40	A50	A70	C10 - C30	C20	E01
All engines	x 4, ELDOR, Housing Colour:Black, COIL ON PLUG, incl. spark plug connector									1.970.426	C10	
				ENGINE								
1.8 TFSI	Petrol	125	11/11-12/15	CJEB								
Engine	Information				A10	A20	A40	A50	A70	C10 - C30	C20	E01
All engines	x 4, ELDOR, Colour:Black, COIL ON PLUG									1.970.636	C10	
				ENGINE								
1.8 TFSI	Petrol	88	01/08-12/15	CABA, CDHA								
Engine	Information				A10	A20	A40	A50	A70	C10 - C30	C20	E01
All engines	x 4, ELDOR, Housing Colour:Black, COIL ON PLUG, incl. spark plug connector									1.970.426	C10	
				ENGINE								
1.8 TFSI quattro	Petrol	118	09/08-03/12	CDHB								
Engine	Information				A10	A20	A40	A50	A70	C10 - C30	C20	E01
All engines	x 4, ELDOR, Housing Colour:Black, COIL ON PLUG, incl. spark plug connector									1.970.426	C10	
				ENGINE								
1.8 TFSI quattro	Petrol	125	11/11-12/15	CJEB								
Engine	Information				A10	A20	A40	A50	A70	C10 - C30	C20	E01
All engines	x 4, ELDOR, Colour:Black, COIL ON PLUG									1.970.636	C10	
				ENGINE								
2.0 TFSI	Petrol	132	06/08-12/15	CAEA, CDNB, CFKA								
Engine	Information				A10	A20	A40	A50	A70	C10 - C30	C20	E01
Eng. CAEA	Qty: 4									1.970.426	C10	
Eng. CDNB, CFKA	x 4, ELDOR, Housing Colour:Black, COIL ON PLUG, incl. spark plug connector									1.970.426	C10	
				ENGINE								
2.0 TFSI	Petrol	155	06/08-05/13	CAEB, CDNC								
Engine	Information				A10	A20	A40	A50	A70	C10 - C30	C20	E01
All engines	x 4, ELDOR, Housing Colour:Black, COIL ON PLUG, incl. spark plug connector									1.970.426	C10	
Eng. CAEB	Qty: 4									1.970.426	C10	
				ENGINE								
2.0 TFSI	Petrol	162	05/13-12/15	CAED								
Engine	Information				A10	A20	A40	A50	A70	C10 - C30	C20	E01
All engines	Qty: 4									1.970.426	C10	
All engines	x 4, ELDOR, Housing Colour:Black, COIL ON PLUG, incl. spark plug connector									1.970.426	C10	

A10 CONDENSER	A20 CONTACT SET	A40 DISTRIBUTOR CAP	A50 ROTOR	A70 PICK-UP
C10 COIL	C20 IGNITION MODULE	C30 ELECTRONIC IGNITION KIT	E01 IGNITION CABLE SET	

Vehicle	alim.	kW	Date	Engine	FUNCTIONS ON THE VEHICLE							
					A10	A20	A40	A50	A70	C10 - C30	C20	E01
ENGINE												
2.0 TFSI	Petrol	165	05/13-12/15	CNCD								
Engine	Information				A10	A20	A40	A50	A70	C10 - C30	C20	E01
All engines	->year 01/05/15, x4, HITACHI, COIL ON PLUG, incl. spark plug connector									1.970.636	C10	
ENGINE												
2.0 TFSI flexible fuel	Petrol/ Ethanol	132	11/09-12/15	CFKA								
Engine	Information				A10	A20	A40	A50	A70	C10 - C30	C20	E01
All engines	x 4, ELDOR, Housing Colour:Black, COIL ON PLUG, incl. spark plug connector									1.970.426	C10	
ENGINE												
2.0 TFSI flexible fuel quattro	Petrol/ Ethanol	132	11/09-12/15	CFKA								
Engine	Information				A10	A20	A40	A50	A70	C10 - C30	C20	E01
All engines	x 4, ELDOR, Housing Colour:Black, COIL ON PLUG, incl. spark plug connector									1.970.426	C10	
ENGINE												
2.0 TFSI quattro	Petrol	132	11/09-03/12	CFKA								
Engine	Information				A10	A20	A40	A50	A70	C10 - C30	C20	E01
All engines	x 4, ELDOR, Housing Colour:Black, COIL ON PLUG, incl. spark plug connector									1.970.426	C10	
ENGINE												
2.0 TFSI quattro	Petrol	155	06/08-12/15	CAEB, CDNC, CPMA								
Engine	Information				A10	A20	A40	A50	A70	C10 - C30	C20	E01
All engines	x 4, ELDOR, Housing Colour:Black, COIL ON PLUG, incl. spark plug connector									1.970.426	C10	
Eng. CAEB	Qty: 4									1.970.426	C10	
ENGINE												
2.0 TFSI quattro	Petrol	162	05/13-12/15	CAED, CPMB								
Engine	Information				A10	A20	A40	A50	A70	C10 - C30	C20	E01
All engines	x 4, ELDOR, Housing Colour:Black, COIL ON PLUG, incl. spark plug connector									1.970.426	C10	
ENGINE												
2.0 TFSI quattro	Petrol	165	05/13-12/15	CNCD								
Engine	Information				A10	A20	A40	A50	A70	C10 - C30	C20	E01
All engines	->year 01/05/15, x4, HITACHI, COIL ON PLUG, incl. spark plug connector									1.970.636	C10	
ENGINE												
3.0 TFSI quattro	Petrol	200	02/12-12/15	CMUA, CRED								
Engine	Information				A10	A20	A40	A50	A70	C10 - C30	C20	E01
All engines	x 6, Colour:Red, COIL ON PLUG, incl. spark plug connector									1.970.427	C10	
ENGINE												
3.2 FSI	Petrol	195	09/08-03/12	CALA								
Engine	Information				A10	A20	A40	A50	A70	C10 - C30	C20	E01
All engines	x 6, Colour:Red, COIL ON PLUG, incl. spark plug connector									1.970.427	C10	
ENGINE												
3.2 FSI quattro	Petrol	195	11/07-03/12	CALA								
Engine	Information				A10	A20	A40	A50	A70	C10 - C30	C20	E01
All engines	x 6, Colour:Red, COIL ON PLUG, incl. spark plug connector									1.970.427	C10	
ENGINE												
RS4 quattro	Petrol	331	05/12-08/15	CFSA								
Engine	Information				A10	A20	A40	A50	A70	C10 - C30	C20	E01
All engines	RS4 Quattro, x8, ELDOR, Housing Colour:Black, COIL ON PLUG, incl. spark plug connector									1.970.426	C10	
ENGINE												
S4 quattro	Petrol	245	11/08-12/15	CAKA, CCBA, CGWC, CGXC, CREC, CTUB								
Engine	Information				A10	A20	A40	A50	A70	C10 - C30	C20	E01
All engines	S4 Quattro, x 6, Colour:Red, COIL ON PLUG, incl. spark plug connector									1.970.427	C10	
A4 IV ALLROAD												
ENGINE												
2.0 TFSI quattro	Petrol	155	04/09-05/16	CDNC, CPMA								
Engine	Information				A10	A20	A40	A50	A70	C10 - C30	C20	E01
All engines	x 4, ELDOR, Housing Colour:Black, COIL ON PLUG, incl. spark plug connector									1.970.426	C10	

A10	CONDENSER	A20	CONTACT SET	A40	DISTRIBUTOR CAP	A50	ROTOR	A70	PICK-UP
C10	COIL	C20	IGNITION MODULE	C30	ELECTRONIC IGNITION KIT	E01	IGNITION CABLE SET		

The present application list is a brief version. For the detailed information about the possibility of installation on a specific vehicle, please refer to our web-catalogue <http://catalogo.facet.eu/>









					FUNCTIONS ON THE VEHICLE							
Vehicle	alim.	kW	Date	Engine								
ENGINE												
2.0 TFSI quattro	Petrol	162	05/13-05/16	CPMB								
Engine	Information				A10	A20	A40	A50	A70	C10 - C30	C20	E01
All engines	x 4, ELDOR, Housing Colour:Black, COIL ON PLUG, incl. spark plug connector									1.970.426	C10	
ENGINE												
2.0 TFSI quattro	Petrol	165	05/13-05/16	CNCD								
Engine	Information				A10	A20	A40	A50	A70	C10 - C30	C20	E01
All engines	->year 01/05/15, x 4, HITACHI, COIL ON PLUG, incl. spark plug connector									1.970.636	C10	
A4 V												
ENGINE												
1.4 TFSI	Petrol	110	08/15-11/19	CVNA								
Engine	Information				A10	A20	A40	A50	A70	C10 - C30	C20	E01
All engines	x 4, BERU, ELDOR, COIL ON PLUG, incl. spark plug connector, Number of pins:4, incl. spark plug connector									1.970.599	C10	
ENGINE												
2.0 TFSI	Petrol	183	11/15-11/19	CYRC								
Engine	Information				A10	A20	A40	A50	A70	C10 - C30	C20	E01
All engines	x 4, HITACHI, COIL ON PLUG, incl. spark plug connector									1.970.636	C10	
ENGINE												
2.0 TFSI	Petrol	185	05/15-11/19	CYMC, CYRB								
Engine	Information				A10	A20	A40	A50	A70	C10 - C30	C20	E01
All engines	x 4, HITACHI, COIL ON PLUG, incl. spark plug connector									1.970.636	C10	
ENGINE												
2.0 TFSI Mild Hybrid	Petrol/ Electric	185	05/17-11/19	DDWA								
Engine	Information				A10	A20	A40	A50	A70	C10 - C30	C20	E01
All engines	x 4, HITACHI, COIL ON PLUG, incl. spark plug connector									1.970.636	C10	
ENGINE												
2.0 TFSI Mild Hybrid quattro	Petrol/ Electric	185	05/17->	DDWA								
Engine	Information				A10	A20	A40	A50	A70	C10 - C30	C20	E01
All engines	x 4, HITACHI, COIL ON PLUG, incl. spark plug connector									1.970.636	C10	
ENGINE												
2.0 TFSI quattro	Petrol	183	11/15-11/19	CYRC								
Engine	Information				A10	A20	A40	A50	A70	C10 - C30	C20	E01
All engines	x 4, HITACHI, COIL ON PLUG, incl. spark plug connector									1.970.636	C10	
ENGINE												
2.0 TFSI quattro	Petrol	185	05/15->	CYMC, CYRB								
Engine	Information				A10	A20	A40	A50	A70	C10 - C30	C20	E01
All engines	x 4, HITACHI, COIL ON PLUG, incl. spark plug connector									1.970.636	C10	
ENGINE												
35 TFSI Mild Hybrid	Petrol/ Electric	110	12/18->	DLVB, DMSB								
Engine	Information				A10	A20	A40	A50	A70	C10 - C30	C20	E01
All engines	x 4, HITACHI, COIL ON PLUG, incl. spark plug connector									1.970.636	C10	
ENGINE												
40 TFSI Mild Hybrid	Petrol/ Electric	150	06/20->	DMSA								
Engine	Information				A10	A20	A40	A50	A70	C10 - C30	C20	E01
All engines	x 4, HITACHI, COIL ON PLUG, incl. spark plug connector									1.970.636	C10	
ENGINE												
40 TFSI Mild Hybrid quattro	Petrol/ Electric	150	06/20->	DMSA								
Engine	Information				A10	A20	A40	A50	A70	C10 - C30	C20	E01
All engines	x 4, HITACHI, COIL ON PLUG, incl. spark plug connector									1.970.636	C10	
ENGINE												
45 TFSI Mild Hybrid	Petrol/ Electric	180	07/18-11/19	DKNA								
Engine	Information				A10	A20	A40	A50	A70	C10 - C30	C20	E01
All engines	x 4, HITACHI, COIL ON PLUG, incl. spark plug connector									1.970.636	C10	

A10 CONDENSER	A20 CONTACT SET	A40 DISTRIBUTOR CAP	A50 ROTOR	A70 PICK-UP
C10 COIL	C20 IGNITION MODULE	C30 ELECTRONIC IGNITION KIT	E01 IGNITION CABLE SET	

Vehicle	alim.	kW	Date	Engine	FUNCTIONS ON THE VEHICLE							
					A10	A20	A40	A50	A70	C10 - C30	C20	E01
ENGINE												
45 TFSI Mild Hybrid quattro	Petrol/ Electric	180	07/18-11/19	DKNA								
Engine	Information			A10	A20	A40	A50	A70	C10 - C30	C20	E01	
All engines	x 4, HITACHI, COIL ON PLUG, incl. spark plug connector								1.970.636	C10		
ENGINE												
45 TFSI Mild Hybrid quattro	Petrol/ Electric	195	08/20->	DMTA								
Engine	Information			A10	A20	A40	A50	A70	C10 - C30	C20	E01	
All engines	x 4, HITACHI, COIL ON PLUG, incl. spark plug connector								1.970.636	C10		
A4 V ALLROAD												
ENGINE												
2.0 TFSI Mild Hybrid quattro	Petrol/ Electric	185	11/18-10/19	DDWA								
Engine	Information			A10	A20	A40	A50	A70	C10 - C30	C20	E01	
All engines	x 4, HITACHI, COIL ON PLUG, incl. spark plug connector								1.970.636	C10		
ENGINE												
2.0 TFSI quattro	Petrol	183	05/16-10/19	CYRC								
Engine	Information			A10	A20	A40	A50	A70	C10 - C30	C20	E01	
All engines	x 4, HITACHI, COIL ON PLUG, incl. spark plug connector								1.970.636	C10		
ENGINE												
2.0 TFSI quattro	Petrol	185	01/16->	CYMC, CYRB								
Engine	Information			A10	A20	A40	A50	A70	C10 - C30	C20	E01	
All engines	x 4, HITACHI, COIL ON PLUG, incl. spark plug connector								1.970.636	C10		
ENGINE												
45 TFSI Mild Hybrid quattro	Petrol/ Electric	180	07/18->	DKNA								
Engine	Information			A10	A20	A40	A50	A70	C10 - C30	C20	E01	
All engines	x 4, HITACHI, COIL ON PLUG, incl. spark plug connector								1.970.636	C10		
ENGINE												
45 TFSI Mild Hybrid quattro	Petrol/ Electric	195	08/20->	DMTA								
Engine	Information			A10	A20	A40	A50	A70	C10 - C30	C20	E01	
All engines	x 4, HITACHI, COIL ON PLUG, incl. spark plug connector								1.970.636	C10		
A5 I												
ENGINE												
1.8 TFSI	Petrol	106	09/14-01/17	CJED								
Engine	Information			A10	A20	A40	A50	A70	C10 - C30	C20	E01	
All engines	->year 01/03/15, x 4, Colour:Black, COIL ON PLUG, incl. spark plug connector								1.970.636	C10		
ENGINE												
1.8 TFSI	Petrol	118	05/09-03/12	CDHB								
Engine	Information			A10	A20	A40	A50	A70	C10 - C30	C20	E01	
All engines	x 4, ELDOR, Housing Colour:Black, COIL ON PLUG, incl. spark plug connector								1.970.426	C10		
ENGINE												
1.8 TFSI	Petrol	125	10/07-01/17	CABD, CJEB								
Engine	Information			A10	A20	A40	A50	A70	C10 - C30	C20	E01	
Eng. CABD	Qty: 4								1.970.426	C10		
Eng. CABD	x 4, ELDOR, Housing Colour:Black, COIL ON PLUG, incl. spark plug connector								1.970.426	C10		
Eng. CJEB	->year 01/04/15, x 4, ELDOR, x 4, Colour:Black, ELDOR, x 4, COIL ON PLUG, Colour:Black, COIL ON PLUG, incl. spark plug connector, incl. spark plug connector								1.970.636	C10		
ENGINE												
1.8 TFSI	Petrol	130	05/15-01/17	CJEE								
Engine	Information			A10	A20	A40	A50	A70	C10 - C30	C20	E01	
All engines	->year 01/05/15, x 4, Colour:Black, COIL ON PLUG, incl. spark plug connector								1.970.636	C10		
ENGINE												
2.0 TFSI	Petrol	132	11/08-06/14	CAEA, CDNB								
Engine	Information			A10	A20	A40	A50	A70	C10 - C30	C20	E01	
All engines	x 4, ELDOR, Housing Colour:Black, COIL ON PLUG, incl. spark plug connector								1.970.426	C10		

A10 CONDENSER	A20 CONTACT SET	A40 DISTRIBUTOR CAP	A50 ROTOR	A70 PICK-UP
C10 COIL	C20 IGNITION MODULE	C30 ELECTRONIC IGNITION KIT	E01 IGNITION CABLE SET	

The present application list is a brief version. For the detailed information about the possibility of installation on a specific vehicle, please refer to our web-catalogue <http://catalogo.facet.eu/>

				FUNCTIONS ON THE VEHICLE								
Vehicle	alim.	kW	Date	Engine								
				ENGINE								
2.0 TFSI	Petrol	155	06/08-06/14	CAEB, CDNC								
Engine	Information			A10	A20	A40	A50	A70	C10 - C30	C20	E01	
All engines	x 4, ELDOR, Housing Colour:Black, COIL ON PLUG, incl. spark plug connector								1.970.426	C10		
				ENGINE								
2.0 TFSI	Petrol	162	05/13-12/14	CAED								
Engine	Information			A10	A20	A40	A50	A70	C10 - C30	C20	E01	
All engines	x 4, ELDOR, Housing Colour:Black, COIL ON PLUG, incl. spark plug connector								1.970.426	C10		
				ENGINE								
2.0 TFSI	Petrol	165	05/13-05/16	CNCD								
Engine	Information			A10	A20	A40	A50	A70	C10 - C30	C20	E01	
All engines	->year 01/05/15, x 4, HITACHI, COIL ON PLUG, incl. spark plug connector								1.970.636	C10		
				ENGINE								
2.0 TFSI quattro	Petrol	155	06/08-01/17	CAEB, CDNC, CPMA								
Engine	Information			A10	A20	A40	A50	A70	C10 - C30	C20	E01	
All engines	x 4, ELDOR, Housing Colour:Black, COIL ON PLUG, incl. spark plug connector								1.970.426	C10		
Eng. CAEB	Qty: 4								1.970.426	C10		
				ENGINE								
2.0 TFSI quattro	Petrol	162	03/12-01/17	CAED, CPMB								
Engine	Information			A10	A20	A40	A50	A70	C10 - C30	C20	E01	
All engines	x 4, ELDOR, Housing Colour:Black, COIL ON PLUG, incl. spark plug connector								1.970.426	C10		
Eng. CPMB	Qty: 4								1.970.426	C10		
				ENGINE								
2.0 TFSI quattro	Petrol	165	05/13-05/16	CNCD								
Engine	Information			A10	A20	A40	A50	A70	C10 - C30	C20	E01	
All engines	->year 01/05/15, x 4, HITACHI, COIL ON PLUG, incl. spark plug connector								1.970.636	C10		
				ENGINE								
3.0 TFSI quattro	Petrol	200	08/11->	CHMB, CMUA, CRED								
Engine	Information			A10	A20	A40	A50	A70	C10 - C30	C20	E01	
All engines	x 6, Colour:Red, COIL ON PLUG, incl. spark plug connector								1.970.427	C10		
Eng. CHMB	Qty: 6								1.970.427	C10		
				ENGINE								
3.2 FSI	Petrol	195	06/07-03/12	CALA								
Engine	Information			A10	A20	A40	A50	A70	C10 - C30	C20	E01	
All engines	x 6, Colour:Red, COIL ON PLUG, incl. spark plug connector								1.970.427	C10		
				ENGINE								
3.2 FSI quattro	Petrol	195	06/07-03/12	CALA								
Engine	Information			A10	A20	A40	A50	A70	C10 - C30	C20	E01	
All engines	x 6, Colour:Red, COIL ON PLUG, incl. spark plug connector								1.970.427	C10		
				ENGINE								
RS5 quattro	Petrol	331	03/10-01/17	CFSA								
Engine	Information			A10	A20	A40	A50	A70	C10 - C30	C20	E01	
All engines	RS5 Cabrio Quattro, RS5 Quattro, x 8, ELDOR, Housing Colour:Black, COIL ON PLUG, incl. spark plug connector								1.970.426	C10		
				ENGINE								
S5 quattro	Petrol	245	06/09-01/17	CAKA, CCBA, CGWC, CGXC, CREC, CTDA, CTUB								
Engine	Information			A10	A20	A40	A50	A70	C10 - C30	C20	E01	
All engines	S5 Cabrio Quattro, S5 Quattro, S5 Sportback Quattro, x 6, Colour:Red, COIL ON PLUG, incl. spark plug connector								1.970.427	C10		
Eng. CGXC, CTUB	Qty: 6								1.970.427	C10		
				ENGINE								
S5 quattro	Petrol	260	06/07-03/12	CAUA								
Engine	Information			A10	A20	A40	A50	A70	C10 - C30	C20	E01	
All engines	S5 Quattro, x 8, Colour:Red, COIL ON PLUG, incl. spark plug connector								1.970.427	C10		
				A5 II								
				ENGINE								
1.4 TFSI	Petrol	110	11/16-02/20	CVNA								
Engine	Information			A10	A20	A40	A50	A70	C10 - C30	C20	E01	
All engines	x 4, HITACHI, COIL ON PLUG, incl. spark plug connector								1.970.599	C10		
				A10 CONDENSER								
				A20 CONTACT SET								
				A40 DISTRIBUTOR CAP								
				A50 ROTOR								
				A70 PICK-UP								
				C10 COIL								
				C20 IGNITION MODULE								
				C30 ELECTRONIC IGNITION KIT								
				E01 IGNITION CABLE SET								

Vehicle	alim.	kW	Date	Engine	FUNCTIONS ON THE VEHICLE									
					A10	A20	A40	A50	A70	C10 - C30	C20	E01		
ENGINE														
2.0 TFSI	Petrol	185	11/16-02/20	CYRB										
Engine	Information				A10	A20	A40	A50	A70	C10 - C30	C20	E01		
All engines	x 4, HITACHI, COIL ON PLUG, incl. spark plug connector									1.970.636	C10			
ENGINE														
2.0 TFSI Mild Hybrid	Petrol/ Electric	185	05/17-02/20	DDWA										
Engine	Information				A10	A20	A40	A50	A70	C10 - C30	C20	E01		
All engines	x 4, HITACHI, COIL ON PLUG, incl. spark plug connector									1.970.636	C10			
ENGINE														
2.0 TFSI Mild Hybrid quattro	Petrol/ Electric	185	05/17->	DDWA, DLHB										
Engine	Information				A10	A20	A40	A50	A70	C10 - C30	C20	E01		
All engines	x 4, HITACHI, COIL ON PLUG, incl. spark plug connector									1.970.636	C10			
ENGINE														
2.0 TFSI quattro	Petrol	183	06/16-02/20	CYRC										
Engine	Information				A10	A20	A40	A50	A70	C10 - C30	C20	E01		
All engines	x 4, HITACHI, COIL ON PLUG, incl. spark plug connector									1.970.636	C10			
ENGINE														
2.0 TFSI quattro	Petrol	185	06/16->	CYMC, CYRB										
Engine	Information				A10	A20	A40	A50	A70	C10 - C30	C20	E01		
All engines	x 4, HITACHI, COIL ON PLUG, incl. spark plug connector									1.970.636	C10			
ENGINE														
35 TFSI Mild Hybrid	Petrol/ Electric	110	08/18->	DLVB, DMSB										
Engine	Information				A10	A20	A40	A50	A70	C10 - C30	C20	E01		
All engines	x 4, HITACHI, COIL ON PLUG, incl. spark plug connector									1.970.636	C10			
ENGINE														
40 TFSI Mild Hybrid	Petrol/ Electric	150	05/20->	DMSA										
Engine	Information				A10	A20	A40	A50	A70	C10 - C30	C20	E01		
All engines	x 4, HITACHI, COIL ON PLUG, incl. spark plug connector									1.970.636	C10			
ENGINE														
40 TFSI Mild Hybrid quattro	Petrol/ Electric	150	06/20->	DMSA										
Engine	Information				A10	A20	A40	A50	A70	C10 - C30	C20	E01		
All engines	x 4, HITACHI, COIL ON PLUG, incl. spark plug connector									1.970.636	C10			
ENGINE														
45 TFSI Mild Hybrid	Petrol/ Electric	180	07/18-02/20	DKNA										
Engine	Information				A10	A20	A40	A50	A70	C10 - C30	C20	E01		
All engines	x 4, HITACHI, COIL ON PLUG, incl. spark plug connector									1.970.636	C10			
ENGINE														
45 TFSI Mild Hybrid quattro	Petrol/ Electric	180	07/18-02/20	DKNA										
Engine	Information				A10	A20	A40	A50	A70	C10 - C30	C20	E01		
All engines	x 4, HITACHI, COIL ON PLUG, incl. spark plug connector									1.970.636	C10			
ENGINE														
45 TFSI Mild Hybrid quattro	Petrol/ Electric	195	10/19->	DMTA, DPAA										
Engine	Information				A10	A20	A40	A50	A70	C10 - C30	C20	E01		
All engines	x 4, HITACHI, COIL ON PLUG, incl. spark plug connector									1.970.636	C10			
A6 I														
ENGINE														
1.8 quattro	Petrol	92	12/95-12/97	ADR										
Engine	Information				A10	A20	A40	A50	A70	C10 - C30	C20	E01		
All engines													1.501.491	
ENGINE														
2.0	Petrol	74	06/94-12/97	AAE										
Engine	Information				A10	A20	A40	A50	A70	C10 - C30	C20	E01		
All engines	version Bosch						1.306.266	1.406.121R						
All engines													1.500.768	

A10 CONDENSER	A20 CONTACT SET	A40 DISTRIBUTOR CAP	A50 ROTOR	A70 PICK-UP
C10 COIL	C20 IGNITION MODULE	C30 ELECTRONIC IGNITION KIT	E01 IGNITION CABLE SET	









The present application list is a brief version. For the detailed information about the possibility of installation on a specific vehicle, please refer to our web-catalogue <http://catalogo.facet.eu/>

Vehicle	alim.	kW	Date	Engine	FUNCTIONS ON THE VEHICLE										
					A10	A20	A40	A50	A70	C10 - C30	C20	E01			
ENGINE															
2.0	Petrol	79	06/94-07/96	ADW											
ENGINE															
Engine	Information				A10	A20	A40	A50	A70	C10 - C30	C20	E01			
All engines	version Bosch						1.306.266	1.406.121R							
All engines													1.500.768		
ENGINE															
2.0	Petrol	85	06/94-12/97	ABK											
ENGINE															
Engine	Information				A10	A20	A40	A50	A70	C10 - C30	C20	E01			
All engines	version Bosch						1.306.266	1.406.121R							
All engines													1.500.768		
ENGINE															
2.0 16V	Petrol	103	06/94-12/97	ACE											
ENGINE															
Engine	Information				A10	A20	A40	A50	A70	C10 - C30	C20	E01			
All engines	version Bosch						1.306.248								
All engines													1.501.356		
ENGINE															
2.0 16V quattro	Petrol	103	06/94-12/97	ACE											
ENGINE															
Engine	Information				A10	A20	A40	A50	A70	C10 - C30	C20	E01			
All engines	version Bosch						1.306.248								
All engines													1.501.356		
ENGINE															
2.3	Petrol	98	06/94-12/95	7M15A-FKS											
ENGINE															
Engine	Information				A10	A20	A40	A50	A70	C10 - C30	C20	E01			
All engines	version Bosch						1.306.231	1.406.121R							
All engines	ch. 4A-T-000 001 ->												1.501.682		
ENGINE															
2.3 quattro	Petrol	98	06/94-12/95	7M15A-FKS											
ENGINE															
Engine	Information				A10	A20	A40	A50	A70	C10 - C30	C20	E01			
All engines	version Bosch						1.306.231	1.406.121R							
ENGINE															
2.4	Petrol	110	07/95-12/97	AFM											
ENGINE															
Engine	Information				A10	A20	A40	A50	A70	C10 - C30	C20	E01			
All engines											1.965.051				
ENGINE															
2.6	Petrol	102	06/94-10/97	ACZ											
ENGINE															
Engine	Information				A10	A20	A40	A50	A70	C10 - C30	C20	E01			
All engines											1.965.051				
ENGINE															
2.6	Petrol	110	06/94-12/97	ABC											
ENGINE															
Engine	Information				A10	A20	A40	A50	A70	C10 - C30	C20	E01			
All engines											1.965.051				
ENGINE															
2.6 quattro	Petrol	102	06/94-04/97	ACZ											
ENGINE															
Engine	Information				A10	A20	A40	A50	A70	C10 - C30	C20	E01			
All engines											1.965.051				
ENGINE															
2.6 quattro	Petrol	110	06/94-12/97	ABC											
ENGINE															
Engine	Information				A10	A20	A40	A50	A70	C10 - C30	C20	E01			
All engines											1.965.051				
ENGINE															
2.8	Petrol	120	08/95-07/96	AEJ											
ENGINE															
Engine	Information				A10	A20	A40	A50	A70	C10 - C30	C20	E01			
All engines											1.965.051				
ENGINE															
2.8	Petrol	128	06/94-12/97	AAH, AEJ											
ENGINE															
Engine	Information				A10	A20	A40	A50	A70	C10 - C30	C20	E01			
All engines											1.965.051				
ENGINE															
2.8 quattro	Petrol	128	06/94-12/97	AAH, AEJ											
ENGINE															
Engine	Information				A10	A20	A40	A50	A70	C10 - C30	C20	E01			
All engines											1.965.051				
ENGINE															
A10	CONDENSER		A20	CONTACT SET		A40	DISTRIBUTOR CAP		A50	ROTOR		A70	PICK-UP		
C10	COIL		C20	IGNITION MODULE		C30	ELECTRONIC IGNITION KIT		E01	IGNITION CABLE SET					

Vehicle	alim.	kW	Date	Engine	FUNCTIONS ON THE VEHICLE								
					A10	A20	A40	A50	A70	C10 - C30	C20	E01	
S6 4.2 quattro					ENGINE								
Petrol	213	06/94-12/97	AEC		A10	A20	A40	A50	A70	C10 - C30	C20	E01	
Engine	Information												
All engines	Qty: 2, version Bosch						1.306.248						
S6 Plus quattro					ENGINE								
Petrol	240	04/96-12/97	AHK		A10	A20	A40	A50	A70	C10 - C30	C20	E01	
Engine	Information												
All engines	without spark plug connector, Qty: 8									1.970.354S	C10		
All engines	incl. spark plug connector, Qty: 8									1.970.422	C10		
All engines	Qty: 2										1.965.076		
A6 II					ENGINE								
1.8	Petrol	85	05/97-01/05	AFY		A10	A20	A40	A50	A70	C10 - C30	C20	E01
Engine	Information												
All engines												1.501.491	
1.8					ENGINE								
Petrol	92	07/97-01/05	AJP, AQE, ARH		A10	A20	A40	A50	A70	C10 - C30	C20	E01	
Engine	Information												
All engines	x 4, COIL ON PLUG, incl. spark plug connector									1.970.445	C10		
1.8 T					ENGINE								
Petrol	110	01/97-01/05	1HN9, AEB, ANB, APU, ARK, AWT		A10	A20	A40	A50	A70	C10 - C30	C20	E01	
Engine	Information												
Eng. AEB, ANB, APU, ARK	x 4, COIL ON PLUG									1.970.354S	C10		
Eng. AWT	x 4, COIL ON PLUG, incl. spark plug connector									1.970.429	C10		
Eng. 1HN9, ANB, APU, ARK	ch. 4B-W-014 501 ->											1.965.072	
Eng. 1HN9	->ch. 4B-W-014 500											1.965.076	
1.8 T					ENGINE								
Petrol	132	12/97-01/05	AJL		A10	A20	A40	A50	A70	C10 - C30	C20	E01	
Engine	Information												
All engines	x 4, COIL ON PLUG									1.970.354S	C10		
All engines											1.965.072		
1.8 T quattro					ENGINE								
Petrol	110	02/97-01/05	1HN9, AEB, ANB, APU, ARK, AWT		A10	A20	A40	A50	A70	C10 - C30	C20	E01	
Engine	Information												
Eng. AEB, ANB, APU, ARK	x 4, COIL ON PLUG									1.970.354S	C10		
Eng. AWT	x 4, COIL ON PLUG, incl. spark plug connector									1.970.429	C10		
Eng. 1HN9, ANB, APU, ARK	ch. 4B-W-014 501 ->											1.965.072	
Eng. 1HN9	->ch. 4B-W-014 500											1.965.076	
1.8 T quattro					ENGINE								
Petrol	132	12/97-01/05	AJL		A10	A20	A40	A50	A70	C10 - C30	C20	E01	
Engine	Information												
All engines	x 4, COIL ON PLUG									1.970.354S	C10		
All engines											1.965.072		
2.0					ENGINE								
Petrol	96	08/01-01/05	ALT		A10	A20	A40	A50	A70	C10 - C30	C20	E01	
Engine	Information												
All engines	x 4, Colour:Red, COIL ON PLUG, incl. spark plug connector									1.970.436	C10		
2.7 T					ENGINE								
Petrol	169	02/99-01/05	AJK		A10	A20	A40	A50	A70	C10 - C30	C20	E01	
Engine	Information												
All engines	x 6, COIL ON PLUG									1.970.354S	C10		
2.7 T quattro					ENGINE								
Petrol	169	12/97-01/05	AJK, AZA		A10	A20	A40	A50	A70	C10 - C30	C20	E01	
Engine	Information												
All engines	x 6, COIL ON PLUG									1.970.354S	C10		
2.7 T quattro					ENGINE								
Petrol	184	08/01-01/05	1457L77, ARE		A10	A20	A40	A50	A70	C10 - C30	C20	E01	
Engine	Information												
Eng. ARE	x 6, COIL ON PLUG									1.970.354S	C10		
Eng. 1457L77	x 6, COIL ON PLUG, incl. spark plug connector									1.970.429	C10		

A10 CONDENSER	A20 CONTACT SET	A40 DISTRIBUTOR CAP	A50 ROTOR	A70 PICK-UP
C10 COIL	C20 IGNITION MODULE	C30 ELECTRONIC IGNITION KIT	E01 IGNITION CABLE SET	

The present application list is a brief version. For the detailed information about the possibility of installation on a specific vehicle, please refer to our web-catalogue <http://catalogo.facet.eu/>

				FUNCTIONS ON THE VEHICLE								
Vehicle	alim.	kW	Date	Engine								
				ENGINE								
3.0	Petrol	160	06/01-01/05	BBJ								
				ENGINE								
Engine		Information			A10	A20	A40	A50	A70	C10 - C30	C20	E01
All engines		x 6, Colour:Red, COIL ON PLUG, incl. spark plug connector								1.970.436	C10	
3.0	Petrol	162	08/01-01/05	ASN								
				ENGINE								
Engine		Information			A10	A20	A40	A50	A70	C10 - C30	C20	E01
All engines		x 6, Colour:Red, COIL ON PLUG, incl. spark plug connector								1.970.436	C10	
3.0 quattro	Petrol	160	06/01-01/05	BBJ								
				ENGINE								
Engine		Information			A10	A20	A40	A50	A70	C10 - C30	C20	E01
All engines		x 6, Colour:Red, COIL ON PLUG, incl. spark plug connector								1.970.436	C10	
3.0 quattro	Petrol	162	08/01-01/05	ASN								
				ENGINE								
Engine		Information			A10	A20	A40	A50	A70	C10 - C30	C20	E01
All engines		x 6, Colour:Red, COIL ON PLUG, incl. spark plug connector								1.970.436	C10	
4.2 quattro	Petrol	220	11/98-01/05	ARS, ASG								
				ENGINE								
Engine		Information			A10	A20	A40	A50	A70	C10 - C30	C20	E01
All engines		x 8, COIL ON PLUG, incl. spark plug connector								1.970.445	C10	
RS6 plus quattro	Petrol	353	04/04-01/05	BRV								
				ENGINE								
Engine		Information			A10	A20	A40	A50	A70	C10 - C30	C20	E01
All engines		RS6 Quattro, x 8, COIL ON PLUG, incl. spark plug connector								1.970.445	C10	
RS6 quattro	Petrol	331	07/02-01/05	BCY								
				ENGINE								
Engine		Information			A10	A20	A40	A50	A70	C10 - C30	C20	E01
All engines		RS6 Quattro, x 8, COIL ON PLUG, incl. spark plug connector								1.970.445	C10	
S6 quattro	Petrol	250	09/99-01/05	ANK, AQJ								
				ENGINE								
Engine		Information			A10	A20	A40	A50	A70	C10 - C30	C20	E01
All engines		S6 Quattro, x 8, COIL ON PLUG, incl. spark plug connector								1.970.445	C10	
A6 III				ENGINE								
2.0 TFSI	Petrol	125	06/05-08/11	BPJ, BYK								
				ENGINE								
Engine		Information			A10	A20	A40	A50	A70	C10 - C30	C20	E01
Eng. BPJ		x 4, ELDOR, Housing Colour:Black, COIL ON PLUG, incl. spark plug connector								1.970.426	C10	
Eng. BYK		Qty: 4								1.970.426	C10	
2.4	Petrol	130	05/04-10/08	BDW								
				ENGINE								
Engine		Information			A10	A20	A40	A50	A70	C10 - C30	C20	E01
All engines		x 6, Colour:Red, COIL ON PLUG, incl. spark plug connector								1.970.427	C10	
2.4 [CHN]	Petrol	130	04/05->	BDW								
				ENGINE								
Engine		Information			A10	A20	A40	A50	A70	C10 - C30	C20	E01
All engines		Qty: 6								1.970.427	C10	
2.4 quattro	Petrol	130	01/05-10/08	BDW								
				ENGINE								
Engine		Information			A10	A20	A40	A50	A70	C10 - C30	C20	E01
All engines		x 6, Colour:Red, COIL ON PLUG, incl. spark plug connector								1.970.427	C10	
2.8 FSI	Petrol	140	10/08-08/11	CCDA								
				ENGINE								
Engine		Information			A10	A20	A40	A50	A70	C10 - C30	C20	E01
All engines		x 6, Colour:Red, COIL ON PLUG, incl. spark plug connector								1.970.427	C10	
2.8 FSI	Petrol	154	11/06-10/08	BDX								
				ENGINE								
Engine		Information			A10	A20	A40	A50	A70	C10 - C30	C20	E01
All engines		x 6, Colour:Red, COIL ON PLUG, incl. spark plug connector								1.970.427	C10	

A10 CONDENSER	A20 CONTACT SET	A40 DISTRIBUTOR CAP	A50 ROTOR	A70 PICK-UP
C10 COIL	C20 IGNITION MODULE	C30 ELECTRONIC IGNITION KIT	E01 IGNITION CABLE SET	

Vehicle	alim.	kW	Date	Engine	FUNCTIONS ON THE VEHICLE									
					A10	A20	A40	A50	A70	C10 - C30	C20	E01		
ENGINE														
2.8 FSI	Petrol	162	10/08-08/11	CCEA										
ENGINE														
Information					A10	A20	A40	A50	A70	C10 - C30	C20	E01		
All engines										1.970.427	C10			
2.8 FSI quattro	Petrol	140	10/08-08/11	CCDA										
ENGINE														
Information					A10	A20	A40	A50	A70	C10 - C30	C20	E01		
All engines										1.970.427	C10			
2.8 FSI quattro	Petrol	154	06/07-10/08	BDX										
ENGINE														
Information					A10	A20	A40	A50	A70	C10 - C30	C20	E01		
All engines										1.970.427	C10			
2.8 FSI quattro	Petrol	162	10/08-08/11	CCEA										
ENGINE														
Information					A10	A20	A40	A50	A70	C10 - C30	C20	E01		
All engines										1.970.427	C10			
3.0	Petrol	160	08/04-05/06	BBJ										
ENGINE														
Information					A10	A20	A40	A50	A70	C10 - C30	C20	E01		
All engines										1.970.436	C10			
3.0 [CHN]	Petrol	160	04/05->	BBJ										
ENGINE														
Information					A10	A20	A40	A50	A70	C10 - C30	C20	E01		
All engines										1.970.436	C10			
3.0 quattro	Petrol	160	05/04-05/06	BBJ										
ENGINE														
Information					A10	A20	A40	A50	A70	C10 - C30	C20	E01		
All engines										1.970.436	C10			
3.0 TFSI quattro	Petrol	213	10/08-08/11	CAJA										
ENGINE														
Information					A10	A20	A40	A50	A70	C10 - C30	C20	E01		
All engines										1.970.427	C10			
3.0 TFSI quattro	Petrol	220	10/08-08/11	CCAA										
ENGINE														
Information					A10	A20	A40	A50	A70	C10 - C30	C20	E01		
All engines										1.970.427	C10			
3.2 FSI	Petrol	188	05/04-05/09	AUK, BKH										
ENGINE														
Information					A10	A20	A40	A50	A70	C10 - C30	C20	E01		
All engines										1.970.427	C10			
3.2 FSI	Petrol	195	05/09-03/11	CALA										
ENGINE														
Information					A10	A20	A40	A50	A70	C10 - C30	C20	E01		
All engines										1.970.427	C10			
3.2 FSI quattro	Petrol	183	09/06-10/08	BYU										
ENGINE														
Information					A10	A20	A40	A50	A70	C10 - C30	C20	E01		
All engines										1.970.427	C10			
3.2 FSI quattro	Petrol	188	05/04-10/08	AUK, BKH										
ENGINE														
Information					A10	A20	A40	A50	A70	C10 - C30	C20	E01		
All engines										1.970.427	C10			
4.2 FSI quattro	Petrol	257	05/06-08/11	BVJ										
ENGINE														
Information					A10	A20	A40	A50	A70	C10 - C30	C20	E01		
All engines										1.970.427	C10			
4.2 quattro	Petrol	246	05/04-05/06	BAT										
ENGINE														
Information					A10	A20	A40	A50	A70	C10 - C30	C20	E01		
All engines										1.970.433	C10			

A10 CONDENSER	A20 CONTACT SET	A40 DISTRIBUTOR CAP	A50 ROTOR	A70 PICK-UP
C10 COIL	C20 IGNITION MODULE	C30 ELECTRONIC IGNITION KIT	E01 IGNITION CABLE SET	

The present application list is a brief version. For the detailed information about the possibility of installation on a specific vehicle, please refer to our web-catalogue <http://catalogo.facet.eu/>









					FUNCTIONS ON THE VEHICLE							
Vehicle	alim.	kW	Date	Engine	A10	A20	A40	A50	A70	C10 - C30	C20	E01
ENGINE												
RS6 quattro	Petrol	426	04/08-08/10	BUH								
Engine	Information				A10	A20	A40	A50	A70	C10 - C30	C20	E01
All engines	RS6 Quattro, x 10, Colour:Red, COIL ON PLUG, incl. spark plug connector									1.970.427	C10	
ENGINE												
S6 quattro	Petrol	320	03/06-08/11	BXA								
Engine	Information				A10	A20	A40	A50	A70	C10 - C30	C20	E01
All engines	S6 Quattro, x 10, Colour:Red, COIL ON PLUG, incl. spark plug connector									1.970.427	C10	
ENGINE												
A6 IV												
ENGINE												
1.8 TFSI	Petrol	140	09/14-09/18	CYGA								
Engine	Information				A10	A20	A40	A50	A70	C10 - C30	C20	E01
All engines	->year 01/05/15, x 4, Colour:Black, COIL ON PLUG, incl. spark plug connector									1.970.636	C10	
ENGINE												
2.0 TFSI	Petrol	132	05/11-09/18	CDNB								
Engine	Information				A10	A20	A40	A50	A70	C10 - C30	C20	E01
All engines	x 4, ELDOR, Housing Colour:Black, COIL ON PLUG, incl. spark plug connector									1.970.426	C10	
ENGINE												
2.0 TFSI	Petrol	155	03/11-05/13	CAEB								
Engine	Information				A10	A20	A40	A50	A70	C10 - C30	C20	E01
All engines	x 4, ELDOR, Housing Colour:Black, COIL ON PLUG, incl. spark plug connector									1.970.426	C10	
ENGINE												
2.0 TFSI	Petrol	162	05/13->	CAED								
Engine	Information				A10	A20	A40	A50	A70	C10 - C30	C20	E01
All engines	Qty: 4									1.970.426	C10	
All engines	x 4, ELDOR, Housing Colour:Black, COIL ON PLUG, incl. spark plug connector									1.970.426	C10	
ENGINE												
2.0 TFSI	Petrol	185	09/14-09/18	CYNB, CYPA								
Engine	Information				A10	A20	A40	A50	A70	C10 - C30	C20	E01
All engines	->year 01/05/15, x 4, HITACHI, COIL ON PLUG, incl. spark plug connector ----- 01/02/18 ->, x 4, HITACHI, COIL ON PLUG, incl. spark plug connector									1.970.636	C10	
ENGINE												
2.0 TFSI hybrid	Petrol/ Electric	155	11/11-09/18	CHJA								
Engine	Information				A10	A20	A40	A50	A70	C10 - C30	C20	E01
All engines	x 4, ELDOR, Housing Colour:Black, COIL ON PLUG, incl. spark plug connector									1.970.426	C10	
ENGINE												
2.0 TFSI quattro	Petrol	155	05/12-05/13	CAEB								
Engine	Information				A10	A20	A40	A50	A70	C10 - C30	C20	E01
All engines	x 4, ELDOR, Housing Colour:Black, COIL ON PLUG, incl. spark plug connector									1.970.426	C10	
ENGINE												
2.0 TFSI quattro	Petrol	185	05/14-09/18	CYNB, CYPA								
Engine	Information				A10	A20	A40	A50	A70	C10 - C30	C20	E01
All engines	->year 01/05/15, x 4, HITACHI, COIL ON PLUG, incl. spark plug connector									1.970.636	C10	
ENGINE												
2.8 FSI	Petrol	150	11/10-04/15	CHVA								
Engine	Information				A10	A20	A40	A50	A70	C10 - C30	C20	E01
All engines	x 6, Colour:Red, COIL ON PLUG, incl. spark plug connector									1.970.427	C10	
ENGINE												
2.8 FSI quattro	Petrol	150	11/10-04/15	CHVA								
Engine	Information				A10	A20	A40	A50	A70	C10 - C30	C20	E01
All engines	x 6, Colour:Red, COIL ON PLUG, incl. spark plug connector									1.970.427	C10	
ENGINE												
2.8 FSI quattro	Petrol	162	09/14-09/18	CVPA								
Engine	Information				A10	A20	A40	A50	A70	C10 - C30	C20	E01
All engines	x 6, Colour:Red, COIL ON PLUG, incl. spark plug connector									1.970.427	C10	

A10 CONDENSER	A20 CONTACT SET	A40 DISTRIBUTOR CAP	A50 ROTOR	A70 PICK-UP
C10 COIL	C20 IGNITION MODULE	C30 ELECTRONIC IGNITION KIT	E01 IGNITION CABLE SET	

Vehicle	alim.	kW	Date	Engine	FUNCTIONS ON THE VEHICLE								
					A10	A20	A40	A50	A70	C10 - C30	C20	E01	
ENGINE													
3.0 TFSI	Petrol	250	09/14->	CREH									
Engine	Information				A10	A20	A40	A50	A70	C10 - C30	C20	E01	
All engines	Qty: 6									1.970.427	C10		
ENGINE													
3.0 TFSI quattro	Petrol	220	11/10-05/12	CGWB									
Engine	Information				A10	A20	A40	A50	A70	C10 - C30	C20	E01	
All engines	x 6, Colour:Red, COIL ON PLUG, incl. spark plug connector									1.970.427	C10		
ENGINE													
3.0 TFSI quattro	Petrol	228	03/11-09/18	CGWD, CGXB, CTUA									
Engine	Information				A10	A20	A40	A50	A70	C10 - C30	C20	E01	
All engines	x 6, Colour:Red, COIL ON PLUG, incl. spark plug connector									1.970.427	C10		
ENGINE													
3.0 TFSI quattro	Petrol	245	09/14-09/18	CREC									
Engine	Information				A10	A20	A40	A50	A70	C10 - C30	C20	E01	
All engines	x 6, Colour:Red, COIL ON PLUG, incl. spark plug connector									1.970.427	C10		
ENGINE													
3.0 TFSI quattro	Petrol	250	09/16-09/18	CREH									
Engine	Information				A10	A20	A40	A50	A70	C10 - C30	C20	E01	
All engines	x 6, Colour:Red, COIL ON PLUG, incl. spark plug connector									1.970.427	C10		
A6 V													
ENGINE													
40 TFSI	Petrol	150	09/20->	DMTC									
Engine	Information				A10	A20	A40	A50	A70	C10 - C30	C20	E01	
All engines	x 4, HITACHI, COIL ON PLUG, incl. spark plug connector									1.970.636	C10		
ENGINE													
45 TFSI Mild Hybrid	Petrol/ Electric	180	08/18->	DKNA, DLHA									
Engine	Information				A10	A20	A40	A50	A70	C10 - C30	C20	E01	
All engines	x 4, HITACHI, COIL ON PLUG, incl. spark plug connector									1.970.636	C10		
ENGINE													
45 TFSI Mild Hybrid	Petrol/ Electric	195	05/20->	DMTA									
Engine	Information				A10	A20	A40	A50	A70	C10 - C30	C20	E01	
All engines	x 4, HITACHI, COIL ON PLUG, incl. spark plug connector									1.970.636	C10		
ENGINE													
45 TFSI Mild Hybrid quattro	Petrol/ Electric	180	08/18->	DKNA, DLHA									
Engine	Information				A10	A20	A40	A50	A70	C10 - C30	C20	E01	
All engines	x 4, HITACHI, COIL ON PLUG, incl. spark plug connector									1.970.636	C10		
ENGINE													
45 TFSI Mild Hybrid quattro	Petrol/ Electric	195	05/20->	DMTA									
Engine	Information				A10	A20	A40	A50	A70	C10 - C30	C20	E01	
All engines	x 4, HITACHI, COIL ON PLUG, incl. spark plug connector									1.970.636	C10		
ENGINE													
50 TFSI e quattro	Petrol/ Electric	185	11/19->	DLGA									
Engine	Information				A10	A20	A40	A50	A70	C10 - C30	C20	E01	
All engines	x 4, HITACHI, COIL ON PLUG, incl. spark plug connector									1.970.636	C10		
ENGINE													
50 TFSI e quattro	Petrol/ Electric	195	02/21->	DRYA									
Engine	Information				A10	A20	A40	A50	A70	C10 - C30	C20	E01	
All engines	x 4, HITACHI, COIL ON PLUG, incl. spark plug connector									1.970.636	C10		
ENGINE													
50 TFSI e quattro	Petrol/ Electric	220	11/19->	DLGA, DRYA									
Engine	Information				A10	A20	A40	A50	A70	C10 - C30	C20	E01	
All engines	x 4, HITACHI, COIL ON PLUG, incl. spark plug connector									1.970.636	C10		

A10	CONDENSER	A20	CONTACT SET	A40	DISTRIBUTOR CAP	A50	ROTOR	A70	PICK-UP
C10	COIL	C20	IGNITION MODULE	C30	ELECTRONIC IGNITION KIT	E01	IGNITION CABLE SET		

The present application list is a brief version. For the detailed information about the possibility of installation on a specific vehicle, please refer to our web-catalogue <http://catalogo.facet.eu/>

					FUNCTIONS ON THE VEHICLE							
Vehicle	alim.	kW	Date	Engine								
ENGINE												
55 TFSI e quattro	Petrol/ Electric	185	11/19->	DLGA								
Engine	Information				A10	A20	A40	A50	A70	C10 - C30	C20	E01
All engines	x 4, HITACHI, COIL ON PLUG, incl. spark plug connector									1.970.636	C10	
ENGINE												
55 TFSI e quattro	Petrol/ Electric	195	02/21->	DRYA								
Engine	Information				A10	A20	A40	A50	A70	C10 - C30	C20	E01
All engines	x 4, HITACHI, COIL ON PLUG, incl. spark plug connector									1.970.636	C10	
ENGINE												
55 TFSI e quattro	Petrol/ Electric	270	11/19->	DLGA								
Engine	Information				A10	A20	A40	A50	A70	C10 - C30	C20	E01
All engines	x 4, HITACHI, COIL ON PLUG, incl. spark plug connector									1.970.636	C10	
A7												
ENGINE												
2.0 50 TFSI e	Diesel/ Electro	220	11/19->	DLGA								
Engine	Information				A10	A20	A40	A50	A70	C10 - C30	C20	E01
All engines	x 4, HITACHI, COIL ON PLUG, incl. spark plug connector									1.970.636	C10	
ENGINE												
45 TFSI Mild Hybrid	Petrol/ Electric	180	07/18->	DKNA, DLHA								
Engine	Information				A10	A20	A40	A50	A70	C10 - C30	C20	E01
All engines	x 4, HITACHI, COIL ON PLUG, incl. spark plug connector									1.970.636	C10	
ENGINE												
45 TFSI Mild hybrid quattro	Petrol/ Electric	180	07/18->	DKNA, DLHA								
Engine	Information				A10	A20	A40	A50	A70	C10 - C30	C20	E01
All engines	x 4, HITACHI, COIL ON PLUG, incl. spark plug connector									1.970.636	C10	
ENGINE												
55 TFSI e quattro	Petrol/ Electric	185	07/19->	DLGA								
Engine	Information				A10	A20	A40	A50	A70	C10 - C30	C20	E01
All engines	x 4, HITACHI, COIL ON PLUG, incl. spark plug connector									1.970.636	C10	
ENGINE												
55 TFSI e quattro	Petrol/ Electric	270	07/19->	DLGA								
Engine	Information				A10	A20	A40	A50	A70	C10 - C30	C20	E01
All engines	x 4, HITACHI, COIL ON PLUG, incl. spark plug connector									1.970.636	C10	
A7 SPORTBACK												
ENGINE												
2.0 TFSI	Petrol	185	09/14-05/18	CYPA								
Engine	Information				A10	A20	A40	A50	A70	C10 - C30	C20	E01
All engines	->year 01/03/15, x 4, HITACHI, COIL ON PLUG, incl. spark plug connector									1.970.636	C10	
ENGINE												
2.0 TFSI quattro	Petrol	185	05/15-05/18	CYNB								
Engine	Information				A10	A20	A40	A50	A70	C10 - C30	C20	E01
All engines	15/04/16 ->, Qty: 4									1.970.427	C10	
ENGINE												
2.5 FSI	Petrol	150	05/12->	CLXB								
Engine	Information				A10	A20	A40	A50	A70	C10 - C30	C20	E01
All engines	Qty: 6									1.970.427	C10	
ENGINE												
2.8 FSI	Petrol	150	02/11-03/15	CHVA								
Engine	Information				A10	A20	A40	A50	A70	C10 - C30	C20	E01
All engines	x 6, Colour:Red, COIL ON PLUG, incl. spark plug connector									1.970.427	C10	
ENGINE												
2.8 FSI quattro	Petrol	150	10/10-03/15	CHVA, CNYA								
Engine	Information				A10	A20	A40	A50	A70	C10 - C30	C20	E01
Eng. CHVA	x 6, Colour:Red, COIL ON PLUG, incl. spark plug connector									1.970.427	C10	
Eng. CNYA	Qty: 6									1.970.427	C10	

A10 CONDENSER	A20 CONTACT SET	A40 DISTRIBUTOR CAP	A50 ROTOR	A70 PICK-UP
C10 COIL	C20 IGNITION MODULE	C30 ELECTRONIC IGNITION KIT	E01 IGNITION CABLE SET	

Vehicle	alim.	kW	Date	Engine	FUNCTIONS ON THE VEHICLE											
					A10	A20	A40	A50	A70	C10 - C30	C20	E01				
ENGINE																
2.8 FSI quattro	Petrol	162	09/14-05/18	CVPA												
Engine	Information				A10	A20	A40	A50	A70	C10 - C30	C20	E01				
All engines	x 6, Colour:Red, COIL ON PLUG, incl. spark plug connector									1.970.427	C10					
ENGINE																
2.8 TFSI	Petrol	162	09/14->	CVPA												
Engine	Information				A10	A20	A40	A50	A70	C10 - C30	C20	E01				
All engines	Qty: 6									1.970.427	C10					
ENGINE																
3.0 TFSI	Petrol	250	05/14->	CREH												
Engine	Information				A10	A20	A40	A50	A70	C10 - C30	C20	E01				
All engines	Qty: 6									1.970.427	C10					
ENGINE																
3.0 TFSI quattro	Petrol	220	10/10-05/12	CGWB, CHMA												
Engine	Information				A10	A20	A40	A50	A70	C10 - C30	C20	E01				
Eng. CGWB	x 6, Colour:Red, COIL ON PLUG, incl. spark plug connector									1.970.427	C10					
Eng. CHMA	Qty: 6									1.970.427	C10					
ENGINE																
3.0 TFSI quattro	Petrol	228	01/11-03/15	CGWD, CGXB, CTTA, CTUA												
Engine	Information				A10	A20	A40	A50	A70	C10 - C30	C20	E01				
Eng. CGWD, CGXB, CTTA	x 6, Colour:Red, COIL ON PLUG, incl. spark plug connector									1.970.427	C10					
Eng. CTUA	Qty: 6									1.970.427	C10					
ENGINE																
3.0 TFSI quattro	Petrol	245	05/14-05/18	CREC												
Engine	Information				A10	A20	A40	A50	A70	C10 - C30	C20	E01				
All engines	x 6, Colour:Red, COIL ON PLUG, incl. spark plug connector									1.970.427	C10					
A8 I																
2.8	Petrol	120	07/95-03/96	AEJ												
Engine	Information				A10	A20	A40	A50	A70	C10 - C30	C20	E01				
All engines											1.965.051					
ENGINE																
2.8	Petrol	128	03/94-03/96	AAH												
Engine	Information				A10	A20	A40	A50	A70	C10 - C30	C20	E01				
All engines											1.965.051					
ENGINE																
2.8 quattro	Petrol	120	07/95-03/96	AEJ												
Engine	Information				A10	A20	A40	A50	A70	C10 - C30	C20	E01				
All engines											1.965.051					
ENGINE																
2.8 quattro	Petrol	128	03/94-03/96	AAH												
Engine	Information				A10	A20	A40	A50	A70	C10 - C30	C20	E01				
All engines											1.965.051					
ENGINE																
3.7	Petrol	169	07/95-12/98	AEW, AKJ												
Engine	Information				A10	A20	A40	A50	A70	C10 - C30	C20	E01				
Eng. AKJ	without spark plug connector, Qty: 8									1.970.3545	C10					
Eng. AKJ	incl. spark plug connector, Qty: 8									1.970.422	C10					
All engines	Qty: 2										1.965.076					
ENGINE																
3.7	Petrol	191	11/98-09/02	AKC, AQG												
Engine	Information				A10	A20	A40	A50	A70	C10 - C30	C20	E01				
All engines	x 8, COIL ON PLUG, incl. spark plug connector									1.970.445	C10					
ENGINE																
3.7 quattro	Petrol	169	07/95-11/98	AEW, AKJ												
Engine	Information				A10	A20	A40	A50	A70	C10 - C30	C20	E01				
All engines	Qty: 2										1.965.076					
ENGINE																
3.7 quattro	Petrol	191	11/98-09/02	AKC, AQG												
Engine	Information				A10	A20	A40	A50	A70	C10 - C30	C20	E01				
All engines	x 8, COIL ON PLUG, incl. spark plug connector									1.970.445	C10					
A10 CONDENSER					A20 CONTACT SET					A40 DISTRIBUTOR CAP			A50 ROTOR		A70 PICK-UP	
C10 COIL					C20 IGNITION MODULE					C30 ELECTRONIC IGNITION KIT			E01 IGNITION CABLE SET			









				FUNCTIONS ON THE VEHICLE								
Vehicle	alim.	kW	Date	Engine								
				ENGINE								
4.2 quattro	Petrol	175	02/99-04/00	ARU								
Engine	Information				A10	A20	A40	A50	A70	C10 - C30	C20	E01
All engines	x 8, COIL ON PLUG, incl. spark plug connector									1.970.445	C10	
				ENGINE								
4.2 quattro	Petrol	180	03/94-07/96	AEM								
Engine	Information				A10	A20	A40	A50	A70	C10 - C30	C20	E01
All engines	01/08/95 ->, ch. 4DT000221 ->, x 8, COIL ON PLUG									1.970.3545	C10	
All engines	Qty: 2										1.965.076	
				ENGINE								
4.2 quattro	Petrol	210	07/95-09/98	AGH								
Engine	Information				A10	A20	A40	A50	A70	C10 - C30	C20	E01
All engines	ch. 4D-T-000 221 ->, without spark plug connector, Qty: 8									1.970.3545	C10	
All engines	ch. 4D-T-000 221 ->, incl. spark plug connector, Qty: 8									1.970.422	C10	
All engines	Qty: 2										1.965.076	
				ENGINE								
4.2 quattro	Petrol	220	03/94-11/98	ABZ, AKG								
Engine	Information				A10	A20	A40	A50	A70	C10 - C30	C20	E01
All engines	01/08/95 ->, ch. 4DT000221 ->, ->ch. 4DX004999, x 8, COIL ON PLUG									1.970.3545	C10	
All engines	01/01/99 ->, ch. DX005001 ->, x 8, COIL ON PLUG, incl. spark plug connector									1.970.445	C10	
All engines	Qty: 2										1.965.076	
				ENGINE								
4.2 quattro	Petrol	224	09/96-12/99	ABZ								
Engine	Information				A10	A20	A40	A50	A70	C10 - C30	C20	E01
All engines	ch. 4D-X-005 001 ->, Qty: 8									1.970.445	C10	
				ENGINE								
4.2 quattro	Petrol	228	11/98-09/02	AQF, AUW								
Engine	Information				A10	A20	A40	A50	A70	C10 - C30	C20	E01
All engines	->year 01/12/98, ->ch. 4DX004999, x 8, COIL ON PLUG									1.970.3545	C10	
All engines	01/01/99 ->, ch. DX005001 ->, x 8, COIL ON PLUG, incl. spark plug connector									1.970.445	C10	
				ENGINE								
S8 quattro	Petrol	250	07/96-06/99	2C2CNG, AHC, AKH								
Engine	Information				A10	A20	A40	A50	A70	C10 - C30	C20	E01
Eng. AHC, AKH	S8 Quattro, x 8, COIL ON PLUG									1.970.3545	C10	
Eng. 2C2CNG, AKH	Qty: 2										1.965.076	
				ENGINE								
S8 quattro	Petrol	265	06/99-09/02	AQH, AVP, AYS, BCS								
Engine	Information				A10	A20	A40	A50	A70	C10 - C30	C20	E01
All engines	S8 Quattro, x 8, COIL ON PLUG, incl. spark plug connector									1.970.445	C10	
Eng. AYS, BCS	Qty: 8									1.970.445	C10	
				ENGINE								
A8 II				ENGINE								
2.8 FSI	Petrol	154	08/07-07/10	BDX								
Engine	Information				A10	A20	A40	A50	A70	C10 - C30	C20	E01
All engines	x 6, Colour:Red, COIL ON PLUG, incl. spark plug connector									1.970.427	C10	
				ENGINE								
2.8 FSI	Petrol	170	01/09-07/10	CJBA								
Engine	Information				A10	A20	A40	A50	A70	C10 - C30	C20	E01
All engines	Qty: 6									1.970.427	C10	
				ENGINE								
3.0	Petrol	160	07/03-05/06	BBJ								
Engine	Information				A10	A20	A40	A50	A70	C10 - C30	C20	E01
All engines	x 6, Colour:Red, COIL ON PLUG, incl. spark plug connector									1.970.436	C10	
				ENGINE								
3.0	Petrol	162	07/03-05/05	ASN								
Engine	Information				A10	A20	A40	A50	A70	C10 - C30	C20	E01
All engines	x 6, Colour:Red, COIL ON PLUG, incl. spark plug connector									1.970.436	C10	

A10 CONDENSER	A20 CONTACT SET	A40 DISTRIBUTOR CAP	A50 ROTOR	A70 PICK-UP
C10 COIL	C20 IGNITION MODULE	C30 ELECTRONIC IGNITION KIT	E01 IGNITION CABLE SET	

Vehicle	alim.	kW	Date	Engine	FUNCTIONS ON THE VEHICLE									
					A10	A20	A40	A50	A70	C10 - C30	C20	E01		
ENGINE														
3.0 quattro	Petrol	160	11/03-05/04	BBJ										
Engine	Information				A10	A20	A40	A50	A70	C10 - C30	C20	E01		
All engines	x 6, Colour:Red, COIL ON PLUG, incl. spark plug connector									1.970.436	C10			
ENGINE														
3.0 quattro	Petrol	162	07/03-05/05	ASN										
Engine	Information				A10	A20	A40	A50	A70	C10 - C30	C20	E01		
All engines	x 6, Colour:Red, COIL ON PLUG, incl. spark plug connector									1.970.436	C10			
ENGINE														
3.2 FSI	Petrol	191	06/05-07/10	BPK										
Engine	Information				A10	A20	A40	A50	A70	C10 - C30	C20	E01		
All engines	x 6, Colour:Red, COIL ON PLUG, incl. spark plug connector									1.970.427	C10			
ENGINE														
3.2 FSI quattro	Petrol	191	06/05-07/10	BPK										
Engine	Information				A10	A20	A40	A50	A70	C10 - C30	C20	E01		
All engines	x 6, Colour:Red, COIL ON PLUG, incl. spark plug connector									1.970.427	C10			
ENGINE														
3.7 quattro	Petrol	206	10/02-05/06	BFL										
Engine	Information				A10	A20	A40	A50	A70	C10 - C30	C20	E01		
All engines	x 8, Colour:Red, COIL ON PLUG, incl. spark plug connector									1.970.433	C10			
ENGINE														
4.2 FSI quattro	Petrol	257	06/06-07/10	BJJ										
Engine	Information				A10	A20	A40	A50	A70	C10 - C30	C20	E01		
All engines	x 8, Colour:Red, COIL ON PLUG, incl. spark plug connector									1.970.427	C10			
ENGINE														
4.2 quattro	Petrol	246	10/02-07/10	BFM										
Engine	Information				A10	A20	A40	A50	A70	C10 - C30	C20	E01		
All engines	x 8, Colour:Red, COIL ON PLUG, incl. spark plug connector									1.970.433	C10			
ENGINE														
S8 quattro	Petrol	324	09/06-07/10	BSM										
Engine	Information				A10	A20	A40	A50	A70	C10 - C30	C20	E01		
All engines	S8 Quattro, x 10, Colour:Red, COIL ON PLUG, incl. spark plug connector									1.970.427	C10			
ENGINE														
S8 quattro	Petrol	331	06/06-07/10	BSM										
Engine	Information				A10	A20	A40	A50	A70	C10 - C30	C20	E01		
All engines	S8 Quattro, x 10, Colour:Red, COIL ON PLUG, incl. spark plug connector									1.970.427	C10			
A8 III														
ENGINE														
2.0 TFSI hybrid	Petrol/ Electric	155	02/12-11/15	CHJA										
Engine	Information				A10	A20	A40	A50	A70	C10 - C30	C20	E01		
All engines	x 4, ELDOR, Housing Colour:Black, COIL ON PLUG, incl. spark plug connector									1.970.426	C10			
ENGINE														
2.5 TFSI	Petrol	150	07/12-06/16	CPAA, CVBA										
Engine	Information				A10	A20	A40	A50	A70	C10 - C30	C20	E01		
All engines	x 6, Colour:Red, COIL ON PLUG, incl. spark plug connector									1.970.427	C10			
ENGINE														
3.0 TDI quattro	Diesel	176	11/12-06/16	CPNA, CPNB										
Engine	Information				A10	A20	A40	A50	A70	C10 - C30	C20	E01		
All engines	x 6, Colour:Red, COIL ON PLUG, incl. spark plug connector									1.970.427	C10			
ENGINE														
3.0 TFSI quattro	Petrol	213	07/10-04/14	CGWA, CREG										
Engine	Information				A10	A20	A40	A50	A70	C10 - C30	C20	E01		
All engines	x 6, Colour:Red, COIL ON PLUG, incl. spark plug connector									1.970.427	C10			
ENGINE														
3.0 TFSI quattro	Petrol	228	11/11-01/18	CGWD, CREA										
Engine	Information				A10	A20	A40	A50	A70	C10 - C30	C20	E01		
All engines	x 6, Colour:Red, COIL ON PLUG, incl. spark plug connector									1.970.427	C10			

A10 CONDENSER	A20 CONTACT SET	A40 DISTRIBUTOR CAP	A50 ROTOR	A70 PICK-UP
C10 COIL	C20 IGNITION MODULE	C30 ELECTRONIC IGNITION KIT	E01 IGNITION CABLE SET	

The present application list is a brief version. For the detailed information about the possibility of installation on a specific vehicle, please refer to our web-catalogue <http://catalogo.facet.eu/>









					FUNCTIONS ON THE VEHICLE							
Vehicle	alim.	kW	Date	Engine	 A10	 A20	 A40	 A50	 A70	 C10 - C30	 C20	 E01
ALLROAD												
3.0 TFSI quattro	Petrol	245	06/10-01/18	ENGINE CGXC, CMDA, CREC, CTDA, CTUB								
Engine	Information				A10	A20	A40	A50	A70	C10 - C30	C20	E01
Eng. CGXC, CMDA	x 6, Colour:Red, COIL ON PLUG, incl. spark plug connector									1.970.427	C10	
Eng. CREC, CTDA, CTUB	Qty: 6									1.970.427	C10	
4.2 FSI quattro	Petrol	273	11/09-12/12	ENGINE CDRA								
Engine	Information				A10	A20	A40	A50	A70	C10 - C30	C20	E01
All engines	x 8, Colour:Red, COIL ON PLUG, incl. spark plug connector									1.970.427	C10	
2.7 T quattro	Petrol	184	05/00-08/05	ENGINE 1457L77, ARE								
Engine	Information				A10	A20	A40	A50	A70	C10 - C30	C20	E01
All engines	x 6, COIL ON PLUG									1.970.3545	C10	
All engines	x 6, COIL ON PLUG, incl. spark plug connector									1.970.429	C10	
4.2 V8 quattro	Petrol	220	07/02-08/05	ENGINE BAS								
Engine	Information				A10	A20	A40	A50	A70	C10 - C30	C20	E01
All engines	x 8, Colour:Red, COIL ON PLUG, incl. spark plug connector									1.970.433	C10	
CABRIOLET												
1.8	Petrol	92	01/97-08/00	ENGINE ADR								
Engine	Information				A10	A20	A40	A50	A70	C10 - C30	C20	E01
All engines												1.501.491
2.0 16V	Petrol	103	06/95-07/96	ENGINE ACE								
Engine	Information				A10	A20	A40	A50	A70	C10 - C30	C20	E01
All engines	version Bosch						1.306.248					
2.0 E	Petrol	85	01/93-07/98	ENGINE ABK								
Engine	Information				A10	A20	A40	A50	A70	C10 - C30	C20	E01
All engines	version Bosch						1.306.266	1.406.121R				
All engines	->ch. 8G-P-015 000									1.990.414	C30	
All engines												1.500.768
2.3 E	Petrol	98	05/91-07/94	ENGINE NG								
Engine	Information				A10	A20	A40	A50	A70	C10 - C30	C20	E01
All engines	version Bosch						1.306.231	1.406.121R				
All engines												1.501.682
2.6	Petrol	102	05/95-08/00	ENGINE ACZ								
Engine	Information				A10	A20	A40	A50	A70	C10 - C30	C20	E01
All engines											1.965.051	
2.6	Petrol	110	06/93-08/00	ENGINE ABC								
Engine	Information				A10	A20	A40	A50	A70	C10 - C30	C20	E01
All engines											1.965.051	
2.8	Petrol	128	11/92-08/00	ENGINE AAH								
Engine	Information				A10	A20	A40	A50	A70	C10 - C30	C20	E01
All engines											1.965.051	
COUPE												
1.8	Petrol	82	08/89-07/91	ENGINE DZ								
Engine	Information				A10	A20	A40	A50	A70	C10 - C30	C20	E01
All engines	version Bosch						1.306.266	1.406.055R	1.906.219			
All engines										1.970.127	C10	1.965.007
2.0	Petrol	82	03/90-07/90	ENGINE 3A								
Engine	Information				A10	A20	A40	A50	A70	C10 - C30	C20	E01
All engines	version Bosch						1.306.266	1.406.121R				

A10 CONDENSER	A20 CONTACT SET	A40 DISTRIBUTOR CAP	A50 ROTOR	A70 PICK-UP
C10 COIL	C20 IGNITION MODULE	C30 ELECTRONIC IGNITION KIT	E01 IGNITION CABLE SET	

Vehicle	alim.	kW	Date	Engine	FUNCTIONS ON THE VEHICLE							
					A10	A20	A40	A50	A70	C10 - C30	C20	E01
ENGINE												
2.0	Petrol	82	03/90-07/90	3A								
ENGINE												
Engine Information					A10	A20	A40	A50	A70	C10 - C30	C20	E01
All engines												1.500.768
ENGINE												
2.0	Petrol	83	05/89-03/90	3A								
ENGINE												
Engine Information					A10	A20	A40	A50	A70	C10 - C30	C20	E01
All engines							1.306.266	1.406.121R				
All engines												1.500.768
ENGINE												
2.0	Petrol	85	05/89-12/96	AAD, ABK								
ENGINE												
Engine Information					A10	A20	A40	A50	A70	C10 - C30	C20	E01
All engines							1.306.266	1.406.121R				
Eng. ABK										1.990.414	C30	
All engines												1.500.768
ENGINE												
2.0 16 V	Petrol	101	01/92-07/92	6A								
ENGINE												
Engine Information					A10	A20	A40	A50	A70	C10 - C30	C20	E01
All engines							1.306.248					
ENGINE												
2.0 16 V	Petrol	103	08/92-12/96	ACE								
ENGINE												
Engine Information					A10	A20	A40	A50	A70	C10 - C30	C20	E01
All engines							1.306.248					
ENGINE												
2.0 20 V	Petrol	118	08/89-07/91	NM								
ENGINE												
Engine Information					A10	A20	A40	A50	A70	C10 - C30	C20	E01
All engines							1.306.231					
ENGINE												
2.0 20 V quattro	Petrol	118	08/89-07/91	NM								
ENGINE												
Engine Information					A10	A20	A40	A50	A70	C10 - C30	C20	E01
All engines							1.306.231					
ENGINE												
2.2	Petrol	100	11/88-07/91	9C54								
ENGINE												
Engine Information					A10	A20	A40	A50	A70	C10 - C30	C20	E01
All engines							1.306.231	1.406.055R	1.906.219			
All engines										1.970.127	C10	1.965.007
All engines												1.501.682
ENGINE												
2.2 GT	Petrol	100	09/84-10/88	9C54								
ENGINE												
Engine Information					A10	A20	A40	A50	A70	C10 - C30	C20	E01
All engines							1.306.231					
All engines								1.406.055R				
All engines								1.406.116R				
All engines										1.970.125	C10	
All engines										1.970.127	C10	
All engines												1.965.004
All engines												1.965.007
All engines												1.501.682
ENGINE												
2.2 quattro	Petrol	100	10/84-07/91	9C54								
ENGINE												
Engine Information					A10	A20	A40	A50	A70	C10 - C30	C20	E01
All engines							1.306.231					
All engines								1.406.055R				
All engines								1.406.116R				
All engines									1.906.219			
All engines										1.970.125	C10	
All engines										1.970.127	C10	
All engines												1.965.004
All engines												1.965.007
All engines												1.501.682
ENGINE												
2.2 quattro	Petrol	88	08/85-10/88	JT								
ENGINE												
Engine Information					A10	A20	A40	A50	A70	C10 - C30	C20	E01
All engines							1.306.231	1.406.055R				

A10	CONDENSER	A20	CONTACT SET	A40	DISTRIBUTOR CAP	A50	ROTOR	A70	PICK-UP
C10	COIL	C20	IGNITION MODULE	C30	ELECTRONIC IGNITION KIT	E01	IGNITION CABLE SET		

The present application list is a brief version. For the detailed information about the possibility of installation on a specific vehicle, please refer to our web-catalogue <http://catalogo.facet.eu/>

				FUNCTIONS ON THE VEHICLE								
Vehicle	alim.	kW	Date	Engine	 A10	 A20	 A40	 A50	 A70	 C10 - C30	 C20	 E01
				ENGINE								
2.2 quattro	Petrol	88	08/85-10/88	JT								
Engine	Information				A10	A20	A40	A50	A70	C10 - C30	C20	E01
All engines	->ch. 85-F-220 000									1.970.125	C10	
All engines	ch. 85-G-000 001 ->									1.970.127	C10	
All engines	->ch. 85-H-070 000										1.965.004	
All engines	ch. 85-J-000 001 ->										1.965.007	
				ENGINE								
2.3	Petrol	100	10/88-07/94	NG								
Engine	Information				A10	A20	A40	A50	A70	C10 - C30	C20	E01
All engines	version Bosch						1.306.231	1.406.121R				
All engines											1.501.682	
				ENGINE								
2.3	Petrol	98	03/90-12/96	NG								
Engine	Information				A10	A20	A40	A50	A70	C10 - C30	C20	E01
All engines	version Bosch						1.306.231	1.406.121R				
All engines											1.501.682	
				ENGINE								
2.3 20V	Petrol	123	08/90-07/91	7A								
Engine	Information				A10	A20	A40	A50	A70	C10 - C30	C20	E01
All engines	version Bosch						1.306.231					
				ENGINE								
2.3 20V	Petrol	125	08/89-07/91	7A								
Engine	Information				A10	A20	A40	A50	A70	C10 - C30	C20	E01
All engines	version Bosch						1.306.231					
				ENGINE								
2.3 20V quattro	Petrol	123	05/90-12/96	7A								
Engine	Information				A10	A20	A40	A50	A70	C10 - C30	C20	E01
All engines	version Bosch						1.306.231					
				ENGINE								
2.3 20V quattro	Petrol	125	11/88-07/91	7A								
Engine	Information				A10	A20	A40	A50	A70	C10 - C30	C20	E01
All engines	version Bosch						1.306.231					
				ENGINE								
2.3 quattro	Petrol	100	11/88-12/92	NG								
Engine	Information				A10	A20	A40	A50	A70	C10 - C30	C20	E01
All engines	version Bosch						1.306.231	1.406.121R				
All engines											1.501.682	
				ENGINE								
2.3 quattro	Petrol	98	01/87-12/96	NG								
Engine	Information				A10	A20	A40	A50	A70	C10 - C30	C20	E01
All engines	version Bosch						1.306.231	1.406.121R	1.906.219			
All engines											1.501.682	
				ENGINE								
2.6	Petrol	110	08/92-12/96	ABC								
Engine	Information				A10	A20	A40	A50	A70	C10 - C30	C20	E01
All engines											1.965.051	
				ENGINE								
2.6 quattro	Petrol	110	08/92-12/96	ABC								
Engine	Information				A10	A20	A40	A50	A70	C10 - C30	C20	E01
All engines											1.965.051	
				ENGINE								
2.8	Petrol	128	09/91-12/96	AAH								
Engine	Information				A10	A20	A40	A50	A70	C10 - C30	C20	E01
All engines											1.965.051	
				ENGINE								
2.8 quattro	Petrol	128	08/91-12/96	AAH								
Engine	Information				A10	A20	A40	A50	A70	C10 - C30	C20	E01
All engines											1.965.051	

A10 CONDENSER	A20 CONTACT SET	A40 DISTRIBUTOR CAP	A50 ROTOR	A70 PICK-UP
C10 COIL	C20 IGNITION MODULE	C30 ELECTRONIC IGNITION KIT	E01 IGNITION CABLE SET	

Vehicle	alim.	kW	Date	Engine	FUNCTIONS ON THE VEHICLE									
					A10	A20	A40	A50	A70	C10 - C30	C20	E01		
ENGINE														
S2	Petrol	162	09/90-09/92	3B										
ENGINE														
Engine	Information				A10	A20	A40	A50	A70	C10 - C30	C20	E01		
All engines	version Bosch						1.306.231							
ENGINE														
S2 quattro	Petrol	162	09/90-09/92	3B										
ENGINE														
Engine	Information				A10	A20	A40	A50	A70	C10 - C30	C20	E01		
All engines	version Bosch						1.306.231							
ENGINE														
Q2														
ENGINE														
1.0 TFSI	Petrol	85	10/16-10/20	CHZJ, DKRF										
ENGINE														
Engine	Information				A10	A20	A40	A50	A70	C10 - C30	C20	E01		
All engines	x 3, ELDOR, COIL ON PLUG, incl. spark plug connector, Number of pins:4, incl. spark plug connector									1.970.599	C10			
ENGINE														
1.4 TFSI	Petrol	110	06/16-08/18	CZEA										
ENGINE														
Engine	Information				A10	A20	A40	A50	A70	C10 - C30	C20	E01		
All engines	x 4, BERU, version 1, version 2, COIL ON PLUG, ELDOR, COIL ON PLUG, incl. spark plug connector, incl. spark plug connector, Number of pins:4, incl. spark plug connector									1.970.599	C10			
ENGINE														
2.0 TFSI quattro	Petrol	140	05/17->	CZPB, DKZA										
ENGINE														
Engine	Information				A10	A20	A40	A50	A70	C10 - C30	C20	E01		
All engines	01/04/18 ->, x 4, HITACHI, COIL ON PLUG, incl. spark plug connector									1.970.636	C10			
ENGINE														
30 TFSI	Petrol	81	08/20->	DLAA										
ENGINE														
Engine	Information				A10	A20	A40	A50	A70	C10 - C30	C20	E01		
All engines	x 3, ELDOR, COIL ON PLUG, incl. spark plug connector, Number of pins:4, incl. spark plug connector									1.970.599	C10			
ENGINE														
30 TFSI	Petrol	85	07/18-10/20	CHZJ, DKRF										
ENGINE														
Engine	Information				A10	A20	A40	A50	A70	C10 - C30	C20	E01		
All engines	x 3, ELDOR, COIL ON PLUG, incl. spark plug connector, Number of pins:4, incl. spark plug connector									1.970.599	C10			
ENGINE														
SQ2 TFSI quattro	Petrol	221	08/18->	DNFC, DNUE										
ENGINE														
Engine	Information				A10	A20	A40	A50	A70	C10 - C30	C20	E01		
All engines	SQ2 Quattro, x 4, HITACHI, COIL ON PLUG, incl. spark plug connector									1.970.636	C10			
ENGINE														
Q3														
ENGINE														
1.4 TFSI	Petrol	92	07/16-10/18	CZDB										
ENGINE														
Engine	Information				A10	A20	A40	A50	A70	C10 - C30	C20	E01		
All engines	x 4, ELDOR, COIL ON PLUG, Number of pins:4, incl. spark plug connector									1.970.599	C10			
ENGINE														
1.4 TSI	Petrol	110	10/13-10/18	CHPB, CZDA, CZEA										
ENGINE														
Engine	Information				A10	A20	A40	A50	A70	C10 - C30	C20	E01		
All engines	x 4, BERU, ELDOR, COIL ON PLUG, incl. spark plug connector, Number of pins:4, incl. spark plug connector									1.970.599	C10			
ENGINE														
2.0 TFSI	Petrol	147	10/13->	CCTA										
ENGINE														
Engine	Information				A10	A20	A40	A50	A70	C10 - C30	C20	E01		
All engines	Qty: 4									1.970.426	C10			
ENGINE														
2.0 TFSI quattro	Petrol	125	06/11-04/15	CCZC										
ENGINE														
Engine	Information				A10	A20	A40	A50	A70	C10 - C30	C20	E01		
All engines	x 4, ELDOR, Housing Colour:Black, COIL ON PLUG, incl. spark plug connector									1.970.426	C10			
ENGINE														
2.0 TFSI quattro	Petrol	147	09/14-10/18	CCTA										
ENGINE														
Engine	Information				A10	A20	A40	A50	A70	C10 - C30	C20	E01		
All engines	x 4, ELDOR, Housing Colour:Black, COIL ON PLUG, incl. spark plug connector									1.970.426	C10			

A10 CONDENSER	A20 CONTACT SET	A40 DISTRIBUTOR CAP	A50 ROTOR	A70 PICK-UP
C10 COIL	C20 IGNITION MODULE	C30 ELECTRONIC IGNITION KIT	E01 IGNITION CABLE SET	

The present application list is a brief version. For the detailed information about the possibility of installation on a specific vehicle, please refer to our web-catalogue <http://catalogo.facet.eu/>









					FUNCTIONS ON THE VEHICLE							
Vehicle	alim.	kW	Date	Engine	A10	A20	A40	A50	A70	C10 - C30	C20	E01
ENGINE												
2.0 TFSI quattro	Petrol	155	06/11-04/15	CPSA								
Engine	Information				A10	A20	A40	A50	A70	C10 - C30	C20	E01
All engines	x 4, ELDOR, Housing Colour:Black, COIL ON PLUG, incl. spark plug connector									1.970.426	C10	
ENGINE												
RS 2.5 quattro	Petrol	228	10/13-10/18	CTSA								
Engine	Information				A10	A20	A40	A50	A70	C10 - C30	C20	E01
All engines	RSQ3 Quattro, x 5, ELDOR, Housing Colour:Black, COIL ON PLUG, incl. spark plug connector									1.970.426	C10	
ENGINE												
RS 2.5 quattro	Petrol	250	05/13-10/18	CZGA								
Engine	Information				A10	A20	A40	A50	A70	C10 - C30	C20	E01
All engines	RSQ3 Quattro, x 5, ELDOR, Housing Colour:Black, COIL ON PLUG, incl. spark plug connector									1.970.426	C10	
ENGINE												
RS performance 2.5 quattro	Petrol	270	01/15-10/18	CZGB								
Engine	Information				A10	A20	A40	A50	A70	C10 - C30	C20	E01
All engines	RSQ3 Quattro, x 5, ELDOR, Housing Colour:Black, COIL ON PLUG, incl. spark plug connector									1.970.426	C10	
Q5 I												
ENGINE												
2.0 Hybrid quattro	Petrol/ Electric	180	09/12-05/16	CHJA								
Engine	Information				A10	A20	A40	A50	A70	C10 - C30	C20	E01
All engines	x 4, ELDOR, Housing Colour:Black, COIL ON PLUG, incl. spark plug connector									1.970.426	C10	
ENGINE												
2.0 TFSI	Petrol	130	11/08->	CDNA								
Engine	Information				A10	A20	A40	A50	A70	C10 - C30	C20	E01
All engines	Qty: 6									1.970.426	C10	
ENGINE												
2.0 TFSI Hybrid quattro	Petrol/ Electric	155	06/11-06/16	CHJA								
Engine	Information				A10	A20	A40	A50	A70	C10 - C30	C20	E01
All engines	x 4, ELDOR, Housing Colour:Black, COIL ON PLUG, incl. spark plug connector									1.970.426	C10	
ENGINE												
2.0 TFSI quattro	Petrol	132	08/09-05/17	CDNB, CNCB								
Engine	Information				A10	A20	A40	A50	A70	C10 - C30	C20	E01
Eng. CDNB	x 4, ELDOR, Housing Colour:Black, COIL ON PLUG, incl. spark plug connector									1.970.426	C10	
Eng. CNCB	x 4, HITACHI, COIL ON PLUG, incl. spark plug connector									1.970.636	C10	
ENGINE												
2.0 TFSI quattro	Petrol	155	11/08-09/12	CAEB, CDNC, CPMA								
Engine	Information				A10	A20	A40	A50	A70	C10 - C30	C20	E01
Eng. CAEB, CDNC	x 4, ELDOR, Housing Colour:Black, COIL ON PLUG, incl. spark plug connector									1.970.426	C10	
Eng. CPMA	Qty: 4									1.970.426	C10	
ENGINE												
2.0 TFSI quattro	Petrol	162	05/13-05/17	CPMB								
Engine	Information				A10	A20	A40	A50	A70	C10 - C30	C20	E01
All engines	x 4, ELDOR, Housing Colour:Black, COIL ON PLUG, incl. spark plug connector									1.970.426	C10	
ENGINE												
2.0 TFSI quattro	Petrol	165	06/12-05/16	CNCD								
Engine	Information				A10	A20	A40	A50	A70	C10 - C30	C20	E01
All engines	->year 01/05/15, x 4, HITACHI, COIL ON PLUG, incl. spark plug connector									1.970.636	C10	
ENGINE												
2.0 TFSI quattro [CHN]	Petrol	155	09/09->	CADA								
Engine	Information				A10	A20	A40	A50	A70	C10 - C30	C20	E01
All engines	Qty: 4									1.970.426	C10	

A10 CONDENSER	A20 CONTACT SET	A40 DISTRIBUTOR CAP	A50 ROTOR	A70 PICK-UP
C10 COIL	C20 IGNITION MODULE	C30 ELECTRONIC IGNITION KIT	E01 IGNITION CABLE SET	

Vehicle	alim.	kW	Date	Engine	FUNCTIONS ON THE VEHICLE									
					A10	A20	A40	A50	A70	C10 - C30	C20	E01		
ENGINE														
3.0 TFSI quattro	Petrol	200	06/12-05/17	CTUC, CTVA										
Engine	Information				A10	A20	A40	A50	A70	C10 - C30	C20	E01		
All engines	x 6, Colour:Red, COIL ON PLUG, incl. spark plug connector									1.970.427	C10			
ENGINE														
3.2 FSI quattro	Petrol	199	11/08-12/12	CALB										
Engine	Information				A10	A20	A40	A50	A70	C10 - C30	C20	E01		
All engines	x 6, Colour:Red, COIL ON PLUG, incl. spark plug connector									1.970.427	C10			
ENGINE														
SQ5 TFSI quattro	Petrol	260	05/13-05/17	CTUD, CTXA										
Engine	Information				A10	A20	A40	A50	A70	C10 - C30	C20	E01		
All engines	SQ5 Quattro, x 6, Colour:Red, COIL ON PLUG, incl. spark plug connector									1.970.427	C10			
Q5 II														
ENGINE														
2.0 TFSI quattro	Petrol	183	01/17-11/20	DAXC										
Engine	Information				A10	A20	A40	A50	A70	C10 - C30	C20	E01		
All engines	x 4, BERU, HITACHI, COIL ON PLUG, incl. spark plug connector									1.970.636	C10			
ENGINE														
2.0 TFSI quattro	Petrol	185	06/16->	DAXB, DAYB										
Engine	Information				A10	A20	A40	A50	A70	C10 - C30	C20	E01		
All engines	x 4, BERU, HITACHI, COIL ON PLUG, incl. spark plug connector									1.970.636	C10			
ENGINE														
35 TDI	Diesel	120	10/21->	DTNA										
Engine	Information				A10	A20	A40	A50	A70	C10 - C30	C20	E01		
All engines	x 4, HITACHI, COIL ON PLUG, incl. spark plug connector									1.970.636	C10			
ENGINE														
45 TFSI Mild Hybrid quattro	Petrol/ Electric	180	12/18->	DNTA										
Engine	Information				A10	A20	A40	A50	A70	C10 - C30	C20	E01		
All engines	x 4, HITACHI, COIL ON PLUG, incl. spark plug connector									1.970.636	C10			
ENGINE														
45 TFSI Mild Hybrid quattro	Petrol/ Electric	195	08/20->	DPUA, DPVA										
Engine	Information				A10	A20	A40	A50	A70	C10 - C30	C20	E01		
All engines	x 4, HITACHI, COIL ON PLUG, incl. spark plug connector									1.970.636	C10			
ENGINE														
45 TFSI quattro	Petrol/ Electric	195	11/20->	DPVA										
Engine	Information				A10	A20	A40	A50	A70	C10 - C30	C20	E01		
All engines	x 4, HITACHI, COIL ON PLUG, incl. spark plug connector									1.970.636	C10			
ENGINE														
50 TFSI e quattro	Petrol/ Electric	185	04/19-11/20	DLGA										
Engine	Information				A10	A20	A40	A50	A70	C10 - C30	C20	E01		
All engines	x 4, HITACHI, COIL ON PLUG, incl. spark plug connector									1.970.636	C10			
ENGINE														
50 TFSI e quattro	Petrol/ Electric	220	04/19->	DLGA										
Engine	Information				A10	A20	A40	A50	A70	C10 - C30	C20	E01		
All engines	x 4, HITACHI, COIL ON PLUG, incl. spark plug connector									1.970.636	C10			
ENGINE														
55 TFSI e quattro	Petrol/ Electric	185	08/19-11/20	DLGA										
Engine	Information				A10	A20	A40	A50	A70	C10 - C30	C20	E01		
All engines	x 4, HITACHI, COIL ON PLUG, incl. spark plug connector									1.970.636	C10			
Q7 I														
ENGINE														
3.0 TFSI quattro	Petrol	200	05/10-08/15	CJTC, CJWC										
Engine	Information				A10	A20	A40	A50	A70	C10 - C30	C20	E01		
All engines	x 6, Colour:Red, COIL ON PLUG, incl. spark plug connector									1.970.427	C10			

A10 CONDENSER	A20 CONTACT SET	A40 DISTRIBUTOR CAP	A50 ROTOR	A70 PICK-UP
C10 COIL	C20 IGNITION MODULE	C30 ELECTRONIC IGNITION KIT	E01 IGNITION CABLE SET	

The present application list is a brief version. For the detailed information about the possibility of installation on a specific vehicle, please refer to our web-catalogue <http://catalogo.facet.eu/>









					FUNCTIONS ON THE VEHICLE							
Vehicle	alim.	kW	Date	Engine	 A10	 A20	 A40	 A50	 A70	 C10 - C30	 C20	 E01
ENGINE												
3.0 TFSI quattro	Petrol	206	05/11-08/15	CJWE, CTWB								
Engine	Information				A10	A20	A40	A50	A70	C10 - C30	C20	E01
All engines	x 6, Colour:Red, COIL ON PLUG, incl. spark plug connector									1.970.427	C10	
ENGINE												
3.0 TFSI quattro	Petrol	245	05/10-08/15	CJTB, CJWB, CNAA, CTWA								
Engine	Information				A10	A20	A40	A50	A70	C10 - C30	C20	E01
All engines	x 6, Colour:Red, COIL ON PLUG, incl. spark plug connector									1.970.427	C10	
ENGINE												
4.2 FSI quattro	Petrol	257	03/06-05/10	BAR								
Engine	Information				A10	A20	A40	A50	A70	C10 - C30	C20	E01
All engines	x 8, Colour:Red, COIL ON PLUG, incl. spark plug connector									1.970.427	C10	
ENGINE												
4.2 quattro	Petrol	231	03/06-12/10	BAR								
Engine	Information				A10	A20	A40	A50	A70	C10 - C30	C20	E01
All engines	x 8, Colour:Red, COIL ON PLUG, incl. spark plug connector									1.970.427	C10	
ENGINE												
Q7 II												
ENGINE												
2.0 TFSI	Petrol	185	08/15->	CVJA								
Engine	Information				A10	A20	A40	A50	A70	C10 - C30	C20	E01
All engines	Qty: 4									1.970.636	C10	
ENGINE												
2.0 TFSI quattro	Petrol	185	08/15->	CYRB								
Engine	Information				A10	A20	A40	A50	A70	C10 - C30	C20	E01
All engines	x 4, HITACHI, COIL ON PLUG, incl. spark plug connector									1.970.636	C10	
ENGINE												
3.0 TFSI quattro	Petrol	245	01/15-12/19	CREC								
Engine	Information				A10	A20	A40	A50	A70	C10 - C30	C20	E01
All engines	x 6, Colour:Red, COIL ON PLUG, incl. spark plug connector									1.970.427	C10	
ENGINE												
Q8												
ENGINE												
45 TFSI	Petrol	180	07/20->	DMFA, DNEA								
Engine	Information				A10	A20	A40	A50	A70	C10 - C30	C20	E01
All engines	x 4, HITACHI, COIL ON PLUG, incl. spark plug connector									1.970.636	C10	
ENGINE												
45 TFSI quattro	Petrol	180	10/19->	DMFA, DNEA								
Engine	Information				A10	A20	A40	A50	A70	C10 - C30	C20	E01
All engines	x 4, HITACHI, COIL ON PLUG, incl. spark plug connector									1.970.636	C10	
ENGINE												
R8												
ENGINE												
4.2 FSI quattro	Petrol	309	04/07-09/10	BYH								
Engine	Information				A10	A20	A40	A50	A70	C10 - C30	C20	E01
All engines	x 8, Colour:Red, COIL ON PLUG, incl. spark plug connector									1.970.427	C10	
ENGINE												
4.2 FSI quattro	Petrol	316	07/10-07/15	CNDA								
Engine	Information				A10	A20	A40	A50	A70	C10 - C30	C20	E01
All engines	x 8, Colour:Red, COIL ON PLUG, incl. spark plug connector									1.970.427	C10	
ENGINE												
5.2 FSI	Petrol	397	09/17->	DKAB								
Engine	Information				A10	A20	A40	A50	A70	C10 - C30	C20	E01
All engines	x 10, Colour:Red, COIL ON PLUG									1.970.427	C10	
ENGINE												
5.2 FSI	Petrol	404	07/12-07/15	CTPA								
Engine	Information				A10	A20	A40	A50	A70	C10 - C30	C20	E01
All engines	x 10, Colour:Red, COIL ON PLUG, incl. spark plug connector									1.970.427	C10	
ENGINE												
5.2 FSI	Petrol	419	07/12->	CTPB, DKAC								
Engine	Information				A10	A20	A40	A50	A70	C10 - C30	C20	E01
All engines	x 10, Colour:Red, COIL ON PLUG, incl. spark plug connector									1.970.427	C10	

A10 CONDENSER	A20 CONTACT SET	A40 DISTRIBUTOR CAP	A50 ROTOR	A70 PICK-UP
C10 COIL	C20 IGNITION MODULE	C30 ELECTRONIC IGNITION KIT	E01 IGNITION CABLE SET	

Vehicle	alim.	kW	Date	Engine	FUNCTIONS ON THE VEHICLE									
					A10	A20	A40	A50	A70	C10 - C30	C20	E01		
ENGINE														
5.2 FSI quattro	Petrol	386	04/09-07/15	BUJ, CTYA										
Engine	Information				A10	A20	A40	A50	A70	C10 - C30	C20	E01		
All engines	x 10, Colour:Red, COIL ON PLUG, incl. spark plug connector									1.970.427	C10			
ENGINE														
5.2 FSI quattro	Petrol	397	07/15->	CSPB										
Engine	Information				A10	A20	A40	A50	A70	C10 - C30	C20	E01		
All engines	x 10, Colour:Red, COIL ON PLUG									1.970.427	C10			
ENGINE														
5.2 FSI quattro	Petrol	404	05/12-07/15	CTPA										
Engine	Information				A10	A20	A40	A50	A70	C10 - C30	C20	E01		
All engines	x 10, Colour:Red, COIL ON PLUG, incl. spark plug connector									1.970.427	C10			
ENGINE														
5.2 FSI quattro	Petrol	412	11/10-07/15	CPMA										
Engine	Information				A10	A20	A40	A50	A70	C10 - C30	C20	E01		
All engines	x 10, ELTOR, Housing Colour:Black, COIL ON PLUG, incl. spark plug connector									1.970.426	C10			
ENGINE														
5.2 FSI quattro	Petrol	419	07/14->	CTPB, DKAC										
Engine	Information				A10	A20	A40	A50	A70	C10 - C30	C20	E01		
All engines	x 10, Colour:Red, COIL ON PLUG, incl. spark plug connector									1.970.427	C10			
ENGINE														
5.2 FSI quattro	Petrol	449	07/15->	CSPA, DKAA										
Engine	Information				A10	A20	A40	A50	A70	C10 - C30	C20	E01		
All engines	x 10, Colour:Red, COIL ON PLUG									1.970.427	C10			
ENGINE														
5.2 FSI quattro	Petrol	456	09/18->	DMWA										
Engine	Information				A10	A20	A40	A50	A70	C10 - C30	C20	E01		
All engines	x 10, Colour:Red, COIL ON PLUG									1.970.427	C10			
TT I														
ENGINE														
1.8 T	Petrol	110	01/01-06/06	AUM										
Engine	Information				A10	A20	A40	A50	A70	C10 - C30	C20	E01		
All engines	x 4, COIL ON PLUG, incl. spark plug connector									1.970.429	C10			
ENGINE														
1.8 T	Petrol	120	09/05-06/06	BVP										
Engine	Information				A10	A20	A40	A50	A70	C10 - C30	C20	E01		
All engines	x 4, COIL ON PLUG, incl. spark plug connector									1.970.429	C10			
ENGINE														
1.8 T	Petrol	132	10/98-06/06	AJQ, APP, ATC, AUQ										
Engine	Information				A10	A20	A40	A50	A70	C10 - C30	C20	E01		
All engines	01/08/00 ->, ch. 8N1010001 ->, x 4, COIL ON PLUG, incl. spark plug connector									1.970.429	C10			
All engines	->year 01/07/00, ->ch. 8N1010000, x 4, COIL ON PLUG, incl. spark plug connector									1.970.445	C10			
ENGINE														
1.8 T	Petrol	140	09/05-06/06	BVR										
Engine	Information				A10	A20	A40	A50	A70	C10 - C30	C20	E01		
All engines	x 4, COIL ON PLUG, incl. spark plug connector									1.970.429	C10			
ENGINE														
1.8 T quattro	Petrol	132	10/98-06/06	AJQ, ARY, ATC, AUQ										
Engine	Information				A10	A20	A40	A50	A70	C10 - C30	C20	E01		
All engines	01/08/00 ->, ch. 8N1010001 ->, x 4, COIL ON PLUG, incl. spark plug connector									1.970.429	C10			
All engines	->year 01/07/00, ->ch. 8N1010000, x 4, COIL ON PLUG, incl. spark plug connector									1.970.445	C10			
ENGINE														
1.8 T quattro	Petrol	140	09/05-06/06	BVR										
Engine	Information				A10	A20	A40	A50	A70	C10 - C30	C20	E01		
All engines	x 4, COIL ON PLUG, incl. spark plug connector									1.970.429	C10			

A10	CONDENSER	A20	CONTACT SET	A40	DISTRIBUTOR CAP	A50	ROTOR	A70	PICK-UP
C10	COIL	C20	IGNITION MODULE	C30	ELECTRONIC IGNITION KIT	E01	IGNITION CABLE SET		

The present application list is a brief version. For the detailed information about the possibility of installation on a specific vehicle, please refer to our web-catalogue <http://catalogo.facet.eu/>

				FUNCTIONS ON THE VEHICLE								
Vehicle	alim.	kW	Date	Engine	 A10	 A20	 A40	 A50	 A70	 C10 - C30	 C20	 E01
				ENGINE								
1.8 T quattro	Petrol	165	10/98-06/06	APX, BAM								
Engine	Information				A10	A20	A40	A50	A70	C10 - C30	C20	E01
All engines	01/08/00 ->, x 4, COIL ON PLUG, incl. spark plug connector									1.970.429	C10	
All engines	->year 01/07/00, x 4, COIL ON PLUG, incl. spark plug connector									1.970.445	C10	
				ENGINE								
1.8 T quattro	Petrol	180	03/05-06/06	BFV								
Engine	Information				A10	A20	A40	A50	A70	C10 - C30	C20	E01
All engines	x 4, COIL ON PLUG, incl. spark plug connector									1.970.429	C10	
				ENGINE								
3.2 VR6 quattro	Petrol	184	07/03-06/06	BHE, BPF								
Engine	Information				A10	A20	A40	A50	A70	C10 - C30	C20	E01
All engines	x 6, COIL ON PLUG									1.970.434	C10	
				TT II								
				ENGINE								
1.8 TFSI	Petrol	118	06/08-06/14	CDA A								
Engine	Information				A10	A20	A40	A50	A70	C10 - C30	C20	E01
All engines	x 4, ELDOR, Housing Colour:Black, COIL ON PLUG, incl. spark plug connector									1.970.426	C10	
				ENGINE								
2.0 TFSI	Petrol	147	08/06-06/10	BPY, BWA, CCTA								
Engine	Information				A10	A20	A40	A50	A70	C10 - C30	C20	E01
Eng. BPY, CCTA	Qty: 4									1.970.426	C10	
Eng. BWA	x 4, ELDOR, Housing Colour:Black, COIL ON PLUG, incl. spark plug connector									1.970.426	C10	
				ENGINE								
2.0 TFSI	Petrol	155	05/10-06/14	CESA								
Engine	Information				A10	A20	A40	A50	A70	C10 - C30	C20	E01
All engines	x 4, ELDOR, Housing Colour:Black, COIL ON PLUG, incl. spark plug connector									1.970.426	C10	
				ENGINE								
2.0 TFSI quattro	Petrol	147	06/08-06/10	BWA, CCZA								
Engine	Information				A10	A20	A40	A50	A70	C10 - C30	C20	E01
Eng. BWA	Qty: 4									1.970.426	C10	
Eng. CCZA	x 4, ELDOR, Housing Colour:Black, COIL ON PLUG, incl. spark plug connector									1.970.426	C10	
				ENGINE								
2.0 TFSI quattro	Petrol	155	05/10-06/14	CESA, CETA								
Engine	Information				A10	A20	A40	A50	A70	C10 - C30	C20	E01
All engines	x 4, ELDOR, Housing Colour:Black, COIL ON PLUG, incl. spark plug connector									1.970.426	C10	
				ENGINE								
2.0 TTS quattro	Petrol	195	05/08-06/14	CDLA, CDMA								
Engine	Information				A10	A20	A40	A50	A70	C10 - C30	C20	E01
All engines	TTS Quattro, x 4, ELDOR, Housing Colour:Black, COIL ON PLUG, incl. spark plug connector									1.970.426	C10	
				ENGINE								
2.0 TTS quattro	Petrol	200	05/08-06/14	CDLB								
Engine	Information				A10	A20	A40	A50	A70	C10 - C30	C20	E01
All engines	TTS Quattro, x 4, ELDOR, Housing Colour:Black, COIL ON PLUG, incl. spark plug connector									1.970.426	C10	
				ENGINE								
2.5 RS quattro	Petrol	250	07/09-06/14	CEPA								
Engine	Information				A10	A20	A40	A50	A70	C10 - C30	C20	E01
All engines	TTRS Quattro, x 5, ELDOR, Housing Colour:Black, COIL ON PLUG, incl. spark plug connector									1.970.426	C10	
				ENGINE								
2.5 RS quattro	Petrol	265	05/11-06/14	CEPB								
Engine	Information				A10	A20	A40	A50	A70	C10 - C30	C20	E01
All engines	TTRS Quattro, x 5, ELDOR, Housing Colour:Black, COIL ON PLUG, incl. spark plug connector									1.970.426	C10	
				ENGINE								
3.2 V6 quattro	Petrol	184	08/06-06/10	BUB								
Engine	Information				A10	A20	A40	A50	A70	C10 - C30	C20	E01
All engines	x 6, COIL ON PLUG									1.970.434	C10	

A10 CONDENSER	A20 CONTACT SET	A40 DISTRIBUTOR CAP	A50 ROTOR	A70 PICK-UP
C10 COIL	C20 IGNITION MODULE	C30 ELECTRONIC IGNITION KIT	E01 IGNITION CABLE SET	

Vehicle	alim.	kW	Date	Engine	FUNCTIONS ON THE VEHICLE							
					A10	A20	A40	A50	A70	C10 - C30	C20	E01

TT III

				ENGINE
1.8 TFSI	Petrol	132	07/15-08/18	CJSA, CJSB

Engine	Information	A10	A20	A40	A50	A70	C10 - C30	C20	E01
All engines	x 4, HITACHI, COIL ON PLUG, incl. spark plug connector						1.970.636	C10	

				ENGINE
2.0 TTS quattro	Petrol	210	02/15->	CJXF

Engine	Information	A10	A20	A40	A50	A70	C10 - C30	C20	E01
All engines	TTS Quattro, x 4, HITACHI, COIL ON PLUG, incl. spark plug connector						1.970.636	C10	

				ENGINE
2.0 TTS quattro	Petrol	215	07/15->	CYFB

Engine	Information	A10	A20	A40	A50	A70	C10 - C30	C20	E01
All engines	TTS Quattro, x 4, HITACHI, COIL ON PLUG, incl. spark plug connector						1.970.636	C10	

				ENGINE
2.0 TTS quattro	Petrol	225	08/18->	DNUF

Engine	Information	A10	A20	A40	A50	A70	C10 - C30	C20	E01
All engines	x 4, HITACHI, COIL ON PLUG, incl. spark plug connector						1.970.636	C10	

				ENGINE
2.0 TTS quattro	Petrol	228	11/14->	CJXG

Engine	Information	A10	A20	A40	A50	A70	C10 - C30	C20	E01
All engines	TTS Quattro, x 4, HITACHI, COIL ON PLUG, incl. spark plug connector						1.970.636	C10	

				ENGINE
40 TFSI	Petrol	145	07/18->	DKZB, DNNB

Engine	Information	A10	A20	A40	A50	A70	C10 - C30	C20	E01
All engines	01/11/18 ->, x 4, HITACHI, COIL ON PLUG, incl. spark plug connector						1.970.636	C10	

V8

				ENGINE
3.6 quattro	Petrol	180	04/93-02/94	PT

Engine	Information	A10	A20	A40	A50	A70	C10 - C30	C20	E01
All engines	Qty: 2			1.306.248					

				ENGINE
3.6 quattro	Petrol	184	10/88-02/94	PT







Engine	Information	A10	A20	A40	A50	A70	C10 - C30	C20	E01
All engines	Qty: 2			1.306.248					

				ENGINE
4.2 quattro	Petrol	206	10/91-02/94	ABH

Engine	Information	A10	A20	A40	A50	A70	C10 - C30	C20	E01
All engines	Qty: 2			1.306.248					

A10	CONDENSER	A20	CONTACT SET	A40	DISTRIBUTOR CAP	A50	ROTOR	A70	PICK-UP
C10	COIL	C20	IGNITION MODULE	C30	ELECTRONIC IGNITION KIT	E01	IGNITION CABLE SET		

The present application list is a brief version. For the detailed information about the possibility of installation on a specific vehicle, please refer to our web-catalogue <http://catalogo.facet.eu/>

				FUNCTIONS ON THE VEHICLE								
Vehicle	alim.	kW	Date	Engine								
1000-SERIES												
1100	Petrol	32	01/70-12/74	--	ENGINE							
Engine	Information			A10	A20	A40	A50	A70	C10 - C30	C20	E01	
All engines					1.228.083MHV	1.328.075	1.428.006					
1300	Petrol	39	01/70-12/74	--	ENGINE							
Engine	Information			A10	A20	A40	A50	A70	C10 - C30	C20	E01	
All engines					1.228.083MHV	1.328.075	1.428.006					
1300 GT	Petrol	50	01/70-12/74	--	ENGINE							
Engine	Information			A10	A20	A40	A50	A70	C10 - C30	C20	E01	
All engines					1.228.083MHV	1.328.075	1.428.006					
ALLEGRO												
1.1	Petrol	33	05/73-10/81	10 H	ENGINE							
Engine	Information			A10	A20	A40	A50	A70	C10 - C30	C20	E01	
All engines						1.328.075	1.428.006					
1.3	Petrol	40	05/73-03/82	12 H	ENGINE							
Engine	Information			A10	A20	A40	A50	A70	C10 - C30	C20	E01	
All engines					1.228.083MHV	1.328.075	1.428.006					
1.5 Super	Petrol	50	05/73-03/82	14 H	ENGINE							
Engine	Information			A10	A20	A40	A50	A70	C10 - C30	C20	E01	
All engines					1.228.083MHV	1.328.075	1.428.006					
APACHE												
1300	Petrol	44	11/71-10/74	--	ENGINE							
Engine	Information			A10	A20	A40	A50	A70	C10 - C30	C20	E01	
All engines						1.328.075	1.428.006					
1300 TC	Petrol	52	11/71-10/74	--	ENGINE							
Engine	Information			A10	A20	A40	A50	A70	C10 - C30	C20	E01	
All engines						1.328.075	1.428.006					
MAXI												
1500	Petrol	50	04/69-07/80	--, 14 H	ENGINE							
Engine	Information			A10	A20	A40	A50	A70	C10 - C30	C20	E01	
All engines					1.228.083MHV	1.328.075	1.428.006					
1750	Petrol	53	04/69-10/80	17 H	ENGINE							
Engine	Information			A10	A20	A40	A50	A70	C10 - C30	C20	E01	
All engines					1.228.083MHV	1.328.075	1.428.006					
1750 HL	Petrol	66	10/72-10/80	--, 17 LA	ENGINE							
Engine	Information			A10	A20	A40	A50	A70	C10 - C30	C20	E01	
All engines					1.228.083MHV	1.328.075	1.428.006					
MINI												
1.3	Petrol	53	09/69-09/80	12 HC	ENGINE							
Engine	Information			A10	A20	A40	A50	A70	C10 - C30	C20	E01	
All engines						1.328.075	1.428.006					
1000	Petrol	26	10/67-09/84	--	ENGINE							
Engine	Information			A10	A20	A40	A50	A70	C10 - C30	C20	E01	
All engines						1.328.075	1.428.006					
1000	Petrol	28	01/69-08/81	--, 99 H	ENGINE							
Engine	Information			A10	A20	A40	A50	A70	C10 - C30	C20	E01	
All engines						1.328.075	1.428.006					

A10 CONDENSER	A20 CONTACT SET	A40 DISTRIBUTOR CAP	A50 ROTOR	A70 PICK-UP
C10 COIL	C20 IGNITION MODULE	C30 ELECTRONIC IGNITION KIT	E01 IGNITION CABLE SET	

Vehicle	alim.	kW	Date	Engine	FUNCTIONS ON THE VEHICLE									
					A10	A20	A40	A50	A70	C10 - C30	C20	E01		
ENGINE														
1000	Petrol	29	10/67-09/84	99 H										
Engine Information					A10	A20	A40	A50	A70	C10 - C30	C20	E01		
All engines						1.228.083MHV	1.328.075	1.428.006						
ENGINE														
1275 GT	Petrol	39	10/69-08/80	12 H										
Engine Information					A10	A20	A40	A50	A70	C10 - C30	C20	E01		
All engines						1.228.083MHV	1.328.075	1.428.006						
ENGINE														
850	Petrol	25	01/60-12/69	--										
Engine Information					A10	A20	A40	A50	A70	C10 - C30	C20	E01		
All engines								1.428.006						
MINI I														
ENGINE														
1.0	Petrol	44	09/62-08/69	--										
Engine Information					A10	A20	A40	A50	A70	C10 - C30	C20	E01		
All engines								1.428.006						
ENGINE														
1.1	Petrol	46	11/62-08/64	--										
Engine Information					A10	A20	A40	A50	A70	C10 - C30	C20	E01		
All engines								1.428.006						
ENGINE														
1.3	Petrol	57	09/62-08/69	--										
Engine Information					A10	A20	A40	A50	A70	C10 - C30	C20	E01		
All engines								1.428.006						
ENGINE														
850	Petrol	25	06/59-08/69	781Y										
Engine Information					A10	A20	A40	A50	A70	C10 - C30	C20	E01		
All engines							1.328.075	1.428.006						
ENGINE														
Cooper	Petrol	41	01/61-12/67	99 H										
Engine Information					A10	A20	A40	A50	A70	C10 - C30	C20	E01		
All engines								1.428.006						
ENGINE														
Cooper S	Petrol	57	09/62-12/71	--										
Engine Information					A10	A20	A40	A50	A70	C10 - C30	C20	E01		
All engines							1.328.075	1.428.006						
MONTEGO														
ENGINE														
1.3	Petrol	50	10/84-08/88	--, 12 HL										
Engine Information					A10	A20	A40	A50	A70	C10 - C30	C20	E01		
All engines							1.328.094	1.428.025						
ENGINE														
1.6 LS	Petrol	61	10/84-08/88	16 HC37										
Engine Information					A10	A20	A40	A50	A70	C10 - C30	C20	E01		
All engines							1.328.093	1.428.024R						
ENGINE														
1.6 LS, HL	Petrol	61	04/84-08/88	16 HC37										
Engine Information					A10	A20	A40	A50	A70	C10 - C30	C20	E01		
All engines							1.328.093	1.428.024R						
ENGINE														
2.0	Petrol	74	04/84-08/88	20 HSC										
Engine Information					A10	A20	A40	A50	A70	C10 - C30	C20	E01		
All engines							1.328.093	1.428.024R						
ENGINE														
2.0 Turbo	Petrol	110	04/84-08/88	20 HC85										
Engine Information					A10	A20	A40	A50	A70	C10 - C30	C20	E01		
All engines							1.328.093	1.428.024R						

A10 CONDENSER	A20 CONTACT SET	A40 DISTRIBUTOR CAP	A50 ROTOR	A70 PICK-UP
C10 COIL	C20 IGNITION MODULE	C30 ELECTRONIC IGNITION KIT	E01 IGNITION CABLE SET	

The present application list is a brief version. For the detailed information about the possibility of installation on a specific vehicle, please refer to our web-catalogue <http://catalogo.facet.eu/>

Vehicle	alim.	kW	Date	Engine	FUNCTIONS ON THE VEHICLE							
					A10	A20	A40	A50	A70	C10 - C30	C20	E01

3000

				ENGINE
3.0 Sport	Petrol	110	03/64-10/68	--

Engine	Information	A10	A20	A40	A50	A70	C10 - C30	C20	E01
All engines					1.428.007				

SPRITE

				ENGINE
1.3	Petrol	48	03/66-10/71	--, 12CC

Engine	Information	A10	A20	A40	A50	A70	C10 - C30	C20	E01
All engines					1.428.006				

SPRITE MK.III

				ENGINE
1.1	Petrol	41	03/64-09/66	--

Engine	Information	A10	A20	A40	A50	A70	C10 - C30	C20	E01
All engines					1.428.006				

A10 CONDENSER	A20 CONTACT SET	A40 DISTRIBUTOR CAP	A50 ROTOR	A70 PICK-UP
C10 COIL	C20 IGNITION MODULE	C30 ELECTRONIC IGNITION KIT	E01 IGNITION CABLE SET	

Vehicle	alim.	kW	Date	Engine	FUNCTIONS ON THE VEHICLE							
					 A10	 A20	 A40	 A50	 A70	 C10 - C30	 C20	 E01

CHEVANNE

				ENGINE
1.3	Petrol	39	06/76-02/80	13D



Engine	Information	A10	A20	A40	A50	A70	C10 - C30	C20	E01
All engines					1.412.090				

				ENGINE
1.3	Petrol	40	03/80-12/82	LW4

Engine	Information	A10	A20	A40	A50	A70	C10 - C30	C20	E01
All engines					1.412.090				

A10	CONDENSER	A20	CONTACT SET	A40	DISTRIBUTOR CAP	A50	ROTOR	A70	PICK-UP
C10	COIL	C20	IGNITION MODULE	C30	ELECTRONIC IGNITION KIT	E01	IGNITION CABLE SET		

The present application list is a brief version. For the detailed information about the possibility of installation on a specific vehicle, please refer to our web-catalogue <http://catalogo.facet.eu/>

					FUNCTIONS ON THE VEHICLE							
Vehicle	alim.	kW	Date	Engine								
					A10	A20	A40	A50	A70	C10 - C30	C20	E01

BENTAYGA

				ENGINE
3.0 Hybrid	Petrol/ Electric	250	08/18->	DCBE

Engine	Information	A10	A20	A40	A50	A70	C10 - C30	C20	E01
All engines	x 6, ELDOR, COIL ON PLUG						1.970.636	C10	

				ENGINE
4.0	Petrol	404	01/18->	DCUA









Engine	Information	A10	A20	A40	A50	A70	C10 - C30	C20	E01
All engines	x 8, COIL ON PLUG						1.970.636	C10	

A10	CONDENSER	A20	CONTACT SET	A40	DISTRIBUTOR CAP	A50	ROTOR	A70	PICK-UP
C10	COIL	C20	IGNITION MODULE	C30	ELECTRONIC IGNITION KIT	E01	IGNITION CABLE SET		

Vehicle	alim.	kW	Date	Engine	FUNCTIONS ON THE VEHICLE									
					A10	A20	A40	A50	A70	C10 - C30	C20	E01		
1 I														
116 i	Petrol	85	06/04-12/11	ENGINE N43 B16 A, N45 B16 A										
Engine	Information			A10	A20	A40	A50	A70	C10 - C30	C20	E01			
Eng. N45 B16 A	x 4, DELPHI, ELDOR, COIL ON PLUG								1.970.475	C10				
Eng. N43 B16 A	Qty: 4								1.970.607	C10				
116 i	Petrol	90	03/07-12/11	ENGINE N43 B16 AA, N43 B20 A										
Engine	Information			A10	A20	A40	A50	A70	C10 - C30	C20	E01			
All engines	x 4, BOSCH, COIL ON PLUG								1.970.607	C10				
118 d	Diesel	90	06/04-02/07	ENGINE M47 D20 (204D4)										
Engine	Information			A10	A20	A40	A50	A70	C10 - C30	C20	E01			
All engines	Qty: 4								1.970.607	C10				
118 i	Petrol	100	09/06-12/13	ENGINE N46 B20 B										
Engine	Information			A10	A20	A40	A50	A70	C10 - C30	C20	E01			
All engines	x 4, DELPHI, ELDOR, COIL ON PLUG								1.970.475	C10				
118 i	Petrol	105	09/06-12/13	ENGINE N43 B20 A										
Engine	Information			A10	A20	A40	A50	A70	C10 - C30	C20	E01			
All engines	x 4, BOSCH, COIL ON PLUG								1.970.607	C10				
118 i	Petrol	125	03/07-12/07	ENGINE N43 B20 A										
Engine	Information			A10	A20	A40	A50	A70	C10 - C30	C20	E01			
All engines	x 4, BOSCH, COIL ON PLUG								1.970.607	C10				
118 i	Petrol	95	07/04-02/08	ENGINE N46 B20 B										
Engine	Information			A10	A20	A40	A50	A70	C10 - C30	C20	E01			
All engines	x 4, DELPHI, COIL ON PLUG								1.970.475	C10				
120 i	Petrol	110	06/04-02/07	ENGINE N46 B20 B, N46 B20 BD, N46 B20 C										
Engine	Information			A10	A20	A40	A50	A70	C10 - C30	C20	E01			
All engines	x 4, DELPHI, COIL ON PLUG								1.970.475	C10				
120 i	Petrol	115	03/07-12/13	ENGINE N46 B20 B, N46 B20 BD, N46 B20 C										
Engine	Information			A10	A20	A40	A50	A70	C10 - C30	C20	E01			
Eng. N46 B20 B, N46 B20 C	x 4, DELPHI, COIL ON PLUG								1.970.475	C10				
Eng. N46 B20 BD	Qty: 4								1.970.607	C10				
120 i	Petrol	120	03/07-12/13	ENGINE N43 B20 A, N46 B20 C										
Engine	Information			A10	A20	A40	A50	A70	C10 - C30	C20	E01			
Eng. N46 B20 C	Qty: 4								1.970.475	C10				
Eng. N43 B20 A	x 4, BOSCH, COIL ON PLUG								1.970.607	C10				
120 i	Petrol	125	03/07-10/13	ENGINE N43 B20 A										
Engine	Information			A10	A20	A40	A50	A70	C10 - C30	C20	E01			
All engines	x 4, BOSCH, COIL ON PLUG								1.970.607	C10				
125 i	Petrol	160	10/07->	ENGINE N52 B30 A, N52 B30 B, N52 B30 BF										
Engine	Information			A10	A20	A40	A50	A70	C10 - C30	C20	E01			
All engines	x 6, DELPHI, COIL ON PLUG								1.970.475	C10				
Eng. N52 B30 B, N52 B30 BF	Qty: 6								1.970.475	C10				
128 i	Petrol	172	12/07->	ENGINE N51 B30 A, N52 B30 A										
Engine	Information			A10	A20	A40	A50	A70	C10 - C30	C20	E01			
All engines	Qty: 6								1.970.475	C10				

A10 CONDENSER	A20 CONTACT SET	A40 DISTRIBUTOR CAP	A50 ROTOR	A70 PICK-UP
C10 COIL	C20 IGNITION MODULE	C30 ELECTRONIC IGNITION KIT	E01 IGNITION CABLE SET	

The present application list is a brief version. For the detailed information about the possibility of installation on a specific vehicle, please refer to our web-catalogue <http://catalogo.facet.eu/>









					FUNCTIONS ON THE VEHICLE							
Vehicle	alim.	kW	Date	Engine	 A10	 A20	 A40	 A50	 A70	 C10 - C30	 C20	 E01
ENGINE												
130 i	Petrol	190	09/06-12/11	N52 B30 A, N52 B30 B, N52 B30 BF								
Engine					A10	A20	A40	A50	A70	C10 - C30	C20	E01
Information					x 6, DELPHI, COIL ON PLUG							
										1.970.475	C10	
ENGINE												
130 i	Petrol	195	09/05-12/11	N52 B30 A, N52 B30 B, N52 B30 BF								
Engine					A10	A20	A40	A50	A70	C10 - C30	C20	E01
Information					x 6, DELPHI, COIL ON PLUG							
										1.970.475	C10	
ENGINE												
135 i	Petrol	225	10/07-10/13	N54 B30 A, N55 B30 A								
Engine					A10	A20	A40	A50	A70	C10 - C30	C20	E01
Information					x 6, DELPHI, ELDOR, COIL ON PLUG							
										1.970.475	C10	
ENGINE												
135 i	Petrol	240	10/07-12/13	N54 B30 A, N55 B30 A								
Engine					A10	A20	A40	A50	A70	C10 - C30	C20	E01
Information					Qty: 6							
Eng. N54 B30 A										1.970.475	C10	
Information					x 6, DELPHI, COIL ON PLUG							
Eng. N55 B30 A										1.970.475	C10	
ENGINE												
M	Petrol	250	03/11-06/12	N54 B30 A								
Engine					A10	A20	A40	A50	A70	C10 - C30	C20	E01
Information					x 6, DELPHI, ELDOR, COIL ON PLUG							
										1.970.475	C10	
ENGINE												
1 II												
ENGINE												
114 i	Petrol	75	12/11->	N13 B16 A								
Engine					A10	A20	A40	A50	A70	C10 - C30	C20	E01
Information					x 4, DELPHI, COIL ON PLUG							
										1.970.475	C10	
ENGINE												
116 i	Petrol	100	07/11->	N13 B16 A								
Engine					A10	A20	A40	A50	A70	C10 - C30	C20	E01
Information					x 4, DELPHI, COIL ON PLUG							
										1.970.475	C10	
ENGINE												
116 i	Petrol	80	03/15->	B38 B15 A								
Engine					A10	A20	A40	A50	A70	C10 - C30	C20	E01
Information					x 3, COIL ON PLUG							
										1.970.632	C10	
ENGINE												
118 i	Petrol	100	03/15->	B38 B15 A, N13 B16 A								
Engine					A10	A20	A40	A50	A70	C10 - C30	C20	E01
Information					Eng. N13 B16 A x 4, DELPHI, COIL ON PLUG							
										1.970.475	C10	
Information					Eng. B38 B15 A x 3, COIL ON PLUG							
										1.970.632	C10	
ENGINE												
118 i	Petrol	125	07/11->	N13 B16 A								
Engine					A10	A20	A40	A50	A70	C10 - C30	C20	E01
Information					x 4, DELPHI, COIL ON PLUG							
										1.970.475	C10	
ENGINE												
120 i	Petrol	130	03/15->	N13 B16 A								
Engine					A10	A20	A40	A50	A70	C10 - C30	C20	E01
Information					x 4, DELPHI, COIL ON PLUG							
										1.970.475	C10	
ENGINE												
120 i	Petrol	135	07/16->	B48 B20 A								
Engine					A10	A20	A40	A50	A70	C10 - C30	C20	E01
Information					x 4, COIL ON PLUG							
										1.970.632	C10	
ENGINE												
125 i	Petrol	160	12/11-12/19	N20 B20 A								
Engine					A10	A20	A40	A50	A70	C10 - C30	C20	E01
Information					x 4, DELPHI, COIL ON PLUG							
										1.970.475	C10	
ENGINE												
125 i	Petrol	165	10/15->	B48 B20 B								
Engine					A10	A20	A40	A50	A70	C10 - C30	C20	E01
Information					x 4, COIL ON PLUG							
										1.970.632	C10	

A10 CONDENSER	A20 CONTACT SET	A40 DISTRIBUTOR CAP	A50 ROTOR	A70 PICK-UP
C10 COIL	C20 IGNITION MODULE	C30 ELECTRONIC IGNITION KIT	E01 IGNITION CABLE SET	

Vehicle	alim.	kW	Date	Engine	FUNCTIONS ON THE VEHICLE									
					A10	A20	A40	A50	A70	C10 - C30	C20	E01		
ENGINE														
125 i	Petrol	175	03/12->	N20 B20 A										
Engine	Information				A10	A20	A40	A50	A70	C10 - C30	C20	E01		
All engines	x 4, DELPHI, COIL ON PLUG									1.970.475	C10			
ENGINE														
125 i Active Flex	Petrol/ Ethanol	160	11/14-11/17	N20 B20 A										
Engine	Information				A10	A20	A40	A50	A70	C10 - C30	C20	E01		
All engines	x 4, DELPHI, COIL ON PLUG									1.970.475	C10			
ENGINE														
M 135 i	Petrol	235	12/11->	N55 B30 A										
Engine	Information				A10	A20	A40	A50	A70	C10 - C30	C20	E01		
All engines	x 6, DELPHI, COIL ON PLUG									1.970.475	C10			
ENGINE														
M 135 i	Petrol	240	03/15->	N55 B30 A										
Engine	Information				A10	A20	A40	A50	A70	C10 - C30	C20	E01		
All engines	x 6, DELPHI, COIL ON PLUG									1.970.475	C10			
ENGINE														
M 135 i xDrive	Petrol	235	02/12->	N55 B30 A										
Engine	Information				A10	A20	A40	A50	A70	C10 - C30	C20	E01		
All engines	x 6, DELPHI, COIL ON PLUG									1.970.475	C10			
ENGINE														
M 135 i xDrive	Petrol	240	03/15->	N55 B30 A										
Engine	Information				A10	A20	A40	A50	A70	C10 - C30	C20	E01		
All engines	x 6, DELPHI, COIL ON PLUG									1.970.475	C10			
ENGINE														
M 140 i	Petrol	250	10/15->	B58 B30 A										
Engine	Information				A10	A20	A40	A50	A70	C10 - C30	C20	E01		
All engines	x 6, COIL ON PLUG									1.970.632	C10			
ENGINE														
M 140 i xDrive	Petrol	250	09/15->	B58 B30 A										
Engine	Information				A10	A20	A40	A50	A70	C10 - C30	C20	E01		
All engines	x 6, COIL ON PLUG									1.970.632	C10			
1 III														
ENGINE														
116 i	Petrol	80	11/20->	B38 A15 A										
Engine	Information				A10	A20	A40	A50	A70	C10 - C30	C20	E01		
All engines	x 3, COIL ON PLUG									1.970.632	C10			
ENGINE														
118 i	Petrol	100	11/20->	B38 A15 A										
Engine	Information				A10	A20	A40	A50	A70	C10 - C30	C20	E01		
All engines	x 3, COIL ON PLUG									1.970.632	C10			
ENGINE														
118 i	Petrol	103	07/19->	B38 A15 A										
Engine	Information				A10	A20	A40	A50	A70	C10 - C30	C20	E01		
All engines	x 3, COIL ON PLUG									1.970.632	C10			
ENGINE														
120 i	Petrol	131	11/20->	B48 A20 A, B48 A20 F										
Engine	Information				A10	A20	A40	A50	A70	C10 - C30	C20	E01		
All engines	x 4, COIL ON PLUG									1.970.632	C10			
ENGINE														
128 ti	Petrol	180	11/20->	B48 A20 B										
Engine	Information				A10	A20	A40	A50	A70	C10 - C30	C20	E01		
All engines	x 4, COIL ON PLUG									1.970.632	C10			
ENGINE														
128 ti	Petrol	195	11/20->	B48 A20 E										
Engine	Information				A10	A20	A40	A50	A70	C10 - C30	C20	E01		
All engines	x 4, COIL ON PLUG									1.970.632	C10			

A10 CONDENSER	A20 CONTACT SET	A40 DISTRIBUTOR CAP	A50 ROTOR	A70 PICK-UP
C10 COIL	C20 IGNITION MODULE	C30 ELECTRONIC IGNITION KIT	E01 IGNITION CABLE SET	

The present application list is a brief version. For the detailed information about the possibility of installation on a specific vehicle, please refer to our web-catalogue <http://catalogo.facet.eu/>









					FUNCTIONS ON THE VEHICLE							
Vehicle	alim.	kW	Date	Engine	 A10	 A20	 A40	 A50	 A70	 C10 - C30	 C20	 E01
M 135 i xDrive												
Petrol 225 07/19-> ENGINE B48 A20 E												
Engine		Information			A10	A20	A40	A50	A70	C10 - C30	C20	E01
All engines		x 4, COIL ON PLUG								1.970.632	C10	
1500-2000												
1600												
Petrol 61 04/64-04/68 ENGINE M10 B16 (16A)												
Engine		Information			A10	A20	A40	A50	A70	C10 - C30	C20	E01
All engines						1.206.029HV						
1800												
Petrol 66 08/63-09/69 ENGINE M118												
Engine		Information			A10	A20	A40	A50	A70	C10 - C30	C20	E01
All engines						1.206.029HV						
1800 Ti												
Petrol 81 10/63-04/68 ENGINE M118												
Engine		Information			A10	A20	A40	A50	A70	C10 - C30	C20	E01
All engines						1.206.029HV						
1800 Ti												
Petrol 96 10/63-04/68 ENGINE M118												
Engine		Information			A10	A20	A40	A50	A70	C10 - C30	C20	E01
All engines						1.206.029HV						
2000												
Petrol 74 09/68-07/72 ENGINE 18F209												
Engine		Information			A10	A20	A40	A50	A70	C10 - C30	C20	E01
All engines								1.406.018R				
2000 Ti/Tilux												
Petrol 88 01/66-07/72 ENGINE 18F209												
Engine		Information			A10	A20	A40	A50	A70	C10 - C30	C20	E01
All engines						1.206.029HV						
1502-2002												
1600 Ti												
Petrol 77 09/67-11/69 ENGINE M10 B16 (16A)												
Engine		Information			A10	A20	A40	A50	A70	C10 - C30	C20	E01
All engines						1.206.029HV						
1602												
Petrol 63 04/71-07/75 ENGINE M10 B16 A												
Engine		Information			A10	A20	A40	A50	A70	C10 - C30	C20	E01
All engines							1.306.062					
2002												
Petrol 74 02/68-07/75 ENGINE 18F209, M10 B20 A												
Engine		Information			A10	A20	A40	A50	A70	C10 - C30	C20	E01
All engines						1.206.029HV						
Eng. M10 B20 A							1.406.018R					
2002 Ti												
Petrol 88 06/68-04/72 ENGINE 18F209												
Engine		Information			A10	A20	A40	A50	A70	C10 - C30	C20	E01
All engines						1.206.029HV						
2002 Tii												
Petrol 96 01/71-07/75 ENGINE 18F209, M10 B20 (23EA)												
Engine		Information			A10	A20	A40	A50	A70	C10 - C30	C20	E01
All engines						1.206.029HV						
1600 GT												
1.6												
Petrol 77 10/67-05/69 ENGINE M10 B16 (16A)												
Engine		Information			A10	A20	A40	A50	A70	C10 - C30	C20	E01
All engines						1.206.029HV						
2												
216 i												
Petrol 75 09/14-02/18 ENGINE B38 A15 A												
Engine		Information			A10	A20	A40	A50	A70	C10 - C30	C20	E01
All engines		x 3, COIL ON PLUG								1.970.632	C10	

A10 CONDENSER	A20 CONTACT SET	A40 DISTRIBUTOR CAP	A50 ROTOR	A70 PICK-UP
C10 COIL	C20 IGNITION MODULE	C30 ELECTRONIC IGNITION KIT	E01 IGNITION CABLE SET	

Vehicle	alim.	kW	Date	Engine	FUNCTIONS ON THE VEHICLE									
					A10	A20	A40	A50	A70	C10 - C30	C20	E01		
ENGINE														
216 i	Petrol	80	03/18->	B38 A15 A										
ENGINE														
All engines					x 3, COIL ON PLUG						1.970.632	C10		
ENGINE														
218 i	Petrol	100	07/14->	B38 A15 A, B38 B15 A										
ENGINE														
All engines					x 3, COIL ON PLUG						1.970.632	C10		
ENGINE														
218 i	Petrol	103	04/17->	B38 A15 A										
ENGINE														
All engines					x 3, COIL ON PLUG						1.970.632	C10		
ENGINE														
220 i	Petrol	120	03/14->	B48 A20 A										
ENGINE														
All engines					x 4, COIL ON PLUG						1.970.632	C10		
ENGINE														
220 i	Petrol	131	11/20->	B48 A20 A, B48 A20 F										
ENGINE														
All engines					x 4, COIL ON PLUG						1.970.632	C10		
ENGINE														
220 i	Petrol	135	10/13->	B48 B20 A, N20 B20 A, N20 B20 B										
ENGINE														
Eng. N20 B20 A, N20 B20 B					x 4, DELPHI, COIL ON PLUG						1.970.475	C10		
Eng. B48 B20 A					x 4, COIL ON PLUG						1.970.632	C10		
ENGINE														
220 i	Petrol	141	03/14->	B48 A20 A, B48 A20 F										
ENGINE														
All engines					x 4, COIL ON PLUG						1.970.632	C10		
ENGINE														
220 i xDrive	Petrol	131	03/21->	B48 A20 A										
ENGINE														
All engines					x 4, COIL ON PLUG						1.970.632	C10		
ENGINE														
225 i	Petrol	170	11/13->	B48 A20 B										
ENGINE														
All engines					x 4, COIL ON PLUG						1.970.632	C10		
ENGINE														
225 i xDrive	Petrol	170	03/14->	B48 A20 B										
ENGINE														
All engines					x 4, COIL ON PLUG						1.970.632	C10		
ENGINE														
225 xe Plug-in-Hybrid	Petrol/ Electric	100	11/14->	B38 A15 A										
ENGINE														
All engines					x 3, COIL ON PLUG						1.970.632	C10		
ENGINE														
225 xe Plug-in-Hybrid	Petrol/ Electric	162	11/20->	B38 A15 A										
ENGINE														
All engines					x 3, COIL ON PLUG						1.970.632	C10		
ENGINE														
225 xe Plug-in-Hybrid	Petrol/ Electric	165	11/14->	B38 A15 A										
ENGINE														
All engines					x 3, COIL ON PLUG						1.970.632	C10		
ENGINE														
225 xe Plug-in-Hybrid	Petrol/ Electric	92	11/20->	B38 A15 A										
ENGINE														
All engines					x 3, COIL ON PLUG						1.970.632	C10		

A10 CONDENSER	A20 CONTACT SET	A40 DISTRIBUTOR CAP	A50 ROTOR	A70 PICK-UP
C10 COIL	C20 IGNITION MODULE	C30 ELECTRONIC IGNITION KIT	E01 IGNITION CABLE SET	

The present application list is a brief version. For the detailed information about the possibility of installation on a specific vehicle, please refer to our web-catalogue <http://catalogo.facet.eu/>





					FUNCTIONS ON THE VEHICLE							
Vehicle	alim.	kW	Date	Engine	 A10	 A20	 A40	 A50	 A70	 C10 - C30	 C20	 E01
228 i												
Petrol 180 07/14->												
ENGINE												
N20 B20 A												
Engine	Information				A10	A20	A40	A50	A70	C10 - C30	C20	E01
All engines	x 4, DELPHI, COIL ON PLUG									1.970.475	C10	
230 i												
Petrol 185 07/16->												
ENGINE												
B48 B20 B												
Engine	Information				A10	A20	A40	A50	A70	C10 - C30	C20	E01
All engines	x 4, COIL ON PLUG									1.970.632	C10	
M 235 i												
Petrol 240 10/13->												
ENGINE												
N55 B30 A												
Engine	Information				A10	A20	A40	A50	A70	C10 - C30	C20	E01
All engines	x 6, DELPHI, COIL ON PLUG									1.970.475	C10	
M 235 i xDrive												
Petrol 225 11/19->												
ENGINE												
B48 A20 E												
Engine	Information				A10	A20	A40	A50	A70	C10 - C30	C20	E01
All engines	x 4, COIL ON PLUG									1.970.632	C10	
M 235 i xDrive												
Petrol 240 07/14->												
ENGINE												
N55 B30 A												
Engine	Information				A10	A20	A40	A50	A70	C10 - C30	C20	E01
All engines	x 6, DELPHI, COIL ON PLUG									1.970.475	C10	
M 240 i												
Petrol 250 09/15->												
ENGINE												
B58 B30 A												
Engine	Information				A10	A20	A40	A50	A70	C10 - C30	C20	E01
All engines	x 6, COIL ON PLUG									1.970.632	C10	
M 240 i xDrive												
Petrol 250 09/15->												
ENGINE												
B58 B30 A												
Engine	Information				A10	A20	A40	A50	A70	C10 - C30	C20	E01
All engines	x 6, COIL ON PLUG									1.970.632	C10	
M2												
Petrol 272 11/15-06/18												
ENGINE												
N55 B30 A												
Engine	Information				A10	A20	A40	A50	A70	C10 - C30	C20	E01
All engines	x 6, DELPHI, COIL ON PLUG									1.970.475	C10	
M2 Competition												
Petrol 302 06/18->												
ENGINE												
S55 B30 A												
Engine	Information				A10	A20	A40	A50	A70	C10 - C30	C20	E01
All engines	x 6, DELPHI, COIL ON PLUG									1.970.475	C10	
M2 CS												
Petrol 331 11/19->												
ENGINE												
S55 B30 A												
Engine	Information				A10	A20	A40	A50	A70	C10 - C30	C20	E01
All engines	x 6, DELPHI, COIL ON PLUG									1.970.475	C10	
2000												
CS												
Petrol 88 10/65-06/70												
ENGINE												
18F209												
Engine	Information				A10	A20	A40	A50	A70	C10 - C30	C20	E01
All engines						1.206.029HV						
2500-3.3												
3.0 S												
Petrol 132 05/71-04/77												
ENGINE												
M30 B30												
Engine	Information				A10	A20	A40	A50	A70	C10 - C30	C20	E01
All engines						1.206.062						
3 I												
315												
Petrol 55 03/81-03/84												
ENGINE												
M10 B16 (164VB)												
Engine	Information				A10	A20	A40	A50	A70	C10 - C30	C20	E01
All engines	version Bosch						1.306.094	1.406.115R				
All engines											1.965.005	
320 i												
Petrol 92 06/75-08/82												
ENGINE												
18F209												
Engine	Information				A10	A20	A40	A50	A70	C10 - C30	C20	E01
All engines						1.206.062						

A10 CONDENSER	A20 CONTACT SET	A40 DISTRIBUTOR CAP	A50 ROTOR	A70 PICK-UP
C10 COIL	C20 IGNITION MODULE	C30 ELECTRONIC IGNITION KIT	E01 IGNITION CABLE SET	

Vehicle	alim.	kW	Date	Engine	FUNCTIONS ON THE VEHICLE									
					A10	A20	A40	A50	A70	C10 - C30	C20	E01		
3 II														
316	Petrol	66	09/83-06/88	ENGINE M10 B18 (184VC), M10 B18 (184VD)										
Engine	Information													
All engines	version Bosch					1.306.094	1.406.115R							
All engines	->year 30/09/83											1.965.005		
All engines	without marten protection													1.500.572
316 i	Petrol	73	09/87-06/94	ENGINE M40 B16 (164E1)										
Engine	Information													
All engines	version Bosch					1.306.247	1.406.119R							
All engines	without marten protection													1.500.573
316 i	Petrol	75	08/87-06/94	ENGINE M10 B18 (184KA), M40 B16 (164E1)										
Engine	Information													
Eng. M10 B18 (184KA)	version Bosch					1.306.094	1.406.055R							
Eng. M40 B16 (164E1)	version Bosch					1.306.247	1.406.119R							
Eng. M10 B18 (184KA)	without marten protection													1.500.572
Eng. M40 B16 (164E1)	without marten protection													1.500.573
318 i	Petrol	75	12/84-08/88	ENGINE M10 B18 (184KA)										
Engine	Information													
All engines	version Bosch					1.306.094	1.406.055R, 1.406.115R							
All engines	without marten protection													1.500.572
318 i	Petrol	77	09/82-08/87	ENGINE M10 B18 (184EA)										
Engine	Information													
All engines	version Bosch					1.306.094	1.406.055R, 1.406.115R							
All engines	without marten protection													1.500.572
318 i	Petrol	83	06/87-06/94	ENGINE M40 B18 (184E1)										
Engine	Information													
All engines	version Bosch					1.306.247	1.406.119R							
All engines	without marten protection													1.500.573
318 i	Petrol	85	09/87-06/91	ENGINE M40 B18 (184E1)										
Engine	Information													
All engines	version Bosch					1.306.247	1.406.119R							
All engines	without marten protection													1.500.573
318 is	Petrol	100	09/89-08/91	ENGINE M42 B18 (184S1)										
Engine	Information													
All engines	Qty: 4									1.970.1625	C10			
320 i	Petrol	110	12/85-06/90	ENGINE M20 B20 (206KA)										
Engine	Information													
All engines	version Bosch					1.306.238	1.406.119R							
All engines	+automatic transmission													1.500.587
All engines	+manual transmission													1.500.597
320 i	Petrol	92	09/82-12/91	ENGINE M20 B20 (206EB)										
Engine	Information													
All engines	version Bosch					1.306.238	1.406.119R							
All engines	+automatic transmission													1.500.587
All engines	+manual transmission													1.500.597
320 i	Petrol	93	07/87-10/93	ENGINE M20 B20 (206KA)										
Engine	Information													
All engines	version Bosch					1.306.238	1.406.119R							

A10	CONDENSER	A20	CONTACT SET	A40	DISTRIBUTOR CAP	A50	ROTOR	A70	PICK-UP
C10	COIL	C20	IGNITION MODULE	C30	ELECTRONIC IGNITION KIT	E01	IGNITION CABLE SET		

The present application list is a brief version. For the detailed information about the possibility of installation on a specific vehicle, please refer to our web-catalogue <http://catalogo.facet.eu/>









					FUNCTIONS ON THE VEHICLE							
Vehicle	alim.	kW	Date	Engine	 A10	 A20	 A40	 A50	 A70	 C10 - C30	 C20	 E01
ENGINE												
320 i	Petrol	93	07/87-10/93	M20 B20 (206KA)								
Engine	Information				A10	A20	A40	A50	A70	C10 - C30	C20	E01
All engines	+automatic transmission											1.500.587
All engines	+manual transmission											1.500.597
ENGINE												
320 i	Petrol	95	05/86-11/93	M20 B20 (206KA)								
Engine	Information				A10	A20	A40	A50	A70	C10 - C30	C20	E01
All engines	version Bosch						1.306.238	1.406.119R				
All engines	+automatic transmission											1.500.587
All engines	+manual transmission											1.500.597
ENGINE												
323 i	Petrol	102	09/82-08/83	M20 B23 (236EC)								
Engine	Information				A10	A20	A40	A50	A70	C10 - C30	C20	E01
All engines	version Bosch						1.306.121	1.406.060R, 1.406.112R				
All engines	->year 30/09/84										1.965.005	
ENGINE												
323 i	Petrol	110	09/83-09/86	M20 B23 (236EC)								
Engine	Information				A10	A20	A40	A50	A70	C10 - C30	C20	E01
All engines	version Bosch						1.306.121	1.406.060R, 1.406.112R				
All engines	->year 30/09/84										1.965.005	
ENGINE												
325 e 2.7	Petrol	90	10/83-12/88	M20 B27 (276KA), M20 B27 (276KB)								
Engine	Information				A10	A20	A40	A50	A70	C10 - C30	C20	E01
All engines	version Bosch						1.306.238	1.406.119R				
ENGINE												
325 e 2.7	Petrol	95	01/85-08/87	M20 B27 (276KB)								
Engine	Information				A10	A20	A40	A50	A70	C10 - C30	C20	E01
All engines	version Bosch						1.306.238	1.406.119R				
ENGINE												
325 i	Petrol	125	12/86-11/93	M20 B25 (256E1), M20 B25 (256E2), M20 B25 (256EX), M20 B25 (256K1)								
Engine	Information				A10	A20	A40	A50	A70	C10 - C30	C20	E01
All engines	version Bosch						1.306.238	1.406.119R				
All engines	+automatic transmission, 01/10/87 ->											1.500.587
All engines	->year 30/09/87											1.500.597
ENGINE												
325 i	Petrol	126	09/83-11/89	M20 B25 (256E2)								
Engine	Information				A10	A20	A40	A50	A70	C10 - C30	C20	E01
All engines	version Bosch						1.306.238	1.406.119R				
All engines	+automatic transmission, 01/10/87 ->											1.500.587
All engines	->year 30/09/87											1.500.597
ENGINE												
325 i X	Petrol	125	09/86-10/93	M20 B25 (256E1), M20 B25 (256E2), M20 B25 (256EX), M20 B25 (256K1)								
Engine	Information				A10	A20	A40	A50	A70	C10 - C30	C20	E01
All engines	version Bosch						1.306.238	1.406.119R				
ENGINE												
325 i X	Petrol	126	03/86-12/87	M20 B25 (256E1), M20 B25 (256E2), M20 B25 (256EX), M20 B25 (256K1)								
Engine	Information				A10	A20	A40	A50	A70	C10 - C30	C20	E01
All engines	version Bosch						1.306.238	1.406.119R				

A10 CONDENSER	A20 CONTACT SET	A40 DISTRIBUTOR CAP	A50 ROTOR	A70 PICK-UP
C10 COIL	C20 IGNITION MODULE	C30 ELECTRONIC IGNITION KIT	E01 IGNITION CABLE SET	

Vehicle	alim.	kW	Date	Engine	FUNCTIONS ON THE VEHICLE							
					A10	A20	A40	A50	A70	C10 - C30	C20	E01
3 III												
316 g	Petrol/ Com- pressed Natural Gas (CNG)	75	02/96-08/00	M43 B16 (164E2)								
Engine	Information				A10	A20	A40	A50	A70	C10 - C30	C20	E01
All engines	without marten protection											1.500.900
316 i	Petrol	73	03/91-08/93	M40 B16 (164E1)								
Engine	Information				A10	A20	A40	A50	A70	C10 - C30	C20	E01
All engines	version Bosch						1.306.247	1.406.119R				
All engines	E36, without marten protection											1.500.605
316 i	Petrol	75	09/90-08/00	M43 B16 (164E2)								
Engine	Information				A10	A20	A40	A50	A70	C10 - C30	C20	E01
All engines	version Bosch						1.306.247	1.406.119R				
All engines	E36, without marten protection											1.500.605
All engines	without marten protection											1.500.900
316 i	Petrol	77	01/99-08/00	M43 B19 (194E1)								
Engine	Information				A10	A20	A40	A50	A70	C10 - C30	C20	E01
All engines	without marten protection											1.500.900
318 i	Petrol	83	09/90-08/93	M40 B18 (184E1)								
Engine	Information				A10	A20	A40	A50	A70	C10 - C30	C20	E01
All engines	version Bosch						1.306.247	1.406.119R				
All engines	E36, without marten protection											1.500.605
318 i	Petrol	85	09/93-11/99	M43 B18 (184E2)								
Engine	Information				A10	A20	A40	A50	A70	C10 - C30	C20	E01
All engines	without marten protection											1.500.900
318 is	Petrol	103	01/92-04/99	M42 B18 (184S1), M44 B19 (194S1)								
Engine	Information				A10	A20	A40	A50	A70	C10 - C30	C20	E01
Eng. M42 B18 (184S1)	->year 30/09/93, Qty: 4									1.970.1625	C10	
All engines	01/10/93 ->											1.501.921
318 ti	Petrol	103	09/94-08/99	M42 B18 (184S1), M44 B19 (194S1)								
Engine	Information				A10	A20	A40	A50	A70	C10 - C30	C20	E01
All engines												1.501.921
320 i	Petrol	110	01/91-11/99	M50 B20 (206S1), M50 B20 (206S2), M52 B20 (206S3)								
Engine	Information				A10	A20	A40	A50	A70	C10 - C30	C20	E01
All engines	without spark plug connector, Qty: 6									1.970.1625	C10	
All engines	+automatic transmission, RHD, without spark plug connector, Qty: 6									1.970.352	C10	
All engines	incl. spark plug connector, Qty: 6									1.970.412	C10	
All engines	+automatic transmission, RHD, incl. spark plug connector, Qty: 6									1.970.413	C10	
320 i	Petrol	135	11/19->	B46 B20 B, B48 B20 A								
Engine	Information				A10	A20	A40	A50	A70	C10 - C30	C20	E01
All engines	x 4, COIL ON PLUG									1.970.632	C10	
323 i	Petrol	125	05/95-11/99	M52 B25 (256S3)								
Engine	Information				A10	A20	A40	A50	A70	C10 - C30	C20	E01
All engines	without spark plug connector, Qty: 6									1.970.352	C10	
All engines	incl. spark plug connector, Qty: 6									1.970.413	C10	









A10 CONDENSER	A20 CONTACT SET	A40 DISTRIBUTOR CAP	A50 ROTOR	A70 PICK-UP
C10 COIL	C20 IGNITION MODULE	C30 ELECTRONIC IGNITION KIT	E01 IGNITION CABLE SET	

The present application list is a brief version. For the detailed information about the possibility of installation on a specific vehicle, please refer to our web-catalogue <http://catalogo.facet.eu/>

					FUNCTIONS ON THE VEHICLE							
Vehicle	alim.	kW	Date	Engine	 A10	 A20	 A40	 A50	 A70	 C10 - C30	 C20	 E01
ENGINE												
323 ti	Petrol	120	01/99-08/00	M52 B25 (256S3)								
Engine	Information				A10	A20	A40	A50	A70	C10 - C30	C20	E01
All engines	without spark plug connector, Qty: 6									1.970.352	C10	
All engines	incl. spark plug connector, Qty: 6									1.970.413	C10	
ENGINE												
323 ti	Petrol	125	09/97-08/00	M52 B25 (256S3)								
Engine	Information				A10	A20	A40	A50	A70	C10 - C30	C20	E01
All engines	without spark plug connector, Qty: 6									1.970.352	C10	
All engines	incl. spark plug connector, Qty: 6									1.970.413	C10	
ENGINE												
325 i	Petrol	141	09/90-12/95	M50 B25 (256S1), M50 B25 (256S2)								
Engine	Information				A10	A20	A40	A50	A70	C10 - C30	C20	E01
All engines	without spark plug connector, Qty: 6									1.970.1625	C10	
All engines	incl. spark plug connector, Qty: 6									1.970.412	C10	
ENGINE												
328 i	Petrol	142	01/95-11/99	M52 B28 (286S1)								
Engine	Information				A10	A20	A40	A50	A70	C10 - C30	C20	E01
All engines	without spark plug connector, Qty: 6									1.970.352	C10	
All engines	incl. spark plug connector, Qty: 6									1.970.413	C10	
ENGINE												
330 i	Petrol	190	07/19->	B48 B20 B								
Engine	Information				A10	A20	A40	A50	A70	C10 - C30	C20	E01
All engines	x 4, COIL ON PLUG									1.970.632	C10	
ENGINE												
M 340 i xDrive	Petrol	275	11/19->	B58 B30 B								
Engine	Information				A10	A20	A40	A50	A70	C10 - C30	C20	E01
All engines	x 6, COIL ON PLUG									1.970.632	C10	
ENGINE												
M3 3.0	Petrol	210	11/92-07/95	S50 B30 (306S1)								
Engine	Information				A10	A20	A40	A50	A70	C10 - C30	C20	E01
All engines	without spark plug connector, Qty: 6									1.970.1625	C10	
All engines	incl. spark plug connector, Qty: 6									1.970.412	C10	
ENGINE												
M3 3.0	Petrol	217	09/93-05/95	S50 B30 (306S1)								
Engine	Information				A10	A20	A40	A50	A70	C10 - C30	C20	E01
All engines	without spark plug connector, Qty: 6									1.970.1625	C10	
All engines	incl. spark plug connector, Qty: 6									1.970.412	C10	
ENGINE												
M3 3.2	Petrol	236	10/95-09/99	S50 B32 (326S1)								
Engine	Information				A10	A20	A40	A50	A70	C10 - C30	C20	E01
All engines	without spark plug connector, Qty: 6									1.970.352	C10	
All engines	incl. spark plug connector, Qty: 6									1.970.413	C10	
3 IV												
ENGINE												
316 Ci	Petrol	77	04/00-07/06	M43 B16 (164E3)								
Engine	Information				A10	A20	A40	A50	A70	C10 - C30	C20	E01
All engines												1.499.069
ENGINE												
316 Ci	Petrol	85	10/01->	N40 B16 A, N45 B16 A								
Engine	Information				A10	A20	A40	A50	A70	C10 - C30	C20	E01
Eng. N40 B16 A	Qty: 4									1.970.475	C10	
Eng. N45 B16 A	x 4, DELPHI, ELDOR, COIL ON PLUG									1.970.475	C10	
ENGINE												
316 i	Petrol	77	12/98-02/05	M43 B16 (164E3), M43 B19 (194E1)								
Engine	Information				A10	A20	A40	A50	A70	C10 - C30	C20	E01
All engines												1.499.069

A10 CONDENSER	A20 CONTACT SET	A40 DISTRIBUTOR CAP	A50 ROTOR	A70 PICK-UP
C10 COIL	C20 IGNITION MODULE	C30 ELECTRONIC IGNITION KIT	E01 IGNITION CABLE SET	

Vehicle	alim.	kW	Date	Engine	FUNCTIONS ON THE VEHICLE									
					A10	A20	A40	A50	A70	C10 - C30	C20	E01		
316 i	Petrol	85	02/02-02/05	ENGINE N40 B16 A, N42 B18 A, N45 B16 A, N46 B18 A										
Engine	Information				A10	A20	A40	A50	A70	C10 - C30	C20	E01		
All engines	01/04/03 ->, x 4, BREMI, x 4, COIL ON PLUG, DELPHI, ELDOR, x 4, COIL ON PLUG, DELPHI, COIL ON PLUG									1.970.475	C10			
Eng. N45 B16 A	Qty: 4									1.970.475	C10			
316 ti	Petrol	85	06/01-02/05	ENGINE N40 B16 A, N42 B18 A, N45 B16 A, N46 B18 A										
Engine	Information				A10	A20	A40	A50	A70	C10 - C30	C20	E01		
All engines	01/04/03 ->, x 4, BREMI, x 4, COIL ON PLUG, DELPHI, ELDOR, x 4, COIL ON PLUG, DELPHI, COIL ON PLUG									1.970.475	C10			
318 Ci	Petrol	100	12/00-08/06	ENGINE N42 B20 A, N46 B20 A										
Engine	Information				A10	A20	A40	A50	A70	C10 - C30	C20	E01		
All engines	01/04/03 ->, x 4, DELPHI, x 4, COIL ON PLUG, DELPHI, COIL ON PLUG									1.970.475	C10			
Eng. N46 B20 A	Qty: 4									1.970.475	C10			
318 Ci	Petrol	105	09/01-12/07	ENGINE N42 B20 A, N46 B20 A										
Engine	Information				A10	A20	A40	A50	A70	C10 - C30	C20	E01		
All engines	01/04/03 ->, x 4, BREMI, x 4, COIL ON PLUG, DELPHI, x 4, COIL ON PLUG, DELPHI, COIL ON PLUG									1.970.475	C10			
Eng. N46 B20 A	Qty: 4									1.970.475	C10			
318 Ci	Petrol	110	03/04-08/06	ENGINE N46 B20 A, N46 B20 B, N46 B20 C										
Engine	Information				A10	A20	A40	A50	A70	C10 - C30	C20	E01		
Eng. N46 B20 A, N46 B20 C	x 4, DELPHI, COIL ON PLUG									1.970.475	C10			
Eng. N46 B20 B	Qty: 4									1.970.475	C10			
318 Ci	Petrol	85	12/99-08/01	ENGINE M43 B19 (194E1)										
Engine	Information				A10	A20	A40	A50	A70	C10 - C30	C20	E01		
All engines													1.499.069	
318 Ci	Petrol	87	12/99-08/01	ENGINE M43 B19 (194E1)										
Engine	Information				A10	A20	A40	A50	A70	C10 - C30	C20	E01		
All engines													1.499.069	
318 i	Petrol	100	09/01-02/05	ENGINE N42 B20 A										
Engine	Information				A10	A20	A40	A50	A70	C10 - C30	C20	E01		
All engines	01/03/03 ->, x 4, DELPHI, COIL ON PLUG									1.970.475	C10			
318 i	Petrol	105	09/01-07/05	ENGINE N42 B20 A, N46 B20 A, N46 B20 C										
Engine	Information				A10	A20	A40	A50	A70	C10 - C30	C20	E01		
All engines	01/04/03 ->, x 4, BREMI, x 4, COIL ON PLUG, DELPHI, x 4, COIL ON PLUG, DELPHI, COIL ON PLUG									1.970.475	C10			
318 i	Petrol	85	10/99-09/01	ENGINE M43 B19 (194E1)										
Engine	Information				A10	A20	A40	A50	A70	C10 - C30	C20	E01		
All engines													1.499.069	
318 i	Petrol	87	12/97-09/01	ENGINE M43 B19 (194E1)										
Engine	Information				A10	A20	A40	A50	A70	C10 - C30	C20	E01		
All engines													1.499.069	
318 ti	Petrol	100	03/01-12/04	ENGINE N42 B20 A, N46 B20 A										
Engine	Information				A10	A20	A40	A50	A70	C10 - C30	C20	E01		
All engines	01/03/03 ->, x 4, DELPHI, COIL ON PLUG									1.970.475	C10			
318 ti	Petrol	105	03/01-12/04	ENGINE N42 B20 A, N46 B20 A										
Engine	Information				A10	A20	A40	A50	A70	C10 - C30	C20	E01		
All engines	01/04/03 ->, x 4, BREMI, COIL ON PLUG, x 4, DELPHI, COIL ON PLUG									1.970.475	C10			
A10	CONDENSER		A20	CONTACT SET		A40	DISTRIBUTOR CAP		A50	ROTOR		A70	PICK-UP	
C10	COIL		C20	IGNITION MODULE		C30	ELECTRONIC IGNITION KIT		E01	IGNITION CABLE SET				

					FUNCTIONS ON THE VEHICLE							
Vehicle	alim.	kW	Date	Engine	 A10	 A20	 A40	 A50	 A70	 C10 - C30	 C20	 E01
ENGINE												
320 Ci	Petrol	110	02/99-08/01	M52 B20 (206S4), M52B206S4								
Engine	Information				A10	A20	A40	A50	A70	C10 - C30	C20	E01
Eng. M52 B20 (206S4)	->year 30/09/02, without spark plug connector, Qty: 6									1.970.352	C10	
Eng. M52B206S4	x 6, BOSCH, BREMI, COIL ON PLUG, incl. spark plug connector									1.970.352	C10	
Eng. M52 B20 (206S4)	->year 30/09/02, incl. spark plug connector, Qty: 6									1.970.413	C10	
Eng. M52 B20 (206S4)	01/10/02 ->, Qty: 6									1.970.475	C10	
ENGINE												
320 Ci	Petrol	120	01/00-12/07	M54 B22 (226S1), M54B226S1								
Engine	Information				A10	A20	A40	A50	A70	C10 - C30	C20	E01
Eng. M54 B22 (226S1)	->year 30/09/02, without spark plug connector, Qty: 6									1.970.352	C10	
Eng. M54B226S1	->year 01/09/02, x 6, BREMI, COIL ON PLUG									1.970.352	C10	
Eng. M54 B22 (226S1)	->year 30/09/02, incl. spark plug connector, Qty: 6									1.970.413	C10	
Eng. M54 B22 (226S1)	01/10/02 ->, Qty: 6									1.970.475	C10	
Eng. M54B226S1	01/09/02 ->, x 6, DELPHI, COIL ON PLUG									1.970.475	C10	
	01/10/02 ->, x 6, DELPHI, COIL ON PLUG											
ENGINE												
320 Ci	Petrol	125	01/00-12/07	M54 B22 (226S1), M54B226S1								
Engine	Information				A10	A20	A40	A50	A70	C10 - C30	C20	E01
Eng. M54 B22 (226S1)	->year 30/09/02, without spark plug connector, Qty: 6									1.970.352	C10	
Eng. M54B226S1	->year 01/09/02, x 6, BOSCH, BREMI, COIL ON PLUG, incl. spark plug connector									1.970.352	C10	
Eng. M54 B22 (226S1)	->year 30/09/02, incl. spark plug connector, Qty: 6									1.970.413	C10	
Eng. M54 B22 (226S1)	01/10/02 ->, Qty: 6									1.970.475	C10	
Eng. M54B226S1	01/10/02 ->, x 6, DELPHI, COIL ON PLUG									1.970.475	C10	
ENGINE												
320 i	Petrol	110	03/98-09/00	M52 B20 (206S4), M52B206S4								
Engine	Information				A10	A20	A40	A50	A70	C10 - C30	C20	E01
Eng. M52 B20 (206S4)	->year 30/09/02, without spark plug connector, Qty: 6									1.970.352	C10	
Eng. M52B206S4	x 6, BOSCH, BREMI, COIL ON PLUG, incl. spark plug connector									1.970.352	C10	
Eng. M52 B20 (206S4)	->year 30/09/02, incl. spark plug connector, Qty: 6									1.970.413	C10	
Eng. M52 B20 (206S4)	01/10/02 ->, Qty: 6									1.970.475	C10	
Eng. M52 B20 (206S4)	01/10/02 ->, Qty: 6									1.970.475	C10	
ENGINE												
320 i	Petrol	120	09/00-02/05	4F8Q 636, M54 B22 (226S1), M54B226S1								
Engine	Information				A10	A20	A40	A50	A70	C10 - C30	C20	E01
Eng. 4F8Q 636, M54B226S1	->year 01/08/02, x 6, BREMI, COIL ON PLUG									1.970.352	C10	
Eng. M54 B22 (226S1)	->year 30/09/02, without spark plug connector, Qty: 6									1.970.352	C10	
Eng. M54 B22 (226S1)	->year 30/09/02, incl. spark plug connector, Qty: 6									1.970.413	C10	
Eng. 4F8Q 636, M54B226S1	01/09/02 ->, x 6, DELPHI, COIL ON PLUG									1.970.475	C10	
Eng. M54 B22 (226S1)	01/10/02 ->, Qty: 6									1.970.475	C10	
ENGINE												
320 i	Petrol	125	09/00-02/05	4F8Q 636, M54 B22 (226S1), M54B226S1								
Engine	Information				A10	A20	A40	A50	A70	C10 - C30	C20	E01
Eng. 4F8Q 636, M54B226S1	->year 01/09/02, x 6, BOSCH, BREMI, COIL ON PLUG, incl. spark plug connector									1.970.352	C10	
Eng. M54 B22 (226S1)	->year 30/09/02, without spark plug connector, Qty: 6									1.970.352	C10	
Eng. M54 B22 (226S1)	->year 30/09/02, incl. spark plug connector, Qty: 6									1.970.413	C10	
Eng. 4F8Q 636, M54B226S1	01/10/02 ->, x 6, DELPHI, COIL ON PLUG									1.970.475	C10	
Eng. M54 B22 (226S1)	01/10/02 ->, Qty: 6									1.970.475	C10	
ENGINE												
323 Ci	Petrol	120	04/99-09/00	8CLS, M52 B25 (256S4), M52B256S4								
Engine	Information				A10	A20	A40	A50	A70	C10 - C30	C20	E01
Eng. 8CLS, M52B256S4	x 6, BREMI, COIL ON PLUG									1.970.352	C10	
Eng. M52 B25 (256S4)	without spark plug connector, Qty: 6									1.970.352	C10	
Eng. M52 B25 (256S4)	incl. spark plug connector, Qty: 6									1.970.413	C10	

A10 CONDENSER	A20 CONTACT SET	A40 DISTRIBUTOR CAP	A50 ROTOR	A70 PICK-UP
C10 COIL	C20 IGNITION MODULE	C30 ELECTRONIC IGNITION KIT	E01 IGNITION CABLE SET	

Vehicle	alim.	kW	Date	Engine	FUNCTIONS ON THE VEHICLE									
					A10	A20	A40	A50	A70	C10 - C30	C20	E01		
ENGINE														
323 Ci	Petrol	125	04/99-09/00	01F8, M52 B25 (256S4), M52B256S4										
Engine	Information				A10	A20	A40	A50	A70		C10 - C30	C20	E01	
Eng. 01F8, M52B256S4	x 6, BOSCH, BREMI, COIL ON PLUG, incl. spark plug connector										1.970.352	C10		
Eng. M52 B25 (256S4)	without spark plug connector, Qty: 6										1.970.352	C10		
Eng. M52 B25 (256S4)	incl. spark plug connector, Qty: 6										1.970.413	C10		
ENGINE														
323 i	Petrol	120	03/98-09/00	M52 B25 (256S4), M52B256S4										
Engine	Information				A10	A20	A40	A50	A70		C10 - C30	C20	E01	
Eng. M52 B25 (256S4)	without spark plug connector, Qty: 6										1.970.352	C10		
Eng. M52B256S4	x 6, BREMI, COIL ON PLUG										1.970.352	C10		
Eng. M52 B25 (256S4)	incl. spark plug connector, Qty: 6										1.970.413	C10		
ENGINE														
323 i	Petrol	125	03/98-09/00	M52 B25 (256S4), M52B256S4										
Engine	Information				A10	A20	A40	A50	A70		C10 - C30	C20	E01	
Eng. M52 B25 (256S4)	without spark plug connector, Qty: 6										1.970.352	C10		
Eng. M52B256S4	x 6, BOSCH, BREMI, COIL ON PLUG, incl. spark plug connector										1.970.352	C10		
Eng. M52 B25 (256S4)	incl. spark plug connector, Qty: 6										1.970.413	C10		
ENGINE														
323 i	Petrol	135	03/99-12/03	- (24 6 S3)										
Engine	Information				A10	A20	A40	A50	A70		C10 - C30	C20	E01	
All engines	without spark plug connector, Qty: 6										1.970.352	C10		
All engines	incl. spark plug connector, Qty: 6										1.970.413	C10		
ENGINE														
325 Ci	Petrol	137	01/01->	M56256S6										
Engine	Information				A10	A20	A40	A50	A70		C10 - C30	C20	E01	
All engines	->year 30/09/02, without spark plug connector, Qty: 6										1.970.352	C10		
All engines	->year 30/09/02, incl. spark plug connector, Qty: 6										1.970.413	C10		
All engines	01/10/02 ->, Qty: 6										1.970.475	C10		
ENGINE														
325 Ci	Petrol	141	09/00-08/06	4CSS, M54 B25 (256S5), M54B256S5										
Engine	Information				A10	A20	A40	A50	A70		C10 - C30	C20	E01	
Eng. 4CSS, M54B256S5	x 6, BOSCH, BREMI, COIL ON PLUG, incl. spark plug connector										1.970.352	C10		
Eng. M54 B25 (256S5)	->year 30/09/02, without spark plug connector, Qty: 6										1.970.352	C10		
Eng. M54 B25 (256S5)	->year 30/09/02, incl. spark plug connector, Qty: 6										1.970.413	C10		
Eng. 4CSS, M54B256S5	01/10/02 ->, x 6, DELPHI, COIL ON PLUG										1.970.475	C10		
Eng. M54 B25 (256S5)	01/10/02 ->, Qty: 6										1.970.475	C10		
ENGINE														
325 i	Petrol	137	01/01->	M56256S6										
Engine	Information				A10	A20	A40	A50	A70		C10 - C30	C20	E01	
All engines	->year 30/09/02, without spark plug connector, Qty: 6										1.970.352	C10		
All engines	->year 30/09/02, incl. spark plug connector, Qty: 6										1.970.413	C10		
All engines	01/10/02 ->, Qty: 6										1.970.475	C10		
ENGINE														
325 i	Petrol	141	09/00->	-(24 6 S4), M54 B25 (256S5), M54B256S5										
Engine	Information				A10	A20	A40	A50	A70		C10 - C30	C20	E01	
Eng. -(24 6 S4), M54 B25 (256S5)	->year 30/09/02, without spark plug connector, Qty: 6										1.970.352	C10		
Eng. M54B256S5	->year 01/09/02, x 6, BREMI, COIL ON PLUG										1.970.352	C10		
Eng. -(24 6 S4), M54 B25 (256S5)	->year 30/09/02, incl. spark plug connector, Qty: 6										1.970.413	C10		
Eng. -(24 6 S4), M54 B25 (256S5)	01/10/02 ->, Qty: 6										1.970.475	C10		
Eng. M54B256S5	01/10/02 ->, x 6, DELPHI, COIL ON PLUG										1.970.475	C10		
ENGINE														
325 ti	Petrol	141	04/01-12/04	M54 B25 (256S5), M54B256S5										
Engine	Information				A10	A20	A40	A50	A70		C10 - C30	C20	E01	
Eng. M54 B25 (256S5)	->year 30/09/02, without spark plug connector, Qty: 6										1.970.352	C10		

A10	CONDENSER	A20	CONTACT SET	A40	DISTRIBUTOR CAP	A50	ROTOR	A70	PICK-UP
C10	COIL	C20	IGNITION MODULE	C30	ELECTRONIC IGNITION KIT	E01	IGNITION CABLE SET		

The present application list is a brief version. For the detailed information about the possibility of installation on a specific vehicle, please refer to our web-catalogue <http://catalogo.facet.eu/>

FUNCTIONS ON THE VEHICLE

Vehicle	alim.	kW	Date	Engine	 A10	 A20	 A40	 A50	 A70	 C10 - C30	 C20	 E01
---------	-------	----	------	--------	---	---	---	--	---	---	---	---

ENGINE				
325 ti	Petrol	141	04/01-12/04	M54 B25 (256S5), M54B256S5

Engine	Information	A10	A20	A40	A50	A70	C10 - C30	C20	E01
Eng. M54B256S5	x 6, BOSCH, BREMI, COIL ON PLUG, incl. spark plug connector						1.970.352	C10	
Eng. M54 B25 (256S5)	->year 30/09/02, incl. spark plug connector, Qty: 6						1.970.413	C10	
Eng. M54 B25 (256S5)	01/10/02 ->, Qty: 6						1.970.475	C10	
Eng. M54B256S5	01/10/02 ->, x 6, DELPHI, COIL ON PLUG						1.970.475	C10	

ENGINE				
325 xi	Petrol	141	09/00-02/05	M54 B25 (256S5), M54B256S5

Engine	Information	A10	A20	A40	A50	A70	C10 - C30	C20	E01
Eng. M54 B25 (256S5)	->year 30/09/02, without spark plug connector, Qty: 6						1.970.352	C10	
Eng. M54B256S5	->year 01/09/02, x 6, BREMI, COIL ON PLUG						1.970.352	C10	
Eng. M54 B25 (256S5)	->year 30/09/02, incl. spark plug connector, Qty: 6						1.970.413	C10	
Eng. M54 B25 (256S5)	01/10/02 ->, Qty: 6						1.970.475	C10	
Eng. M54B256S5	01/10/02 ->, x 6, DELPHI, COIL ON PLUG						1.970.475	C10	

ENGINE				
328 Ci	Petrol	142	12/98-05/00	M52 B28 (286S2), M52B286S2

Engine	Information	A10	A20	A40	A50	A70	C10 - C30	C20	E01
Eng. M52 B28 (286S2)	without spark plug connector, Qty: 6						1.970.352	C10	
Eng. M52B286S2	x 6, BOSCH, BREMI, COIL ON PLUG, incl. spark plug connector						1.970.352	C10	
Eng. M52 B28 (286S2)	incl. spark plug connector, Qty: 6						1.970.413	C10	

ENGINE				
328 i	Petrol	142	02/98-06/00	1LGX, M52 B28 (286S2), M52B286S2

Engine	Information	A10	A20	A40	A50	A70	C10 - C30	C20	E01
Eng. 1LGX, M52B286S2	x 6, BOSCH, BREMI, COIL ON PLUG, incl. spark plug connector						1.970.352	C10	
Eng. M52 B28 (286S2)	without spark plug connector, Qty: 6						1.970.352	C10	
Eng. M52 B28 (286S2)	incl. spark plug connector, Qty: 6						1.970.413	C10	

ENGINE				
330 Ci	Petrol	170	06/00-08/06	7ACR, M54 B30 (306S3), M54B306S3

Engine	Information	A10	A20	A40	A50	A70	C10 - C30	C20	E01
Eng. 7ACR, M54B306S3	x 6, BOSCH, BREMI, COIL ON PLUG, incl. spark plug connector						1.970.352	C10	
Eng. M54 B30 (306S3)	->year 30/09/02, without spark plug connector, Qty: 6						1.970.352	C10	
Eng. M54 B30 (306S3)	->year 30/09/02, incl. spark plug connector, Qty: 6						1.970.413	C10	
Eng. 7ACR, M54B306S3	01/10/02 ->, x 6, DELPHI, COIL ON PLUG						1.970.475	C10	
Eng. M54 B30 (306S3)	01/10/02 ->, Qty: 6						1.970.475	C10	

ENGINE				
330 i	Petrol	168	01/01-04/05	M54B306S3

Engine	Information	A10	A20	A40	A50	A70	C10 - C30	C20	E01
All engines	->year 01/09/02, x 6, BREMI, COIL ON PLUG						1.970.352	C10	
All engines	01/10/02 ->, x 6, DELPHI, COIL ON PLUG						1.970.475	C10	

ENGINE				
330 i	Petrol	170	06/00-02/05	M54 B30 (306S3), M54B306S3

Engine	Information	A10	A20	A40	A50	A70	C10 - C30	C20	E01
Eng. M54 B30 (306S3)	->year 30/09/02, without spark plug connector, Qty: 6						1.970.352	C10	
Eng. M54B306S3	->year 01/09/02, x 6, BREMI, COIL ON PLUG						1.970.352	C10	
Eng. M54 B30 (306S3)	->year 30/09/02, incl. spark plug connector, Qty: 6						1.970.413	C10	
Eng. M54 B30 (306S3)	01/10/02 ->, Qty: 6						1.970.475	C10	
Eng. M54B306S3	01/10/02 ->, x 6, DELPHI, COIL ON PLUG						1.970.475	C10	

ENGINE				
330 xi	Petrol	170	06/00-07/06	M54 B30 (306S3), M54B306S3









Engine	Information	A10	A20	A40	A50	A70	C10 - C30	C20	E01
Eng. M54 B30 (306S3)	->year 30/09/02, without spark plug connector, Qty: 6						1.970.352	C10	
Eng. M54B306S3	->year 01/09/02, x 6, BREMI, COIL ON PLUG						1.970.352	C10	
Eng. M54 B30 (306S3)	->year 30/09/02, incl. spark plug connector, Qty: 6						1.970.413	C10	
Eng. M54 B30 (306S3)	01/10/02 ->, Qty: 6						1.970.475	C10	
Eng. M54B306S3	01/10/02 ->, x 6, DELPHI, COIL ON PLUG						1.970.475	C10	

A10 CONDENSER	A20 CONTACT SET	A40 DISTRIBUTOR CAP	A50 ROTOR	A70 PICK-UP
C10 COIL	C20 IGNITION MODULE	C30 ELECTRONIC IGNITION KIT	E01 IGNITION CABLE SET	

Vehicle	alim.	kW	Date	Engine	FUNCTIONS ON THE VEHICLE								
					A10	A20	A40	A50	A70	C10 - C30	C20	E01	
ENGINE													
M3	Petrol	252	07/00-08/06	S54 B32 (326S4), S54B326S4									
Engine Information					A10	A20	A40	A50	A70	C10 - C30	C20	E01	
Eng. S54 B32 (326S4) Qty: 6										1.970.475	C10		
Eng. S54B326S4 x 6, BREMI, DELPHI, ELDOR, COIL ON PLUG										1.970.475	C10		
ENGINE													
M3 CSL	Petrol	265	05/03-12/03	S54 B32 (326S4), S54B326S4									
Engine Information					A10	A20	A40	A50	A70	C10 - C30	C20	E01	
Eng. S54 B32 (326S4) Qty: 6										1.970.475	C10		
Eng. S54B326S4 x 6, BREMI, DELPHI, ELDOR, COIL ON PLUG										1.970.475	C10		
3 SERIES													
ENGINE													
325i xDrive	Petrol	160	09/08-10/11	N52 B25 A									
Engine Information					A10	A20	A40	A50	A70	C10 - C30	C20	E01	
All engines x 6, DELPHI, COIL ON PLUG										1.970.475	C10		
3 V													
ENGINE													
316 i	Petrol	85	09/05-10/11	N45 B16 A									
Engine Information					A10	A20	A40	A50	A70	C10 - C30	C20	E01	
All engines x 4, DELPHI, ELDOR, COIL ON PLUG										1.970.475	C10		
ENGINE													
316 i	Petrol	90	09/07-06/13	N43 B16 A, N43 B16 AA									
Engine Information					A10	A20	A40	A50	A70	C10 - C30	C20	E01	
All engines x 4, BOSCH, COIL ON PLUG										1.970.607	C10		
ENGINE													
318 i	Petrol	100	09/07-03/12	N43 B20 A, N46 B20 B									
Engine Information					A10	A20	A40	A50	A70	C10 - C30	C20	E01	
Eng. N46 B20 B Qty: 4										1.970.475	C10		
Eng. N46 B20 B x 4, DELPHI, COIL ON PLUG										1.970.475	C10		
Eng. N43 B20 A x 4, BOSCH, COIL ON PLUG										1.970.607	C10		
ENGINE													
318 i	Petrol	105	05/07-12/13	N43 B20 A									
Engine Information					A10	A20	A40	A50	A70	C10 - C30	C20	E01	
All engines x 4, BOSCH, COIL ON PLUG										1.970.607	C10		
ENGINE													
318 i	Petrol	95	09/05-08/07	N46 B20 B									
Engine Information					A10	A20	A40	A50	A70	C10 - C30	C20	E01	
All engines x 4, DELPHI, COIL ON PLUG										1.970.475	C10		
ENGINE													
320 i	Petrol	110	12/04-06/12	N46 B20 A, N46 B20 B, N46 B20 C, N46 B20 CB									
Engine Information					A10	A20	A40	A50	A70	C10 - C30	C20	E01	
Eng. N46 B20 A Qty: 4										1.970.475	C10		
Eng. N46 B20 B, N46 B20 C, N46 B20 CB x 4, DELPHI, COIL ON PLUG										1.970.475	C10		
ENGINE													
320 i	Petrol	115	09/05-12/13	N43 B20 A, N46 B20 B, N46 B20 C									
Engine Information					A10	A20	A40	A50	A70	C10 - C30	C20	E01	
Eng. N46 B20 B, N46 B20 C x 4, DELPHI, COIL ON PLUG										1.970.475	C10		
Eng. N43 B20 A x 4, BOSCH, COIL ON PLUG										1.970.607	C10		
ENGINE													
320 i	Petrol	120	09/06-12/13	N43 B20 A									
Engine Information					A10	A20	A40	A50	A70	C10 - C30	C20	E01	
All engines x 4, BOSCH, COIL ON PLUG										1.970.607	C10		
ENGINE													
320 i	Petrol	125	02/07-12/13	N43 B20 A									
Engine Information					A10	A20	A40	A50	A70	C10 - C30	C20	E01	
All engines x 4, BOSCH, COIL ON PLUG										1.970.607	C10		

A10 CONDENSER	A20 CONTACT SET	A40 DISTRIBUTOR CAP	A50 ROTOR	A70 PICK-UP
C10 COIL	C20 IGNITION MODULE	C30 ELECTRONIC IGNITION KIT	E01 IGNITION CABLE SET	







The present application list is a brief version. For the detailed information about the possibility of installation on a specific vehicle, please refer to our web-catalogue <http://catalogo.facet.eu/>

					FUNCTIONS ON THE VEHICLE												
Vehicle	alim.	kW	Date	Engine													
ENGINE																	
320 si	Petrol	127	09/05-08/06	N45 B20 A													
ENGINE																	
All engines					x 4, DELPHI, ELDOR, COIL ON PLUG						1.970.475	C10					
ENGINE																	
323 i	Petrol	130	09/05->	N52 B25 A, N52 B25 B, N52 B25 BE, N52 B25 BF, N52B25B, N52B25BE, N52N B25 A, N52NB-25BF													
ENGINE																	
Eng. N52 B25 A, N52 B25 B, N52 B25 BE, N52 B25 BF					x 6, BOSCH, DELPHI, COIL ON PLUG						1.970.475	C10					
Eng. N52 B25 A, N52B25B, N52B25BE, N52N B25 A, N52NB25BF					Qty: 6, Qty: 6						1.970.475	C10					
ENGINE																	
323 i	Petrol	140	04/06-02/12	N52 B25 A, N52 B25 BF													
ENGINE																	
All engines					x 6, DELPHI, ELDOR, COIL ON PLUG						1.970.475	C10					
ENGINE																	
325 i	Petrol	150	05/05-10/13	N52 B25 A, N52 B25 AF, N52 B25 BF													
ENGINE																	
All engines					x 6, DELPHI, COIL ON PLUG						1.970.475	C10					
Eng. N52 B25 A					Qty: 6						1.970.475	C10					
ENGINE																	
325 i	Petrol	155	12/04-12/13	N52 B25 A, N52 B25 AF, N52 B25 BF, N53 B30 A													
ENGINE																	
Eng. N52 B25 A, N52 B25 AF, N52 B25 BF					x 6, DELPHI, x 6, BOSCH, COIL ON PLUG, DELPHI, x 6, BOSCH, COIL ON PLUG, DELPHI, COIL ON PLUG						1.970.475	C10					
Eng. N53 B30 A					x 6, DELPHI, COIL ON PLUG						1.970.607	C10					
ENGINE																	
325 i	Petrol	160	12/04->	N52 B25 A, N52 B25 AF, N52 B25 B, N52 B25 BF, N52B25B, N53 B30 A													
ENGINE																	
Eng. N52 B25 A, N52 B25 AF, N52 B25 B, N52 B25 BF					x 6, DELPHI, x 6, BOSCH, COIL ON PLUG, DELPHI, COIL ON PLUG						1.970.475	C10					
Eng. N52 B25 BF, N52B25B					Qty: 6						1.970.475	C10					
Eng. N53 B30 A					x 6, BOSCH, COIL ON PLUG						1.970.607	C10					
ENGINE																	
325 i xDrive	Petrol	150	03/10-04/13	N52 B25 A													
ENGINE																	
All engines					x 6, DELPHI, ELDOR, COIL ON PLUG						1.970.475	C10					
ENGINE																	
325 i xDrive	Petrol	155	09/08-06/13	N53 B30 A													
ENGINE																	
All engines					x 6, BOSCH, COIL ON PLUG						1.970.607	C10					
ENGINE																	
325 i xDrive	Petrol	160	09/08-12/13	N53 B30 A													
ENGINE																	
All engines					x 6, BOSCH, COIL ON PLUG						1.970.607	C10					
ENGINE																	
325 xi	Petrol	155	09/07-08/08	N53 B30 A													
ENGINE																	
All engines					x 6, BOSCH, COIL ON PLUG						1.970.607	C10					
ENGINE																	
325 xi	Petrol	160	01/05->	N52 B25 A, N52 B30 A, N53 B30 A													
ENGINE																	
Eng. N52 B25 A					x 6, DELPHI, x 6, BOSCH, COIL ON PLUG, DELPHI, COIL ON PLUG						1.970.475	C10					
Eng. N52 B30 A					x 6, BOSCH, DELPHI, COIL ON PLUG						1.970.475	C10					
Qty: 6																	
A10	CONDENSER			A20	CONTACT SET			A40	DISTRIBUTOR CAP			A50	ROTOR		A70	PICK-UP	
C10	COIL			C20	IGNITION MODULE			C30	ELECTRONIC IGNITION KIT			E01	IGNITION CABLE SET				

Vehicle	alim.	kW	Date	Engine	FUNCTIONS ON THE VEHICLE									
					A10	A20	A40	A50	A70	C10 - C30	C20	E01		
ENGINE														
325 xi	Petrol	160	01/05->	N52 B25 A, N52 B30 A, N53 B30 A										
Engine	Information				A10	A20	A40	A50	A70	C10 - C30	C20	E01		
Eng. N53 B30 A	x 6, BOSCH, COIL ON PLUG									1.970.607	C10			
ENGINE														
328 i	Petrol	172	06/06->	N51 B30 A, N52 B30 A										
Engine	Information				A10	A20	A40	A50	A70	C10 - C30	C20	E01		
All engines	Qty: 6									1.970.475	C10			
Eng. N51 B30 A	x 6, DELPHI, COIL ON PLUG									1.970.475	C10			
ENGINE														
328 i	Petrol	187	07/05-11/07	N52N B30 A										
Engine	Information				A10	A20	A40	A50	A70	C10 - C30	C20	E01		
All engines	Qty: 6									1.970.475	C10			
ENGINE														
328 xi	Petrol	172	09/06->	N51 B30 A, N52 B30 A										
Engine	Information				A10	A20	A40	A50	A70	C10 - C30	C20	E01		
All engines	Qty: 6									1.970.475	C10			
ENGINE														
330 i	Petrol	190	12/04-10/13	N52 B30 A, N52 B30 BF										
Engine	Information				A10	A20	A40	A50	A70	C10 - C30	C20	E01		
All engines	x 6, DELPHI, x 6, BOSCH, COIL ON PLUG, DELPHI, COIL ON PLUG									1.970.475	C10			
ENGINE														
330 i	Petrol	200	09/06-10/13	N52 B30 A, N52 B30 B, N52 B30 BF, N53 B30 A										
Engine	Information				A10	A20	A40	A50	A70	C10 - C30	C20	E01		
Eng. N52 B30 A, N52 B30 BF, N53 B30 A	-eng. N53B30A, x 6, DELPHI, x 6, COIL ON PLUG, DELPHI, COIL ON PLUG									1.970.475	C10			
Eng. N52 B30 B	Qty: 6									1.970.475	C10			
Eng. N52 B30 A, N52 B30 BF, N53 B30 A	x 6, BOSCH, x 6, BOSCH, COIL ON PLUG, COIL ON PLUG									1.970.607	C10			
ENGINE														
330 i xDrive	Petrol	200	09/07-06/13	N53 B30 A										
Engine	Information				A10	A20	A40	A50	A70	C10 - C30	C20	E01		
All engines	->year 01/12/08, x 6, BOSCH, x 6, BOSCH, COIL ON PLUG, COIL ON PLUG ----- 01/04/12->, x 6, BOSCH, COIL ON PLUG									1.970.607	C10			
ENGINE														
330 xi	Petrol	190	09/05-08/07	N52 B30 A										
Engine	Information				A10	A20	A40	A50	A70	C10 - C30	C20	E01		
All engines	x 6, DELPHI, x 6, BOSCH, COIL ON PLUG, DELPHI, COIL ON PLUG									1.970.475	C10			
ENGINE														
330 xi	Petrol	200	09/06-06/12	N52 B30 A, N53 B30 A										
Engine	Information				A10	A20	A40	A50	A70	C10 - C30	C20	E01		
Eng. N52 B30 A	x 6, DELPHI, ELDOR, COIL ON PLUG									1.970.475	C10			
Eng. N53 B30 A	x 6, BOSCH, x 6, BOSCH, COIL ON PLUG, COIL ON PLUG									1.970.607	C10			
ENGINE														
335 i	Petrol	220	03/06-12/11	N54 B30 A, N55 B30 A										
Engine	Information				A10	A20	A40	A50	A70	C10 - C30	C20	E01		
All engines	x 6, DELPHI, ELDOR, COIL ON PLUG									1.970.475	C10			
ENGINE														
335 i	Petrol	224	03/06-12/11	N54 B30 A, N55 B30 A										
Engine	Information				A10	A20	A40	A50	A70	C10 - C30	C20	E01		
All engines	x 6, DELPHI, ELDOR, COIL ON PLUG									1.970.475	C10			
ENGINE														
335 i	Petrol	225	06/06-10/13	N54 B30 A, N54 B30 B, N55 B30 A										
Engine	Information				A10	A20	A40	A50	A70	C10 - C30	C20	E01		
Eng. N54 B30 A, N55 B30 A	x 6, DELPHI, ELDOR, COIL ON PLUG									1.970.475	C10			
Eng. N54 B30 B	Qty: 6									1.970.475	C10			

A10 CONDENSER	A20 CONTACT SET	A40 DISTRIBUTOR CAP	A50 ROTOR	A70 PICK-UP
C10 COIL	C20 IGNITION MODULE	C30 ELECTRONIC IGNITION KIT	E01 IGNITION CABLE SET	

The present application list is a brief version. For the detailed information about the possibility of installation on a specific vehicle, please refer to our web-catalogue <http://catalogo.facet.eu/>









					FUNCTIONS ON THE VEHICLE							
Vehicle	alim.	kW	Date	Engine								
ENGINE												
335 i	Petrol	240	03/06-10/13	N54 B30 A, N55 B30 A								
ENGINE												
Engine	Information				A10	A20	A40	A50	A70	C10 - C30	C20	E01
All engines	x 6, DELPHI, ELDOR, COIL ON PLUG									1.970.475	C10	
ENGINE												
335 i xDrive	Petrol	224	05/08-06/13	N54 B30 A, N55 B30 A								
ENGINE												
Engine	Information				A10	A20	A40	A50	A70	C10 - C30	C20	E01
All engines	x 6, DELPHI, ELDOR, x 6, COIL ON PLUG, DELPHI, COIL ON PLUG									1.970.475	C10	
ENGINE												
335 i xDrive	Petrol	225	09/08-12/13	N54 B30 A, N55 B30 A								
ENGINE												
Engine	Information				A10	A20	A40	A50	A70	C10 - C30	C20	E01
All engines	x 6, DELPHI, ELDOR, COIL ON PLUG									1.970.475	C10	
ENGINE												
335 i xDrive	Petrol	240	05/08-06/13	N54 B30 A, N55 B30 A								
ENGINE												
Engine	Information				A10	A20	A40	A50	A70	C10 - C30	C20	E01
All engines	x 6, DELPHI, ELDOR, COIL ON PLUG									1.970.475	C10	
ENGINE												
335 xi	Petrol	224	09/06-06/08	N54 B30 A, N55 B30 A								
ENGINE												
Engine	Information				A10	A20	A40	A50	A70	C10 - C30	C20	E01
All engines	x 6, ELDOR, x 6, COIL ON PLUG, DELPHI, COIL ON PLUG									1.970.475	C10	
ENGINE												
335 xi	Petrol	225	03/07-02/10	N54 B30 A, N55 B30 A								
ENGINE												
Engine	Information				A10	A20	A40	A50	A70	C10 - C30	C20	E01
Eng. N54 B30 A	x 6, DELPHI, ELDOR, COIL ON PLUG									1.970.475	C10	
Eng. N55 B30 A	Qty: 6									1.970.475	C10	
ENGINE												
335 xi	Petrol	240	09/06-02/10	N54 B30 A, N55 B30 A								
ENGINE												
Engine	Information				A10	A20	A40	A50	A70	C10 - C30	C20	E01
All engines	x 6, DELPHI, ELDOR, x 6, COIL ON PLUG, DELPHI, ELDOR, COIL ON PLUG									1.970.475	C10	
3 VI												
ENGINE												
316 i	Petrol	100	07/12-08/16	N13 B16 A								
ENGINE												
Engine	Information				A10	A20	A40	A50	A70	C10 - C30	C20	E01
All engines	x 4, DELPHI, COIL ON PLUG									1.970.475	C10	
ENGINE												
316 Li [CHN]	Petrol	100	10/12->	N13 B16 A								
ENGINE												
Engine	Information				A10	A20	A40	A50	A70	C10 - C30	C20	E01
All engines	Qty: 4									1.970.475	C10	
ENGINE												
318 i	Petrol	100	07/15-06/19	B38 B15 A								
ENGINE												
Engine	Information				A10	A20	A40	A50	A70	C10 - C30	C20	E01
All engines	x 3, COIL ON PLUG									1.970.632	C10	
ENGINE												
320 i	Petrol	120	11/12->	B48 B20 A, N20 B20 A, N20 B20 B								
ENGINE												
Engine	Information				A10	A20	A40	A50	A70	C10 - C30	C20	E01
Eng. N20 B20 A, N20 B20 B	x 4, DELPHI, COIL ON PLUG									1.970.475	C10	
Eng. N20 B20 B	Qty: 4									1.970.475	C10	
Eng. B48 B20 A	x 4, COIL ON PLUG									1.970.632	C10	
ENGINE												
320 i	Petrol	125	11/12-06/16	N13 B16 A								
ENGINE												
Engine	Information				A10	A20	A40	A50	A70	C10 - C30	C20	E01
All engines	x 4, DELPHI, COIL ON PLUG									1.970.475	C10	
ENGINE												
320 i	Petrol	135	03/12->	B48 B20 A, N20 B20 A, N20 B20 B								
ENGINE												
Engine	Information				A10	A20	A40	A50	A70	C10 - C30	C20	E01
Eng. N20 B20 A, N20 B20 B	x 4, DELPHI, COIL ON PLUG									1.970.475	C10	
Eng. B48 B20 A	x 4, COIL ON PLUG									1.970.632	C10	

A10 CONDENSER	A20 CONTACT SET	A40 DISTRIBUTOR CAP	A50 ROTOR	A70 PICK-UP
C10 COIL	C20 IGNITION MODULE	C30 ELECTRONIC IGNITION KIT	E01 IGNITION CABLE SET	

Vehicle	alim.	kW	Date	Engine	FUNCTIONS ON THE VEHICLE									
					A10	A20	A40	A50	A70	C10 - C30	C20	E01		
320 i xDrive	Petrol	120	03/13->	ENGINE B48 B20 A, N20 B20 A, N20 B20 B										
Engine	Information				A10	A20	A40	A50	A70	C10 - C30	C20	E01		
Eng. N20 B20 A, N20 B20 B	x 4, DELPHI, COIL ON PLUG									1.970.475	C10			
Eng. N20 B20 B	Qty: 4									1.970.475	C10			
Eng. B48 B20 A	x 4, COIL ON PLUG									1.970.632	C10			
320 i xDrive	Petrol	135	07/12->	ENGINE B48 B20 A, N20 B20 A, N20 B20 B										
Engine	Information				A10	A20	A40	A50	A70	C10 - C30	C20	E01		
Eng. N20 B20 A, N20 B20 B	x 4, DELPHI, COIL ON PLUG									1.970.475	C10			
Eng. N20 B20 B	Qty: 4									1.970.475	C10			
Eng. B48 B20 A	x 4, COIL ON PLUG									1.970.632	C10			
320 Li [CHN]	Petrol	0	02/12->	ENGINE --										
Engine	Information				A10	A20	A40	A50	A70	C10 - C30	C20	E01		
All engines	Qty: 4									1.970.475	C10			
328 i	Petrol	180	11/11-10/18	ENGINE N20 B20 A, N26 B20 A										
Engine	Information				A10	A20	A40	A50	A70	C10 - C30	C20	E01		
All engines	x 4, DELPHI, COIL ON PLUG									1.970.475	C10			
Eng. N26 B20 A	Qty: 4									1.970.475	C10			
328 i xDrive	Petrol	180	07/12-08/16	ENGINE N20 B20 A, N26 B20 A										
Engine	Information				A10	A20	A40	A50	A70	C10 - C30	C20	E01		
Eng. N20 B20 A	x 4, DELPHI, COIL ON PLUG									1.970.475	C10			
Eng. N26 B20 A	Qty: 4									1.970.475	C10			
328 i xDrive [USA]	Petrol	0	10/11->	ENGINE --										
Engine	Information				A10	A20	A40	A50	A70	C10 - C30	C20	E01		
All engines	Qty: 4									1.970.475	C10			
328 Li [CHN]	Petrol	180	10/11->	ENGINE N20 B20 A										
Engine	Information				A10	A20	A40	A50	A70	C10 - C30	C20	E01		
All engines	Qty: 4									1.970.475	C10			
328 Li xDrive [CHN]	Petrol	0	10/11->	ENGINE --										
Engine	Information				A10	A20	A40	A50	A70	C10 - C30	C20	E01		
All engines	Qty: 4									1.970.475	C10			
328i	Petrol	160	11/11-06/15	ENGINE N20 B20 A										
Engine	Information				A10	A20	A40	A50	A70	C10 - C30	C20	E01		
All engines	x 4, DELPHI, COIL ON PLUG									1.970.475	C10			
330 e	Petrol/ Electric	135	11/15-10/18	ENGINE B48 B20 A										
Engine	Information				A10	A20	A40	A50	A70	C10 - C30	C20	E01		
All engines	x 4, COIL ON PLUG									1.970.632	C10			
330 e	Petrol/ Electric	185	11/15-10/18	ENGINE B48 B20 A										
Engine	Information				A10	A20	A40	A50	A70	C10 - C30	C20	E01		
All engines	x 4, COIL ON PLUG									1.970.632	C10			
330 i	Petrol	185	07/15->	ENGINE B46 B20 B, B48 B20 B										
Engine	Information				A10	A20	A40	A50	A70	C10 - C30	C20	E01		
All engines	x 4, COIL ON PLUG									1.970.632	C10			
330 i xDrive	Petrol	183	07/16->	ENGINE B48 B20 B										
Engine	Information				A10	A20	A40	A50	A70	C10 - C30	C20	E01		
All engines	x 4, COIL ON PLUG									1.970.632	C10			

A10 CONDENSER	A20 CONTACT SET	A40 DISTRIBUTOR CAP	A50 ROTOR	A70 PICK-UP
C10 COIL	C20 IGNITION MODULE	C30 ELECTRONIC IGNITION KIT	E01 IGNITION CABLE SET	

The present application list is a brief version. For the detailed information about the possibility of installation on a specific vehicle, please refer to our web-catalogue <http://catalogo.facet.eu/>









					FUNCTIONS ON THE VEHICLE							
Vehicle	alim.	kW	Date	Engine								
ENGINE												
330 i xDrive	Petrol	185	07/15->	B48 B20 B								
Engine	Information				A10	A20	A40	A50	A70	C10 - C30	C20	E01
All engines	x 4, COIL ON PLUG									1.970.632	C10	
ENGINE												
335 i	Petrol	225	11/11-06/16	N55 B30 A								
Engine	Information				A10	A20	A40	A50	A70	C10 - C30	C20	E01
All engines	x 6, DELPHI, COIL ON PLUG									1.970.475	C10	
ENGINE												
335 i	Petrol	240	11/11-03/14	N55 B30 A								
Engine	Information				A10	A20	A40	A50	A70	C10 - C30	C20	E01
All engines	x 6, DELPHI, COIL ON PLUG									1.970.475	C10	
ENGINE												
335 i	Petrol	250	07/13-06/16	N55 B30 A								
Engine	Information				A10	A20	A40	A50	A70	C10 - C30	C20	E01
All engines	x 6, DELPHI, COIL ON PLUG									1.970.475	C10	
ENGINE												
335 i xDrive	Petrol	225	07/12-06/16	N55 B30 A								
Engine	Information				A10	A20	A40	A50	A70	C10 - C30	C20	E01
All engines	x 6, DELPHI, COIL ON PLUG									1.970.475	C10	
ENGINE												
335 i xDrive	Petrol	240	07/12-03/14	N55 B30 A								
Engine	Information				A10	A20	A40	A50	A70	C10 - C30	C20	E01
All engines	x 6, DELPHI, COIL ON PLUG									1.970.475	C10	
ENGINE												
335 i xDrive	Petrol	250	07/13-06/16	N55 B30 A								
Engine	Information				A10	A20	A40	A50	A70	C10 - C30	C20	E01
All engines	x 6, DELPHI, COIL ON PLUG									1.970.475	C10	
ENGINE												
340 i	Petrol	240	07/15->	B58 B30 A								
Engine	Information				A10	A20	A40	A50	A70	C10 - C30	C20	E01
All engines	x 6, COIL ON PLUG									1.970.632	C10	
ENGINE												
340 i	Petrol	265	07/15->	B58 B30 A								
Engine	Information				A10	A20	A40	A50	A70	C10 - C30	C20	E01
All engines	x 6, COIL ON PLUG									1.970.632	C10	
ENGINE												
340 i xDrive	Petrol	240	07/15->	B58 B30 A								
Engine	Information				A10	A20	A40	A50	A70	C10 - C30	C20	E01
All engines	x 6, COIL ON PLUG									1.970.632	C10	
ENGINE												
340 i xDrive	Petrol	265	07/15->	B58 B30 A								
Engine	Information				A10	A20	A40	A50	A70	C10 - C30	C20	E01
All engines	x 6, COIL ON PLUG									1.970.632	C10	
ENGINE												
ActiveHybrid	Petrol/ Electric	225	07/12-06/15	N55 B30 A								
Engine	Information				A10	A20	A40	A50	A70	C10 - C30	C20	E01
All engines	x 6, DELPHI, COIL ON PLUG									1.970.475	C10	
ENGINE												
ActiveHybrid	Petrol/ Electric	250	07/12-06/15	N55 B30 A								
Engine	Information				A10	A20	A40	A50	A70	C10 - C30	C20	E01
All engines	x 6, DELPHI, COIL ON PLUG									1.970.475	C10	
ENGINE												
M3	Petrol	317	03/14-10/18	S55 B30 A								
Engine	Information				A10	A20	A40	A50	A70	C10 - C30	C20	E01
All engines	x 6, DELPHI, COIL ON PLUG									1.970.475	C10	

A10 CONDENSER	A20 CONTACT SET	A40 DISTRIBUTOR CAP	A50 ROTOR	A70 PICK-UP
C10 COIL	C20 IGNITION MODULE	C30 ELECTRONIC IGNITION KIT	E01 IGNITION CABLE SET	

Vehicle	alim.	kW	Date	Engine	FUNCTIONS ON THE VEHICLE								
					A10	A20	A40	A50	A70	C10 - C30	C20	E01	
M3 Competition					ENGINE								
Petrol	331	03/16-10/18	S55 B30 A										
Engine	Information				A10	A20	A40	A50	A70	C10 - C30	C20	E01	
All engines	x 6, DELPHI, COIL ON PLUG									1.970.475	C10		
M3 CS					ENGINE								
Petrol	338	01/18-10/18	S55 B30 A										
Engine	Information				A10	A20	A40	A50	A70	C10 - C30	C20	E01	
All engines	x 6, DELPHI, COIL ON PLUG									1.970.475	C10		
3 VII					ENGINE								
318 i					ENGINE								
Petrol	115	03/20->	B48 B20 A										
Engine	Information				A10	A20	A40	A50	A70	C10 - C30	C20	E01	
All engines	x 4, COIL ON PLUG									1.970.632	C10		
320 e Plug-in-Hybrid					ENGINE								
Petrol/ Electric	120	07/20->	B48 B20 A										
Engine	Information				A10	A20	A40	A50	A70	C10 - C30	C20	E01	
All engines	x 4, COIL ON PLUG									1.970.632	C10		
320 e Plug-in-Hybrid					ENGINE								
Petrol/ Electric	150	07/20->	B48 B20 A										
Engine	Information				A10	A20	A40	A50	A70	C10 - C30	C20	E01	
All engines	x 4, COIL ON PLUG									1.970.632	C10		
320 e Plug-in-Hybrid xDrive					ENGINE								
Petrol/ Electric	120	03/21->	B48 B20 A										
Engine	Information				A10	A20	A40	A50	A70	C10 - C30	C20	E01	
All engines	x 4, COIL ON PLUG									1.970.632	C10		
320 e Plug-in-Hybrid xDrive					ENGINE								
Petrol/ Electric	150	03/21->	B48 B20 A										
Engine	Information				A10	A20	A40	A50	A70	C10 - C30	C20	E01	
All engines	x 4, COIL ON PLUG									1.970.632	C10		
320 i					ENGINE								
Petrol	135	03/19->	B46 B20 B, B48 B20 A, B48 B20 B										
Engine	Information				A10	A20	A40	A50	A70	C10 - C30	C20	E01	
All engines	x 4, COIL ON PLUG									1.970.632	C10		
320 i 1.6					ENGINE								
Petrol	125	03/19->	B48 B16 A										
Engine	Information				A10	A20	A40	A50	A70	C10 - C30	C20	E01	
All engines	x 4, COIL ON PLUG									1.970.632	C10		
320 i xDrive					ENGINE								
Petrol	135	07/19->	B48 B20 A										
Engine	Information				A10	A20	A40	A50	A70	C10 - C30	C20	E01	
All engines	x 4, COIL ON PLUG									1.970.632	C10		
330 e Plug-in-Hybrid					ENGINE								
Petrol/ Electric	135	07/19->	B46 B20 B, B48 B20 A										
Engine	Information				A10	A20	A40	A50	A70	C10 - C30	C20	E01	
All engines	x 4, COIL ON PLUG									1.970.632	C10		
330 e Plug-in-Hybrid					ENGINE								
Petrol/ Electric	185	07/19-02/20	B46 B20 B, B48 B20 A										
Engine	Information				A10	A20	A40	A50	A70	C10 - C30	C20	E01	
All engines	x 4, COIL ON PLUG									1.970.632	C10		
330 e Plug-in-Hybrid					ENGINE								
Petrol/ Electric	215	03/20->	B46 B20 B, B48 B20 A										
Engine	Information				A10	A20	A40	A50	A70	C10 - C30	C20	E01	
All engines	x 4, COIL ON PLUG									1.970.632	C10		

A10 CONDENSER	A20 CONTACT SET	A40 DISTRIBUTOR CAP	A50 ROTOR	A70 PICK-UP
C10 COIL	C20 IGNITION MODULE	C30 ELECTRONIC IGNITION KIT	E01 IGNITION CABLE SET	

The present application list is a brief version. For the detailed information about the possibility of installation on a specific vehicle, please refer to our web-catalogue <http://catalogo.facet.eu/>

					FUNCTIONS ON THE VEHICLE							
Vehicle	alim.	kW	Date	Engine	 A10	 A20	 A40	 A50	 A70	 C10 - C30	 C20	 E01
ENGINE												
330 e Plug-in-Hybrid xDrive	Petrol/ Electric	135	07/20->	B48 B20 A								
Engine	Information				A10	A20	A40	A50	A70	C10 - C30	C20	E01
All engines	x 4, COIL ON PLUG									1.970.632	C10	
ENGINE												
330 e Plug-in-Hybrid xDrive	Petrol/ Electric	215	07/20->	B48 B20 A								
Engine	Information				A10	A20	A40	A50	A70	C10 - C30	C20	E01
All engines	x 4, COIL ON PLUG									1.970.632	C10	
ENGINE												
330 i	Petrol	190	11/18->	B48 B20 B								
Engine	Information				A10	A20	A40	A50	A70	C10 - C30	C20	E01
All engines	x 4, COIL ON PLUG									1.970.632	C10	
ENGINE												
330 i xDrive	Petrol	190	11/18->	B46 B20 B, B48 B20 B								
Engine	Information				A10	A20	A40	A50	A70	C10 - C30	C20	E01
All engines	x 4, COIL ON PLUG									1.970.632	C10	
ENGINE												
M 340 i Mild-Hybrid xDrive	Petrol/ Electric	275	11/20->	B58 B30 B								
Engine	Information				A10	A20	A40	A50	A70	C10 - C30	C20	E01
All engines	x 6, COIL ON PLUG									1.970.632	C10	
ENGINE												
M 340 i xDrive	Petrol	275	07/19->	B58 B30 B								
Engine	Information				A10	A20	A40	A50	A70	C10 - C30	C20	E01
All engines	x 6, COIL ON PLUG									1.970.632	C10	
ENGINE												
M 340 i xDrive	Petrol	285	03/19->	B58 B30 B								
Engine	Information				A10	A20	A40	A50	A70	C10 - C30	C20	E01
All engines	x 6, COIL ON PLUG									1.970.632	C10	
ENGINE												
M3	Petrol	353	11/20->	S58B30B								
Engine	Information				A10	A20	A40	A50	A70	C10 - C30	C20	E01
All engines	x 6, COIL ON PLUG									1.970.632	C10	
ENGINE												
M3 Competition	Petrol	375	11/20->	S58 B30 A								
Engine	Information				A10	A20	A40	A50	A70	C10 - C30	C20	E01
All engines	x 6, COIL ON PLUG									1.970.632	C10	
ENGINE												
M3 Competition xDrive	Petrol	375	05/21->	S58 B30 A								
Engine	Information				A10	A20	A40	A50	A70	C10 - C30	C20	E01
All engines	x 6, COIL ON PLUG									1.970.632	C10	
4												
ENGINE												
418 i	Petrol	100	07/15->	B38 B15 A								
Engine	Information				A10	A20	A40	A50	A70	C10 - C30	C20	E01
All engines	x 3, COIL ON PLUG									1.970.632	C10	
ENGINE												
420 i	Petrol	120	11/13->	B48 B20 A, N20 B20 A, N20 B20 B								
Engine	Information				A10	A20	A40	A50	A70	C10 - C30	C20	E01
Eng. N20 B20 A, N20 B20 B	x 4, DELPHI, COIL ON PLUG									1.970.475	C10	
Eng. B48 B20 A	x 4, COIL ON PLUG									1.970.632	C10	
ENGINE												
420 i	Petrol	135	11/13->	B46 B20 B, B48 B20 A, N20 B20 A, N20 B20 B								
Engine	Information				A10	A20	A40	A50	A70	C10 - C30	C20	E01
Eng. N20 B20 A, N20 B20 B	x 4, DELPHI, COIL ON PLUG									1.970.475	C10	
Eng. B46 B20 B, B48 B20 A	x 4, COIL ON PLUG									1.970.632	C10	

A10 CONDENSER	A20 CONTACT SET	A40 DISTRIBUTOR CAP	A50 ROTOR	A70 PICK-UP
C10 COIL	C20 IGNITION MODULE	C30 ELECTRONIC IGNITION KIT	E01 IGNITION CABLE SET	

Vehicle	alim.	kW	Date	Engine	FUNCTIONS ON THE VEHICLE								
					A10	A20	A40	A50	A70	C10 - C30	C20	E01	
420 i 1.6	Petrol	125	11/20->	ENGINE B48 B16 A									
Engine	Information				A10	A20	A40	A50	A70	C10 - C30	C20	E01	
All engines	x 4, COIL ON PLUG									1.970.632	C10		
420 i xDrive	Petrol	120	11/13->	ENGINE B48 B20 A, N20 B20 A, N20 B20 B									
Engine	Information				A10	A20	A40	A50	A70	C10 - C30	C20	E01	
Eng. N20 B20 A	Qty: 4									1.970.475	C10		
Eng. N20 B20 B	x 4, DELPHI, COIL ON PLUG									1.970.475	C10		
Eng. B48 B20 A	x 4, COIL ON PLUG									1.970.632	C10		
420 i xDrive	Petrol	135	11/13->	ENGINE B48 B20 A, N20 B20 A, N20 B20 B									
Engine	Information				A10	A20	A40	A50	A70	C10 - C30	C20	E01	
Eng. N20 B20 A	Qty: 4									1.970.475	C10		
Eng. N20 B20 B	x 4, DELPHI, COIL ON PLUG									1.970.475	C10		
Eng. B48 B20 A	x 4, COIL ON PLUG									1.970.632	C10		
428 i	Petrol	180	07/13-02/17	ENGINE N20 B20 A, N26 B20 A									
Engine	Information				A10	A20	A40	A50	A70	C10 - C30	C20	E01	
All engines	x 4, DELPHI, COIL ON PLUG									1.970.475	C10		
Eng. N26 B20 A	Qty: 4									1.970.475	C10		
428 i xDrive	Petrol	180	07/13-02/16	ENGINE N20 B20 A, N26 B20 A									
Engine	Information				A10	A20	A40	A50	A70	C10 - C30	C20	E01	
Eng. N20 B20 A	x 4, DELPHI, COIL ON PLUG									1.970.475	C10		
Eng. N26 B20 A	Qty: 4									1.970.475	C10		
430 i	Petrol	180	07/21->	ENGINE B46 B20 B, B48 B20 B									
Engine	Information				A10	A20	A40	A50	A70	C10 - C30	C20	E01	
All engines	x 4, COIL ON PLUG									1.970.632	C10		
430 i	Petrol	183	03/16->	ENGINE B48 B20 B									
Engine	Information				A10	A20	A40	A50	A70	C10 - C30	C20	E01	
All engines	x 4, COIL ON PLUG									1.970.632	C10		
430 i	Petrol	185	03/16->	ENGINE B46 B20 B, B48 B20 B									
Engine	Information				A10	A20	A40	A50	A70	C10 - C30	C20	E01	
All engines	x 4, COIL ON PLUG									1.970.632	C10		
430 i	Petrol	190	07/20->	ENGINE B46 B20 B, B48 B20 B									
Engine	Information				A10	A20	A40	A50	A70	C10 - C30	C20	E01	
All engines	x 4, COIL ON PLUG									1.970.632	C10		
430 i xDrive	Petrol	180	07/21->	ENGINE B48 B20 B									
Engine	Information				A10	A20	A40	A50	A70	C10 - C30	C20	E01	
All engines	x 4, COIL ON PLUG									1.970.632	C10		
430 i xDrive	Petrol	183	03/16->	ENGINE B48 B20 B									
Engine	Information				A10	A20	A40	A50	A70	C10 - C30	C20	E01	
All engines	x 4, COIL ON PLUG									1.970.632	C10		
430 i xDrive	Petrol	185	03/16->	ENGINE B48 B20 B									
Engine	Information				A10	A20	A40	A50	A70	C10 - C30	C20	E01	
All engines	x 4, COIL ON PLUG									1.970.632	C10		
430 i xDrive	Petrol	190	07/21->	ENGINE B48 B20 B									
Engine	Information				A10	A20	A40	A50	A70	C10 - C30	C20	E01	
All engines	x 4, COIL ON PLUG									1.970.632	C10		

A10 CONDENSER	A20 CONTACT SET	A40 DISTRIBUTOR CAP	A50 ROTOR	A70 PICK-UP
C10 COIL	C20 IGNITION MODULE	C30 ELECTRONIC IGNITION KIT	E01 IGNITION CABLE SET	

The present application list is a brief version. For the detailed information about the possibility of installation on a specific vehicle, please refer to our web-catalogue <http://catalogo.facet.eu/>

Vehicle	alim.	kW	Date	Engine	FUNCTIONS ON THE VEHICLE								
					A10	A20	A40	A50	A70	C10 - C30	C20	E01	
ENGINE													
435 i	Petrol	225	07/13-02/16	N55 B30 A									
Engine	Information				A10	A20	A40	A50	A70	C10 - C30	C20	E01	
All engines	x 6, DELPHI, COIL ON PLUG									1.970.475	C10		
ENGINE													
435 i	Petrol	250	07/13-02/16	N55 B30 A									
Engine	Information				A10	A20	A40	A50	A70	C10 - C30	C20	E01	
All engines	x 6, DELPHI, COIL ON PLUG									1.970.475	C10		
ENGINE													
435 i xDrive	Petrol	225	07/13-02/16	N55 B30 A									
Engine	Information				A10	A20	A40	A50	A70	C10 - C30	C20	E01	
All engines	x 6, DELPHI, COIL ON PLUG									1.970.475	C10		
ENGINE													
435 i xDrive	Petrol	250	07/13-02/16	N55 B30 A									
Engine	Information				A10	A20	A40	A50	A70	C10 - C30	C20	E01	
All engines	x 6, DELPHI, COIL ON PLUG									1.970.475	C10		
ENGINE													
440 i	Petrol	240	03/16->	B58 B30 A									
Engine	Information				A10	A20	A40	A50	A70	C10 - C30	C20	E01	
All engines	x 6, COIL ON PLUG									1.970.632	C10		
ENGINE													
440 i	Petrol	265	03/16->	B58 B30 A									
Engine	Information				A10	A20	A40	A50	A70	C10 - C30	C20	E01	
All engines	x 6, COIL ON PLUG									1.970.632	C10		
ENGINE													
440 i xDrive	Petrol	240	03/16->	B58 B30 A									
Engine	Information				A10	A20	A40	A50	A70	C10 - C30	C20	E01	
All engines	x 6, COIL ON PLUG									1.970.632	C10		
ENGINE													
440 i xDrive	Petrol	265	03/16->	B58 B30 A									
Engine	Information				A10	A20	A40	A50	A70	C10 - C30	C20	E01	
All engines	x 6, COIL ON PLUG									1.970.632	C10		
ENGINE													
M 440 i Mild-Hybrid	Petrol/ Electric	275	07/21->	B58 B30 B									
Engine	Information				A10	A20	A40	A50	A70	C10 - C30	C20	E01	
All engines	x 6, COIL ON PLUG									1.970.632	C10		
ENGINE													
M 440 i Mild-Hybrid xDrive	Petrol/ Electric	275	11/20->	B58 B30 B									
Engine	Information				A10	A20	A40	A50	A70	C10 - C30	C20	E01	
All engines	x 6, COIL ON PLUG									1.970.632	C10		
ENGINE													
M 440 i Mild-Hybrid xDrive	Petrol/ Electric	285	07/20->	B58 B30 B									
Engine	Information				A10	A20	A40	A50	A70	C10 - C30	C20	E01	
All engines	x 6, COIL ON PLUG									1.970.632	C10		
ENGINE													
M4	Petrol	317	03/14->	S55 B30 A									
Engine	Information				A10	A20	A40	A50	A70	C10 - C30	C20	E01	
All engines	x 6, DELPHI, COIL ON PLUG									1.970.475	C10		
ENGINE													
M4	Petrol	353	11/20->	S58B30B									
Engine	Information				A10	A20	A40	A50	A70	C10 - C30	C20	E01	
All engines	x 6, COIL ON PLUG									1.970.632	C10		
ENGINE													
M4 Competition	Petrol	331	03/16->	S55 B30 A									
Engine	Information				A10	A20	A40	A50	A70	C10 - C30	C20	E01	
All engines	x 6, DELPHI, COIL ON PLUG									1.970.475	C10		

A10 CONDENSER	A20 CONTACT SET	A40 DISTRIBUTOR CAP	A50 ROTOR	A70 PICK-UP
C10 COIL	C20 IGNITION MODULE	C30 ELECTRONIC IGNITION KIT	E01 IGNITION CABLE SET	

Vehicle	alim.	kW	Date	Engine	FUNCTIONS ON THE VEHICLE									
					A10	A20	A40	A50	A70	C10 - C30	C20	E01		
M4 Competition					ENGINE									
	Petrol	375	11/20->	S58 B30 A										
Engine	Information				A10	A20	A40	A50	A70	C10 - C30	C20	E01		
All engines	x 6, COIL ON PLUG									1.970.632	C10			
M4 Competition M xDrive					ENGINE									
	Petrol	375	07/21->	S58 B30 A										
Engine	Information				A10	A20	A40	A50	A70	C10 - C30	C20	E01		
All engines	x 6, COIL ON PLUG									1.970.632	C10			
M4 CS					ENGINE									
	Petrol	338	07/17-06/19	S55 B30 A										
Engine	Information				A10	A20	A40	A50	A70	C10 - C30	C20	E01		
All engines	x 6, DELPHI, COIL ON PLUG									1.970.475	C10			
M4 GTS					ENGINE									
	Petrol	368	03/16-02/17	S55 B30 A										
Engine	Information				A10	A20	A40	A50	A70	C10 - C30	C20	E01		
All engines	x 6, DELPHI, COIL ON PLUG									1.970.475	C10			
4 SERIES					ENGINE									
M440i xDrive Coupe Mild-Hybrid					ENGINE									
	Petrol/ Electric	275	11/20->	B58 B30 B										
Engine	Information				A10	A20	A40	A50	A70	C10 - C30	C20	E01		
All engines	x 6, COIL ON PLUG									1.970.632	C10			
5 I					ENGINE									
518					ENGINE									
	Petrol	66	07/74-05/81	M10 B18 (184VB)										
Engine	Information				A10	A20	A40	A50	A70	C10 - C30	C20	E01		
All engines							1.306.062				1.965.005	1.500.572		
All engines	version Bosch						1.306.094	1.406.115R						
5 II					ENGINE									
518					ENGINE									
	Petrol	66	06/81-09/84	M10 B18 (184VC), M10 B18 (184VD)										
Engine	Information				A10	A20	A40	A50	A70	C10 - C30	C20	E01		
All engines	version Bosch						1.306.094	1.406.115R						
All engines	->year 30/09/83										1.965.005			
All engines	without marten protection											1.500.572		
518 i					ENGINE									
	Petrol	75	05/81-12/87	M10 B18 (184EB)										
Engine	Information				A10	A20	A40	A50	A70	C10 - C30	C20	E01		
All engines	version Bosch						1.306.094	1.406.055R, 1.406.115R						
All engines	without marten protection											1.500.572		
518 i					ENGINE									
	Petrol	77	05/81-12/87	M10 B18 (184EB)										
Engine	Information				A10	A20	A40	A50	A70	C10 - C30	C20	E01		
All engines	version Bosch						1.306.094	1.406.055R, 1.406.115R						
All engines	without marten protection											1.500.572		
520 i					ENGINE									
	Petrol	110	12/86-12/87	M20 B20 (206KA)										
Engine	Information				A10	A20	A40	A50	A70	C10 - C30	C20	E01		
All engines	version Bosch						1.306.238	1.406.119R						
All engines	->year 30/09/83										1.965.005			
520 i					ENGINE									
	Petrol	92	06/81-12/87	M20 B20 (206EA)										
Engine	Information				A10	A20	A40	A50	A70	C10 - C30	C20	E01		
All engines	version Bosch						1.306.121	1.406.060R, 1.406.112R						
All engines	->year 30/09/83										1.965.005			
520 i					ENGINE									
	Petrol	95	08/85-12/87	M20 B20 (206KA)										
Engine	Information				A10	A20	A40	A50	A70	C10 - C30	C20	E01		
All engines	version Bosch						1.306.238	1.406.119R						

A10	CONDENSER	A20	CONTACT SET	A40	DISTRIBUTOR CAP	A50	ROTOR	A70	PICK-UP
C10	COIL	C20	IGNITION MODULE	C30	ELECTRONIC IGNITION KIT	E01	IGNITION CABLE SET		

The present application list is a brief version. For the detailed information about the possibility of installation on a specific vehicle, please refer to our web-catalogue <http://catalogo.facet.eu/>







Vehicle	alim.	kW	Date	Engine	FUNCTIONS ON THE VEHICLE									
					A10	A20	A40	A50	A70	C10 - C30	C20	E01		
ENGINE														
520 i	Petrol	95	08/85-12/87	M20 B20 (206KA)										
Engine		Information			A10	A20	A40	A50	A70	C10 - C30	C20	E01		
All engines		->year 30/09/83									1.965.005			
ENGINE														
525 e	Petrol	90	09/81-12/87	M20 B27 (276EB), M20 B27 (276KA), M20 B27 (276KB)										
Engine		Information			A10	A20	A40	A50	A70	C10 - C30	C20	E01		
All engines		version Bosch					1.306.238	1.406.119R						
ENGINE														
525 e	Petrol	92	03/83-12/87	M20 B27 (276EA)										
Engine		Information			A10	A20	A40	A50	A70	C10 - C30	C20	E01		
All engines		version Bosch					1.306.238	1.406.119R						
ENGINE														
525 e	Petrol	95	09/85-12/87	M20 B27 (276KB)										
Engine		Information			A10	A20	A40	A50	A70	C10 - C30	C20	E01		
All engines		version Bosch					1.306.238	1.406.119R						
ENGINE														
525 i	Petrol	110	06/81-12/87	M30 B25 (256EA)										
Engine		Information			A10	A20	A40	A50	A70	C10 - C30	C20	E01		
All engines		version Bosch					1.306.081	1.406.060R, 1.406.112R						
All engines											1.965.005			
ENGINE														
528 i	Petrol	135	06/81-12/87	M30 B28 (286EA)										
Engine		Information			A10	A20	A40	A50	A70	C10 - C30	C20	E01		
All engines		version Bosch					1.306.081	1.406.060R, 1.406.112R						
All engines											1.965.005			
ENGINE														
528 i [USA]	Petrol	0	01/81-12/87	--										
Engine		Information			A10	A20	A40	A50	A70	C10 - C30	C20	E01		
All engines		01/01/85 ->, version Bosch					1.306.238	1.406.119R						
All engines											1.965.005			
ENGINE														
530 i	Petrol	0	01/84-12/88	--										
Engine		Information			A10	A20	A40	A50	A70	C10 - C30	C20	E01		
All engines		version Bosch					1.306.238	1.406.119R						
All engines										1.970.112	C10		1.500.578	
ENGINE														
535 i	Petrol	162	01/85-12/87	M30 B34 (346EC)										
Engine		Information			A10	A20	A40	A50	A70	C10 - C30	C20	E01		
All engines		version Bosch					1.306.238	1.406.119R						
ENGINE														
535 i, M 535 i	Petrol	136	01/85-12/87	M30 B34 (346KA)										
Engine		Information			A10	A20	A40	A50	A70	C10 - C30	C20	E01		
All engines		version Bosch					1.306.238	1.406.119R						
ENGINE														
535 i, M 535 i	Petrol	141	01/85-12/87	M30 B35 (Motronic)										
Engine		Information			A10	A20	A40	A50	A70	C10 - C30	C20	E01		
All engines		version Bosch					1.306.238	1.406.119R						
ENGINE														
M5	Petrol	210	08/85-12/87	S38 B35 (356ED)										
Engine		Information			A10	A20	A40	A50	A70	C10 - C30	C20	E01		
All engines		version Bosch					1.306.238	1.406.119R						
5 III														
ENGINE														
518 i	Petrol	83	09/89-04/94	M40 B18 (184E1), M43 B18 (184E2)										
Engine		Information			A10	A20	A40	A50	A70	C10 - C30	C20	E01		
All engines		version Bosch					1.306.247	1.406.119R						

A10 CONDENSER	A20 CONTACT SET	A40 DISTRIBUTOR CAP	A50 ROTOR	A70 PICK-UP
C10 COIL	C20 IGNITION MODULE	C30 ELECTRONIC IGNITION KIT	E01 IGNITION CABLE SET	

Vehicle	alim.	kW	Date	Engine	FUNCTIONS ON THE VEHICLE									
					A10	A20	A40	A50	A70	C10 - C30	C20	E01		
ENGINE														
520 i	Petrol	110	07/91-07/96	M50 B20 (206S1), M50 B20 (206S2)										
Engine	Information				A10	A20	A40	A50	A70	C10 - C30	C20	E01		
All engines	without spark plug connector, Qty: 6									1.970.1625	C10			
All engines	incl. spark plug connector, Qty: 6									1.970.412	C10			
ENGINE														
520 i	Petrol	95	06/87-09/90	M20 B20 (206KA)										
Engine	Information				A10	A20	A40	A50	A70	C10 - C30	C20	E01		
All engines	version Bosch						1.306.238	1.406.119R						
All engines	01/10/88 ->, without marten protection												1.500.597	
ENGINE														
520 i 24V	Petrol	110	04/90-08/95	M50 B20 (206S1), M50 B20 (206S2)										
Engine	Information				A10	A20	A40	A50	A70	C10 - C30	C20	E01		
All engines	without spark plug connector, Qty: 6									1.970.1625	C10			
All engines	incl. spark plug connector, Qty: 6									1.970.412	C10			
ENGINE														
525 i	Petrol	125	02/88-08/90	M20 B25 (256K1)										
Engine	Information				A10	A20	A40	A50	A70	C10 - C30	C20	E01		
All engines	version Bosch						1.306.238	1.406.119R						
All engines	01/10/88 ->, without marten protection												1.500.597	
ENGINE														
525 i	Petrol	141	07/91-07/96	M50 B25 (256S1), M50 B25 (256S2)										
Engine	Information				A10	A20	A40	A50	A70	C10 - C30	C20	E01		
All engines	without spark plug connector, Qty: 6									1.970.1625	C10			
All engines	incl. spark plug connector, Qty: 6									1.970.412	C10			
ENGINE														
525 i 24V	Petrol	141	03/90-08/95	M50 B25 (256S2)										
Engine	Information				A10	A20	A40	A50	A70	C10 - C30	C20	E01		
All engines	without spark plug connector, Qty: 6									1.970.1625	C10			
All engines	incl. spark plug connector, Qty: 6									1.970.412	C10			
ENGINE														
525 ix	Petrol	141	01/92-03/96	M50 B25 (256S1)										
Engine	Information				A10	A20	A40	A50	A70	C10 - C30	C20	E01		
All engines	without spark plug connector, Qty: 6									1.970.1625	C10			
All engines	incl. spark plug connector, Qty: 6									1.970.412	C10			
ENGINE														
525 ix 24V	Petrol	141	10/91-08/95	M50 B25 (256S1), M50 B25 (256S2)										
Engine	Information				A10	A20	A40	A50	A70	C10 - C30	C20	E01		
All engines	without spark plug connector, Qty: 6									1.970.1625	C10			
All engines	incl. spark plug connector, Qty: 6									1.970.412	C10			
ENGINE														
530 i	Petrol	138	01/88-04/90	M30 B30 (306KA)										
Engine	Information				A10	A20	A40	A50	A70	C10 - C30	C20	E01		
All engines	version Bosch						1.306.238	1.406.119R						
All engines	->year 31/10/88												1.500.578	
ENGINE														
530 i	Petrol	160	09/92-07/96	M60 B30 (308S1)										
Engine	Information				A10	A20	A40	A50	A70	C10 - C30	C20	E01		
All engines	without spark plug connector, Qty: 8									1.970.1625	C10			
All engines	incl. spark plug connector, Qty: 8									1.970.412	C10			
ENGINE														
530 i V8	Petrol	160	09/92-12/95	M60 B30 (308S1)										
Engine	Information				A10	A20	A40	A50	A70	C10 - C30	C20	E01		
All engines	without spark plug connector, Qty: 8									1.970.1625	C10			
All engines	incl. spark plug connector, Qty: 8									1.970.412	C10			

A10	CONDENSER	A20	CONTACT SET	A40	DISTRIBUTOR CAP	A50	ROTOR	A70	PICK-UP
C10	COIL	C20	IGNITION MODULE	C30	ELECTRONIC IGNITION KIT	E01	IGNITION CABLE SET		

The present application list is a brief version. For the detailed information about the possibility of installation on a specific vehicle, please refer to our web-catalogue <http://catalogo.facet.eu/>









					FUNCTIONS ON THE VEHICLE							
Vehicle	alim.	kW	Date	Engine	 A10	 A20	 A40	 A50	 A70	 C10 - C30	 C20	 E01
ENGINE												
535 i	Petrol	155	11/87-02/93	M30 B34 (346KB)								
Engine	Information				A10	A20	A40	A50	A70	C10 - C30	C20	E01
All engines	version Bosch						1.306.238	1.406.119R				
All engines	->year 31/10/88											1.500.578
ENGINE												
540 i	Petrol	210	09/93-07/96	M60 B40 (408S1)								
Engine	Information				A10	A20	A40	A50	A70	C10 - C30	C20	E01
All engines	without spark plug connector, Qty: 8									1.970.162S	C10	
All engines	incl. spark plug connector, Qty: 8									1.970.412	C10	
ENGINE												
540 i V8	Petrol	210	09/92-12/95	M60 B40 (408S1)								
Engine	Information				A10	A20	A40	A50	A70	C10 - C30	C20	E01
All engines	without spark plug connector, Qty: 8									1.970.162S	C10	
All engines	incl. spark plug connector, Qty: 8									1.970.412	C10	
ENGINE												
M5	Petrol	232	09/88-03/92	S38 B36 (366S1)								
Engine	Information				A10	A20	A40	A50	A70	C10 - C30	C20	E01
All engines	version Bosch						1.306.238	1.406.119R				
All engines										1.970.112	C10	
ENGINE												
M5	Petrol	250	01/92-07/95	S38 B38 (386S1)								
Engine	Information				A10	A20	A40	A50	A70	C10 - C30	C20	E01
All engines	without spark plug connector, Qty: 6									1.970.162S	C10	
ENGINE												
M5 Cat	Petrol	232	09/88-03/92	S38 B36 (366S1)								
Engine	Information				A10	A20	A40	A50	A70	C10 - C30	C20	E01
All engines	version Bosch						1.306.238	1.406.119R				
All engines										1.970.112	C10	
5 IV												
ENGINE												
520 i	Petrol	100	01/96-06/03	6BJT, 8TJ376QE, M52B206S3, M52B206S4								
Engine	Information				A10	A20	A40	A50	A70	C10 - C30	C20	E01
All engines	x 6, BOSCH, BREMI, COIL ON PLUG, incl. spark plug connector									1.970.352	C10	
ENGINE												
520 i	Petrol	110	01/96-06/03	6BJT, 8TJ376QE, M52B206S3, M52B206S4								
Engine	Information				A10	A20	A40	A50	A70	C10 - C30	C20	E01
All engines	x 6, BOSCH, BREMI, COIL ON PLUG, incl. spark plug connector									1.970.352	C10	
ENGINE												
520 i	Petrol	120	09/00-12/03	M54 B22 (226S1), M54B226S1								
Engine	Information				A10	A20	A40	A50	A70	C10 - C30	C20	E01
Eng. M54 B22 (226S1)	->year 30/09/02, without spark plug connector, Qty: 6									1.970.352	C10	
Eng. M54B226S1	->year 01/08/02, x 6, BREMI, COIL ON PLUG									1.970.352	C10	
Eng. M54 B22 (226S1)	->year 30/09/02, incl. spark plug connector, Qty: 6									1.970.413	C10	
Eng. M54 B22 (226S1)	01/10/02 ->, Qty: 6									1.970.475	C10	
Eng. M54B226S1	01/09/02 ->, x 6, DELPHI, COIL ON PLUG									1.970.475	C10	
ENGINE												
520 i	Petrol	125	09/00-12/03	M54 B22 (226S1), M54B226S1								
Engine	Information				A10	A20	A40	A50	A70	C10 - C30	C20	E01
Eng. M54 B22 (226S1)	->year 30/09/02, without spark plug connector, Qty: 6									1.970.352	C10	
Eng. M54B226S1	->year 01/09/02, x 6, BREMI, x 6, BOSCH, COIL ON PLUG, COIL ON PLUG, incl. spark plug connector									1.970.352	C10	
Eng. M54 B22 (226S1)	->year 30/09/02, incl. spark plug connector, Qty: 6									1.970.413	C10	
Eng. M54 B22 (226S1)	01/10/02 ->, Qty: 6									1.970.475	C10	
Eng. M54B226S1	01/10/02 ->, x 6, DELPHI, COIL ON PLUG									1.970.475	C10	

A10 CONDENSER	A20 CONTACT SET	A40 DISTRIBUTOR CAP	A50 ROTOR	A70 PICK-UP
C10 COIL	C20 IGNITION MODULE	C30 ELECTRONIC IGNITION KIT	E01 IGNITION CABLE SET	

Vehicle	alim.	kW	Date	Engine	FUNCTIONS ON THE VEHICLE								
					A10	A20	A40	A50	A70	C10 - C30	C20	E01	
523 i	Petrol	120	09/98-08/00	ENGINE 8K7M 818									
Engine					A10	A20	A40	A50	A70	C10 - C30	C20	E01	
All engines										1.970.352	C10		
523 i	Petrol	125	09/95-08/00	ENGINE 1LD5, 4M18A, 6GW491Q-E, M52 B25 (256S3), M52B256S3									
Engine					A10	A20	A40	A50	A70	C10 - C30	C20	E01	
Eng. 1LD5, 4M18A, 6GW491Q-E, M52B256S3										1.970.352	C10		
Eng. M52 B25 (256S3)										1.970.352	C10		
Eng. M52 B25 (256S3)										1.970.413	C10		
525 i	Petrol	141	09/00-05/04	ENGINE 8CUG, M54 B25 (256S5), M54B256S5									
Engine					A10	A20	A40	A50	A70	C10 - C30	C20	E01	
Eng. 8CUG, M54B256S5										1.970.352	C10		
Eng. M54 B25 (256S5)										1.970.352	C10		
Eng. M54 B25 (256S5)										1.970.413	C10		
Eng. 8CUG, M54B256S5										1.970.475	C10		
Eng. M54 B25 (256S5)										1.970.475	C10		
528 i	Petrol	142	09/95-08/00	ENGINE 9D 0836 LE 501, M52 B28 (286S1), M52 B28 (286S2), M52B286S1, M52B286S2									
Engine					A10	A20	A40	A50	A70	C10 - C30	C20	E01	
Eng. 9D 0836 LE 501, M52B286S1, M52B286S2										1.970.352	C10		
Eng. M52 B28 (286S1), M52 B28 (286S2)										1.970.352	C10		
Eng. M52 B28 (286S1), M52 B28 (286S2)										1.970.413	C10		
530 i	Petrol	170	09/00-12/03	ENGINE 2CBL, M54 B30 (306S3), M54B306S3									
Engine					A10	A20	A40	A50	A70	C10 - C30	C20	E01	
Eng. 2CBL, M54B306S3										1.970.352	C10		
Eng. M54 B30 (306S3)										1.970.352	C10		
Eng. M54 B30 (306S3)										1.970.413	C10		
Eng. 2CBL, M54B306S3										1.970.475	C10		
Eng. M54 B30 (306S3)										1.970.475	C10		
535 i	Petrol	173	06/96-08/98	ENGINE 1H4B 410, M62 B35 (358S2)									
Engine					A10	A20	A40	A50	A70	C10 - C30	C20	E01	
Eng. 1H4B 410										1.970.352	C10		
Eng. M62 B35 (358S2)										1.970.352	C10		
Eng. M62 B35 (358S2)										1.970.413	C10		
535 i	Petrol	180	09/98-06/03	ENGINE 6DAM15B									
Engine					A10	A20	A40	A50	A70	C10 - C30	C20	E01	
All engines										1.970.352	C10		
540 i	Petrol	210	03/96-12/03	ENGINE 0JL465QH, 54A91S, 9K20C3, M62 B44 (448S1), M62 B44 (448S2), M62B448S2									
Engine					A10	A20	A40	A50	A70	C10 - C30	C20	E01	
Eng. 0JL465QH, 54A91S, 9K20C3, M62B448S2										1.970.352	C10		
Eng. M62 B44 (448S1), M62 B44 (448S2)										1.970.352	C10		
Eng. M62 B44 (448S1), M62 B44 (448S2)										1.970.413	C10		

A10	CONDENSER	A20	CONTACT SET	A40	DISTRIBUTOR CAP	A50	ROTOR	A70	PICK-UP
C10	COIL	C20	IGNITION MODULE	C30	ELECTRONIC IGNITION KIT	E01	IGNITION CABLE SET		









The present application list is a brief version. For the detailed information about the possibility of installation on a specific vehicle, please refer to our web-catalogue <http://catalogo.facet.eu/>

					FUNCTIONS ON THE VEHICLE									
Vehicle	alim.	kW	Date	Engine										
ENGINE														
M5	Petrol	294	10/98-06/03	8D 0836 LF 40, S62 B50 (508S1)										
Engine	Information				A10	A20	A40	A50	A70	C10 - C30	C20	E01		
Eng. 8D 0836 LF 40	x 8, BOSCH, BREMI, COIL ON PLUG, incl. spark plug connector									1.970.352	C10			
Eng. S62 B50 (508S1)	without spark plug connector, Qty: 8									1.970.352	C10			
Eng. S62 B50 (508S1)	incl. spark plug connector, Qty: 8									1.970.413	C10			
5 V														
ENGINE														
520 i	Petrol	115	09/07-02/10	N46 B20 B										
Engine	Information				A10	A20	A40	A50	A70	C10 - C30	C20	E01		
All engines	x 4, DELPHI, COIL ON PLUG									1.970.475	C10			
ENGINE														
520 i	Petrol	120	12/06-08/10	N43 B20 A										
Engine	Information				A10	A20	A40	A50	A70	C10 - C30	C20	E01		
All engines	x 4, BOSCH, COIL ON PLUG									1.970.607	C10			
ENGINE														
520 i	Petrol	125	07/03->	M54 226 S1, M54 B22 (226S1), M54B226S1, N43 B20 A										
Engine	Information				A10	A20	A40	A50	A70	C10 - C30	C20	E01		
Eng. M54 226 S1, M54 B22 (226S1)	Qty: 6									1.970.475	C10			
Eng. M54B226S1	x 6, DELPHI, COIL ON PLUG									1.970.475	C10			
Eng. N43 B20 A	x 4, BOSCH, COIL ON PLUG									1.970.607	C10			
ENGINE														
520Li	Petrol	115	09/07->	N46 B20 B, N46 B20 C										
Engine	Information				A10	A20	A40	A50	A70	C10 - C30	C20	E01		
All engines	Qty: 4									1.970.475	C10			
ENGINE														
523 i	Petrol	0	07/05->	N52B25B										
Engine	Information				A10	A20	A40	A50	A70	C10 - C30	C20	E01		
All engines	Qty: 6									1.970.475	C10			
ENGINE														
523 i	Petrol	130	10/04->	N52 B25 A, N52 B25 B, N52 B25 BE, N52 B25 BF, N52B25B										
Engine	Information				A10	A20	A40	A50	A70	C10 - C30	C20	E01		
Eng. N52 B25 A, N52 B25 B, N52 B25 BE	x 6, BOSCH, DELPHI, COIL ON PLUG									1.970.475	C10			
Eng. N52 B25 BF, N52B25B	Qty: 6									1.970.475	C10			
ENGINE														
523 i	Petrol	140	01/07-12/10	N52 B25 A, N52 B25 BE, N53 B25 A										
Engine	Information				A10	A20	A40	A50	A70	C10 - C30	C20	E01		
Eng. N52 B25 A, N52 B25 BE	x 6, DELPHI, COIL ON PLUG									1.970.475	C10			
Eng. N53 B25 A	x 6, BOSCH, COIL ON PLUG									1.970.607	C10			
ENGINE														
523Li	Petrol	130	07/05->	N52 B25 A, N52B25B, N52B25BE										
Engine	Information				A10	A20	A40	A50	A70	C10 - C30	C20	E01		
All engines	Qty: 6									1.970.475	C10			
ENGINE														
525 i	Petrol	141	09/03-12/10	M54 B25 (256S5), M54B256S5										
Engine	Information				A10	A20	A40	A50	A70	C10 - C30	C20	E01		
Eng. M54 B25 (256S5)	Qty: 6									1.970.475	C10			
Eng. M54B256S5	x 6, DELPHI, COIL ON PLUG									1.970.475	C10			
ENGINE														
525 i	Petrol	155	03/05-12/10	N52 B25 A, N53 B30 A										
Engine	Information				A10	A20	A40	A50	A70	C10 - C30	C20	E01		
Eng. N52 B25 A	x 6, DELPHI, x 6, BOSCH, COIL ON PLUG, DELPHI, COIL ON PLUG									1.970.475	C10			
Eng. N53 B30 A	x 6, DELPHI, COIL ON PLUG									1.970.607	C10			
ENGINE														
A10	CONDENSER		A20	CONTACT SET		A40	DISTRIBUTOR CAP		A50	ROTOR		A70	PICK-UP	
C10	COIL		C20	IGNITION MODULE		C30	ELECTRONIC IGNITION KIT		E01	IGNITION CABLE SET				

Vehicle	alim.	kW	Date	Engine	FUNCTIONS ON THE VEHICLE									
					A10	A20	A40	A50	A70	C10 - C30	C20	E01		
ENGINE														
525 i	Petrol	160	03/05->	N52 B25 A, N52 B25 B, N52 B25 BF, N52 B30 A, N52 B30 B, N52 B30 BF, N52B25B, N53 B30 A										
Engine	Information				A10	A20	A40	A50	A70	C10 - C30	C20	E01		
Eng. N52 B25 A, N52 B25 B, N52 B25 BF	x 6, BOSCH, DELPHI, COIL ON PLUG, x 6, BOSCH, DELPHI, COIL ON PLUG									1.970.475	C10			
Eng. N52 B25 BF, N52 B30 A, N52 B30 B, N52 B30 BF, N52B25B	Qty: 6									1.970.475	C10			
Eng. N53 B30 A	x 6, BOSCH, COIL ON PLUG									1.970.607	C10			
ENGINE														
525 i xDrive	Petrol	160	09/08-12/10	N53 B30 A										
Engine	Information				A10	A20	A40	A50	A70	C10 - C30	C20	E01		
All engines	x 6, BOSCH, COIL ON PLUG									1.970.607	C10			
ENGINE														
525 xi	Petrol	160	04/05-12/10	N52 B25 A, N53 B30 A										
Engine	Information				A10	A20	A40	A50	A70	C10 - C30	C20	E01		
All engines	x 6, DELPHI, x 6, BOSCH, COIL ON PLUG, DELPHI, COIL ON PLUG									1.970.475	C10			
Eng. N53 B30 A	x 6, BOSCH, COIL ON PLUG									1.970.607	C10			
ENGINE														
525 xi	Petrol	218	07/05->	N52 B30 A										
Engine	Information				A10	A20	A40	A50	A70	C10 - C30	C20	E01		
All engines	Qty: 6									1.970.475	C10			
ENGINE														
525Li	Petrol	160	07/05->	N52 B25 A, N52 B25 BF, N52B25B										
Engine	Information				A10	A20	A40	A50	A70	C10 - C30	C20	E01		
All engines	Qty: 6									1.970.475	C10			
ENGINE														
528 xi	Petrol	172	03/07->	N52 B30 A										
Engine	Information				A10	A20	A40	A50	A70	C10 - C30	C20	E01		
All engines	Qty: 6									1.970.475	C10			
ENGINE														
530 i	Petrol	170	12/01->	3CA4GB16, M54 306 S3, M54 B30 (306S3)										
Engine	Information				A10	A20	A40	A50	A70	C10 - C30	C20	E01		
Eng. 3CA4GB16	x 6, DELPHI, COIL ON PLUG									1.970.475	C10			
Eng. M54 306 S3, M54 B30 (306S3)	Qty: 6									1.970.475	C10			
ENGINE														
530 i	Petrol	187	03/05-03/10	N52 B30 A										
Engine	Information				A10	A20	A40	A50	A70	C10 - C30	C20	E01		
All engines	x 6, DELPHI, ELDOR, COIL ON PLUG									1.970.475	C10			
ENGINE														
530 i	Petrol	190	09/04-03/07	N52 B30 A, N52 B30 BF										
Engine	Information				A10	A20	A40	A50	A70	C10 - C30	C20	E01		
All engines	x 6, BOSCH, DELPHI, COIL ON PLUG									1.970.475	C10			
ENGINE														
530 i	Petrol	200	09/06-12/10	N52 B30 A, N52 B30 BF, N53 B30 A										
Engine	Information				A10	A20	A40	A50	A70	C10 - C30	C20	E01		
All engines	-eng. N53B30A, x 6, DELPHI, COIL ON PLUG									1.970.475	C10			
Eng. N53 B30 A	x 6, BOSCH, COIL ON PLUG									1.970.607	C10			
ENGINE														
530 i xDrive	Petrol	200	09/08-05/10	N53 B30 A										
Engine	Information				A10	A20	A40	A50	A70	C10 - C30	C20	E01		
All engines	x 6, BOSCH, COIL ON PLUG									1.970.607	C10			
ENGINE														
530 xi	Petrol	190	09/04-02/07	N52 B30 A										
Engine	Information				A10	A20	A40	A50	A70	C10 - C30	C20	E01		
All engines	x 6, BOSCH, DELPHI, x 6, BOSCH, COIL ON PLUG, DELPHI, COIL ON PLUG									1.970.475	C10			

A10 CONDENSER	A20 CONTACT SET	A40 DISTRIBUTOR CAP	A50 ROTOR	A70 PICK-UP
C10 COIL	C20 IGNITION MODULE	C30 ELECTRONIC IGNITION KIT	E01 IGNITION CABLE SET	

The present application list is a brief version. For the detailed information about the possibility of installation on a specific vehicle, please refer to our web-catalogue <http://catalogo.facet.eu/>









					FUNCTIONS ON THE VEHICLE							
Vehicle	alim.	kW	Date	Engine	 A10	 A20	 A40	 A50	 A70	 C10 - C30	 C20	 E01
ENGINE												
530 xi	Petrol	200	09/06-05/10	N52 B30 A, N53 B30 A								
Engine	Information				A10	A20	A40	A50	A70	C10 - C30	C20	E01
Eng. N52 B30 A	x 6, DELPHI, COIL ON PLUG									1.970.475	C10	
Eng. N53 B30 A	x 6, BOSCH, COIL ON PLUG									1.970.607	C10	
ENGINE												
530Li	Petrol	190	07/05->	N52 B30 A, N52 B30 B, N52 B30 BF								
Engine	Information				A10	A20	A40	A50	A70	C10 - C30	C20	E01
All engines	Qty: 6									1.970.475	C10	
ENGINE												
535 i	Petrol	225	04/06-12/09	N54 B30 A								
Engine	Information				A10	A20	A40	A50	A70	C10 - C30	C20	E01
All engines	Qty: 6									1.970.475	C10	
ENGINE												
535xi	Petrol	225	03/07->	N54 B30 A								
Engine	Information				A10	A20	A40	A50	A70	C10 - C30	C20	E01
All engines	Qty: 6									1.970.475	C10	
ENGINE												
540 i	Petrol	220	09/05-02/07	N62 B40 A								
Engine	Information				A10	A20	A40	A50	A70	C10 - C30	C20	E01
All engines	x 8, DELPHI, COIL ON PLUG									1.970.475	C10	
ENGINE												
540 i	Petrol	225	03/07-12/09	N62 B40 A								
Engine	Information				A10	A20	A40	A50	A70	C10 - C30	C20	E01
All engines	x 8, DELPHI, COIL ON PLUG									1.970.475	C10	
ENGINE												
545 i	Petrol	245	09/03-12/10	N62 B44 A								
Engine	Information				A10	A20	A40	A50	A70	C10 - C30	C20	E01
All engines	x 8, DELPHI, ELDOR, COIL ON PLUG									1.970.475	C10	
ENGINE												
550 i	Petrol	270	07/05-12/10	N62 B48 A, N62 B48 B								
Engine	Information				A10	A20	A40	A50	A70	C10 - C30	C20	E01
Eng. N62 B48 A	Qty: 8									1.970.475	C10	
Eng. N62 B48 B	x 8, DELPHI, COIL ON PLUG									1.970.475	C10	
5 VI												
ENGINE												
520 i	Petrol	120	09/11-02/17	N20 B20 A, N20 B20 B								
Engine	Information				A10	A20	A40	A50	A70	C10 - C30	C20	E01
All engines	x 4, DELPHI, COIL ON PLUG									1.970.475	C10	
ENGINE												
520 i	Petrol	125	07/13-10/16	N20 B16 A								
Engine	Information				A10	A20	A40	A50	A70	C10 - C30	C20	E01
All engines	x 4, DELPHI, COIL ON PLUG									1.970.475	C10	
ENGINE												
520 i	Petrol	135	10/10-02/17	N20 B20 A, N20 B20 B								
Engine	Information				A10	A20	A40	A50	A70	C10 - C30	C20	E01
All engines	x 4, DELPHI, COIL ON PLUG									1.970.475	C10	
ENGINE												
520Li [CHN]	Petrol	0	01/11->	N20 B20 D								
Engine	Information				A10	A20	A40	A50	A70	C10 - C30	C20	E01
All engines	pole nr. 4									1.970.475	C10	
ENGINE												
520Li [CHN]	Petrol	115	01/09->	N52 B25 AF								
Engine	Information				A10	A20	A40	A50	A70	C10 - C30	C20	E01
All engines	Qty: 6									1.970.475	C10	

A10 CONDENSER	A20 CONTACT SET	A40 DISTRIBUTOR CAP	A50 ROTOR	A70 PICK-UP
C10 COIL	C20 IGNITION MODULE	C30 ELECTRONIC IGNITION KIT	E01 IGNITION CABLE SET	

Vehicle	alim.	kW	Date	Engine	FUNCTIONS ON THE VEHICLE									
					A10	A20	A40	A50	A70	C10 - C30	C20	E01		
523 i	Petrol	150	06/09-08/11	ENGINE N52 B25 A, N52 B25 AF, N52 B25 B, N52 B25 BF, N53 B30 A										
Engine	Information													
Eng. N52 B25 A, N52 B25 AF, N52 B25 B, N52 B25 BF	x 6, DELPHI, COIL ON PLUG									1.970.475	C10			
Eng. N53 B30 A	x 6, BOSCH, COIL ON PLUG									1.970.607	C10			
523 i	Petrol	155	01/10-08/11	ENGINE N53 B30 A										
Engine	Information													
All engines	x 6, BOSCH, COIL ON PLUG									1.970.607	C10			
523 i	Petrol	160	06/09-08/11	ENGINE N53 B30 A										
Engine	Information													
All engines	Qty: 6									1.970.607	C10			
523Li [CHN]	Petrol	130	01/09->	ENGINE N52 B25 AF										
Engine	Information													
All engines	Qty: 6									1.970.475	C10			
525 d	Diesel	155	09/11-10/16	ENGINE N47D20D(N47S1)										
Engine	Information													
All engines	Qty: 4									1.970.475	C10			
525Li [CHN]	Petrol	120	09/11->	ENGINE N20 B20 A										
Engine	Information													
All engines	Qty: 4									1.970.475	C10			
528 i	Petrol	180	09/11-02/17	ENGINE N20 B20 A										
Engine	Information													
All engines	x 4, DELPHI, COIL ON PLUG									1.970.475	C10			
528 i	Petrol	190	11/09->	ENGINE N52 B30 BF, N53 B30 A										
Engine	Information													
Eng. N52 B30 BF	Qty: 6									1.970.475	C10			
Eng. N53 B30 A	x 6, BOSCH, COIL ON PLUG									1.970.607	C10			
528 i xDrive	Petrol	180	09/11-02/17	ENGINE N20 B20 A										
Engine	Information													
All engines	x 4, DELPHI, COIL ON PLUG									1.970.475	C10			
528Li [CHN]	Petrol	0	01/13->	ENGINE N20 B20 C										
Engine	Information													
All engines	Qty: 4									1.970.475	C10			
528Li [CHN]	Petrol	190	09/10->	ENGINE N52 B30 AF										
Engine	Information													
All engines	Qty: 6									1.970.475	C10			
530 Hybrid [CHN]	Petrol/ Electric	0	01/13->	ENGINE --										
Engine	Information													
All engines	Qty: 2									1.970.475	C10			
530 i	Petrol	190	03/10-06/13	ENGINE N52 B30 A, N52 B30 AF, N52 B30 BF										
Engine	Information													
All engines	x 6, DELPHI, COIL ON PLUG									1.970.475	C10			

A10 CONDENSER	A20 CONTACT SET	A40 DISTRIBUTOR CAP	A50 ROTOR	A70 PICK-UP
C10 COIL	C20 IGNITION MODULE	C30 ELECTRONIC IGNITION KIT	E01 IGNITION CABLE SET	

The present application list is a brief version. For the detailed information about the possibility of installation on a specific vehicle, please refer to our web-catalogue <http://catalogo.facet.eu/>

				FUNCTIONS ON THE VEHICLE								
Vehicle	alim.	kW	Date	Engine								
				ENGINE								
530 i	Petrol	200	05/11-06/13	N53 B30 A								
Engine		Information			A10	A20	A40	A50	A70	C10 - C30	C20	E01
All engines		x 6, BOSCH, COIL ON PLUG								1.970.607	C10	
				ENGINE								
530Li [CHN]	Petrol	190	09/10->	N52 B30 AF								
Engine		Information			A10	A20	A40	A50	A70	C10 - C30	C20	E01
All engines		Qty: 6								1.970.475	C10	
				ENGINE								
535 i	Petrol	225	01/10-02/17	N55 B30 A								
Engine		Information			A10	A20	A40	A50	A70	C10 - C30	C20	E01
All engines		x 6, DELPHI, COIL ON PLUG								1.970.475	C10	
				ENGINE								
535 i	Petrol	240	07/13-02/17	N55 B30 A								
Engine		Information			A10	A20	A40	A50	A70	C10 - C30	C20	E01
All engines		x 6, DELPHI, COIL ON PLUG								1.970.475	C10	
				ENGINE								
535 i xDrive	Petrol	225	03/11-02/17	N55 B30 A								
Engine		Information			A10	A20	A40	A50	A70	C10 - C30	C20	E01
All engines		x 6, DELPHI, COIL ON PLUG								1.970.475	C10	
				ENGINE								
535 i xDrive	Petrol	240	07/13-02/17	N55 B30 A								
Engine		Information			A10	A20	A40	A50	A70	C10 - C30	C20	E01
All engines		x 6, DELPHI, COIL ON PLUG								1.970.475	C10	
				ENGINE								
535Li [CHN]	Petrol	225	01/09->	N55 B30 A								
Engine		Information			A10	A20	A40	A50	A70	C10 - C30	C20	E01
All engines		Qty: 6								1.970.475	C10	
				ENGINE								
550 i	Petrol	300	03/10-06/13	N63 B44 A								
Engine		Information			A10	A20	A40	A50	A70	C10 - C30	C20	E01
All engines		x 8, DELPHI, ELDOR, COIL ON PLUG								1.970.475	C10	
				ENGINE								
550 i	Petrol	330	07/13-02/17	N63 B44 B								
Engine		Information			A10	A20	A40	A50	A70	C10 - C30	C20	E01
All engines		x 8, BOSCH, DELPHI, COIL ON PLUG								1.970.475	C10	
				ENGINE								
550 i xDrive	Petrol	300	08/10-06/13	N63 B44 A								
Engine		Information			A10	A20	A40	A50	A70	C10 - C30	C20	E01
All engines		x 8, DELPHI, ELDOR, COIL ON PLUG								1.970.475	C10	
				ENGINE								
550 i xDrive	Petrol	330	07/13-10/16	N63 B44 B								
Engine		Information			A10	A20	A40	A50	A70	C10 - C30	C20	E01
All engines		x 8, BOSCH, DELPHI, COIL ON PLUG								1.970.475	C10	
				ENGINE								
ActiveHybrid	Petrol/ Electric	225	12/11-10/16	N55 B30 A								
Engine		Information			A10	A20	A40	A50	A70	C10 - C30	C20	E01
All engines		x 6, DELPHI, COIL ON PLUG								1.970.475	C10	
				ENGINE								
ActiveHybrid	Petrol/ Electric	250	12/11-10/16	N55 B30 A								
Engine		Information			A10	A20	A40	A50	A70	C10 - C30	C20	E01
All engines		x 6, DELPHI, COIL ON PLUG								1.970.475	C10	
				ENGINE								
M5	Petrol	412	09/11-10/16	S63 B44 B								
Engine		Information			A10	A20	A40	A50	A70	C10 - C30	C20	E01
All engines		x 8, BOSCH, DELPHI, COIL ON PLUG								1.970.475	C10	

A10 CONDENSER	A20 CONTACT SET	A40 DISTRIBUTOR CAP	A50 ROTOR	A70 PICK-UP
C10 COIL	C20 IGNITION MODULE	C30 ELECTRONIC IGNITION KIT	E01 IGNITION CABLE SET	

Vehicle	alim.	kW	Date	Engine	FUNCTIONS ON THE VEHICLE									
					A10	A20	A40	A50	A70	C10 - C30	C20	E01		
ENGINE														
M5 30th Anniversary	Petrol	441	07/14-10/16	S63 B44 B										
Engine	Information				A10	A20	A40	A50	A70	C10 - C30	C20	E01		
All engines	x 8, BOSCH, DELPHI, COIL ON PLUG									1.970.475	C10			
ENGINE														
M5 Competition	Petrol	423	02/13-10/16	S63 B44 B										
Engine	Information				A10	A20	A40	A50	A70	C10 - C30	C20	E01		
All engines	x 8, BOSCH, DELPHI, COIL ON PLUG									1.970.475	C10			
5 VI GT														
ENGINE														
528 i	Petrol	180	07/13-02/17	N20 B20 A										
Engine	Information				A10	A20	A40	A50	A70	C10 - C30	C20	E01		
All engines	x 4, DELPHI, COIL ON PLUG									1.970.475	C10			
ENGINE														
535 i	Petrol	225	01/09-02/17	N55 B30 A										
Engine	Information				A10	A20	A40	A50	A70	C10 - C30	C20	E01		
All engines	x 6, DELPHI, COIL ON PLUG									1.970.475	C10			
ENGINE														
535 i xDrive	Petrol	225	09/10-02/17	N55 B30 A										
Engine	Information				A10	A20	A40	A50	A70	C10 - C30	C20	E01		
All engines	x 6, DELPHI, COIL ON PLUG									1.970.475	C10			
ENGINE														
550 i	Petrol	298	10/09-06/12	N63 B44 A										
Engine	Information				A10	A20	A40	A50	A70	C10 - C30	C20	E01		
All engines	Qty: 8									1.970.475	C10			
ENGINE														
550 i	Petrol	300	08/09-06/12	N63 B44 A										
Engine	Information				A10	A20	A40	A50	A70	C10 - C30	C20	E01		
All engines	x 8, DELPHI, ELDOR, COIL ON PLUG									1.970.475	C10			
ENGINE														
550 i	Petrol	330	07/12-02/17	N63 B44 B										
Engine	Information				A10	A20	A40	A50	A70	C10 - C30	C20	E01		
All engines	x 8, BOSCH, DELPHI, COIL ON PLUG									1.970.475	C10			
ENGINE														
550 i xDrive	Petrol	300	06/10-03/14	N63 B40 A, N63 B44 A										
Engine	Information				A10	A20	A40	A50	A70	C10 - C30	C20	E01		
Eng. N63 B40 A	Qty: 8									1.970.475	C10			
Eng. N63 B44 A	x 8, DELPHI, ELDOR, COIL ON PLUG									1.970.475	C10			
ENGINE														
550 i xDrive	Petrol	330	07/12-02/17	N63 B44 B										
Engine	Information				A10	A20	A40	A50	A70	C10 - C30	C20	E01		
All engines	x 8, BOSCH, DELPHI, COIL ON PLUG									1.970.475	C10			
5 VII														
ENGINE														
520 E PLUG-IN-HYBRID	Petrol/ Electric	120	03/21->	B48 B20 A										
Engine	Information				A10	A20	A40	A50	A70	C10 - C30	C20	E01		
All engines	x 4, COIL ON PLUG									1.970.632	C10			
ENGINE														
520 E PLUG-IN-HYBRID	Petrol/ Electric	150	03/21->	B48 B20 A										
Engine	Information				A10	A20	A40	A50	A70	C10 - C30	C20	E01		
All engines	x 4, COIL ON PLUG									1.970.632	C10			
ENGINE														
520 i	Petrol	120	07/17-06/20	B48 B20 A, B48 B20 B										
Engine	Information				A10	A20	A40	A50	A70	C10 - C30	C20	E01		
All engines	x 4, COIL ON PLUG									1.970.632	C10			
ENGINE														
520 i	Petrol	125	07/17->	B48 B16 A										
Engine	Information				A10	A20	A40	A50	A70	C10 - C30	C20	E01		
All engines	x 4, COIL ON PLUG									1.970.632	C10			

A10	CONDENSER	A20	CONTACT SET	A40	DISTRIBUTOR CAP	A50	ROTOR	A70	PICK-UP
C10	COIL	C20	IGNITION MODULE	C30	ELECTRONIC IGNITION KIT	E01	IGNITION CABLE SET		

The present application list is a brief version. For the detailed information about the possibility of installation on a specific vehicle, please refer to our web-catalogue <http://catalogo.facet.eu/>









Vehicle	alim.	kW	Date	Engine	FUNCTIONS ON THE VEHICLE									
					A10	A20	A40	A50	A70	C10 - C30	C20	E01		
ENGINE														
520 i	Petrol	135	07/17->	B48 B20 A, B48 B20 B										
Engine	Information				A10	A20	A40	A50	A70	C10 - C30	C20	E01		
All engines	x 4, COIL ON PLUG									1.970.632	C10			
ENGINE														
520 i	Petrol	155	07/17-06/20	B48 B20 A, B48 B20 B										
Engine	Information				A10	A20	A40	A50	A70	C10 - C30	C20	E01		
All engines	x 4, COIL ON PLUG									1.970.632	C10			
ENGINE														
520 i Mild-Hybrid	Petrol/ Electric	120	07/20->	B48 B20 A										
Engine	Information				A10	A20	A40	A50	A70	C10 - C30	C20	E01		
All engines	x 4, COIL ON PLUG									1.970.632	C10			
ENGINE														
520 i Mild-Hybrid	Petrol/ Electric	135	07/20->	B48 B20 A										
Engine	Information				A10	A20	A40	A50	A70	C10 - C30	C20	E01		
All engines	x 4, COIL ON PLUG									1.970.632	C10			
ENGINE														
530 e Plug-in-Hybrid	Petrol/ Electric	120	07/19->	B48 B20 A										
Engine	Information				A10	A20	A40	A50	A70	C10 - C30	C20	E01		
All engines	x 4, COIL ON PLUG									1.970.632	C10			
ENGINE														
530 e Plug-in-Hybrid	Petrol/ Electric	135	03/17->	B46 B20 B, B48 B20 A										
Engine	Information				A10	A20	A40	A50	A70	C10 - C30	C20	E01		
All engines	x 4, COIL ON PLUG									1.970.632	C10			
ENGINE														
530 e Plug-in-Hybrid	Petrol/ Electric	170	07/19-06/20	B48 B20 A										
Engine	Information				A10	A20	A40	A50	A70	C10 - C30	C20	E01		
All engines	x 4, COIL ON PLUG									1.970.632	C10			
ENGINE														
530 e Plug-in-Hybrid	Petrol/ Electric	200	07/20->	B48 B20 A										
Engine	Information				A10	A20	A40	A50	A70	C10 - C30	C20	E01		
All engines	x 4, COIL ON PLUG									1.970.632	C10			
ENGINE														
530 e Plug-in-Hybrid	Petrol/ Electric	215	07/20->	B46 B20 B, B48 B20 A										
Engine	Information				A10	A20	A40	A50	A70	C10 - C30	C20	E01		
All engines	x 4, COIL ON PLUG									1.970.632	C10			
ENGINE														
530 e Plug-in-Hybrid xDrive	Petrol/ Electric	120	07/19->	B48 B20 A										
Engine	Information				A10	A20	A40	A50	A70	C10 - C30	C20	E01		
All engines	x 4, COIL ON PLUG									1.970.632	C10			
ENGINE														
530 e Plug-in-Hybrid xDrive	Petrol/ Electric	135	03/17->	B46 B20 B, B48 B20 A										
Engine	Information				A10	A20	A40	A50	A70	C10 - C30	C20	E01		
All engines	x 4, COIL ON PLUG									1.970.632	C10			
ENGINE														
530 e Plug-in-Hybrid xDrive	Petrol/ Electric	170	07/19-06/20	B48 B20 A										
Engine	Information				A10	A20	A40	A50	A70	C10 - C30	C20	E01		
All engines	x 4, COIL ON PLUG									1.970.632	C10			
ENGINE														
530 e Plug-in-Hybrid xDrive	Petrol/ Electric	185	03/17-06/20	B46 B20 B, B48 B20 A										
Engine	Information				A10	A20	A40	A50	A70	C10 - C30	C20	E01		
All engines	x 4, COIL ON PLUG									1.970.632	C10			

A10 CONDENSER	A20 CONTACT SET	A40 DISTRIBUTOR CAP	A50 ROTOR	A70 PICK-UP
C10 COIL	C20 IGNITION MODULE	C30 ELECTRONIC IGNITION KIT	E01 IGNITION CABLE SET	

Vehicle	alim.	kW	Date	Engine	FUNCTIONS ON THE VEHICLE									
					A10	A20	A40	A50	A70	C10 - C30	C20	E01		
ENGINE														
530 e Plug-in-Hybrid xDrive	Petrol/ Electric	200	07/20->	B48 B20 A										
Engine	Information				A10	A20	A40	A50	A70	C10 - C30	C20	E01		
All engines	x 4, COIL ON PLUG									1.970.632	C10			
ENGINE														
530 e Plug-in-Hybrid xDrive	Petrol/ Electric	215	07/20->	B46 B20 B, B48 B20 A										
Engine	Information				A10	A20	A40	A50	A70	C10 - C30	C20	E01		
All engines	x 4, COIL ON PLUG									1.970.632	C10			
ENGINE														
530 i	Petrol	185	09/16->	B46 B20 B, B48 B20 B										
Engine	Information				A10	A20	A40	A50	A70	C10 - C30	C20	E01		
All engines	x 4, COIL ON PLUG									1.970.632	C10			
ENGINE														
530 i Mild-Hybrid	Petrol/ Electric	185	07/20->	B48 B20 B										
Engine	Information				A10	A20	A40	A50	A70	C10 - C30	C20	E01		
All engines	x 4, COIL ON PLUG									1.970.632	C10			
ENGINE														
530 i Mild-Hybrid xDrive	Petrol/ Electric	185	07/20->	B48 B20 B										
Engine	Information				A10	A20	A40	A50	A70	C10 - C30	C20	E01		
All engines	x 4, COIL ON PLUG									1.970.632	C10			
ENGINE														
530 i xDrive	Petrol	183	09/16->	B46 B20 B										
Engine	Information				A10	A20	A40	A50	A70	C10 - C30	C20	E01		
All engines	->year 01/06/19, x 4, COIL ON PLUG 01/07/19 ->, x 4, COIL ON PLUG									1.970.632	C10			
ENGINE														
530 i xDrive	Petrol	185	09/16->	B46 B20 B, B48 B20 B										
Engine	Information				A10	A20	A40	A50	A70	C10 - C30	C20	E01		
All engines	x 4, COIL ON PLUG									1.970.632	C10			
ENGINE														
540 i	Petrol	250	09/16-06/20	B58 B30 A										
Engine	Information				A10	A20	A40	A50	A70	C10 - C30	C20	E01		
All engines	x 6, COIL ON PLUG									1.970.632	C10			
ENGINE														
540 i	Petrol	265	09/16-06/20	B58 B30 A										
Engine	Information				A10	A20	A40	A50	A70	C10 - C30	C20	E01		
All engines	x 6, COIL ON PLUG									1.970.632	C10			
ENGINE														
540 i Mild-Hybrid	Petrol/ Electric	245	07/20->	B58 B30 C										
Engine	Information				A10	A20	A40	A50	A70	C10 - C30	C20	E01		
All engines	x 6, COIL ON PLUG									1.970.632	C10			
ENGINE														
540 i Mild-Hybrid xDrive	Petrol/ Electric	245	07/20->	B58 B30 C										
Engine	Information				A10	A20	A40	A50	A70	C10 - C30	C20	E01		
All engines	x 6, COIL ON PLUG									1.970.632	C10			
ENGINE														
540 i xDrive	Petrol	250	09/16->	B58 B30 A										
Engine	Information				A10	A20	A40	A50	A70	C10 - C30	C20	E01		
All engines	x 6, COIL ON PLUG									1.970.632	C10			
ENGINE														
540 i xDrive	Petrol	265	09/16-06/20	B58 B30 A										
Engine	Information				A10	A20	A40	A50	A70	C10 - C30	C20	E01		
All engines	x 6, COIL ON PLUG									1.970.632	C10			

A10	CONDENSER	A20	CONTACT SET	A40	DISTRIBUTOR CAP	A50	ROTOR	A70	PICK-UP
C10	COIL	C20	IGNITION MODULE	C30	ELECTRONIC IGNITION KIT	E01	IGNITION CABLE SET		

The present application list is a brief version. For the detailed information about the possibility of installation on a specific vehicle, please refer to our web-catalogue <http://catalogo.facet.eu/>

					FUNCTIONS ON THE VEHICLE							
Vehicle	alim.	kW	Date	Engine								
ENGINE												
545 e Plug-in-Hybrid xDrive	Petrol/Electric	210	11/20->	B58 B30 C								
Engine	Information				A10	A20	A40	A50	A70	C10 - C30	C20	E01
All engines	x 4, COIL ON PLUG									1.970.632	C10	
ENGINE												
545 e Plug-in-Hybrid xDrive	Petrol/Electric	290	11/20->	B58 B30 C								
Engine	Information				A10	A20	A40	A50	A70	C10 - C30	C20	E01
All engines	x 4, COIL ON PLUG									1.970.632	C10	
ENGINE												
M 550 i xDrive	Petrol	340	03/17-06/19	N63 B44 C								
Engine	Information				A10	A20	A40	A50	A70	C10 - C30	C20	E01
All engines	x 8, DELPHI, COIL ON PLUG									1.970.475	C10	
ENGINE												
M5	Petrol	441	09/17->	S63 B44 B								
Engine	Information				A10	A20	A40	A50	A70	C10 - C30	C20	E01
All engines	x 8, DELPHI, COIL ON PLUG									1.970.475	C10	
ENGINE												
M5 Competition	Petrol	460	07/18->	S63 B44 B								
Engine	Information				A10	A20	A40	A50	A70	C10 - C30	C20	E01
All engines	x 8, DELPHI, COIL ON PLUG									1.970.475	C10	
ENGINE												
M5 CS	Petrol	467	03/21->	S63 B44 B								
Engine	Information				A10	A20	A40	A50	A70	C10 - C30	C20	E01
All engines	x 8, DELPHI, COIL ON PLUG									1.970.475	C10	
6 I												
ENGINE												
628 Ci	Petrol	135	09/79-08/87	M30 B28								
Engine	Information				A10	A20	A40	A50	A70	C10 - C30	C20	E01
All engines	version Bosch						1.306.081	1.406.112R				
All engines											1.965.005	
ENGINE												
633 Ci	Petrol	145	09/78-08/84	05U18								
Engine	Information				A10	A20	A40	A50	A70	C10 - C30	C20	E01
All engines											1.965.005	
ENGINE												
633 Ci	Petrol	147	10/75-12/81	05U18								
Engine	Information				A10	A20	A40	A50	A70	C10 - C30	C20	E01
All engines											1.965.005	
ENGINE												
635 Ci	Petrol	160	06/78-04/82	M30 B35 (Motronic, 9.3:1)								
Engine	Information				A10	A20	A40	A50	A70	C10 - C30	C20	E01
All engines	01/01/85 ->, version Bosch						1.306.238	1.406.119R				
All engines											1.965.005	
ENGINE												
M 635 CSi	Petrol	191	04/86-02/89	S38 B35 (356ED)								
Engine	Information				A10	A20	A40	A50	A70	C10 - C30	C20	E01
All engines	version Bosch						1.306.238	1.406.119R				
ENGINE												
M 635 CSi	Petrol	210	04/84-12/88	M88 B35 (356ED)								
Engine	Information				A10	A20	A40	A50	A70	C10 - C30	C20	E01
All engines	version Bosch						1.306.238	1.406.119R				
6 II												
ENGINE												
630 i	Petrol	190	09/04-08/07	N52 B30 A, N52 B30 B, N52 B30 BF								
Engine	Information				A10	A20	A40	A50	A70	C10 - C30	C20	E01
All engines	x 6, ELDOR, x 6, BOSCH, COIL ON PLUG, DELPHI, COIL ON PLUG									1.970.475	C10	

A10 CONDENSER	A20 CONTACT SET	A40 DISTRIBUTOR CAP	A50 ROTOR	A70 PICK-UP
C10 COIL	C20 IGNITION MODULE	C30 ELECTRONIC IGNITION KIT	E01 IGNITION CABLE SET	

Vehicle	alim.	kW	Date	Engine	FUNCTIONS ON THE VEHICLE									
					A10	A20	A40	A50	A70	C10 - C30	C20	E01		
ENGINE														
630 i	Petrol	200	09/07-08/10	N52 B30 A, N52 B30 B, N52 B30 BF, N53 B30 A										
Engine	Information													
Eng. N52 B30 A, N52 B30 B, N52 B30 BF	x 6, DELPHI, COIL ON PLUG									1.970.475	C10			
Eng. N53 B30 A	x 6, BOSCH, COIL ON PLUG									1.970.607	C10			
ENGINE														
645 Ci	Petrol	245	09/03-08/05	N62 B44 A										
Engine	Information													
All engines	x 8, ELDOR, COIL ON PLUG									1.970.475	C10			
ENGINE														
650 i	Petrol	270	09/05-08/10	N62 B48 B										
Engine	Information													
All engines	x 8, DELPHI, ELDOR, COIL ON PLUG									1.970.475	C10			
6 III														
ENGINE														
640 i	Petrol	235	07/11-10/18	N55 B30 A										
Engine	Information													
All engines	x 6, DELPHI, COIL ON PLUG									1.970.475	C10			
ENGINE														
640 i xDrive	Petrol	235	03/13-10/18	N55 B30 A										
Engine	Information													
All engines	x 6, DELPHI, COIL ON PLUG									1.970.475	C10			
ENGINE														
650 i	Petrol	298	09/11-12/12	N63 B44 A										
Engine	Information													
All engines	x 8, ELDOR, COIL ON PLUG									1.970.475	C10			
ENGINE														
650 i	Petrol	300	12/10-06/12	N63 B44 A										
Engine	Information													
All engines	x 8, DELPHI, ELDOR, COIL ON PLUG									1.970.475	C10			
ENGINE														
650 i	Petrol	330	07/12-10/18	N63 B44 A, N63 B44 B										
Engine	Information													
Eng. N63 B44 A	Qty: 8									1.970.475	C10			
Eng. N63 B44 B	x 8, BOSCH, DELPHI, COIL ON PLUG									1.970.475	C10			
ENGINE														
650 i xDrive	Petrol	0	11/11->	N63 B40 A										
Engine	Information													
All engines	Qty: 8									1.970.475	C10			
ENGINE														
650 i xDrive	Petrol	300	09/11-02/15	N63 B44 A										
Engine	Information													
All engines	x 8, DELPHI, ELDOR, COIL ON PLUG									1.970.475	C10			
ENGINE														
650 i xDrive	Petrol	330	07/12-10/18	N63 B44 A, N63 B44 B										
Engine	Information													
Eng. N63 B44 A	Qty: 8									1.970.475	C10			
Eng. N63 B44 B	x 8, BOSCH, DELPHI, COIL ON PLUG									1.970.475	C10			
ENGINE														
650 i xDrive 4.0	Petrol	330	06/11->	N63 B40 A										
Engine	Information													
All engines	Qty: 8									1.970.475	C10			
ENGINE														
M6	Petrol	412	03/12-10/18	S63 B44 B										
Engine	Information													
All engines	x 8, BOSCH, DELPHI, COIL ON PLUG									1.970.475	C10			
ENGINE														
M6 Competition	Petrol	423	07/13-02/15	S63 B44 B										
Engine	Information													
All engines	x 8, BOSCH, COIL ON PLUG									1.970.475	C10			

A10 CONDENSER	A20 CONTACT SET	A40 DISTRIBUTOR CAP	A50 ROTOR	A70 PICK-UP
C10 COIL	C20 IGNITION MODULE	C30 ELECTRONIC IGNITION KIT	E01 IGNITION CABLE SET	

The present application list is a brief version. For the detailed information about the possibility of installation on a specific vehicle, please refer to our web-catalogue <http://catalogo.facet.eu/>









				FUNCTIONS ON THE VEHICLE								
Vehicle	alim.	kW	Date	Engine								
				ENGINE								
M6 Competition	Petrol	441	03/15-10/18	S63 B44 B								
Engine	Information			A10	A20	A40	A50	A70	C10 - C30	C20	E01	
All engines	x 8, BOSCH, DELPHI, COIL ON PLUG								1.970.475	C10		
				6 IV GT								
				ENGINE								
630 i	Petrol	183	06/17-06/20	B48 B20 B								
Engine	Information			A10	A20	A40	A50	A70	C10 - C30	C20	E01	
All engines	->year 01/06/19, x 4, COIL ON PLUG 01/07/19->, x 4, COIL ON PLUG								1.970.632	C10		
				ENGINE								
630 i	Petrol	190	07/17-06/20	B48 B20 B								
Engine	Information			A10	A20	A40	A50	A70	C10 - C30	C20	E01	
All engines	x 4, COIL ON PLUG								1.970.632	C10		
				ENGINE								
630 i Mild-Hybrid	Petrol/ Electric	190	07/20->	B48 B20 B								
Engine	Information			A10	A20	A40	A50	A70	C10 - C30	C20	E01	
All engines	x 4, COIL ON PLUG								1.970.632	C10		
				ENGINE								
630 i xDrive	Petrol	190	07/19->	B58 B30 C								
Engine	Information			A10	A20	A40	A50	A70	C10 - C30	C20	E01	
All engines	x 6, COIL ON PLUG								1.970.632	C10		
				ENGINE								
640 i	Petrol	250	06/17-06/20	B58 B30 A, B58 B30 C								
Engine	Information			A10	A20	A40	A50	A70	C10 - C30	C20	E01	
All engines	x 6, COIL ON PLUG								1.970.632	C10		
				ENGINE								
640 i	Petrol	265	06/17-06/20	B58 B30 A, B58 B30 C								
Engine	Information			A10	A20	A40	A50	A70	C10 - C30	C20	E01	
All engines	x 6, COIL ON PLUG								1.970.632	C10		
				ENGINE								
640 i Mild-Hybrid	Petrol/ Electric	245	07/20->	B58 B30 C								
Engine	Information			A10	A20	A40	A50	A70	C10 - C30	C20	E01	
All engines	x 6, COIL ON PLUG								1.970.632	C10		
				ENGINE								
640 i Mild-Hybrid xDrive	Petrol/ Electric	245	07/20->	B58 B30 C								
Engine	Information			A10	A20	A40	A50	A70	C10 - C30	C20	E01	
All engines	x 6, COIL ON PLUG								1.970.632	C10		
				ENGINE								
640 i xDrive	Petrol	250	06/17-06/20	B58 B30 A, B58 B30 C								
Engine	Information			A10	A20	A40	A50	A70	C10 - C30	C20	E01	
All engines	x 6, COIL ON PLUG								1.970.632	C10		
				ENGINE								
640 i xDrive	Petrol	265	06/17-06/20	B58 B30 A, B58 B30 C								
Engine	Information			A10	A20	A40	A50	A70	C10 - C30	C20	E01	
All engines	x 6, COIL ON PLUG								1.970.632	C10		
				7 I								
				ENGINE								
728	Petrol	125	05/77-08/79	M30 B28								
Engine	Information			A10	A20	A40	A50	A70	C10 - C30	C20	E01	
All engines	version Bosch					1.306.081						
All engines										1.965.005		
				ENGINE								
728 i	Petrol	135	09/77-08/86	M30 B28								
Engine	Information			A10	A20	A40	A50	A70	C10 - C30	C20	E01	
All engines	->year 31/12/80, version Bosch					1.306.081						
All engines										1.965.005		

A10 CONDENSER	A20 CONTACT SET	A40 DISTRIBUTOR CAP	A50 ROTOR	A70 PICK-UP
C10 COIL	C20 IGNITION MODULE	C30 ELECTRONIC IGNITION KIT	E01 IGNITION CABLE SET	

Vehicle	alim.	kW	Date	Engine	FUNCTIONS ON THE VEHICLE									
					A10	A20	A40	A50	A70	C10 - C30	C20	E01		
ENGINE														
730	Petrol	135	05/77-08/79	M30 B30										
ENGINE														
Engine	Information			A10	A20	A40	A50	A70	C10 - C30	C20	E01			
All engines	version Bosch					1.306.081								
All engines										1.965.005				
ENGINE														
735 i	Petrol	141	04/85-08/86	M30 B35 (Motronic)										
ENGINE														
Engine	Information			A10	A20	A40	A50	A70	C10 - C30	C20	E01			
All engines	version Bosch					1.306.238	1.406.119R							
ENGINE														
7 II														
ENGINE														
730 i, iL	Petrol	138	03/87-03/94	M30 B30 (306KA)										
ENGINE														
Engine	Information			A10	A20	A40	A50	A70	C10 - C30	C20	E01			
All engines	version Bosch					1.306.238	1.406.119R							
All engines	->year 30/09/88, 01/03/88 ->												1.500.578	
ENGINE														
730 i, iL	Petrol	145	03/85-01/89	M30 B30 (306EA)										
ENGINE														
Engine	Information			A10	A20	A40	A50	A70	C10 - C30	C20	E01			
All engines	version Bosch					1.306.238	1.406.119R							
All engines	->year 30/09/88, 01/03/88 ->												1.500.578	
ENGINE														
730 i, iL V8	Petrol	160	04/92-09/94	M60 B30 (308S1)										
ENGINE														
Engine	Information			A10	A20	A40	A50	A70	C10 - C30	C20	E01			
All engines	without spark plug connector, Qty: 8								1.970.162S	C10				
All engines	incl. spark plug connector, Qty: 8								1.970.412	C10				
ENGINE														
735 i, iL	Petrol	155	06/86-07/92	M30 B34 (346KB)										
ENGINE														
Engine	Information			A10	A20	A40	A50	A70	C10 - C30	C20	E01			
All engines	version Bosch					1.306.238	1.406.119R							
All engines	01/03/88 ->, ->year 30/09/88												1.500.578	
ENGINE														
735 i, iL	Petrol	162	07/86-01/89	M30 B35 (Motronic, 9.2:1)										
ENGINE														
Engine	Information			A10	A20	A40	A50	A70	C10 - C30	C20	E01			
All engines	version Bosch					1.306.238	1.406.119R							
All engines	01/03/88 ->, ->year 30/09/88												1.500.578	
ENGINE														
740 i, iL V8	Petrol	210	05/92-03/94	M60 B40 (408S1)										
ENGINE														
Engine	Information			A10	A20	A40	A50	A70	C10 - C30	C20	E01			
All engines	without spark plug connector, Qty: 8								1.970.162S	C10				
All engines	incl. spark plug connector, Qty: 8								1.970.412	C10				
ENGINE														
750 i, iL V12	Petrol	220	09/87-09/94	M70 B50 (5012A)										
ENGINE														
Engine	Information			A10	A20	A40	A50	A70	C10 - C30	C20	E01			
All engines	Qty: 2, version Bosch					1.306.238	1.406.119R							
All engines	to engine cylinder:1-6								1.970.112	C10				
ENGINE														
7 III														
ENGINE														
728 i, iL	Petrol	142	08/95-11/01	M52 B28 (286S1), M52 B28 (286S2)										
ENGINE														
Engine	Information			A10	A20	A40	A50	A70	C10 - C30	C20	E01			
All engines	without spark plug connector, Qty: 6								1.970.352	C10				
All engines	incl. spark plug connector, Qty: 6								1.970.413	C10				
ENGINE														
728i X	Petrol	142	11/95-09/01	M52 B28 (286S1)										
ENGINE														
Engine	Information			A10	A20	A40	A50	A70	C10 - C30	C20	E01			
All engines	without spark plug connector, Qty: 6								1.970.352	C10				
All engines	incl. spark plug connector, Qty: 6								1.970.413	C10				
ENGINE														
730 i, iL	Petrol	155	10/94-11/01	M60 B30 (308S1)										
ENGINE														
Engine	Information			A10	A20	A40	A50	A70	C10 - C30	C20	E01			
All engines	without spark plug connector, Qty: 8								1.970.162S	C10				

A10	CONDENSER	A20	CONTACT SET	A40	DISTRIBUTOR CAP	A50	ROTOR	A70	PICK-UP
C10	COIL	C20	IGNITION MODULE	C30	ELECTRONIC IGNITION KIT	E01	IGNITION CABLE SET		

The present application list is a brief version. For the detailed information about the possibility of installation on a specific vehicle, please refer to our web-catalogue <http://catalogo.facet.eu/>





					FUNCTIONS ON THE VEHICLE							
Vehicle	alim.	kW	Date	Engine								
ENGINE												
730 i, iL	Petrol	155	10/94-11/01	M60 B30 (308S1)								
Engine	Information				A10	A20	A40	A50	A70	C10 - C30	C20	E01
All engines	incl. spark plug connector, Qty: 8									1.970.412	C10	
ENGINE												
730 i, iL	Petrol	160	03/94-02/96	M60 B30 (308S1)								
Engine	Information				A10	A20	A40	A50	A70	C10 - C30	C20	E01
All engines	without spark plug connector, Qty: 8									1.970.1625	C10	
All engines	incl. spark plug connector, Qty: 8									1.970.412	C10	
ENGINE												
735 i, iL	Petrol	173	03/96-08/98	M62 B35 (358S1)								
Engine	Information				A10	A20	A40	A50	A70	C10 - C30	C20	E01
All engines	without spark plug connector, Qty: 8									1.970.352	C10	
All engines	incl. spark plug connector, Qty: 8									1.970.413	C10	
ENGINE												
740 i, iL	Petrol	210	03/94-07/01	M60 B40 (408S1), M62 B44 (448S1), M62 B44 (448S2)								
Engine	Information				A10	A20	A40	A50	A70	C10 - C30	C20	E01
Eng. M60 B40 (408S1)	without spark plug connector, Qty: 8									1.970.1625	C10	
Eng. M62 B44 (448S1), M62 B44 (448S2)	without spark plug connector, Qty: 8									1.970.352	C10	
Eng. M60 B40 (408S1)	incl. spark plug connector, Qty: 8									1.970.412	C10	
Eng. M62 B44 (448S1), M62 B44 (448S2)	incl. spark plug connector, Qty: 8									1.970.413	C10	
ENGINE												
750 i, iL	Petrol	240	11/94-07/01	M73 B54 (54121), M73 B54 (54122)								
Engine	Information				A10	A20	A40	A50	A70	C10 - C30	C20	E01
All engines	Qty: 2, version Bosch						1.306.238	1.406.119R				
7 IV												
ENGINE												
730 i, Li	Petrol	170	03/03-07/08	1CYA, M54 B30 (306S3)								
Engine	Information				A10	A20	A40	A50	A70	C10 - C30	C20	E01
Eng. 1CYA	x 6, DELPHI, COIL ON PLUG									1.970.475	C10	
Eng. M54 B30 (306S3)	Qty: 6									1.970.475	C10	
ENGINE												
730 i, Li	Petrol	184	03/05-07/08	N52 B30 A								
Engine	Information				A10	A20	A40	A50	A70	C10 - C30	C20	E01
All engines	Qty: 6									1.970.475	C10	
ENGINE												
730 i, Li	Petrol	190	03/05-08/08	N52 B30 A, N52 B30 BF								
Engine	Information				A10	A20	A40	A50	A70	C10 - C30	C20	E01
All engines	x 6, BOSCH, DELPHI, ELDOR, COIL ON PLUG									1.970.475	C10	
ENGINE												
730 i, Li	Petrol	190	03/05->	N52 B30 B								
Engine	Information				A10	A20	A40	A50	A70	C10 - C30	C20	E01
All engines	Qty: 6									1.970.475	C10	
ENGINE												
735 i, Li	Petrol	200	11/01-02/05	N62 B36 A								
Engine	Information				A10	A20	A40	A50	A70	C10 - C30	C20	E01
All engines	x 8, ELDOR, COIL ON PLUG									1.970.475	C10	
ENGINE												
740 i, Li	Petrol	225	03/05-08/08	N62 B40 A								
Engine	Information				A10	A20	A40	A50	A70	C10 - C30	C20	E01
All engines	x 8, DELPHI, ELDOR, COIL ON PLUG									1.970.475	C10	
ENGINE												
745 i, Li	Petrol	245	07/01-03/05	N62 B44 A								
Engine	Information				A10	A20	A40	A50	A70	C10 - C30	C20	E01
All engines	x 8, DELPHI, ELDOR, COIL ON PLUG									1.970.475	C10	

A10 CONDENSER	A20 CONTACT SET	A40 DISTRIBUTOR CAP	A50 ROTOR	A70 PICK-UP
C10 COIL	C20 IGNITION MODULE	C30 ELECTRONIC IGNITION KIT	E01 IGNITION CABLE SET	

Vehicle	alim.	kW	Date	Engine	FUNCTIONS ON THE VEHICLE									
					A10	A20	A40	A50	A70	C10 - C30	C20	E01		
ENGINE														
750 i, Li	Petrol	270	03/05-08/08	N62 B48 B										
Engine	Information				A10	A20	A40	A50	A70	C10 - C30	C20	E01		
All engines	x 8, DELPHI, ELDOR, COIL ON PLUG									1.970.475	C10			
ENGINE														
760 i, Li	Petrol	327	01/03-08/08	N73 B60 A, N73 B60 B										
Engine	Information				A10	A20	A40	A50	A70	C10 - C30	C20	E01		
All engines	x 12, ELDOR, COIL ON PLUG									1.970.475	C10			
ENGINE														
B7 Alpina	Petrol	0	01/06->	H1										
Engine	Information				A10	A20	A40	A50	A70	C10 - C30	C20	E01		
All engines	Qty: 8									1.970.475	C10			
7 V														
ENGINE														
730 i, Li	Petrol	190	09/09-06/15	N52 B30 A, N52 B30 AF, N52 B30 BF										
Engine	Information				A10	A20	A40	A50	A70	C10 - C30	C20	E01		
All engines	x 6, DELPHI, COIL ON PLUG									1.970.475	C10			
ENGINE														
740 i, Li	Petrol	235	07/12-12/15	N55 B30 A										
Engine	Information				A10	A20	A40	A50	A70	C10 - C30	C20	E01		
All engines	x 6, DELPHI, COIL ON PLUG									1.970.475	C10			
ENGINE														
740 i, Li	Petrol	240	09/08-06/12	N54 B30 A										
Engine	Information				A10	A20	A40	A50	A70	C10 - C30	C20	E01		
All engines	x 6, DELPHI, ELDOR, COIL ON PLUG									1.970.475	C10			
ENGINE														
740 i, Li xDrive	Petrol	235	07/12-12/15	N55 B30 A										
Engine	Information				A10	A20	A40	A50	A70	C10 - C30	C20	E01		
All engines	x 6, DELPHI, COIL ON PLUG									1.970.475	C10			
ENGINE														
750 i, Li	Petrol	300	09/08-06/12	N63 B44 A										
Engine	Information				A10	A20	A40	A50	A70	C10 - C30	C20	E01		
All engines	x 8, DELPHI, ELDOR, COIL ON PLUG									1.970.475	C10			
ENGINE														
750 i, Li	Petrol	330	07/12-06/15	N63 B44 B										
Engine	Information				A10	A20	A40	A50	A70	C10 - C30	C20	E01		
All engines	x 8, BOSCH, COIL ON PLUG									1.970.475	C10			
ENGINE														
750 i, Li xDrive	Petrol	300	09/09-06/12	N63 B44 A, N63 B44 B										
Engine	Information				A10	A20	A40	A50	A70	C10 - C30	C20	E01		
Eng. N63 B44 A	x 8, DELPHI, ELDOR, COIL ON PLUG									1.970.475	C10			
Eng. N63 B44 B	Qty: 8									1.970.475	C10			
ENGINE														
750 i, Li xDrive	Petrol	330	07/12-06/15	N63 B44 B										
Engine	Information				A10	A20	A40	A50	A70	C10 - C30	C20	E01		
All engines	x 8, BOSCH, COIL ON PLUG									1.970.475	C10			
ENGINE														
750Li xDrive	Petrol	0	01/11->	N63 B40 A										
Engine	Information				A10	A20	A40	A50	A70	C10 - C30	C20	E01		
All engines	Qty: 8									1.970.475	C10			
ENGINE														
760 i, Li	Petrol	400	09/09-12/15	N74 B60 A										
Engine	Information				A10	A20	A40	A50	A70	C10 - C30	C20	E01		
All engines	x 12, DELPHI, COIL ON PLUG									1.970.475	C10			
ENGINE														
ActiveHybrid 7	Petrol/ Electric	235	08/12-06/15	N55 B30 A										
Engine	Information				A10	A20	A40	A50	A70	C10 - C30	C20	E01		
All engines	x 6, DELPHI, COIL ON PLUG									1.970.475	C10			

A10 CONDENSER	A20 CONTACT SET	A40 DISTRIBUTOR CAP	A50 ROTOR	A70 PICK-UP
C10 COIL	C20 IGNITION MODULE	C30 ELECTRONIC IGNITION KIT	E01 IGNITION CABLE SET	

The present application list is a brief version. For the detailed information about the possibility of installation on a specific vehicle, please refer to our web-catalogue <http://catalogo.facet.eu/>









					FUNCTIONS ON THE VEHICLE							
Vehicle	alim.	kW	Date	Engine								
ENGINE												
ActiveHybrid 7	Petrol/ Electric	260	08/12-06/15	N55 B30 A								
Engine	Information				A10	A20	A40	A50	A70	C10 - C30	C20	E01
All engines	x 6, DELPHI, COIL ON PLUG									1.970.475	C10	
ENGINE												
ActiveHybrid 7	Petrol/ Electric	330	04/10-06/12	N63 B44 A								
Engine	Information				A10	A20	A40	A50	A70	C10 - C30	C20	E01
All engines	x 8, DELPHI, ELDOR, COIL ON PLUG									1.970.475	C10	
ENGINE												
ActiveHybrid 7	Petrol/ Electric	342	04/10-06/12	N63 B44 A								
Engine	Information				A10	A20	A40	A50	A70	C10 - C30	C20	E01
All engines	x 8, DELPHI, ELDOR, COIL ON PLUG									1.970.475	C10	
7 VI												
ENGINE												
730 i	Petrol	183	11/15->	B48 B20 B								
Engine	Information				A10	A20	A40	A50	A70	C10 - C30	C20	E01
All engines	x 4, COIL ON PLUG									1.970.632	C10	
ENGINE												
730 i, Li	Petrol	190	11/15-02/19	B48 B20 B								
Engine	Information				A10	A20	A40	A50	A70	C10 - C30	C20	E01
All engines	x 4, COIL ON PLUG									1.970.632	C10	
ENGINE												
730 i, Li	Petrol	195	03/19->	B48 B20 B								
Engine	Information				A10	A20	A40	A50	A70	C10 - C30	C20	E01
All engines	x 4, COIL ON PLUG									1.970.632	C10	
ENGINE												
740 e, Le	Petrol/ Electric	190	07/16-02/19	B48 B20 B								
Engine	Information				A10	A20	A40	A50	A70	C10 - C30	C20	E01
All engines	x 4, COIL ON PLUG									1.970.632	C10	
ENGINE												
740 e, Le	Petrol/ Electric	240	07/16-02/19	B48 B20 B								
Engine	Information				A10	A20	A40	A50	A70	C10 - C30	C20	E01
All engines	x 4, COIL ON PLUG									1.970.632	C10	
ENGINE												
740 i, Li	Petrol	240	07/15-02/19	B58 B30 A								
Engine	Information				A10	A20	A40	A50	A70	C10 - C30	C20	E01
All engines	x 6, COIL ON PLUG									1.970.632	C10	
ENGINE												
740 i, Li	Petrol	250	03/19->	B58 B30 C								
Engine	Information				A10	A20	A40	A50	A70	C10 - C30	C20	E01
All engines	x 6, COIL ON PLUG									1.970.632	C10	
ENGINE												
740 Le xDrive	Petrol/ Electric	190	07/16-02/19	B48 B20 B								
Engine	Information				A10	A20	A40	A50	A70	C10 - C30	C20	E01
All engines	x 4, COIL ON PLUG									1.970.632	C10	
ENGINE												
740 Le xDrive	Petrol/ Electric	240	07/16-02/19	B48 B20 B								
Engine	Information				A10	A20	A40	A50	A70	C10 - C30	C20	E01
All engines	x 4, COIL ON PLUG									1.970.632	C10	
ENGINE												
740 Li xDrive	Petrol	240	03/16-02/19	B58 B30 A								
Engine	Information				A10	A20	A40	A50	A70	C10 - C30	C20	E01
All engines	x 6, COIL ON PLUG									1.970.632	C10	

A10 CONDENSER	A20 CONTACT SET	A40 DISTRIBUTOR CAP	A50 ROTOR	A70 PICK-UP
C10 COIL	C20 IGNITION MODULE	C30 ELECTRONIC IGNITION KIT	E01 IGNITION CABLE SET	

Vehicle	alim.	kW	Date	Engine	FUNCTIONS ON THE VEHICLE									
					A10	A20	A40	A50	A70	C10 - C30	C20	E01		
ENGINE														
740 Li xDrive	Petrol	250	03/19->	B58 B30 C										
ENGINE														
All engines					x 6, COIL ON PLUG						1,970.632	C10		
ENGINE														
745 e, Le Plug-in-Hybrid	Petrol/ Electric	210	03/19->	B58 B30 C										
ENGINE														
All engines					x 6, COIL ON PLUG						1,970.632	C10		
ENGINE														
745 e, Le Plug-in-Hybrid	Petrol/ Electric	290	03/19->	B58 B30 C										
ENGINE														
All engines					x 6, COIL ON PLUG						1,970.632	C10		
ENGINE														
745 Le Plug-in-Hybrid xDrive	Petrol/ Electric	210	03/19->	B58 B30 C										
ENGINE														
All engines					x 6, COIL ON PLUG						1,970.632	C10		
ENGINE														
745 Le Plug-in-Hybrid xDrive	Petrol/ Electric	290	03/19->	B58 B30 C										
ENGINE														
All engines					x 6, COIL ON PLUG						1,970.632	C10		
ENGINE														
750 i, Li	Petrol	330	11/15-02/19	N63 B44 C										
ENGINE														
All engines					x 8, DELPHI, COIL ON PLUG						1,970.475	C10		
ENGINE														
750 i, Li xDrive	Petrol	330	09/15-02/19	N63 B44 C										
ENGINE														
All engines					x 8, DELPHI, COIL ON PLUG						1,970.475	C10		
ENGINE														
750 Li xDrive	Petrol	330	03/16->	N63 B40 B										
ENGINE														
All engines					x 8, DELPHI, COIL ON PLUG						1,970.475	C10		
ENGINE														
M 760 i, Li xDrive	Petrol	448	12/16-02/19	N74 B66 B										
ENGINE														
All engines					x 12, DELPHI, COIL ON PLUG						1,970.475	C10		
ENGINE														
M 760 Li xDrive	Petrol	430	03/19->	N74 B66 C										
ENGINE														
All engines					x 12, DELPHI, COIL ON PLUG						1,970.475	C10		
ENGINE														
8														
ENGINE														
840 Ci	Petrol	210	03/96-06/99	M62 B44 (448S1)										
ENGINE														
All engines					without spark plug connector, Qty: 8						1,970.352	C10		
All engines					incl. spark plug connector, Qty: 8						1,970.413	C10		
ENGINE														
840 i	Petrol	210	03/93-02/96	M60 B40 (408S1)										
ENGINE														
All engines					without spark plug connector, Qty: 8						1,970.1625	C10		
All engines					incl. spark plug connector, Qty: 8						1,970.412	C10		
ENGINE														
840 i	Petrol	245	11/20->	B58 B30 C										
ENGINE														
All engines					x 6, COIL ON PLUG						1,970.632	C10		

A10	CONDENSER	A20	CONTACT SET	A40	DISTRIBUTOR CAP	A50	ROTOR	A70	PICK-UP
C10	COIL	C20	IGNITION MODULE	C30	ELECTRONIC IGNITION KIT	E01	IGNITION CABLE SET		

The present application list is a brief version. For the detailed information about the possibility of installation on a specific vehicle, please refer to our web-catalogue <http://catalogo.facet.eu/>









				FUNCTIONS ON THE VEHICLE								
Vehicle	alim.	kW	Date	Engine								
				ENGINE								
840 i	Petrol	250	07/19-10/20	B58 B30 C								
				ENGINE								
Engine		Information			A10	A20	A40	A50	A70	C10 - C30	C20	E01
All engines		x 6, COIL ON PLUG								1.970.632	C10	
840 i xDrive	Petrol	245	11/20->	B58 B30 C								
				ENGINE								
Engine		Information			A10	A20	A40	A50	A70	C10 - C30	C20	E01
All engines		x 6, COIL ON PLUG								1.970.632	C10	
840 i xDrive	Petrol	250	07/19->	B58 B30 C								
				ENGINE								
Engine		Information			A10	A20	A40	A50	A70	C10 - C30	C20	E01
All engines		x 6, COIL ON PLUG								1.970.632	C10	
850 Si	Petrol	280	11/92-12/96	S70 B56 (56121)								
				ENGINE								
Engine		Information			A10	A20	A40	A50	A70	C10 - C30	C20	E01
All engines		Qty: 2, version Bosch					1.306.238	1.406.119R				
All engines		to engine cylinder:1-6								1.970.112	C10	
850 i, Ci	Petrol	220	01/90-08/94	M70 B50 (5012A)								
				ENGINE								
Engine		Information			A10	A20	A40	A50	A70	C10 - C30	C20	E01
All engines		Qty: 2, version Bosch					1.306.238	1.406.119R				
All engines		to engine cylinder:1-6								1.970.112	C10	
M8	Petrol	441	07/19->	S63 B44 B								
				ENGINE								
Engine		Information			A10	A20	A40	A50	A70	C10 - C30	C20	E01
All engines		x 8, DELPHI, COIL ON PLUG								1.970.475	C10	
M8 Competition	Petrol	460	07/19->	S63 B44 B								
				ENGINE								
Engine		Information			A10	A20	A40	A50	A70	C10 - C30	C20	E01
All engines		x 8, DELPHI, COIL ON PLUG								1.970.475	C10	
X1 I												
sDrive 16 i	Petrol	105	03/13-06/15	N20 B16 A								
				ENGINE								
Engine		Information			A10	A20	A40	A50	A70	C10 - C30	C20	E01
All engines		x 4, DELPHI, COIL ON PLUG								1.970.475	C10	
sDrive 18 i	Petrol	100	03/10-06/15	N46 B20 B								
				ENGINE								
Engine		Information			A10	A20	A40	A50	A70	C10 - C30	C20	E01
All engines		x 4, ELDOR, COIL ON PLUG								1.970.475	C10	
sDrive 18 i	Petrol	110	03/10-06/15	N46 B20 B, N46 B20 BD								
				ENGINE								
Engine		Information			A10	A20	A40	A50	A70	C10 - C30	C20	E01
All engines		x 4, ELDOR, COIL ON PLUG								1.970.475	C10	
sDrive 18 i [CHN]	Petrol	135	01/13->	N20 B20 C								
				ENGINE								
Engine		Information			A10	A20	A40	A50	A70	C10 - C30	C20	E01
All engines		Qty: 4								1.970.475	C10	
sDrive 20 i	Petrol	135	09/11-06/15	N20 B20 A								
				ENGINE								
Engine		Information			A10	A20	A40	A50	A70	C10 - C30	C20	E01
All engines		x 4, DELPHI, COIL ON PLUG								1.970.475	C10	
sDrive 28 i [USA]	Petrol	180	01/09->	N20 B20 A								
				ENGINE								
Engine		Information			A10	A20	A40	A50	A70	C10 - C30	C20	E01
All engines		Qty: 4								1.970.475	C10	
xDrive 20 i	Petrol	135	09/11-06/15	N20 B20 A								
				ENGINE								
Engine		Information			A10	A20	A40	A50	A70	C10 - C30	C20	E01
All engines		x 4, DELPHI, COIL ON PLUG								1.970.475	C10	

A10 CONDENSER	A20 CONTACT SET	A40 DISTRIBUTOR CAP	A50 ROTOR	A70 PICK-UP
C10 COIL	C20 IGNITION MODULE	C30 ELECTRONIC IGNITION KIT	E01 IGNITION CABLE SET	

Vehicle	alim.	kW	Date	Engine	FUNCTIONS ON THE VEHICLE									
					A10	A20	A40	A50	A70	C10 - C30	C20	E01		
ENGINE														
xDrive 25 i	Petrol	160	03/10-08/11	N52 B30 A										
Engine	Information				A10	A20	A40	A50	A70	C10 - C30	C20	E01		
All engines	x 6, DELPHI, ELDOR, COIL ON PLUG									1.970.475	C10			
ENGINE														
xDrive 28 i	Petrol	180	03/11-06/15	N20 B20 A										
Engine	Information				A10	A20	A40	A50	A70	C10 - C30	C20	E01		
All engines	x 4, DELPHI, COIL ON PLUG									1.970.475	C10			
ENGINE														
xDrive 28 i	Petrol	190	09/09-08/11	N52 B30 A										
Engine	Information				A10	A20	A40	A50	A70	C10 - C30	C20	E01		
All engines	x 6, DELPHI, COIL ON PLUG									1.970.475	C10			
ENGINE														
xDrive 28 i	Petrol	194	03/10-06/11	N52 B30 A										
Engine	Information				A10	A20	A40	A50	A70	C10 - C30	C20	E01		
All engines	x 6, DELPHI, COIL ON PLUG									1.970.475	C10			
ENGINE														
xDrive 35 i	Petrol	225	03/11-06/15	N55 B30 A										
Engine	Information				A10	A20	A40	A50	A70	C10 - C30	C20	E01		
All engines	Qty: 6									1.970.475	C10			
X1 II														
ENGINE														
sDrive 18 i	Petrol	100	11/15->	B38 A15 A										
Engine	Information				A10	A20	A40	A50	A70	C10 - C30	C20	E01		
All engines	x 3, COIL ON PLUG									1.970.632	C10			
ENGINE														
sDrive 18 i	Petrol	103	07/17->	B38 A15 A										
Engine	Information				A10	A20	A40	A50	A70	C10 - C30	C20	E01		
All engines	x 3, COIL ON PLUG									1.970.632	C10			
ENGINE														
sDrive 20 i	Petrol	131	11/20->	B48 A20 A, B48 A20 F										
Engine	Information				A10	A20	A40	A50	A70	C10 - C30	C20	E01		
All engines	x 4, COIL ON PLUG									1.970.632	C10			
ENGINE														
sDrive 20 i	Petrol	141	07/15->	B48 A20 A, B48 A20 F										
Engine	Information				A10	A20	A40	A50	A70	C10 - C30	C20	E01		
All engines	x 4, COIL ON PLUG									1.970.632	C10			
ENGINE														
xDrive 20 i	Petrol	131	11/20->	B48 A20 A, B48 A20 F										
Engine	Information				A10	A20	A40	A50	A70	C10 - C30	C20	E01		
All engines	x 4, COIL ON PLUG									1.970.632	C10			
ENGINE														
xDrive 20 i	Petrol	141	07/15->	B48 A20 B										
Engine	Information				A10	A20	A40	A50	A70	C10 - C30	C20	E01		
All engines	x 4, COIL ON PLUG									1.970.632	C10			
ENGINE														
xDrive 25 e Plug-in-Hybrid	Petrol/ Electric	162	03/20->	B38 A15 A										
Engine	Information				A10	A20	A40	A50	A70	C10 - C30	C20	E01		
All engines	x 3, COIL ON PLUG									1.970.632	C10			
ENGINE														
xDrive 25 e Plug-in-Hybrid	Petrol/ Electric	92	03/20->	B38 A15 A										
Engine	Information				A10	A20	A40	A50	A70	C10 - C30	C20	E01		
All engines	x 3, COIL ON PLUG									1.970.632	C10			
ENGINE														
xDrive 25 i	Petrol	170	07/15->	B46 A20 B, B48 A20 B										
Engine	Information				A10	A20	A40	A50	A70	C10 - C30	C20	E01		
All engines	x 4, COIL ON PLUG									1.970.632	C10			









A10	CONDENSER	A20	CONTACT SET	A40	DISTRIBUTOR CAP	A50	ROTOR	A70	PICK-UP
C10	COIL	C20	IGNITION MODULE	C30	ELECTRONIC IGNITION KIT	E01	IGNITION CABLE SET		

The present application list is a brief version. For the detailed information about the possibility of installation on a specific vehicle, please refer to our web-catalogue <http://catalogo.facet.eu/>

					FUNCTIONS ON THE VEHICLE							
Vehicle	alim.	kW	Date	Engine	 A10	 A20	 A40	 A50	 A70	 C10 - C30	 C20	 E01
X2												
M35 i	Petrol	225	11/18->	ENGINE B48 A20 E								
Engine		Information			A10	A20	A40	A50	A70	C10 - C30	C20	E01
All engines		x 4, COIL ON PLUG								1.970.632	C10	
sDrive 18 i												
sDrive 18 i	Petrol	100	03/18->	ENGINE B32 S15 A, B38 A15 A								
Engine		Information			A10	A20	A40	A50	A70	C10 - C30	C20	E01
All engines		x 3, COIL ON PLUG								1.970.632	C10	
sDrive 18 i												
sDrive 18 i	Petrol	103	03/18->	ENGINE B38 A15 A								
Engine		Information			A10	A20	A40	A50	A70	C10 - C30	C20	E01
All engines		x 3, COIL ON PLUG								1.970.632	C10	
sDrive 20 i												
sDrive 20 i	Petrol	131	11/20->	ENGINE B48 A20 A, B48 A20 F								
Engine		Information			A10	A20	A40	A50	A70	C10 - C30	C20	E01
All engines		x 4, COIL ON PLUG								1.970.632	C10	
sDrive 20 i												
sDrive 20 i	Petrol	141	11/17->	ENGINE B42 S20 A, B48 A20 A								
Engine		Information			A10	A20	A40	A50	A70	C10 - C30	C20	E01
All engines		x 4, COIL ON PLUG								1.970.632	C10	
xDrive 20 i												
xDrive 20 i	Petrol	131	11/20->	ENGINE B48 A20 A								
Engine		Information			A10	A20	A40	A50	A70	C10 - C30	C20	E01
All engines		x 4, COIL ON PLUG								1.970.632	C10	
xDrive 20 i												
xDrive 20 i	Petrol	141	03/18-10/20	ENGINE B48 A20 A								
Engine		Information			A10	A20	A40	A50	A70	C10 - C30	C20	E01
All engines		x 4, COIL ON PLUG								1.970.632	C10	
xDrive 25 e Plug-in-Hybrid												
xDrive 25 e Plug-in-Hybrid	Petrol/ Electric	162	03/20->	ENGINE B38 A15 A								
Engine		Information			A10	A20	A40	A50	A70	C10 - C30	C20	E01
All engines		x 3, COIL ON PLUG								1.970.632	C10	
xDrive 25 e Plug-in-Hybrid												
xDrive 25 e Plug-in-Hybrid	Petrol/ Electric	92	03/20->	ENGINE B38 A15 A								
Engine		Information			A10	A20	A40	A50	A70	C10 - C30	C20	E01
All engines		x 3, COIL ON PLUG								1.970.632	C10	
X3 I												
2.0 i	Petrol	110	07/05-08/08	ENGINE N46 B20 B								
Engine		Information			A10	A20	A40	A50	A70	C10 - C30	C20	E01
All engines		x 4, DELPHI, COIL ON PLUG								1.970.475	C10	
2.5 i												
2.5 i	Petrol	141	03/04-07/06	ENGINE M54 B25 (256S5), M54B256S5								
Engine		Information			A10	A20	A40	A50	A70	C10 - C30	C20	E01
Eng. M54 B25 (256S5)		Qty: 6								1.970.475	C10	
Eng. M54B256S5		x 6, DELPHI, COIL ON PLUG								1.970.475	C10	
2.5 si												
2.5 si	Petrol	160	08/06-08/08	ENGINE N52 B25 A, N52 B25 AF, N52 B25 BF								
Engine		Information			A10	A20	A40	A50	A70	C10 - C30	C20	E01
All engines		x 6, DELPHI, COIL ON PLUG								1.970.475	C10	
2.5 si xDrive												
2.5 si xDrive	Petrol	155	08/06-08/08	ENGINE N52 B25 A, N52 B25 AF, N52 B25 BF								
Engine		Information			A10	A20	A40	A50	A70	C10 - C30	C20	E01
All engines		x 6, DELPHI, COIL ON PLUG								1.970.475	C10	

A10 CONDENSER	A20 CONTACT SET	A40 DISTRIBUTOR CAP	A50 ROTOR	A70 PICK-UP
C10 COIL	C20 IGNITION MODULE	C30 ELECTRONIC IGNITION KIT	E01 IGNITION CABLE SET	

Vehicle	alim.	kW	Date	Engine	FUNCTIONS ON THE VEHICLE											
					A10	A20	A40	A50	A70	C10 - C30	C20	E01				
ENGINE																
3.0 i xDrive	Petrol	170	09/03-07/06	M54 B30 (306S3), M54B306S3												
Engine	Information				A10	A20	A40	A50	A70	C10 - C30	C20	E01				
Eng. M54 B30 (306S3)	Qty: 6									1.970.475	C10					
Eng. M54B306S3	x 6, DELPHI, COIL ON PLUG									1.970.475	C10					
ENGINE																
3.0 si	Petrol	194	09/06-08/08	N52 B30 A, N52KB30												
Engine	Information				A10	A20	A40	A50	A70	C10 - C30	C20	E01				
All engines	x 6, DELPHI, ELDOR, COIL ON PLUG									1.970.475	C10					
Eng. N52 B30 A	Qty: 6									1.970.475	C10					
ENGINE																
3.0 si	Petrol	200	08/06-08/08	N52 B30 A, N52 B30 BF												
Engine	Information				A10	A20	A40	A50	A70	C10 - C30	C20	E01				
All engines	x 6, DELPHI, COIL ON PLUG									1.970.475	C10					
ENGINE																
xDrive 2.5si	Petrol	160	09/06->	N52 B25 BF, N52B25B												
Engine	Information				A10	A20	A40	A50	A70	C10 - C30	C20	E01				
All engines	Qty: 6									1.970.475	C10					
ENGINE																
xDrive 20 i	Petrol	110	09/08-08/11	N46 B20 B												
Engine	Information				A10	A20	A40	A50	A70	C10 - C30	C20	E01				
All engines	x 4, DELPHI, COIL ON PLUG									1.970.475	C10					
ENGINE																
xDrive 25 i	Petrol	155	09/08-08/10	N52 B25 A, N52 B25 AF, N52 B25 BF												
Engine	Information				A10	A20	A40	A50	A70	C10 - C30	C20	E01				
All engines	x 6, DELPHI, COIL ON PLUG									1.970.475	C10					
ENGINE																
xDrive 25 i	Petrol	160	09/08-08/10	N52 B25 A, N52 B25 AF, N52 B25 BF												
Engine	Information				A10	A20	A40	A50	A70	C10 - C30	C20	E01				
All engines	x 6, DELPHI, COIL ON PLUG									1.970.475	C10					
ENGINE																
xDrive 3.0si	Petrol	200	09/06->	N52 B30 B, N52 B30 BF												
Engine	Information				A10	A20	A40	A50	A70	C10 - C30	C20	E01				
All engines	Qty: 6									1.970.475	C10					
ENGINE																
xDrive 30 i	Petrol	200	09/08-08/10	N52 B30 A, N52 B30 BF												
Engine	Information				A10	A20	A40	A50	A70	C10 - C30	C20	E01				
All engines	x 6, DELPHI, COIL ON PLUG									1.970.475	C10					
X3 II																
ENGINE																
sDrive 20 i	Petrol	125	04/14-08/17	N20 B16 A												
Engine	Information				A10	A20	A40	A50	A70	C10 - C30	C20	E01				
All engines	x 4, DELPHI, COIL ON PLUG									1.970.475	C10					
ENGINE																
sDrive 20 i	Petrol	135	04/14-08/17	N20 B20 A												
Engine	Information				A10	A20	A40	A50	A70	C10 - C30	C20	E01				
All engines	x 4, DELPHI, COIL ON PLUG									1.970.475	C10					
ENGINE																
sDrive 28 i [USA]	Petrol	135	01/13->	N20 B20 A												
Engine	Information				A10	A20	A40	A50	A70	C10 - C30	C20	E01				
All engines	Qty: 4									1.970.475	C10					
ENGINE																
xDrive 20 i	Petrol	135	10/11-08/17	N20 B20 A												
Engine	Information				A10	A20	A40	A50	A70	C10 - C30	C20	E01				
All engines	x 4, DELPHI, COIL ON PLUG									1.970.475	C10					
ENGINE																
xDrive 28 i	Petrol	180	04/12-08/17	N20 B20 A												
Engine	Information				A10	A20	A40	A50	A70	C10 - C30	C20	E01				
All engines	x 4, DELPHI, COIL ON PLUG									1.970.475	C10					
ENGINE																
A10	CONDENSER			A20	CONTACT SET			A40	DISTRIBUTOR CAP		A50	ROTOR		A70	PICK-UP	
C10	COIL			C20	IGNITION MODULE			C30	ELECTRONIC IGNITION KIT		E01	IGNITION CABLE SET				









					FUNCTIONS ON THE VEHICLE							
Vehicle	alim.	kW	Date	Engine	 A10	 A20	 A40	 A50	 A70	 C10 - C30	 C20	 E01
ENGINE												
xDrive 28 i	Petrol	190	01/11-10/12	N52 B30 A, N52 B30 AF, N52 B30 BF								
Engine	Information				A10	A20	A40	A50	A70	C10 - C30	C20	E01
All engines	x 6, DELPHI, ELDOR, COIL ON PLUG									1.970.475	C10	
ENGINE												
xDrive 35 i	Petrol	225	09/10-08/17	N55 B30 A								
Engine	Information				A10	A20	A40	A50	A70	C10 - C30	C20	E01
All engines	x 6, DELPHI, COIL ON PLUG									1.970.475	C10	
X3 III												
ENGINE												
M	Petrol	353	03/19->	S58 B30 A								
Engine	Information				A10	A20	A40	A50	A70	C10 - C30	C20	E01
All engines	x 6, COIL ON PLUG									1.970.632	C10	
ENGINE												
M Competition	Petrol	375	03/19->	S58 B30 A								
Engine	Information				A10	A20	A40	A50	A70	C10 - C30	C20	E01
All engines	x 6, COIL ON PLUG									1.970.632	C10	
ENGINE												
sDrive 20 i	Petrol	135	12/17->	B48 B20 A								
Engine	Information				A10	A20	A40	A50	A70	C10 - C30	C20	E01
All engines	x 4, COIL ON PLUG									1.970.632	C10	
ENGINE												
sDrive 20 i 1.6	Petrol	125	12/17->	B48 B16 A								
Engine	Information				A10	A20	A40	A50	A70	C10 - C30	C20	E01
All engines	x 4, COIL ON PLUG									1.970.632	C10	
ENGINE												
xDrive 20 i	Petrol	135	12/17->	B48 B20 A								
Engine	Information				A10	A20	A40	A50	A70	C10 - C30	C20	E01
All engines	x 4, COIL ON PLUG									1.970.632	C10	
ENGINE												
xDrive 20 i Mild Hybrid	Petrol/ Electric	135	08/21->	B48 B20 B								
Engine	Information				A10	A20	A40	A50	A70	C10 - C30	C20	E01
All engines	x 4, COIL ON PLUG									1.970.632	C10	
ENGINE												
xDrive 30 e Plug-in-Hybrid	Petrol/ Electric	120	12/19->	B48 B20 A								
Engine	Information				A10	A20	A40	A50	A70	C10 - C30	C20	E01
All engines	x 4, COIL ON PLUG									1.970.632	C10	
ENGINE												
xDrive 30 e Plug-in-Hybrid	Petrol/ Electric	135	12/19->	B46 B20 B, B48 B20 A								
Engine	Information				A10	A20	A40	A50	A70	C10 - C30	C20	E01
All engines	x 4, COIL ON PLUG									1.970.632	C10	
ENGINE												
xDrive 30 e Plug-in-Hybrid	Petrol/ Electric	170	12/19->	B48 B20 A								
Engine	Information				A10	A20	A40	A50	A70	C10 - C30	C20	E01
All engines	x 4, COIL ON PLUG									1.970.632	C10	
ENGINE												
xDrive 30 e Plug-in-Hybrid	Petrol/ Electric	185	12/19->	B46 B20 B, B48 B20 A								
Engine	Information				A10	A20	A40	A50	A70	C10 - C30	C20	E01
All engines	x 4, COIL ON PLUG									1.970.632	C10	
ENGINE												
xDrive 30 i	Petrol	183	08/17->	B48 B20 B								
Engine	Information				A10	A20	A40	A50	A70	C10 - C30	C20	E01
All engines	x 4, COIL ON PLUG									1.970.632	C10	

A10 CONDENSER	A20 CONTACT SET	A40 DISTRIBUTOR CAP	A50 ROTOR	A70 PICK-UP
C10 COIL	C20 IGNITION MODULE	C30 ELECTRONIC IGNITION KIT	E01 IGNITION CABLE SET	

Vehicle	alim.	kW	Date	Engine	FUNCTIONS ON THE VEHICLE									
					A10	A20	A40	A50	A70	C10 - C30	C20	E01		
ENGINE														
xDrive 30 i	Petrol	185	08/17->	B46 B20 B, B48 B20 B										
Engine	Information				A10	A20	A40	A50	A70	C10 - C30	C20	E01		
Eng. B46 B20 B	COIL ON PLUG, Qty: 4									1.970.632	C10			
Eng. B48 B20 B	x 4, COIL ON PLUG									1.970.632	C10			
ENGINE														
xDrive 30 i Mild Hybrid	Petrol/ Electric	180	08/21->	B48 B20 B										
Engine	Information				A10	A20	A40	A50	A70	C10 - C30	C20	E01		
All engines	x 4, COIL ON PLUG									1.970.632	C10			
ENGINE														
xDrive M40 i	Petrol	260	09/18-08/19	B58 B30 A										
Engine	Information				A10	A20	A40	A50	A70	C10 - C30	C20	E01		
All engines	x 6, COIL ON PLUG									1.970.632	C10			
ENGINE														
xDrive M40 i	Petrol	265	08/17->	B58 B30 A										
Engine	Information				A10	A20	A40	A50	A70	C10 - C30	C20	E01		
All engines	x 6, COIL ON PLUG									1.970.632	C10			
ENGINE														
xDrive M40 i	Petrol	285	09/19->	B58 B30 B										
Engine	Information				A10	A20	A40	A50	A70	C10 - C30	C20	E01		
All engines	x 6, COIL ON PLUG									1.970.632	C10			
ENGINE														
X4 I														
M 40 i	Petrol	265	12/15-03/18	N55 B30 A										
Engine	Information				A10	A20	A40	A50	A70	C10 - C30	C20	E01		
All engines	x 6, DELPHI, COIL ON PLUG									1.970.475	C10			
ENGINE														
xDrive 20 i	Petrol	135	04/14-03/18	N20 B20 A										
Engine	Information				A10	A20	A40	A50	A70	C10 - C30	C20	E01		
All engines	x 4, DELPHI, COIL ON PLUG									1.970.475	C10			
ENGINE														
xDrive 28 i	Petrol	180	04/14-03/18	N20 B20 A										
Engine	Information				A10	A20	A40	A50	A70	C10 - C30	C20	E01		
All engines	x 4, DELPHI, COIL ON PLUG									1.970.475	C10			
ENGINE														
xDrive 35 i	Petrol	225	04/14-03/18	N55 B30 A										
Engine	Information				A10	A20	A40	A50	A70	C10 - C30	C20	E01		
All engines	x 6, DELPHI, COIL ON PLUG									1.970.475	C10			
ENGINE														
X4 II														
M	Petrol	353	03/19->	S58 B30 A										
Engine	Information				A10	A20	A40	A50	A70	C10 - C30	C20	E01		
All engines	x 6, COIL ON PLUG									1.970.632	C10			
ENGINE														
M Competition	Petrol	375	03/19->	S58 B30 A										
Engine	Information				A10	A20	A40	A50	A70	C10 - C30	C20	E01		
All engines	x 6, COIL ON PLUG									1.970.632	C10			
ENGINE														
M40 i xDrive	Petrol	260	04/18-08/19	B58 B30 A										
Engine	Information				A10	A20	A40	A50	A70	C10 - C30	C20	E01		
All engines	x 6, COIL ON PLUG									1.970.632	C10			
ENGINE														
M40 i xDrive	Petrol	265	04/18->	B58 B30 A										
Engine	Information				A10	A20	A40	A50	A70	C10 - C30	C20	E01		
All engines	x 6, COIL ON PLUG									1.970.632	C10			
ENGINE														
M40 i xDrive	Petrol	285	09/19->	B58 B30 B										
Engine	Information				A10	A20	A40	A50	A70	C10 - C30	C20	E01		
All engines	x 6, COIL ON PLUG									1.970.632	C10			

A10 CONDENSER	A20 CONTACT SET	A40 DISTRIBUTOR CAP	A50 ROTOR	A70 PICK-UP
C10 COIL	C20 IGNITION MODULE	C30 ELECTRONIC IGNITION KIT	E01 IGNITION CABLE SET	

The present application list is a brief version. For the detailed information about the possibility of installation on a specific vehicle, please refer to our web-catalogue <http://catalogo.facet.eu/>









					FUNCTIONS ON THE VEHICLE							
Vehicle	alim.	kW	Date	Engine	 A10	 A20	 A40	 A50	 A70	 C10 - C30	 C20	 E01
ENGINE												
xDrive 20 i	Petrol	135	04/18->	B48 B20 A								
Engine	Information				A10	A20	A40	A50	A70	C10 - C30	C20	E01
All engines	x 4, COIL ON PLUG									1.970.632	C10	
ENGINE												
xDrive 20 i Mild Hybrid	Petrol/ Electric	135	08/21->	B46 B20 B, B48 B20 A								
Engine	Information				A10	A20	A40	A50	A70	C10 - C30	C20	E01
All engines	x 4, COIL ON PLUG									1.970.632	C10	
ENGINE												
xDrive 30 i	Petrol	183	04/18->	B48 B20 B								
Engine	Information				A10	A20	A40	A50	A70	C10 - C30	C20	E01
All engines	x 4, COIL ON PLUG									1.970.632	C10	
ENGINE												
xDrive 30 i	Petrol	185	04/18->	B48 B20 B								
Engine	Information				A10	A20	A40	A50	A70	C10 - C30	C20	E01
All engines	x 4, COIL ON PLUG									1.970.632	C10	
ENGINE												
xDrive 30 i Mild Hybrid	Petrol/ Electric	180	07/21->	B46 B20 B, B48 B20 B								
Engine	Information				A10	A20	A40	A50	A70	C10 - C30	C20	E01
All engines	x 4, COIL ON PLUG									1.970.632	C10	
X5 I												
ENGINE												
3.0 i	Petrol	163	05/00-12/06	M54 B30 (306S3)								
Engine	Information				A10	A20	A40	A50	A70	C10 - C30	C20	E01
All engines	->year 31/10/02, without spark plug connector, Qty: 6									1.970.352	C10	
All engines	->year 31/10/02, incl. spark plug connector, Qty: 6									1.970.413	C10	
All engines	01/11/02->, Qty: 6									1.970.475	C10	
ENGINE												
3.0 i	Petrol	170	04/00-10/06	5CNG, M54 B30 (306S3)								
Engine	Information				A10	A20	A40	A50	A70	C10 - C30	C20	E01
Eng. M54 B30 (306S3)	->year 31/10/02, without spark plug connector, Qty: 6									1.970.352	C10	
Eng. M54 B30 (306S3)	->year 31/10/02, incl. spark plug connector, Qty: 6									1.970.413	C10	
Eng. 5CNG	x 6, DELPHI, COIL ON PLUG									1.970.475	C10	
Eng. M54 B30 (306S3)	01/11/02->, Qty: 6									1.970.475	C10	
ENGINE												
4.4 i	Petrol	210	01/00-09/03	M62 B44 (448S2), M62B448S2								
Engine	Information				A10	A20	A40	A50	A70	C10 - C30	C20	E01
Eng. M62 B44 (448S2)	without spark plug connector, Qty: 8									1.970.352	C10	
Eng. M62B448S2	x 8, BREMI, COIL ON PLUG									1.970.352	C10	
Eng. M62 B44 (448S2)	incl. spark plug connector, Qty: 8									1.970.413	C10	
ENGINE												
4.4 i	Petrol	235	10/03-10/06	N62 B44, N62 B44 A								
Engine	Information				A10	A20	A40	A50	A70	C10 - C30	C20	E01
Eng. N62 B44	Qty: 8									1.970.475	C10	
Eng. N62 B44 A	x 8, DELPHI, ELDOR, COIL ON PLUG									1.970.475	C10	
ENGINE												
4.6 is	Petrol	255	10/01-09/03	M62 B46 (468S1), M62B468S1								
Engine	Information				A10	A20	A40	A50	A70	C10 - C30	C20	E01
Eng. M62 B46 (468S1)	without spark plug connector, Qty: 8									1.970.352	C10	
Eng. M62B468S1	x 8, BREMI, COIL ON PLUG									1.970.352	C10	
Eng. M62 B46 (468S1)	incl. spark plug connector, Qty: 8									1.970.413	C10	
ENGINE												
4.8 is	Petrol	265	04/04-09/06	N62 B48 A								
Engine	Information				A10	A20	A40	A50	A70	C10 - C30	C20	E01
All engines	x 8, DELPHI, ELDOR, COIL ON PLUG									1.970.475	C10	

A10 CONDENSER	A20 CONTACT SET	A40 DISTRIBUTOR CAP	A50 ROTOR	A70 PICK-UP
C10 COIL	C20 IGNITION MODULE	C30 ELECTRONIC IGNITION KIT	E01 IGNITION CABLE SET	

Vehicle	alim.	kW	Date	Engine	FUNCTIONS ON THE VEHICLE									
					A10	A20	A40	A50	A70	C10 - C30	C20	E01		
X5 II														
3.0 si	Petrol	200	10/06-09/08	ENGINE N52 B30 A, N52 B30 AF, N52 B30 B, N52 B30 BF										
Engine	Information													
Eng. N52 B30 A, N52 B30 AF, N52 B30 BF	x 6, DELPHI, COIL ON PLUG									1.970.475	C10			
Eng. N52 B30 B	Qty: 6									1.970.475	C10			
4.8 i xDrive	Petrol	261	10/06-09/08	ENGINE N62 B48 B										
Engine	Information													
All engines	x 8, DELPHI, COIL ON PLUG									1.970.475	C10			
M	Petrol	408	07/09-07/13	ENGINE S63 B44 A										
Engine	Information													
All engines	x 8, DELPHI, ELDOR, COIL ON PLUG									1.970.475	C10			
xDrive 30 i	Petrol	171	09/08-12/10	ENGINE N52 B30 A										
Engine	Information													
All engines	Qty: 6									1.970.475	C10			
xDrive 30 i	Petrol	172	02/07-12/12	ENGINE N52 B30 A										
Engine	Information													
All engines	x 4, DELPHI, COIL ON PLUG									1.970.475	C10			
xDrive 30 i	Petrol	200	10/08-03/10	ENGINE N52 B30 A										
Engine	Information													
All engines	x 6, DELPHI, COIL ON PLUG									1.970.475	C10			
xDrive 35 i	Petrol	225	04/10-07/13	ENGINE N55 B30 A										
Engine	Information													
All engines	x 6, DELPHI, COIL ON PLUG									1.970.475	C10			
xDrive 35 i	Petrol	235	02/12-06/13	ENGINE N55 B30 A										
Engine	Information													
All engines	x 6, DELPHI, COIL ON PLUG									1.970.475	C10			
xDrive 40 i	Petrol	225	01/12-06/13	ENGINE N55 B30 A										
Engine	Information													
All engines	x 6, DELPHI, COIL ON PLUG									1.970.475	C10			
xDrive 48 i	Petrol	261	10/08-03/10	ENGINE N62 B48 B										
Engine	Information													
All engines	x 8, DELPHI, COIL ON PLUG									1.970.475	C10			
xDrive 50 i	Petrol	300	04/10-07/13	ENGINE N63 B44 A										
Engine	Information													
All engines	x 8, DELPHI, ELDOR, COIL ON PLUG									1.970.475	C10			
X5 III														
M	Petrol	423	12/14-07/18	ENGINE S63 B44 B										
Engine	Information													
All engines	x 8, BOSCH, DELPHI, COIL ON PLUG									1.970.475	C10			
sDrive 35 i [USA]	Petrol	225	01/13->	ENGINE N55 B30 A										
Engine	Information													
All engines	Qty: 6									1.970.475	C10			
xDrive 28 i	Petrol	180	06/15-07/18	ENGINE N20 B20 A										
Engine	Information													
All engines	x 4, DELPHI, COIL ON PLUG									1.970.475	C10			

A10 CONDENSER	A20 CONTACT SET	A40 DISTRIBUTOR CAP	A50 ROTOR	A70 PICK-UP
C10 COIL	C20 IGNITION MODULE	C30 ELECTRONIC IGNITION KIT	E01 IGNITION CABLE SET	

The present application list is a brief version. For the detailed information about the possibility of installation on a specific vehicle, please refer to our web-catalogue <http://catalogo.facet.eu/>









					FUNCTIONS ON THE VEHICLE							
Vehicle	alim.	kW	Date	Engine	 A10	 A20	 A40	 A50	 A70	 C10 - C30	 C20	 E01
ENGINE												
xDrive 35 i	Petrol	225	12/13-07/18	N55 B30 A								
Engine	Information				A10	A20	A40	A50	A70	C10 - C30	C20	E01
All engines	x 6, DELPHI, COIL ON PLUG									1.970.475	C10	
ENGINE												
xDrive 35 i	Petrol	240	12/13-07/18	N55 B30 A								
Engine	Information				A10	A20	A40	A50	A70	C10 - C30	C20	E01
All engines	x 6, DELPHI, COIL ON PLUG									1.970.475	C10	
ENGINE												
xDrive 40e	Petrol/ Electric	155	08/15-07/18	N20 B20 A								
Engine	Information				A10	A20	A40	A50	A70	C10 - C30	C20	E01
All engines	x 4, DELPHI, COIL ON PLUG									1.970.475	C10	
ENGINE												
xDrive 40e	Petrol/ Electric	180	08/15-07/18	N20 B20 A								
Engine	Information				A10	A20	A40	A50	A70	C10 - C30	C20	E01
All engines	x 4, DELPHI, COIL ON PLUG									1.970.475	C10	
ENGINE												
xDrive 40e	Petrol/ Electric	205	08/15-07/18	N20 B20 A								
Engine	Information				A10	A20	A40	A50	A70	C10 - C30	C20	E01
All engines	x 4, DELPHI, COIL ON PLUG									1.970.475	C10	
ENGINE												
xDrive 40e	Petrol/ Electric	230	08/15-07/18	N20 B20 A								
Engine	Information				A10	A20	A40	A50	A70	C10 - C30	C20	E01
All engines	x 4, DELPHI, COIL ON PLUG									1.970.475	C10	
ENGINE												
xDrive 50 i	Petrol	330	08/13-07/18	N63 B44 B								
Engine	Information				A10	A20	A40	A50	A70	C10 - C30	C20	E01
All engines	x 8, BOSCH, DELPHI, COIL ON PLUG									1.970.475	C10	
ENGINE												
xDrive 50i	Petrol	0	07/13->	N63 B40 A								
Engine	Information				A10	A20	A40	A50	A70	C10 - C30	C20	E01
All engines	Qty: 8									1.970.475	C10	
X5 IV												
ENGINE												
M	Petrol	441	12/19->	S63 B44 B								
Engine	Information				A10	A20	A40	A50	A70	C10 - C30	C20	E01
All engines	x 8, DELPHI, COIL ON PLUG									1.970.475	C10	
ENGINE												
M Competition	Petrol	460	12/19->	S63 B44 B								
Engine	Information				A10	A20	A40	A50	A70	C10 - C30	C20	E01
All engines	x 8, DELPHI, COIL ON PLUG									1.970.475	C10	
ENGINE												
xDrive 40 i	Petrol	250	08/18->	B58 B30 C								
Engine	Information				A10	A20	A40	A50	A70	C10 - C30	C20	E01
All engines	x 6, COIL ON PLUG									1.970.632	C10	
ENGINE												
xDrive 40 i Mil-d-Hybrid	Petrol/ Electric	245	12/20->	B58 B30 C								
Engine	Information				A10	A20	A40	A50	A70	C10 - C30	C20	E01
All engines	x 6, COIL ON PLUG									1.970.632	C10	
ENGINE												
xDrive 45 e Plug-in-Hybrid	Petrol/ Electric	155	06/19->	B58 B30 C								
Engine	Information				A10	A20	A40	A50	A70	C10 - C30	C20	E01
All engines	x 6, COIL ON PLUG									1.970.632	C10	

A10 CONDENSER	A20 CONTACT SET	A40 DISTRIBUTOR CAP	A50 ROTOR	A70 PICK-UP
C10 COIL	C20 IGNITION MODULE	C30 ELECTRONIC IGNITION KIT	E01 IGNITION CABLE SET	

Vehicle	alim.	kW	Date	Engine	FUNCTIONS ON THE VEHICLE								
					A10	A20	A40	A50	A70	C10 - C30	C20	E01	
ENGINE													
xDrive 45 e Plug-in-Hybrid	Petrol/ Electric	210	06/19->	B58 B30 C									
Engine	Information				A10	A20	A40	A50	A70	C10 - C30	C20	E01	
All engines	x 6, COIL ON PLUG									1.970.632	C10		
ENGINE													
xDrive 45 e Plug-in-Hybrid	Petrol/ Electric	235	06/19->	B58 B30 C									
Engine	Information				A10	A20	A40	A50	A70	C10 - C30	C20	E01	
All engines	x 6, COIL ON PLUG									1.970.632	C10		
ENGINE													
xDrive 45 e Plug-in-Hybrid	Petrol/ Electric	290	06/19->	B58 B30 C									
Engine	Information				A10	A20	A40	A50	A70	C10 - C30	C20	E01	
All engines	x 6, COIL ON PLUG									1.970.632	C10		
ENGINE													
xDrive 50 i	Petrol	340	08/18->	N63 B44 D									
Engine	Information				A10	A20	A40	A50	A70	C10 - C30	C20	E01	
All engines	x 8, DELPHI, COIL ON PLUG									1.970.475	C10		
X6 I													
ENGINE													
35 i	Petrol	225	05/08-08/08	N54 B30 A									
Engine	Information				A10	A20	A40	A50	A70	C10 - C30	C20	E01	
All engines	Qty: 6									1.970.475	C10		
ENGINE													
50 i	Petrol	300	05/08-06/14	N63 B44 A									
Engine	Information				A10	A20	A40	A50	A70	C10 - C30	C20	E01	
All engines	Qty: 8									1.970.475	C10		
ENGINE													
ActiveHybrid	Petrol/ Electric	357	01/09-10/11	N63 B44 A									
Engine	Information				A10	A20	A40	A50	A70	C10 - C30	C20	E01	
All engines	x 8, DELPHI, ELDOR, COIL ON PLUG									1.970.475	C10		
ENGINE													
ActiveHybrid xDrive	Petrol/ Electric	300	01/09-10/11	N63 B44 A									
Engine	Information				A10	A20	A40	A50	A70	C10 - C30	C20	E01	
All engines	x 8, DELPHI, ELDOR, COIL ON PLUG									1.970.475	C10		
ENGINE													
M	Petrol	408	07/09-07/14	S63 B44 A									
Engine	Information				A10	A20	A40	A50	A70	C10 - C30	C20	E01	
All engines	x 8, DELPHI, ELDOR, COIL ON PLUG									1.970.475	C10		
ENGINE													
xDrive 35 i	Petrol	224	01/08-06/14	N54 B30 A, N55 B30 A									
Engine	Information				A10	A20	A40	A50	A70	C10 - C30	C20	E01	
All engines	x 6, DELPHI, ELDOR, COIL ON PLUG									1.970.475	C10		
ENGINE													
xDrive 35 i	Petrol	225	01/08-07/14	N54 B30 A, N55 B30 A									
Engine	Information				A10	A20	A40	A50	A70	C10 - C30	C20	E01	
All engines	x 6, DELPHI, ELDOR, COIL ON PLUG									1.970.475	C10		
ENGINE													
xDrive 35 i	Petrol	235	07/09-06/14	N55 B30 A									
Engine	Information				A10	A20	A40	A50	A70	C10 - C30	C20	E01	
All engines	x 6, DELPHI, COIL ON PLUG									1.970.475	C10		
ENGINE													
xDrive 35 i	Petrol	240	06/07-03/10	N54 B30 A									
Engine	Information				A10	A20	A40	A50	A70	C10 - C30	C20	E01	
All engines	x 6, DELPHI, ELDOR, COIL ON PLUG									1.970.475	C10		
ENGINE													
xDrive 40 i	Petrol	235	01/12->	N55 B30 A									
Engine	Information				A10	A20	A40	A50	A70	C10 - C30	C20	E01	
All engines	Qty: 6									1.970.475	C10		

A10	CONDENSER	A20	CONTACT SET	A40	DISTRIBUTOR CAP	A50	ROTOR	A70	PICK-UP
C10	COIL	C20	IGNITION MODULE	C30	ELECTRONIC IGNITION KIT	E01	IGNITION CABLE SET		

The present application list is a brief version. For the detailed information about the possibility of installation on a specific vehicle, please refer to our web-catalogue <http://catalogo.facet.eu/>









					FUNCTIONS ON THE VEHICLE							
Vehicle	alim.	kW	Date	Engine	 A10	 A20	 A40	 A50	 A70	 C10 - C30	 C20	 E01
X6 II												
xDrive 50 i	Petrol	300	07/08-07/14	ENGINE N63 B44 A								
Engine	Information				A10	A20	A40	A50	A70	C10 - C30	C20	E01
All engines	x 8, DELPHI, ELDOR, COIL ON PLUG									1.970.475	C10	
xDrive 50 i	Petrol	330	10/07-06/14	ENGINE N63 B44 A								
Engine	Information				A10	A20	A40	A50	A70	C10 - C30	C20	E01
All engines	x 8, DELPHI, ELDOR, COIL ON PLUG									1.970.475	C10	
X6 II												
35 i [USA]	Petrol	225	08/14->	ENGINE N55 B30 A								
Engine	Information				A10	A20	A40	A50	A70	C10 - C30	C20	E01
All engines	Qty: 6									1.970.475	C10	
M	Petrol	423	12/14-07/19	ENGINE S63 B44 B								
Engine	Information				A10	A20	A40	A50	A70	C10 - C30	C20	E01
All engines	x 8, BOSCH, DELPHI, COIL ON PLUG									1.970.475	C10	
xDrive 35 i	Petrol	225	08/14-07/19	ENGINE N55 B30 A								
Engine	Information				A10	A20	A40	A50	A70	C10 - C30	C20	E01
All engines	x 6, DELPHI, COIL ON PLUG									1.970.475	C10	
xDrive 35 i	Petrol	240	08/14-07/19	ENGINE N55 B30 A								
Engine	Information				A10	A20	A40	A50	A70	C10 - C30	C20	E01
All engines	x 6, DELPHI, COIL ON PLUG									1.970.475	C10	
xDrive 50 i	Petrol	0	08/14->	ENGINE N63 B40 A								
Engine	Information				A10	A20	A40	A50	A70	C10 - C30	C20	E01
All engines	Qty: 8									1.970.475	C10	
xDrive 50 i	Petrol	330	08/14-07/19	ENGINE N63 B44 B								
Engine	Information				A10	A20	A40	A50	A70	C10 - C30	C20	E01
All engines	x 8, BOSCH, DELPHI, COIL ON PLUG									1.970.475	C10	
xDrive 50 i [USA]	Petrol	330	08/14->	ENGINE N63 B44 B								
Engine	Information				A10	A20	A40	A50	A70	C10 - C30	C20	E01
All engines	Qty: 8									1.970.475	C10	
X6 III												
M	Petrol	441	12/19->	ENGINE S63 B44 B								
Engine	Information				A10	A20	A40	A50	A70	C10 - C30	C20	E01
All engines	x 8, DELPHI, COIL ON PLUG									1.970.475	C10	
M Competition	Petrol	460	12/19->	ENGINE S63 B44 B								
Engine	Information				A10	A20	A40	A50	A70	C10 - C30	C20	E01
All engines	x 8, DELPHI, COIL ON PLUG									1.970.475	C10	
xDrive 40 i	Petrol	250	08/19->	ENGINE B58 B30 C								
Engine	Information				A10	A20	A40	A50	A70	C10 - C30	C20	E01
All engines	x 6, COIL ON PLUG									1.970.632	C10	
xDrive 40 i Mil-Hybrid	Petrol/ Electric	245	12/20->	ENGINE B58 B30 C								
Engine	Information				A10	A20	A40	A50	A70	C10 - C30	C20	E01
All engines	x 6, COIL ON PLUG									1.970.632	C10	
X7												
xDrive 40 i	Petrol	250	03/19->	ENGINE B58 B30 C								
Engine	Information				A10	A20	A40	A50	A70	C10 - C30	C20	E01
All engines	x 6, COIL ON PLUG									1.970.632	C10	

A10 CONDENSER	A20 CONTACT SET	A40 DISTRIBUTOR CAP	A50 ROTOR	A70 PICK-UP
C10 COIL	C20 IGNITION MODULE	C30 ELECTRONIC IGNITION KIT	E01 IGNITION CABLE SET	

Vehicle	alim.	kW	Date	Engine	FUNCTIONS ON THE VEHICLE									
					A10	A20	A40	A50	A70	C10 - C30	C20	E01		
ENGINE														
xDrive 40 i Mild-Hybrid	Petrol/Electric	245	12/20->	B58 B30 C										
Engine	Information				A10	A20	A40	A50	A70	C10 - C30	C20	E01		
All engines	x 6, COIL ON PLUG									1.970.632	C10			
ENGINE														
xDrive M 50 i	Petrol	390	07/19->	N63 B44 D										
Engine	Information				A10	A20	A40	A50	A70	C10 - C30	C20	E01		
All engines	x 8, DELPHI, COIL ON PLUG									1.970.475	C10			
Z1														
2.5	Petrol	125	06/88-06/91	M20 B25 (256K1)										
Engine	Information				A10	A20	A40	A50	A70	C10 - C30	C20	E01		
All engines	version Bosch						1.306.238	1.406.119R						
All engines										1.970.112	C10			
Z3														
1.8 i	Petrol	85	10/95-10/98	M43 B18 (184E2)										
Engine	Information				A10	A20	A40	A50	A70	C10 - C30	C20	E01		
All engines	without marten protection												1.500.900	
ENGINE														
1.9 i	Petrol	103	11/95-03/99	M44 B19 (194S1)										
Engine	Information				A10	A20	A40	A50	A70	C10 - C30	C20	E01		
All engines													1.501.921	
ENGINE														
1.9 i	Petrol	85	01/99-01/03	M43 B19 (194E1)										
Engine	Information				A10	A20	A40	A50	A70	C10 - C30	C20	E01		
All engines	without marten protection												1.500.900	
ENGINE														
1.9 i	Petrol	87	07/98-01/03	M43 B19 (194E1)										
Engine	Information				A10	A20	A40	A50	A70	C10 - C30	C20	E01		
All engines	without marten protection												1.500.900	
ENGINE														
2.0 i	Petrol	110	04/99-01/03	M52 B20 (206S4)										
Engine	Information				A10	A20	A40	A50	A70	C10 - C30	C20	E01		
All engines	without spark plug connector, Qty: 6									1.970.352	C10			
All engines	incl. spark plug connector, Qty: 6									1.970.413	C10			
ENGINE														
2.2 i	Petrol	120	08/00-01/03	M54 B22 (226S1)										
Engine	Information				A10	A20	A40	A50	A70	C10 - C30	C20	E01		
All engines	without spark plug connector, Qty: 6									1.970.352	C10			
All engines	incl. spark plug connector, Qty: 6									1.970.413	C10			
ENGINE														
2.2 i	Petrol	125	10/00-06/02	M54 B22 (226S1)										
Engine	Information				A10	A20	A40	A50	A70	C10 - C30	C20	E01		
All engines	without spark plug connector, Qty: 6									1.970.352	C10			
All engines	incl. spark plug connector, Qty: 6									1.970.413	C10			
ENGINE														
2.8 i	Petrol	142	11/96-05/00	M52 B28 (286S1)										
Engine	Information				A10	A20	A40	A50	A70	C10 - C30	C20	E01		
All engines	without spark plug connector, Qty: 6									1.970.352	C10			
All engines	incl. spark plug connector, Qty: 6									1.970.413	C10			
ENGINE														
2.8 i	Petrol	143	01/96-07/00	M52 B28 (286S1), M52 B28 (286S2)										
Engine	Information				A10	A20	A40	A50	A70	C10 - C30	C20	E01		
All engines	without spark plug connector, Qty: 6									1.970.352	C10			
All engines	incl. spark plug connector, Qty: 6									1.970.413	C10			
ENGINE														
3.0 i	Petrol	170	06/00-06/03	M54 B30 (306S3)										
Engine	Information				A10	A20	A40	A50	A70	C10 - C30	C20	E01		
All engines	without spark plug connector, Qty: 6									1.970.352	C10			

A10	CONDENSER	A20	CONTACT SET	A40	DISTRIBUTOR CAP	A50	ROTOR	A70	PICK-UP
C10	COIL	C20	IGNITION MODULE	C30	ELECTRONIC IGNITION KIT	E01	IGNITION CABLE SET		

The present application list is a brief version. For the detailed information about the possibility of installation on a specific vehicle, please refer to our web-catalogue <http://catalogo.facet.eu/>

				FUNCTIONS ON THE VEHICLE								
Vehicle	alim.	kW	Date	Engine								
				ENGINE								
3.0 i	Petrol	170	06/00-06/03	M54 B30 (306S3)								
Engine		Information			A10	A20	A40	A50	A70	C10 - C30	C20	E01
All engines		incl. spark plug connector, Qty: 6								1.970.413	C10	
				ENGINE								
M	Petrol	236	02/98-06/01	S50 B32 (326S1)								
Engine		Information			A10	A20	A40	A50	A70	C10 - C30	C20	E01
All engines		without spark plug connector, Qty: 6								1.970.352	C10	
All engines		incl. spark plug connector, Qty: 6								1.970.413	C10	
				ENGINE								
M	Petrol	239	06/01-06/03	S54 B32 (326S4)								
Engine		Information			A10	A20	A40	A50	A70	C10 - C30	C20	E01
All engines		Qty: 6								1.970.475	C10	
				ENGINE								
M 3.2	Petrol	236	01/97-06/00	S50 B32 (326S1)								
Engine		Information			A10	A20	A40	A50	A70	C10 - C30	C20	E01
All engines		without spark plug connector, Qty: 6								1.970.352	C10	
All engines		incl. spark plug connector, Qty: 6								1.970.413	C10	
				ENGINE								
M 3.2	Petrol	239	06/01-01/03	S54 B32 (326S4)								
Engine		Information			A10	A20	A40	A50	A70	C10 - C30	C20	E01
All engines		Qty: 6								1.970.475	C10	
				Z4 I								
				ENGINE								
2.0 i	Petrol	110	03/05-02/09	N46 B20 A								
Engine		Information			A10	A20	A40	A50	A70	C10 - C30	C20	E01
All engines		Qty: 4								1.970.475	C10	
				ENGINE								
2.2 i	Petrol	125	10/03-10/05	M54 B22 (226S1)								
Engine		Information			A10	A20	A40	A50	A70	C10 - C30	C20	E01
All engines		Qty: 6								1.970.475	C10	
				ENGINE								
2.5 i	Petrol	130	01/06->	N52 B25 B								
Engine		Information			A10	A20	A40	A50	A70	C10 - C30	C20	E01
All engines		Qty: 6								1.970.475	C10	
				ENGINE								
2.5 i	Petrol	141	12/02-12/05	M54 B25 (256S5)								
Engine		Information			A10	A20	A40	A50	A70	C10 - C30	C20	E01
All engines		Qty: 6								1.970.475	C10	
				ENGINE								
2.5 si	Petrol	160	01/06->	N52 B25 B								
Engine		Information			A10	A20	A40	A50	A70	C10 - C30	C20	E01
All engines		Qty: 6								1.970.475	C10	
				ENGINE								
3.0 i	Petrol	0	01/06->	N52 B30 A								
Engine		Information			A10	A20	A40	A50	A70	C10 - C30	C20	E01
All engines		Qty: 6								1.970.475	C10	
				ENGINE								
3.0 i	Petrol	170	12/02-12/05	M54 B30 (306S3)								
Engine		Information			A10	A20	A40	A50	A70	C10 - C30	C20	E01
All engines		Qty: 6								1.970.475	C10	
				ENGINE								
3.0 si	Petrol	195	01/06->	N52 B30 B								
Engine		Information			A10	A20	A40	A50	A70	C10 - C30	C20	E01
All engines		Qty: 6								1.970.475	C10	
				ENGINE								
M	Petrol	252	01/06-08/08	S54 B32 (326S4)								
Engine		Information			A10	A20	A40	A50	A70	C10 - C30	C20	E01
All engines		Qty: 6								1.970.475	C10	

A10 CONDENSER	A20 CONTACT SET	A40 DISTRIBUTOR CAP	A50 ROTOR	A70 PICK-UP
C10 COIL	C20 IGNITION MODULE	C30 ELECTRONIC IGNITION KIT	E01 IGNITION CABLE SET	

Vehicle	alim.	kW	Date	Engine	FUNCTIONS ON THE VEHICLE							
					A10	A20	A40	A50	A70	C10 - C30	C20	E01

Z4 II

				ENGINE
sDrive30i	Petrol	190	05/09->	N52 B30 B, N52 B30 BF

Engine	Information	A10	A20	A40	A50	A70	C10 - C30	C20	E01
All engines	Qty: 6						1.970.475	C10	

Z8

				ENGINE
4.9	Petrol	294	01/00-12/03	S62 B50 (508S1)

Engine	Information	A10	A20	A40	A50	A70	C10 - C30	C20	E01
All engines	without spark plug connector, Qty: 8						1.970.352	C10	
All engines	incl. spark plug connector, Qty: 8						1.970.413	C10	

A10	CONDENSER	A20	CONTACT SET	A40	DISTRIBUTOR CAP	A50	ROTOR	A70	PICK-UP
C10	COIL	C20	IGNITION MODULE	C30	ELECTRONIC IGNITION KIT	E01	IGNITION CABLE SET		

The present application list is a brief version. For the detailed information about the possibility of installation on a specific vehicle, please refer to our web-catalogue <http://catalogo.facet.eu/>

Vehicle	alim.	kW	Date	Engine	FUNCTIONS ON THE VEHICLE							
					A10	A20	A40	A50	A70	C10 - C30	C20	E01
												

EQUIPE					ENGINE
1300 GT	Petrol	56	01/67-12/70	--	

Engine	Information	A10	A20	A40	A50	A70	C10 - C30	C20	E01
All engines				1.328.075	1.428.006				

EQUIPE					ENGINE
2.0 GT	Petrol	77	01/68-12/71	--	

Engine	Information	A10	A20	A40	A50	A70	C10 - C30	C20	E01
All engines					1.412.090, 1.428.007				

A10 CONDENSER	A20 CONTACT SET	A40 DISTRIBUTOR CAP	A50 ROTOR	A70 PICK-UP
C10 COIL	C20 IGNITION MODULE	C30 ELECTRONIC IGNITION KIT	E01 IGNITION CABLE SET	









Vehicle	alim.	kW	Date	Engine	FUNCTIONS ON THE VEHICLE							
					 A10	 A20	 A40	 A50	 A70	 C10 - C30	 C20	 E01

ISABELLA				ENGINE
1.5	Petrol	55	06/54-02/62	--

Engine	Information	A10	A20	A40	A50	A70	C10 - C30	C20	E01
All engines					1.406.018R				

A10	CONDENSER	A20	CONTACT SET	A40	DISTRIBUTOR CAP	A50	ROTOR	A70	PICK-UP
C10	COIL	C20	IGNITION MODULE	C30	ELECTRONIC IGNITION KIT	E01	IGNITION CABLE SET		

The present application list is a brief version. For the detailed information about the possibility of installation on a specific vehicle, please refer to our web-catalogue <http://catalogo.facet.eu/>

					FUNCTIONS ON THE VEHICLE							
Vehicle	alim.	kW	Date	Engine								
AVEO I												
1.2	Petrol	53	03/05->	ENGINE B12S1, F12S3, LQ5								
Engine Information					A10	A20	A40	A50	A70	C10 - C30	C20	E01
All engines												1.499.006
1.2	Petrol	55	01/08->	ENGINE B12D1, LMU								
Engine Information					A10	A20	A40	A50	A70	C10 - C30	C20	E01
All engines												1.499.249
1.2	Petrol	56	01/07-09/12	ENGINE B12S1, LY4								
Engine Information					A10	A20	A40	A50	A70	C10 - C30	C20	E01
All engines												1.499.006
1.2	Petrol	62	01/08->	ENGINE B12D1, LMU								
Engine Information					A10	A20	A40	A50	A70	C10 - C30	C20	E01
All engines												1.499.249
1.2 LPG	Petrol/ Liquified Petro- leum Gas (LPG)	62	04/08->	ENGINE B12D1, LMU								
Engine Information					A10	A20	A40	A50	A70	C10 - C30	C20	E01
All engines												1.499.249
1.4	Petrol	61	03/05->	ENGINE F14S3								
Engine Information					A10	A20	A40	A50	A70	C10 - C30	C20	E01
All engines												1.501.731
1.4	Petrol	69	03/05-05/13	ENGINE F14D3, L14								
Engine Information					A10	A20	A40	A50	A70	C10 - C30	C20	E01
All engines												1.501.680
1.4	Petrol	74	04/08->	ENGINE A 14 XER								
Engine Information					A10	A20	A40	A50	A70	C10 - C30	C20	E01
All engines										1.970.547	C10	
1.4 16V	Petrol	69	05/03-05/08	ENGINE F14D3								
Engine Information					A10	A20	A40	A50	A70	C10 - C30	C20	E01
All engines												1.501.680
1.4 CNG	CNG	69	01/10->	ENGINE L95								
Engine Information					A10	A20	A40	A50	A70	C10 - C30	C20	E01
All engines												1.501.680
1.5	Petrol	62	01/05->	ENGINE F15S3, LX6								
Engine Information					A10	A20	A40	A50	A70	C10 - C30	C20	E01
Eng. LX6												1.499.249
Eng. F15S3												1.501.731
1.6	Petrol	76	05/05->	ENGINE F16D3, LXV								
Engine Information					A10	A20	A40	A50	A70	C10 - C30	C20	E01
All engines												1.501.680
1.6	Petrol	77	09/03-12/08	ENGINE A16DMS, LXT, LXV								
Engine Information					A10	A20	A40	A50	A70	C10 - C30	C20	E01
All engines												1.501.680

A10 CONDENSER	A20 CONTACT SET	A40 DISTRIBUTOR CAP	A50 ROTOR	A70 PICK-UP
C10 COIL	C20 IGNITION MODULE	C30 ELECTRONIC IGNITION KIT	E01 IGNITION CABLE SET	

Vehicle	alim.	kW	Date	Engine	FUNCTIONS ON THE VEHICLE							
					A10	A20	A40	A50	A70	C10 - C30	C20	E01

AVEO II

				ENGINE
1.2	Petrol	51	03/11->	LWD

Engine	Information	A10	A20	A40	A50	A70	C10 - C30	C20	E01
All engines							1.970.547	C10	
All engines	x 1, x 4, COIL ON PLUG						1.970.547	C10	

				ENGINE
1.2	Petrol	63	03/11->	LDC

Engine	Information	A10	A20	A40	A50	A70	C10 - C30	C20	E01
All engines							1.970.547	C10	
All engines	x 1, version 1, version 2, COIL ON PLUG						1.970.547	C10	

				ENGINE
1.2 LPG	Petrol/ Liquified Petroleum Gas (LPG)	63	11/12-12/15	LDC

Engine	Information	A10	A20	A40	A50	A70	C10 - C30	C20	E01
All engines	x 4, COIL ON PLUG						1.970.547	C10	

				ENGINE
1.4	Petrol	74	03/11->	LDD

Engine	Information	A10	A20	A40	A50	A70	C10 - C30	C20	E01
All engines							1.970.547	C10	
All engines	x 1, x 4, COIL ON PLUG						1.970.547	C10	

				ENGINE
1.4 Turbo	Petrol	103	08/13->	A 14 NET

Engine	Information	A10	A20	A40	A50	A70	C10 - C30	C20	E01
All engines	x 4, COIL ON PLUG						1.970.547	C10	

				ENGINE
1.6	Petrol	85	03/11->	LDE

Engine	Information	A10	A20	A40	A50	A70	C10 - C30	C20	E01
All engines	x 4, COIL ON PLUG						1.970.545	C10	

CAPTIVA

				ENGINE
2.4	Petrol	100	06/06->	Z 24 SED

Engine	Information	A10	A20	A40	A50	A70	C10 - C30	C20	E01
All engines									1.499.247

				ENGINE
2.4 4WD	Petrol	100	06/06-02/11	Z 24 SED

Engine	Information	A10	A20	A40	A50	A70	C10 - C30	C20	E01
All engines									1.499.247

				ENGINE
2.4 LPG	Petrol/ Liquified Petroleum Gas (LPG)	100	01/07->	Z 24 SED

Engine	Information	A10	A20	A40	A50	A70	C10 - C30	C20	E01
All engines									1.499.247

				ENGINE
2.4 LPG 4WD	Petrol/ Liquified Petroleum Gas (LPG)	100	01/07-02/11	Z 24 SED

Engine	Information	A10	A20	A40	A50	A70	C10 - C30	C20	E01
All engines									1.499.247









CRUZE

				ENGINE
1.4	Petrol	103	09/10->	A 14 NET, LUJ

Engine	Information	A10	A20	A40	A50	A70	C10 - C30	C20	E01
All engines	x 4, COIL ON PLUG						1.970.547	C10	
Eng. LUJ							1.970.547	C10	

A10	CONDENSER	A20	CONTACT SET	A40	DISTRIBUTOR CAP	A50	ROTOR	A70	PICK-UP
C10	COIL	C20	IGNITION MODULE	C30	ELECTRONIC IGNITION KIT	E01	IGNITION CABLE SET		









The present application list is a brief version. For the detailed information about the possibility of installation on a specific vehicle, please refer to our web-catalogue <http://catalogo.facet.eu/>

					FUNCTIONS ON THE VEHICLE							
Vehicle	alim.	kW	Date	Engine	 A10	 A20	 A40	 A50	 A70	 C10 - C30	 C20	 E01
ENGINE												
1.4	Petrol	74	07/13->	A 14 XER, LDD								
ENGINE												
A 14 XER, LDD												
Engine	Information				A10	A20	A40	A50	A70	C10 - C30	C20	E01
All engines	x 4, COIL ON PLUG									1.970.547	C10	
Eng. LDD										1.970.547	C10	
ENGINE												
1.6	Petrol	80	05/09->	F16D3, LXT								
ENGINE												
F16D3, LXT												
Engine	Information				A10	A20	A40	A50	A70	C10 - C30	C20	E01
All engines												1.501.680
ENGINE												
1.6	Petrol	86	12/12->	LDE								
ENGINE												
LDE												
Engine	Information				A10	A20	A40	A50	A70	C10 - C30	C20	E01
All engines	x 4, COIL ON PLUG									1.970.545	C10	
ENGINE												
1.6	Petrol	91	06/11->	LDE								
ENGINE												
LDE												
Engine	Information				A10	A20	A40	A50	A70	C10 - C30	C20	E01
All engines	01/01/12->, 01/01/14->, x 4, COIL ON PLUG									1.970.545	C10	
EPICA												
ENGINE												
2.0	Petrol	98	01/05-12/06	T20SED								
ENGINE												
T20SED												
Engine	Information				A10	A20	A40	A50	A70	C10 - C30	C20	E01
All engines												1.501.677
EVANDA												
ENGINE												
2.0	Petrol	96	03/05-12/06	X 20 SED								
ENGINE												
X 20 SED												
Engine	Information				A10	A20	A40	A50	A70	C10 - C30	C20	E01
All engines												1.501.677
KALOS												
ENGINE												
1.2	Petrol	53	03/05->	B12S1, F12S3								
ENGINE												
B12S1, F12S3												
Engine	Information				A10	A20	A40	A50	A70	C10 - C30	C20	E01
All engines												1.499.006
ENGINE												
1.4 16V	Petrol	69	03/05->	F14D3								
ENGINE												
F14D3												
Engine	Information				A10	A20	A40	A50	A70	C10 - C30	C20	E01
All engines												1.501.680
LACETTI												
ENGINE												
1.4	Petrol	69	03/05-03/13	F14D3, L14(85CUL4)								
ENGINE												
F14D3, L14(85CUL4)												
Engine	Information				A10	A20	A40	A50	A70	C10 - C30	C20	E01
Eng. L14(85CUL4)	x 1, D.I.S.									1.970.585	C10	
Eng. F14D3												1.501.509
ENGINE												
1.4	Petrol	70	03/05->	F14D3								
ENGINE												
F14D3												
Engine	Information				A10	A20	A40	A50	A70	C10 - C30	C20	E01
All engines										1.970.585	C10	1.501.509
ENGINE												
1.4 16V	Petrol	70	03/05-03/13	F14D3, L14(85CUL4)								
ENGINE												
F14D3, L14(85CUL4)												
Engine	Information				A10	A20	A40	A50	A70	C10 - C30	C20	E01
Eng. L14(85CUL4)	x 1, D.I.S.									1.970.585	C10	
Eng. F14D3												1.501.509
ENGINE												
1.4 LPG	Petrol/ Liquified Petro- leum Gas (LPG)	69	01/05-12/12	L14(85CUL4)								
ENGINE												
L14(85CUL4)												
Engine	Information				A10	A20	A40	A50	A70	C10 - C30	C20	E01
All engines	x 1, D.I.S.									1.970.585	C10	
ENGINE												
1.6	Petrol	80	03/05->	F16D3, LXT								
ENGINE												
F16D3, LXT												
Engine	Information				A10	A20	A40	A50	A70	C10 - C30	C20	E01
Eng. LXT	x 1, D.I.S.									1.970.585	C10	
LEGEND												
A10	CONDENSER	A20	CONTACT SET	A40	DISTRIBUTOR CAP	A50	ROTOR	A70	PICK-UP			
C10	COIL	C20	IGNITION MODULE	C30	ELECTRONIC IGNITION KIT	E01	IGNITION CABLE SET					

Vehicle	alim.	kW	Date	Engine	FUNCTIONS ON THE VEHICLE									
					A10	A20	A40	A50	A70	C10 - C30	C20	E01		
ENGINE														
1.6	Petrol	80	03/05->	F16D3, LXT										
Engine		Information			A10	A20	A40	A50	A70	C10 - C30	C20	E01		
Eng. F16D3													1.501.509	
ENGINE														
1.6 LPG	Petrol/ Liquified Petro- leum Gas (LPG)	80	06/09-12/11	LXT										
Engine		Information			A10	A20	A40	A50	A70	C10 - C30	C20	E01		
All engines		x 1, D.I.S.								1.970.585	C10			
ENGINE														
1.8	Petrol	66	08/05-12/09	LDA										
Engine		Information			A10	A20	A40	A50	A70	C10 - C30	C20	E01		
All engines		x 1, D.I.S.								1.970.585	C10			
ENGINE														
1.8	Petrol	89	08/05-12/11	LDA										
Engine		Information			A10	A20	A40	A50	A70	C10 - C30	C20	E01		
All engines		x 1, D.I.S.								1.970.585	C10			
ENGINE														
1.8	Petrol	90	03/05->	LDA, T18SED										
Engine		Information			A10	A20	A40	A50	A70	C10 - C30	C20	E01		
Eng. LDA		x 1, D.I.S.								1.970.585	C10			
Eng. T18SED													1.501.677	
ENGINE														
2.0	Petrol	89	03/05->	U20SED										
Engine		Information			A10	A20	A40	A50	A70	C10 - C30	C20	E01		
All engines													1.501.677	
LANOS														
ENGINE														
1.5	Petrol	63	11/05->	A15SMS										
Engine		Information			A10	A20	A40	A50	A70	C10 - C30	C20	E01		
All engines													1.501.731	
ENGINE														
1.5	Petrol	64	11/05-12/18	A15SMS										
Engine		Information			A10	A20	A40	A50	A70	C10 - C30	C20	E01		
All engines													1.501.731	
ENGINE														
1.6 16V	Petrol	78	11/05->	A16DMS										
Engine		Information			A10	A20	A40	A50	A70	C10 - C30	C20	E01		
All engines													1.501.680	
MATIZ														
ENGINE														
0.8	Petrol	38	03/05-12/13	LBF(49CUL3), LQ2(49CUL3)										
Engine		Information			A10	A20	A40	A50	A70	C10 - C30	C20	E01		
All engines		VET. 577031 ->											1.499.007	
All engines		->VET. 577030											1.501.634	
ENGINE														
0.8 LPG	Petrol/ Liquified Petro- leum Gas (LPG)	38	03/05-12/07	F8CV										
Engine		Information			A10	A20	A40	A50	A70	C10 - C30	C20	E01		
All engines		VET. 577031 ->											1.499.007	
All engines		->VET. 577030											1.501.634	
ENGINE														
1.0	Petrol	46	01/08-12/13	B10S										
Engine		Information			A10	A20	A40	A50	A70	C10 - C30	C20	E01		
All engines													1.499.006	

A10 CONDENSER	A20 CONTACT SET	A40 DISTRIBUTOR CAP	A50 ROTOR	A70 PICK-UP
C10 COIL	C20 IGNITION MODULE	C30 ELECTRONIC IGNITION KIT	E01 IGNITION CABLE SET	

The present application list is a brief version. For the detailed information about the possibility of installation on a specific vehicle, please refer to our web-catalogue <http://catalogo.facet.eu/>









					FUNCTIONS ON THE VEHICLE							
Vehicle	alim.	kW	Date	Engine								
ENGINE												
1.0	Petrol	47	03/05-12/07	B10S								
ENGINE												
All engines												1.499.006
ENGINE												
1.0	Petrol	49	03/05->	B10S1, LQ4(61CUL4)								
ENGINE												
All engines												1.499.006
ENGINE												
1.0 LPG	Petrol/ Liquified Petro- leum Gas (LPG)	49	03/05-03/11	B10S1								
ENGINE												
All engines												1.499.006
ENGINE												
1.4	Petrol	69	01/05-12/07	F14D3, L14(85CUL4)								
ENGINE												
Eng. L14(85CUL4)										1.970.585	C10	
Eng. F14D3												1.501.509
ENGINE												
1.4	Petrol	70	01/06-12/08	F14D3, L14(85CUL4)								
ENGINE												
Eng. L14(85CUL4)										1.970.585	C10	
Eng. F14D3												1.501.509
ENGINE												
1.6	Petrol	76	01/10->	LXT								
ENGINE												
All engines										1.970.585	C10	1.501.509
ENGINE												
1.6	Petrol	80	03/05-12/11	F16D3, L44(96CUL4), LXT								
ENGINE												
Eng. L44(96CUL4), LXT										1.970.585	C10	
Eng. F16D3												1.501.509
ENGINE												
1.6 LPG	Petrol/ Liquified Petro- leum Gas (LPG)	80	03/05-12/10	L44(96CUL4), LXT								
ENGINE												
All engines										1.970.585	C10	
ENGINE												
1.8	Petrol	89	08/05-12/11	LDA								
ENGINE												
All engines										1.970.585	C10	
ENGINE												
1.8	Petrol	90	03/05-12/09	LDA, T18SED								
ENGINE												
Eng. LDA										1.970.585	C10	
Eng. T18SED												1.501.677
ENGINE												
1.4 16V	Petrol	70	03/05->	F14D3								
ENGINE												
All engines										1.970.585	C10	1.501.509
ENGINE												
1.6	Petrol	78	08/03-12/08	LXT								
ENGINE												
All engines										1.970.585	C10	1.501.509

A10 CONDENSER	A20 CONTACT SET	A40 DISTRIBUTOR CAP	A50 ROTOR	A70 PICK-UP
C10 COIL	C20 IGNITION MODULE	C30 ELECTRONIC IGNITION KIT	E01 IGNITION CABLE SET	

Vehicle	alim.	kW	Date	Engine	FUNCTIONS ON THE VEHICLE									
					A10	A20	A40	A50	A70	C10 - C30	C20	E01		
ENGINE														
1.6	Petrol	80	08/03-12/08	F16D3										
Engine					A10	A20	A40	A50	A70	C10 - C30	C20	E01		
All engines										1.970.585	C10		1.501.509	
ENGINE														
1.6 SRV	Petrol	74	06/06->	F16D3										
Engine					A10	A20	A40	A50	A70	C10 - C30	C20	E01		
All engines										1.970.585	C10		1.501.509	
ENGINE														
1.8	Petrol	90	08/03-12/08	T18SED										
Engine					A10	A20	A40	A50	A70	C10 - C30	C20	E01		
All engines													1.501.677	
ENGINE														
1.8 SRV	Petrol	90	06/06->	T18SED										
Engine					A10	A20	A40	A50	A70	C10 - C30	C20	E01		
All engines													1.501.677	
ENGINE														
2.0	Petrol	0	03/05->	U20SED										
Engine					A10	A20	A40	A50	A70	C10 - C30	C20	E01		
All engines													1.501.677	
ENGINE														
2.0	Petrol	98	06/99-07/03	X 20 SED										
Engine					A10	A20	A40	A50	A70	C10 - C30	C20	E01		
All engines													1.501.677	
ORLANDO														
ENGINE														
1.4	Petrol	103	06/12->	LUJ										
Engine					A10	A20	A40	A50	A70	C10 - C30	C20	E01		
All engines										1.970.547	C10			
REZZO														
ENGINE														
1.6	Petrol	77	03/05->	A16DMS										
Engine					A10	A20	A40	A50	A70	C10 - C30	C20	E01		
All engines													1.501.680	
ENGINE														
1.6	Petrol	79	08/05->	A16DMS										
Engine					A10	A20	A40	A50	A70	C10 - C30	C20	E01		
All engines													1.501.680	
ENGINE														
2.0	Petrol	89	03/05->	T20SED										
Engine					A10	A20	A40	A50	A70	C10 - C30	C20	E01		
All engines													1.501.677	
ENGINE														
2.0	Petrol	90	08/05-09/09	T20SED										
Engine					A10	A20	A40	A50	A70	C10 - C30	C20	E01		
All engines													1.501.677	
SPARK I														
ENGINE														
0.8	Petrol	38	09/00-12/06	F8CV										
Engine					A10	A20	A40	A50	A70	C10 - C30	C20	E01		
All engines							1.331.139	1.431.131						
All engines							1.331.172	1.431.139						
All engines										1.970.219	C10		1.501.634	
All engines													1.499.007	
ENGINE														
1.0	Petrol	47	11/02-12/04	G 10 CV										
Engine					A10	A20	A40	A50	A70	C10 - C30	C20	E01		
All engines													1.499.006	

A10	CONDENSER	A20	CONTACT SET	A40	DISTRIBUTOR CAP	A50	ROTOR	A70	PICK-UP
C10	COIL	C20	IGNITION MODULE	C30	ELECTRONIC IGNITION KIT	E01	IGNITION CABLE SET		

The present application list is a brief version. For the detailed information about the possibility of installation on a specific vehicle, please refer to our web-catalogue <http://catalogo.facet.eu/>









					FUNCTIONS ON THE VEHICLE								
Vehicle	alim.	kW	Date	Engine	 A10	 A20	 A40	 A50	 A70	 C10 - C30	 C20	 E01	
SPARK II													
0.8	Petrol	37	05/05-02/10	ENGINE F8CV									
Engine					Information	A10	A20	A40	A50	A70	C10 - C30	C20	E01
All engines					VET. 577031 ->								1.499.007
All engines					->VET. 577030								1.501.634
1.0 LPG													
Bi-Fuel	46	05/05->	ENGINE B10S										
Engine					Information	A10	A20	A40	A50	A70	C10 - C30	C20	E01
All engines													1.499.006
1.0 SX													
Petrol	46	05/05->	ENGINE B10S, LA2										
Engine					Information	A10	A20	A40	A50	A70	C10 - C30	C20	E01
All engines													1.499.006
1.0 SX													
Petrol	49	05/05->	ENGINE B10S1										
Engine					Information	A10	A20	A40	A50	A70	C10 - C30	C20	E01
All engines													1.499.006
SPARK III													
1.0	Petrol	50	03/10->	ENGINE B10D1									
Engine					Information	A10	A20	A40	A50	A70	C10 - C30	C20	E01
All engines													1.499.249
1.0 LPG													
Petrol/ Liquified Petro- leum Gas (LPG)	48	07/10->	ENGINE B10D1										
Engine					Information	A10	A20	A40	A50	A70	C10 - C30	C20	E01
All engines													1.499.249
1.0 LPG													
Petrol/ Liquified Petro- leum Gas (LPG)	50	03/10->	ENGINE B10D1, LMT										
Engine					Information	A10	A20	A40	A50	A70	C10 - C30	C20	E01
All engines													1.499.249
1.2													
Petrol	60	03/10->	ENGINE B12D1, LMU										
Engine					Information	A10	A20	A40	A50	A70	C10 - C30	C20	E01
All engines													1.499.249
1.2													
Petrol	61	01/11->	ENGINE Z 12 XE										
Engine					Information	A10	A20	A40	A50	A70	C10 - C30	C20	E01
All engines													1.499.249
1.2 LPG													
Petrol/ Liquified Petro- leum Gas (LPG)	60	03/10->	ENGINE B12D1, LMU										
Engine					Information	A10	A20	A40	A50	A70	C10 - C30	C20	E01
All engines													1.499.249
TACUMA													
1.6	Petrol	79	02/05->	ENGINE A16DMS									
Engine					Information	A10	A20	A40	A50	A70	C10 - C30	C20	E01
All engines													1.501.680
2.0													
Petrol	90	02/05->	ENGINE X 20 SED										
Engine					Information	A10	A20	A40	A50	A70	C10 - C30	C20	E01
All engines													1.501.677

A10 CONDENSER	A20 CONTACT SET	A40 DISTRIBUTOR CAP	A50 ROTOR	A70 PICK-UP
C10 COIL	C20 IGNITION MODULE	C30 ELECTRONIC IGNITION KIT	E01 IGNITION CABLE SET	

Vehicle	alim.	kW	Date	Engine	FUNCTIONS ON THE VEHICLE									
					A10	A20	A40	A50	A70	C10 - C30	C20	E01		
TRAX														
1.4	Petrol	103	12/12->	A 14 NET										
Engine		Information			A10	A20	A40	A50	A70	C10 - C30	C20	E01		
All engines		x 4, COIL ON PLUG								1.970.547	C10			
1.4 AWD	Petrol	103	12/12->	A 14 NET										
Engine		Information			A10	A20	A40	A50	A70	C10 - C30	C20	E01		
All engines		x 4, COIL ON PLUG								1.970.547	C10			
1.4 LPG	Petrol/ Liquified Petro- leum Gas (LPG)	103	04/13->	A 14 NET										
Engine		Information			A10	A20	A40	A50	A70	C10 - C30	C20	E01		
All engines		x 4, COIL ON PLUG								1.970.547	C10			
1.6	Petrol	85	12/12->	LDE										
Engine		Information			A10	A20	A40	A50	A70	C10 - C30	C20	E01		
All engines		x 4, COIL ON PLUG								1.970.545	C10			
1.8	Petrol	103	03/13->	2H0										
Engine		Information			A10	A20	A40	A50	A70	C10 - C30	C20	E01		
All engines		x 4, COIL ON PLUG								1.970.545	C10			
1.8 AWD	Petrol	103	03/13->	2H0										
Engine		Information			A10	A20	A40	A50	A70	C10 - C30	C20	E01		
All engines		x 4, COIL ON PLUG								1.970.545	C10			
VIVANT														
1.6	Petrol	77	01/05->	A16DMS										
Engine		Information			A10	A20	A40	A50	A70	C10 - C30	C20	E01		
All engines													1.501.680	
1.6	Petrol	78	08/01->	A16DMS										
Engine		Information			A10	A20	A40	A50	A70	C10 - C30	C20	E01		
All engines													1.501.680	
1.8	Petrol	72	05/00->	F18S2										
Engine		Information			A10	A20	A40	A50	A70	C10 - C30	C20	E01		
All engines													1.501.730	
2.0	Petrol	89	08/00->	X 20 SED										
Engine		Information			A10	A20	A40	A50	A70	C10 - C30	C20	E01		
All engines													1.501.677	
2.0 CX	Petrol	89	01/05->	T20SED										
Engine		Information			A10	A20	A40	A50	A70	C10 - C30	C20	E01		
All engines													1.501.677	
VOLT														
EV 150	Petrol/ Electric	111	11/11->	LUU										
Engine		Information			A10	A20	A40	A50	A70	C10 - C30	C20	E01		
All engines		x 4, COIL ON PLUG								1.970.547	C10			









A10 CONDENSER	A20 CONTACT SET	A40 DISTRIBUTOR CAP	A50 ROTOR	A70 PICK-UP
C10 COIL	C20 IGNITION MODULE	C30 ELECTRONIC IGNITION KIT	E01 IGNITION CABLE SET	

The present application list is a brief version. For the detailed information about the possibility of installation on a specific vehicle, please refer to our web-catalogue <http://catalogo.facet.eu/>

				FUNCTIONS ON THE VEHICLE								
Vehicle	alim.	kW	Date	Engine								
CIRRUS												
2.0 LX	Petrol	98	10/97-09/00	ENGINE ECB								
Engine	Information			A10	A20	A40	A50	A70	C10 - C30	C20	E01	
All engines												1.501.507
2.4 LX	Petrol	103	05/94-09/00	ENGINE EDZ								
Engine	Information			A10	A20	A40	A50	A70	C10 - C30	C20	E01	
All engines												1.501.508
2.5 LX	Petrol	120	10/94-09/00	ENGINE EEB								
Engine	Information			A10	A20	A40	A50	A70	C10 - C30	C20	E01	
All engines	version Mitsubishi					1.331.161						
CROSSFIRE												
3.2	Petrol	160	07/03-12/08	ENGINE EGX								
Engine	Information			A10	A20	A40	A50	A70	C10 - C30	C20	E01	
All engines	x 6, COIL ON PLUG								1.970.417	C10		
SRT-6	Petrol	246	09/04-12/07	ENGINE EGZ								
Engine	Information			A10	A20	A40	A50	A70	C10 - C30	C20	E01	
All engines	x 6, COIL ON PLUG								1.970.417	C10		
DELTA												
1.4 16V	Petrol	103	08/11->	ENGINE 198 A7.000								
Engine	Information			A10	A20	A40	A50	A70	C10 - C30	C20	E01	
All engines	x 4, COIL ON PLUG								1.970.549	C10		
LE BARON												
2.2 i	Petrol	109	10/83-09/87	ENGINE EDG								
Engine	Information			A10	A20	A40	A50	A70	C10 - C30	C20	E01	
All engines	version Chrysler						1.410.179					
2.2 i	Petrol	69	09/89-12/94	ENGINE --								
Engine	Information			A10	A20	A40	A50	A70	C10 - C30	C20	E01	
All engines	version Chrysler						1.410.179					
2.2 i Turbo	Petrol	109	09/86-12/90	ENGINE --								
Engine	Information			A10	A20	A40	A50	A70	C10 - C30	C20	E01	
All engines	version Chrysler						1.410.179					
2.2 i Turbo	Petrol	130	10/83-01/91	ENGINE EDG, EDR								
Engine	Information			A10	A20	A40	A50	A70	C10 - C30	C20	E01	
All engines	version Chrysler						1.410.179					
2.5 i	Petrol	75	09/86-12/94	ENGINE EDM								
Engine	Information			A10	A20	A40	A50	A70	C10 - C30	C20	E01	
All engines	version Chrysler						1.410.179					
2.5 i Turbo	Petrol	112	01/89-12/94	ENGINE EDT								
Engine	Information			A10	A20	A40	A50	A70	C10 - C30	C20	E01	
All engines	version Chrysler						1.410.179					
3.0 i V6	Petrol	105	01/90-12/96	ENGINE 6G72, EFA								
Engine	Information			A10	A20	A40	A50	A70	C10 - C30	C20	E01	
All engines	version Mitsubishi					1.331.116	1.431.109					
NEON I												
1.8 16V	Petrol	85	09/97-08/99	ENGINE EBD								
Engine	Information			A10	A20	A40	A50	A70	C10 - C30	C20	E01	
All engines												1.501.507

A10 CONDENSER	A20 CONTACT SET	A40 DISTRIBUTOR CAP	A50 ROTOR	A70 PICK-UP
C10 COIL	C20 IGNITION MODULE	C30 ELECTRONIC IGNITION KIT	E01 IGNITION CABLE SET	

Vehicle	alim.	kW	Date	Engine	FUNCTIONS ON THE VEHICLE									
					A10	A20	A40	A50	A70	C10 - C30	C20	E01		
ENGINE														
2.0	Petrol	118	10/96-09/00	ECC										
ENGINE														
Engine Information					A10	A20	A40	A50	A70	C10 - C30	C20	E01		
All engines													1.501.508	
ENGINE														
2.0 16V	Petrol	107	06/94-08/99	ECC										
ENGINE														
Engine Information					A10	A20	A40	A50	A70	C10 - C30	C20	E01		
All engines													1.501.508	
ENGINE														
2.0 16V	Petrol	109	04/96-08/99	420T										
ENGINE														
Engine Information					A10	A20	A40	A50	A70	C10 - C30	C20	E01		
All engines													1.501.508	
ENGINE														
2.0 16V	Petrol	98	05/94-08/99	420H										
ENGINE														
Engine Information					A10	A20	A40	A50	A70	C10 - C30	C20	E01		
All engines													1.501.507	
NEON II														
ENGINE														
1.6	Petrol	85	11/01-12/06	EJD										
ENGINE														
Engine Information					A10	A20	A40	A50	A70	C10 - C30	C20	E01		
All engines													1.501.719	
ENGINE														
2.0 16V	Petrol	98	08/99-12/06	420H										
ENGINE														
Engine Information					A10	A20	A40	A50	A70	C10 - C30	C20	E01		
All engines													1.501.507	
PT CRUISER														
ENGINE														
1.6	Petrol	85	11/01-12/10	EJD										
ENGINE														
Engine Information					A10	A20	A40	A50	A70	C10 - C30	C20	E01		
All engines													1.501.719	
ENGINE														
2.0	Petrol	104	06/00-09/04	ECC										
ENGINE														
Engine Information					A10	A20	A40	A50	A70	C10 - C30	C20	E01		
All engines													1.501.511	
ENGINE														
2.4	Petrol	105	03/04-03/08	EDZ										
ENGINE														
Engine Information					A10	A20	A40	A50	A70	C10 - C30	C20	E01		
All engines													1.501.511	
ENGINE														
2.4 GT	Petrol	164	03/04-03/08	EDV										
ENGINE														
Engine Information					A10	A20	A40	A50	A70	C10 - C30	C20	E01		
All engines													1.501.990	
ENGINE														
GT 2.4	Petrol	164	08/03-12/10	EDV										
ENGINE														
Engine Information					A10	A20	A40	A50	A70	C10 - C30	C20	E01		
All engines													1.501.990	
SEBRING I														
ENGINE														
2.5 LE	Petrol	120	05/95-12/96	EEB										
ENGINE														
Engine Information					A10	A20	A40	A50	A70	C10 - C30	C20	E01		
All engines							1.331.161							
SEBRING II														
ENGINE														
2.0	Petrol	104	04/01-06/07	ECC										
ENGINE														
Engine Information					A10	A20	A40	A50	A70	C10 - C30	C20	E01		
All engines													1.501.507	
All engines													1.501.511	
ENGINE														
2.4	Petrol	112	04/01-06/07	EDZ										
ENGINE														
Engine Information					A10	A20	A40	A50	A70	C10 - C30	C20	E01		
All engines													1.501.511, 1.501.764	
ENGINE														
A10	CONDENSER		A20	CONTACT SET		A40	DISTRIBUTOR CAP		A50	ROTOR		A70	PICK-UP	
C10	COIL		C20	IGNITION MODULE		C30	ELECTRONIC IGNITION KIT		E01	IGNITION CABLE SET				

				FUNCTIONS ON THE VEHICLE								
Vehicle	alim.	kW	Date	Engine	 A10	 A20	 A40	 A50	 A70	 C10 - C30	 C20	 E01
STRATUS												
2.0 16V	Petrol	98	12/95-04/01	ENGINE ECB								
Engine	Information				A10	A20	A40	A50	A70	C10 - C30	C20	E01
All engines												1.501.507
2.0 LE	Petrol	96	12/95-04/01	ENGINE 420X, C00								
Engine	Information				A10	A20	A40	A50	A70	C10 - C30	C20	E01
All engines												1.501.507
2.4 16 V	Petrol	103	12/95-04/01	ENGINE EDZ								
Engine	Information				A10	A20	A40	A50	A70	C10 - C30	C20	E01
All engines												1.501.508
2.4 16V	Petrol	112	12/95-04/01	ENGINE EDZ								
Engine	Information				A10	A20	A40	A50	A70	C10 - C30	C20	E01
All engines												1.501.508
2.5 LX	Petrol	120	04/96-04/01	ENGINE 625H								
Engine	Information				A10	A20	A40	A50	A70	C10 - C30	C20	E01
All engines	version Mitsubishi						1.331.161					
2.5 LX V6	Petrol	120	12/95-04/01	ENGINE 5RG225								
Engine	Information				A10	A20	A40	A50	A70	C10 - C30	C20	E01
All engines	version Mitsubishi						1.331.161					
2.5 V6	Petrol	125	12/95-04/01	ENGINE 5RG225								
Engine	Information				A10	A20	A40	A50	A70	C10 - C30	C20	E01
All engines	version Mitsubishi						1.331.161					
VOYAGER												
2.5 i	Petrol	72	01/91-09/95	ENGINE K00								
Engine	Information				A10	A20	A40	A50	A70	C10 - C30	C20	E01
All engines	version Chrysler							1.410.179				
2.5 i	Petrol	74	08/90-09/95	ENGINE K								
Engine	Information				A10	A20	A40	A50	A70	C10 - C30	C20	E01
All engines	version Chrysler							1.410.179				
3.0 i	Petrol	108	01/91-09/95	ENGINE 300, 6G72								
Engine	Information				A10	A20	A40	A50	A70	C10 - C30	C20	E01
All engines	version Mitsubishi						1.331.116	1.431.109				
3.3	Petrol	112	10/89-09/90	ENGINE EGA								
Engine	Information				A10	A20	A40	A50	A70	C10 - C30	C20	E01
All engines	version Mitsubishi						1.331.116	1.431.109				
VOYAGER I												
3.0 i [USA]	Petrol	108	10/84-07/90	ENGINE EFA								
Engine	Information				A10	A20	A40	A50	A70	C10 - C30	C20	E01
All engines	version Mitsubishi						1.331.116	1.431.109				
VOYAGER II												
2.0 i	Petrol	98	01/95-03/01	ENGINE C00								
Engine	Information				A10	A20	A40	A50	A70	C10 - C30	C20	E01
All engines												1.501.507
2.4 i	Petrol	111	01/95-03/01	ENGINE B00								
Engine	Information				A10	A20	A40	A50	A70	C10 - C30	C20	E01
All engines												1.501.508

A10 CONDENSER	A20 CONTACT SET	A40 DISTRIBUTOR CAP	A50 ROTOR	A70 PICK-UP
C10 COIL	C20 IGNITION MODULE	C30 ELECTRONIC IGNITION KIT	E01 IGNITION CABLE SET	

Vehicle	alim.	kW	Date	Engine	FUNCTIONS ON THE VEHICLE									
					A10	A20	A40	A50	A70	C10 - C30	C20	E01		
ENGINE														
3.3 i	Petrol	116	01/95-03/01	R00										
Engine	Information				A10	A20	A40	A50	A70	C10 - C30	C20	E01		
All engines													1.501.343	
ENGINE														
3.8 i AWD	Petrol	122	01/95-03/01	L00										
Engine	Information				A10	A20	A40	A50	A70	C10 - C30	C20	E01		
All engines													1.501.343	
ENGINE														
3.8 i AWD	Petrol	131	01/95-03/01	EGH										
Engine	Information				A10	A20	A40	A50	A70	C10 - C30	C20	E01		
All engines													1.501.343	
VOYAGER III														
ENGINE														
2.4	Petrol	108	02/00-12/08	EDZ										
Engine	Information				A10	A20	A40	A50	A70	C10 - C30	C20	E01		
All engines													1.501.511	
ENGINE														
3.3	Petrol	128	02/00-12/08	EGA										
Engine	Information				A10	A20	A40	A50	A70	C10 - C30	C20	E01		
All engines													1.501.345	
ENGINE														
3.3 AWD	Petrol	128	02/00-12/08	EGA										
Engine	Information				A10	A20	A40	A50	A70	C10 - C30	C20	E01		
All engines													1.501.345	
YPSILON														
ENGINE														
1.2	Petrol	51	05/11->	169 A4.000										
Engine	Information				A10	A20	A40	A50	A70	C10 - C30	C20	E01		
All engines	x 1, D.I.S.									1.970.423	C10			

A10	CONDENSER	A20	CONTACT SET	A40	DISTRIBUTOR CAP	A50	ROTOR	A70	PICK-UP
C10	COIL	C20	IGNITION MODULE	C30	ELECTRONIC IGNITION KIT	E01	IGNITION CABLE SET		

The present application list is a brief version. For the detailed information about the possibility of installation on a specific vehicle, please refer to our web-catalogue <http://catalogo.facet.eu/>

FUNCTIONS ON THE VEHICLE

Vehicle	alim.	kW	Date	Engine								
---------	-------	----	------	--------	---	---	---	--	---	---	---	---

2 CV

6	Petrol	21	02/70-10/85	ENGINE A06/635, A06/664
---	--------	----	-------------	----------------------------

Engine	Information	A10	A20	A40	A50	A70	C10 - C30	C20	E01
All engines	version Ducellier		1.215.064						

ACADIANE

6	Petrol	22	08/78-10/88	ENGINE M28 (AM2)
---	--------	----	-------------	---------------------

Engine	Information	A10	A20	A40	A50	A70	C10 - C30	C20	E01
All engines	version Ducellier		1.215.064						

AX

1.3 Sport	Petrol	70	04/87-12/88	ENGINE M4A
-----------	--------	----	-------------	---------------

Engine	Information	A10	A20	A40	A50	A70	C10 - C30	C20	E01
All engines	version Bosch			1.306.241	1.406.056R				
All engines	version Ducellier			1.315.074	1.415.102R	1.915.019			
All engines	Kit, version Ducellier			1.315.087					
All engines	->year 27/04/91						1.970.105	C10	
All engines	28/04/91 ->						1.970.155	C10	
All engines									1.501.376

1.4 GTi	Petrol	66	08/91-12/96	ENGINE KFY (TU3FJ2)
---------	--------	----	-------------	------------------------

Engine	Information	A10	A20	A40	A50	A70	C10 - C30	C20	E01
All engines							1.970.189	C10	1.501.374

1.4 GTi	Petrol	69	06/91-12/96	ENGINE KFZ (TU3FJ2)
---------	--------	----	-------------	------------------------

Engine	Information	A10	A20	A40	A50	A70	C10 - C30	C20	E01
All engines							1.970.189	C10	1.501.374

1.4 GTi	Petrol	74	06/91-12/92	ENGINE KFZ (TU3FJ2)
---------	--------	----	-------------	------------------------

Engine	Information	A10	A20	A40	A50	A70	C10 - C30	C20	E01
All engines							1.970.189	C10	1.501.374

10	Petrol	32	09/86-06/92	ENGINE C1A
----	--------	----	-------------	---------------

Engine	Information	A10	A20	A40	A50	A70	C10 - C30	C20	E01
All engines	version Bosch			1.306.241	1.406.056R				
All engines	version Ducellier			1.315.074	1.415.102R	1.915.019			
All engines	Kit, version Ducellier			1.315.087					
All engines	version Marelli				1.430.060				
All engines	->year 27/04/91						1.970.105	C10	
All engines	28/04/91 ->						1.970.155	C10	
All engines									1.501.376

10	Petrol	33	07/86-12/98	ENGINE CDY (TU9M)
----	--------	----	-------------	----------------------

Engine	Information	A10	A20	A40	A50	A70	C10 - C30	C20	E01
All engines							1.970.189	C10	1.501.374

10	Petrol	37	02/87-12/98	ENGINE CDZ (TU9M)
----	--------	----	-------------	----------------------

Engine	Information	A10	A20	A40	A50	A70	C10 - C30	C20	E01
All engines							1.970.189	C10	1.501.374

10 E	Petrol	30	12/86-12/88	ENGINE C3A
------	--------	----	-------------	---------------

Engine	Information	A10	A20	A40	A50	A70	C10 - C30	C20	E01
All engines	version Bosch			1.306.241	1.406.056R				
All engines	version Ducellier			1.315.074	1.415.102R	1.915.019			
All engines	Kit, version Ducellier			1.315.087					
All engines	version Marelli				1.430.060				
All engines	->year 27/04/91						1.970.105	C10	
All engines	28/04/91 ->						1.970.155	C10	
All engines									1.501.376

A10 CONDENSER	A20 CONTACT SET	A40 DISTRIBUTOR CAP	A50 ROTOR	A70 PICK-UP
C10 COIL	C20 IGNITION MODULE	C30 ELECTRONIC IGNITION KIT	E01 IGNITION CABLE SET	

Vehicle	alim.	kW	Date	Engine	FUNCTIONS ON THE VEHICLE							
					A10	A20	A40	A50	A70	C10 - C30	C20	E01

ENGINE				
11	Petrol	40	12/86-04/94	H1A, H1B

Engine	Information	A10	A20	A40	A50	A70	C10 - C30	C20	E01
All engines	version Bosch			1.306.241	1.406.056R				
All engines	version Ducellier			1.315.074	1.415.102R	1.915.019			
All engines	Kit, version Ducellier			1.315.087					
All engines	version Marelli				1.430.060				
All engines	->year 27/04/91						1.970.105	C10	
All engines	28/04/91 ->						1.970.155	C10	
All engines									1.501.376

ENGINE				
11	Petrol	44	09/86-06/98	HDY, HDZ (TU1M)

Engine	Information	A10	A20	A40	A50	A70	C10 - C30	C20	E01
All engines	version Bosch			1.306.241	1.406.056R				
All engines	version Ducellier			1.315.074	1.415.102R	1.915.019			
All engines	Kit, version Ducellier			1.315.087					
All engines	->year 27/04/91						1.970.105	C10	
All engines	28/04/91 ->, ->year 04/05/92						1.970.155	C10	
All engines	05/05/92 ->						1.970.189	C10	1.501.374
All engines	->year 04/05/92								1.501.376

ENGINE				
11 4x4	Petrol	40	06/91-07/92	H1A

Engine	Information	A10	A20	A40	A50	A70	C10 - C30	C20	E01
All engines	version Bosch			1.306.241	1.406.056R				
All engines	version Ducellier			1.315.074	1.415.102R	1.915.019			
All engines	Kit, version Ducellier			1.315.087					
All engines	version Marelli				1.430.060				
All engines	->year 27/04/91						1.970.105	C10	
All engines	28/04/91 ->						1.970.155	C10	
All engines									1.501.376

ENGINE				
11 Cat	Petrol	40	09/88-12/89	HAZ (TU1CP)

Engine	Information	A10	A20	A40	A50	A70	C10 - C30	C20	E01
All engines	version Bosch			1.306.241	1.406.056R				
All engines	version Ducellier			1.315.074	1.415.102R	1.915.019			
All engines	Kit, version Ducellier			1.315.087					
All engines	version Marelli				1.430.060				
All engines	->year 27/04/91						1.970.105	C10	
All engines	28/04/91 ->						1.970.155	C10	
All engines									1.501.376

ENGINE				
14	Petrol	44	12/86-12/88	K1B, KAY (TU3CP)

Engine	Information	A10	A20	A40	A50	A70	C10 - C30	C20	E01
All engines	version Bosch			1.306.241	1.406.056R				
All engines	version Ducellier			1.315.074	1.415.102R	1.915.019			
All engines	Kit, version Ducellier			1.315.087					
All engines	->year 27/04/91						1.970.105	C10	
All engines	28/04/91 ->						1.970.155	C10	
All engines									1.501.376

ENGINE				
14	Petrol	49	06/88-12/89	K1F

Engine	Information	A10	A20	A40	A50	A70	C10 - C30	C20	E01
All engines	version Bosch			1.306.241	1.406.056R				
All engines	version Ducellier			1.315.074	1.415.102R	1.915.019			
All engines	Kit, version Ducellier			1.315.087					
All engines	->year 27/04/91						1.970.105	C10	
All engines	28/04/91 ->						1.970.155	C10	
All engines									1.501.376

ENGINE				
14	Petrol	51	01/89-12/91	K1G

Engine	Information	A10	A20	A40	A50	A70	C10 - C30	C20	E01
All engines	version Bosch			1.306.241	1.406.056R				
All engines	version Ducellier			1.315.074	1.415.102R	1.915.019			

A10	CONDENSER	A20	CONTACT SET	A40	DISTRIBUTOR CAP	A50	ROTOR	A70	PICK-UP
C10	COIL	C20	IGNITION MODULE	C30	ELECTRONIC IGNITION KIT	E01	IGNITION CABLE SET		

FUNCTIONS ON THE VEHICLE

Vehicle	alim.	kW	Date	Engine								
---------	-------	----	------	--------	---	---	---	--	---	---	---	---

ENGINE				
14	Petrol	51	01/89-12/91	K1G

Engine	Information	A10	A20	A40	A50	A70	C10 - C30	C20	E01
All engines	Kit, version Ducellier			1.315.087					
All engines	->year 27/04/91						1.970.105	C10	
All engines	28/04/91 ->						1.970.155	C10	
All engines									1.501.376

ENGINE				
14	Petrol	55	04/87-04/97	K2D, KDX (TU3M/Z), KDY (TU3FM), KDY (TU3M), KDZ (TU3M/Z)

Engine	Information	A10	A20	A40	A50	A70	C10 - C30	C20	E01
All engines	version Bosch			1.306.241	1.406.056R				
All engines	version Ducellier			1.315.074	1.415.102R	1.915.019			
All engines	Kit, version Ducellier			1.315.087					
Eng. K2D, KDX (TU3M/Z), KDY (TU3FM)	->year 27/04/91						1.970.105	C10	
All engines	28/04/91 ->, ->year 04/01/93						1.970.155	C10	
Eng. KDX (TU3M/Z), KDY (TU3FM)	05/01/93 ->						1.970.189	C10	1.501.374
All engines	->year 04/01/93								1.501.376

ENGINE				
14	Petrol	61	01/88-12/92	K2A

Engine	Information	A10	A20	A40	A50	A70	C10 - C30	C20	E01
All engines	version Bosch			1.306.241	1.406.056R				
All engines	version Ducellier			1.315.074	1.415.102R	1.915.019			
All engines	Kit, version Ducellier			1.315.087					
All engines	->year 27/04/91						1.970.105	C10	
All engines	28/04/91 ->						1.970.155	C10	
All engines									1.501.376

ENGINE				
14	Petrol	62	01/88-12/92	K2A, K2B

Engine	Information	A10	A20	A40	A50	A70	C10 - C30	C20	E01
All engines	version Bosch			1.306.241	1.406.056R				
All engines	version Ducellier			1.315.074	1.415.102R	1.915.019			
All engines	Kit, version Ducellier			1.315.087					
All engines	->year 27/04/91						1.970.105	C10	
All engines	28/04/91 ->						1.970.155	C10	
All engines									1.501.376

ENGINE				
14 4x4	Petrol	55	08/91-12/96	KDX (TU3M/Z), KDY (TU3FM), KDY (TU3M), KDZ (TU3M/Z)

Engine	Information	A10	A20	A40	A50	A70	C10 - C30	C20	E01
All engines	version Bosch			1.306.241	1.406.056R				
All engines	version Ducellier			1.315.074	1.415.102R	1.915.019			
All engines	Kit, version Ducellier			1.315.087					
Eng. KDY (TU3FM)	->year 27/04/91						1.970.105	C10	
All engines	28/04/91 ->, ->year 04/01/93						1.970.155	C10	
Eng. KDY (TU3FM)	05/01/93 ->						1.970.189	C10	1.501.374
All engines	->year 04/01/93								1.501.376

ENGINE				
14 GT	Petrol	59	01/89-12/91	KDZ (TU3M/Z)

Engine	Information	A10	A20	A40	A50	A70	C10 - C30	C20	E01
All engines	version Bosch			1.306.241	1.406.056R				
All engines	version Ducellier			1.315.074	1.415.102R	1.915.019			
All engines	Kit, version Ducellier			1.315.087					
All engines							1.970.105	C10	1.501.376

AXEL

ENGINE				
11	Petrol	42	01/84-03/91	G11/631

Engine	Information	A10	A20	A40	A50	A70	C10 - C30	C20	E01
All engines	version Ducellier	1.115.034		1.315.058	1.415.088				

A10 CONDENSER	A20 CONTACT SET	A40 DISTRIBUTOR CAP	A50 ROTOR	A70 PICK-UP
C10 COIL	C20 IGNITION MODULE	C30 ELECTRONIC IGNITION KIT	E01 IGNITION CABLE SET	

Vehicle	alim.	kW	Date	Engine	FUNCTIONS ON THE VEHICLE									
					A10	A20	A40	A50	A70	C10 - C30	C20	E01		
1.4 i	Petrol	55	07/96-12/11	ENGINE KFW (TU3JP), KFX (TU3JP)										
Engine	Information				A10	A20	A40	A50	A70	C10 - C30	C20	E01		
All engines	euro 3, x 1, COIL ON PLUG									1.970.405	C10			
1.4 i	Petrol	57	08/99-05/08	ENGINE KFW (TU3JP), KFX (TU3JP)										
Engine	Information				A10	A20	A40	A50	A70	C10 - C30	C20	E01		
All engines	x 1, Electricfil, COIL ON PLUG									1.970.403	C10			
All engines	x 1, COIL ON PLUG									1.970.405	C10			
1.4 i bivalent	Petrol/ Com- pressed Natural Gas (CNG)	55	04/03-10/08	ENGINE KFW (TU3JP)										
Engine	Information				A10	A20	A40	A50	A70	C10 - C30	C20	E01		
All engines	->year 31/05/98									1.970.188	C10		1.501.374	
All engines	euro 2, x 4, Electricfil, COIL ON PLUG									1.970.403	C10			
All engines	euro 3, x 1, COIL ON PLUG									1.970.405	C10			
1.6 16V	Petrol	80	10/00-12/11	ENGINE NFU (TU5JP4)										
Engine	Information				A10	A20	A40	A50	A70	C10 - C30	C20	E01		
All engines	x 1, COIL ON PLUG									1.970.407	C10			
1.6 16V	Petrol	81	11/02-10/08	ENGINE NFU (TU5JP4)										
Engine	Information				A10	A20	A40	A50	A70	C10 - C30	C20	E01		
All engines	x 1, COIL ON PLUG									1.970.407	C10			
1.8 i	Petrol	66	05/97-10/02	ENGINE LFX (XU7JB)										
Engine	Information				A10	A20	A40	A50	A70	C10 - C30	C20	E01		
All engines	x 1, D.I.S., connector type, saw teeth									1.970.188	C10			
All engines													1.500.674	
1.8 i 4WD	Petrol	66	04/97-10/01	ENGINE LFX (XU7JB)										
Engine	Information				A10	A20	A40	A50	A70	C10 - C30	C20	E01		
All engines										1.970.188	C10			1.500.674
BERLINGO II														
1.2 PureTech 110	Petrol	81	02/16->	ENGINE --, EB2DT, HNZ (EB2DT)										
Engine	Information				A10	A20	A40	A50	A70	C10 - C30	C20	E01		
Eng. --, EB2DT	Qty: 3									1.970.620	C10			
Eng. HNZ (EB2DT)	x 3, COIL ON PLUG									1.970.620	C10			
1.6	Petrol	66	04/08->	ENGINE NFR (TU5JP4B)										
Engine	Information				A10	A20	A40	A50	A70	C10 - C30	C20	E01		
All engines	x 1, COIL ON PLUG									1.970.407	C10			
1.6	Petrol	80	04/08->	ENGINE N6A (TU5JP4), NFU (TU5JP4)										
Engine	Information				A10	A20	A40	A50	A70	C10 - C30	C20	E01		
Eng. N6A (TU5JP4)										1.970.407	C10			
Eng. NFU (TU5JP4)	x 1, COIL ON PLUG									1.970.407	C10			
1.6 Vti 120	Petrol	88	11/09->	ENGINE 5FS (EP6C)										
Engine	Information				A10	A20	A40	A50	A70	C10 - C30	C20	E01		
All engines	x 4, COIL ON PLUG									1.970.475	C10			
1.6 Vti 95	Petrol	72	07/10->	ENGINE 5FK (EP6CB)										
Engine	Information				A10	A20	A40	A50	A70	C10 - C30	C20	E01		
All engines	x 4, COIL ON PLUG									1.970.475	C10			

A10 CONDENSER	A20 CONTACT SET	A40 DISTRIBUTOR CAP	A50 ROTOR	A70 PICK-UP
C10 COIL	C20 IGNITION MODULE	C30 ELECTRONIC IGNITION KIT	E01 IGNITION CABLE SET	

Vehicle	alim.	kW	Date	Engine	FUNCTIONS ON THE VEHICLE							
					A10	A20	A40	A50	A70	C10 - C30	C20	E01

BX				
1.1	Petrol	40	06/88-06/91	H1A

Engine	Information	A10	A20	A40	A50	A70	C10 - C30	C20	E01
All engines	15/05/88 ->, version Bosch			1.306.241	1.406.056R				
All engines	->year 14/05/88, version Ducellier			1.315.058					
All engines	15/05/88 ->, version Ducellier			1.315.074	1.415.102R	1.915.019			
All engines	Kit, 15/05/88 ->, version Ducellier			1.315.087					
All engines	->year 15/05/88, version Ducellier				1.415.094				
All engines	15/05/88 ->						1.970.105	C10	1.501.376
All engines	->year 14/05/88							1.965.005	

ENGINE				
1.4	Petrol	50	07/86-12/94	K1F

Engine	Information	A10	A20	A40	A50	A70	C10 - C30	C20	E01
All engines	->year 01/05/88, version Bosch			1.306.124					
All engines	02/05/88 ->, version Bosch			1.306.241					
All engines	->year 01/05/88, version Ducellier, distr. num. 2525578A, 2525579A			1.315.058					
All engines	->year 01/05/88, version Ducellier, distr. num. 2525577A/B/C, distr. num. 2525578B, distr. num. 2525621, 2525579B			1.315.067					
All engines	02/05/88 ->, version Ducellier			1.315.074	1.415.102R	1.915.019			
All engines	Kit, 02/05/88 ->, version Ducellier			1.315.087					
All engines	version Bosch				1.406.056R				
All engines	->year 01/05/88, version Ducellier				1.415.094				
All engines	02/05/88 ->						1.970.105	C10	1.501.376
All engines	->year 01/05/88							1.965.005	

ENGINE				
1.4	Petrol	52	01/87-01/92	150C

Engine	Information	A10	A20	A40	A50	A70	C10 - C30	C20	E01
All engines	->year 01/05/88, version Bosch			1.306.124					
All engines	02/05/88 ->, version Bosch			1.306.241					
All engines	->year 01/05/88, version Ducellier, distr. num. 2525578A, 2525579A			1.315.058					
All engines	->year 01/05/88, version Ducellier, distr. num. 2525577A/B/C, distr. num. 2525578B, distr. num. 2525621, 2525579B			1.315.067					
All engines	02/05/88 ->, version Ducellier			1.315.074	1.415.102R	1.915.019			
All engines	Kit, 02/05/88 ->, version Ducellier			1.315.087					
All engines	version Bosch				1.406.056R				
All engines	->year 01/05/88, version Ducellier				1.415.094				
All engines	02/05/88 ->						1.970.105	C10	1.501.376
All engines	->year 01/05/88							1.965.005	

ENGINE				
1.4	Petrol	55	09/91-09/93	K2D

Engine	Information	A10	A20	A40	A50	A70	C10 - C30	C20	E01
All engines	->year 01/05/88, version Bosch			1.306.124					
All engines	02/05/88 ->, version Bosch			1.306.241					
All engines	->year 01/05/88, version Ducellier, distr. num. 2525578A, 2525579A			1.315.058					
All engines	->year 01/05/88, version Ducellier, distr. num. 2525577A/B/C, distr. num. 2525578B, distr. num. 2525621, 2525579B			1.315.067					
All engines	02/05/88 ->, version Ducellier			1.315.074	1.415.102R	1.915.019			
All engines	Kit, 02/05/88 ->, version Ducellier			1.315.087					
All engines	version Bosch				1.406.056R				
All engines	->year 01/05/88, version Ducellier				1.415.094				
All engines	02/05/88 ->						1.970.105	C10	1.501.376
All engines	->year 01/05/88							1.965.005	

ENGINE				
1.4 E	Petrol	46	05/86-06/88	KAZ

Engine	Information	A10	A20	A40	A50	A70	C10 - C30	C20	E01
All engines	->year 01/05/88, version Bosch			1.306.124					
All engines	02/05/88 ->, version Bosch			1.306.241					
All engines	->year 01/05/88, version Ducellier, distr. num. 2525578A, 2525579A			1.315.058					
All engines	->year 01/05/88, version Ducellier, distr. num. 2525577A/B/C, distr. num. 2525578B, distr. num. 2525621, 2525579B			1.315.067					
All engines	02/05/88 ->, version Ducellier			1.315.074	1.415.102R	1.915.019			

A10 CONDENSER	A20 CONTACT SET	A40 DISTRIBUTOR CAP	A50 ROTOR	A70 PICK-UP
C10 COIL	C20 IGNITION MODULE	C30 ELECTRONIC IGNITION KIT	E01 IGNITION CABLE SET	

Vehicle	alim.	kW	Date	Engine	FUNCTIONS ON THE VEHICLE							
					A10	A20	A40	A50	A70	C10 - C30	C20	E01

ENGINE				
1.4 E	Petrol	46	05/86-06/88	KAZ

Engine	Information	A10	A20	A40	A50	A70	C10 - C30	C20	E01
All engines	Kit, 02/05/88 ->, version Ducellier			1.315.087					
All engines	version Bosch				1.406.056R				
All engines	->year 01/05/88, version Ducellier				1.415.094				
All engines	02/05/88 ->						1.970.105	C10	1.501.376
All engines	->year 01/05/88							1.965.005	

ENGINE				
1.4 E	Petrol	50	07/86-12/94	K1F

Engine	Information	A10	A20	A40	A50	A70	C10 - C30	C20	E01
All engines	->year 01/05/88, version Bosch			1.306.124					
All engines	02/05/88 ->, version Bosch			1.306.241					
All engines	->year 01/05/88, version Ducellier, distr. num. 2525578A, 2525579A			1.315.058					
All engines	->year 01/05/88, version Ducellier, distr. num. 2525577A/B/C, distr. num. 2525578B, distr. num. 2525621, 2525579B			1.315.067					
All engines	02/05/88 ->, version Ducellier			1.315.074	1.415.102R	1.915.019			
All engines	Kit, 02/05/88 ->, version Ducellier			1.315.087					
All engines	version Bosch				1.406.056R				
All engines	->year 01/05/88, version Ducellier				1.415.094				
All engines	02/05/88 ->						1.970.105	C10	1.501.376
All engines	->year 01/05/88							1.965.005	

ENGINE				
1.4 E	Petrol	59	09/82-12/86	150B (XY8)

Engine	Information	A10	A20	A40	A50	A70	C10 - C30	C20	E01
All engines	->year 01/05/88, version Bosch			1.306.124					
All engines	02/05/88 ->, version Bosch			1.306.241					
All engines	->year 01/05/88, version Ducellier, distr. num. 2525578A, 2525579A			1.315.058					
All engines	->year 01/05/88, version Ducellier, distr. num. 2525577A/B/C, distr. num. 2525578B, distr. num. 2525621, 2525579B			1.315.067					
All engines	02/05/88 ->, version Ducellier			1.315.074	1.415.102R	1.915.019			
All engines	Kit, 02/05/88 ->, version Ducellier			1.315.087					
All engines	version Bosch				1.406.056R				
All engines	->year 01/05/88, version Ducellier				1.415.094				
All engines	02/05/88 ->						1.970.105	C10	1.501.376
All engines	->year 01/05/88							1.965.005	

ENGINE				
1.6	Petrol	85	01/87-01/92	B6D, B6E

Engine	Information	A10	A20	A40	A50	A70	C10 - C30	C20	E01
All engines	->year 31/10/89, version Bosch			1.306.124					
All engines	01/11/89 ->, version Bosch			1.306.241					
All engines	version Bosch				1.406.056R				
All engines	01/11/89 ->						1.970.105	C10	1.500.491
All engines								1.965.005	
All engines	->year 31/10/89								1.500.747

ENGINE				
14	Petrol	53	01/86-02/93	150C

Engine	Information	A10	A20	A40	A50	A70	C10 - C30	C20	E01
All engines	->year 01/05/88, version Bosch			1.306.124					
All engines	02/05/88 ->, version Bosch			1.306.241					
All engines	->year 01/05/88, version Ducellier, distr. num. 2525578A, 2525579A			1.315.058					
All engines	->year 01/05/88, version Ducellier, distr. num. 2525577A/B/C, distr. num. 2525578B, distr. num. 2525621, 2525579B			1.315.067					
All engines	02/05/88 ->, version Ducellier			1.315.074	1.415.102R	1.915.019			
All engines	Kit, 02/05/88 ->, version Ducellier			1.315.087					
All engines	version Bosch				1.406.056R				
All engines	->year 01/05/88, version Ducellier				1.415.094				
All engines	02/05/88 ->						1.970.105	C10	1.501.376
All engines	->year 01/05/88							1.965.005	

A10 CONDENSER	A20 CONTACT SET	A40 DISTRIBUTOR CAP	A50 ROTOR	A70 PICK-UP
C10 COIL	C20 IGNITION MODULE	C30 ELECTRONIC IGNITION KIT	E01 IGNITION CABLE SET	

Vehicle	alim.	kW	Date	Engine	FUNCTIONS ON THE VEHICLE							
					A10	A20	A40	A50	A70	C10 - C30	C20	E01

ENGINE				
14	Petrol	55	01/89-02/93	KDY (TU3M), KDZ (TU3M/Z)

Engine	Information	A10	A20	A40	A50	A70	C10 - C30	C20	E01
All engines	version Bosch			1.306.241	1.406.056R				
All engines	version Ducellier			1.315.074	1.415.102R	1.915.019			
All engines	Kit, version Ducellier			1.315.087					
All engines							1.970.105	C10	1.501.376

ENGINE				
14 E	Petrol	45	10/82-06/88	150A

Engine	Information	A10	A20	A40	A50	A70	C10 - C30	C20	E01
All engines	->year 01/05/88, version Bosch			1.306.124					
All engines	02/05/88 ->, version Bosch			1.306.241					
All engines	->year 01/05/88, version Ducellier, distr. num. 2525578A, 2525579A			1.315.058					
All engines	->year 01/05/88, version Ducellier, distr. num. 2525577A/B/C, distr. num. 2525578B, distr. num. 2525621, 2525579B			1.315.067					
All engines	02/05/88 ->, version Ducellier			1.315.074	1.415.102R	1.915.019			
All engines	Kit, 02/05/88 ->, version Ducellier			1.315.087					
All engines	version Bosch				1.406.056R				
All engines	->year 01/05/88, version Ducellier				1.415.094				
All engines	02/05/88 ->						1.970.105	C10	1.501.376
All engines	->year 01/05/88							1.965.005	

ENGINE				
14 E	Petrol	52	04/83-07/89	150C, K1G

Engine	Information	A10	A20	A40	A50	A70	C10 - C30	C20	E01
All engines	->year 01/05/88, version Bosch			1.306.124					
All engines	02/05/88 ->, version Bosch, 02/05/88 ->			1.306.241					
All engines	->year 01/05/88, version Ducellier, distr. num. 2525578A, 2525579A			1.315.058					
All engines	->year 01/05/88, version Ducellier, distr. num. 2525577A/B/C, distr. num. 2525578B, distr. num. 2525621, 2525579B			1.315.067					
All engines	02/05/88 ->, version Ducellier			1.315.074	1.415.102R	1.915.019			
All engines	Kit, 02/05/88 ->, version Ducellier			1.315.087					
All engines	version Bosch				1.406.056R				
All engines	->year 01/05/88, version Ducellier				1.415.094				
All engines	02/05/88 ->						1.970.105	C10	1.501.376
All engines	->year 01/05/88							1.965.005	

ENGINE				
14 E	Petrol	53	04/83-02/93	150C

Engine	Information	A10	A20	A40	A50	A70	C10 - C30	C20	E01
All engines	->year 01/05/88, version Bosch			1.306.124					
All engines	02/05/88 ->, version Bosch			1.306.241					
All engines	->year 01/05/88, version Ducellier, distr. num. 2525578A, 2525579A			1.315.058					
All engines	->year 01/05/88, version Ducellier, distr. num. 2525577A/B/C, distr. num. 2525578B, distr. num. 2525621, 2525579B			1.315.067					
All engines	02/05/88 ->, version Ducellier			1.315.074	1.415.102R	1.915.019			
All engines	Kit, 02/05/88 ->, version Ducellier			1.315.087					
All engines	version Bosch				1.406.056R				
All engines	->year 01/05/88, version Ducellier				1.415.094				
All engines	02/05/88 ->						1.970.105	C10	1.501.376
All engines	->year 01/05/88							1.965.005	

ENGINE				
15	Petrol	58	01/87-01/92	B1E (XU51C)

Engine	Information	A10	A20	A40	A50	A70	C10 - C30	C20	E01
All engines	version Bosch			1.306.124	1.406.056R				
All engines	->year 01/10/89, version Ducellier			1.315.067	1.415.094	1.915.017			
All engines	02/10/89 ->, version Ducellier			1.315.074	1.415.102R	1.915.019			
All engines	Kit, 02/10/89 ->, version Ducellier			1.315.087					
All engines	02/10/89 ->						1.970.106	C10	
All engines	->year 01/10/89							1.965.005	

A10 CONDENSER	A20 CONTACT SET	A40 DISTRIBUTOR CAP	A50 ROTOR	A70 PICK-UP
C10 COIL	C20 IGNITION MODULE	C30 ELECTRONIC IGNITION KIT	E01 IGNITION CABLE SET	

The present application list is a brief version. For the detailed information about the possibility of installation on a specific vehicle, please refer to our web-catalogue <http://catalogo.facet.eu/>

FUNCTIONS ON THE VEHICLE

Vehicle	alim.	kW	Date	Engine	 A10	 A20	 A40	 A50	 A70	 C10 - C30	 C20	 E01
---------	-------	----	------	--------	---	---	---	--	---	---	---	---

ENGINE				
15	Petrol	59	10/87-05/92	B1E (XU51C)

Engine	Information	A10	A20	A40	A50	A70	C10 - C30	C20	E01
All engines	version Bosch			1.306.124	1.406.056R				
All engines	->year 01/10/89, version Ducellier			1.315.067	1.415.094	1.915.017			
All engines	02/10/89 ->, version Ducellier			1.315.074	1.415.102R	1.915.019			
All engines	Kit, 02/10/89 ->, version Ducellier			1.315.087					
All engines	02/10/89 ->						1.970.106	C10	
All engines	->year 01/10/89							1.965.005	

ENGINE				
16	Petrol	53	01/87-12/94	B1E (XU51C)

Engine	Information	A10	A20	A40	A50	A70	C10 - C30	C20	E01
All engines	version Bosch			1.306.124	1.406.056R				
All engines	->year 01/10/89, version Ducellier			1.315.067	1.415.094	1.915.017			
All engines	version Ducellier, 02/10/89 ->			1.315.074	1.415.102R	1.915.019			
All engines	Kit, version Ducellier, 02/10/89 ->			1.315.087					
All engines	02/10/89 ->						1.970.106	C10	
All engines	->year 01/10/89							1.965.005	

ENGINE				
16	Petrol	55	09/88-12/94	BAY (XU5CP), BAZ (XU5CP)

Engine	Information	A10	A20	A40	A50	A70	C10 - C30	C20	E01
All engines	version Bosch, FOR: (D), FOR: (S), FOR: (CH)			1.306.124					
All engines	version Bosch, 28/03/88 ->			1.306.241					
All engines	->year 27/03/88, version Ducellier			1.315.058					
All engines	version Ducellier, FOR: (A), FOR: (S), 01/07/87 ->, FOR: (CH)			1.315.067	1.415.094	1.915.017			
All engines	28/03/88 ->, version Ducellier			1.315.074	1.415.102R	1.915.019			
All engines	Kit, 28/03/88 ->, version Ducellier			1.315.087					
All engines	version Bosch				1.406.056R				
All engines	28/03/88 ->						1.970.106	C10	
All engines	->year 27/03/88							1.965.005	

ENGINE				
16	Petrol	58	09/87-02/93	23DH

Engine	Information	A10	A20	A40	A50	A70	C10 - C30	C20	E01
All engines	version Bosch			1.306.124	1.406.056R				
All engines	->year 01/10/89, version Ducellier			1.315.067	1.415.094	1.915.017			
All engines	version Ducellier, 02/10/89 ->			1.315.074	1.415.102R	1.915.019			
All engines	Kit, version Ducellier, 02/10/89 ->			1.315.087					
All engines	02/10/89 ->						1.970.106	C10	
All engines	->year 01/10/89							1.965.005	

ENGINE				
16	Petrol	64	07/85-12/94	171D

Engine	Information	A10	A20	A40	A50	A70	C10 - C30	C20	E01
All engines	version Bosch, FOR: (D), FOR: (S), FOR: (CH)			1.306.124					
All engines	version Bosch, 28/03/88 ->			1.306.241					
All engines	->year 27/03/88, version Ducellier			1.315.058					
All engines	version Ducellier, FOR: (A), FOR: (S), 01/07/87 ->, FOR: (CH)			1.315.067	1.415.094	1.915.017			
All engines	28/03/88 ->, version Ducellier			1.315.074	1.415.102R	1.915.019			
All engines	Kit, 28/03/88 ->, version Ducellier			1.315.087					
All engines	version Bosch				1.406.056R				
All engines	28/03/88 ->						1.970.106	C10	
All engines	->year 27/03/88							1.965.005	





ENGINE				
16	Petrol	65	05/89-12/94	BDY (XU5M), BDZ (XU5M)

Engine	Information	A10	A20	A40	A50	A70	C10 - C30	C20	E01
All engines	->year 28/04/91, version Ducellier			1.315.074	1.415.102R				
All engines	->year 28/04/91, Kit, version Ducellier			1.315.087					
All engines	->year 28/04/91						1.970.106	C10	
All engines	29/04/91 ->						1.970.188	C10	1.500.674

A10 CONDENSER	A20 CONTACT SET	A40 DISTRIBUTOR CAP	A50 ROTOR	A70 PICK-UP
C10 COIL	C20 IGNITION MODULE	C30 ELECTRONIC IGNITION KIT	E01 IGNITION CABLE SET	

Vehicle	alim.	kW	Date	Engine	FUNCTIONS ON THE VEHICLE									
					A10	A20	A40	A50	A70	C10 - C30	C20	E01		
16	Petrol	66	10/82-06/88	ENGINE 171A, 171B, 171C										
Engine	Information			A10	A20	A40	A50	A70	C10 - C30	C20	E01			
All engines	version Bosch, FOR: (D), FOR: (S), FOR: (CH)					1.306.124								
All engines	version Bosch, 28/03/88 ->					1.306.241								
All engines	->year 27/03/88, version Ducellier					1.315.058								
All engines	version Ducellier, FOR: (A), FOR: (S), 01/07/87 ->, FOR: (CH)					1.315.067	1.415.094	1.915.017						
All engines	28/03/88 ->, version Ducellier					1.315.074	1.415.102R	1.915.019						
All engines	Kit, 28/03/88 ->, version Ducellier					1.315.087								
All engines	version Bosch						1.406.056R							
All engines	28/03/88 ->								1.970.106	C10				
All engines	->year 27/03/88											1.965.005		
16	Petrol	68	04/83-01/92	ENGINE 171C										
Engine	Information			A10	A20	A40	A50	A70	C10 - C30	C20	E01			
All engines	version Bosch, FOR: (D), FOR: (S), FOR: (CH)					1.306.124								
All engines	version Bosch, 28/03/88 ->					1.306.241								
All engines	->year 27/03/88, version Ducellier					1.315.058								
All engines	version Ducellier, FOR: (A), FOR: (S), 01/07/87 ->, FOR: (CH)					1.315.067	1.415.094	1.915.017						
All engines	28/03/88 ->, version Ducellier					1.315.074	1.415.102R	1.915.019						
All engines	Kit, 28/03/88 ->, version Ducellier					1.315.087								
All engines	version Bosch						1.406.056R							
All engines	28/03/88 ->								1.970.106	C10				
All engines	->year 27/03/88											1.965.005		
16	Petrol	76	03/86-12/94	ENGINE 180Z										
Engine	Information			A10	A20	A40	A50	A70	C10 - C30	C20	E01			
All engines	->year 31/10/89, version Bosch					1.306.124								
All engines	01/11/89 ->, version Bosch					1.306.241								
All engines	version Bosch						1.406.056R							
All engines	01/11/89 ->								1.970.105	C10			1.500.491	
All engines	->year 31/10/89											1.965.005		1.500.747
16 E	Petrol	65	05/89-02/93	ENGINE BDY (XU5M), BDZ (XU5M)										
Engine	Information			A10	A20	A40	A50	A70	C10 - C30	C20	E01			
All engines	->year 28/04/91, version Ducellier					1.315.074	1.415.102R							
All engines	->year 28/04/91, Kit, version Ducellier					1.315.087								
All engines	->year 28/04/91								1.970.106	C10				
All engines	29/04/91 ->								1.970.188	C10			1.500.674	
19	Petrol	70	09/86-12/89	ENGINE D2C (XU92C)										
Engine	Information			A10	A20	A40	A50	A70	C10 - C30	C20	E01			
All engines	distr. num. 0237009058, distr. num. 0237009068, version Bosch					1.306.124								
All engines	distr. num. 0237009623, version Bosch					1.306.241								
All engines	distr. num. 2525691, distr. num. 2525692A, distr. num. 2525692B, version Ducellier					1.315.067	1.415.094	1.915.017						
All engines	distr. num. 2525717A, 2525747, version Ducellier					1.315.074	1.415.102R	1.915.019						
All engines	Kit, distr. num. 2525717A, 2525747, version Ducellier					1.315.087								
All engines	version Bosch						1.406.056R							
All engines	23/05/89 ->								1.970.106	C10				
All engines	->year 22/05/89											1.965.005		
19	Petrol	75	07/86-12/94	ENGINE 159A, D2A (XU92C)										
Engine	Information			A10	A20	A40	A50	A70	C10 - C30	C20	E01			
All engines	distr. num. 0237009058, distr. num. 0237009068, version Bosch					1.306.124								
All engines	distr. num. 0237009623, version Bosch					1.306.241								
All engines	distr. num. 2525691, distr. num. 2525692A, distr. num. 2525692B, version Ducellier					1.315.067	1.415.094	1.915.017						
All engines	distr. num. 2525717A, 2525747, version Ducellier					1.315.074	1.415.102R	1.915.019						
All engines	Kit, distr. num. 2525717A, 2525747, version Ducellier					1.315.087								
All engines	version Bosch						1.406.056R							
All engines	23/05/89 ->								1.970.106	C10				
All engines	->year 22/05/89											1.965.005		
A10	CONDENSER		A20	CONTACT SET		A40	DISTRIBUTOR CAP		A50	ROTOR		A70	PICK-UP	
C10	COIL		C20	IGNITION MODULE		C30	ELECTRONIC IGNITION KIT		E01	IGNITION CABLE SET				

FUNCTIONS ON THE VEHICLE

Vehicle	alim.	kW	Date	Engine								
ENGINE												
19	Petrol	75	07/86-12/94	159A, D2A (XU92C)								
Engine	Information				A10	A20	A40	A50	A70	C10 - C30	C20	E01
All engines	23/05/89 ->									1.970.106	C10	
All engines	->year 22/05/89										1.965.005	
ENGINE												
19	Petrol	76	01/87-01/92	D2A (XU92C)								
Engine	Information				A10	A20	A40	A50	A70	C10 - C30	C20	E01
All engines	distr. num. 0237009058, distr. num. 0237009068, version Bosch						1.306.124					
All engines	distr. num. 0237009623, version Bosch						1.306.241					
All engines	distr. num. 2525691, distr. num. 2525692A, distr. num. 2525692B, version Ducellier						1.315.067	1.415.094	1.915.017			
All engines	distr. num. 2525717A, 2525747, version Ducellier						1.315.074	1.415.102R	1.915.019			
All engines	Kit, distr. num. 2525717A, 2525747, version Ducellier						1.315.087					
All engines	version Bosch							1.406.056R				
All engines	23/05/89 ->									1.970.106	C10	
All engines	->year 22/05/89										1.965.005	
ENGINE												
19	Petrol	77	07/86-05/89	D2A (XU92C)								
Engine	Information				A10	A20	A40	A50	A70	C10 - C30	C20	E01
All engines	distr. num. 0237009058, distr. num. 0237009068, version Bosch						1.306.124					
All engines	distr. num. 0237009623, version Bosch						1.306.241					
All engines	distr. num. 2525691, distr. num. 2525692A, distr. num. 2525692B, version Ducellier						1.315.067	1.415.094	1.915.017			
All engines	distr. num. 2525717A, 2525747, version Ducellier						1.315.074	1.415.102R	1.915.019			
All engines	Kit, distr. num. 2525717A, 2525747, version Ducellier						1.315.087					
All engines	version Bosch							1.406.056R				
All engines	23/05/89 ->									1.970.106	C10	
All engines	->year 22/05/89										1.965.005	
ENGINE												
19	Petrol	78	09/84-01/92	D2E								
Engine	Information				A10	A20	A40	A50	A70	C10 - C30	C20	E01
All engines	distr. num. 0237009058, distr. num. 0237009068, version Bosch						1.306.124					
All engines	distr. num. 0237009623, version Bosch						1.306.241					
All engines	distr. num. 2525691, distr. num. 2525692A, distr. num. 2525692B, version Ducellier						1.315.067	1.415.094	1.915.017			
All engines	distr. num. 2525717A, 2525747, version Ducellier						1.315.074	1.415.102R	1.915.019			
All engines	Kit, distr. num. 2525717A, 2525747, version Ducellier						1.315.087					
All engines	version Bosch							1.406.056R				
All engines	23/05/89 ->									1.970.106	C10	
All engines	->year 22/05/89										1.965.005	
ENGINE												
19	Petrol	80	06/88-12/94	DDZ (XU9M)								
Engine	Information				A10	A20	A40	A50	A70	C10 - C30	C20	E01
All engines	version Ducellier						1.315.074	1.415.102R				
All engines	Kit, version Ducellier						1.315.087					
ENGINE												
19	Petrol	88	06/88-12/94	DKZ (XU9JA)								
Engine	Information				A10	A20	A40	A50	A70	C10 - C30	C20	E01
All engines	version Bosch, ->year 05/06/88, version Export, FOR: (J)						1.306.124					
All engines	version Bosch, ->year 02/05/90						1.306.241					
All engines	version Ducellier, ->year 05/06/88, version Export, distr. num. 2525678, FOR: (J)						1.315.067	1.415.094	1.915.017			
All engines	version Ducellier, ->year 02/05/90, 06/06/88 ->, version Export, distr. num. 2525709A, FOR: (J)						1.315.074	1.415.102R				
All engines	Kit, version Ducellier, ->year 02/05/90, 06/06/88 ->, version Export, distr. num. 2525709A, FOR: (J)						1.315.087					
All engines	->year 02/05/90, version Bosch, ->year 05/06/88, version Export, FOR: (J)							1.406.056R				
All engines	->year 02/05/90, version Ducellier								1.915.019			
All engines	02/07/90 ->, version Export									1.970.105	C10	
All engines	27/05/87 ->, ->year 02/05/90									1.970.106	C10	
All engines	03/05/90 ->									1.970.188	C10	
All engines	->year 26/05/87, version Export, FOR: (J)										1.965.005	
All engines	27/05/87 ->, FOR: (A), ->year 02/05/90, FOR: (J)											1.500.747

A10	CONDENSER	A20	CONTACT SET	A40	DISTRIBUTOR CAP	A50	ROTOR	A70	PICK-UP
C10	COIL	C20	IGNITION MODULE	C30	ELECTRONIC IGNITION KIT	E01	IGNITION CABLE SET		

Vehicle	alim.	kW	Date	Engine	FUNCTIONS ON THE VEHICLE									
					A10	A20	A40	A50	A70	C10 - C30	C20	E01		
19	Petrol	90	07/86-01/92	ENGINE D6A (XU9J2)										
Engine	Information				A10	A20	A40	A50	A70	C10 - C30	C20	E01		
All engines	version Bosch, ->year 05/06/88, version Export, FOR: (J)						1.306.124							
All engines	->year 02/05/90, version Bosch						1.306.241							
All engines	version Ducellier, ->year 05/06/88, version Export, distr. num. 2525678, FOR: (J)						1.315.067	1.415.094	1.915.017					
All engines	->year 02/05/90, version Ducellier, 06/06/88 ->, version Export, distr. num. 2525709A, FOR: (J)						1.315.074	1.415.102R						
All engines	Kit, ->year 02/05/90, version Ducellier, 06/06/88 ->, version Export, distr. num. 2525709A, FOR: (J)						1.315.087							
All engines	->year 02/05/90, version Bosch, ->year 05/06/88, version Export, FOR: (J)							1.406.056R						
All engines	->year 02/05/90, version Ducellier								1.915.019					
All engines	02/07/90 ->, version Export									1.970.105	C10			
All engines	->year 02/05/90, 27/05/87 ->									1.970.106	C10			
All engines	03/05/90 ->									1.970.188	C10			
All engines	->year 26/05/87, version Export, FOR: (J)											1.965.005		
All engines	->year 02/05/90, 27/05/87 ->, FOR: (A), FOR: (J)												1.500.747	
19 4x4	Petrol	80	10/90-05/91	ENGINE DDZ (XU9M)										
Engine	Information				A10	A20	A40	A50	A70	C10 - C30	C20	E01		
All engines	version Ducellier						1.315.074	1.415.102R						
All engines	Kit, version Ducellier						1.315.087							
19 Cat	Petrol	75	07/86-12/94	ENGINE DFZ (XU9J1)										
Engine	Information				A10	A20	A40	A50	A70	C10 - C30	C20	E01		
All engines	version Bosch, ->year 05/06/88, version Export, FOR: (J)						1.306.124							
All engines	->year 02/05/90, version Bosch						1.306.241							
All engines	version Ducellier, ->year 05/06/88, version Export, distr. num. 2525678, FOR: (J)						1.315.067	1.415.094	1.915.017					
All engines	->year 02/05/90, version Ducellier, 06/06/88 ->, version Export, distr. num. 2525709A, FOR: (J)						1.315.074	1.415.102R						
All engines	Kit, ->year 02/05/90, version Ducellier, 06/06/88 ->, version Export, distr. num. 2525709A, FOR: (J)						1.315.087							
All engines	->year 02/05/90, version Bosch, ->year 05/06/88, version Export, FOR: (J)							1.406.056R						
All engines	->year 02/05/90, version Ducellier								1.915.019					
All engines	02/07/90 ->, version Export									1.970.105	C10			
All engines	->year 02/05/90, 27/05/87 ->									1.970.106	C10			
All engines	03/05/90 ->									1.970.188	C10			
All engines	->year 26/05/87, version Export, FOR: (J)											1.965.005		
All engines	->year 02/05/90, 27/05/87 ->, FOR: (A), FOR: (J)												1.500.747	
19 E	Petrol	80	06/88-02/93	ENGINE DDZ (XU9M)										
Engine	Information				A10	A20	A40	A50	A70	C10 - C30	C20	E01		
All engines	version Ducellier						1.315.074	1.415.102R						
All engines	Kit, version Ducellier						1.315.087							
19 E 4x4	Petrol	80	04/89-02/93	ENGINE D2F										
Engine	Information				A10	A20	A40	A50	A70	C10 - C30	C20	E01		
All engines	distr. num. 0237009058, distr. num. 0237009068, version Bosch						1.306.124							
All engines	distr. num. 0237009623, version Bosch						1.306.241							
All engines	distr. num. 2525691, distr. num. 2525692A, distr. num. 2525692B, version Ducellier						1.315.067	1.415.094	1.915.017					
All engines	distr. num. 2525717A, 2525747, version Ducellier						1.315.074	1.415.102R	1.915.019					
All engines	Kit, distr. num. 2525717A, 2525747, version Ducellier						1.315.087							
All engines	version Bosch							1.406.056R						
All engines	23/05/89 ->									1.970.106	C10			
All engines	->year 22/05/89											1.965.005		
19 GTi	Petrol	88	06/88-02/93	ENGINE DKZ (XU9JA)										
Engine	Information				A10	A20	A40	A50	A70	C10 - C30	C20	E01		
All engines	version Bosch, ->year 05/06/88, version Export, FOR: (J)						1.306.124							
All engines	->year 02/05/90, version Bosch						1.306.241							
All engines	version Ducellier, ->year 05/06/88, version Export, distr. num. 2525678, FOR: (J)						1.315.067	1.415.094	1.915.017					
All engines	->year 02/05/90, version Ducellier, 06/06/88 ->, version Export, distr. num. 2525709A, FOR: (J)						1.315.074	1.415.102R						

A10 CONDENSER	A20 CONTACT SET	A40 DISTRIBUTOR CAP	A50 ROTOR	A70 PICK-UP
C10 COIL	C20 IGNITION MODULE	C30 ELECTRONIC IGNITION KIT	E01 IGNITION CABLE SET	

The present application list is a brief version. For the detailed information about the possibility of installation on a specific vehicle, please refer to our web-catalogue <http://catalogo.facet.eu/>

Vehicle	alim.	kW	Date	Engine	FUNCTIONS ON THE VEHICLE							
					A10	A20	A40	A50	A70	C10 - C30	C20	E01

ENGINE				
19 GTi	Petrol	88	06/88-02/93	DKZ (XU9JA)

Engine	Information	A10	A20	A40	A50	A70	C10 - C30	C20	E01
All engines	Kit, ->year 02/05/90, version Ducellier, 06/06/88 ->, version Export, distr. num. 2525709A, FOR: (J)			1.315.087					
All engines	->year 02/05/90, version Bosch, ->year 05/06/88, version Export, FOR: (J)				1.406.056R				
All engines	->year 02/05/90, version Ducellier					1.915.019			
All engines	02/07/90 ->, version Export						1.970.105	C10	
All engines	->year 02/05/90, 27/05/87 ->						1.970.106	C10	
All engines	03/05/90 ->						1.970.188	C10	
All engines	->year 26/05/87, version Export, FOR: (J)							1.965.005	
All engines	->year 02/05/90, 27/05/87 ->, FOR: (A), FOR: (J)								1.500.747

ENGINE				
19 GTi	Petrol	90	07/86-02/93	D6A (XU9J2)

Engine	Information	A10	A20	A40	A50	A70	C10 - C30	C20	E01
All engines	version Bosch, ->year 05/06/88, version Export, FOR: (J)			1.306.124					
All engines	->year 02/05/90, version Bosch			1.306.241					
All engines	version Ducellier, ->year 05/06/88, version Export, distr. num. 2525678, FOR: (J)			1.315.067	1.415.094	1.915.017			
All engines	->year 02/05/90, version Ducellier, 06/06/88 ->, version Export, distr. num. 2525709A, FOR: (J)			1.315.074	1.415.102R				
All engines	Kit, ->year 02/05/90, version Ducellier, 06/06/88 ->, version Export, distr. num. 2525709A, FOR: (J)			1.315.087					
All engines	->year 02/05/90, version Bosch, ->year 05/06/88, version Export, FOR: (J)				1.406.056R				
All engines	->year 02/05/90, version Ducellier					1.915.019			
All engines	02/07/90 ->, version Export						1.970.105	C10	
All engines	->year 02/05/90, 27/05/87 ->						1.970.106	C10	
All engines	03/05/90 ->						1.970.188	C10	
All engines	->year 26/05/87, version Export, FOR: (J)							1.965.005	
All engines	->year 02/05/90, 27/05/87 ->, FOR: (A), FOR: (J)								1.500.747

ENGINE				
19 GTi 16V	Petrol	108	03/88-02/93	DFW (XU9J4)

Engine	Information	A10	A20	A40	A50	A70	C10 - C30	C20	E01
All engines	version Ducellier			1.315.077	1.415.104				
All engines	Kit, version Ducellier			1.315.078					
All engines							1.970.106	C10	1.965.005

ENGINE				
19 GTi 16V	Petrol	116	09/87-12/88	D6C (XU9J4)

Engine	Information	A10	A20	A40	A50	A70	C10 - C30	C20	E01
All engines	version Ducellier			1.315.077	1.415.104				
All engines	Kit, version Ducellier			1.315.078					
All engines							1.970.106	C10	1.965.005

ENGINE				
19 GTi 4x4	Petrol	88	06/88-02/93	DKZ (XU9JA)

Engine	Information	A10	A20	A40	A50	A70	C10 - C30	C20	E01
All engines	version Bosch, ->year 05/06/88, version Export, FOR: (J)			1.306.124					
All engines	->year 02/05/90, version Bosch			1.306.241					
All engines	version Ducellier, ->year 05/06/88, version Export, distr. num. 2525678, FOR: (J)			1.315.067	1.415.094	1.915.017			
All engines	->year 02/05/90, version Ducellier, 06/06/88 ->, version Export, distr. num. 2525709A, FOR: (J)			1.315.074	1.415.102R				
All engines	Kit, ->year 02/05/90, version Ducellier, 06/06/88 ->, version Export, distr. num. 2525709A, FOR: (J)			1.315.087					
All engines	->year 02/05/90, version Bosch, ->year 05/06/88, version Export, FOR: (J)				1.406.056R				
All engines	->year 02/05/90, version Ducellier					1.915.019			
All engines	02/07/90 ->, version Export						1.970.105	C10	
All engines	->year 02/05/90, 27/05/87 ->						1.970.106	C10	
All engines	03/05/90 ->						1.970.188	C10	
All engines	->year 26/05/87, version Export, FOR: (J)							1.965.005	
All engines	->year 02/05/90, 27/05/87 ->, FOR: (A), FOR: (J)								1.500.747

C1 I				
ENGINE				
1.0	Petrol	50	06/05-09/14	CFA (384F), CFB (1KR)

Engine	Information	A10	A20	A40	A50	A70	C10 - C30	C20	E01
All engines	x 3, COIL ON PLUG						1.970.461	C10	

A10	CONDENSER	A20	CONTACT SET	A40	DISTRIBUTOR CAP	A50	ROTOR	A70	PICK-UP
C10	COIL	C20	IGNITION MODULE	C30	ELECTRONIC IGNITION KIT	E01	IGNITION CABLE SET		

Vehicle	alim.	kW	Date	Engine	FUNCTIONS ON THE VEHICLE							
					A10	A20	A40	A50	A70	C10 - C30	C20	E01

C1 II

ENGINE
1.0 VTI 68

Engine	Information	A10	A20	A40	A50	A70	C10 - C30	C20	E01
All engines	euro5/euro6, x 3, COIL ON PLUG						1.970.459	C10	

ENGINE
1.0 VTI 72

Engine	Information	A10	A20	A40	A50	A70	C10 - C30	C20	E01
All engines	euro5/euro6, x 3, COIL ON PLUG						1.970.459	C10	

ENGINE
1.2 VTI 82

Engine	Information	A10	A20	A40	A50	A70	C10 - C30	C20	E01
All engines	x 3, COIL ON PLUG						1.970.609	C10	

C15

ENGINE
1.0

Engine	Information	A10	A20	A40	A50	A70	C10 - C30	C20	E01
All engines	version Bosch			1.306.124	1.406.056R				
All engines	version Ducellier			1.315.058	1.415.094				
All engines								1.965.005	

ENGINE
1.0

Engine	Information	A10	A20	A40	A50	A70	C10 - C30	C20	E01
All engines	version Bosch			1.306.241	1.406.056R				
All engines	version Ducellier			1.315.074	1.415.102R	1.915.019			
All engines	Kit, version Ducellier			1.315.087					
All engines							1.970.105	C10	1.501.376

ENGINE
1.0

Engine	Information	A10	A20	A40	A50	A70	C10 - C30	C20	E01
All engines	version Bosch			1.306.241	1.406.056R				
All engines	version Ducellier			1.315.074	1.415.102R	1.915.019			
All engines	Kit, version Ducellier			1.315.087					
All engines							1.970.105	C10	1.501.376

ENGINE
1.0 E

Engine	Information	A10	A20	A40	A50	A70	C10 - C30	C20	E01
All engines	version Bosch			1.306.124	1.406.056R				
All engines	version Ducellier			1.315.058	1.415.094				
All engines								1.965.005	

ENGINE
1.1

Engine	Information	A10	A20	A40	A50	A70	C10 - C30	C20	E01
All engines	version Bosch			1.306.124					
All engines	version Ducellier			1.315.058	1.415.094				
Eng. 109K	version Bosch				1.406.056R				
Eng. E1A	version Bosch				1.406.061R				
Eng. E1A							1.970.106	C10	
All engines									1.965.005

ENGINE
1.1

Engine	Information	A10	A20	A40	A50	A70	C10 - C30	C20	E01
All engines	version Bosch			1.306.124	1.406.056R				
All engines	version Ducellier			1.315.058	1.415.094				
All engines								1.965.005	

ENGINE
1.1

Engine	Information	A10	A20	A40	A50	A70	C10 - C30	C20	E01
All engines	version Bosch			1.306.241	1.406.056R				
All engines	version Ducellier			1.315.074	1.415.102R	1.915.019			
All engines	Kit, version Ducellier			1.315.087					

A10 CONDENSER	A20 CONTACT SET	A40 DISTRIBUTOR CAP	A50 ROTOR	A70 PICK-UP
C10 COIL	C20 IGNITION MODULE	C30 ELECTRONIC IGNITION KIT	E01 IGNITION CABLE SET	









Vehicle	alim.	kW	Date	Engine	FUNCTIONS ON THE VEHICLE									
					A10	A20	A40	A50	A70	C10 - C30	C20	E01		
ENGINE														
1.1	Petrol	40	11/88-07/96	H1A										
ENGINE														
1.1	Petrol	44	08/88-07/96	HDZ (TU1M)										
ENGINE														
1.1 i	Petrol	44	07/88-12/96	HDZ (TU1M), TU1MZ										
ENGINE														
1.3	Petrol	47	07/87-05/88	G1A										
ENGINE														
1.4	Petrol	44	05/87-10/92	150D (XY7)										
ENGINE														
1.4	Petrol	49	07/87-12/96	K1H (TU3A)										
ENGINE														
1.4	Petrol	51	08/87-04/91	K1G										
ENGINE														
1.4	Petrol	55	05/91-07/96	KDY (TU3M)										
ENGINE														
1.4 E	Petrol	40	07/86-12/96	K3A, KAZ										
ENGINE														
1.4 E	Petrol	44	05/87-12/96	150D (XY7)										
ENGINE														
ENGINE														

A10 CONDENSER	A20 CONTACT SET	A40 DISTRIBUTOR CAP	A50 ROTOR	A70 PICK-UP
C10 COIL	C20 IGNITION MODULE	C30 ELECTRONIC IGNITION KIT	E01 IGNITION CABLE SET	

Vehicle	alim.	kW	Date	Engine	FUNCTIONS ON THE VEHICLE									
					A10	A20	A40	A50	A70	C10 - C30	C20	E01		
ENGINE														
1.4 E	Petrol	44	05/87-12/96	150D (XY7)										
Engine	Information				A10	A20	A40	A50	A70	C10 - C30	C20	E01		
All engines	version Ducellier						1.315.067	1.415.094						
All engines											1.965.005			
ENGINE														
1.4 E	Petrol	52	08/87-10/92	K1F										
Engine	Information				A10	A20	A40	A50	A70	C10 - C30	C20	E01		
All engines	version Bosch						1.306.241	1.406.056R						
All engines	version Ducellier						1.315.074	1.415.102R	1.915.019					
All engines	Kit, version Ducellier						1.315.087							
All engines										1.970.105	C10		1.501.376	
ENGINE														
1.4 E	Petrol	55	05/91-12/96	K2D										
Engine	Information				A10	A20	A40	A50	A70	C10 - C30	C20	E01		
All engines	version Bosch						1.306.241	1.406.056R						
All engines	version Ducellier						1.315.074	1.415.102R	1.915.019					
All engines	Kit, version Ducellier						1.315.087							
All engines										1.970.105	C10		1.501.376	
ENGINE														
1.4 i	Petrol	55	05/91-12/96	KDY (TU3FM), KDY (TU3M)										
Engine	Information				A10	A20	A40	A50	A70	C10 - C30	C20	E01		
All engines	version Bosch						1.306.241	1.406.056R						
All engines	version Ducellier						1.315.074	1.415.102R	1.915.019					
All engines	Kit, version Ducellier						1.315.087							
All engines										1.970.105	C10		1.501.376	
C2														
ENGINE														
1.1	Petrol	44	09/03-09/12	HFX (TU1JP)										
Engine	Information				A10	A20	A40	A50	A70	C10 - C30	C20	E01		
All engines										1.970.405	C10			
ENGINE														
1.4	Petrol	54	09/03-12/09	KFV (TU3JP)										
Engine	Information				A10	A20	A40	A50	A70	C10 - C30	C20	E01		
All engines										1.970.405	C10			
ENGINE														
1.4	Petrol	55	10/06-12/09	KFV (TU3JP)										
Engine	Information				A10	A20	A40	A50	A70	C10 - C30	C20	E01		
All engines	x 1, COIL ON PLUG									1.970.405	C10			
ENGINE														
1.4 16V	Petrol	65	04/05-12/09	KFU (ET3J4)										
Engine	Information				A10	A20	A40	A50	A70	C10 - C30	C20	E01		
All engines	x 1, COIL ON PLUG									1.970.483	C10			
ENGINE														
1.6	Petrol	80	07/03-10/10	NFU (TU5JP4)										
Engine	Information				A10	A20	A40	A50	A70	C10 - C30	C20	E01		
All engines	x 1, COIL ON PLUG									1.970.407	C10			
ENGINE														
1.6 VTS	Petrol	90	10/04-12/09	NFS (TU5JP4S)										
Engine	Information				A10	A20	A40	A50	A70	C10 - C30	C20	E01		
All engines	x 1, COIL ON PLUG									1.970.407	C10			
C3 AIRCROSS														
ENGINE														
1.2 PureTech 82	Petrol	60	06/17->	HMR (EB2FA), HMZ (EB2F)										
Engine	Information				A10	A20	A40	A50	A70	C10 - C30	C20	E01		
All engines	x 3, COIL ON PLUG									1.970.609	C10			
ENGINE														
PureTech 82	Petrol	60	05/19->	HMZ (EB2F)										
Engine	Information				A10	A20	A40	A50	A70	C10 - C30	C20	E01		
All engines	x 3, COIL ON PLUG									1.970.609	C10			

A10	CONDENSER	A20	CONTACT SET	A40	DISTRIBUTOR CAP	A50	ROTOR	A70	PICK-UP
C10	COIL	C20	IGNITION MODULE	C30	ELECTRONIC IGNITION KIT	E01	IGNITION CABLE SET		

The present application list is a brief version. For the detailed information about the possibility of installation on a specific vehicle, please refer to our web-catalogue <http://catalogo.facet.eu/>

					FUNCTIONS ON THE VEHICLE							
Vehicle	alim.	kW	Date	Engine								
PureTech 82												
ENGINE												
Petrol		81	05/19->	HNZ (EB2DT)								
Engine		Information			A10	A20	A40	A50	A70	C10 - C30	C20	E01
All engines		x 3, COIL ON PLUG								1.970.620	C10	
C3 I												
1.1 i												
ENGINE												
Petrol		44	02/02->	HFX (TU1A), HFX (TU1JP)								
Engine		Information			A10	A20	A40	A50	A70	C10 - C30	C20	E01
All engines										1.970.405	C10	
1.1 LPG												
ENGINE												
Petrol/ Liquified Petro- leum Gas (LPG)		44	06/06-12/09	HFX (TU1A)								
Engine		Information			A10	A20	A40	A50	A70	C10 - C30	C20	E01
All engines		x 4, COIL ON PLUG								1.970.405	C10	
1.4 16V												
ENGINE												
Petrol		65	12/03->	KFU (ET3J4)								
Engine		Information			A10	A20	A40	A50	A70	C10 - C30	C20	E01
All engines		x 1, COIL ON PLUG								1.970.483	C10	
1.4 BiFuel												
ENGINE												
Petrol/ Liquified Petro- leum Gas (LPG)		54	09/08-12/09	KFV (TU3JP)								
Engine		Information			A10	A20	A40	A50	A70	C10 - C30	C20	E01
All engines		x 1, COIL ON PLUG								1.970.405	C10	
1.4 i												
ENGINE												
Petrol		54	02/02-11/10	KFV (TU3A), KFV (TU3JP)								
Engine		Information			A10	A20	A40	A50	A70	C10 - C30	C20	E01
All engines		x 1, COIL ON PLUG								1.970.405	C10	
1.4 i Bivalent												
ENGINE												
Petrol/ Com- pressed Natural Gas (CNG)		54	02/02->	KFV (TU3JP)								
Engine		Information			A10	A20	A40	A50	A70	C10 - C30	C20	E01
All engines		x 1, COIL ON PLUG								1.970.405	C10	
1.6 16V												
ENGINE												
Petrol		80	02/02->	N6A (TU5JP4), NFU (TU5JP4)								
Engine		Information			A10	A20	A40	A50	A70	C10 - C30	C20	E01
Eng. N6A (TU5JP4)										1.970.407	C10	
Eng. NFU (TU5JP4)		x 1, COIL ON PLUG								1.970.407	C10	
1.6 16V												
ENGINE												
Petrol		81	05/03-09/05	NFU (TU5JP4)								
Engine		Information			A10	A20	A40	A50	A70	C10 - C30	C20	E01
All engines		x 1, COIL ON PLUG								1.970.407	C10	
C3 I PLURIEL												
1.4												
ENGINE												
Petrol		54	05/03->	KFV (TU3A), KFV (TU3JP)								
Engine		Information			A10	A20	A40	A50	A70	C10 - C30	C20	E01
All engines		x 1, COIL ON PLUG								1.970.405	C10	
1.4												
ENGINE												
Petrol		55	07/03->	KFV (TU3A)								
Engine		Information			A10	A20	A40	A50	A70	C10 - C30	C20	E01
All engines		x 4, COIL ON PLUG								1.970.405	C10	
1.4 Hybrid												
ENGINE												
Petrol/ Electric		54	05/05->	KFV (TU3JP)								
Engine		Information			A10	A20	A40	A50	A70	C10 - C30	C20	E01
All engines										1.970.405	C10	

A10 CONDENSER	A20 CONTACT SET	A40 DISTRIBUTOR CAP	A50 ROTOR	A70 PICK-UP
C10 COIL	C20 IGNITION MODULE	C30 ELECTRONIC IGNITION KIT	E01 IGNITION CABLE SET	

Vehicle	alim.	kW	Date	Engine	FUNCTIONS ON THE VEHICLE												
					A10	A20	A40	A50	A70	C10 - C30	C20	E01					
ENGINE																	
1.6	Petrol	80	05/03->	NFU (TU5JP4)													
Engine					A10	A20	A40	A50	A70	C10 - C30	C20	E01					
Information										1.970.407	C10						
All engines																	
Information																	
x 1, COIL ON PLUG																	
C3 II																	
ENGINE																	
1.0VTi 68	Petrol	50	08/12->	ZMZ (EB0)													
Engine					A10	A20	A40	A50	A70	C10 - C30	C20	E01					
Information										1.970.609	C10						
All engines																	
x 3, COIL ON PLUG																	
ENGINE																	
1.1 BiFuel	Petrol/ Liquified Petro- leum Gas (LPG)	44	11/10->	HFX (TU1A)													
Engine					A10	A20	A40	A50	A70	C10 - C30	C20	E01					
Information										1.970.405	C10						
All engines																	
x 4, COIL ON PLUG																	
ENGINE																	
1.1 i	Petrol	44	09/09-01/13	HFV (TU1A), HFX (TU1A)													
Engine					A10	A20	A40	A50	A70	C10 - C30	C20	E01					
Information										1.970.405	C10						
All engines																	
x 1, COIL ON PLUG																	
ENGINE																	
1.2 THP 110	Petrol	81	10/14->	HNZ (EB2DT)													
Engine					A10	A20	A40	A50	A70	C10 - C30	C20	E01					
Information										1.970.620	C10						
All engines																	
x 3, COIL ON PLUG																	
ENGINE																	
1.2 VTi 82	Petrol	60	06/12-09/16	177L, HMZ (EB2F)													
Engine					A10	A20	A40	A50	A70	C10 - C30	C20	E01					
Information										1.970.609	C10						
All engines																	
x 3, COIL ON PLUG																	
ENGINE																	
1.4	Petrol	54	11/09-09/16	K6E (TU3A), KFT (TU3A), KFT (TU3AE5)													
Engine					A10	A20	A40	A50	A70	C10 - C30	C20	E01					
Information										1.970.405	C10						
All engines																	
x 4, COIL ON PLUG																	
ENGINE																	
1.4 16V	Petrol	70	11/09->	EP3C													
Engine					A10	A20	A40	A50	A70	C10 - C30	C20	E01					
Information										1.970.475	C10						
All engines																	
Qty: 4																	
ENGINE																	
1.4 i	Petrol	55	11/09->	TU 3 JP													
Engine					A10	A20	A40	A50	A70	C10 - C30	C20	E01					
Information										1.970.405	C10						
All engines																	
ENGINE																	
1.4 LPG	Petrol/ Liquified Petro- leum Gas (LPG)	54	07/10->	KFT (TU3A)													
Engine					A10	A20	A40	A50	A70	C10 - C30	C20	E01					
Information										1.970.405	C10						
All engines																	
x 4, COIL ON PLUG																	
ENGINE																	
1.4 LPG	Petrol/ Liquified Petro- leum Gas (LPG)	70	06/13->	8FN (EP3)													
Engine					A10	A20	A40	A50	A70	C10 - C30	C20	E01					
Information										1.970.475	C10						
All engines																	
x 4, COIL ON PLUG																	
ENGINE																	
1.4 VTi	Petrol	72	11/09->	8FR (EP3)													
Engine					A10	A20	A40	A50	A70	C10 - C30	C20	E01					
Information										1.970.475	C10						
All engines																	
x 4, COIL ON PLUG																	
ENGINE																	
1.4 VTi 95	Petrol	70	11/09->	8FP (EP3C)													
Engine					A10	A20	A40	A50	A70	C10 - C30	C20	E01					
Information										1.970.475	C10						
All engines																	
x 4, COIL ON PLUG																	
ENGINE																	
A10	CONDENSER			A20	CONTACT SET			A40	DISTRIBUTOR CAP			A50	ROTOR		A70	PICK-UP	
C10	COIL			C20	IGNITION MODULE			C30	ELECTRONIC IGNITION KIT			E01	IGNITION CABLE SET				

Vehicle	alim.	kW	Date	Engine	FUNCTIONS ON THE VEHICLE							
					A10	A20	A40	A50	A70	C10 - C30	C20	E01
ENGINE												
1.6 Flex	Petrol/ Ethanol	81	11/09->	NFX (TU5JP4)								
Engine	Information				A10	A20	A40	A50	A70	C10 - C30	C20	E01
All engines										1.970.407	C10	
ENGINE												
1.6 Vti 120	Petrol	88	11/09->	5FS (EP6C)								
Engine	Information				A10	A20	A40	A50	A70	C10 - C30	C20	E01
All engines	x 4, COIL ON PLUG									1.970.475	C10	
C3 III												
ENGINE												
1.2 PureTech 82	Petrol	61	05/18->	HMR (EB2FA)								
Engine	Information				A10	A20	A40	A50	A70	C10 - C30	C20	E01
All engines	x 3, COIL ON PLUG									1.970.609	C10	
ENGINE												
1.2 PureTech 82 LPG	Petrol/ Liquified Petro- leum Gas (LPG)	61	05/18->	HMR (EB2FA)								
Engine	Information				A10	A20	A40	A50	A70	C10 - C30	C20	E01
All engines	x 3, COIL ON PLUG									1.970.609	C10	
ENGINE												
1.2 Vti 68	Petrol	50	07/16->	HMM (EB2FAD), HMP (EB2FB)								
Engine	Information				A10	A20	A40	A50	A70	C10 - C30	C20	E01
All engines	x 3, COIL ON PLUG									1.970.609	C10	
ENGINE												
1.2 Vti 82	Petrol	60	07/16->	HMZ (EB2F)								
Engine	Information				A10	A20	A40	A50	A70	C10 - C30	C20	E01
All engines	x 3, COIL ON PLUG									1.970.609	C10	
ENGINE												
1.2 Vti 82 LPG	Petrol/ Liquified Petro- leum Gas (LPG)	60	07/16->	HMZ (EB2F)								
Engine	Information				A10	A20	A40	A50	A70	C10 - C30	C20	E01
All engines	x 3, COIL ON PLUG									1.970.609	C10	
ENGINE												
PureTech 110	Petrol	81	03/19->	HNZ (EB2DT)								
Engine	Information				A10	A20	A40	A50	A70	C10 - C30	C20	E01
All engines	x 3, COIL ON PLUG									1.970.620	C10	
ENGINE												
PureTech 82	Petrol	61	03/19->	HMR (EB2FA)								
Engine	Information				A10	A20	A40	A50	A70	C10 - C30	C20	E01
All engines	x 3, COIL ON PLUG									1.970.609	C10	
C3 PICASSO												
ENGINE												
1.2 THP 110	Petrol	81	01/15->	HNZ (EB2DT)								
Engine	Information				A10	A20	A40	A50	A70	C10 - C30	C20	E01
All engines	x 3, COIL ON PLUG									1.970.620	C10	
ENGINE												
1.4 Vti 95	Petrol	70	02/09->	8FN (EP3), 8FP (EP3C), 8FS (EP3)								
Engine	Information				A10	A20	A40	A50	A70	C10 - C30	C20	E01
All engines	x 4, COIL ON PLUG									1.970.475	C10	
ENGINE												
1.4 Vti 95 LPG	Petrol/ Liquified Petro- leum Gas (LPG)	70	01/12->	8FN (EP3)								
Engine	Information				A10	A20	A40	A50	A70	C10 - C30	C20	E01
All engines	x 4, COIL ON PLUG									1.970.475	C10	

A10 CONDENSER	A20 CONTACT SET	A40 DISTRIBUTOR CAP	A50 ROTOR	A70 PICK-UP
C10 COIL	C20 IGNITION MODULE	C30 ELECTRONIC IGNITION KIT	E01 IGNITION CABLE SET	

Vehicle	alim.	kW	Date	Engine	FUNCTIONS ON THE VEHICLE								
					A10	A20	A40	A50	A70	C10 - C30	C20	E01	
ENGINE													
1.6 VTi	Petrol	84	07/09->	5FP (EP6)									
Engine	Information				A10	A20	A40	A50	A70	C10 - C30	C20	E01	
All engines	x 4, COIL ON PLUG									1.970.475	C10		
ENGINE													
1.6 VTi 120	Petrol	88	02/09->	5FS (EP6C), 5FW (EP6)									
Engine	Information				A10	A20	A40	A50	A70	C10 - C30	C20	E01	
All engines	x 4, COIL ON PLUG									1.970.475	C10		
C4 AIRCROSS													
ENGINE													
1.6	Petrol	86	04/12->	4A92, NKZ (4A92)									
Engine	Information				A10	A20	A40	A50	A70	C10 - C30	C20	E01	
All engines	x 4, COIL ON PLUG									1.970.505	C10		
ENGINE													
2.0	Petrol	110	04/12->	4B11									
Engine	Information				A10	A20	A40	A50	A70	C10 - C30	C20	E01	
All engines	Qty: 4									1.970.497	C10		
All engines	x 4, COIL ON PLUG									1.970.497	C10		
ENGINE													
2.0 AWC	Petrol	110	04/12->	4B11									
Engine	Information				A10	A20	A40	A50	A70	C10 - C30	C20	E01	
All engines	Qty: 4									1.970.497	C10		
All engines	x 4, COIL ON PLUG									1.970.497	C10		
C4 CACTUS													
ENGINE													
1.2 VTi 75 / PureTech 75	Petrol	55	09/14->	HMU (EB2D), HMU (EB2FD)									
Engine	Information				A10	A20	A40	A50	A70	C10 - C30	C20	E01	
All engines	x 3, COIL ON PLUG									1.970.609	C10		
ENGINE													
1.2 VTi 82	Petrol	60	09/14->	HMZ (EB2F)									
Engine	Information				A10	A20	A40	A50	A70	C10 - C30	C20	E01	
All engines	x 3, COIL ON PLUG									1.970.609	C10		
ENGINE													
PureTech 130	Petrol	96	05/19->	HNY (EB2DTS)									
Engine	Information				A10	A20	A40	A50	A70	C10 - C30	C20	E01	
All engines	x 3, COIL ON PLUG									1.970.620	C10		
ENGINE													
PureTech 82	Petrol	60	05/19->	177L									
Engine	Information				A10	A20	A40	A50	A70	C10 - C30	C20	E01	
All engines	x 3, COIL ON PLUG									1.970.609	C10		
C4 GRAND PICASSO I													
ENGINE													
1.6 16V	Petrol	103	07/08-12/10	5FT (EP6DT)									
Engine	Information				A10	A20	A40	A50	A70	C10 - C30	C20	E01	
All engines	x 4, COIL ON PLUG									1.970.475	C10		
ENGINE													
1.6 16V	Petrol	110	10/08-08/13	5FX (EP6DT)									
Engine	Information				A10	A20	A40	A50	A70	C10 - C30	C20	E01	
All engines	x 4, COIL ON PLUG									1.970.475	C10		
ENGINE													
1.6 16V	Petrol	88	07/08->	EP6C									
Engine	Information				A10	A20	A40	A50	A70	C10 - C30	C20	E01	
All engines	Qty: 4									1.970.475	C10		
ENGINE													
1.6 THP 155	Petrol	115	09/10-08/13	5FV (EP6CDT)									
Engine	Information				A10	A20	A40	A50	A70	C10 - C30	C20	E01	
All engines	x 4, COIL ON PLUG									1.970.475	C10		

A10	CONDENSER	A20	CONTACT SET	A40	DISTRIBUTOR CAP	A50	ROTOR	A70	PICK-UP
C10	COIL	C20	IGNITION MODULE	C30	ELECTRONIC IGNITION KIT	E01	IGNITION CABLE SET		

The present application list is a brief version. For the detailed information about the possibility of installation on a specific vehicle, please refer to our web-catalogue <http://catalogo.facet.eu/>

FUNCTIONS ON THE VEHICLE

Vehicle	alim.	kW	Date	Engine	FUNCTIONS ON THE VEHICLE								
					A10	A20	A40	A50	A70	C10 - C30	C20	E01	
ENGINE													
1.6 VTi 120	Petrol	88	07/08-08/13	5FW (EP6)									
Engine	Information				A10	A20	A40	A50	A70	C10 - C30	C20	E01	
All engines	x 4, COIL ON PLUG									1.970.475	C10		
ENGINE													
1.8 i 16V	Petrol	92	10/06-12/10	6FY (EW7A)									
Engine	Information				A10	A20	A40	A50	A70	C10 - C30	C20	E01	
All engines	x 1, COIL ON PLUG									1.970.476	C10		
ENGINE													
1.8 i 16V Flex	Petrol/ Ethanol	86	06/09-01/13	6FY (EW7A)									
Engine	Information				A10	A20	A40	A50	A70	C10 - C30	C20	E01	
All engines	x 1, COIL ON PLUG									1.970.476	C10		
ENGINE													
2.0 i 16V	Petrol	103	10/06-08/13	RFJ (EW10A)									
Engine	Information				A10	A20	A40	A50	A70	C10 - C30	C20	E01	
All engines	x 1, COIL ON PLUG									1.970.476	C10		
ENGINE													
2.0 i 16V	Petrol	105	01/10-08/13	RFJ (EW10A)									
Engine	Information				A10	A20	A40	A50	A70	C10 - C30	C20	E01	
All engines										1.970.476	C10		
C4 GRAND PICASSO II													
ENGINE													
1.2 THP 130	Petrol	96	04/14->	HNY (EB2DTS)									
Engine	Information				A10	A20	A40	A50	A70	C10 - C30	C20	E01	
All engines	x 3, COIL ON PLUG									1.970.620	C10		
ENGINE													
1.6 THP 150	Petrol	110	09/14->	5FX (EP6DT)									
Engine	Information				A10	A20	A40	A50	A70	C10 - C30	C20	E01	
All engines	x 4, COIL ON PLUG									1.970.475	C10		
ENGINE													
1.6 THP 155	Petrol	115	09/13->	5FV (EP6CDT)									
Engine	Information				A10	A20	A40	A50	A70	C10 - C30	C20	E01	
All engines	x 4, COIL ON PLUG									1.970.475	C10		
ENGINE													
1.6 THP 165	Petrol	121	07/14->	5GZ (EP6FDT)									
Engine	Information				A10	A20	A40	A50	A70	C10 - C30	C20	E01	
All engines	x 4, COIL ON PLUG									1.970.475	C10		
ENGINE													
1.6 VTi 120	Petrol	88	09/13->	5FS (EP6C)									
Engine	Information				A10	A20	A40	A50	A70	C10 - C30	C20	E01	
All engines	x 4, COIL ON PLUG									1.970.475	C10		
C4 I													
ENGINE													
1.4 16V	Petrol	65	11/04-07/11	KFU (ET3J4)									
Engine	Information				A10	A20	A40	A50	A70	C10 - C30	C20	E01	
All engines	x 1, COIL ON PLUG									1.970.483	C10		
ENGINE													
1.6 16V	Petrol	80	11/04-07/11	NFU (TU5JP4)									
Engine	Information				A10	A20	A40	A50	A70	C10 - C30	C20	E01	
All engines	x 1, COIL ON PLUG									1.970.407	C10		
ENGINE													
1.6 16V Bio-Flex	Petrol	80	09/07->	N6A (TU5JP4)									
Engine	Information				A10	A20	A40	A50	A70	C10 - C30	C20	E01	
All engines	x 1, COIL ON PLUG									1.970.407	C10		
ENGINE													
1.6 16V Flex Fuel	Petrol	80	02/09->	N6A (TU5JP4)									
Engine	Information				A10	A20	A40	A50	A70	C10 - C30	C20	E01	
All engines										1.970.407	C10		

A10 CONDENSER	A20 CONTACT SET	A40 DISTRIBUTOR CAP	A50 ROTOR	A70 PICK-UP
C10 COIL	C20 IGNITION MODULE	C30 ELECTRONIC IGNITION KIT	E01 IGNITION CABLE SET	

Vehicle	alim.	kW	Date	Engine	FUNCTIONS ON THE VEHICLE								
					A10	A20	A40	A50	A70	C10 - C30	C20	E01	
ENGINE													
1.6 Flex	Petrol/ Ethanol	81	02/09-07/11	--									
Engine	Information				A10	A20	A40	A50	A70	C10 - C30	C20	E01	
All engines										1.970.407	C10		
ENGINE													
1.6 THP	Petrol	103	06/08-07/11	5FT (EP6DT)									
Engine	Information				A10	A20	A40	A50	A70	C10 - C30	C20	E01	
All engines	x 4, COIL ON PLUG									1.970.475	C10		
ENGINE													
1.6 THP 140	Petrol	103	07/08-07/11	5FT (EP6DT)									
Engine	Information				A10	A20	A40	A50	A70	C10 - C30	C20	E01	
All engines	x 4, COIL ON PLUG									1.970.475	C10		
ENGINE													
1.6 THP 150	Petrol	110	07/08-07/11	5FX (EP6DT)									
Engine	Information				A10	A20	A40	A50	A70	C10 - C30	C20	E01	
All engines	x 4, COIL ON PLUG									1.970.475	C10		
ENGINE													
1.6 VTi 120	Petrol	88	07/08-07/11	5FW (EP6)									
Engine	Information				A10	A20	A40	A50	A70	C10 - C30	C20	E01	
All engines	x 4, COIL ON PLUG									1.970.475	C10		
ENGINE													
2.0 16V	Petrol	100	11/04-07/07	RFN (EW10J4)									
Engine	Information				A10	A20	A40	A50	A70	C10 - C30	C20	E01	
All engines	x 4, COIL ON PLUG									1.970.408	C10		
ENGINE													
2.0 16V	Petrol	103	11/04-07/11	RFJ (EW10A)									
Engine	Information				A10	A20	A40	A50	A70	C10 - C30	C20	E01	
All engines										1.970.476	C10		
All engines	x 1, COIL ON PLUG									1.970.476	C10		
ENGINE													
2.0 16V	Petrol	105	09/06-07/09	RFJ (EW10A)									
Engine	Information				A10	A20	A40	A50	A70	C10 - C30	C20	E01	
All engines	x 1, COIL ON PLUG									1.970.476	C10		
ENGINE													
2.0 16V	Petrol	130	11/04-12/10	RFK (EW10J4S)									
Engine	Information				A10	A20	A40	A50	A70	C10 - C30	C20	E01	
All engines	x 4, COIL ON PLUG									1.970.509	C10		
ENGINE													
2.0 VTR	Petrol	103	10/06-12/07	RFJ (EW10A)									
Engine	Information				A10	A20	A40	A50	A70	C10 - C30	C20	E01	
All engines	x 1, COIL ON PLUG									1.970.476	C10		
C4 II													
ENGINE													
1.2 THP 110	Petrol	81	02/15-12/17	8D4HH, HNZ (EB2DT)									
Engine	Information				A10	A20	A40	A50	A70	C10 - C30	C20	E01	
All engines	x 3, COIL ON PLUG									1.970.620	C10		
ENGINE													
1.2 THP 130	Petrol	96	04/14->	HNY (EB2DTS)									
Engine	Information				A10	A20	A40	A50	A70	C10 - C30	C20	E01	
All engines	x 3, COIL ON PLUG									1.970.620	C10		
ENGINE													
1.4 16V	Petrol	70	11/09->	EP3C									
Engine	Information				A10	A20	A40	A50	A70	C10 - C30	C20	E01	
All engines	Qty: 4									1.970.475	C10		
ENGINE													
1.4 VTi 95	Petrol	70	11/09->	8FP (EP3C)									
Engine	Information				A10	A20	A40	A50	A70	C10 - C30	C20	E01	
All engines	x 4, COIL ON PLUG									1.970.475	C10		

A10 CONDENSER	A20 CONTACT SET	A40 DISTRIBUTOR CAP	A50 ROTOR	A70 PICK-UP
C10 COIL	C20 IGNITION MODULE	C30 ELECTRONIC IGNITION KIT	E01 IGNITION CABLE SET	

The present application list is a brief version. For the detailed information about the possibility of installation on a specific vehicle, please refer to our web-catalogue <http://catalogo.facet.eu/>

				FUNCTIONS ON THE VEHICLE								
Vehicle	alim.	kW	Date	Engine	A10	A20	A40	A50	A70	C10 - C30	C20	E01
				ENGINE								
1.6 16V	Petrol	147	10/10->	EP6FDTX								
Engine		Information			A10	A20	A40	A50	A70	C10 - C30	C20	E01
All engines		Qty: 4								1.970.475	C10	
				ENGINE								
1.6 Flex	Petrol/ Ethanol	81	11/09->	NFX (TU5JP4)								
Engine		Information			A10	A20	A40	A50	A70	C10 - C30	C20	E01
All engines										1.970.407	C10	
				ENGINE								
1.6 THP 155	Petrol	115	11/09-12/16	5FV (EP6CDT)								
Engine		Information			A10	A20	A40	A50	A70	C10 - C30	C20	E01
All engines		x 4, COIL ON PLUG								1.970.475	C10	
				ENGINE								
1.6 VTi 120	Petrol	88	11/09-12/16	5FS (EP6C)								
Engine		Information			A10	A20	A40	A50	A70	C10 - C30	C20	E01
All engines		x 4, COIL ON PLUG								1.970.475	C10	
				ENGINE								
1.6 VTi 120 LPG	Petrol/ Liquified Petroleum Gas (LPG)	88	09/11->	5FS (EP6C)								
Engine		Information			A10	A20	A40	A50	A70	C10 - C30	C20	E01
All engines		x 4, COIL ON PLUG								1.970.475	C10	
				ENGINE								
2.0 Flex	Petrol/ Ethanol	103	11/09->	RFJ (EW10A)								
Engine		Information			A10	A20	A40	A50	A70	C10 - C30	C20	E01
All engines										1.970.476	C10	
				C4 III								
				ENGINE								
1.2 PureTech 110	Petrol	81	04/18->	HNX (EB2DTS)								
Engine		Information			A10	A20	A40	A50	A70	C10 - C30	C20	E01
All engines		x 3, COIL ON PLUG								1.970.620	C10	
				ENGINE								
1.6 THP 165	Petrol	121	04/18->	5GZ (EP6FDT)								
Engine		Information			A10	A20	A40	A50	A70	C10 - C30	C20	E01
All engines		x 4, COIL ON PLUG								1.970.475	C10	
				ENGINE								
PureTech 130	Petrol	96	05/19->	HNY (EB2DTS)								
Engine		Information			A10	A20	A40	A50	A70	C10 - C30	C20	E01
All engines		x 3, COIL ON PLUG								1.970.620	C10	
				C4 PICASSO I								
				ENGINE								
1.6 16V	Petrol	110	07/08-08/13	5FX (EP6DT)								
Engine		Information			A10	A20	A40	A50	A70	C10 - C30	C20	E01
All engines		x 4, COIL ON PLUG								1.970.475	C10	
				ENGINE								
1.6 THP 140	Petrol	103	07/08-08/13	5FT (EP6DT)								
Engine		Information			A10	A20	A40	A50	A70	C10 - C30	C20	E01
All engines		x 4, COIL ON PLUG								1.970.475	C10	
				ENGINE								
1.6 THP 155	Petrol	115	09/10-08/13	5FV (EP6CDT)								
Engine		Information			A10	A20	A40	A50	A70	C10 - C30	C20	E01
All engines		x 4, COIL ON PLUG								1.970.475	C10	
				ENGINE								
1.6 VTi 120	Petrol	88	07/08-08/13	5FW (EP6)								
Engine		Information			A10	A20	A40	A50	A70	C10 - C30	C20	E01
All engines		x 4, COIL ON PLUG								1.970.475	C10	

A10 CONDENSER	A20 CONTACT SET	A40 DISTRIBUTOR CAP	A50 ROTOR	A70 PICK-UP
C10 COIL	C20 IGNITION MODULE	C30 ELECTRONIC IGNITION KIT	E01 IGNITION CABLE SET	

Vehicle	alim.	kW	Date	Engine	FUNCTIONS ON THE VEHICLE									
					A10	A20	A40	A50	A70	C10 - C30	C20	E01		
ENGINE														
1.8 Bifuel	Petrol/ Ethanol	92	01/09-10/12	6FY (EW7A)										
Engine	Information				A10	A20	A40	A50	A70	C10 - C30	C20	E01		
All engines	x 1, COIL ON PLUG									1.970.476	C10			
ENGINE														
1.8 i 16V	Petrol	92	02/07-12/11	6FY (EW7A)										
Engine	Information				A10	A20	A40	A50	A70	C10 - C30	C20	E01		
All engines	x 1, COIL ON PLUG									1.970.476	C10			
ENGINE														
2.0 i 16V	Petrol	103	09/07-08/13	RFJ (EW10A)										
Engine	Information				A10	A20	A40	A50	A70	C10 - C30	C20	E01		
All engines	x 1, COIL ON PLUG									1.970.476	C10			
C4 PICASSO II														
ENGINE														
1.2 THP 130	Petrol	96	04/14->	HNY (EB2DTS)										
Engine	Information				A10	A20	A40	A50	A70	C10 - C30	C20	E01		
All engines	x 3, COIL ON PLUG									1.970.620	C10			
ENGINE														
1.6 THP 150	Petrol	110	09/14->	5FX (EP6DT)										
Engine	Information				A10	A20	A40	A50	A70	C10 - C30	C20	E01		
All engines	x 4, COIL ON PLUG									1.970.475	C10			
ENGINE														
1.6 THP 155	Petrol	115	02/13->	5FV (EP6CDT)										
Engine	Information				A10	A20	A40	A50	A70	C10 - C30	C20	E01		
All engines	x 4, COIL ON PLUG									1.970.475	C10			
ENGINE														
1.6 THP 165	Petrol	121	07/14->	5GZ (EP6FDT)										
Engine	Information				A10	A20	A40	A50	A70	C10 - C30	C20	E01		
All engines	x 4, COIL ON PLUG									1.970.475	C10			
ENGINE														
1.6 VTi 120	Petrol	88	02/13->	5FS (EP6C)										
Engine	Information				A10	A20	A40	A50	A70	C10 - C30	C20	E01		
All engines	x 4, COIL ON PLUG									1.970.475	C10			
ENGINE														
THP 155	Petrol	115	02/13->	5FV (EP6CDT)										
Engine	Information				A10	A20	A40	A50	A70	C10 - C30	C20	E01		
All engines	x 4, COIL ON PLUG									1.970.475	C10			
ENGINE														
VTi 120	Petrol	88	02/13->	5FS (EP6C)										
Engine	Information				A10	A20	A40	A50	A70	C10 - C30	C20	E01		
All engines	x 4, COIL ON PLUG									1.970.475	C10			
C5 AIRCROSS														
ENGINE														
1.6 Hybrid	Petrol/ Electric	133	04/20->	5GF (EP6FADTXD)										
Engine	Information				A10	A20	A40	A50	A70	C10 - C30	C20	E01		
All engines	Emission Standard:Euro 6.2, x 4, COIL ON PLUG									1.970.475	C10			
ENGINE														
1.6 Hybrid	Petrol/ Electric	165	04/20->	5GF (EP6FADTXD)										
Engine	Information				A10	A20	A40	A50	A70	C10 - C30	C20	E01		
All engines	Emission Standard:Euro 6.2, x 4, COIL ON PLUG									1.970.475	C10			
ENGINE														
1.6 PureTech 180	Petrol	133	11/18->	5GF (EP6FADTXD)										
Engine	Information				A10	A20	A40	A50	A70	C10 - C30	C20	E01		
All engines	x 4, COIL ON PLUG									1.970.475	C10			
ENGINE														
1.6 THP 150	Petrol	110	09/19->	5GX (EP6FTMD)										
Engine	Information				A10	A20	A40	A50	A70	C10 - C30	C20	E01		
All engines	x 4, COIL ON PLUG									1.970.475	C10			

A10 CONDENSER	A20 CONTACT SET	A40 DISTRIBUTOR CAP	A50 ROTOR	A70 PICK-UP
C10 COIL	C20 IGNITION MODULE	C30 ELECTRONIC IGNITION KIT	E01 IGNITION CABLE SET	









The present application list is a brief version. For the detailed information about the possibility of installation on a specific vehicle, please refer to our web-catalogue <http://catalogo.facet.eu/>

FUNCTIONS ON THE VEHICLE

Vehicle	alim.	kW	Date	Engine								
C5 I												
1.6 THP 165	Petrol	121	05/19->	ENGINE 5GY (EP6FDTM)								
Engine	Information			A10	A20	A40	A50	A70	C10 - C30	C20	E01	
All engines	x 4, COIL ON PLUG								1.970.475	C10		
1.8	Petrol	85	09/04-08/05	ENGINE 6FZ (EW7J4)								
Engine	Information			A10	A20	A40	A50	A70	C10 - C30	C20	E01	
All engines	x 4, COIL ON PLUG								1.970.408	C10		
1.8 16V	Petrol	85	03/01->	ENGINE 6FZ (EW7J4)								
Engine	Information			A10	A20	A40	A50	A70	C10 - C30	C20	E01	
All engines	x 4, COIL ON PLUG								1.970.408	C10		
1.8 16V	Petrol	92	09/05->	ENGINE 6FY (EW7A)								
Engine	Information			A10	A20	A40	A50	A70	C10 - C30	C20	E01	
All engines	x 1, COIL ON PLUG								1.970.476	C10		
2.0	Petrol	103	11/04-01/08	ENGINE RFJ (EW10A)								
Engine	Information			A10	A20	A40	A50	A70	C10 - C30	C20	E01	
All engines	x 1, COIL ON PLUG								1.970.476	C10		
2.0 16V	Petrol	100	03/01-08/04	ENGINE RFN (EW10J4)								
Engine	Information			A10	A20	A40	A50	A70	C10 - C30	C20	E01	
All engines	x 4, COIL ON PLUG								1.970.408	C10		
2.0 16V	Petrol	103	09/04->	ENGINE RFJ (EW10A)								
Engine	Information			A10	A20	A40	A50	A70	C10 - C30	C20	E01	
All engines	x 1, COIL ON PLUG								1.970.476	C10		
C5 II												
1.6 THP 150	Petrol	110	04/09->	ENGINE 5FN (EP6CDT)								
Engine	Information			A10	A20	A40	A50	A70	C10 - C30	C20	E01	
All engines	x 4, COIL ON PLUG								1.970.475	C10		
1.6 THP 155	Petrol	115	04/09->	ENGINE 5FV (EP6CDT)								
Engine	Information			A10	A20	A40	A50	A70	C10 - C30	C20	E01	
All engines	x 4, COIL ON PLUG								1.970.475	C10		
1.6 VTi 120	Petrol	88	07/10->	ENGINE 5FS (EP6C)								
Engine	Information			A10	A20	A40	A50	A70	C10 - C30	C20	E01	
All engines	x 4, COIL ON PLUG								1.970.475	C10		
1.8 16V	Petrol	92	02/08->	ENGINE 6FY (EW7A)								
Engine	Information			A10	A20	A40	A50	A70	C10 - C30	C20	E01	
All engines	x 1, COIL ON PLUG								1.970.476	C10		
2.0 16V	Petrol	103	02/08->	ENGINE RFJ (EW10A)								
Engine	Information			A10	A20	A40	A50	A70	C10 - C30	C20	E01	
All engines	x 1, COIL ON PLUG								1.970.476	C10		
2.0 16V BioFlex	Petrol/ Ethanol	103	02/08->	ENGINE RFJ (EW10A)								
Engine	Information			A10	A20	A40	A50	A70	C10 - C30	C20	E01	
All engines	x 1, COIL ON PLUG								1.970.476	C10		
C8												
2.0	Petrol	100	07/02->	ENGINE RFN (EW10J4)								
Engine	Information			A10	A20	A40	A50	A70	C10 - C30	C20	E01	
All engines	x 4, COIL ON PLUG								1.970.408	C10		

A10 CONDENSER	A20 CONTACT SET	A40 DISTRIBUTOR CAP	A50 ROTOR	A70 PICK-UP
C10 COIL	C20 IGNITION MODULE	C30 ELECTRONIC IGNITION KIT	E01 IGNITION CABLE SET	

Vehicle	alim.	kW	Date	Engine	FUNCTIONS ON THE VEHICLE									
					A10	A20	A40	A50	A70	C10 - C30	C20	E01		
ENGINE														
2.0	Petrol	103	06/04-12/11	RFJ (EW10A)										
Engine	Information				A10	A20	A40	A50	A70	C10 - C30	C20	E01		
All engines	x 1, COIL ON PLUG									1.970.476	C10			
ENGINE														
2.0 16V	Petrol	103	09/05->	RFJ (EW10A)										
Engine	Information				A10	A20	A40	A50	A70	C10 - C30	C20	E01		
All engines	x 1, COIL ON PLUG									1.970.476	C10			
ENGINE														
2.0 16V	Petrol	104	09/05->	RFJ (EW10A)										
Engine	Information				A10	A20	A40	A50	A70	C10 - C30	C20	E01		
All engines										1.970.476	C10			
ENGINE														
2.2	Petrol	116	07/02->	3FZ (EW12J4)										
Engine	Information				A10	A20	A40	A50	A70	C10 - C30	C20	E01		
All engines	x 4, COIL ON PLUG									1.970.509	C10			
C-CROSSER														
ENGINE														
2.0	Petrol	108	11/10->	4B11										
Engine	Information				A10	A20	A40	A50	A70	C10 - C30	C20	E01		
All engines	x 4, COIL ON PLUG									1.970.497	C10			
ENGINE														
2.0 Trazione integrale	Petrol	108	11/10->	4B11										
Engine	Information				A10	A20	A40	A50	A70	C10 - C30	C20	E01		
All engines	x 4, COIL ON PLUG									1.970.497	C10			
ENGINE														
2.4 16V	Petrol	125	08/08->	SFZ (4B12 MMC)										
Engine	Information				A10	A20	A40	A50	A70	C10 - C30	C20	E01		
All engines	x 4, COIL ON PLUG									1.970.497	C10			
C-CROSSER ENTERPRISE														
ENGINE														
2.4 16V	Petrol	125	01/09->	4B12										
Engine	Information				A10	A20	A40	A50	A70	C10 - C30	C20	E01		
All engines	x 4, COIL ON PLUG									1.970.497	C10			
C-ELYSEE														
ENGINE														
1.2 PureTech 82	Petrol	61	02/18->	HMR (EB2FA)										
Engine	Information				A10	A20	A40	A50	A70	C10 - C30	C20	E01		
All engines	x 3, COIL ON PLUG									1.970.609	C10			
ENGINE														
1.2 VTi 72	Petrol	53	11/12->	HMY (EB2M)										
Engine	Information				A10	A20	A40	A50	A70	C10 - C30	C20	E01		
All engines	x 3, COIL ON PLUG									1.970.609	C10			
ENGINE														
1.2 VTi 82	Petrol	60	12/14->	177L, EB2F, HMZ (EB2F)										
Engine	Information				A10	A20	A40	A50	A70	C10 - C30	C20	E01		
Eng. 177L, HMZ (EB2F)	x 3, COIL ON PLUG									1.970.609	C10			
Eng. EB2F	Qty: 3									1.970.609	C10			
CX I														
ENGINE														
2000	Petrol	78	06/79-08/85	829 A5										
Engine	Information				A10	A20	A40	A50	A70	C10 - C30	C20	E01		
All engines	version Ducellier						1.315.058	1.415.094						
ENGINE														
2400	Petrol	85	08/76-06/80	M23-623										
Engine	Information				A10	A20	A40	A50	A70	C10 - C30	C20	E01		
All engines	version Ducellier				1.115.034		1.315.059	1.415.091						
ENGINE														
2400 GTI	Petrol	94	06/77-06/83	M23-622										
Engine	Information				A10	A20	A40	A50	A70	C10 - C30	C20	E01		
All engines	version Ducellier						1.315.059	1.415.083R						
A10	CONDENSER		A20	CONTACT SET		A40	DISTRIBUTOR CAP		A50	ROTOR		A70	PICK-UP	
C10	COIL		C20	IGNITION MODULE		C30	ELECTRONIC IGNITION KIT		E01	IGNITION CABLE SET				

				FUNCTIONS ON THE VEHICLE								
Vehicle	alim.	kW	Date	Engine								
				ENGINE								
2400 GTi	Petrol	96	06/77-06/82	M23-622								
				ENGINE								
Engine		Information			A10	A20	A40	A50	A70	C10 - C30	C20	E01
All engines		version Ducellier					1.315.059	1.415.083R				
				ENGINE								
CX II												
20 RE	Petrol	78	08/85-12/92	829 A5								
				ENGINE								
Engine		Information			A10	A20	A40	A50	A70	C10 - C30	C20	E01
All engines		version Ducellier					1.315.058	1.415.094				
All engines											1.965.005	
				ENGINE								
22 TRS	Petrol	83	07/85-12/92	J6T A500								
				ENGINE								
Engine		Information			A10	A20	A40	A50	A70	C10 - C30	C20	E01
All engines		version Ducellier					1.315.058	1.415.094				
All engines											1.965.005	
				ENGINE								
DS3												
1.2 THP 110	Petrol	81	10/14-07/15	HNZ (EB2DT)								
				ENGINE								
Engine		Information			A10	A20	A40	A50	A70	C10 - C30	C20	E01
All engines		x 3, COIL ON PLUG								1.970.620	C10	
				ENGINE								
1.2 VTi 82	Petrol	60	01/13-07/15	177L, HMZ (EB2F)								
				ENGINE								
Engine		Information			A10	A20	A40	A50	A70	C10 - C30	C20	E01
All engines		x 3, COIL ON PLUG								1.970.609	C10	
				ENGINE								
1.4 VTi 95	Petrol	70	04/10-07/15	8FR (EP3C)								
				ENGINE								
Engine		Information			A10	A20	A40	A50	A70	C10 - C30	C20	E01
All engines		x 4, COIL ON PLUG								1.970.475	C10	
				ENGINE								
1.4 VTi 95 LPG	Petrol/ Liquified Petroleum Gas (LPG)	70	08/12-07/15	8FR (EP3C)								
				ENGINE								
Engine		Information			A10	A20	A40	A50	A70	C10 - C30	C20	E01
All engines		x 4, COIL ON PLUG								1.970.475	C10	
				ENGINE								
1.4 VTi 98	Petrol	72	11/09-07/15	8FR (EP3C)								
				ENGINE								
Engine		Information			A10	A20	A40	A50	A70	C10 - C30	C20	E01
All engines		x 4, COIL ON PLUG								1.970.475	C10	
				ENGINE								
1.6	Petrol	153	02/11-07/15	5GM (EP6FTX)								
				ENGINE								
Engine		Information			A10	A20	A40	A50	A70	C10 - C30	C20	E01
All engines		Qty: 4								1.970.475	C10	
				ENGINE								
1.6 Racing	Petrol	149	02/11-07/15	5FF (EP6DTS)								
				ENGINE								
Engine		Information			A10	A20	A40	A50	A70	C10 - C30	C20	E01
All engines		x 4, COIL ON PLUG								1.970.475	C10	
				ENGINE								
1.6 Racing	Petrol	152	02/11-07/15	5FD (EP6DTS)								
				ENGINE								
Engine		Information			A10	A20	A40	A50	A70	C10 - C30	C20	E01
All engines		x 4, COIL ON PLUG								1.970.475	C10	
				ENGINE								
1.6 THP 150	Petrol	110	01/10-07/15	5FN (EP6CDT), 5FX (EP6DT)								
				ENGINE								
Engine		Information			A10	A20	A40	A50	A70	C10 - C30	C20	E01
All engines		x 4, COIL ON PLUG								1.970.475	C10	
				ENGINE								
1.6 THP 155	Petrol	115	04/10-07/15	5FR (EP6DT), 5FV (EP6CDT)								
				ENGINE								
Engine		Information			A10	A20	A40	A50	A70	C10 - C30	C20	E01
All engines		x 4, COIL ON PLUG								1.970.475	C10	

A10 CONDENSER	A20 CONTACT SET	A40 DISTRIBUTOR CAP	A50 ROTOR	A70 PICK-UP
C10 COIL	C20 IGNITION MODULE	C30 ELECTRONIC IGNITION KIT	E01 IGNITION CABLE SET	

Vehicle	alim.	kW	Date	Engine	FUNCTIONS ON THE VEHICLE									
					A10	A20	A40	A50	A70	C10 - C30	C20	E01		
ENGINE														
1.6 THP 165	Petrol	121	10/14-07/15	5GZ (EP6FDT)										
Engine	Information				A10	A20	A40	A50	A70	C10 - C30	C20	E01		
All engines	x 4, COIL ON PLUG									1.970.475	C10			
ENGINE														
1.6 VTi 120	Petrol	88	04/10-07/15	5FS (EP6C)										
Engine	Information				A10	A20	A40	A50	A70	C10 - C30	C20	E01		
All engines	x 4, COIL ON PLUG									1.970.475	C10			
DS4														
ENGINE														
1.2 THP 130	Petrol	96	07/14-07/15	HNY (EB2DTS)										
Engine	Information				A10	A20	A40	A50	A70	C10 - C30	C20	E01		
All engines	x 3, COIL ON PLUG									1.970.620	C10			
ENGINE														
1.6 THP 150	Petrol	110	04/11-07/15	5FE (EP6CDTMD)										
Engine	Information				A10	A20	A40	A50	A70	C10 - C30	C20	E01		
All engines	x 4, COIL ON PLUG									1.970.475	C10			
ENGINE														
1.6 THP 155	Petrol	115	04/11-07/15	5FV (EP6CDT)										
Engine	Information				A10	A20	A40	A50	A70	C10 - C30	C20	E01		
All engines	x 4, COIL ON PLUG									1.970.475	C10			
ENGINE														
1.6 THP 160	Petrol	120	04/12-07/15	5FM (EP6CDTM)										
Engine	Information				A10	A20	A40	A50	A70	C10 - C30	C20	E01		
All engines	x 4, COIL ON PLUG									1.970.475	C10			
ENGINE														
1.6 THP 165	Petrol	121	01/12-07/15	5FM (EP6CDTM), 5FM (EP6DT), 5GZ (EP6FDT)										
Engine	Information				A10	A20	A40	A50	A70	C10 - C30	C20	E01		
Eng. 5FM (EP6CDTM), 5GZ (EP6FDT)	x 4, COIL ON PLUG									1.970.475	C10			
Eng. 5FM (EP6DT)	Qty: 4									1.970.475	C10			
ENGINE														
1.6 THP 200	Petrol	147	04/11-07/15	5FU (EP6DTX)										
Engine	Information				A10	A20	A40	A50	A70	C10 - C30	C20	E01		
All engines	x 4, COIL ON PLUG									1.970.475	C10			
ENGINE														
1.6 THP 210	Petrol	155	07/15-07/15	5GM (EP6FDTX)										
Engine	Information				A10	A20	A40	A50	A70	C10 - C30	C20	E01		
All engines	Qty: 4									1.970.475	C10			
ENGINE														
1.6 VTi 120	Petrol	88	04/11-07/15	5FS (EP6C)										
Engine	Information				A10	A20	A40	A50	A70	C10 - C30	C20	E01		
All engines	x 4, COIL ON PLUG									1.970.475	C10			
DS5														
ENGINE														
1.6 THP 150	Petrol	110	11/11-07/15	5FE (EP6CDTMD)										
Engine	Information				A10	A20	A40	A50	A70	C10 - C30	C20	E01		
All engines	x 4, COIL ON PLUG									1.970.475	C10			
ENGINE														
1.6 THP 155	Petrol	115	11/11-07/15	5FV (EP6CDT)										
Engine	Information				A10	A20	A40	A50	A70	C10 - C30	C20	E01		
All engines	x 4, COIL ON PLUG									1.970.475	C10			
ENGINE														
1.6 THP 165	Petrol	121	01/12-07/15	5FM (EP6CDTM), 5FM (EP6DT), 5GZ (EP6FDT)										
Engine	Information				A10	A20	A40	A50	A70	C10 - C30	C20	E01		
All engines	x 4, COIL ON PLUG									1.970.475	C10			

A10	CONDENSER	A20	CONTACT SET	A40	DISTRIBUTOR CAP	A50	ROTOR	A70	PICK-UP
C10	COIL	C20	IGNITION MODULE	C30	ELECTRONIC IGNITION KIT	E01	IGNITION CABLE SET		

The present application list is a brief version. For the detailed information about the possibility of installation on a specific vehicle, please refer to our web-catalogue <http://catalogo.facet.eu/>

					FUNCTIONS ON THE VEHICLE							
Vehicle	alim.	kW	Date	Engine	A10	A20	A40	A50	A70	C10 - C30	C20	E01
ENGINE												
1.6 THP 165 Hybrid	Petrol/ Electric	121	06/12-07/15	5GZ (EP6FDT)								
Engine	Information				A10	A20	A40	A50	A70	C10 - C30	C20	E01
All engines	x 4, COIL ON PLUG									1.970.475	C10	
ENGINE												
1.6 THP 200	Petrol	147	11/11-07/15	5FU (EP6DTX)								
Engine	Information				A10	A20	A40	A50	A70	C10 - C30	C20	E01
All engines	x 4, COIL ON PLUG									1.970.475	C10	
ENGINE												
1.6 THP 210	Petrol	155	11/14-07/15	5GM (EP6FTX)								
Engine	Information				A10	A20	A40	A50	A70	C10 - C30	C20	E01
All engines	Qty: 4									1.970.475	C10	
DYANE												
4	Petrol	17	04/68-07/75	A79/1 (AYA2)								
Engine	Information				A10	A20	A40	A50	A70	C10 - C30	C20	E01
All engines	version Ducellier					1.215.064						
EVASION												
1.8	Petrol	73	05/97-07/02	LFZ (XU7JP)								
Engine	Information				A10	A20	A40	A50	A70	C10 - C30	C20	E01
All engines												1.500.674
ENGINE												
1.8	Petrol	76	02/96-12/96	LFZ (XU7JP)								
Engine	Information				A10	A20	A40	A50	A70	C10 - C30	C20	E01
All engines	x 1, D.I.S., connector type, saw teeth									1.970.188	C10	
ENGINE												
2.0	Petrol	89	06/94-07/02	RFU (XU10J2/C)								
Engine	Information				A10	A20	A40	A50	A70	C10 - C30	C20	E01
All engines	x 1, D.I.S., connector type, saw teeth									1.970.188	C10	
All engines												1.500.494
ENGINE												
2.0 16V	Petrol	100	05/00-07/02	RFN (EW10J4)								
Engine	Information				A10	A20	A40	A50	A70	C10 - C30	C20	E01
All engines	x 4, COIL ON PLUG									1.970.408	C10	
ENGINE												
2.0 Turbo C.T.	Petrol	108	06/94-07/02	RGX (XU10J2TE)								
Engine	Information				A10	A20	A40	A50	A70	C10 - C30	C20	E01
All engines	x 1, D.I.S., connector type, saw teeth									1.970.188	C10	
All engines												1.500.494
GRAND C4 SPACETOURER												
ENGINE												
1.6 PureTech 180	Petrol	133	04/18->	5GF (EP6FADTXD)								
Engine	Information				A10	A20	A40	A50	A70	C10 - C30	C20	E01
All engines	x 4, COIL ON PLUG									1.970.475	C10	
ENGINE												
1.6 THP 165	Petrol	110	04/18->	5GX (EP6FTMD)								
Engine	Information				A10	A20	A40	A50	A70	C10 - C30	C20	E01
All engines	x 4, COIL ON PLUG									1.970.475	C10	
ENGINE												
1.6 THP 165	Petrol	121	04/18->	5GZ (EP6FDT)								
Engine	Information				A10	A20	A40	A50	A70	C10 - C30	C20	E01
All engines	x 4, COIL ON PLUG									1.970.475	C10	
ENGINE												
PureTech 130	Petrol	96	05/19->	HNY (EB2DTS)								
Engine	Information				A10	A20	A40	A50	A70	C10 - C30	C20	E01
All engines	x 3, COIL ON PLUG									1.970.620	C10	

A10 CONDENSER	A20 CONTACT SET	A40 DISTRIBUTOR CAP	A50 ROTOR	A70 PICK-UP
C10 COIL	C20 IGNITION MODULE	C30 ELECTRONIC IGNITION KIT	E01 IGNITION CABLE SET	

Vehicle	alim.	kW	Date	Engine	FUNCTIONS ON THE VEHICLE							
					A10	A20	A40	A50	A70	C10 - C30	C20	E01

GS				
				ENGINE
A 1.3	Petrol	48	07/78-07/86	G13/625

Engine	Information	A10	A20	A40	A50	A70	C10 - C30	C20	E01
All engines	version Ducellier			1.315.058	1.415.094				
All engines								1.965.005	

JUMPER I				
				ENGINE
2.0	Petrol	79	02/94-02/02	XU102C

Engine	Information	A10	A20	A40	A50	A70	C10 - C30	C20	E01
All engines	version Ducellier			1.315.074	1.415.102R	1.915.019			
All engines	Kit, version Ducellier			1.315.087					

ENGINE				
2.0	Petrol	80	02/94-04/02	RFW (XU10J2U)

Engine	Information	A10	A20	A40	A50	A70	C10 - C30	C20	E01
All engines							1.970.188	C10	1.500.674

ENGINE				
2.0 4x4	Petrol	80	08/96-04/02	RFW (XU10J2U)

Engine	Information	A10	A20	A40	A50	A70	C10 - C30	C20	E01
All engines							1.970.188	C10	1.500.674

JUMPER II				
				ENGINE
2.0	Petrol	81	04/02->	XU10J2

Engine	Information	A10	A20	A40	A50	A70	C10 - C30	C20	E01
All engines	x 1, D.I.S., connector type, saw teeth						1.970.188	C10	
All engines									1.500.674

ENGINE				
2.0 bivalent	Petrol/ Compressed Natural Gas (CNG)	81	02/03->	XU10J2

Engine	Information	A10	A20	A40	A50	A70	C10 - C30	C20	E01
All engines	x 1, D.I.S., connector type, saw teeth						1.970.188	C10	
All engines									1.500.674

JUMPY I				
				ENGINE
1.6	Petrol	58	10/95-08/00	1580 SPI, 220 A2.000

Engine	Information	A10	A20	A40	A50	A70	C10 - C30	C20	E01
All engines	x 1, D.I.S., connector type, saw teeth						1.970.168	C10	
All engines									1.500.655

ENGINE				
1.6	Petrol	59	10/95-08/00	220 A2.000

Engine	Information	A10	A20	A40	A50	A70	C10 - C30	C20	E01
All engines							1.970.168	C10	1.500.655

ENGINE				
1.6 i	Petrol	58	10/95-08/00	1580 SPI, 220 A2.000

Engine	Information	A10	A20	A40	A50	A70	C10 - C30	C20	E01
All engines	x 1, D.I.S., connector type, saw teeth						1.970.168	C10	
All engines									1.500.655

ENGINE				
2.0	Petrol	100	04/00-12/06	RFN (EW10J4)

Engine	Information	A10	A20	A40	A50	A70	C10 - C30	C20	E01
All engines							1.970.408	C10	
All engines	x 4, COIL ON PLUG						1.970.408	C10	

ENGINE				
2.0 i 16V	Petrol	102	03/00-10/06	RFN (EW10J4)

Engine	Information	A10	A20	A40	A50	A70	C10 - C30	C20	E01
All engines	x 4, COIL ON PLUG						1.970.408	C10	

A10	CONDENSER	A20	CONTACT SET	A40	DISTRIBUTOR CAP	A50	ROTOR	A70	PICK-UP
C10	COIL	C20	IGNITION MODULE	C30	ELECTRONIC IGNITION KIT	E01	IGNITION CABLE SET		

The present application list is a brief version. For the detailed information about the possibility of installation on a specific vehicle, please refer to our web-catalogue <http://catalogo.facet.eu/>

					FUNCTIONS ON THE VEHICLE							
Vehicle	alim.	kW	Date	Engine								
JUMPY II												
2.0i	Petrol	103	01/07-03/16	ENGINE RFH (EW10A), RFJ (EW10A)								
Engine					A10	A20	A40	A50	A70	C10 - C30	C20	E01
All engines										1.970.476	C10	
LNA												
1.1	Petrol	37	07/82-04/85	ENGINE 109/5E								
Engine					A10	A20	A40	A50	A70	C10 - C30	C20	E01
All engines							1.306.124	1.406.056R				
All engines							1.315.058	1.415.094				
All engines											1.965.005	
MEHARI												
0.6	Petrol	19	05/68-10/79	ENGINE M28/1 (AK2)								
Engine					A10	A20	A40	A50	A70	C10 - C30	C20	E01
All engines						1.215.064						
NEMO												
1.4	Petrol	54	02/08->	ENGINE KFT (TU3A), KFV (TU3A)								
Engine					A10	A20	A40	A50	A70	C10 - C30	C20	E01
All engines										1.970.405	C10	
SAXO												
1.0	Petrol	33	10/97-06/03	ENGINE CDZ (TU9M)								
Engine					A10	A20	A40	A50	A70	C10 - C30	C20	E01
All engines										1.970.188	C10	
1.0	Petrol	37	08/99-06/03	ENGINE CDZ (TU9M)								
Engine					A10	A20	A40	A50	A70	C10 - C30	C20	E01
All engines										1.970.188	C10	
1.0 X	Petrol	33	05/96-11/98	ENGINE CDY (TU9M), CDZ (TU9M)								
Engine					A10	A20	A40	A50	A70	C10 - C30	C20	E01
Eng. CDY (TU9M)										1.970.188	C10	
Eng. CDZ (TU9M)												1.501.374
1.0 X	Petrol	37	05/98-06/03	ENGINE CDZ (TU9M)								
Engine					A10	A20	A40	A50	A70	C10 - C30	C20	E01
All engines										1.970.188	C10	
All engines												1.501.374
1.1 BiFuel	Petrol/ Liquified Petro- leum Gas (LPG)	44	07/00-06/03	ENGINE HDZ (TU1M)								
Engine					A10	A20	A40	A50	A70	C10 - C30	C20	E01
All engines										1.970.188	C10	
1.1 X, SX	Petrol	40	05/96-09/03	ENGINE HDZ (TU1M)								
Engine					A10	A20	A40	A50	A70	C10 - C30	C20	E01
All engines										1.970.188	C10	
All engines												1.501.374
1.1 X, SX	Petrol	44	05/96-09/03	ENGINE HDZ (TU1M), HFX (TU1JP)								
Engine					A10	A20	A40	A50	A70	C10 - C30	C20	E01
Eng. HDZ (TU1M)										1.970.188	C10	1.501.374
Eng. HFX (TU1JP)										1.970.405	C10	

A10 CONDENSER	A20 CONTACT SET	A40 DISTRIBUTOR CAP	A50 ROTOR	A70 PICK-UP
C10 COIL	C20 IGNITION MODULE	C30 ELECTRONIC IGNITION KIT	E01 IGNITION CABLE SET	

Vehicle	alim.	kW	Date	Engine	FUNCTIONS ON THE VEHICLE									
					A10	A20	A40	A50	A70	C10 - C30	C20	E01		
ENGINE														
1.4 VTS	Petrol	55	05/96-06/03	KFW (TU3JP), KFX (TU3JP)										
Engine	Information				A10	A20	A40	A50	A70	C10 - C30	C20	E01		
All engines	->year 01/01/98, NOT FOR: (USA), x 1, D.I.S., connector type, saw teeth									1.970.188	C10			
All engines	01/02/98 ->, NOT FOR: (USA), x 4, Electricfil, COIL ON PLUG									1.970.403	C10			
All engines	FOR: (USA), x 1, COIL ON PLUG									1.970.405	C10			
Eng. KFX (TU3JP)	+manual transmission, ->year 04/01/98, +automatic transmission													1.501.374
ENGINE														
1.6	Petrol	66	02/96-06/03	NFZ (TU5JP)										
Engine	Information				A10	A20	A40	A50	A70	C10 - C30	C20	E01		
All engines	->year 01/06/98, x 1, D.I.S., connector type, saw teeth									1.970.188	C10			
All engines	01/07/98 ->, x 4, Electricfil, COIL ON PLUG									1.970.403	C10			
All engines	+manual transmission, ->year 31/05/98, +automatic transmission													1.501.374
ENGINE														
1.6	Petrol	74	02/01-04/04	NFT (TU5JP)										
Engine	Information				A10	A20	A40	A50	A70	C10 - C30	C20	E01		
All engines	+automatic transmission									1.970.188	C10			1.501.374
All engines	x 1, COIL ON PLUG									1.970.405	C10			
ENGINE														
1.6 VTL, VTR	Petrol	65	05/96-06/03	NFZ (TU5JP)										
Engine	Information				A10	A20	A40	A50	A70	C10 - C30	C20	E01		
All engines	->year 01/06/98, x 1, D.I.S., connector type, saw teeth									1.970.188	C10			
All engines	01/07/98 ->, x 4, Electricfil, COIL ON PLUG									1.970.403	C10			
All engines	+manual transmission, ->year 31/05/98, +automatic transmission													1.501.374
ENGINE														
1.6 VTS	Petrol	72	09/00-09/03	NFT (TU5JP)										
Engine	Information				A10	A20	A40	A50	A70	C10 - C30	C20	E01		
All engines	+automatic transmission									1.970.188	C10			1.501.374
All engines	x 1, COIL ON PLUG									1.970.405	C10			
VISA														
ENGINE														
11 E	Petrol	35	09/78-06/88	109K										
Engine	Information				A10	A20	A40	A50	A70	C10 - C30	C20	E01		
All engines	version Bosch						1.306.124	1.406.056R						
All engines	version Duellier						1.315.058	1.415.094						
All engines													1.965.005	
XANTIA I														
ENGINE														
1.6 i	Petrol	65	03/93-03/01	BFZ (XU5JP)										
Engine	Information				A10	A20	A40	A50	A70	C10 - C30	C20	E01		
All engines										1.970.188	C10			1.500.674
ENGINE														
1.8 i	Petrol	66	04/97-04/03	LFX (XU7JB)										
Engine	Information				A10	A20	A40	A50	A70	C10 - C30	C20	E01		
All engines										1.970.188	C10			1.500.674
ENGINE														
1.8 i	Petrol	74	03/93-01/98	LFX (XU7JP)										
Engine	Information				A10	A20	A40	A50	A70	C10 - C30	C20	E01		
All engines										1.970.188	C10			1.500.674
ENGINE														
2.0	Petrol	95	03/93-05/95	RFX XU10J2C/Z L3										
Engine	Information				A10	A20	A40	A50	A70	C10 - C30	C20	E01		
All engines										1.970.188	C10			1.500.494
ENGINE														
2.0 i	Petrol	89	03/93-04/03	RFX (XU10J2C)										
Engine	Information				A10	A20	A40	A50	A70	C10 - C30	C20	E01		
All engines										1.970.188	C10			1.500.494

A10	CONDENSER	A20	CONTACT SET	A40	DISTRIBUTOR CAP	A50	ROTOR	A70	PICK-UP
C10	COIL	C20	IGNITION MODULE	C30	ELECTRONIC IGNITION KIT	E01	IGNITION CABLE SET		

The present application list is a brief version. For the detailed information about the possibility of installation on a specific vehicle, please refer to our web-catalogue <http://catalogo.facet.eu/>

FUNCTIONS ON THE VEHICLE

Vehicle	alim.	kW	Date	Engine	A10	A20	A40	A50	A70	C10 - C30	C20	E01
				ENGINE								
2.0 Turbo	Petrol	108	06/95-04/03	RGX (XU10J2TE)								
Engine	Information				A10	A20	A40	A50	A70	C10 - C30	C20	E01
All engines										1.970.188	C10	1.500.494
				ENGINE								
XANTIA II				ENGINE								
1.6 i SX	Petrol	65	01/98-03/01	BFZ (XU5JP)								
Engine	Information				A10	A20	A40	A50	A70	C10 - C30	C20	E01
All engines										1.970.188	C10	1.500.674
				ENGINE								
1.8 i	Petrol	66	01/98-04/03	LFX (XU7JB)								
Engine	Information				A10	A20	A40	A50	A70	C10 - C30	C20	E01
All engines										1.970.188	C10	1.500.674
				ENGINE								
2.0 i	Petrol	89	01/98-04/03	RFX (XU10J2C)								
Engine	Information				A10	A20	A40	A50	A70	C10 - C30	C20	E01
All engines										1.970.188	C10	1.500.494
				ENGINE								
2.0 Turbo	Petrol	108	01/98-04/03	RGX (XU10J2TE)								
Engine	Information				A10	A20	A40	A50	A70	C10 - C30	C20	E01
All engines										1.970.188	C10	1.500.494
				ENGINE								
XM I				ENGINE								
2.0	Petrol	84	05/89-04/94	--								
Engine	Information				A10	A20	A40	A50	A70	C10 - C30	C20	E01
All engines	version Ducellier						1.315.074	1.415.102R	1.915.019			
All engines	Kit, version Ducellier						1.315.087					
				ENGINE								
2.0 i	Petrol	79	05/89-04/94	RDZ (XU10MZ)								
Engine	Information				A10	A20	A40	A50	A70	C10 - C30	C20	E01
All engines	->year 04/06/90, version Ducellier						1.315.074					
All engines	->year 04/06/90, Kit, version Ducellier						1.315.087					
All engines	->year 02/05/90, version Ducellier							1.415.102R				
All engines	->year 04/06/90									1.970.155	C10	1.965.005
All engines	05/06/90 ->									1.970.188	C10	1.500.494
				ENGINE								
2.0 i	Petrol	89	05/89-06/94	RFZ (XU10J2)								
Engine	Information				A10	A20	A40	A50	A70	C10 - C30	C20	E01
All engines	version Ducellier, +manual transmission, ->year 14/05/90, +automatic transmission						1.315.074	1.415.102R	1.915.019			
All engines	Kit, version Ducellier, +manual transmission, ->year 14/05/90, +automatic transmission						1.315.087					
All engines	+manual transmission, ->year 14/05/90, +automatic transmission									1.970.155	C10	
All engines	+manual transmission, 15/05/90 ->									1.970.188	C10	1.500.494
				ENGINE								
2.0 i Turbo	Petrol	104	09/92-06/94	RGY (XU10J2TE/Z)								
Engine	Information				A10	A20	A40	A50	A70	C10 - C30	C20	E01
All engines										1.970.188	C10	1.500.494
				ENGINE								
2.0 Turbo	Petrol	104	09/92-04/94	RGY (XU10J2TE/Z)								
Engine	Information				A10	A20	A40	A50	A70	C10 - C30	C20	E01
All engines										1.970.188	C10	1.500.494
				ENGINE								
3.0	Petrol	123	05/89-05/94	UFZ (ZPJ/Z)								
Engine	Information				A10	A20	A40	A50	A70	C10 - C30	C20	E01
All engines	version Bosch						1.306.252	1.406.119R				
All engines											1.965.034	
				ENGINE								
3.0 V6	Petrol	123	05/89-06/94	SFZ (ZPJ/Z), UFZ (ZPJ/Z)								
Engine	Information				A10	A20	A40	A50	A70	C10 - C30	C20	E01
All engines	version Bosch						1.306.252	1.406.119R				
All engines											1.965.034	

A10 CONDENSER	A20 CONTACT SET	A40 DISTRIBUTOR CAP	A50 ROTOR	A70 PICK-UP
C10 COIL	C20 IGNITION MODULE	C30 ELECTRONIC IGNITION KIT	E01 IGNITION CABLE SET	

Vehicle	alim.	kW	Date	Engine	FUNCTIONS ON THE VEHICLE									
					A10	A20	A40	A50	A70	C10 - C30	C20	E01		
ENGINE														
3.0 V6 24V	Petrol	147	07/90-06/94	SKZ (ZPJ4/Z), UKZ (ZPJ4/Z)										
Engine					A10	A20	A40	A50	A70	C10 - C30	C20	E01		
All engines							1.306.252	1.406.119R						
All engines											1.965.034			
XM II														
ENGINE														
2.0	Petrol	89	08/94-07/99	XU10J2										
Engine					A10	A20	A40	A50	A70	C10 - C30	C20	E01		
All engines										1.970.188	C10		1.500.494	
ENGINE														
2.0 Turbo	Petrol	108	05/94-10/00	RGX (XU10J2TE), RGY (XU10J2TE/Z)										
Engine					A10	A20	A40	A50	A70	C10 - C30	C20	E01		
All engines										1.970.188	C10		1.500.494	
ENGINE														
3.0 V6	Petrol	123	05/94-10/00	SFZ (ZPJ/Z), UFZ (ZPJ/Z)										
Engine					A10	A20	A40	A50	A70	C10 - C30	C20	E01		
All engines							1.306.252	1.406.119R						
All engines											1.965.034			
ENGINE														
3.0 V6 24V	Petrol	147	05/94-10/00	SKZ (ZPJ4/Z), UKZ (ZPJ4/Z)										
Engine					A10	A20	A40	A50	A70	C10 - C30	C20	E01		
All engines							1.306.252	1.406.119R						
All engines											1.965.034			
XSARA														
ENGINE														
1.4	Petrol	55	05/98-03/05	KFX (TU3JP)										
Engine					A10	A20	A40	A50	A70	C10 - C30	C20	E01		
All engines										1.970.403	C10			
All engines										1.970.405	C10			
ENGINE														
1.4 i	Petrol	55	04/97-08/05	KFW (TU3JP), KFX (TU3JP)										
Engine					A10	A20	A40	A50	A70	C10 - C30	C20	E01		
Eng. KFW (TU3JP)										1.970.188	C10		1.501.374	
All engines										1.970.188	C10			
All engines										1.970.403	C10			
All engines										1.970.405	C10			
ENGINE														
1.4 LPG	Petrol/ Liquified Petro- leum Gas (LPG)	55	05/98-08/00	KFW (TU3JP), KFX (TU3JP)										
Engine					A10	A20	A40	A50	A70	C10 - C30	C20	E01		
Eng. KFW (TU3JP)										1.970.188	C10			
All engines										1.970.403	C10			
ENGINE														
1.6 16V	Petrol	80	09/00-08/05	NFU (TU5JP4)										
Engine					A10	A20	A40	A50	A70	C10 - C30	C20	E01		
All engines										1.970.407	C10			
ENGINE														
1.6 i	Petrol	65	04/97-09/00	NFZ (TU5JP)										
Engine					A10	A20	A40	A50	A70	C10 - C30	C20	E01		
All engines										1.970.188	C10		1.501.374	
All engines										1.970.188	C10			
All engines										1.970.403	C10			
A10	CONDENSER		A20	CONTACT SET		A40	DISTRIBUTOR CAP		A50	ROTOR		A70	PICK-UP	
C10	COIL		C20	IGNITION MODULE		C30	ELECTRONIC IGNITION KIT		E01	IGNITION CABLE SET				

Vehicle	alim.	kW	Date	Engine	FUNCTIONS ON THE VEHICLE								
					A10	A20	A40	A50	A70	C10 - C30	C20	E01	
ENGINE													
1.8 i	Petrol	66	04/97-09/00	LFX (XU7JB)									
Engine	Information				A10	A20	A40	A50	A70	C10 - C30	C20	E01	
All engines	x 1, D.I.S., connector type, saw teeth									1.970.188	C10		
All engines													1.500.674
ENGINE													
1.8 i	Petrol	74	02/98-09/00	LFZ (XU7JP)									
Engine	Information				A10	A20	A40	A50	A70	C10 - C30	C20	E01	
All engines	x 1, D.I.S., connector type, saw teeth									1.970.188	C10		
All engines													1.500.674
ENGINE													
1.8 i Aut.	Petrol	74	04/97-09/00	LFZ (XU7JP)									
Engine	Information				A10	A20	A40	A50	A70	C10 - C30	C20	E01	
All engines	x 1, D.I.S., connector type, saw teeth									1.970.188	C10		
All engines													1.500.674
ENGINE													
2.0 16V	Petrol	100	09/00-08/05	RFN (EW10J4)									
Engine	Information				A10	A20	A40	A50	A70	C10 - C30	C20	E01	
All engines	x 4, COIL ON PLUG									1.970.408	C10		
XSARA PICASSO													
ENGINE													
1.6	Petrol	65	12/99-09/01	NFZ (TU5JP)									
Engine	Information				A10	A20	A40	A50	A70	C10 - C30	C20	E01	
All engines	x 4, Electricfil, COIL ON PLUG									1.970.403	C10		
ENGINE													
1.6	Petrol	67	06/02-08/05	NFZ (TU5JP)									
Engine	Information				A10	A20	A40	A50	A70	C10 - C30	C20	E01	
All engines	x 4, Electricfil, COIL ON PLUG									1.970.403	C10		
ENGINE													
1.6	Petrol	70	12/99-12/10	NFV (TU5JP)									
Engine	Information				A10	A20	A40	A50	A70	C10 - C30	C20	E01	
All engines	x 1, COIL ON PLUG									1.970.405	C10		
ENGINE													
1.6 16V	Petrol	80	03/05->	N6A (TU5JP4), NFU (TU5JP4)									
Engine	Information				A10	A20	A40	A50	A70	C10 - C30	C20	E01	
Eng. N6A (TU5JP4)										1.970.407	C10		
Eng. NFU (TU5JP4)	x 1, COIL ON PLUG									1.970.407	C10		
ENGINE													
1.6 16V	Petrol	81	06/05-09/06	NFU (TU5JP4)									
Engine	Information				A10	A20	A40	A50	A70	C10 - C30	C20	E01	
All engines	x 1, COIL ON PLUG									1.970.407	C10		
ENGINE													
1.6 Chrono	Petrol	74	04/01-10/04	NFV (TU5JP)									
Engine	Information				A10	A20	A40	A50	A70	C10 - C30	C20	E01	
All engines	x 1, COIL ON PLUG									1.970.405	C10		
ENGINE													
1.8 16V	Petrol	85	02/00-08/05	6FZ (EW7J4)									
Engine	Information				A10	A20	A40	A50	A70	C10 - C30	C20	E01	
All engines	x 4, COIL ON PLUG									1.970.408	C10		
ENGINE													
2.0	Petrol	88	02/04-10/04	RFN (EW10J4)									
Engine	Information				A10	A20	A40	A50	A70	C10 - C30	C20	E01	
All engines	x 1, COIL ON PLUG									1.970.408	C10		
ENGINE													
2.0 16V	Petrol	100	01/03-06/12	RFN (EW10J4)									
Engine	Information				A10	A20	A40	A50	A70	C10 - C30	C20	E01	
All engines	x 4, COIL ON PLUG									1.970.408	C10		

A10 CONDENSER	A20 CONTACT SET	A40 DISTRIBUTOR CAP	A50 ROTOR	A70 PICK-UP
C10 COIL	C20 IGNITION MODULE	C30 ELECTRONIC IGNITION KIT	E01 IGNITION CABLE SET	

Vehicle	alim.	kW	Date	Engine	FUNCTIONS ON THE VEHICLE														
					A10	A20	A40	A50	A70	C10 - C30	C20	E01							
ENGINE																			
2.0 16V	Petrol	101	12/99-11/11	RFN (EW10J4)															
ENGINE																			
All engines											1.970.408	C10							
ZX																			
1.1	Petrol	40	03/91-08/93	H1A, H1B															
ENGINE																			
All engines							1.306.241	1.406.056R											
All engines							1.315.074	1.415.102R	1.915.019										
All engines							1.315.087												
All engines								1.430.060											
All engines										1.970.155	C10		1.501.376						
ENGINE																			
1.1	Petrol	44	03/91-06/97	HDZ (TU1M)															
ENGINE																			
All engines							1.306.241	1.406.056R											
All engines							1.315.074	1.415.102R	1.915.019										
All engines							1.315.087												
All engines										1.970.155	C10		1.501.376						
All engines										1.970.189	C10		1.501.374						
ENGINE																			
1.4	Petrol	55	03/91-06/97	KDZ (TU3M/Z)															
ENGINE																			
All engines											1.970.189	C10		1.501.374					
ENGINE																			
1.4 i	Petrol	55	03/91-10/97	KDX (TU3M/Z), KDY (TU3M), KDZ (TU3M/Z), KFX (TU3JP), TU32															
ENGINE																			
Eng. KDY (TU3M), TU32							1.306.241	1.406.056R											
Eng. KDY (TU3M), TU32							1.315.074	1.415.102R	1.915.019										
Eng. KDY (TU3M), TU32							1.315.087												
Eng. KDY (TU3M), TU32										1.970.155	C10		1.501.376						
Eng. KFX (TU3JP)										1.970.188	C10								
Eng. KDX (TU3M/Z), KDZ (TU3M/Z)										1.970.189	C10								
Eng. KDX (TU3M/Z), KDZ (TU3M/Z), KFX (TU3JP)													1.501.374						
ENGINE																			
1.6	Petrol	66	07/94-10/97	BDY (XU5M), BFZ (XU5JP)															
ENGINE																			
All engines											1.970.188	C10		1.500.674					
ENGINE																			
1.6 i	Petrol	65	03/91-10/97	BDY (XU5M), BFZ (XU5JP)															
ENGINE																			
All engines											1.970.188	C10		1.500.674					
ENGINE																			
1.8	Petrol	76	03/91-10/97	LFZ (XU7JP)															
ENGINE																			
All engines											1.970.188	C10		1.500.674					
ENGINE																			
1.8 i	Petrol	74	07/92-10/97	LFZ (XU7JP)															
ENGINE																			
All engines											1.970.188	C10		1.500.674					
ENGINE																			
1.9	Petrol	93	03/91-06/97	D6E (XU9JA)															
ENGINE																			
All engines							1.315.074	1.415.102R											
All engines							1.315.087												
All engines										1.970.155	C10	1.965.005	1.500.491						
All engines										1.970.188	C10		1.500.674						
A10	CONDENSER			A20	CONTACT SET			A40	DISTRIBUTOR CAP			A50	ROTOR			A70	PICK-UP		
C10	COIL			C20	IGNITION MODULE			C30	ELECTRONIC IGNITION KIT			E01	IGNITION CABLE SET						

Vehicle	alim.	kW	Date	Engine	FUNCTIONS ON THE VEHICLE							
					A10	A20	A40	A50	A70	C10 - C30	C20	E01

ENGINE				
1.9	Petrol	96	03/91-09/93	D6E (XU9JA)

Engine	Information	A10	A20	A40	A50	A70	C10 - C30	C20	E01
All engines	version Ducellier, version Export			1.315.074	1.415.102R				
All engines	Kit, version Export, version Ducellier			1.315.087					
All engines	version Export						1.970.155	C10	1.965.005
All engines							1.970.188	C10	1.500.674

ENGINE				
1.9 i	Petrol	88	03/91-06/97	DKZ (XU9JA)

Engine	Information	A10	A20	A40	A50	A70	C10 - C30	C20	E01
All engines	version Ducellier, version Export			1.315.074	1.415.102R				
All engines	Kit, version Export, version Ducellier			1.315.087					
All engines	version Export						1.970.155	C10	1.965.005
All engines							1.970.188	C10	1.500.674

ENGINE				
2.0	Petrol	90	07/94-10/97	RFX (XU10J2C)

Engine	Information	A10	A20	A40	A50	A70	C10 - C30	C20	E01
All engines							1.970.188	C10	1.500.494

ENGINE				
2.0 i	Petrol	89	07/92-06/97	RFX (XU10J2C)

Engine	Information	A10	A20	A40	A50	A70	C10 - C30	C20	E01
All engines							1.970.188	C10	1.500.494

ENGINE				
2.0 i	Petrol	90	07/94-10/97	XU10J2

Engine	Information	A10	A20	A40	A50	A70	C10 - C30	C20	E01
All engines							1.970.188	C10	1.500.494

A10	CONDENSER	A20	CONTACT SET	A40	DISTRIBUTOR CAP	A50	ROTOR	A70	PICK-UP
C10	COIL	C20	IGNITION MODULE	C30	ELECTRONIC IGNITION KIT	E01	IGNITION CABLE SET		

Vehicle	alim.	kW	Date	Engine	FUNCTIONS ON THE VEHICLE							
					A10	A20	A40	A50	A70	C10 - C30	C20	E01

FORMENTOR

				ENGINE
1.4 e-Hybrid	Petrol/ Electric	110	01/21->	DGEA

Engine	Information	A10	A20	A40	A50	A70	C10 - C30	C20	E01
All engines	x 4, ELDOR, COIL ON PLUG, incl. spark plug connector, Number of pins:4, incl. spark plug connector						1.970.599	C10	

				ENGINE
1.4 e-Hybrid	Petrol/ Electric	150	01/21->	DGEA

Engine	Information	A10	A20	A40	A50	A70	C10 - C30	C20	E01
All engines	x 4, ELDOR, COIL ON PLUG, incl. spark plug connector, Number of pins:4, incl. spark plug connector						1.970.599	C10	

				ENGINE
2.0 TSI	Petrol	180	03/21->	DNPA

Engine	Information	A10	A20	A40	A50	A70	C10 - C30	C20	E01
All engines	x 4, HITACHI, COIL ON PLUG, incl. spark plug connector						1.970.636	C10	

				ENGINE
2.0 TSI 4Drive	Petrol	140	08/20->	DNNA

Engine	Information	A10	A20	A40	A50	A70	C10 - C30	C20	E01
All engines	x 4, HITACHI, COIL ON PLUG, incl. spark plug connector						1.970.636	C10	

				ENGINE
2.0 TSI 4Drive	Petrol	228	07/20->	DNFB

Engine	Information	A10	A20	A40	A50	A70	C10 - C30	C20	E01
All engines	x 4, HITACHI, COIL ON PLUG, incl. spark plug connector						1.970.636	C10	

				ENGINE
VZ 1.4 e-Hybrid	Petrol/ Electric	180	02/21->	DGEA

Engine	Information	A10	A20	A40	A50	A70	C10 - C30	C20	E01
All engines	x 4, ELDOR, COIL ON PLUG, incl. spark plug connector, Number of pins:4, incl. spark plug connector						1.970.599	C10	

LEON

				ENGINE
1.4 e-HYBRID	Petrol/ Electric	110	09/20->	DGEA

Engine	Information	A10	A20	A40	A50	A70	C10 - C30	C20	E01
All engines	x 4, ELDOR, COIL ON PLUG, Number of pins:4, incl. spark plug connector						1.970.599	C10	

				ENGINE
1.4 e-HYBRID	Petrol/ Electric	150	09/20->	DGEA

Engine	Information	A10	A20	A40	A50	A70	C10 - C30	C20	E01
All engines	x 4, ELDOR, COIL ON PLUG, Number of pins:4, incl. spark plug connector						1.970.599	C10	

				ENGINE
2.0 TSI	Petrol	221	06/21->	DNFC

Engine	Information	A10	A20	A40	A50	A70	C10 - C30	C20	E01
All engines	x 4, HITACHI, COIL ON PLUG, incl. spark plug connector						1.970.636	C10	

				ENGINE
2.0 TSI 4Drive	Petrol	228	06/21->	DNFB

Engine	Information	A10	A20	A40	A50	A70	C10 - C30	C20	E01
All engines	x 4, HITACHI, COIL ON PLUG, incl. spark plug connector						1.970.636	C10	

				ENGINE
VZ 1.4 e-HYBRID	Petrol/ Electric	180	09/20->	DGEA

Engine	Information	A10	A20	A40	A50	A70	C10 - C30	C20	E01
All engines	x 4, ELDOR, COIL ON PLUG, Number of pins:4, incl. spark plug connector						1.970.599	C10	

A10 CONDENSER	A20 CONTACT SET	A40 DISTRIBUTOR CAP	A50 ROTOR	A70 PICK-UP
C10 COIL	C20 IGNITION MODULE	C30 ELECTRONIC IGNITION KIT	E01 IGNITION CABLE SET	

The present application list is a brief version. For the detailed information about the possibility of installation on a specific vehicle, please refer to our web-catalogue <http://catalogo.facet.eu/>

				FUNCTIONS ON THE VEHICLE								
Vehicle	alim.	kW	Date	Engine	 A10	 A20	 A40	 A50	 A70	 C10 - C30	 C20	 E01
1210				ENGINE								
1.2	Petrol	36	01/69->	--								
Engine	Information				A10	A20	A40	A50	A70	C10 - C30	C20	E01
All engines	version Ducellier				1.115.023	1.215.055		1.415.091				
All engines	->year 31/12/79, version Ducellier						1.315.049					
All engines										1.970.101D	C10	
1310				ENGINE								
1.3	Petrol	40	05/83-07/04	810-02/-99								
Engine	Information				A10	A20	A40	A50	A70	C10 - C30	C20	E01
All engines	version Ducellier				1.115.023	1.215.055	1.315.049	1.415.091				
All engines										1.970.101D	C10	
1410				ENGINE								
1.4	Petrol	43	01/69->	--								
Engine	Information				A10	A20	A40	A50	A70	C10 - C30	C20	E01
All engines	version Ducellier				1.115.023	1.215.055		1.415.091				
All engines	->year 31/12/79, version Ducellier						1.315.049					
All engines	01/01/80->, version Ducellier						1.315.054					
All engines										1.970.101D	C10	
ARO				ENGINE								
10	Petrol	0	01/72-12/80	--								
Engine	Information				A10	A20	A40	A50	A70	C10 - C30	C20	E01
All engines	version Ducellier				1.115.023	1.215.101	1.315.049	1.415.091				
All engines												1.500.511
DOKKER				ENGINE								
1.2Tce	Petrol	0	11/12->	H5F 408								
Engine	Information				A10	A20	A40	A50	A70	C10 - C30	C20	E01
All engines	Qty: 4									1.970.613	C10	
1.2Tce	Petrol	85	11/12->	H5F 402, H5F 408								
Engine	Information				A10	A20	A40	A50	A70	C10 - C30	C20	E01
All engines	x 4, COIL ON PLUG									1.970.613	C10	
1.2Tce 115	Petrol	84	12/12->	H5F 402								
Engine	Information				A10	A20	A40	A50	A70	C10 - C30	C20	E01
All engines	x 4, COIL ON PLUG									1.970.613	C10	
1.2Tce 115	Petrol	85	07/15->	--, H5F 408								
Engine	Information				A10	A20	A40	A50	A70	C10 - C30	C20	E01
Eng. --	Qty: 4									1.970.613	C10	
Eng. H5F 408	x 4, COIL ON PLUG									1.970.613	C10	
1.6	Petrol	0	11/12->	H4M 738, H4M 740								
Engine	Information				A10	A20	A40	A50	A70	C10 - C30	C20	E01
All engines	Qty: 4									1.970.613	C10	
1.6	Petrol	61	11/12->	K7M 812, K7M 828								
Engine	Information				A10	A20	A40	A50	A70	C10 - C30	C20	E01
All engines	x 1, D.I.S.									1.970.596	C10	
All engines												1.499.252
1.6	Petrol	75	04/15->	H4M 738								
Engine	Information				A10	A20	A40	A50	A70	C10 - C30	C20	E01
All engines	x 4, COIL ON PLUG									1.970.613	C10	

A10 CONDENSER	A20 CONTACT SET	A40 DISTRIBUTOR CAP	A50 ROTOR	A70 PICK-UP
C10 COIL	C20 IGNITION MODULE	C30 ELECTRONIC IGNITION KIT	E01 IGNITION CABLE SET	

Vehicle	alim.	kW	Date	Engine	FUNCTIONS ON THE VEHICLE									
					A10	A20	A40	A50	A70	C10 - C30	C20	E01		
ENGINE														
1.6 LPG	Petrol/ Liquified Petro- leum Gas (LPG)	61	11/13->	K7M 812, K7M 828										
ENGINE														
Engine		Information				A10	A20	A40	A50	A70	C10 - C30	C20	E01	
All engines		x 1, D.I.S.									1.970.596	C10		
All engines													1.499.252	
ENGINE														
1.6 LPG	Petrol/ Liquified Petro- leum Gas (LPG)	75	04/15->	H4M 740										
ENGINE														
Engine		Information				A10	A20	A40	A50	A70	C10 - C30	C20	E01	
All engines		x 4, COIL ON PLUG									1.970.613	C10		
ENGINE														
1.6 LPG	Petrol/ Liquified Petro- leum Gas (LPG)	80	08/18->	H4M 740										
ENGINE														
Engine		Information				A10	A20	A40	A50	A70	C10 - C30	C20	E01	
All engines		x 4, COIL ON PLUG									1.970.613	C10		
DUSTER														
ENGINE														
1.0 LPG	Petrol/ Liquified Petro- leum Gas (LPG)	74	01/19->	H4D 450, H4D 460										
ENGINE														
Engine		Information				A10	A20	A40	A50	A70	C10 - C30	C20	E01	
All engines		x 3, COIL ON PLUG									1.970.552	C10		
ENGINE														
1.0 TCe 100	Petrol	74	01/19->	H4D 450, H4D 460										
ENGINE														
Engine		Information				A10	A20	A40	A50	A70	C10 - C30	C20	E01	
All engines		x 3, COIL ON PLUG									1.970.552	C10		
ENGINE														
1.0 TCe 100 4x4	Petrol	74	01/19->	H4D 450, H4D 460										
ENGINE														
Engine		Information				A10	A20	A40	A50	A70	C10 - C30	C20	E01	
All engines		x 3, COIL ON PLUG									1.970.552	C10		
ENGINE														
1.0 TCe 90	Petrol	67	05/21->	H4D470										
ENGINE														
Engine		Information				A10	A20	A40	A50	A70	C10 - C30	C20	E01	
All engines		x 3, COIL ON PLUG									1.970.552	C10		
ENGINE														
1.2 TCe 125	Petrol	0	01/12->	H5F 408										
ENGINE														
Engine		Information				A10	A20	A40	A50	A70	C10 - C30	C20	E01	
All engines		Qty: 4									1.970.613	C10		
ENGINE														
1.2 TCe 125	Petrol	92	10/13->	H5F 404, H5F 408										
ENGINE														
Engine		Information				A10	A20	A40	A50	A70	C10 - C30	C20	E01	
All engines		x 4, COIL ON PLUG									1.970.613	C10		
ENGINE														
1.2 TCe 125 4x4	Petrol	92	10/13->	H5F 404, H5F 410										
ENGINE														
Engine		Information				A10	A20	A40	A50	A70	C10 - C30	C20	E01	
All engines		x 4, COIL ON PLUG									1.970.613	C10		
ENGINE														
1.6	Petrol	0	04/10->	K4M 642, K4M 646, K4M 694, K4M 842, K4M 884										
ENGINE														
Engine		Information				A10	A20	A40	A50	A70	C10 - C30	C20	E01	
All engines		Qty: 4									1.970.432	C10		
ENGINE														
1.6 16V	Petrol	0	04/10->	K4M 490										
ENGINE														
Engine		Information				A10	A20	A40	A50	A70	C10 - C30	C20	E01	
All engines		Qty: 4									1.970.432	C10		

A10 CONDENSER	A20 CONTACT SET	A40 DISTRIBUTOR CAP	A50 ROTOR	A70 PICK-UP
C10 COIL	C20 IGNITION MODULE	C30 ELECTRONIC IGNITION KIT	E01 IGNITION CABLE SET	

The present application list is a brief version. For the detailed information about the possibility of installation on a specific vehicle, please refer to our web-catalogue <http://catalogo.facet.eu/>

Vehicle	alim.	kW	Date	Engine	FUNCTIONS ON THE VEHICLE							
					A10	A20	A40	A50	A70	C10 - C30	C20	E01

ENGINE				
1.6 16V	Petrol	77	04/10->	K4M 606, K4M 616, K4M 694, K4M 696, K4M 842, K4M 896

Engine	Information	A10	A20	A40	A50	A70	C10 - C30	C20	E01
Eng. K4M 606, K4M 694, K4M 696, K4M 842, K4M 896	HSAB/HSMA/HSAP/HSAN, x 4, SAGEM, COIL ON PLUG						1.970.432	C10	
Eng. K4M 616	Qty: 4						1.970.432	C10	

ENGINE				
1.6 16V 4x4	Petrol	77	06/10->	K4M 490, K4M 606, K4M 646, K4M 690

Engine	Information	A10	A20	A40	A50	A70	C10 - C30	C20	E01
All engines	x 4, SAGEM, COIL ON PLUG, HSAS/HSAB/HSAN, x 4, SAGEM, COIL ON PLUG						1.970.432	C10	

ENGINE				
1.6 16V Hi-Flex	Petrol/Ethanol	77	08/10->	K4M 696

Engine	Information	A10	A20	A40	A50	A70	C10 - C30	C20	E01
All engines	x 4, SAGEM, COIL ON PLUG						1.970.432	C10	

ENGINE				
1.6 16V LPG	Petrol/Liquified Petroleum Gas (LPG)	77	04/11-01/18	K4M 616, K4M 642, K4M 696

Engine	Information	A10	A20	A40	A50	A70	C10 - C30	C20	E01
Eng. K4M 616, K4M 642	x 4, SAGEM, COIL ON PLUG						1.970.432	C10	
Eng. K4M 696	Qty: 4						1.970.432	C10	

ENGINE				
1.6 SCe 115	Petrol	84	06/15->	H4M 438, H4M 738

Engine	Information	A10	A20	A40	A50	A70	C10 - C30	C20	E01
Eng. H4M 438	Qty: 4						1.970.613	C10	
Eng. H4M 738	x 4, COIL ON PLUG						1.970.613	C10	

ENGINE				
1.6 SCe 115 4x4	Petrol	84	06/15->	H4M 430, H4M 730, H4M 738

Engine	Information	A10	A20	A40	A50	A70	C10 - C30	C20	E01
Eng. H4M 430	Qty: 4						1.970.613	C10	
Eng. H4M 730, H4M 738	x 4, COIL ON PLUG						1.970.613	C10	

ENGINE				
1.6 SCe 115 LPG	Petrol/Ethanol	84	06/15-01/18	H4M 740

Engine	Information	A10	A20	A40	A50	A70	C10 - C30	C20	E01
All engines	x 4, COIL ON PLUG						1.970.613	C10	

ENGINE				
1.6 SCe 115 LPG	Petrol/Liquified Petroleum Gas (LPG)	80	10/17->	H4M 740

Engine	Information	A10	A20	A40	A50	A70	C10 - C30	C20	E01
All engines	x 4, COIL ON PLUG						1.970.613	C10	

ENGINE				
2.0	Petrol	0	04/10->	F4R 400, F4R 401, F4R 403, F4R 404, F4R 405, F4R 408, F4R 410, F4R 412, F4R 414, F4R 416

Engine	Information	A10	A20	A40	A50	A70	C10 - C30	C20	E01
All engines	Qty: 4						1.970.432	C10	

ENGINE				
2.0	Petrol	104	04/10->	F4R 402







Engine	Information	A10	A20	A40	A50	A70	C10 - C30	C20	E01
All engines	Qty: 4						1.970.432	C10	

LODGY				
1.2 Tce	Petrol	0	03/12->	H5F 408

Engine	Information	A10	A20	A40	A50	A70	C10 - C30	C20	E01
All engines	Qty: 4						1.970.613	C10	

A10 CONDENSER	A20 CONTACT SET	A40 DISTRIBUTOR CAP	A50 ROTOR	A70 PICK-UP
C10 COIL	C20 IGNITION MODULE	C30 ELECTRONIC IGNITION KIT	E01 IGNITION CABLE SET	

Vehicle	alim.	kW	Date	Engine	FUNCTIONS ON THE VEHICLE									
					A10	A20	A40	A50	A70	C10 - C30	C20	E01		
ENGINE														
1.2 Tce	Petrol	85	03/12->	H5F 402, H5F 408										
ENGINE														
Engine					A10	A20	A40	A50	A70	C10 - C30	C20	E01		
All engines										1.970.613	C10			
ENGINE														
1.6	Petrol	0	03/12->	H4M 738, K4M 845										
ENGINE														
Engine					A10	A20	A40	A50	A70	C10 - C30	C20	E01		
Eng. K4M 845										1.970.432	C10			
Eng. H4M 738										1.970.613	C10			
ENGINE														
1.6	Petrol	61	03/12->	K7M 812, K7M 828										
ENGINE														
Engine					A10	A20	A40	A50	A70	C10 - C30	C20	E01		
Eng. K7M 812										1.970.596	C10			
Eng. K7M 828										1.970.596	C10			
All engines													1.499.252	
ENGINE														
1.6 LPG	Petrol/ Liquified Petroleum Gas (LPG)	61	11/13->	K7M 812, K7M 828										
ENGINE														
Engine					A10	A20	A40	A50	A70	C10 - C30	C20	E01		
All engines										1.970.596	C10			
All engines													1.499.252	
ENGINE														
1.6 LPG	Petrol/ Liquified Petroleum Gas (LPG)	75	04/15->	H4M 740										
ENGINE														
Engine					A10	A20	A40	A50	A70	C10 - C30	C20	E01		
All engines										1.970.613	C10			
ENGINE														
1.6 LPG	Petrol/ Liquified Petroleum Gas (LPG)	80	08/18->	H4M 740										
ENGINE														
Engine					A10	A20	A40	A50	A70	C10 - C30	C20	E01		
All engines										1.970.613	C10			
ENGINE														
1.6 Sce 100	Petrol	75	06/15->	H4M 738, H4M 740										
ENGINE														
Engine					A10	A20	A40	A50	A70	C10 - C30	C20	E01		
Eng. H4M 738										1.970.613	C10			
Eng. H4M 740										1.970.613	C10			
LOGAN I														
ENGINE														
1.0 Hi-Flex	Petrol/ Ethanol	56	01/11-10/12	D4D760										
ENGINE														
Engine					A10	A20	A40	A50	A70	C10 - C30	C20	E01		
All engines										1.970.518	C10			
ENGINE														
1.2 16V	Petrol	55	02/06->	D4F 732										
ENGINE														
Engine					A10	A20	A40	A50	A70	C10 - C30	C20	E01		
All engines										1.970.518	C10			
All engines													1.499.246	
ENGINE														
1.2 16V LPG	Petrol/ Liquified Petroleum Gas (LPG)	55	02/06->	D4F 734										
ENGINE														
Engine					A10	A20	A40	A50	A70	C10 - C30	C20	E01		
All engines										1.970.518	C10			
ENGINE														
1.4	Petrol	55	09/04->	K7J 710										
ENGINE														
Engine					A10	A20	A40	A50	A70	C10 - C30	C20	E01		
All engines										1.970.596	C10			1.499.252
A10	CONDENSER	A20	CONTACT SET	A40	DISTRIBUTOR CAP	A50	ROTOR	A70	PICK-UP					
C10	COIL	C20	IGNITION MODULE	C30	ELECTRONIC IGNITION KIT	E01	IGNITION CABLE SET							









					FUNCTIONS ON THE VEHICLE							
Vehicle	alim.	kW	Date	Engine								
					A10	A20	A40	A50	A70	C10 - C30	C20	E01
ENGINE												
1.4	Petrol	55	09/04->	K7J 710								
Engine	Information											
All engines	x 1, D.I.S.									1.970.596	C10	
All engines	->year 18/03/05											1.499.244
All engines	18/03/05 ->											1.499.252
ENGINE												
1.4 MPI LPG	Petrol/ Liquified Petro- leum Gas (LPG)	55	02/06-12/12	K7J 710, K7J 714								
Engine	Information											
Eng. K7J 710										1.970.596	C10	1.499.252
Eng. K7J 714	x 1, D.I.S.									1.970.596	C10	
ENGINE												
1.6	Petrol	64	09/04->	K7M 710								
Engine	Information											
All engines	->year 01/11/11, x 1, D.I.S., x 1, D.I.S. 01/12/11 ->, x 1, D.I.S.									1.970.596	C10	
All engines	->year 18/03/05											1.499.244
All engines												1.499.252
All engines	18/03/05 ->											1.499.252
ENGINE												
1.6 16V	Petrol	77	12/05->	K4M 690, K4M 694, K4M 696, K4M 697, K4M 698								
Engine	Information											
All engines	x 4, SAGEM, COIL ON PLUG									1.970.432	C10	
Eng. K4M 694	Qty: 4									1.970.432	C10	
ENGINE												
1.6 16V Flexifuel	Petrol/ Ethanol	77	07/10->	K4M 696								
Engine	Information											
All engines	x 4, SAGEM, COIL ON PLUG									1.970.432	C10	
ENGINE												
1.6 16V Hi-Flex	Petrol/ Ethanol	77	11/09->	K4M 690, K4M 696								
Engine	Information											
Eng. K4M 690	Qty: 4									1.970.432	C10	
Eng. K4M 696	x 4, SAGEM, COIL ON PLUG									1.970.432	C10	
ENGINE												
1.6 Bifuel	Bi-Fuel	62	05/10->	K7M 800								
Engine	Information											
All engines										1.970.596	C10	1.499.252
Eng. K7M 800										1.970.596	C10	1.499.252
Eng. K7M 718, K7M 818	x 1, D.I.S.									1.970.596	C10	
ENGINE												
1.6 Bifuel	Petrol/ Liquified Petro- leum Gas (LPG)	64	11/08->	K7M 710, K7M 718								
Engine	Information											
Eng. K7M 710										1.970.596	C10	
Eng. K7M 718	x 1, D.I.S.									1.970.596	C10	
Eng. K7M 710	->year 18/03/05											1.499.244
Eng. K7M 710	18/03/05 ->											1.499.252
ENGINE												
1.6 LPG	Petrol/ Liquified Petro- leum Gas (LPG)	62	05/10-12/12	K7M 818								
Engine	Information											
All engines	x 1, D.I.S.									1.970.596	C10	

A10 CONDENSER	A20 CONTACT SET	A40 DISTRIBUTOR CAP	A50 ROTOR	A70 PICK-UP
C10 COIL	C20 IGNITION MODULE	C30 ELECTRONIC IGNITION KIT	E01 IGNITION CABLE SET	

Vehicle	alim.	kW	Date	Engine	FUNCTIONS ON THE VEHICLE									
					A10	A20	A40	A50	A70	C10 - C30	C20	E01		
ENGINE														
1.6 LPG	Petrol/ Liquified Petro- leum Gas (LPG)	64	08/04-03/11	K7M 718										
Engine					A10	A20	A40	A50	A70	C10 - C30	C20	E01		
All engines										1.970.596	C10			
ENGINE														
1.6 MPI 85	Petrol	62	05/10->	K7M 800										
Engine					A10	A20	A40	A50	A70	C10 - C30	C20	E01		
All engines										1.970.596	C10			
All engines													1.499.252	
LOGAN II														
ENGINE														
1.0	Petrol	0	10/12->	D4D 754										
Engine					A10	A20	A40	A50	A70	C10 - C30	C20	E01		
All engines										1.970.518	C10			
ENGINE														
1.2	Petrol	54	05/15->	D4F 732										
Engine					A10	A20	A40	A50	A70	C10 - C30	C20	E01		
All engines										1.970.518	C10			
ENGINE														
1.2	Petrol	55	10/12->	D4F 732, D4F 734										
Engine					A10	A20	A40	A50	A70	C10 - C30	C20	E01		
All engines										1.970.518	C10			
ENGINE														
1.2 LPG	Petrol/ Liquified Petro- leum Gas (LPG)	53	02/13->	D4F 734										
Engine					A10	A20	A40	A50	A70	C10 - C30	C20	E01		
All engines										1.970.518	C10			
ENGINE														
1.2 LPG	Petrol/ Liquified Petro- leum Gas (LPG)	55	10/12->	D4F 732, D4F 734										
Engine					A10	A20	A40	A50	A70	C10 - C30	C20	E01		
All engines										1.970.518	C10			
ENGINE														
1.6	Petrol	63	06/13-08/16	K7M 812										
Engine					A10	A20	A40	A50	A70	C10 - C30	C20	E01		
All engines										1.970.596	C10			
ENGINE														
1.6 16V	Petrol	0	10/12->	K4M 845, K7M 812										
Engine					A10	A20	A40	A50	A70	C10 - C30	C20	E01		
Eng. K4M 845										1.970.432	C10			
Eng. K7M 812										1.970.596	C10		1.499.252	
ENGINE														
1.6 16V	Petrol	77	01/13->	K4M 842, K7M 764										
Engine					A10	A20	A40	A50	A70	C10 - C30	C20	E01		
Eng. K4M 842										1.970.432	C10			
Eng. K7M 764										1.970.596	C10		1.499.252	
ENGINE														
2.0	Petrol	0	10/12->	F4R 412, F4R 416										
Engine					A10	A20	A40	A50	A70	C10 - C30	C20	E01		
All engines										1.970.432	C10			
ENGINE														
TcE 90	Petrol	0	10/12->	H4B 408, H4B 410										
Engine					A10	A20	A40	A50	A70	C10 - C30	C20	E01		
All engines										1.970.613	C10			

A10 CONDENSER	A20 CONTACT SET	A40 DISTRIBUTOR CAP	A50 ROTOR	A70 PICK-UP
C10 COIL	C20 IGNITION MODULE	C30 ELECTRONIC IGNITION KIT	E01 IGNITION CABLE SET	

The present application list is a brief version. For the detailed information about the possibility of installation on a specific vehicle, please refer to our web-catalogue <http://catalogo.facet.eu/>

					FUNCTIONS ON THE VEHICLE							
Vehicle	alim.	kW	Date	Engine								
ENGINE												
TCe 90	Petrol	66	10/12->	H4B 400, H4B 408								
ENGINE												
Engine		Information			A10	A20	A40	A50	A70	C10 - C30	C20	E01
All engines		x 3, COIL ON PLUG								1.970.613	C10	
ENGINE												
TCe 90 LPG	Petrol/ Liquified Petro- leum Gas (LPG)	66	09/15->	H4B 410								
ENGINE												
Engine		Information			A10	A20	A40	A50	A70	C10 - C30	C20	E01
All engines		x 3, COIL ON PLUG								1.970.613	C10	
LOGAN II MCV												
ENGINE												
1.0 LPG	Petrol/ Liquified Petro- leum Gas (LPG)	74	11/19->	H4D 450, H4D 460								
ENGINE												
Engine		Information			A10	A20	A40	A50	A70	C10 - C30	C20	E01
All engines		x 3, COIL ON PLUG								1.970.552	C10	
ENGINE												
1.0 TCe 100	Petrol	74	11/19->	H4D 450, H4D 460								
ENGINE												
Engine		Information			A10	A20	A40	A50	A70	C10 - C30	C20	E01
All engines		x 3, COIL ON PLUG								1.970.552	C10	
ENGINE												
1.2	Petrol	54	05/15->	D4F 732								
ENGINE												
Engine		Information			A10	A20	A40	A50	A70	C10 - C30	C20	E01
All engines		x 1, D.I.S.								1.970.518	C10	
ENGINE												
1.2	Petrol	55	02/13->	D4F 732								
ENGINE												
Engine		Information			A10	A20	A40	A50	A70	C10 - C30	C20	E01
All engines		x 1, D.I.S.								1.970.518	C10	
ENGINE												
1.2 LPG	Petrol/ Liquified Petro- leum Gas (LPG)	53	02/13->	D4F 734								
ENGINE												
Engine		Information			A10	A20	A40	A50	A70	C10 - C30	C20	E01
All engines		x 1, D.I.S.								1.970.518	C10	
ENGINE												
1.2 LPG	Petrol/ Liquified Petro- leum Gas (LPG)	55	02/13->	D4F 732, D4F 734								
ENGINE												
Engine		Information			A10	A20	A40	A50	A70	C10 - C30	C20	E01
All engines		x 1, D.I.S.								1.970.518	C10	
ENGINE												
1.6	Petrol	62	06/13->	K7M 812								
ENGINE												
Engine		Information			A10	A20	A40	A50	A70	C10 - C30	C20	E01
All engines		x 1, D.I.S.								1.970.596	C10	
ENGINE												
TCe 90	Petrol	66	02/13->	H4B 400, H4B 408								
ENGINE												
Engine		Information			A10	A20	A40	A50	A70	C10 - C30	C20	E01
All engines		x 3, COIL ON PLUG								1.970.613	C10	
ENGINE												
TCe 90 LPG	Petrol/ Liquified Petro- leum Gas (LPG)	66	09/15->	H4B 410								
ENGINE												
Engine		Information			A10	A20	A40	A50	A70	C10 - C30	C20	E01
All engines		K8M1, x 3, COIL ON PLUG								1.970.613	C10	

A10 CONDENSER	A20 CONTACT SET	A40 DISTRIBUTOR CAP	A50 ROTOR	A70 PICK-UP
C10 COIL	C20 IGNITION MODULE	C30 ELECTRONIC IGNITION KIT	E01 IGNITION CABLE SET	

Vehicle	alim.	kW	Date	Engine	FUNCTIONS ON THE VEHICLE							
					A10	A20	A40	A50	A70	C10 - C30	C20	E01
SANDERO												
1.0 TcE 100	Petrol	74	01/21->	H4D480								
ENGINE		Information										
All engines		x 3, COIL ON PLUG		A10	A20	A40	A50	A70	C10 - C30	C20	E01	
1.0 TcE 100 ECO-G	Petrol/ Liquified Petro- leum Gas (LPG)	74	01/21->	H4D480								
ENGINE		Information										
All engines		x 3, COIL ON PLUG		A10	A20	A40	A50	A70	C10 - C30	C20	E01	
1.0 TcE 90	Petrol	67	01/21->	H4D470								
ENGINE		Information										
All engines		x 3, COIL ON PLUG		A10	A20	A40	A50	A70	C10 - C30	C20	E01	
1.0 TcE 90 ECO-G	Petrol/ Liquified Petro- leum Gas (LPG)	67	01/21->	H4D470								
ENGINE		Information										
All engines		x 3, COIL ON PLUG		A10	A20	A40	A50	A70	C10 - C30	C20	E01	
SANDERO I												
1.0 Hi-Flex	Petrol/ Ethanol	56	01/11-12/12	D4D760								
ENGINE		Information										
All engines		x 1, D.I.S.		A10	A20	A40	A50	A70	C10 - C30	C20	E01	
1.2 16V	Petrol	55	11/08->	D4F 732								
ENGINE		Information										
All engines		x 1, D.I.S.		A10	A20	A40	A50	A70	C10 - C30	C20	E01	
All engines												1.499.246
1.2 16V LPG	Petrol/ Liquified Petro- leum Gas (LPG)	55	11/08->	D4F 732, D4F 734								
ENGINE		Information										
Eng. D4F 732				A10	A20	A40	A50	A70	C10 - C30	C20	E01	
Eng. D4F 734		x 1, D.I.S.										1.499.246
1.4	Petrol	55	06/08->	K7J 710								
ENGINE		Information										
All engines		x 1, D.I.S.		A10	A20	A40	A50	A70	C10 - C30	C20	E01	
All engines		->year 18/03/05										1.499.244
All engines		18/03/05 ->										1.499.252
1.4 MPI LPG	Petrol/ Liquified Petro- leum Gas (LPG)	53	01/09->	K7J 714								
ENGINE		Information										
All engines		x 1, D.I.S.		A10	A20	A40	A50	A70	C10 - C30	C20	E01	
1.6	Petrol	62	06/08->	K7M 718								
ENGINE		Information										
All engines				A10	A20	A40	A50	A70	C10 - C30	C20	E01	
All engines												1.499.252
1.6	Petrol	64	06/08->	K7M 710								
ENGINE		Information										
All engines		x 1, D.I.S.		A10	A20	A40	A50	A70	C10 - C30	C20	E01	
All engines												1.499.252
A10	CONDENSER	A20	CONTACT SET	A40	DISTRIBUTOR CAP	A50	ROTOR	A70	PICK-UP			
C10	COIL	C20	IGNITION MODULE	C30	ELECTRONIC IGNITION KIT	E01	IGNITION CABLE SET					

Vehicle	alim.	kW	Date	Engine	FUNCTIONS ON THE VEHICLE							
					A10	A20	A40	A50	A70	C10 - C30	C20	E01

ENGINE				
1.6 16V	Petrol	77	07/11->	K4M 690, K4M 694

Engine	Information	A10	A20	A40	A50	A70	C10 - C30	C20	E01
All engines	x 4, SAGEM, COIL ON PLUG						1.970.432	C10	

ENGINE				
1.6 16V Bifuel	Petrol/ Ethanol	77	01/11->	K4M 690, K4M 696

Engine	Information	A10	A20	A40	A50	A70	C10 - C30	C20	E01
Eng. K4M 690	Qty: 4						1.970.432	C10	
Eng. K4M 696	x 4, SAGEM, COIL ON PLUG						1.970.432	C10	

ENGINE				
1.6 Hi-Flex	Petrol/ Ethanol	64	06/08-12/12	K7M 732

Engine	Information	A10	A20	A40	A50	A70	C10 - C30	C20	E01
All engines	x 1, D.I.S.						1.970.596	C10	

ENGINE				
1.6 LPG	Petrol/ Liquified Petro- leum Gas (LPG)	60	01/11-12/12	K7M 818

Engine	Information	A10	A20	A40	A50	A70	C10 - C30	C20	E01
All engines	x 1, D.I.S.						1.970.596	C10	

ENGINE				
1.6 LPG	Petrol/ Liquified Petro- leum Gas (LPG)	62	05/10-10/12	K7M 818

Engine	Information	A10	A20	A40	A50	A70	C10 - C30	C20	E01
All engines	x 1, D.I.S.						1.970.596	C10	

ENGINE				
1.6 LPG	Petrol/ Liquified Petro- leum Gas (LPG)	64	06/08-12/12	K7M 718

Engine	Information	A10	A20	A40	A50	A70	C10 - C30	C20	E01
All engines	x 1, D.I.S.						1.970.596	C10	

ENGINE				
1.6 MPI 85	Petrol	62	05/10-06/13	K7M 800

Engine	Information	A10	A20	A40	A50	A70	C10 - C30	C20	E01
All engines	x 1, D.I.S.						1.970.596	C10	
All engines									1.499.252

ENGINE				
1.0	Petrol	0	10/12->	D4D 754

Engine	Information	A10	A20	A40	A50	A70	C10 - C30	C20	E01
All engines							1.970.518	C10	

ENGINE				
1.0 LPG	Petrol/ Liquified Petro- leum Gas (LPG)	74	11/19->	H4D 450, H4D 460

Engine	Information	A10	A20	A40	A50	A70	C10 - C30	C20	E01
All engines	x 3, COIL ON PLUG						1.970.552	C10	

ENGINE				
1.0 TCe 100	Petrol	74	11/19->	H4D 450, H4D 460

Engine	Information	A10	A20	A40	A50	A70	C10 - C30	C20	E01
All engines	x 3, COIL ON PLUG						1.970.552	C10	

ENGINE				
1.0 TCE 90 GPF	Petrol	67	01/21->	H4D470









Engine	Information	A10	A20	A40	A50	A70	C10 - C30	C20	E01
All engines	x 3, COIL ON PLUG						1.970.552	C10	

A10 CONDENSER	A20 CONTACT SET	A40 DISTRIBUTOR CAP	A50 ROTOR	A70 PICK-UP
C10 COIL	C20 IGNITION MODULE	C30 ELECTRONIC IGNITION KIT	E01 IGNITION CABLE SET	

Vehicle	alim.	kW	Date	Engine	FUNCTIONS ON THE VEHICLE									
					A10	A20	A40	A50	A70	C10 - C30	C20	E01		
ENGINE														
1.2	Petrol	54	05/15->	D4F 732										
ENGINE														
All engines											1.970.518	C10		
1.2	Petrol	55	10/12->	D4F 732, D4F 734										
ENGINE														
All engines											1.970.518	C10		
1.2 LPG	Petrol/ Liquified Petro- leum Gas (LPG)	55	10/12->	D4F 732, D4F 734										
ENGINE														
All engines											1.970.518	C10		
Eng. D4F 734											1.970.518	C10		
1.6	Petrol	63	11/12->	K7M 812										
ENGINE														
All engines											1.970.596	C10		1.499.252
1.6 16V	Petrol	77	01/13->	K4M 842, K4M 845										
ENGINE														
All engines											1.970.432	C10		
Qty: 4														
1.6 I	Petrol	77	10/12->	K7M 764										
ENGINE														
All engines											1.970.596	C10		1.499.252
2.0	Petrol	0	10/12->	F4R 416										
ENGINE														
All engines											1.970.432	C10		
Qty: 4														
2.0 LPG	Petrol/ Liquified Petro- leum Gas (LPG)	0	10/12->	F4R 412										
ENGINE														
All engines											1.970.432	C10		
Qty: 4														
TCe 90	Petrol	0	10/12->	--										
ENGINE														
All engines											1.970.613	C10		
Qty: 3														
TCe 90	Petrol	66	10/12->	H4B 400, H4B 408										
ENGINE														
All engines											1.970.613	C10		
x 3, COIL ON PLUG														
TCe 90 LPG	Petrol/ Liquified Petro- leum Gas (LPG)	66	09/15->	H4B 410										
ENGINE														
All engines											1.970.613	C10		
x 3, COIL ON PLUG														
SOLENZA														
1.4	Petrol	55	02/03-10/05	E7J 262										
ENGINE														
All engines											1.970.596	C10		
x 1, D.I.S.														

A10 CONDENSER	A20 CONTACT SET	A40 DISTRIBUTOR CAP	A50 ROTOR	A70 PICK-UP
C10 COIL	C20 IGNITION MODULE	C30 ELECTRONIC IGNITION KIT	E01 IGNITION CABLE SET	

The present application list is a brief version. For the detailed information about the possibility of installation on a specific vehicle, please refer to our web-catalogue <http://catalogo.facet.eu/>

				FUNCTIONS ON THE VEHICLE								
Vehicle	alim.	kW	Date	Engine	 A10	 A20	 A40	 A50	 A70	 C10 - C30	 C20	 E01
ARANOS												
1.5	Petrol	66	01/95-11/97	ENGINE V15L								
Engine		Information			A10	A20	A40	A50	A70	C10 - C30	C20	E01
All engines		version Delco Remy					1.312.075					
All engines												1.501.433
1.8												
1.8	Petrol	70	01/95-11/97	ENGINE Y18L								
Engine		Information			A10	A20	A40	A50	A70	C10 - C30	C20	E01
All engines		version Delco Remy					1.312.075	1.412.098				
ESPERO												
1.5	Petrol	55	10/97-09/99	ENGINE G15MF								
Engine		Information			A10	A20	A40	A50	A70	C10 - C30	C20	E01
All engines												1.501.433
1.5 16V												
1.5 16V	Petrol	66	02/95-06/99	ENGINE A15MF								
Engine		Information			A10	A20	A40	A50	A70	C10 - C30	C20	E01
All engines		version Delco Remy					1.312.075					
All engines												1.501.433
1.8												
1.8	Petrol	70	02/95-06/99	ENGINE C18LE								
Engine		Information			A10	A20	A40	A50	A70	C10 - C30	C20	E01
All engines		version Delco Remy					1.312.075	1.412.098				
2.0												
2.0	Petrol	77	02/95-06/99	ENGINE C20LE								
Engine		Information			A10	A20	A40	A50	A70	C10 - C30	C20	E01
All engines		version Delco Remy					1.312.075	1.412.098				
EVANDA												
2.0	Petrol	96	08/02->	ENGINE L88, X 20 SED								
Engine		Information			A10	A20	A40	A50	A70	C10 - C30	C20	E01
All engines												1.501.677
KALOS												
1.2	Petrol	53	04/03->	ENGINE B12S1, F12S3								
Engine		Information			A10	A20	A40	A50	A70	C10 - C30	C20	E01
All engines												1.499.006
1.4												
1.4	Petrol	61	09/02->	ENGINE F14S3								
Engine		Information			A10	A20	A40	A50	A70	C10 - C30	C20	E01
All engines												1.501.731
1.4												
1.4	Petrol	69	05/03-12/04	ENGINE F14D3								
Engine		Information			A10	A20	A40	A50	A70	C10 - C30	C20	E01
All engines												1.501.680
1.4 16V												
1.4 16V	Petrol	69	04/03->	ENGINE F14D3								
Engine		Information			A10	A20	A40	A50	A70	C10 - C30	C20	E01
All engines												1.501.680
KORANDO												
2.0	Petrol	93	12/98-02/01	ENGINE E20								
Engine		Information			A10	A20	A40	A50	A70	C10 - C30	C20	E01
All engines		x 1, D.I.S.								1.970.316	C10	
2.0 16V												
2.0 16V	Petrol	94	02/99->	ENGINE E20, M 161.950								
Engine		Information			A10	A20	A40	A50	A70	C10 - C30	C20	E01
Eng. E20		x 1, D.I.S.								1.970.316	C10	
Eng. M 161.950		Qty: 2								1.970.316	C10	

A10 CONDENSER	A20 CONTACT SET	A40 DISTRIBUTOR CAP	A50 ROTOR	A70 PICK-UP
C10 COIL	C20 IGNITION MODULE	C30 ELECTRONIC IGNITION KIT	E01 IGNITION CABLE SET	

Vehicle	alim.	kW	Date	Engine	FUNCTIONS ON THE VEHICLE									
					A10	A20	A40	A50	A70	C10 - C30	C20	E01		
ENGINE														
2.3	Petrol	103	01/99-02/01	E23										
Engine	Information				A10	A20	A40	A50	A70	C10 - C30	C20	E01		
All engines	x 1, D.I.S.									1.970.316	C10			
ENGINE														
2.3	Petrol	105	01/99->	E23, M 161.970										
Engine	Information				A10	A20	A40	A50	A70	C10 - C30	C20	E01		
Eng. E23	x 1, D.I.S.									1.970.316	C10			
Eng. M 161.970	Qty: 2									1.970.316	C10			
ENGINE														
3.2 4x4	Petrol	156	01/99->	E32, M 104.995										
Engine	Information				A10	A20	A40	A50	A70	C10 - C30	C20	E01		
Eng. E32	x 1, D.I.S.									1.970.316	C10			
Eng. M 104.995	Qty: 3									1.970.316	C10			
LACETTI														
ENGINE														
1.4	Petrol	70	02/04->	F14D3										
Engine	Information				A10	A20	A40	A50	A70	C10 - C30	C20	E01		
All engines													1.501.509	
ENGINE														
1.6	Petrol	80	02/04->	F16D3										
Engine	Information				A10	A20	A40	A50	A70	C10 - C30	C20	E01		
All engines	x 1, D.I.S.									1.970.585	C10			
All engines													1.501.509	
ENGINE														
1.8	Petrol	90	02/04->	T18SED										
Engine	Information				A10	A20	A40	A50	A70	C10 - C30	C20	E01		
All engines													1.501.677	
LANOS														
ENGINE														
1.3	Petrol	55	05/97->	A14SMS										
Engine	Information				A10	A20	A40	A50	A70	C10 - C30	C20	E01		
All engines													1.501.731	
ENGINE														
1.5	Petrol	63	05/97->	A15SMS										
Engine	Information				A10	A20	A40	A50	A70	C10 - C30	C20	E01		
All engines													1.501.731	
ENGINE														
1.6 16V	Petrol	78	02/97->	A16DMS										
Engine	Information				A10	A20	A40	A50	A70	C10 - C30	C20	E01		
All engines													1.501.680	
LEGANZA														
ENGINE														
2.0 16V	Petrol	93	07/00-04/04	T20SED										
Engine	Information				A10	A20	A40	A50	A70	C10 - C30	C20	E01		
All engines													1.501.677	
ENGINE														
2.0 16V	Petrol	98	06/97-12/02	X 20 SED										
Engine	Information				A10	A20	A40	A50	A70	C10 - C30	C20	E01		
All engines													1.501.677	
ENGINE														
2.2 16V	Petrol	100	04/99-12/02	T22SED										
Engine	Information				A10	A20	A40	A50	A70	C10 - C30	C20	E01		
All engines													1.501.677	
MATIZ														
ENGINE														
0.8	Petrol	38	08/98->	F8CV										
Engine	Information				A10	A20	A40	A50	A70	C10 - C30	C20	E01		
All engines	version Mando						1.331.139	1.431.131						
All engines	version Dac						1.331.172	1.431.139						
All engines	->VET. 577030									1.970.219	C10		1.501.634	
All engines	->ch. 577030, x 1, DISTRIBUTOR									1.970.219	C10			
A10	CONDENSER		A20	CONTACT SET		A40	DISTRIBUTOR CAP		A50	ROTOR		A70	PICK-UP	
C10	COIL		C20	IGNITION MODULE		C30	ELECTRONIC IGNITION KIT		E01	IGNITION CABLE SET				

Vehicle	alim.	kW	Date	Engine	FUNCTIONS ON THE VEHICLE							
					A10	A20	A40	A50	A70	C10 - C30	C20	E01

MATIZ

				ENGINE
0.8	Petrol	38	08/98->	F8CV

Engine	Information	A10	A20	A40	A50	A70	C10 - C30	C20	E01
All engines	VET.577031->								1.499.007

				ENGINE
1.0	Petrol	46	04/03-12/04	B10S

Engine	Information	A10	A20	A40	A50	A70	C10 - C30	C20	E01
All engines									1.499.006

				ENGINE
1.0	Petrol	47	01/03->	B10S

Engine	Information	A10	A20	A40	A50	A70	C10 - C30	C20	E01
All engines									1.499.006

MUSSO

				ENGINE
2.3	Petrol	103	01/99->	M 111.970

Engine	Information	A10	A20	A40	A50	A70	C10 - C30	C20	E01
All engines	Musso, x 1, D.I.S.						1.970.316	C10	

				ENGINE
3.2 4x4	Petrol	162	01/99->	M 104.992, M162E32

Engine	Information	A10	A20	A40	A50	A70	C10 - C30	C20	E01
Eng. M 104.992	Qty: 3						1.970.316	C10	
Eng. M162E32	Musso, x 1, D.I.S.						1.970.316	C10	

NEXIA

				ENGINE
1.5	Petrol	44	08/96-08/97	G15MF

Engine	Information	A10	A20	A40	A50	A70	C10 - C30	C20	E01
All engines	version Delco Remy			1.312.075	1.412.098				
All engines									1.501.942

				ENGINE
1.5	Petrol	52	02/95-08/97	G15MF

Engine	Information	A10	A20	A40	A50	A70	C10 - C30	C20	E01
All engines	version Delco Remy			1.312.075	1.412.098				
All engines									1.501.942

				ENGINE
1.5	Petrol	55	02/95-08/97	G15MF

Engine	Information	A10	A20	A40	A50	A70	C10 - C30	C20	E01
All engines	version Delco Remy			1.312.075	1.412.098				
All engines									1.501.942

				ENGINE
1.5 16V	Petrol	66	02/95-08/97	A15MF

Engine	Information	A10	A20	A40	A50	A70	C10 - C30	C20	E01
All engines	version Delco Remy			1.312.075					
All engines									1.501.433

NUBIRA I

				ENGINE
1.6 16V	Petrol	76	07/00->	A16DMS

Engine	Information	A10	A20	A40	A50	A70	C10 - C30	C20	E01
All engines									1.501.680

				ENGINE
1.6 16V	Petrol	78	05/97-05/99	A16DMS

Engine	Information	A10	A20	A40	A50	A70	C10 - C30	C20	E01
All engines									1.501.680

				ENGINE
2.0 16V	Petrol	93	12/00->	T20SED

Engine	Information	A10	A20	A40	A50	A70	C10 - C30	C20	E01
All engines									1.501.677

				ENGINE
2.0 16V	Petrol	98	05/97->	X 20 SED, Z20L

Engine	Information	A10	A20	A40	A50	A70	C10 - C30	C20	E01
All engines									1.501.677

A10 CONDENSER	A20 CONTACT SET	A40 DISTRIBUTOR CAP	A50 ROTOR	A70 PICK-UP
C10 COIL	C20 IGNITION MODULE	C30 ELECTRONIC IGNITION KIT	E01 IGNITION CABLE SET	

Vehicle	alim.	kW	Date	Engine	FUNCTIONS ON THE VEHICLE							
					A10	A20	A40	A50	A70	C10 - C30	C20	E01
2.0 CDX												
ENGINE												
T20SED												
Engine			Information		A10	A20	A40	A50	A70	C10 - C30	C20	E01
All engines												1.501.677
NUBIRA II												
1.4												
ENGINE												
F14D3												
Engine			Information		A10	A20	A40	A50	A70	C10 - C30	C20	E01
All engines			x 1, D.I.S.							1.970.585	C10	
All engines												1.501.509
1.6												
ENGINE												
F16D3												
Engine			Information		A10	A20	A40	A50	A70	C10 - C30	C20	E01
All engines			x 1, D.I.S.							1.970.585	C10	
All engines												1.501.509
1.8												
ENGINE												
T18SED												
Engine			Information		A10	A20	A40	A50	A70	C10 - C30	C20	E01
All engines												1.501.677
REXTON												
3.2 V6												
ENGINE												
M 162.992												
Engine			Information		A10	A20	A40	A50	A70	C10 - C30	C20	E01
All engines			Qty: 3							1.970.316	C10	
REZZO												
1.6												
ENGINE												
A16DMS												
Engine			Information		A10	A20	A40	A50	A70	C10 - C30	C20	E01
All engines												1.501.680
1.8												
ENGINE												
--												
Engine			Information		A10	A20	A40	A50	A70	C10 - C30	C20	E01
All engines												1.501.730
1.8												
ENGINE												
F18D2												
Engine			Information		A10	A20	A40	A50	A70	C10 - C30	C20	E01
All engines												1.501.730
1.8												
ENGINE												
A18DMS												
Engine			Information		A10	A20	A40	A50	A70	C10 - C30	C20	E01
All engines												1.501.730
1.8												
ENGINE												
--												
Engine			Information		A10	A20	A40	A50	A70	C10 - C30	C20	E01
All engines												1.501.730
2.0												
ENGINE												
X 20 SED												
Engine			Information		A10	A20	A40	A50	A70	C10 - C30	C20	E01
All engines												1.501.677
2.0												
ENGINE												
T20SED												
Engine			Information		A10	A20	A40	A50	A70	C10 - C30	C20	E01
All engines												1.501.677
TACUMA												
1.6												
ENGINE												
A16DMS												
Engine			Information		A10	A20	A40	A50	A70	C10 - C30	C20	E01
All engines												1.501.680

A10 CONDENSER	A20 CONTACT SET	A40 DISTRIBUTOR CAP	A50 ROTOR	A70 PICK-UP
C10 COIL	C20 IGNITION MODULE	C30 ELECTRONIC IGNITION KIT	E01 IGNITION CABLE SET	

The present application list is a brief version. For the detailed information about the possibility of installation on a specific vehicle, please refer to our web-catalogue <http://catalogo.facet.eu/>

Vehicle	alim.	kW	Date	Engine	FUNCTIONS ON THE VEHICLE							
					A10	A20	A40	A50	A70	C10 - C30	C20	E01

ENGINE				
2.0	Petrol	89	09/00-01/05	X 20 SED

Engine	Information	A10	A20	A40	A50	A70	C10 - C30	C20	E01
All engines									1.501.677

A10	CONDENSER	A20	CONTACT SET	A40	DISTRIBUTOR CAP	A50	ROTOR	A70	PICK-UP
C10	COIL	C20	IGNITION MODULE	C30	ELECTRONIC IGNITION KIT	E01	IGNITION CABLE SET		

Vehicle	alim.	kW	Date	Engine	FUNCTIONS ON THE VEHICLE							
					A10	A20	A40	A50	A70	C10 - C30	C20	E01

850				
				ENGINE
0.8	Petrol	34	07/86-12/89	--

Engine	Information	A10	A20	A40	A50	A70	C10 - C30	C20	E01
All engines	version Denso		1.213.011HV						
All engines	->year 30/11/86, version Denso				1.413.014				
All engines	01/12/86 ->, version Denso				1.413.030				

APPLAUSE I				
				ENGINE
1.6 16V	Petrol	66	06/89-07/97	HD

Engine	Information	A10	A20	A40	A50	A70	C10 - C30	C20	E01
All engines	version Denso			1.313.258	1.413.028				

1.6 16V				
				ENGINE
1.6 16V	Petrol	77	06/89-07/97	HD-E

Engine	Information	A10	A20	A40	A50	A70	C10 - C30	C20	E01
All engines	version Denso			1.313.258	1.413.028				

1.6 16V 4WD				
				ENGINE
1.6 16V 4WD	Petrol	77	06/89-07/97	HD-E

Engine	Information	A10	A20	A40	A50	A70	C10 - C30	C20	E01
All engines	version Denso			1.313.258	1.413.028				

CHARADE III				
				ENGINE
1.0	Petrol	38	03/87-12/92	CB 23

Engine	Information	A10	A20	A40	A50	A70	C10 - C30	C20	E01
All engines	version Denso		1.213.011HV	1.313.094					
All engines	->year 31/12/88, version Denso				1.413.014				
All engines	01/01/89 ->, version Denso				1.413.030				

1.0				
				ENGINE
1.0	Petrol	40	11/90-12/92	CB 90

Engine	Information	A10	A20	A40	A50	A70	C10 - C30	C20	E01
All engines	version Denso				1.413.029				

1.0 GTi				
				ENGINE
1.0 GTi	Petrol	74	03/87-12/92	CB 80 T

Engine	Information	A10	A20	A40	A50	A70	C10 - C30	C20	E01
All engines	version Denso				1.413.029				

1.0i				
				ENGINE
1.0i	Petrol	0	01/88->	G102

Engine	Information	A10	A20	A40	A50	A70	C10 - C30	C20	E01
All engines	version Denso				1.413.028				
All engines							1.970.252	C10	

1.0i [USA]				
				ENGINE
1.0i [USA]	Petrol	0	01/89->	CB

Engine	Information	A10	A20	A40	A50	A70	C10 - C30	C20	E01
All engines	version Denso				1.413.029				

1.0i 12v GTti				
				ENGINE
1.0i 12v GTti	Petrol	74	11/90-02/93	CB 70

Engine	Information	A10	A20	A40	A50	A70	C10 - C30	C20	E01
All engines	version Denso				1.413.029				

1.3				
				ENGINE
1.3	Petrol	56	09/88-01/92	HC-C

Engine	Information	A10	A20	A40	A50	A70	C10 - C30	C20	E01
All engines	version Denso			1.313.258	1.413.028				
All engines							1.970.252	C10	

1.3				
				ENGINE
1.3	Petrol	66	11/90-02/93	HC-E

Engine	Information	A10	A20	A40	A50	A70	C10 - C30	C20	E01
All engines	version Denso				1.413.028				
All engines							1.970.252	C10	

A10 CONDENSER	A20 CONTACT SET	A40 DISTRIBUTOR CAP	A50 ROTOR	A70 PICK-UP
C10 COIL	C20 IGNITION MODULE	C30 ELECTRONIC IGNITION KIT	E01 IGNITION CABLE SET	





The present application list is a brief version. For the detailed information about the possibility of installation on a specific vehicle, please refer to our web-catalogue <http://catalogo.facet.eu/>

					FUNCTIONS ON THE VEHICLE												
Vehicle	alim.	kW	Date	Engine	A10	A20	A40	A50	A70	C10 - C30	C20	E01					
ENGINE																	
1.3 i	Petrol	66	06/88-12/92	HC-E													
Engine	Information				A10	A20	A40	A50	A70	C10 - C30	C20	E01					
All engines	version Denso							1.413.028									
All engines										1.970.252	C10						
ENGINE																	
1.3 i 4WD	Petrol	66	06/88-01/93	HC-E													
Engine	Information				A10	A20	A40	A50	A70	C10 - C30	C20	E01					
All engines	version Denso							1.413.028									
All engines										1.970.252	C10						
ENGINE																	
1.3i [USA]	Petrol	0	01/89->	HC-E													
Engine	Information				A10	A20	A40	A50	A70	C10 - C30	C20	E01					
All engines	version Denso						1.313.258	1.413.028									
CHARADE VI																	
ENGINE																	
1.33 16V	Petrol	73	05/11->	1NR-FE													
Engine	Information				A10	A20	A40	A50	A70	C10 - C30	C20	E01					
All engines	Charade, x 4, COIL ON PLUG									1.970.537	C10						
CUORE II																	
ENGINE																	
0.8	Petrol	29	11/89-12/90	ED 10													
Engine	Information				A10	A20	A40	A50	A70	C10 - C30	C20	E01					
All engines	version Denso						1.313.128										
All engines	->year 28/02/87, version Denso							1.413.014									
All engines	01/03/87->, version Denso							1.413.030									
ENGINE																	
0.8	Petrol	32	09/85-06/90	ED 10													
Engine	Information				A10	A20	A40	A50	A70	C10 - C30	C20	E01					
All engines	version Denso						1.313.128										
All engines	->year 28/02/87, version Denso							1.413.014									
All engines	01/03/87->, version Denso							1.413.030									
ENGINE																	
0.8 4WD	Petrol	32	09/86-10/88	ED 10													
Engine	Information				A10	A20	A40	A50	A70	C10 - C30	C20	E01					
All engines	version Denso						1.313.128										
All engines	->year 28/02/87, version Denso							1.413.014									
All engines	01/03/87->, version Denso							1.413.030									
CUORE III																	
ENGINE																	
0.8	Petrol	30	10/90-12/94	ED 10 K													
Engine	Information				A10	A20	A40	A50	A70	C10 - C30	C20	E01					
All engines	01/08/92->											1.501.436					
CUORE IV																	
ENGINE																	
0.8	Petrol	32	01/95-08/98	ED 20													
Engine	Information				A10	A20	A40	A50	A70	C10 - C30	C20	E01					
All engines	->year 30/11/96, LHD											1.501.436					
CUORE VII																	
ENGINE																	
1.0 LPG	Petrol/ Liquified Petroleum Gas (LPG)	51	09/11-12/12	1KR-FE													
Engine	Information				A10	A20	A40	A50	A70	C10 - C30	C20	E01					
All engines	x 3, COIL ON PLUG									1.970.461	C10						
DOMINO																	
ENGINE																	
0.8	Petrol	32	08/85-07/90	ED													
Engine	Information				A10	A20	A40	A50	A70	C10 - C30	C20	E01					
All engines	version Denso						1.313.128										
All engines	->year 28/02/87, version Denso							1.413.014									
All engines	01/03/87->, version Denso							1.413.030									
A10	CONDENSER	A20	CONTACT SET	A40	DISTRIBUTOR CAP	A50	ROTOR	A70	PICK-UP	C10	COIL	C20	IGNITION MODULE	C30	ELECTRONIC IGNITION KIT	E01	IGNITION CABLE SET

Vehicle	alim.	kW	Date	Engine	FUNCTIONS ON THE VEHICLE									
					A10	A20	A40	A50	A70	C10 - C30	C20	E01		
ENGINE														
0.8i	Petrol	32	08/90-10/98	ED20										
ENGINE														
Engine	Information				A10	A20	A40	A50	A70	C10 - C30	C20	E01		
All engines	01/08/92 ->												1.501.436	
FEROZA														
ENGINE														
1.6 16V	Petrol	63	10/88-12/99	HD-C										
ENGINE														
Engine	Information				A10	A20	A40	A50	A70	C10 - C30	C20	E01		
All engines	version Denso						1.313.257							
All engines	->year 31/12/95, version Denso							1.413.028						
All engines													1.501.732	
ENGINE														
1.6 16V 4x4	Petrol	63	10/88-12/99	HD-C										
ENGINE														
Engine	Information				A10	A20	A40	A50	A70	C10 - C30	C20	E01		
All engines	version Denso						1.313.257	1.413.028						
All engines													1.501.732	
ENGINE														
1.6 i 16V	Petrol	70	10/88-12/99	HD-E										
ENGINE														
Engine	Information				A10	A20	A40	A50	A70	C10 - C30	C20	E01		
All engines	->year 31/12/95, version Denso						1.313.257	1.413.028						
All engines													1.501.732	
ENGINE														
1.6 i 16V 4x4	Petrol	70	10/88-12/99	HD-E										
ENGINE														
Engine	Information				A10	A20	A40	A50	A70	C10 - C30	C20	E01		
All engines	->year 31/12/95, version Denso						1.313.257	1.413.028						
All engines													1.501.732	
ENGINE														
1.6i	Petrol	0	01/84->	--										
ENGINE														
Engine	Information				A10	A20	A40	A50	A70	C10 - C30	C20	E01		
All engines	version Denso					1.213.011HV	1.313.257							
All engines	->year 31/12/89, version Denso							1.413.014						
All engines	01/01/90 ->, version Denso							1.413.028						
All engines													1.501.732	
HIJET I														
ENGINE														
1.0	Petrol	33	06/86-12/89	CB										
ENGINE														
Engine	Information				A10	A20	A40	A50	A70	C10 - C30	C20	E01		
All engines	version Denso					1.213.011HV		1.413.014						
HIJET II														
ENGINE														
1.3 i 16V	Petrol	48	05/98-10/05	HC-E										
ENGINE														
Engine	Information				A10	A20	A40	A50	A70	C10 - C30	C20	E01		
All engines	01/05/98 ->									1.970.252	C10			
MIRA														
ENGINE														
0.8i	Petrol	32	12/94-02/97	ED20										
ENGINE														
Engine	Information				A10	A20	A40	A50	A70	C10 - C30	C20	E01		
All engines	->year 31/12/96, LHD													1.501.436
MOVE														
ENGINE														
0.8	Petrol	31	01/97-11/99	ED 20										
ENGINE														
Engine	Information				A10	A20	A40	A50	A70	C10 - C30	C20	E01		
All engines														1.501.436
ROCKY														
ENGINE														
2.0i [USA]	Petrol	0	01/89->	--										
ENGINE														
Engine	Information				A10	A20	A40	A50	A70	C10 - C30	C20	E01		
All engines	version Denso						1.313.257	1.413.028						
All engines													1.501.732	

A10	CONDENSER	A20	CONTACT SET	A40	DISTRIBUTOR CAP	A50	ROTOR	A70	PICK-UP
C10	COIL	C20	IGNITION MODULE	C30	ELECTRONIC IGNITION KIT	E01	IGNITION CABLE SET		

The present application list is a brief version. For the detailed information about the possibility of installation on a specific vehicle, please refer to our web-catalogue <http://catalogo.facet.eu/>

					FUNCTIONS ON THE VEHICLE							
Vehicle	alim.	kW	Date	Engine								
					A10	A20	A40	A50	A70	C10 - C30	C20	E01

SPORTTRACK				ENGINE
1.6 16v 4x4	Petrol	62	10/88-08/93	HD-C

Engine	Information	A10	A20	A40	A50	A70	C10 - C30	C20	E01
All engines	version Denso			1.313.257	1.413.028				
All engines									1.501.732

A10	CONDENSER	A20	CONTACT SET	A40	DISTRIBUTOR CAP	A50	ROTOR	A70	PICK-UP
C10	COIL	C20	IGNITION MODULE	C30	ELECTRONIC IGNITION KIT	E01	IGNITION CABLE SET		

Vehicle	alim.	kW	Date	Engine	FUNCTIONS ON THE VEHICLE							
					 A10	 A20	 A40	 A50	 A70	 C10 - C30	 C20	 E01

2.8 - 5.3

				ENGINE
Sovereign 2.8	Petrol	110	10/69-05/75	--

Engine	Information	A10	A20	A40	A50	A70	C10 - C30	C20	E01
All engines					1.428.007				

				ENGINE
Sovereign 4.2	Petrol	127	09/73-03/79	--

Engine	Information	A10	A20	A40	A50	A70	C10 - C30	C20	E01
All engines					1.428.007				

				ENGINE
Sovereign 4.2	Petrol	137	10/69-09/73	--

Engine	Information	A10	A20	A40	A50	A70	C10 - C30	C20	E01
All engines					1.428.007				

A10	CONDENSER	A20	CONTACT SET	A40	DISTRIBUTOR CAP	A50	ROTOR	A70	PICK-UP
C10	COIL	C20	IGNITION MODULE	C30	ELECTRONIC IGNITION KIT	E01	IGNITION CABLE SET		

The present application list is a brief version. For the detailed information about the possibility of installation on a specific vehicle, please refer to our web-catalogue <http://catalogo.facet.eu/>

Vehicle	alim.	kW	Date	Engine	FUNCTIONS ON THE VEHICLE							
					A10	A20	A40	A50	A70	C10 - C30	C20	E01
DS 4												
PureTech 180	Petrol	133	10/21->	5GF (EP6FADTXD)								
Engine	Information			A10	A20	A40	A50	A70	C10 - C30	C20	E01	
All engines	x 4, COIL ON PLUG								1.970.475	C10		
DS 5												
1.6 THP 165	Petrol	121	07/15-12/18	5GZ (EP6FDT)								
Engine	Information			A10	A20	A40	A50	A70	C10 - C30	C20	E01	
All engines	x 4, COIL ON PLUG								1.970.475	C10		
1.6 THP 210	Petrol	155	04/15-12/18	5GM (EP6FDTX)								
Engine	Information			A10	A20	A40	A50	A70	C10 - C30	C20	E01	
All engines	x 4, COIL ON PLUG								1.970.475	C10		
DS 7												
1.6 PureTech 180	Petrol	133	04/18->	5GF (EP6FADTXD)								
Engine	Information			A10	A20	A40	A50	A70	C10 - C30	C20	E01	
All engines	x 4, COIL ON PLUG								1.970.475	C10		
1.6 PureTech 225	Petrol	165	09/17->	5GC (EP6FADTX)								
Engine	Information			A10	A20	A40	A50	A70	C10 - C30	C20	E01	
All engines	x 4, COIL ON PLUG								1.970.475	C10		
E-TENSE	Petrol/ Electric	133	10/19->	5GQ (EP6FADTXHP)								
Engine	Information			A10	A20	A40	A50	A70	C10 - C30	C20	E01	
All engines	x 4, COIL ON PLUG								1.970.475	C10		
E-TENSE 225	Petrol/ Electric	133	05/21->	5GQ (EP6FADTXHP)								
Engine	Information			A10	A20	A40	A50	A70	C10 - C30	C20	E01	
All engines	x 4, COIL ON PLUG								1.970.475	C10		
E-TENSE 225	Petrol/ Electric	165	05/21->	5GQ (EP6FADTXHP)								
Engine	Information			A10	A20	A40	A50	A70	C10 - C30	C20	E01	
All engines	x 4, COIL ON PLUG								1.970.475	C10		
E-TENSE 4x4	Petrol/ Electric	147	05/19->	5GB (EP6FADTXHP)								
Engine	Information			A10	A20	A40	A50	A70	C10 - C30	C20	E01	
All engines	x 4, COIL ON PLUG								1.970.475	C10		
E-TENSE 4x4	Petrol/ Electric	221	05/19->	5GB (EP6FADTXHP)								
Engine	Information			A10	A20	A40	A50	A70	C10 - C30	C20	E01	
All engines	x 4, COIL ON PLUG								1.970.475	C10		
DS3												
1.2 THP 110 / PureTech 110	Petrol	81	04/15-07/19	HNP (EB2ADT), HNZ (EB2DT)								
Engine	Information			A10	A20	A40	A50	A70	C10 - C30	C20	E01	
All engines	x 3, COIL ON PLUG								1.970.620	C10		
1.2 THP 130	Petrol	96	09/15-07/19	HNY (EB2DTS)								
Engine	Information			A10	A20	A40	A50	A70	C10 - C30	C20	E01	
All engines	x 3, COIL ON PLUG								1.970.620	C10		
1.2 VTi 82	Petrol	60	04/15-07/19	HMZ (EB2), HMZ (EB2F)								
Engine	Information			A10	A20	A40	A50	A70	C10 - C30	C20	E01	
All engines	x 3, COIL ON PLUG								1.970.609	C10		

A10 CONDENSER	A20 CONTACT SET	A40 DISTRIBUTOR CAP	A50 ROTOR	A70 PICK-UP
C10 COIL	C20 IGNITION MODULE	C30 ELECTRONIC IGNITION KIT	E01 IGNITION CABLE SET	

Vehicle	alim.	kW	Date	Engine	FUNCTIONS ON THE VEHICLE								
					A10	A20	A40	A50	A70	C10 - C30	C20	E01	
ENGINE													
1.6 THP	Petrol	110	07/15-07/19	5GW (EP6FDT), 5GX (EP6FDTMD)									
Engine	Information				A10	A20	A40	A50	A70	C10 - C30	C20	E01	
All engines	x 4, COIL ON PLUG									1.970.475	C10		
ENGINE													
1.6 THP	Petrol	120	07/15-07/19	5GZ (EP6FDT)									
Engine	Information				A10	A20	A40	A50	A70	C10 - C30	C20	E01	
All engines	x 4, COIL ON PLUG									1.970.475	C10		
ENGINE													
1.6 THP 165	Petrol	121	07/15-07/19	5GZ (EP6FDT)									
Engine	Information				A10	A20	A40	A50	A70	C10 - C30	C20	E01	
All engines	x 4, COIL ON PLUG									1.970.475	C10		
ENGINE													
1.6 THP 208	Petrol	153	09/15-07/19	5GR (EP6FDTX)									
Engine	Information				A10	A20	A40	A50	A70	C10 - C30	C20	E01	
All engines	x 4, COIL ON PLUG									1.970.475	C10		
DS4 / DS4 CROSSBACK													
ENGINE													
1.2 THP 130	Petrol	96	07/15-12/18	HNY (EB2DTS)									
Engine	Information				A10	A20	A40	A50	A70	C10 - C30	C20	E01	
All engines	x 3, COIL ON PLUG									1.970.620	C10		
ENGINE													
1.6 THP 150	Petrol	110	10/16-12/18	5FE (EP6CDTMD)									
Engine	Information				A10	A20	A40	A50	A70	C10 - C30	C20	E01	
All engines	x 4, COIL ON PLUG									1.970.475	C10		
ENGINE													
1.6 THP 160	Petrol	120	07/15-12/18	5FM (EP6CDTM)									
Engine	Information				A10	A20	A40	A50	A70	C10 - C30	C20	E01	
All engines	x 4, COIL ON PLUG									1.970.475	C10		
ENGINE													
1.6 THP 165	Petrol	121	07/15-12/18	5GZ (EP6FDT)									
Engine	Information				A10	A20	A40	A50	A70	C10 - C30	C20	E01	
All engines	x 4, COIL ON PLUG									1.970.475	C10		
ENGINE													
1.6 THP 210	Petrol	155	07/15-12/18	5GM (EP6FDTX)									
Engine	Information				A10	A20	A40	A50	A70	C10 - C30	C20	E01	
All engines	x 4, COIL ON PLUG									1.970.475	C10		

A10 CONDENSER	A20 CONTACT SET	A40 DISTRIBUTOR CAP	A50 ROTOR	A70 PICK-UP
C10 COIL	C20 IGNITION MODULE	C30 ELECTRONIC IGNITION KIT	E01 IGNITION CABLE SET	

					FUNCTIONS ON THE VEHICLE								
Vehicle	alim.	kW	Date	Engine									
124													
1200	Petrol	44	07/66-10/73	124 A.000									
ENGINE													
Engine	Information				A10	A20	A40	A50	A70	C10 - C30	C20	E01	
All engines	version Ducellier					1.215.056	1.315.059	1.415.083R					
All engines	version Marelli					1.230.132	1.330.069	1.430.054R					
All engines										1.970.101D	C10		
1400 Special													
1400 Special	Petrol	51	12/68-12/72	124 B2.000									
ENGINE													
Engine	Information				A10	A20	A40	A50	A70	C10 - C30	C20	E01	
All engines	version Ducellier					1.215.056	1.315.059	1.415.083R					
All engines	version Marelli					1.230.132	1.330.069	1.430.054R					
All engines										1.970.101D	C10		
1600 Special T													
1600 Special T	Petrol	70	01/73-07/75	132 AC.000									
ENGINE													
Engine	Information				A10	A20	A40	A50	A70	C10 - C30	C20	E01	
All engines	version Ducellier					1.215.056	1.315.059	1.415.083R					
All engines	version Marelli					1.230.132	1.330.069	1.430.054R					
All engines										1.970.101D	C10		
125													
1.6	Petrol	66	07/67-03/74	125 A.000									
ENGINE													
Engine	Information				A10	A20	A40	A50	A70	C10 - C30	C20	E01	
All engines								1.430.037					
126													
600	Petrol	17	09/72-06/77	126 A.000									
ENGINE													
Engine	Information				A10	A20	A40	A50	A70	C10 - C30	C20	E01	
All engines	version Marelli					1.230.120	1.330.086	1.430.040					
All engines										1.970.101D	C10	1.500.507	
650													
650	Petrol	17	07/77-09/87	126 A1.048									
ENGINE													
Engine	Information				A10	A20	A40	A50	A70	C10 - C30	C20	E01	
All engines	version Marelli					1.230.150M							
All engines												1.500.432	
700													
700	Petrol	19	09/87-06/96	126 A2.000, 126 A2.048									
ENGINE													
Engine	Information				A10	A20	A40	A50	A70	C10 - C30	C20	E01	
All engines	version Marelli				1.130.128								
All engines												1.500.351	
127													
0.9	Petrol	29	06/71-05/83	100 GL.048									
ENGINE													
Engine	Information				A10	A20	A40	A50	A70	C10 - C30	C20	E01	
All engines	version Ducellier				1.115.023	1.215.101	1.315.058	1.415.083R					
All engines	version Marelli				1.130.117	1.230.142		1.430.042R					
All engines	version Fems					1.217.020	1.317.016	1.417.052R					
All engines										1.970.101D	C10	1.500.429	
0.9													
0.9	Petrol	33	09/71-12/84	100 GL.000									
ENGINE													
Engine	Information				A10	A20	A40	A50	A70	C10 - C30	C20	E01	
All engines	version Marelli					1.230.139		1.430.037R					
All engines										1.970.101D	C10	1.500.429	
1.0													
1.0	Petrol	37	01/77-12/86	127 A.000									
ENGINE													
Engine	Information				A10	A20	A40	A50	A70	C10 - C30	C20	E01	
All engines	version Marelli				1.130.117	1.230.142	1.330.090	1.430.042R					
All engines										1.970.101D	C10		

A10 CONDENSER	A20 CONTACT SET	A40 DISTRIBUTOR CAP	A50 ROTOR	A70 PICK-UP
C10 COIL	C20 IGNITION MODULE	C30 ELECTRONIC IGNITION KIT	E01 IGNITION CABLE SET	

Vehicle	alim.	kW	Date	Engine	FUNCTIONS ON THE VEHICLE							
					A10	A20	A40	A50	A70	C10 - C30	C20	E01

128

				ENGINE
1.1	Petrol	40	03/69-12/84	128 A.000

Engine	Information	A10	A20	A40	A50	A70	C10 - C30	C20	E01
All engines	version Ducellier	1.115.023	1.215.056HV	1.315.049	1.415.083R				
All engines	version Marelli		1.230.142	1.330.081	1.430.036R				
All engines							1.970.101D	C10	

131

				ENGINE
1.3 Mirafiori	Petrol	40	10/74-09/81	131 A6.000

Engine	Information	A10	A20	A40	A50	A70	C10 - C30	C20	E01
All engines	version Ducellier	1.115.023	1.215.056HV	1.315.059	1.415.083R				
All engines	01/01/76 ->, version Marelli	1.130.117	1.230.142		1.430.042R				
All engines	version Femsa		1.217.020		1.417.052				
All engines	->year 31/12/75, version Marelli		1.230.139		1.430.037R				
All engines					1.430.037		1.970.101D	C10	

1.3 Super Mirafiori

Engine	Information	A10	A20	A40	A50	A70	C10 - C30	C20	E01
All engines					1.430.037				

1.4 Mirafiori

Engine	Information	A10	A20	A40	A50	A70	C10 - C30	C20	E01
All engines					1.430.037				

1.6

Engine	Information	A10	A20	A40	A50	A70	C10 - C30	C20	E01
All engines					1.430.037				

1.6 Super

Engine	Information	A10	A20	A40	A50	A70	C10 - C30	C20	E01
All engines					1.430.037				

2.0 Super

Engine	Information	A10	A20	A40	A50	A70	C10 - C30	C20	E01
All engines					1.430.037				

132

				ENGINE
1.6	Petrol	65	05/77-09/82	132 C.000

Engine	Information	A10	A20	A40	A50	A70	C10 - C30	C20	E01
All engines	version Ducellier	1.115.023	1.215.056HV	1.315.059	1.415.091				
All engines	version Marelli	1.130.117	1.230.142	1.330.090	1.430.042R				
All engines	version Femsa		1.217.020		1.417.052R				
All engines	+air conditioning, version Marelli		1.230.139						
All engines	+air conditioning, RHD, version Marelli				1.430.037R				
All engines	+air conditioning, LHD, version Marelli				1.430.041				
All engines							1.970.101D	C10	

2.0

Engine	Information	A10	A20	A40	A50	A70	C10 - C30	C20	E01
All engines	version Bosch			1.306.079	1.406.025R				
All engines	+air conditioning, LHD, version Marelli			1.330.093					
All engines	version Marelli				1.430.054R	1.930.161/1			









242

				ENGINE
1.6	Petrol	46	10/75-07/82	124 B3.000

Engine	Information	A10	A20	A40	A50	A70	C10 - C30	C20	E01
All engines	version Ducellier	1.115.023	1.215.055	1.315.045					
All engines	version Marelli		1.230.139						
All engines							1.970.101D	C10	

A10	CONDENSER	A20	CONTACT SET	A40	DISTRIBUTOR CAP	A50	ROTOR	A70	PICK-UP
C10	COIL	C20	IGNITION MODULE	C30	ELECTRONIC IGNITION KIT	E01	IGNITION CABLE SET		

The present application list is a brief version. For the detailed information about the possibility of installation on a specific vehicle, please refer to our web-catalogue <http://catalogo.facet.eu/>



					FUNCTIONS ON THE VEHICLE							
Vehicle	alim.	kW	Date	Engine	 A10	 A20	 A40	 A50	 A70	 C10 - C30	 C20	 E01
500												
0.5	Petrol	11	01/60-12/66	ENGINE 120.000								
Engine	Information				A10	A20	A40	A50	A70	C10 - C30	C20	E01
All engines	version Marelli					1.230.120	1.330.059	1.430.029				
All engines										1.970.101D	C10	
ENGINE												
0.5	Petrol	13	01/65-12/75	ENGINE 110 F.000, 120.000								
Engine	Information				A10	A20	A40	A50	A70	C10 - C30	C20	E01
All engines	version Marelli					1.230.120	1.330.059	1.430.029				
All engines										1.970.101D	C10	
ENGINE												
0.6	Petrol	13	08/68-01/76	ENGINE 111A000								
Engine	Information				A10	A20	A40	A50	A70	C10 - C30	C20	E01
All engines	version Marelli					1.230.120	1.330.086	1.430.029				
All engines										1.970.101D	C10	
ENGINE												
0.9	Petrol	44	12/13->	ENGINE 312 A4.000, 312 A6.000								
Engine	Information				A10	A20	A40	A50	A70	C10 - C30	C20	E01
Eng. 312 A4.000	naturally Asp. Eng., Qty: 2									1.970.442	C10	
Eng. 312 A6.000	x 2, COIL ON PLUG, incl. spark plug connector									1.970.442	C10	
ENGINE												
0.9	Petrol	48	09/12->	ENGINE 312 A4.000								
Engine	Information				A10	A20	A40	A50	A70	C10 - C30	C20	E01
All engines	x 2, COIL ON PLUG, incl. spark plug connector									1.970.442	C10	
ENGINE												
1.2	Petrol	51	07/07->	ENGINE 169 A4.000								
Engine	Information				A10	A20	A40	A50	A70	C10 - C30	C20	E01
All engines	x 1, D.I.S.									1.970.423	C10	
All engines												1.499.170
ENGINE												
1.2 LPG	Petrol/ Liquified Petroleum Gas (LPG)	51	12/10->	ENGINE 169 A4.000								
Engine	Information				A10	A20	A40	A50	A70	C10 - C30	C20	E01
All engines	x 1, D.I.S.									1.970.423	C10	
ENGINE												
1.4	Petrol	74	10/07->	ENGINE 169 A3.000								
Engine	Information				A10	A20	A40	A50	A70	C10 - C30	C20	E01
All engines	x 4, COIL ON PLUG, incl. spark plug connector									1.970.442	C10	
ENGINE												
1.4	Petrol	75	09/08->	ENGINE 169 A3.000								
Engine	Information				A10	A20	A40	A50	A70	C10 - C30	C20	E01
All engines	x 4, COIL ON PLUG, incl. spark plug connector									1.970.442	C10	
500 C												
0.9	Petrol	44	12/13->	ENGINE 312 A6.000								
Engine	Information				A10	A20	A40	A50	A70	C10 - C30	C20	E01
All engines	x 2, COIL ON PLUG, incl. spark plug connector									1.970.442	C10	
ENGINE												
0.9	Petrol	48	09/12->	ENGINE 312 A4.000								
Engine	Information				A10	A20	A40	A50	A70	C10 - C30	C20	E01
All engines	x 2, COIL ON PLUG, incl. spark plug connector									1.970.442	C10	
ENGINE												
1.2	Petrol	51	09/09->	ENGINE 169 A4.000								
Engine	Information				A10	A20	A40	A50	A70	C10 - C30	C20	E01
All engines	x 1, D.I.S.									1.970.423	C10	
All engines												1.499.170

A10 CONDENSER	A20 CONTACT SET	A40 DISTRIBUTOR CAP	A50 ROTOR	A70 PICK-UP
C10 COIL	C20 IGNITION MODULE	C30 ELECTRONIC IGNITION KIT	E01 IGNITION CABLE SET	

Vehicle	alim.	kW	Date	Engine	FUNCTIONS ON THE VEHICLE										
					A10	A20	A40	A50	A70	C10 - C30	C20	E01			
ENGINE															
1.4	Petrol	74	09/09->	169 A3.000											
Engine					A10	A20	A40	A50	A70	C10 - C30	C20	E01			
Information										1.970.442	C10				
All engines					x 4, COIL ON PLUG, incl. spark plug connector										
ENGINE															
1.4	Petrol	75	09/11->	169 A3.000, EAB											
Engine					A10	A20	A40	A50	A70	C10 - C30	C20	E01			
Information										1.970.442	C10				
Eng. 169 A3.000					x 4, COIL ON PLUG, incl. spark plug connector										
Eng. EAB					Qty: 4							1.970.442	C10		
500 MY12															
ENGINE															
0.9	Petrol	48	01/12->	--											
Engine					A10	A20	A40	A50	A70	C10 - C30	C20	E01			
Information										1.970.442	C10				
All engines					naturally Asp. Eng., Qty: 2										
ENGINE															
0.9	Petrol	62	01/12->	--											
Engine					A10	A20	A40	A50	A70	C10 - C30	C20	E01			
Information										1.970.442	C10				
All engines					naturally Asp. Eng., Qty: 2										
ENGINE															
0.9	Petrol	77	01/12->	--											
Engine					A10	A20	A40	A50	A70	C10 - C30	C20	E01			
Information										1.970.442	C10				
All engines					naturally Asp. Eng., Qty: 2										
ENGINE															
1.2	Petrol	51	01/12->	--											
Engine					A10	A20	A40	A50	A70	C10 - C30	C20	E01			
Information										1.970.423	C10		1.499.170		
All engines															
ENGINE															
1.4	Petrol	74	01/12->	--											
Engine					A10	A20	A40	A50	A70	C10 - C30	C20	E01			
Information										1.970.442	C10				
All engines					Qty: 4										
500 MY15															
ENGINE															
0.9	Petrol	48	01/15->	--											
Engine					A10	A20	A40	A50	A70	C10 - C30	C20	E01			
Information										1.970.442	C10				
All engines					naturally Asp. Eng., Qty: 2										
ENGINE															
0.9	Petrol	62	01/15->	--											
Engine					A10	A20	A40	A50	A70	C10 - C30	C20	E01			
Information										1.970.442	C10				
All engines					naturally Asp. Eng., Qty: 2										
ENGINE															
0.9	Petrol	77	01/15->	--											
Engine					A10	A20	A40	A50	A70	C10 - C30	C20	E01			
Information										1.970.442	C10				
All engines					naturally Asp. Eng., Qty: 2										
ENGINE															
1.2	Petrol	0	01/15->	--											
Engine					A10	A20	A40	A50	A70	C10 - C30	C20	E01			
Information										1.970.423	C10		1.499.170		
All engines															
ENGINE															
1.2 LPG	Petrol	0	01/15->	--											
Engine					A10	A20	A40	A50	A70	C10 - C30	C20	E01			
Information										1.970.423	C10		1.499.170		
All engines															
ENGINE															
1.4	Petrol	0	01/15->	--											
Engine					A10	A20	A40	A50	A70	C10 - C30	C20	E01			
Information										1.970.442	C10				
All engines					Qty: 4										
500L															
ENGINE															
1.4	Petrol	70	09/12->	843 A1.000											
Engine					A10	A20	A40	A50	A70	C10 - C30	C20	E01			
Information										1.970.442	C10				
All engines					x 4, COIL ON PLUG, incl. spark plug connector										

A10 CONDENSER	A20 CONTACT SET	A40 DISTRIBUTOR CAP	A50 ROTOR	A70 PICK-UP
C10 COIL	C20 IGNITION MODULE	C30 ELECTRONIC IGNITION KIT	E01 IGNITION CABLE SET	

The present application list is a brief version. For the detailed information about the possibility of installation on a specific vehicle, please refer to our web-catalogue <http://catalogo.facet.eu/>

					FUNCTIONS ON THE VEHICLE							
Vehicle	alim.	kW	Date	Engine								

500X

					ENGINE
1.4	Petrol	100	09/14->	552 63 624	

Engine	Information	A10	A20	A40	A50	A70	C10 - C30	C20	E01
All engines	x 4, COIL ON PLUG						1.970.549	C10	

					ENGINE
1.4	Petrol	103	09/14->	552 63 624	

Engine	Information	A10	A20	A40	A50	A70	C10 - C30	C20	E01
All engines	x 4, COIL ON PLUG						1.970.549	C10	

					ENGINE
1.4 4x4	Petrol	120	02/15->	552 63 623	

Engine	Information	A10	A20	A40	A50	A70	C10 - C30	C20	E01
All engines	x 4, version 1, COIL ON PLUG						1.970.549	C10	

					ENGINE
1.4 LPG	Petrol/ Liquified Petroleum Gas (LPG)	88	03/17->	552 77 701	

Engine	Information	A10	A20	A40	A50	A70	C10 - C30	C20	E01
All engines	01/07/17 ->, x 4, COIL ON PLUG						1.970.549	C10	

600

					ENGINE
0.6	Petrol	15	03/55-05/61	--	

Engine	Information	A10	A20	A40	A50	A70	C10 - C30	C20	E01
All engines	version Marelli		1.230.120		1.430.029				
All engines							1.970.101D	C10	

850

					ENGINE
0.8	Petrol	25	07/64-10/72	100 G.000	

Engine	Information	A10	A20	A40	A50	A70	C10 - C30	C20	E01
All engines	version Ducellier		1.215.056	1.315.049	1.415.083R				
All engines	version Marelli		1.230.132	1.330.069	1.430.037R				
All engines					1.430.037		1.970.101D	C10	

					ENGINE
0.8	Petrol	27	07/64-10/72	100 G.002	

Engine	Information	A10	A20	A40	A50	A70	C10 - C30	C20	E01
All engines					1.430.037				

					ENGINE
0.8 Special	Petrol	35	03/68-10/72	100 GB.000	

Engine	Information	A10	A20	A40	A50	A70	C10 - C30	C20	E01
All engines					1.430.037				

					ENGINE
0.9 Sport	Petrol	38	02/68-12/72	--, 100 GL.040	

Engine	Information	A10	A20	A40	A50	A70	C10 - C30	C20	E01
All engines					1.430.037				

ARGENTA

					ENGINE
1600	Petrol	72	04/81-12/85	132 D.000	

Engine	Information	A10	A20	A40	A50	A70	C10 - C30	C20	E01
All engines	->year 01/05/82, version Marelli	1.130.117	1.230.142	1.330.090	1.430.042R				
All engines	01/05/82 ->, version Marelli		1.230.139		1.430.041				
All engines							1.970.101D	C10	

					ENGINE
1600 i.e	Petrol	66	04/81-12/85	132 D.000	

Engine	Information	A10	A20	A40	A50	A70	C10 - C30	C20	E01
All engines	->year 01/05/82, version Marelli	1.130.117	1.230.142	1.330.090	1.430.042R				
All engines	01/05/82 ->, version Marelli		1.230.139		1.430.041				
All engines							1.970.101D	C10	

					ENGINE
2000	Petrol	83	06/78-12/85	132 D1.000	









Engine	Information	A10	A20	A40	A50	A70	C10 - C30	C20	E01
All engines	version Bosch			1.306.079	1.406.025R				

A10 CONDENSER	A20 CONTACT SET	A40 DISTRIBUTOR CAP	A50 ROTOR	A70 PICK-UP
C10 COIL	C20 IGNITION MODULE	C30 ELECTRONIC IGNITION KIT	E01 IGNITION CABLE SET	

Vehicle	alim.	kW	Date	Engine	FUNCTIONS ON THE VEHICLE							
					A10	A20	A40	A50	A70	C10 - C30	C20	E01
2000					ENGINE							
Petrol	83	06/78-12/85	132 D1.000		A10	A20	A40	A50	A70	C10 - C30	C20	E01
Engine	Information				A10	A20	A40	A50	A70	C10 - C30	C20	E01
All engines	version Marelli						1.330.082	1.430.054R				
All engines	+automatic transmission, version Marelli						1.330.093	1.430.037R				
2000 i.e.					ENGINE							
Petrol	90	06/81-07/86	132 C3.000		A10	A20	A40	A50	A70	C10 - C30	C20	E01
Engine	Information				A10	A20	A40	A50	A70	C10 - C30	C20	E01
All engines	version Marelli						1.330.093	1.430.054R				
All engines										1.970.103	C10	
BARCETTA					ENGINE							
Petrol	96	04/95-05/05	183 A1.000, 188 A6.000		A10	A20	A40	A50	A70	C10 - C30	C20	E01
Engine	Information				A10	A20	A40	A50	A70	C10 - C30	C20	E01
All engines	01/06/98 ->, x 4, COIL ON PLUG, x 4, COIL ON PLUG, incl. spark plug connector, incl. spark plug connector									1.970.384	C10	
BRAVA					ENGINE							
Petrol	64	12/98-12/02	182 B2.000		A10	A20	A40	A50	A70	C10 - C30	C20	E01
Engine	Information				A10	A20	A40	A50	A70	C10 - C30	C20	E01
All engines										1.970.168	C10	1.501.505
1.2 16V 80					ENGINE							
Petrol	59	10/00-10/01	188 A5.000		A10	A20	A40	A50	A70	C10 - C30	C20	E01
Engine	Information				A10	A20	A40	A50	A70	C10 - C30	C20	E01
All engines	x 1, D.I.S., connector type, saw teeth									1.970.168	C10	
All engines												1.501.505
1.2 16V 80					ENGINE							
Petrol	60	12/98-12/02	182 B2.000		A10	A20	A40	A50	A70	C10 - C30	C20	E01
Engine	Information				A10	A20	A40	A50	A70	C10 - C30	C20	E01
All engines	x 1, D.I.S., connector type, saw teeth									1.970.168	C10	
All engines												1.501.505
1.4					ENGINE							
Petrol	55	10/95-10/01	182 A5.000		A10	A20	A40	A50	A70	C10 - C30	C20	E01
Engine	Information				A10	A20	A40	A50	A70	C10 - C30	C20	E01
All engines	x 1, D.I.S., connector type, saw teeth									1.970.168	C10	
All engines												1.501.363
1.4 12 V					ENGINE							
Petrol	59	10/95-08/98	182 A3.000		A10	A20	A40	A50	A70	C10 - C30	C20	E01
Engine	Information				A10	A20	A40	A50	A70	C10 - C30	C20	E01
All engines	x 1, D.I.S., connector type, saw teeth									1.970.168	C10	
All engines												1.501.363
1.6 16V					ENGINE							
Petrol	66	10/95-10/01	182 A6.000		A10	A20	A40	A50	A70	C10 - C30	C20	E01
Engine	Information				A10	A20	A40	A50	A70	C10 - C30	C20	E01
All engines	x 1, D.I.S., connector type, saw teeth									1.970.345	C10	
All engines												1.501.503
1.6 16V					ENGINE							
Petrol	76	10/95-12/02	182 A4.000, 182 A4.027, 182 B6.000		A10	A20	A40	A50	A70	C10 - C30	C20	E01
Engine	Information				A10	A20	A40	A50	A70	C10 - C30	C20	E01
Eng. 182 A4.000, 182 B6.000	x 1, D.I.S., connector type, saw teeth									1.970.345	C10	
Eng. 182 A4.027										1.970.345	C10	
All engines												1.501.503
BRAVO I					ENGINE							
Petrol	59	10/00-10/01	188 A5.000		A10	A20	A40	A50	A70	C10 - C30	C20	E01
Engine	Information				A10	A20	A40	A50	A70	C10 - C30	C20	E01
All engines	x 1, D.I.S., connector type, saw teeth									1.970.168	C10	
All engines												1.501.505
1.2 16V 80					ENGINE							
Petrol	60	12/98-10/00	182 B2.000		A10	A20	A40	A50	A70	C10 - C30	C20	E01
Engine	Information				A10	A20	A40	A50	A70	C10 - C30	C20	E01
All engines	x 1, D.I.S., connector type, saw teeth									1.970.168	C10	

A10 CONDENSER	A20 CONTACT SET	A40 DISTRIBUTOR CAP	A50 ROTOR	A70 PICK-UP
C10 COIL	C20 IGNITION MODULE	C30 ELECTRONIC IGNITION KIT	E01 IGNITION CABLE SET	

The present application list is a brief version. For the detailed information about the possibility of installation on a specific vehicle, please refer to our web-catalogue <http://catalogo.facet.eu/>

				FUNCTIONS ON THE VEHICLE													
Vehicle	alim.	kW	Date	Engine													
				ENGINE													
1.2 16V 80	Petrol	60	12/98-10/00	182 B2.000													
				ENGINE													
Engine	Information				A10	A20	A40	A50	A70	C10 - C30	C20	E01					
All engines												1.501.505					
				ENGINE													
1.2 16V 80	Petrol	64	12/98-10/01	182 B2.000													
				ENGINE													
Engine	Information				A10	A20	A40	A50	A70	C10 - C30	C20	E01					
All engines										1.970.168	C10	1.501.505					
				ENGINE													
1.4	Petrol	55	10/95-10/01	182 A5.000													
				ENGINE													
Engine	Information				A10	A20	A40	A50	A70	C10 - C30	C20	E01					
All engines	x 1, D.I.S., connector type, saw teeth									1.970.168	C10						
All engines												1.501.363					
				ENGINE													
1.4	Petrol	59	10/95-10/01	182 A3.000													
				ENGINE													
Engine	Information				A10	A20	A40	A50	A70	C10 - C30	C20	E01					
All engines	x 1, D.I.S., connector type, saw teeth									1.970.168	C10						
All engines												1.501.363					
				ENGINE													
1.6	Petrol	76	09/00-10/01	182 B6.000													
				ENGINE													
Engine	Information				A10	A20	A40	A50	A70	C10 - C30	C20	E01					
All engines	x 1, D.I.S., connector type, saw teeth									1.970.345	C10						
All engines												1.501.503					
				ENGINE													
1.6 16V	Petrol	66	10/95-10/01	182 A6.000													
				ENGINE													
Engine	Information				A10	A20	A40	A50	A70	C10 - C30	C20	E01					
All engines	x 1, D.I.S., connector type, saw teeth									1.970.345	C10						
All engines												1.501.503					
				ENGINE													
1.6 16V	Petrol	76	03/96-10/01	178 A8.011, 182 A4.000													
				ENGINE													
Engine	Information				A10	A20	A40	A50	A70	C10 - C30	C20	E01					
Eng. 178 A8.011										1.970.345	C10						
Eng. 182 A4.000	x 1, D.I.S., connector type, saw teeth									1.970.345	C10						
All engines												1.501.503					
				ENGINE													
1.8 GT	Petrol	83	10/95-10/01	182 A2.000													
				ENGINE													
Engine	Information				A10	A20	A40	A50	A70	C10 - C30	C20	E01					
All engines	01/08/99 ->, ch. 4873622 ->, x 4, COIL ON PLUG, incl. spark plug connector									1.970.384	C10						
				ENGINE													
2.0 HGT 20V	Petrol	108	10/95-07/98	182 A1.000													
				ENGINE													
Engine	Information				A10	A20	A40	A50	A70	C10 - C30	C20	E01					
All engines	x 5, COIL ON PLUG, incl. spark plug connector									1.970.314	C10						
				BRAVO II													
				ENGINE													
1.4	Petrol	66	04/07-12/14	192 B2.000													
				ENGINE													
Engine	Information				A10	A20	A40	A50	A70	C10 - C30	C20	E01					
All engines	x 4, COIL ON PLUG, incl. spark plug connector									1.970.442	C10						
				ENGINE													
1.4 16V	Petrol	103	01/10->	--, 198 A7.000													
				ENGINE													
Engine	Information				A10	A20	A40	A50	A70	C10 - C30	C20	E01					
Eng. --	Qty: 4									1.970.549	C10						
Eng. 198 A7.000	x 4, COIL ON PLUG									1.970.549	C10						
				ENGINE													
1.4 16V	Petrol	70	04/07->	--													
				ENGINE													
Engine	Information				A10	A20	A40	A50	A70	C10 - C30	C20	E01					
All engines	naturally Asp. Eng., Qty: 4									1.970.442	C10						
All engines	turbo/Interc., Qty: 4									1.970.549	C10						
				ENGINE													
1.4 LPG	Petrol	66	01/10->	--													
				ENGINE													
Engine	Information				A10	A20	A40	A50	A70	C10 - C30	C20	E01					
All engines	Qty: 4									1.970.442	C10						
				FUNCTIONS ON THE VEHICLE													
A10	CONDENSER	A20	CONTACT SET	A40	DISTRIBUTOR CAP	A50	ROTOR	A70	PICK-UP	C10	COIL	C20	IGNITION MODULE	C30	ELECTRONIC IGNITION KIT	E01	IGNITION CABLE SET

Vehicle	alim.	kW	Date	Engine	FUNCTIONS ON THE VEHICLE									
					A10	A20	A40	A50	A70	C10 - C30	C20	E01		
ENGINE														
1.4 LPG	Petrol	66	01/10->	--										
Engine	Information				A10	A20	A40	A50	A70	C10 - C30	C20	E01		
All engines	x 4, COIL ON PLUG, incl. spark plug connector									1.970.442	C10			
ENGINE														
1.4 T-Jet	Petrol	110	09/07-12/14	198 A1.000										
Engine	Information				A10	A20	A40	A50	A70	C10 - C30	C20	E01		
All engines	naturally Asp. Eng., Qty: 4									1.970.442	C10			
ENGINE														
1.4 T-Jet	Petrol	88	10/07-12/14	198 A4.000										
Engine	Information				A10	A20	A40	A50	A70	C10 - C30	C20	E01		
All engines	naturally Asp. Eng., Qty: 4									1.970.442	C10			
All engines	x 4, COIL ON PLUG, incl. spark plug connector									1.970.442	C10			
CINQUECENTO														
ENGINE														
0.7	Petrol	23	12/91-01/96	170 A.000										
Engine	Information				A10	A20	A40	A50	A70	C10 - C30	C20	E01		
All engines										1.970.146	C10			
ENGINE														
0.7 i	Petrol	22	07/94-01/98	170 A.046										
Engine	Information				A10	A20	A40	A50	A70	C10 - C30	C20	E01		
All engines										1.970.146	C10			
ENGINE														
0.9	Petrol	30	07/91-12/93	170 A1.000										
Engine	Information				A10	A20	A40	A50	A70	C10 - C30	C20	E01		
All engines	Qty: 2									1.970.146	C10			
All engines												1.500.615		
ENGINE														
0.9 i.e.	Petrol	30	07/91-09/94	170 A1.046										
Engine	Information				A10	A20	A40	A50	A70	C10 - C30	C20	E01		
All engines	Qty: 2									1.970.146	C10			
All engines												1.500.615		
ENGINE														
0.9 i.e. S	Petrol	29	07/91-07/99	1170 A1.000, 1170 A1.046										
Engine	Information				A10	A20	A40	A50	A70	C10 - C30	C20	E01		
All engines	Qty: 2									1.970.146	C10			
All engines												1.500.615		
ENGINE														
1.1 Sporting	Petrol	40	10/94-01/98	176 B2.000										
Engine	Information				A10	A20	A40	A50	A70	C10 - C30	C20	E01		
All engines	Qty: 2									1.970.146	C10			
All engines												1.500.616		
COUPE														
ENGINE														
1.8 16V	Petrol	96	03/96-08/00	183 A1.000										
Engine	Information				A10	A20	A40	A50	A70	C10 - C30	C20	E01		
All engines	01/05/98 ->, Qty: 4									1.970.384	C10			
ENGINE														
2.0 16V	Petrol	102	11/93-08/96	836 A3.000										
Engine	Information				A10	A20	A40	A50	A70	C10 - C30	C20	E01		
All engines	version Marelli						1.330.114	1.430.060	1.930.177/1					
All engines										1.990.303	C30	1.500.650		
ENGINE														
2.0 16V [BRA]	Petrol	102	11/93-08/96	836 A3.011										
Engine	Information				A10	A20	A40	A50	A70	C10 - C30	C20	E01		
All engines	version Marelli						1.330.114	1.430.060	1.930.177/1					
All engines										1.990.303	C30	1.500.650		
ENGINE														
2.0 16V Turbo	Petrol	140	11/93-08/96	175 A1.000										
Engine	Information				A10	A20	A40	A50	A70	C10 - C30	C20	E01		
All engines	Qty: 2									1.970.146	C10			
A10	CONDENSER		A20	CONTACT SET		A40	DISTRIBUTOR CAP		A50	ROTOR		A70	PICK-UP	
C10	COIL		C20	IGNITION MODULE		C30	ELECTRONIC IGNITION KIT		E01	IGNITION CABLE SET				

					FUNCTIONS ON THE VEHICLE							
Vehicle	alim.	kW	Date	Engine								
ENGINE												
2.0 16V Turbo	Petrol	140	11/93-08/96	175 A1.000								
Engine	Information				A10	A20	A40	A50	A70	C10 - C30	C20	E01
All engines												1.500.456
ENGINE												
2.0 20V	Petrol	108	08/96-09/98	182 A1.000								
Engine	Information				A10	A20	A40	A50	A70	C10 - C30	C20	E01
All engines	Qty: 5									1.970.314	C10	
ENGINE												
2.0 20V Turbo	Petrol	162	08/96-08/00	175 A3.000								
Engine	Information				A10	A20	A40	A50	A70	C10 - C30	C20	E01
All engines	Qty: 5									1.970.314	C10	
CROMA I												
ENGINE												
1600	Petrol	61	12/85-12/90	154 A.048								
Engine	Information				A10	A20	A40	A50	A70	C10 - C30	C20	E01
All engines	eng. type 1125932 ->, version Marelli						1.330.098					
All engines	->eng. 1125932, version Marelli						1.330.104					
All engines	version Marelli						1.430.055R					
All engines										1.970.103	C10	
ENGINE												
2000 16V	Petrol	101	08/92-08/96	154 E1.000								
Engine	Information				A10	A20	A40	A50	A70	C10 - C30	C20	E01
All engines										1.970.168	C10	1.500.700
ENGINE												
2000 CHT	Petrol	66	12/85-02/89	154 A1.000								
Engine	Information				A10	A20	A40	A50	A70	C10 - C30	C20	E01
All engines	version Marelli						1.330.098					
All engines	->ch. 0145533, version Marelli							1.430.047R				
All engines	->eng. 1129540, ch. 0145534 ->, version Marelli							1.430.055R				
All engines	eng. type 1129540 ->, version Marelli							1.430.059				
All engines	01/01/89 ->									1.970.102	C10	
All engines	->year 01/01/89									1.970.103	C10	
ENGINE												
2000 CHT	Petrol	74	01/91-09/92	154 A1.000, 154 C5.000								
Engine	Information				A10	A20	A40	A50	A70	C10 - C30	C20	E01
All engines	version Marelli						1.330.098					
All engines	->ch. 0145533, version Marelli							1.430.047R				
All engines	->eng. 1129540, ch. 0145534 ->, version Marelli							1.430.055R				
All engines	eng. type 1129540 ->, version Marelli							1.430.059				
All engines										1.970.148	C10	1.500.398
ENGINE												
2000 i.e.	Petrol	83	03/86-09/90	834 B.048								
Engine	Information				A10	A20	A40	A50	A70	C10 - C30	C20	E01
All engines	version Marelli						1.330.098					
All engines	->eng. 957159, version Marelli							1.430.057R				
All engines	eng. type 957159 ->, version Marelli							1.430.060				
All engines									1.930.177/1			1.500.398
ENGINE												
2000 i.e.	Petrol	85	10/87-08/96	154 C3.046, 834 B.146								
Engine	Information				A10	A20	A40	A50	A70	C10 - C30	C20	E01
All engines	version Marelli						1.330.115					
All engines	FOR: (CSI), Country Version:Algeria, version Marelli							1.430.059				
All engines										1.970.148	C10	1.500.398
ENGINE												
2000 i.e.	Petrol	86	05/91-12/96	154 C3.000								
Engine	Information				A10	A20	A40	A50	A70	C10 - C30	C20	E01
All engines	version Marelli						1.330.115					
All engines	FOR: (CSI), Country Version:Algeria, version Marelli							1.430.059				
All engines										1.970.148	C10	1.500.398

A10 CONDENSER	A20 CONTACT SET	A40 DISTRIBUTOR CAP	A50 ROTOR	A70 PICK-UP
C10 COIL	C20 IGNITION MODULE	C30 ELECTRONIC IGNITION KIT	E01 IGNITION CABLE SET	

Vehicle	alim.	kW	Date	Engine	FUNCTIONS ON THE VEHICLE							
					A10	A20	A40	A50	A70	C10 - C30	C20	E01
ENGINE												
2000 i.e.	Petrol	88	03/87-09/92	154 C3.000, 834 B.000								
Engine	Information			A10	A20	A40	A50	A70	C10 - C30	C20	E01	
All engines	version Marelli					1.330.115						
All engines	->eng. 957159, version Marelli						1.430.057R					
All engines	eng. type 957159 ->, version Marelli						1.430.060					
All engines								1.930.177/1	1.990.303	C30		
ENGINE												
2000 i.e. 16V	Petrol	101	03/95-12/96	154 E1.027								
Engine	Information			A10	A20	A40	A50	A70	C10 - C30	C20	E01	
All engines									1.970.168	C10	1.500.700	
ENGINE												
2000 i.e. Turbo	Petrol	110	06/87-08/96	154 C4.046, 834 C.146								
Engine	Information			A10	A20	A40	A50	A70	C10 - C30	C20	E01	
All engines	version Marelli					1.330.115	1.430.059					
All engines									1.990.303	C30	1.500.398	
ENGINE												
2000 i.e. Turbo	Petrol	111	11/86-11/88	834 C.146								
Engine	Information			A10	A20	A40	A50	A70	C10 - C30	C20	E01	
All engines	version Marelli					1.330.115	1.430.059					
All engines									1.990.303	C30	1.500.398	
ENGINE												
2000 i.e. Turbo	Petrol	114	12/85-06/90	154 A2.000								
Engine	Information			A10	A20	A40	A50	A70	C10 - C30	C20	E01	
All engines	version Marelli					1.330.098						
All engines	->eng. 1129191, version Marelli						1.430.055R					
All engines	eng. type 1129191 ->, version Marelli						1.430.059					
All engines											1.500.398	
ENGINE												
2000 i.e. Turbo	Petrol	116	03/91-10/94	154 C4.000								
Engine	Information			A10	A20	A40	A50	A70	C10 - C30	C20	E01	
All engines	version Marelli					1.330.115	1.430.059					
All engines									1.990.303	C30	1.500.398	
CROMA II												
ENGINE												
1.8 16V	Petrol	103	12/05->	939 A4.000								
Engine	Information			A10	A20	A40	A50	A70	C10 - C30	C20	E01	
All engines	x 4, COIL ON PLUG								1.970.450	C10		
DOBLO I												
ENGINE												
1.2	Petrol	48	03/01->	223 A5.000								
Engine	Information			A10	A20	A40	A50	A70	C10 - C30	C20	E01	
All engines	x 1, D.I.S., connector type DIN								1.970.146	C10		
All engines											1.501.451	
ENGINE												
1.4	Petrol	57	10/05->	350 A1.000								
Engine	Information			A10	A20	A40	A50	A70	C10 - C30	C20	E01	
All engines	x 1, D.I.S.								1.970.423	C10		
All engines											1.499.170	
ENGINE												
1.6 Natural Power	Petrol/ Com- pressed Natural Gas (CNG)	68	02/04-07/09	182B6000CNG								
Engine	Information			A10	A20	A40	A50	A70	C10 - C30	C20	E01	
All engines	x 1, D.I.S., connector type, saw teeth								1.970.345	C10		

A10 CONDENSER	A20 CONTACT SET	A40 DISTRIBUTOR CAP	A50 ROTOR	A70 PICK-UP
C10 COIL	C20 IGNITION MODULE	C30 ELECTRONIC IGNITION KIT	E01 IGNITION CABLE SET	

The present application list is a brief version. For the detailed information about the possibility of installation on a specific vehicle, please refer to our web-catalogue <http://catalogo.facet.eu/>

FUNCTIONS ON THE VEHICLE

Vehicle	alim.	kW	Date	Engine								
---------	-------	----	------	--------	---	---	---	--	---	---	---	---

ENGINE				
1.6 Natural Power	Petrol/ Compressed Natural Gas (CNG)	76	09/02->	182 B6.000, 182B6000CNG

Engine	Information	A10	A20	A40	A50	A70	C10 - C30	C20	E01
Eng. 182 B6.000							1.970.345	C10	1.501.503
Eng. 182B6000CNG	x 1, D.I.S., connector type, saw teeth						1.970.345	C10	

DOBLO II				
1.4	Petrol	70	02/10->	843 A1.000

Engine	Information	A10	A20	A40	A50	A70	C10 - C30	C20	E01
All engines	x 4, COIL ON PLUG, incl. spark plug connector						1.970.442	C10	

ENGINE				
1.4 Natural Power	Petrol/ Compressed Natural Gas (CNG)	88	06/10->	198A4000CNG

Engine	Information	A10	A20	A40	A50	A70	C10 - C30	C20	E01
All engines	x 4, COIL ON PLUG, incl. spark plug connector						1.970.442	C10	

DUCATO I				
1.8	Petrol	49	01/82-10/88	169 B

Engine	Information	A10	A20	A40	A50	A70	C10 - C30	C20	E01
All engines	version Ducellier	1.115.034	1.215.105	1.315.054	1.415.091				
All engines	version Marelli		1.230.139						
All engines	version Bosch			1.306.079	1.406.025R				
All engines	no specific info conc. application available						1.970.101D	C10	
All engines								1.965.005	

ENGINE				
1.8	Petrol	51	07/82-12/88	XM7T

Engine	Information	A10	A20	A40	A50	A70	C10 - C30	C20	E01
All engines	version Ducellier	1.115.034	1.215.105	1.315.054	1.415.091				
All engines	version Marelli		1.230.139						
All engines	version Bosch			1.306.079	1.406.025R				
All engines	no specific info conc. application available						1.970.101D	C10	
All engines								1.965.005	

ENGINE				
2.0	Petrol	55	07/85-02/94	170 B, XN 1T

Engine	Information	A10	A20	A40	A50	A70	C10 - C30	C20	E01
All engines	version Ducellier			1.315.054	1.415.094				
All engines								1.965.005	

ENGINE				
2.0	Petrol	58	01/82-08/90	XN 1T

Engine	Information	A10	A20	A40	A50	A70	C10 - C30	C20	E01
All engines	version Ducellier			1.315.054	1.415.094				
All engines								1.965.005	

ENGINE				
2.0	Petrol	62	07/90-03/94	170 D

Engine	Information	A10	A20	A40	A50	A70	C10 - C30	C20	E01
All engines	version Ducellier			1.315.058	1.415.096R				
All engines								1.965.005	

ENGINE				
2.0	Petrol	63	06/90-05/94	170 D, 170C (XN1T)

Engine	Information	A10	A20	A40	A50	A70	C10 - C30	C20	E01
All engines	version Ducellier			1.315.054	1.415.094				
All engines								1.965.005	

ENGINE				
2.0 4x4	Petrol	63	06/90-05/94	170 D

Engine	Information	A10	A20	A40	A50	A70	C10 - C30	C20	E01
All engines	version Ducellier			1.315.054	1.415.094				
All engines								1.965.005	

A10 CONDENSER	A20 CONTACT SET	A40 DISTRIBUTOR CAP	A50 ROTOR	A70 PICK-UP
C10 COIL	C20 IGNITION MODULE	C30 ELECTRONIC IGNITION KIT	E01 IGNITION CABLE SET	

Vehicle	alim.	kW	Date	Engine	FUNCTIONS ON THE VEHICLE							
					A10	A20	A40	A50	A70	C10 - C30	C20	E01

DUCATO II

				ENGINE
2.0	Petrol	74	06/94-12/95	--

Engine	Information	A10	A20	A40	A50	A70	C10 - C30	C20	E01
All engines	Kit, version Ducellier			1.315.087					
All engines	version Ducellier					1.915.019			

				ENGINE
2.0	Petrol	80	03/94-04/02	RFW

Engine	Information	A10	A20	A40	A50	A70	C10 - C30	C20	E01
All engines							1.970.188	C10	1.500.674

				ENGINE
2.0	Petrol	81	04/02->	RFL, RFL (XU10J2U)

Engine	Information	A10	A20	A40	A50	A70	C10 - C30	C20	E01
Eng. RFL	Ducato 11, Ducato 15, x 1, PEUGEOT, D.I.S., connector type, saw teeth						1.970.188	C10	
Eng. RFL (XU10J2U)									1.500.674

				ENGINE
2.0 4x4	Petrol	80	11/94-04/02	RFW

Engine	Information	A10	A20	A40	A50	A70	C10 - C30	C20	E01
All engines							1.970.188	C10	1.500.674

				ENGINE
2.0 4x4	Petrol	81	05/02-07/06	RFL, RFL (XU10J2U)

Engine	Information	A10	A20	A40	A50	A70	C10 - C30	C20	E01
Eng. RFL	Ducato 11, Ducato 15, x 1, PEUGEOT, D.I.S., connector type, saw teeth						1.970.188	C10	
Eng. RFL (XU10J2U)									1.500.674

				ENGINE
2.0 Bipower	Petrol/ Com- pressed Natural Gas (CNG)	81	11/02->	RFL, RFL (XU10J2U)

Engine	Information	A10	A20	A40	A50	A70	C10 - C30	C20	E01
Eng. RFL	Ducato 15, x 1, PEUGEOT, D.I.S., connector type, saw teeth						1.970.188	C10	
Eng. RFL (XU10J2U)									1.500.674

				ENGINE
2.0 LPG	Petrol/ Liquified Petro- leum Gas (LPG)	71	11/02-07/06	RFL

Engine	Information	A10	A20	A40	A50	A70	C10 - C30	C20	E01
All engines	Ducato 15, x 1, PEUGEOT, D.I.S., connector type, saw teeth						1.970.188	C10	

				ENGINE
2.0 Panorama/Com- binato	Petrol	80	03/94-04/02	RFW

Engine	Information	A10	A20	A40	A50	A70	C10 - C30	C20	E01
All engines							1.970.188	C10	1.500.674

DUCATO III

				ENGINE
140 Natural Power	CNG	100	04/09->	F1CE0441A, F1CFA401A, F1CFA401C

Engine	Information	A10	A20	A40	A50	A70	C10 - C30	C20	E01
All engines	Ducato 35, x 4, COIL ON PLUG						1.970.442	C10	

DUNA

				ENGINE
60 1.1	Petrol	43	01/87-12/91	146 A6.000

Engine	Information	A10	A20	A40	A50	A70	C10 - C30	C20	E01
All engines	version Marelli			1.330.101	1.430.047R	1.930.176M			
All engines							1.970.158	C10	1.965.020

				ENGINE
70 1.3	Petrol	49	01/87-12/91	146 A5.000

Engine	Information	A10	A20	A40	A50	A70	C10 - C30	C20	E01
All engines	version Marelli			1.330.101	1.430.047R	1.930.176M			
All engines							1.970.158	C10	1.965.020

A10	CONDENSER	A20	CONTACT SET	A40	DISTRIBUTOR CAP	A50	ROTOR	A70	PICK-UP
C10	COIL	C20	IGNITION MODULE	C30	ELECTRONIC IGNITION KIT	E01	IGNITION CABLE SET		

					FUNCTIONS ON THE VEHICLE							
Vehicle	alim.	kW	Date	Engine								

ELBA

				ENGINE
1.3	Petrol	49	04/91-02/95	146 A5.000

Engine	Information	A10	A20	A40	A50	A70	C10 - C30	C20	E01
All engines	version Marelli			1.330.101		1.930.176M			
All engines	no specific info conc. application available, version Marelli				1.430.047R, 1.430.060				
All engines							1.970.158	C10	1.965.020

				ENGINE
1.4	Petrol	49	10/93-02/95	146 D5.000

Engine	Information	A10	A20	A40	A50	A70	C10 - C30	C20	E01
All engines							1.970.188	C10	1.500.655

				ENGINE
1.5	Petrol	49	01/92-12/96	149 C1.000

Engine	Information	A10	A20	A40	A50	A70	C10 - C30	C20	E01
All engines	->year 31/05/93, version Marelli			1.330.104					
All engines	01/06/93 ->, version Marelli			1.330.114					
All engines	version Marelli				1.430.059				
All engines							1.970.148	C10	

				ENGINE
1.5	Petrol	55	01/92-12/96	149 C1.000

Engine	Information	A10	A20	A40	A50	A70	C10 - C30	C20	E01
All engines	->year 31/05/93, version Marelli			1.330.104					
All engines	01/06/93 ->, version Marelli			1.330.114					
All engines	version Marelli				1.430.059				
All engines							1.970.148	C10	

FIORINO I

				ENGINE
1.0	Petrol	37	01/80-12/87	127 A.000

Engine	Information	A10	A20	A40	A50	A70	C10 - C30	C20	E01
All engines	version Marelli	1.130.117	1.230.142	1.330.090	1.430.042R				
All engines							1.970.101D	C10	

				ENGINE
1.1 60	Petrol	40	11/86-04/88	146 A9.000

Engine	Information	A10	A20	A40	A50	A70	C10 - C30	C20	E01
All engines	version Marelli			1.330.101		1.930.176M			
All engines	->eng. 3854060, version Marelli				1.430.047R				
All engines	eng. type 3854060 ->, version Marelli				1.430.060				
All engines							1.970.158	C10	1.965.020

				ENGINE
1.3	Petrol	49	12/87-08/93	146 A5.000

Engine	Information	A10	A20	A40	A50	A70	C10 - C30	C20	E01
All engines	version Marelli			1.330.101		1.930.176M			
All engines	->eng. 03854060, version Marelli				1.430.047R				
All engines	eng. type 03854060 ->, version Marelli				1.430.060				
All engines							1.970.158	C10	1.965.020

				ENGINE
1.5	Petrol	55	01/88-08/93	149 C1.000

Engine	Information	A10	A20	A40	A50	A70	C10 - C30	C20	E01
All engines	->year 01/05/93, version Marelli			1.330.104					
All engines	01/05/93 ->, version Marelli			1.330.114					
All engines	->year 01/05/90, version Marelli				1.430.055R				
All engines	01/05/90 ->, version Marelli				1.430.059				
All engines	VET. 8098787, 8150978 ->						1.970.102	C10	
All engines	->VET. 8098787, 8150978						1.970.103	C10	

				ENGINE
1050	Petrol	37	01/80-12/87	127 A.000

Engine	Information	A10	A20	A40	A50	A70	C10 - C30	C20	E01
All engines	version Marelli	1.130.117	1.230.142	1.330.090	1.430.042R				
All engines							1.970.101D	C10	

A10 CONDENSER	A20 CONTACT SET	A40 DISTRIBUTOR CAP	A50 ROTOR	A70 PICK-UP
C10 COIL	C20 IGNITION MODULE	C30 ELECTRONIC IGNITION KIT	E01 IGNITION CABLE SET	

Vehicle	alim.	kW	Date	Engine	FUNCTIONS ON THE VEHICLE									
					A10	A20	A40	A50	A70	C10 - C30	C20	E01		
ENGINE														
900	Petrol	33	10/77-10/86	100 GL.000										
Engine	Information			A10	A20	A40	A50	A70	C10 - C30	C20	E01			
All engines	version Ducellier			1.115.023	1.215.056HV	1.315.045	1.415.083R							
All engines	version Marelli			1.130.117	1.230.142		1.430.042R							
All engines	01/01/82 ->, version Marelli					1.330.090								
All engines									1.970.101D	C10				
FIORINO II														
ENGINE														
1.0 iE	Petrol	33	11/92-04/96	156 A2.246										
Engine	Information			A10	A20	A40	A50	A70	C10 - C30	C20	E01			
All engines	version Marelli					1.330.109	1.430.060	1.930.180M						
All engines									1.970.108	C10	1.965.020	1.500.347		
ENGINE														
1.3	Petrol	49	01/88-12/94	146 A5.000										
Engine	Information			A10	A20	A40	A50	A70	C10 - C30	C20	E01			
All engines	version Marelli					1.330.101		1.930.176M						
All engines	->eng. 03854060, version Marelli						1.430.047R							
All engines	eng. type 03854060 ->, version Marelli						1.430.060							
All engines									1.970.158	C10	1.965.020			
ENGINE														
1.4	Petrol	49	05/94-05/01	146 D5.000										
Engine	Information			A10	A20	A40	A50	A70	C10 - C30	C20	E01			
All engines									1.970.168	C10		1.500.655		
ENGINE														
1.4	Petrol	52	11/92-10/96	146 C5.000										
Engine	Information			A10	A20	A40	A50	A70	C10 - C30	C20	E01			
All engines									1.970.168	C10		1.500.655		
ENGINE														
1.5 iE	Petrol	55	01/88-10/92	149 C1.000										
Engine	Information			A10	A20	A40	A50	A70	C10 - C30	C20	E01			
All engines	->year 01/05/93, version Marelli					1.330.104								
All engines	01/05/93 ->, version Marelli					1.330.114								
All engines	->year 01/05/90, version Marelli						1.430.055R							
All engines	01/05/90 ->, version Marelli						1.430.059							
All engines	VET. 8098787, 8150978 ->								1.970.102	C10				
All engines	->VET. 8098787, 8150978								1.970.103	C10				
ENGINE														
1.6	Petrol	55	01/94-05/01	146 C6.000, 146 D6.000										
Engine	Information			A10	A20	A40	A50	A70	C10 - C30	C20	E01			
Eng. 146 C6.000	version Marelli					1.330.115	1.430.059	1.930.177/1						
Eng. 146 C6.000									1.970.148	C10				
Eng. 146 D6.000									1.970.168	C10		1.500.655		
ENGINE														
60 1.1	Petrol	40	05/88-12/93	146 A9.000										
Engine	Information			A10	A20	A40	A50	A70	C10 - C30	C20	E01			
All engines	version Marelli					1.330.101		1.930.176M						
All engines	->eng. 3854060, version Marelli						1.430.047R							
All engines	eng. type 3854060 ->, version Marelli						1.430.060							
All engines									1.970.158	C10	1.965.020			
ENGINE														
70 1.3	Petrol	49	01/88-12/94	146 A5.000										
Engine	Information			A10	A20	A40	A50	A70	C10 - C30	C20	E01			
All engines	version Marelli					1.330.101		1.930.176M						
All engines	->eng. 03854060, version Marelli						1.430.047R							
All engines	eng. type 03854060 ->, version Marelli						1.430.060							
All engines									1.970.158	C10	1.965.020			
ENGINE														
70 i.e. 1.4	Petrol	49	05/94-05/01	146 C5.000, 146 D5.000										
Engine	Information			A10	A20	A40	A50	A70	C10 - C30	C20	E01			
Eng. 146 C5.000	version Marelli					1.330.114	1.430.059							
Eng. 146 C5.000									1.970.148	C10				

A10 CONDENSER	A20 CONTACT SET	A40 DISTRIBUTOR CAP	A50 ROTOR	A70 PICK-UP
C10 COIL	C20 IGNITION MODULE	C30 ELECTRONIC IGNITION KIT	E01 IGNITION CABLE SET	

The present application list is a brief version. For the detailed information about the possibility of installation on a specific vehicle, please refer to our web-catalogue <http://catalogo.facet.eu/>

Vehicle	alim.	kW	Date	Engine	FUNCTIONS ON THE VEHICLE							
					A10	A20	A40	A50	A70	C10 - C30	C20	E01

ENGINE				
70 i.e. 1.4	Petrol	49	05/94-05/01	146 C5.000, 146 D5.000

Engine	Information	A10	A20	A40	A50	A70	C10 - C30	C20	E01
Eng. 146 D5.000							1.970.168	C10	1.500.655

ENGINE				
75 i.e. 1.5	Petrol	55	05/88-12/93	149 C1.000

Engine	Information	A10	A20	A40	A50	A70	C10 - C30	C20	E01
All engines	->year 01/05/93, version Marelli			1.330.104					
All engines	01/05/93 ->, version Marelli			1.330.114					
All engines	->year 01/05/90, version Marelli				1.430.055R				
All engines	01/05/90 ->, version Marelli				1.430.059				
All engines	VET. 8098787, 8150978 ->						1.970.102	C10	
All engines	->VET. 8098787, 8150978						1.970.103	C10	

ENGINE				
75 i.e. 1.6	Petrol	55	10/93-05/01	146 C6.000, 146 D6.000

Engine	Information	A10	A20	A40	A50	A70	C10 - C30	C20	E01
Eng. 146 C6.000	version Marelli			1.330.115	1.430.059	1.930.177/1			
Eng. 146 C6.000							1.970.148	C10	
Eng. 146 D6.000							1.970.168	C10	1.500.655

FIORINO III

ENGINE				
1.4	Petrol	54	11/07->	KFT, KFV

Engine	Information	A10	A20	A40	A50	A70	C10 - C30	C20	E01
All engines	x 4, COIL ON PLUG						1.970.405	C10	
All engines	01/01/16 ->								1.499.170

ENGINE				
1.4	Petrol	57	10/09->	350 A1.000

Engine	Information	A10	A20	A40	A50	A70	C10 - C30	C20	E01
All engines	x 1, D.I.S.						1.970.423	C10	
All engines	01/01/16 ->								1.499.170

ENGINE				
1.4 CNG	Petrol/Compressed Natural Gas (CNG)	51	07/14->	350A1000CNG

Engine	Information	A10	A20	A40	A50	A70	C10 - C30	C20	E01
All engines	x 1, D.I.S.						1.970.423	C10	

ENGINE				
1.4 CNG	Petrol/Compressed Natural Gas (CNG)	57	06/08->	350A1000CNG

Engine	Information	A10	A20	A40	A50	A70	C10 - C30	C20	E01
All engines	x 1, D.I.S.						1.970.423	C10	

ENGINE				
1.4 Natural Power	Petrol/Compressed Natural Gas (CNG)	51	06/08->	350A1000CNG

Engine	Information	A10	A20	A40	A50	A70	C10 - C30	C20	E01
All engines	x 1, D.I.S.						1.970.423	C10	

ENGINE				
1.4 Natural Power	Petrol/Compressed Natural Gas (CNG)	57	06/08->	350 A1.000, 350A1000CNG

Engine	Information	A10	A20	A40	A50	A70	C10 - C30	C20	E01
Eng. 350 A1.000							1.970.423	C10	1.499.170
Eng. 350A1000CNG	x 1, D.I.S.						1.970.423	C10	

A10 CONDENSER	A20 CONTACT SET	A40 DISTRIBUTOR CAP	A50 ROTOR	A70 PICK-UP
C10 COIL	C20 IGNITION MODULE	C30 ELECTRONIC IGNITION KIT	E01 IGNITION CABLE SET	

Vehicle	alim.	kW	Date	Engine	FUNCTIONS ON THE VEHICLE							
					A10	A20	A40	A50	A70	C10 - C30	C20	E01

GRANDE PUNTO

				ENGINE
1.4	Petrol	57	02/06-06/13	350 A1.000

Engine	Information	A10	A20	A40	A50	A70	C10 - C30	C20	E01
All engines	x 1, D.I.S.						1.970.423	C10	

				ENGINE
1.4 LPG	Petrol/ Liquified Petro- leum Gas (LPG)	57	03/09-12/12	350 A1.000

Engine	Information	A10	A20	A40	A50	A70	C10 - C30	C20	E01
All engines	x 1, D.I.S.						1.970.423	C10	

				ENGINE
1.4 Natural Power	Petrol/ Com- pressed Natural Gas (CNG)	57	03/09-12/12	350A1000CNG

Engine	Information	A10	A20	A40	A50	A70	C10 - C30	C20	E01
All engines	x 1, D.I.S.						1.970.423	C10	

IDEA

				ENGINE
1.2	Petrol	59	01/08->	--

Engine	Information	A10	A20	A40	A50	A70	C10 - C30	C20	E01
All engines	Qty: 4						1.970.442	C10	

				ENGINE
1.2 16V	Petrol	59	01/04->	188 A5.000

Engine	Information	A10	A20	A40	A50	A70	C10 - C30	C20	E01
All engines	x 4, COIL ON PLUG, incl. spark plug connector						1.970.442	C10	

				ENGINE
1.4	Petrol	57	10/05->	350 A1.000

Engine	Information	A10	A20	A40	A50	A70	C10 - C30	C20	E01
All engines	x 1, D.I.S.						1.970.423	C10	
All engines									1.499.170

				ENGINE
1.4	Petrol	66	12/03->	192 B2.000

Engine	Information	A10	A20	A40	A50	A70	C10 - C30	C20	E01
All engines	x 4, COIL ON PLUG, incl. spark plug connector						1.970.442	C10	

				ENGINE
1.4	Petrol	70	10/04-12/12	843 A1.000

Engine	Information	A10	A20	A40	A50	A70	C10 - C30	C20	E01
All engines	x 4, COIL ON PLUG, incl. spark plug connector						1.970.442	C10	

				ENGINE
1.4 16V	Petrol	59	08/10->	--

Engine	Information	A10	A20	A40	A50	A70	C10 - C30	C20	E01
All engines	Qty: 4						1.970.442	C10	

				ENGINE
1.4 16V	Petrol	70	01/04->	843 A1.000

Engine	Information	A10	A20	A40	A50	A70	C10 - C30	C20	E01
All engines	x 4, COIL ON PLUG, incl. spark plug connector						1.970.442	C10	

				ENGINE
1.4 LPG	Petrol/ Liquified Petro- leum Gas (LPG)	57	03/09->	350 A1.000

Engine	Information	A10	A20	A40	A50	A70	C10 - C30	C20	E01
All engines	x 1, D.I.S.						1.970.423	C10	

LINEA

				ENGINE
1.4	Petrol	57	06/07->	350 A1.000

Engine	Information	A10	A20	A40	A50	A70	C10 - C30	C20	E01
All engines	x 1, D.I.S.						1.970.423	C10	
All engines									1.499.170

A10 CONDENSER	A20 CONTACT SET	A40 DISTRIBUTOR CAP	A50 ROTOR	A70 PICK-UP
C10 COIL	C20 IGNITION MODULE	C30 ELECTRONIC IGNITION KIT	E01 IGNITION CABLE SET	

The present application list is a brief version. For the detailed information about the possibility of installation on a specific vehicle, please refer to our web-catalogue <http://catalogo.facet.eu/>

					FUNCTIONS ON THE VEHICLE							
Vehicle	alim.	kW	Date	Engine								
ENGINE												
1.4 16V [IND]	Petrol	70	06/07->	--								
Engine	Information				A10	A20	A40	A50	A70	C10 - C30	C20	E01
All engines	Qty: 4									1.970.442	C10	
ENGINE												
1.4 T-Jet	Petrol	88	05/07->	198 A4.000								
Engine	Information				A10	A20	A40	A50	A70	C10 - C30	C20	E01
All engines	MADE BY: (IND), x 4, COIL ON PLUG, incl. spark plug connector									1.970.442	C10	
MAREA												
ENGINE												
1.2 16V	Petrol	60	10/98-05/02	182 B2.000								
Engine	Information				A10	A20	A40	A50	A70	C10 - C30	C20	E01
All engines	x 1, D.I.S., connector type, saw teeth									1.970.168	C10	
All engines												1.501.505
ENGINE												
1.4 80 12V	Petrol	59	09/96-05/02	182 A3.000								
Engine	Information				A10	A20	A40	A50	A70	C10 - C30	C20	E01
All engines	x 1, D.I.S., connector type, saw teeth									1.970.168	C10	
All engines												1.501.363
ENGINE												
1.6	Petrol	68	03/99-08/00	185 A3.000								
Engine	Information				A10	A20	A40	A50	A70	C10 - C30	C20	E01
All engines	x 1, D.I.S., connector type, saw teeth									1.970.345	C10	
All engines												1.501.503
ENGINE												
1.6	Petrol	76	09/00-08/02	182 B6.000								
Engine	Information				A10	A20	A40	A50	A70	C10 - C30	C20	E01
All engines	x 1, D.I.S., connector type, saw teeth									1.970.345	C10	
All engines												1.501.503
ENGINE												
1.6 100 16V	Petrol	76	09/96-05/02	182 A4.000								
Engine	Information				A10	A20	A40	A50	A70	C10 - C30	C20	E01
All engines	x 1, D.I.S., connector type, saw teeth									1.970.345	C10	
All engines												1.501.503
ENGINE												
1.6 100 16V Bipower	Petrol/ Com- pressed Natural Gas (CNG)	76	04/99-05/02	182 A4.000, 185 A3.000								
Engine	Information				A10	A20	A40	A50	A70	C10 - C30	C20	E01
Eng. 185 A3.000										1.970.345	C10	1.501.503
Eng. 182 A4.000	x 1, D.I.S., connector type, saw teeth									1.970.345	C10	
ENGINE												
1.6 16V	Petrol	75	04/97-02/99	185 A3.000								
Engine	Information				A10	A20	A40	A50	A70	C10 - C30	C20	E01
All engines	x 1, D.I.S., connector type, saw teeth									1.970.345	C10	
All engines												1.501.503
ENGINE												
1.6 SX	Petrol	72	09/00-08/02	182 B5.098								
Engine	Information				A10	A20	A40	A50	A70	C10 - C30	C20	E01
All engines	x 1, D.I.S., connector type, saw teeth									1.970.345	C10	
All engines												1.501.503
ENGINE												
2.0 150 20V	Petrol	108	09/96-04/99	182 A1.000								
Engine	Information				A10	A20	A40	A50	A70	C10 - C30	C20	E01
All engines	x 5, COIL ON PLUG, incl. spark plug connector									1.970.314	C10	
ENGINE												
2.0i 20v [BRA]	Petrol	108	10/96-04/99	182 A1.011								
Engine	Information				A10	A20	A40	A50	A70	C10 - C30	C20	E01
All engines	Qty: 5									1.970.314	C10	

A10 CONDENSER	A20 CONTACT SET	A40 DISTRIBUTOR CAP	A50 ROTOR	A70 PICK-UP
C10 COIL	C20 IGNITION MODULE	C30 ELECTRONIC IGNITION KIT	E01 IGNITION CABLE SET	

Vehicle	alim.	kW	Date	Engine	FUNCTIONS ON THE VEHICLE							
					A10	A20	A40	A50	A70	C10 - C30	C20	E01

MULTIPLA

				ENGINE
1.6	Petrol	68	05/04-08/05	182 B6.000

Engine	Information	A10	A20	A40	A50	A70	C10 - C30	C20	E01
All engines	x 1, D.I.S., connector type, saw teeth						1.970.345	C10	
All engines									1.501.503

				ENGINE
1.6	Petrol	74	03/01-08/05	182 B6.000

Engine	Information	A10	A20	A40	A50	A70	C10 - C30	C20	E01
All engines							1.970.345	C10	
All engines									1.501.503

				ENGINE
1.6	Petrol	76	09/00-06/10	182 B6.000

Engine	Information	A10	A20	A40	A50	A70	C10 - C30	C20	E01
All engines	x 1, D.I.S., connector type, saw teeth						1.970.345	C10	
All engines									1.501.503

				ENGINE
1.6 100 16V	Petrol	76	04/99-06/10	182 A4.000

Engine	Information	A10	A20	A40	A50	A70	C10 - C30	C20	E01
All engines	x 1, D.I.S., connector type, saw teeth						1.970.345	C10	
All engines									1.501.503

				ENGINE
1.6 16V	Petrol	70	04/02-06/10	182 B6.000

Engine	Information	A10	A20	A40	A50	A70	C10 - C30	C20	E01
All engines	x 1, D.I.S., connector type, saw teeth						1.970.345	C10	
All engines									1.501.503

				ENGINE
1.6 16V Bipower	Petrol/ Com- pressed Natural Gas (CNG)	76	04/99-06/10	182 B6.000, 186 A4.000

Engine	Information	A10	A20	A40	A50	A70	C10 - C30	C20	E01
All engines	x 1, D.I.S., connector type, saw teeth						1.970.345	C10	
All engines									1.501.503

				ENGINE
1.6 16V Blupower	Petrol/ Com- pressed Natural Gas (CNG)	70	04/99-06/10	186 A3.000, 186A3000C- NG

Engine	Information	A10	A20	A40	A50	A70	C10 - C30	C20	E01
Eng. 186 A3.000							1.970.345	C10	1.501.503
Eng. 186A3000CNG	x 1, D.I.S., connector type, saw teeth						1.970.345	C10	

				ENGINE
1.6 16V GPL	Petrol/ Liquified Petro- leum Gas (LPG)	76	10/01-06/10	182 B6.000

Engine	Information	A10	A20	A40	A50	A70	C10 - C30	C20	E01
All engines	x 1, D.I.S., connector type, saw teeth						1.970.345	C10	
All engines									1.501.503

				ENGINE
1.6 Natural Power	Petrol/ Com- pressed Natural Gas (CNG)	77	11/08-06/10	182B6000CNG

Engine	Information	A10	A20	A40	A50	A70	C10 - C30	C20	E01
All engines	x 1, D.I.S., connector type, saw teeth						1.970.345	C10	

MULTIPLA VAN

				ENGINE
1.6	Petrol	76	09/00-06/10	182 B6.000

Engine	Information	A10	A20	A40	A50	A70	C10 - C30	C20	E01
All engines	x 1, D.I.S., connector type, saw teeth						1.970.345	C10	

A10 CONDENSER	A20 CONTACT SET	A40 DISTRIBUTOR CAP	A50 ROTOR	A70 PICK-UP
C10 COIL	C20 IGNITION MODULE	C30 ELECTRONIC IGNITION KIT	E01 IGNITION CABLE SET	

					FUNCTIONS ON THE VEHICLE							
Vehicle	alim.	kW	Date	Engine	 A10	 A20	 A40	 A50	 A70	 C10 - C30	 C20	 E01
Bipower												
	Petrol/ Ethanol	76	10/01-06/10	ENGINE 182 B6.000								
Engine	Information				A10	A20	A40	A50	A70	C10 - C30	C20	E01
All engines	x 1, D.I.S., connector type, saw teeth									1.970.345	C10	
PALIO												
1.0												
	Petrol	45	04/96-10/03	ENGINE 178 A1.000								
Engine	Information				A10	A20	A40	A50	A70	C10 - C30	C20	E01
All engines	x 1, D.I.S., connector type DIN									1.970.146	C10	
All engines												1.501.451
1.0												
	Petrol	56	04/96-10/03	ENGINE 178 A1.000								
Engine	Information				A10	A20	A40	A50	A70	C10 - C30	C20	E01
All engines	x 1, D.I.S., connector type DIN									1.970.146	C10	
All engines												1.501.451
1.0 GLX												
	Petrol	45	07/98-10/03	ENGINE --								
Engine	Information				A10	A20	A40	A50	A70	C10 - C30	C20	E01
All engines	Qty: 2									1.970.146	C10	
All engines												1.501.451
1.1												
	Petrol	40	07/97-10/03	ENGINE 178 B9.033								
Engine	Information				A10	A20	A40	A50	A70	C10 - C30	C20	E01
All engines	version Marelli						1.330.109	1.430.060	1.930.180M			
All engines	x 1, DISTRIBUTOR, connector type DIN									1.970.108	C10	
All engines											1.965.020	1.500.347
1.1												
	Petrol	42	06/06->	ENGINE 187 A1.000								
Engine	Information				A10	A20	A40	A50	A70	C10 - C30	C20	E01
All engines	Qty: 2									1.970.146	C10	
All engines												1.501.451
1.2												
	Petrol	44	07/97-10/04	ENGINE 178 B7.045, 178 C4.066, 188 A4.000								
Engine	Information				A10	A20	A40	A50	A70	C10 - C30	C20	E01
All engines	x 1, D.I.S., connector type DIN									1.970.146	C10	
Eng. 178 C4.066	Qty: 2									1.970.146	C10	
All engines	->eng. 2935743											1.500.616
All engines	eng. type 2935743 ->											1.501.451
1.2												
	Petrol	50	06/99-10/02	ENGINE 178 E2.000								
Engine	Information				A10	A20	A40	A50	A70	C10 - C30	C20	E01
All engines	x 1, D.I.S., connector type DIN									1.970.146	C10	
All engines	->eng. 2935743											1.500.616
All engines	eng. type 2935743 ->											1.501.451
1.2												
	Petrol	53	07/01-06/05	ENGINE 178 B5.000								
Engine	Information				A10	A20	A40	A50	A70	C10 - C30	C20	E01
All engines	Qty: 2									1.970.146	C10	
All engines	->eng. 2935743											1.500.616
All engines	eng. type 2935743 ->											1.501.451
1.2												
	Petrol	54	04/96->	ENGINE 176 A8.000, 178 B5.000, 178 E2.000								
Engine	Information				A10	A20	A40	A50	A70	C10 - C30	C20	E01
Eng. 176 A8.000, 178 E2.000	Qty: 2									1.970.146	C10	
Eng. 178 B5.000	x 1, D.I.S., connector type DIN									1.970.146	C10	
All engines	->eng. 2935743											1.500.616
All engines	eng. type 2935743 ->											1.501.451

A10 CONDENSER	A20 CONTACT SET	A40 DISTRIBUTOR CAP	A50 ROTOR	A70 PICK-UP
C10 COIL	C20 IGNITION MODULE	C30 ELECTRONIC IGNITION KIT	E01 IGNITION CABLE SET	

Vehicle	alim.	kW	Date	Engine	FUNCTIONS ON THE VEHICLE								
					A10	A20	A40	A50	A70	C10 - C30	C20	E01	
1.2	Petrol	59	03/00-10/04	ENGINE 178 D6.011, 188 A5.000									
Engine	Information												
All engines	x 1, D.I.S., connector type, saw teeth									1.970.168	C10		
Eng. 188 A5.000													1.501.505
1.2 75	Petrol	54	03/98->	ENGINE 178 B7.045									
Engine	Information												
All engines	Qty: 2									1.970.146	C10		
All engines	->eng. 2935743												1.500.616
All engines	eng. type 2935743 ->												1.501.451
1.2 MPI	Petrol	44	01/02->	ENGINE 178 C4.066									
Engine	Information												
All engines	Qty: 2									1.970.146	C10		
All engines	->eng. 2935743												1.500.616
All engines	eng. type 2935743 ->												1.501.451
1.4	Petrol	51	04/96-10/02	ENGINE 178 B2.000, 178 B2.016									
Engine	Information												
All engines	x 1, D.I.S., version 1, connector type DIN, D.I.S., connector type DIN									1.970.146	C10		
1.4	Petrol	63	10/02-10/04	ENGINE 350 A1.000									
Engine	Information												
All engines	x 1, D.I.S.									1.970.423	C10		
1.4	Petrol	70	06/03->	ENGINE 834 A1.000									
Engine	Information												
All engines										1.970.423	C10		1.499.170
1.4 Cat	Petrol	51	04/96-08/01	ENGINE 178 B2.000, 178 B2.016									
Engine	Information												
All engines	x 1, version 1, D.I.S., connector type DIN									1.970.146	C10		
1.5	Petrol	62	02/02->	ENGINE 178 E5.022									
Engine	Information												
All engines	x 1, D.I.S., connector type DIN									1.970.146	C10		
1.6	Petrol	68	07/97-10/00	ENGINE 178 D2.011									
Engine	Information												
All engines										1.970.345	C10		1.501.503
1.6	Petrol	70	06/99->	ENGINE 178 D2.011									
Engine	Information												
All engines										1.970.345	C10		1.501.503
1.6	Petrol	76	06/99-10/00	ENGINE 178 C7.098									
Engine	Information												
All engines	x 1, D.I.S., connector type, saw teeth									1.970.345	C10		
1.6 16V	Petrol	68	07/97-10/03	ENGINE 178 C7.098, 178 D2.011									
Engine	Information												
All engines										1.970.345	C10		1.501.503
1.6 16V	Petrol	74	04/96->	ENGINE 178 B3.000, 182 B6.000									
Engine	Information												
Eng. 178 B3.000	x 1, D.I.S., connector type, saw teeth									1.970.345	C10		
Eng. 182 B6.000										1.970.345	C10		
All engines													1.501.503

A10 CONDENSER	A20 CONTACT SET	A40 DISTRIBUTOR CAP	A50 ROTOR	A70 PICK-UP
C10 COIL	C20 IGNITION MODULE	C30 ELECTRONIC IGNITION KIT	E01 IGNITION CABLE SET	

The present application list is a brief version. For the detailed information about the possibility of installation on a specific vehicle, please refer to our web-catalogue <http://catalogo.facet.eu/>

					FUNCTIONS ON THE VEHICLE							
Vehicle	alim.	kW	Date	Engine								
ENGINE												
1.6 16V	Petrol	76	02/01-01/12	182 B6.000								
Engine	Information				A10	A20	A40	A50	A70	C10 - C30	C20	E01
All engines	x 1, D.I.S., connector type, saw teeth									1.970.345	C10	
All engines												1.501.503
ENGINE												
1.6 16V 100	Petrol	69	01/98->	178 C8.098								
Engine	Information				A10	A20	A40	A50	A70	C10 - C30	C20	E01
All engines	Qty: 2									1.970.146	C10	
ENGINE												
1.6 16V 100	Petrol	74	01/98->	178 C8.098								
Engine	Information				A10	A20	A40	A50	A70	C10 - C30	C20	E01
All engines	Qty: 2									1.970.146	C10	
ENGINE												
1.6 16V Sport	Petrol	76	10/01->	178 E7.000								
Engine	Information				A10	A20	A40	A50	A70	C10 - C30	C20	E01
All engines										1.970.345	C10	
PANDA I												
ENGINE												
1.1	Petrol	37	05/91-03/95	156 C.046								
Engine	Information				A10	A20	A40	A50	A70	C10 - C30	C20	E01
All engines	->year 01/01/93, version Marelli						1.330.109	1.430.060	1.930.180M			
All engines	->year 01/01/93, version Bosch SPi									1.970.108	C10	1.500.347
All engines	01/01/93 ->, Qty: 2, version Weber SPi									1.970.146	C10	
All engines	->year 01/01/93										1.965.020	
All engines	eng. type 5524923 ->, version Weber SPi											1.500.616
All engines	->eng. 5524923, version Weber SPi											1.500.887
ENGINE												
1.1	Petrol	40	09/00-02/04	187 A1.000								
Engine	Information				A10	A20	A40	A50	A70	C10 - C30	C20	E01
All engines	Qty: 2									1.970.146	C10	
All engines												1.501.451
ENGINE												
1.1 AWD	Petrol	40	09/00-02/04	187 A1.000								
Engine	Information				A10	A20	A40	A50	A70	C10 - C30	C20	E01
All engines	Qty: 2									1.970.146	C10	
All engines												1.501.451
ENGINE												
1000	Petrol	32	01/86-04/92	156 A2.100								
Engine	Information				A10	A20	A40	A50	A70	C10 - C30	C20	E01
All engines	version Marelli						1.330.109	1.430.060	1.930.180M			
All engines										1.970.158	C10	1.965.020
												1.500.347
ENGINE												
1000	Petrol	37	01/85-12/92	156 A3.000								
Engine	Information				A10	A20	A40	A50	A70	C10 - C30	C20	E01
All engines	version Marelli						1.330.109	1.430.060	1.930.180M			
All engines										1.970.158	C10	1.965.020
												1.500.347
ENGINE												
1000 4x4	Petrol	32	01/86-07/89	156 A2.100								
Engine	Information				A10	A20	A40	A50	A70	C10 - C30	C20	E01
All engines	version Marelli						1.330.109	1.430.060	1.930.180M			
All engines										1.970.158	C10	1.965.020
												1.500.347
ENGINE												
1000 4x4	Petrol	33	05/86-12/94	141 C2.000, 156 A2.246								
Engine	Information				A10	A20	A40	A50	A70	C10 - C30	C20	E01
Eng. 156 A2.246	version Marelli						1.330.109	1.430.060	1.930.180M			
All engines	->year 01/05/91, version Bosch SPi									1.970.108	C10	
Eng. 141 C2.000	Qty: 2, version Weber SPi									1.970.146	C10	
Eng. 156 A2.246	01/05/91 ->									1.970.158	C10	
Eng. 156 A2.246											1.965.020	1.500.347
Eng. 141 C2.000												1.500.616

A10 CONDENSER	A20 CONTACT SET	A40 DISTRIBUTOR CAP	A50 ROTOR	A70 PICK-UP
C10 COIL	C20 IGNITION MODULE	C30 ELECTRONIC IGNITION KIT	E01 IGNITION CABLE SET	

Vehicle	alim.	kW	Date	Engine	FUNCTIONS ON THE VEHICLE							
					A10	A20	A40	A50	A70	C10 - C30	C20	E01

ENGINE				
1000 4x4	Petrol	37	01/86-12/92	156 A3.000

Engine	Information	A10	A20	A40	A50	A70	C10 - C30	C20	E01
All engines	version Marelli			1.330.109	1.430.060	1.930.180M			
All engines							1.970.158	C10	1.965.020
									1.500.347

ENGINE				
1000 Fire [CHE]	Petrol	33	11/87-04/91	156 A2.146

Engine	Information	A10	A20	A40	A50	A70	C10 - C30	C20	E01
All engines	version Marelli			1.330.109	1.430.060	1.930.180M			
All engines							1.970.108	C10	1.965.020
									1.500.347

ENGINE				
1000 Fire [DEU]	Petrol	33	01/86-07/89	156 A2.048

Engine	Information	A10	A20	A40	A50	A70	C10 - C30	C20	E01
All engines	version Marelli			1.330.109	1.430.060	1.930.180M			
All engines							1.970.101D	C10	1.965.020
									1.500.347

ENGINE				
1000 i.e	Petrol	33	08/92-02/04	156 A2.246

Engine	Information	A10	A20	A40	A50	A70	C10 - C30	C20	E01
All engines	version Bosch SPi, version Marelli			1.330.109	1.430.060	1.930.180M			
All engines	version Bosch SPi						1.970.108	C10	1.965.020
All engines	Qty: 2, version Weber SPi						1.970.146	C10	
All engines	eng. type 5524923 ->, version Weber SPi								1.500.616
All engines	->eng. 5524923, version Weber SPi								1.500.887

ENGINE				
1000 i.e. Cat	Petrol	33	10/87-08/98	141 C2.000, 156 A2.246

Engine	Information	A10	A20	A40	A50	A70	C10 - C30	C20	E01
Eng. 156 A2.246	version Bosch SPi, version Marelli			1.330.109	1.430.060	1.930.180M			
All engines	version Bosch SPi						1.970.108	C10	1.965.020
All engines	Qty: 2, version Weber SPi						1.970.146	C10	
Eng. 156 A2.246	version Bosch SPi							1.965.020	1.500.347
All engines	eng. type 5524923 ->, version Weber SPi								1.500.616
Eng. 156 A2.246	->eng. 5524923, version Weber SPi								1.500.887

ENGINE				
1100	Petrol	37	05/91-12/99	156 C.046

Engine	Information	A10	A20	A40	A50	A70	C10 - C30	C20	E01
All engines	Qty: 2						1.970.146	C10	
All engines	eng. type 5524923 ->								1.500.616
All engines	->eng. 5524923								1.500.887

ENGINE				
1100	Petrol	40	02/95-09/03	176 B2.000, 187 A1.000

Engine	Information	A10	A20	A40	A50	A70	C10 - C30	C20	E01
All engines	Qty: 2						1.970.146	C10	
Eng. 176 B2.000									1.500.616
Eng. 187 A1.000									1.501.451

ENGINE				
1100 4x4	Petrol	40	02/95-07/04	176 B2.000

Engine	Information	A10	A20	A40	A50	A70	C10 - C30	C20	E01
All engines	Qty: 2						1.970.146	C10	
All engines									1.500.616

ENGINE				
1100 i.e.	Petrol	37	01/86-04/91	156 C.046

Engine	Information	A10	A20	A40	A50	A70	C10 - C30	C20	E01
All engines	version Marelli			1.330.109	1.430.060	1.930.180M			
All engines							1.970.108	C10	1.965.020

ENGINE				
1100 i.e. 4x4	Petrol	37	12/00->	187 A1.000

Engine	Information	A10	A20	A40	A50	A70	C10 - C30	C20	E01
All engines	Qty: 2						1.970.146	C10	
All engines									1.501.451

A10 CONDENSER	A20 CONTACT SET	A40 DISTRIBUTOR CAP	A50 ROTOR	A70 PICK-UP
C10 COIL	C20 IGNITION MODULE	C30 ELECTRONIC IGNITION KIT	E01 IGNITION CABLE SET	

The present application list is a brief version. For the detailed information about the possibility of installation on a specific vehicle, please refer to our web-catalogue <http://catalogo.facet.eu/>

Vehicle	alim.	kW	Date	Engine	FUNCTIONS ON THE VEHICLE							
					A10	A20	A40	A50	A70	C10 - C30	C20	E01

ENGINE				
1100 Trekking 4x4	Petrol	37	10/91-07/04	156 C.046

Engine	Information	A10	A20	A40	A50	A70	C10 - C30	C20	E01
All engines	->year 01/01/93, version Marelli			1.330.109	1.430.060	1.930.180M			
All engines	->year 01/01/93, version Bosch SPi						1.970.108	C10	1.500.347
All engines	01/01/93 ->, version Weber SPi, Qty: 2						1.970.146	C10	
All engines	->year 01/01/93							1.965.020	
All engines	eng. type 5524923 ->, version Weber SPi								1.500.616
All engines	->eng. 5524923, version Weber SPi								1.500.887

ENGINE				
650	Petrol	22	01/82-07/04	141 A.000

Engine	Information	A10	A20	A40	A50	A70	C10 - C30	C20	E01
All engines	version Marelli		1.230.120						

ENGINE				
750	Petrol	25	01/86-10/03	141 B.000, 156 A4.000

Engine	Information	A10	A20	A40	A50	A70	C10 - C30	C20	E01
Eng. 141 B.000	version Ducellier	1.115.039	1.215.122	1.315.058	1.415.083R				
Eng. 141 B.000	version Marelli	1.130.128	1.230.146M	1.330.098	1.430.047R				
Eng. 156 A4.000	version Marelli		1.230.149M	1.330.109	1.430.060				
Eng. 156 A4.000	version Ducellier			1.315.080	1.415.094				
All engines							1.970.101D	C10	
Eng. 156 A4.000									1.500.347
Eng. 141 B.000									1.500.466

ENGINE				
750 Cat	Petrol	25	01/95-10/03	156 A4.048

Engine	Information	A10	A20	A40	A50	A70	C10 - C30	C20	E01
All engines	version Ducellier			1.315.080	1.415.094			1.965.029	
All engines	version Marelli			1.330.109	1.430.060	1.930.180M		1.965.020	
All engines							1.970.158	C10	1.500.347

ENGINE				
750 Fire	Petrol	25	11/88-04/91	156 A4.048

Engine	Information	A10	A20	A40	A50	A70	C10 - C30	C20	E01
All engines	version Ducellier			1.315.080	1.415.094			1.965.029	
All engines	version Marelli			1.330.109	1.430.060	1.930.180M		1.965.020	
All engines							1.970.158	C10	1.500.347

ENGINE				
800	Petrol	25	02/81-12/85	100 GL6.000

Engine	Information	A10	A20	A40	A50	A70	C10 - C30	C20	E01
All engines	version Ducellier	1.115.039	1.215.106	1.315.058	1.415.083R				
All engines	version Marelli	1.130.117	1.230.142		1.430.042R				
All engines	version Femsas		1.217.020		1.417.052R				
All engines							1.970.101D	C10	1.500.386

ENGINE				
900	Petrol	29	04/92-12/96	1170 A1.046

Engine	Information	A10	A20	A40	A50	A70	C10 - C30	C20	E01
All engines	Qty: 2						1.970.146	C10	
All engines	->year 01/10/96								1.500.615
All engines	01/10/96 ->								1.501.527

ENGINE				
900	Petrol	33	10/80-06/94	100 GL3.000

Engine	Information	A10	A20	A40	A50	A70	C10 - C30	C20	E01
All engines	version Ducellier	1.115.039	1.215.122	1.315.058	1.415.083R				
All engines	version Marelli	1.130.128	1.230.146M	1.330.098	1.430.047R				
All engines							1.970.101D	C10	1.500.466

ENGINE				
900 CL	Petrol	33	01/86-12/92	146 A.048

Engine	Information	A10	A20	A40	A50	A70	C10 - C30	C20	E01
All engines	version Ducellier	1.115.039	1.215.122	1.315.058	1.415.083R				
All engines	version Marelli	1.130.128	1.230.146M	1.330.098	1.430.047R				
All engines							1.970.101D	C10	1.500.466

A10 CONDENSER	A20 CONTACT SET	A40 DISTRIBUTOR CAP	A50 ROTOR	A70 PICK-UP
C10 COIL	C20 IGNITION MODULE	C30 ELECTRONIC IGNITION KIT	E01 IGNITION CABLE SET	

Vehicle	alim.	kW	Date	Engine	FUNCTIONS ON THE VEHICLE							
					A10	A20	A40	A50	A70	C10 - C30	C20	E01
ENGINE												
900 i.e.	Petrol	29	01/98->	1170 A1.046								
Engine	Information			A10	A20	A40	A50	A70	C10 - C30	C20	E01	
All engines	Qty: 2								1.970.146	C10		
All engines											1.501.527	
ENGINE												
950	Petrol	35	09/82-08/83	A 112 B1.054								
Engine	Information			A10	A20	A40	A50	A70	C10 - C30	C20	E01	
All engines	version Marelli			1.130.117	1.230.142		1.430.042R					
All engines									1.970.101D	C10	1.500.386	
ENGINE												
950 4x4	Petrol	35	09/83-12/86	A 112 B1.054								
Engine	Information			A10	A20	A40	A50	A70	C10 - C30	C20	E01	
All engines	version Marelli			1.130.117	1.230.142		1.430.042R					
All engines									1.970.101D	C10		
PANDA II												
ENGINE												
1.1	Petrol	40	09/03->	187 A1.000								
Engine	Information			A10	A20	A40	A50	A70	C10 - C30	C20	E01	
All engines	x 1, D.I.S., connector type DIN								1.970.146	C10		
All engines											1.501.451	
ENGINE												
1.2	Petrol	44	09/03->	188 A4.000								
Engine	Information			A10	A20	A40	A50	A70	C10 - C30	C20	E01	
All engines	x 1, D.I.S., connector type DIN								1.970.146	C10		
All engines											1.501.451	
ENGINE												
1.2	Petrol	51	03/10->	169 A4.000								
Engine	Information			A10	A20	A40	A50	A70	C10 - C30	C20	E01	
All engines	x 1, D.I.S.								1.970.423	C10		
All engines											1.499.170	
ENGINE												
1.2 4x4	Petrol	44	09/04->	188 A4.000								
Engine	Information			A10	A20	A40	A50	A70	C10 - C30	C20	E01	
All engines	x 1, D.I.S., connector type DIN								1.970.146	C10		
All engines											1.501.451	
ENGINE												
1.2 4x4	Petrol	51	04/10->	169 A4.000								
Engine	Information			A10	A20	A40	A50	A70	C10 - C30	C20	E01	
All engines	x 1, D.I.S.								1.970.423	C10		
All engines											1.499.170	
ENGINE												
1.2 Bipower	Petrol/ Ethanol	44	09/04-12/11	188 A4.000								
Engine	Information			A10	A20	A40	A50	A70	C10 - C30	C20	E01	
All engines	x 1, D.I.S., connector type DIN								1.970.146	C10		
ENGINE												
1.2 LPG	Petrol/ Liquified Petro- leum Gas (LPG)	44	04/09->	188 A4.000								
Engine	Information			A10	A20	A40	A50	A70	C10 - C30	C20	E01	
All engines	x 1, D.I.S., connector type DIN								1.970.146	C10		
All engines											1.501.451	
ENGINE												
1.2 LPG	Petrol/ Liquified Petro- leum Gas (LPG)	51	09/10->	169 A4.000								
Engine	Information			A10	A20	A40	A50	A70	C10 - C30	C20	E01	
All engines	x 1, D.I.S.								1.970.423	C10		

A10	CONDENSER	A20	CONTACT SET	A40	DISTRIBUTOR CAP	A50	ROTOR	A70	PICK-UP
C10	COIL	C20	IGNITION MODULE	C30	ELECTRONIC IGNITION KIT	E01	IGNITION CABLE SET		

The present application list is a brief version. For the detailed information about the possibility of installation on a specific vehicle, please refer to our web-catalogue <http://catalogo.facet.eu/>

Vehicle	alim.	kW	Date	Engine	FUNCTIONS ON THE VEHICLE							
					A10	A20	A40	A50	A70	C10 - C30	C20	E01

ENGINE				
1.2 Natural Power	Petrol/ Compressed Natural Gas (CNG)	44	01/07-12/11	188 A4.000, 188A4000C-NG

Engine	Information	A10	A20	A40	A50	A70	C10 - C30	C20	E01
Eng. 188 A4.000	Qty: 2						1.970.146	C10	
Eng. 188A4000CNG	x 1, D.I.S., connector type DIN						1.970.146	C10	
Eng. 188A4000CNG	x 1, D.I.S.						1.970.423	C10	
Eng. 188 A4.000									1.501.451

ENGINE				
1.4	Petrol	74	10/06->	169 A3.000

Engine	Information	A10	A20	A40	A50	A70	C10 - C30	C20	E01
All engines	x 4, COIL ON PLUG, incl. spark plug connector						1.970.442	C10	

ENGINE				
1.4 16V	Petrol	51	01/10->	--

Engine	Information	A10	A20	A40	A50	A70	C10 - C30	C20	E01
All engines							1.970.423	C10	1.499.170

ENGINE				
1.4 Natural Power	Petrol/ Compressed Natural Gas (CNG)	51	01/12-12/12	350 A1.000

Engine	Information	A10	A20	A40	A50	A70	C10 - C30	C20	E01
All engines							1.970.423	C10	1.499.170

ENGINE				
1.4 Natural Power	Petrol/ Compressed Natural Gas (CNG)	57	10/09->	350 A1.000, 350A1000C-NG

Engine	Information	A10	A20	A40	A50	A70	C10 - C30	C20	E01
Eng. 350 A1.000							1.970.423	C10	1.499.170
Eng. 350A1000CNG	x 1, D.I.S.						1.970.423	C10	

PANDA III

ENGINE				
0.9	Petrol	44	12/13->	312 A4.000, 312 A6.000

Engine	Information	A10	A20	A40	A50	A70	C10 - C30	C20	E01
Eng. 312 A4.000	naturally Asp. Eng., Qty: 2						1.970.442	C10	
Eng. 312 A6.000	x 2, COIL ON PLUG, incl. spark plug connector						1.970.442	C10	

ENGINE				
0.9	Petrol	48	02/12->	312 A4.000

Engine	Information	A10	A20	A40	A50	A70	C10 - C30	C20	E01
All engines	x 2, COIL ON PLUG, incl. spark plug connector						1.970.442	C10	

ENGINE				
0.9	Petrol	57	02/12->	312 A7.000

Engine	Information	A10	A20	A40	A50	A70	C10 - C30	C20	E01
All engines	naturally Asp. Eng., Qty: 2						1.970.442	C10	

ENGINE				
0.9	Petrol	59	11/13->	312 A5.000

Engine	Information	A10	A20	A40	A50	A70	C10 - C30	C20	E01
All engines	naturally Asp. Eng., Qty: 2						1.970.442	C10	

ENGINE				
0.9 4x4	Petrol	66	06/14->	312 A2.000

Engine	Information	A10	A20	A40	A50	A70	C10 - C30	C20	E01
All engines	naturally Asp. Eng., Qty: 2						1.970.442	C10	

ENGINE				
1.2	Petrol	51	02/12->	169 A4.000

Engine	Information	A10	A20	A40	A50	A70	C10 - C30	C20	E01
All engines	x 1, D.I.S.						1.970.423	C10	
All engines									1.499.170

A10 CONDENSER	A20 CONTACT SET	A40 DISTRIBUTOR CAP	A50 ROTOR	A70 PICK-UP
C10 COIL	C20 IGNITION MODULE	C30 ELECTRONIC IGNITION KIT	E01 IGNITION CABLE SET	

Vehicle	alim.	kW	Date	Engine	FUNCTIONS ON THE VEHICLE									
					A10	A20	A40	A50	A70	C10 - C30	C20	E01		
ENGINE														
1.2 LPG	Petrol/ Liquified Petro- leum Gas (LPG)	51	06/12->	169 A4.000										
ENGINE														
All engines					A10	A20	A40	A50	A70	C10 - C30	C20	E01		
All engines										1.970.423	C10			1.499.170
PUNTO I														
1.1	Petrol	40	04/96-02/00	176 B2.000										
ENGINE														
All engines					A10	A20	A40	A50	A70	C10 - C30	C20	E01		
All engines										1.970.146	C10			1.500.616
1.2 16V	Petrol	63	04/97-09/99	176 B9.000										
ENGINE														
All engines					A10	A20	A40	A50	A70	C10 - C30	C20	E01		
All engines										1.970.146	C10			1.501.504
1.4 GT Turbo	Petrol	96	09/96-07/99	176 B6.000										
ENGINE														
All engines					A10	A20	A40	A50	A70	C10 - C30	C20	E01		
All engines										1.970.168	C10			1.500.613
1.4 GT Turbo	Petrol	98	10/93-03/97	176 A4.000										
ENGINE														
All engines					A10	A20	A40	A50	A70	C10 - C30	C20	E01		
All engines										1.970.168	C10			1.500.613
1.6	Petrol	65	01/94-04/97	176 A9.000										
ENGINE														
All engines					A10	A20	A40	A50	A70	C10 - C30	C20	E01		
All engines														1.500.888
55 1.1	Petrol	40	09/93-09/99	176 A6.000, 176 B2.000										
ENGINE														
All engines					A10	A20	A40	A50	A70	C10 - C30	C20	E01		
All engines										1.970.146	C10			1.500.616
60 1.2	Petrol	43	01/94-06/00	176 A7.000										
ENGINE														
All engines					A10	A20	A40	A50	A70	C10 - C30	C20	E01		
All engines										1.970.146	C10			1.500.616
60 1.2	Petrol	44	09/93-06/00	176 B1.000, 176 B4.000										
ENGINE														
All engines					A10	A20	A40	A50	A70	C10 - C30	C20	E01		
All engines										1.970.146	C10			1.500.616
75 1.2	Petrol	54	10/93-09/99	176 A8.000										
ENGINE														
All engines					A10	A20	A40	A50	A70	C10 - C30	C20	E01		
All engines										1.970.146	C10			1.500.616
85 16V 1.2	Petrol	63	04/97-06/00	176 B9.000										
ENGINE														
All engines					A10	A20	A40	A50	A70	C10 - C30	C20	E01		
All engines										1.970.146	C10			1.501.504
90 1.6	Petrol	65	04/94-04/97	176 A9.000										
ENGINE														
All engines					A10	A20	A40	A50	A70	C10 - C30	C20	E01		
All engines														1.500.888

A10 CONDENSER	A20 CONTACT SET	A40 DISTRIBUTOR CAP	A50 ROTOR	A70 PICK-UP
C10 COIL	C20 IGNITION MODULE	C30 ELECTRONIC IGNITION KIT	E01 IGNITION CABLE SET	

The present application list is a brief version. For the detailed information about the possibility of installation on a specific vehicle, please refer to our web-catalogue <http://catalogo.facet.eu/>

					FUNCTIONS ON THE VEHICLE							
Vehicle	alim.	kW	Date	Engine								
					A10	A20	A40	A50	A70	C10 - C30	C20	E01

PUNTO II

				ENGINE
1.2 16V	Petrol	59	06/03->	188 A5.000

Engine	Information	A10	A20	A40	A50	A70	C10 - C30	C20	E01
All engines							1.970.168	C10	1.501.505

				ENGINE
1.2 16V 80	Petrol	59	09/99-04/06	188 A5.000

Engine	Information	A10	A20	A40	A50	A70	C10 - C30	C20	E01
All engines	x 1, D.I.S., connector type, saw teeth						1.970.168	C10	
All engines									1.501.505

				ENGINE
1.2 60	Petrol	44	09/99-12/10	188 A4.000

Engine	Information	A10	A20	A40	A50	A70	C10 - C30	C20	E01
All engines	x 1, D.I.S., connector type DIN						1.970.146	C10	
All engines									1.501.451

				ENGINE
1.2 Bifuel	Petrol/ Liquified Petro- leum Gas (LPG)	44	08/07-03/12	188 A4.000

Engine	Information	A10	A20	A40	A50	A70	C10 - C30	C20	E01
All engines	x 1, D.I.S., connector type DIN						1.970.146	C10	
All engines									1.501.451

				ENGINE
1.2 Bipower	Petrol/ Ethanol	44	08/01-05/03	188 A4.000

Engine	Information	A10	A20	A40	A50	A70	C10 - C30	C20	E01
All engines	x 1, D.I.S., connector type DIN						1.970.146	C10	

				ENGINE
1.2 Natural Power	Petrol/ Com- pressed Natural Gas (CNG)	38	04/04-04/06	188 A4.000, 188A4000C- NG

Engine	Information	A10	A20	A40	A50	A70	C10 - C30	C20	E01
Eng. 188 A4.000	Qty: 2						1.970.146	C10	
Eng. 188A4000CNG	x 1, D.I.S., connector type DIN						1.970.146	C10	
Eng. 188 A4.000									1.501.451

				ENGINE
1.2 Natural Power	Petrol/ Com- pressed Natural Gas (CNG)	44	01/03-03/12	188 A4.000, 188A4000C- NG

Engine	Information	A10	A20	A40	A50	A70	C10 - C30	C20	E01
Eng. 188 A4.000	Qty: 2						1.970.146	C10	
Eng. 188A4000CNG	x 1, D.I.S., connector type DIN						1.970.146	C10	
Eng. 188 A4.000									1.501.451

				ENGINE
1.4	Petrol	70	09/03-03/12	843 A1.000

Engine	Information	A10	A20	A40	A50	A70	C10 - C30	C20	E01
All engines	x 4, COIL ON PLUG, incl. spark plug connector						1.970.442	C10	

				ENGINE
1.4	Petrol	71	11/05->	199 A6.000

Engine	Information	A10	A20	A40	A50	A70	C10 - C30	C20	E01
All engines	Qty: 4						1.970.442	C10	

				ENGINE
1.8 130 HGT	Petrol	96	09/99-03/12	183 A1.000, 188 A6.000

Engine	Information	A10	A20	A40	A50	A70	C10 - C30	C20	E01
All engines	x 4, COIL ON PLUG, incl. spark plug connector						1.970.384	C10	

				ENGINE
1.8 16V	Petrol	96	06/03->	188 A6.000

Engine	Information	A10	A20	A40	A50	A70	C10 - C30	C20	E01
All engines	Qty: 4						1.970.384	C10	

A10 CONDENSER	A20 CONTACT SET	A40 DISTRIBUTOR CAP	A50 ROTOR	A70 PICK-UP
C10 COIL	C20 IGNITION MODULE	C30 ELECTRONIC IGNITION KIT	E01 IGNITION CABLE SET	

Vehicle	alim.	kW	Date	Engine	FUNCTIONS ON THE VEHICLE							
					A10	A20	A40	A50	A70	C10 - C30	C20	E01

PUNTO III

1.2	Petrol	49	02/14->	ENGINE 199 B9.000
-----	--------	----	---------	----------------------

Engine	Information	A10	A20	A40	A50	A70	C10 - C30	C20	E01
All engines	x 1, D.I.S.						1.970.423	C10	
All engines									1.499.170

1.2	Petrol	51	03/12->	ENGINE 169 A4.000
-----	--------	----	---------	----------------------

Engine	Information	A10	A20	A40	A50	A70	C10 - C30	C20	E01
All engines	x 1, D.I.S.						1.970.423	C10	
All engines									1.499.170

1.4	Petrol	55	03/12->	ENGINE 199A7000
-----	--------	----	---------	--------------------

Engine	Information	A10	A20	A40	A50	A70	C10 - C30	C20	E01
All engines	x 1, D.I.S.						1.970.423	C10	

1.4	Petrol	57	03/12->	ENGINE 350 A1.000
-----	--------	----	---------	----------------------

Engine	Information	A10	A20	A40	A50	A70	C10 - C30	C20	E01
All engines	x 1, D.I.S.						1.970.423	C10	
All engines									1.499.170

1.4 Bifuel	Petrol/ Liquified Petro- leum Gas (LPG)	57	03/12->	ENGINE 350 A1.000
------------	---	----	---------	----------------------

Engine	Information	A10	A20	A40	A50	A70	C10 - C30	C20	E01
All engines	x 1, D.I.S.						1.970.423	C10	

1.4 LPG	Petrol/ Liquified Petro- leum Gas (LPG)	57	03/12->	ENGINE 350 A1.000
---------	---	----	---------	----------------------

Engine	Information	A10	A20	A40	A50	A70	C10 - C30	C20	E01
All engines									1.499.170

1.4 Natural Power	Petrol/ Com- pressed Natural Gas (CNG)	57	03/09->	ENGINE 350 A1.000, 350A1000C- NG
-------------------	---	----	---------	--

Engine	Information	A10	A20	A40	A50	A70	C10 - C30	C20	E01
Eng. 350 A1.000							1.970.423	C10	1.499.170
Eng. 350A1000CNG	x 1, D.I.S.						1.970.423	C10	

1.4 Turbo Multi Air	Petrol	99	03/12->	ENGINE 955 A2.000
---------------------	--------	----	---------	----------------------

Engine	Information	A10	A20	A40	A50	A70	C10 - C30	C20	E01
All engines	x 4, COIL ON PLUG						1.970.549	C10	

PUNTO III / GRANDE PUNTO

1.2	Petrol	48	10/05->	ENGINE 199 A4.000
-----	--------	----	---------	----------------------

Engine	Information	A10	A20	A40	A50	A70	C10 - C30	C20	E01
All engines	x 1, D.I.S.						1.970.423	C10	
All engines									1.499.170

1.2	Petrol	51	09/10->	ENGINE 169 A4.000
-----	--------	----	---------	----------------------

Engine	Information	A10	A20	A40	A50	A70	C10 - C30	C20	E01
All engines	x 1, D.I.S.						1.970.423	C10	
All engines									1.499.170

1.2 [IND]	Petrol	48	01/08->	ENGINE --
-----------	--------	----	---------	--------------

Engine	Information	A10	A20	A40	A50	A70	C10 - C30	C20	E01
All engines							1.970.423	C10	1.499.170

A10 CONDENSER	A20 CONTACT SET	A40 DISTRIBUTOR CAP	A50 ROTOR	A70 PICK-UP
C10 COIL	C20 IGNITION MODULE	C30 ELECTRONIC IGNITION KIT	E01 IGNITION CABLE SET	

The present application list is a brief version. For the detailed information about the possibility of installation on a specific vehicle, please refer to our web-catalogue <http://catalogo.facet.eu/>

Vehicle	alim.	kW	Date	Engine	FUNCTIONS ON THE VEHICLE							
					A10	A20	A40	A50	A70	C10 - C30	C20	E01

ENGINE				
1.2 Actual	Petrol	48	09/09->	--

Engine	Information	A10	A20	A40	A50	A70	C10 - C30	C20	E01
All engines							1.970.423	C10	1.499.170

ENGINE				
1.2 LPG	Petrol/ Liquified Petro- leum Gas (LPG)	51	06/08-12/12	199 A4.000

Engine	Information	A10	A20	A40	A50	A70	C10 - C30	C20	E01
All engines	x 1, D.I.S.						1.970.423	C10	
All engines									1.499.170

ENGINE				
1.4	Petrol	55	10/05-07/07	199A7000, 858Y1

Engine	Information	A10	A20	A40	A50	A70	C10 - C30	C20	E01
Eng. 199A7000	x 1, D.I.S.						1.970.423	C10	
Eng. 858Y1									1.499.170

ENGINE				
1.4	Petrol	57	06/05-12/15	350 A1.000

Engine	Information	A10	A20	A40	A50	A70	C10 - C30	C20	E01
All engines	x 1, D.I.S.						1.970.423	C10	
All engines									1.499.170

ENGINE				
1.4 16V	Petrol	70	10/05-08/11	199 A6.000

Engine	Information	A10	A20	A40	A50	A70	C10 - C30	C20	E01
All engines	x 4, COIL ON PLUG, incl. spark plug connector						1.970.442	C10	

ENGINE				
1.4 16V [IND]	Petrol	70	01/08->	--

Engine	Information	A10	A20	A40	A50	A70	C10 - C30	C20	E01
All engines	Qty: 4						1.970.442	C10	

ENGINE				
1.4 Actual	Petrol	57	09/09->	--

Engine	Information	A10	A20	A40	A50	A70	C10 - C30	C20	E01
All engines							1.970.423	C10	1.499.170

ENGINE				
1.4 LPG	Petrol/ Liquified Petro- leum Gas (LPG)	57	12/08->	350 A1.000

Engine	Information	A10	A20	A40	A50	A70	C10 - C30	C20	E01
All engines	x 1, D.I.S.						1.970.423	C10	
All engines									1.499.170

ENGINE				
1.4 Natural Power	Petrol/ Com- pressed Natural Gas (CNG)	57	07/08->	350 A1.000, 350A1000C- NG

Engine	Information	A10	A20	A40	A50	A70	C10 - C30	C20	E01
Eng. 350 A1.000							1.970.423	C10	1.499.170
Eng. 350A1000CNG	x 1, D.I.S.						1.970.423	C10	

PUNTO III EVO

ENGINE				
1.2	Petrol	48	10/09-02/12	199 A4.000

Engine	Information	A10	A20	A40	A50	A70	C10 - C30	C20	E01
All engines	x 1, D.I.S.						1.970.423	C10	
All engines									1.499.170

ENGINE				
1.2	Petrol	51	10/09-02/12	169 A4.000

Engine	Information	A10	A20	A40	A50	A70	C10 - C30	C20	E01
All engines	x 1, D.I.S.						1.970.423	C10	
All engines									1.499.170

A10 CONDENSER	A20 CONTACT SET	A40 DISTRIBUTOR CAP	A50 ROTOR	A70 PICK-UP
C10 COIL	C20 IGNITION MODULE	C30 ELECTRONIC IGNITION KIT	E01 IGNITION CABLE SET	

				FUNCTIONS ON THE VEHICLE								
Vehicle	alim.	kW	Date	Engine								
				ENGINE								
1.6	Petrol	60	10/84-06/89	149 A.000								
				ENGINE								
Engine		Information		A10	A20	A40	A50	A70	C10 - C30	C20	E01	
All engines									1.970.101D	C10		
				ENGINE								
100 Super 1.6	Petrol	74	10/83-12/90	149 A2.000								
				ENGINE								
Engine		Information		A10	A20	A40	A50	A70	C10 - C30	C20	E01	
All engines		version Marelli				1.330.104	1.430.055R					
All engines									1.970.103	C10		
				ENGINE								
70 1.3	Petrol	48	09/83-07/89	149 A3.000								
				ENGINE								
Engine		Information		A10	A20	A40	A50	A70	C10 - C30	C20	E01	
All engines		->year 30/09/85, version Ducellier		1.115.039		1.315.054	1.415.083R					
All engines		version Marelli		1.130.127	1.230.146M	1.330.101	1.430.047R	1.930.176M				
All engines		->year 30/09/85							1.970.101D	C10		
All engines		01/10/85 ->							1.970.102	C10	1.965.020	1.500.354
				ENGINE								
70 1.3	Petrol	50	09/83-07/89	138 B2.000								
				ENGINE								
Engine		Information		A10	A20	A40	A50	A70	C10 - C30	C20	E01	
All engines		->year 30/09/85, version Ducellier		1.115.039		1.315.054	1.415.083R					
All engines		version Marelli		1.130.127	1.230.146M	1.330.101	1.430.047R	1.930.176M				
All engines		->year 30/09/85							1.970.101D	C10		
All engines		01/10/85 ->							1.970.102	C10	1.965.020	1.500.354
				ENGINE								
85 1.5	Petrol	58	05/85-12/87	149 A5.000								
				ENGINE								
Engine		Information		A10	A20	A40	A50	A70	C10 - C30	C20	E01	
All engines		+automatic transmission, version Marelli				1.330.101	1.430.047R					
All engines		version Marelli				1.330.104	1.430.055R					
All engines		+automatic transmission							1.970.102	C10		
All engines									1.970.103	C10		
				ENGINE								
85 1.6	Petrol	60	10/83-06/90	149 A.000								
				ENGINE								
Engine		Information		A10	A20	A40	A50	A70	C10 - C30	C20	E01	
All engines		version Ducellier		1.115.039		1.315.054	1.415.083R					
All engines		version Marelli		1.130.127	1.230.146M	1.330.101	1.430.047R					
All engines									1.970.101D	C10		
				ENGINE								
90 i.e. 1.6	Petrol	66	01/87-07/89	149 C2.000								
				ENGINE								
Engine		Information		A10	A20	A40	A50	A70	C10 - C30	C20	E01	
All engines		version Marelli				1.330.098	1.430.057R					
All engines								1.930.177/1				
RITMO I												
				ENGINE								
1.1	Petrol	43	04/85-12/87	146 A4.048								
				ENGINE								
Engine		Information		A10	A20	A40	A50	A70	C10 - C30	C20	E01	
All engines		version Ducellier		1.115.039		1.315.054	1.415.083R					
All engines		version Marelli			1.230.146M	1.330.101	1.430.047R					
All engines									1.970.101D	C10		
				ENGINE								
1.3	Petrol	48	11/83-08/85	149 A3.000								
				ENGINE								
Engine		Information		A10	A20	A40	A50	A70	C10 - C30	C20	E01	
All engines		version Ducellier		1.115.039	1.215.106	1.315.049	1.415.083R					
All engines		version Marelli				1.330.101	1.430.047R	1.930.176M				
All engines		->year 31/12/82							1.970.101D	C10		
All engines		01/01/83 ->							1.970.102	C10		
All engines											1.965.020	
				ENGINE								
1.5	Petrol	55	10/85-05/87	138 C2.048								
				ENGINE								
Engine		Information		A10	A20	A40	A50	A70	C10 - C30	C20	E01	
All engines		version Marelli				1.330.104	1.430.055R					
All engines									1.970.102	C10		

A10 CONDENSER	A20 CONTACT SET	A40 DISTRIBUTOR CAP	A50 ROTOR	A70 PICK-UP
C10 COIL	C20 IGNITION MODULE	C30 ELECTRONIC IGNITION KIT	E01 IGNITION CABLE SET	

Vehicle	alim.	kW	Date	Engine	FUNCTIONS ON THE VEHICLE							
					A10	A20	A40	A50	A70	C10 - C30	C20	E01

				ENGINE
1.6	Petrol	74	01/83-12/87	149 A4.000

Engine	Information	A10	A20	A40	A50	A70	C10 - C30	C20	E01
All engines	version Marelli			1.330.104	1.430.055R				
All engines							1.970.103	C10	

				ENGINE
105 1.6	Petrol	77	01/83-12/87	138 AR.000

Engine	Information	A10	A20	A40	A50	A70	C10 - C30	C20	E01
All engines	version Marelli				1.430.054R	1.930.161/1			

				ENGINE
75 1.5	Petrol	55	09/85-12/88	138 A2.000

Engine	Information	A10	A20	A40	A50	A70	C10 - C30	C20	E01
All engines	version Ducellier	1.115.039	1.215.106	1.315.049	1.415.083R				
All engines	version Marelli			1.330.104	1.430.055R				
All engines	->year 31/12/82						1.970.101D	C10	
All engines	01/01/83 ->						1.970.103	C10	

				ENGINE
2.0	Petrol	100	09/99-10/06	RFN

Engine	Information	A10	A20	A40	A50	A70	C10 - C30	C20	E01
All engines	x 4, COIL ON PLUG						1.970.408	C10	

				ENGINE
1.6	Petrol	58	02/96-12/06	220 A 2.000

Engine	Information	A10	A20	A40	A50	A70	C10 - C30	C20	E01
All engines	x 1, D.I.S., connector type, saw teeth						1.970.168	C10	
All engines									1.500.655

				ENGINE
2.0	Petrol	100	05/00-12/06	RFN, RFN (EW10J4)

Engine	Information	A10	A20	A40	A50	A70	C10 - C30	C20	E01
Eng. RFN	x 4, COIL ON PLUG						1.970.408	C10	
Eng. RFN (EW10J4)	incl. spark plug connector						1.970.408	C10	

				ENGINE
2.0 16V	Petrol	100	06/00-12/06	RFN, RFN (EW10J4)

Engine	Information	A10	A20	A40	A50	A70	C10 - C30	C20	E01
Eng. RFN	x 4, COIL ON PLUG						1.970.408	C10	
Eng. RFN (EW10J4)	incl. spark plug connector						1.970.408	C10	

				ENGINE
1.6 16V	Petrol	79	06/06-10/14	M16A

Engine	Information	A10	A20	A40	A50	A70	C10 - C30	C20	E01
All engines	x 2, SEMI-DIRECT						1.970.570	C10	
All engines	->year 15/06/09								1.499.013

				ENGINE
1.6 16V	Petrol	88	06/06-10/14	M16A

Engine	Information	A10	A20	A40	A50	A70	C10 - C30	C20	E01
All engines	->year 01/06/09, Fitting Position:for cylinder 1, Fitting Position:for cylinder 3, x 2, SEMI-DIRECT						1.970.570	C10	
All engines	->year 15/06/09								1.499.013

				ENGINE
1.6 16V 4x4	Petrol	79	06/06-10/14	M16A

Engine	Information	A10	A20	A40	A50	A70	C10 - C30	C20	E01
All engines	x 2, SEMI-DIRECT						1.970.570	C10	
All engines	->year 15/06/09								1.499.013

				ENGINE
1.6 16V 4x4	Petrol	88	06/06-10/14	M16A

Engine	Information	A10	A20	A40	A50	A70	C10 - C30	C20	E01
All engines	->year 15/06/09								1.499.013

A10	CONDENSER	A20	CONTACT SET	A40	DISTRIBUTOR CAP	A50	ROTOR	A70	PICK-UP
C10	COIL	C20	IGNITION MODULE	C30	ELECTRONIC IGNITION KIT	E01	IGNITION CABLE SET		

The present application list is a brief version. For the detailed information about the possibility of installation on a specific vehicle, please refer to our web-catalogue <http://catalogo.facet.eu/>

FUNCTIONS ON THE VEHICLE

Vehicle	alim.	kW	Date	Engine	 A10	 A20	 A40	 A50	 A70	 C10 - C30	 C20	 E01
---------	-------	----	------	--------	---	---	---	--	---	---	---	---

SEICENTO / 600

				ENGINE
0.9	Petrol	29	11/97-01/10	1170 A1.046

Engine	Information	A10	A20	A40	A50	A70	C10 - C30	C20	E01
All engines	x 1, D.I.S., connector type DIN						1.970.146	C10	
All engines									1.501.615

				ENGINE
1.1	Petrol	40	01/98-01/10	176 B2.000, 187 A1.000

Engine	Information	A10	A20	A40	A50	A70	C10 - C30	C20	E01
All engines	x 1, D.I.S., connector type DIN						1.970.146	C10	
Eng. 176 B2.000									1.501.616
Eng. 187 A1.000									1.501.451

SIENA

				ENGINE
1.2	Petrol	44	01/98->	178 B7.045

Engine	Information	A10	A20	A40	A50	A70	C10 - C30	C20	E01
All engines	Qty: 2						1.970.146	C10	
All engines	->eng. 2935743								1.501.616
All engines	eng. type 2935743 ->								1.501.451

				ENGINE
1.3	Petrol	44	09/01-12/12	178 C4.066, 188 A4.000

Engine	Information	A10	A20	A40	A50	A70	C10 - C30	C20	E01
Eng. 178 C4.066	Qty: 2						1.970.146	C10	
Eng. 188 A4.000	x 1, D.I.S., connector type DIN						1.970.146	C10	
All engines	->eng. 2935743								1.501.616
All engines	eng. type 2935743 ->								1.501.451

				ENGINE
1.3	Petrol	54	09/98-12/02	178 B5.000

Engine	Information	A10	A20	A40	A50	A70	C10 - C30	C20	E01
All engines	x 1, D.I.S., connector type DIN						1.970.146	C10	
All engines	->eng. 2935743								1.501.616
All engines	eng. type 2935743 ->								1.501.451

				ENGINE
1.3	Petrol	59	09/01-12/09	188 A5.000

Engine	Information	A10	A20	A40	A50	A70	C10 - C30	C20	E01
All engines	FOR: (EU), x 1, D.I.S., connector type, saw teeth						1.970.168	C10	
All engines	NOT FOR: (EU), x 1, D.I.S.						1.970.416	C10	
All engines	->eng. 2935743								1.501.616
All engines	eng. type 2935743 ->								1.501.451

				ENGINE
1.4	Petrol	51	04/96-12/09	178 B2.000, 178 B2.016

Engine	Information	A10	A20	A40	A50	A70	C10 - C30	C20	E01
All engines	x 1, D.I.S., connector type DIN						1.970.146	C10	

				ENGINE
1.4 Cat	Petrol	51	04/96-12/09	178 B2.000, 178 B2.016

Engine	Information	A10	A20	A40	A50	A70	C10 - C30	C20	E01
All engines	x 1, D.I.S., connector type DIN						1.970.146	C10	

				ENGINE
1.5	Petrol	62	06/04->	178 E5.022

Engine	Information	A10	A20	A40	A50	A70	C10 - C30	C20	E01
All engines	Qty: 2						1.970.146	C10	
All engines	x 1, D.I.S., connector type DIN						1.970.146	C10	

				ENGINE
1.6	Petrol	76	11/00-12/12	182 B6.000

Engine	Information	A10	A20	A40	A50	A70	C10 - C30	C20	E01
All engines	x 1, D.I.S., connector type, saw teeth						1.970.345	C10	
All engines									1.501.503

				ENGINE
1.6 16V	Petrol	74	09/98-12/09	178 B3.000

Engine	Information	A10	A20	A40	A50	A70	C10 - C30	C20	E01
All engines	x 1, D.I.S., connector type, saw teeth						1.970.345	C10	
All engines									1.501.503

A10 CONDENSER	A20 CONTACT SET	A40 DISTRIBUTOR CAP	A50 ROTOR	A70 PICK-UP
C10 COIL	C20 IGNITION MODULE	C30 ELECTRONIC IGNITION KIT	E01 IGNITION CABLE SET	

Vehicle	alim.	kW	Date	Engine	FUNCTIONS ON THE VEHICLE									
					A10	A20	A40	A50	A70	C10 - C30	C20	E01		
ENGINE														
1.6 16V	Petrol	76	03/99->	178 D2.011, 182 B6.000										
Engine	Information				A10	A20	A40	A50	A70	C10 - C30	C20	E01		
All engines										1.970.345	C10		1.501.503	
STILO														
ENGINE														
1.2 16V	Petrol	59	02/02-11/06	188 A5.000										
Engine	Information				A10	A20	A40	A50	A70	C10 - C30	C20	E01		
All engines	x 4, COIL ON PLUG, incl. spark plug connector									1.970.442	C10			
ENGINE														
1.4	Petrol	70	01/04-08/08	843 A1.000										
Engine	Information				A10	A20	A40	A50	A70	C10 - C30	C20	E01		
All engines	x 4, COIL ON PLUG, incl. spark plug connector									1.970.442	C10			
ENGINE														
1.4 16V	Petrol	66	03/05-08/08	192 B2.000										
Engine	Information				A10	A20	A40	A50	A70	C10 - C30	C20	E01		
All engines	x 4, COIL ON PLUG, incl. spark plug connector									1.970.442	C10			
ENGINE														
1.4 16V	Petrol	70	10/03-08/08	843 A1.000										
Engine	Information				A10	A20	A40	A50	A70	C10 - C30	C20	E01		
All engines	x 4, COIL ON PLUG, incl. spark plug connector									1.970.442	C10			
ENGINE														
1.6	Petrol	77	04/05-08/08	192 B3.000										
Engine	Information				A10	A20	A40	A50	A70	C10 - C30	C20	E01		
All engines	x 4, COIL ON PLUG									1.970.450	C10			
ENGINE														
1.6 16V	Petrol	77	03/05-12/07	192 B3.000										
Engine	Information				A10	A20	A40	A50	A70	C10 - C30	C20	E01		
All engines	x 4, COIL ON PLUG									1.970.450	C10			
ENGINE														
1.8 16V	Petrol	98	10/01-08/08	192 A4.000										
Engine	Information				A10	A20	A40	A50	A70	C10 - C30	C20	E01		
All engines	x 4, COIL ON PLUG, incl. spark plug connector									1.970.384	C10			
STRADA														
ENGINE														
1.2	Petrol	44	04/03->	188 A4.000										
Engine	Information				A10	A20	A40	A50	A70	C10 - C30	C20	E01		
All engines	x 1, D.I.S., connector type DIN									1.970.146	C10			
All engines	->eng. 2935743												1.500.616	
All engines	eng. type 2935743 ->												1.501.451	
ENGINE														
1.2	Petrol	54	06/99->	178 B5.000, 178 B7.045										
Engine	Information				A10	A20	A40	A50	A70	C10 - C30	C20	E01		
Eng. 178 B5.000	x 1, D.I.S., connector type DIN									1.970.146	C10			
Eng. 178 B7.045	Qty: 2									1.970.146	C10			
All engines	->eng. 2935743												1.500.616	
All engines	eng. type 2935743 ->												1.501.451	
ENGINE														
1.2 Trekking	Petrol	60	11/05->	--, 178 B7.045										
Engine	Information				A10	A20	A40	A50	A70	C10 - C30	C20	E01		
Eng. --	Qty: 2									1.970.146	C10			
Eng. 178 B7.045	x 1, D.I.S., connector type DIN									1.970.146	C10			
Eng. --	->eng. 2935743												1.500.616	
Eng. --	eng. type 2935743 ->												1.501.451	
TALENTO														
ENGINE														
2.0	Petrol	55	03/89-03/94	170 B										
Engine	Information				A10	A20	A40	A50	A70	C10 - C30	C20	E01		
All engines	version Ducellier						1.315.054	1.415.094						
All engines											1.965.005			

A10 CONDENSER	A20 CONTACT SET	A40 DISTRIBUTOR CAP	A50 ROTOR	A70 PICK-UP
C10 COIL	C20 IGNITION MODULE	C30 ELECTRONIC IGNITION KIT	E01 IGNITION CABLE SET	

The present application list is a brief version. For the detailed information about the possibility of installation on a specific vehicle, please refer to our web-catalogue <http://catalogo.facet.eu/>

Vehicle	alim.	kW	Date	Engine	FUNCTIONS ON THE VEHICLE							
					A10	A20	A40	A50	A70	C10 - C30	C20	E01

TEMPRA				
1.4 i.e.	Petrol	51	04/90-08/96	ENGINE 159 A2.000, 160 A1.046, 836 A4.000

Engine	Information	A10	A20	A40	A50	A70	C10 - C30	C20	E01
Eng. 159 A2.000	version Marelli			1.330.101		1.930.176M			
Eng. 160 A1.046	->eng. 8503995, version Marelli			1.330.104					
Eng. 160 A1.046	eng. type 8503995 -, version Marelli			1.330.115					
Eng. 159 A2.000, 160 A1.046	->eng. 8813854, version Marelli				1.430.059				
Eng. 159 A2.000, 160 A1.046	eng. type 8813854 -, version Marelli				1.430.060				
Eng. 160 A1.046	eng. type 8813854 -, version Marelli					1.930.177/1			
Eng. 159 A2.000, 160 A1.046	->year 31/03/93						1.970.108	C10	
Eng. 160 A1.046	01/04/93 ->						1.970.148	C10	
Eng. 836 A4.000							1.970.168	C10	1.500.655
Eng. 159 A2.000								1.965.020	1.500.354
Eng. 160 A1.046	->eng. 8503995								1.500.808
Eng. 160 A1.046	eng. type 8503995 ->								1.500.815

TEMPRA				
1.4 i.e.	Petrol	57	03/91-08/96	ENGINE 159 A2.000

Engine	Information	A10	A20	A40	A50	A70	C10 - C30	C20	E01
All engines	version Marelli			1.330.101		1.930.176M			
All engines	->eng. 8813854, version Marelli				1.430.059				
All engines	eng. type 8813854 -, version Marelli				1.430.060				
All engines							1.970.108	C10	1.965.020
All engines									1.500.354

TEMPRA				
1.6	Petrol	51	04/90-07/96	ENGINE 159 A3.048

Engine	Information	A10	A20	A40	A50	A70	C10 - C30	C20	E01
All engines	+automatic transmission, +air conditioning, +power steering, eng. type 8327193 -, ->eng. 8503995, version Marelli			1.330.104					
All engines	+air conditioning, Selecta, 01/01/93 -, version Marelli			1.330.114					
All engines	->eng. 8327193, version Marelli, +automatic transmission, +power steering, +air conditioning, eng. type 8503995 -, ->year 01/01/93, 01/01/93 -, Selecta			1.330.115					
All engines	version Marelli, Colour:Black				1.430.055R				
All engines	->eng. 8813854, version Marelli, Colour:White				1.430.059				
All engines	eng. type 8813854 -, version Marelli, Colour:White				1.430.060				
All engines	eng. type 8813854 -, version Marelli					1.930.177/1			
All engines							1.970.148	C10	1.500.815
All engines	Selecta								1.500.808

TEMPRA				
1.6	Petrol	63	03/90-12/96	ENGINE 159 A3.000

Engine	Information	A10	A20	A40	A50	A70	C10 - C30	C20	E01
All engines	+automatic transmission, +air conditioning, +power steering, eng. type 8327193 -, ->eng. 8503995, version Marelli			1.330.104					
All engines	+air conditioning, Selecta, 01/01/93 -, version Marelli			1.330.114					
All engines	->eng. 8327193, version Marelli, +automatic transmission, +power steering, +air conditioning, eng. type 8503995 -, ->year 01/01/93, 01/01/93 -, Selecta			1.330.115					
All engines	version Marelli, Colour:Black				1.430.055R				
All engines	->eng. 8813854, version Marelli, Colour:White				1.430.059				
All engines	eng. type 8813854 -, version Marelli, Colour:White				1.430.060				
All engines	eng. type 8813854 -, version Marelli					1.930.177/1			
All engines							1.970.148	C10	1.500.815
All engines	Selecta								1.500.808

TEMPRA				
1.6 i.e.	Petrol	55	06/92-08/96	ENGINE 159 A3.048, 835 C1.000

Engine	Information	A10	A20	A40	A50	A70	C10 - C30	C20	E01
Eng. 159 A3.048	+automatic transmission, +air conditioning, +power steering, eng. type 8327193 -, ->eng. 8503995, version Marelli			1.330.104					
Eng. 159 A3.048	+air conditioning, Selecta, 01/01/93 -, version Marelli			1.330.114					
Eng. 159 A3.048	->eng. 8327193, version Marelli, +automatic transmission, +power steering, +air conditioning, eng. type 8503995 -, ->year 01/01/93, 01/01/93 -, Selecta			1.330.115					
Eng. 159 A3.048	version Marelli, Colour:Black				1.430.055R				
Eng. 159 A3.048	->eng. 8813854, version Marelli, Colour:White				1.430.059				
Eng. 159 A3.048	eng. type 8813854 -, version Marelli, Colour:White				1.430.060				
Eng. 159 A3.048	eng. type 8813854 -, version Marelli					1.930.177/1			

A10 CONDENSER	A20 CONTACT SET	A40 DISTRIBUTOR CAP	A50 ROTOR	A70 PICK-UP
C10 COIL	C20 IGNITION MODULE	C30 ELECTRONIC IGNITION KIT	E01 IGNITION CABLE SET	

Vehicle	alim.	kW	Date	Engine	FUNCTIONS ON THE VEHICLE							
					A10	A20	A40	A50	A70	C10 - C30	C20	E01
ENGINE												
1.6 i.e.	Petrol	55	06/92-08/96	159 A3.048, 835 C1.000								
Engine	Information			A10	A20	A40	A50	A70	C10 - C30	C20	E01	
Eng. 159 A3.048									1.970.148	C10		
Eng. 835 C1.000									1.970.168	C10	1.500.655	
Eng. 159 A3.048	->eng. 7747268, +automatic transmission, +power steering, ->eng. 8503995, +automatic transmission, +power steering, +air conditioning										1.500.808	
Eng. 159 A3.048	eng. type 7747268 ->, +automatic transmission, +power steering, eng. type 8503995 ->										1.500.815	
ENGINE												
1.6 i.e.	Petrol	57	06/90-08/96	159 A3.046, 835 C1.000								
Engine	Information			A10	A20	A40	A50	A70	C10 - C30	C20	E01	
Eng. 159 A3.046	+automatic transmission, +air conditioning, +power steering, eng. type 8327193 ->, ->eng. 8503995, version Marelli					1.330.104						
Eng. 159 A3.046	+air conditioning, Selecta, 01/01/93 ->, version Marelli					1.330.114						
Eng. 159 A3.046	->eng. 8327193, version Marelli, +automatic transmission, +power steering, +air conditioning, eng. type 8503995 ->, ->year 01/01/93, 01/01/93 ->, Selecta					1.330.115						
Eng. 159 A3.046	version Marelli, Colour:Black						1.430.055R					
Eng. 159 A3.046	->eng. 8813854, version Marelli, Colour:White						1.430.059					
Eng. 159 A3.046	eng. type 8813854 ->, version Marelli, Colour:White						1.430.060					
Eng. 159 A3.046									1.970.148	C10		
Eng. 835 C1.000									1.970.168	C10	1.500.655	
Eng. 159 A3.046	->eng. 7747268, +automatic transmission, +power steering, ->eng. 8503995, +automatic transmission, +power steering, +air conditioning										1.500.808	
Eng. 159 A3.046	eng. type 7747268 ->, +automatic transmission, +power steering, eng. type 8503995 ->										1.500.815	
ENGINE												
1.6 i.e.	Petrol	63	06/94-08/96	159 B9.000								
Engine	Information			A10	A20	A40	A50	A70	C10 - C30	C20	E01	
All engines											1.500.888	
ENGINE												
1.6 i.e.	Petrol	66	06/94-08/96	159 B9.000								
Engine	Information			A10	A20	A40	A50	A70	C10 - C30	C20	E01	
All engines											1.500.888	
ENGINE												
1.8 4x4	Petrol	80	07/92-06/93	159 A4.000								
Engine	Information			A10	A20	A40	A50	A70	C10 - C30	C20	E01	
All engines	+automatic transmission, ->eng. 1339267, version Marelli					1.330.104						
All engines	+automatic transmission, eng. type 1339267 ->, version Marelli					1.330.114						
All engines	version Marelli					1.330.115	1.430.060	1.930.177/1				
All engines									1.990.303	C30	1.500.692	
All engines	FOR: (SA)										1.500.398	
ENGINE												
1.8 i.e.	Petrol	66	09/93-08/96	835 C4.000								
Engine	Information			A10	A20	A40	A50	A70	C10 - C30	C20	E01	
All engines	Qty: 2								1.970.146	C10		
All engines											1.500.889	
ENGINE												
1.8 i.e.	Petrol	74	10/94-08/96	836 A5.000								
Engine	Information			A10	A20	A40	A50	A70	C10 - C30	C20	E01	
All engines	Qty: 2								1.970.146	C10		
All engines											1.500.889	
ENGINE												
1.8 i.e.	Petrol	76	09/93-08/96	835 C2.000								
Engine	Information			A10	A20	A40	A50	A70	C10 - C30	C20	E01	
All engines	Qty: 2								1.970.146	C10		
All engines											1.500.889	
ENGINE												
1.8 i.e.	Petrol	77	03/92-08/96	159 A4.046								
Engine	Information			A10	A20	A40	A50	A70	C10 - C30	C20	E01	
All engines	+automatic transmission, ->eng. 1339267, version Marelli					1.330.104						
All engines	+automatic transmission, eng. type 1339267 ->, version Marelli					1.330.114						

A10	CONDENSER	A20	CONTACT SET	A40	DISTRIBUTOR CAP	A50	ROTOR	A70	PICK-UP
C10	COIL	C20	IGNITION MODULE	C30	ELECTRONIC IGNITION KIT	E01	IGNITION CABLE SET		

The present application list is a brief version. For the detailed information about the possibility of installation on a specific vehicle, please refer to our web-catalogue <http://catalogo.facet.eu/>

FUNCTIONS ON THE VEHICLE

Vehicle	alim.	kW	Date	Engine								
---------	-------	----	------	--------	---	---	---	--	---	---	---	---

ENGINE				
1.8 i.e.	Petrol	77	03/92-08/96	159 A4.046

Engine	Information	A10	A20	A40	A50	A70	C10 - C30	C20	E01
All engines	version Marelli			1.330.115	1.430.060	1.930.177/1			
All engines							1.990.303	C30	1.500.692
All engines	FOR: (SA)								1.500.398

ENGINE				
1.8 i.e.	Petrol	81	03/90-08/96	159 A4.000

Engine	Information	A10	A20	A40	A50	A70	C10 - C30	C20	E01
All engines	+automatic transmission, ->eng. 1339267, version Marelli			1.330.104					
All engines	+automatic transmission, eng. type 1339267 ->, version Marelli			1.330.114					
All engines	version Marelli			1.330.115	1.430.060	1.930.177/1			
All engines							1.990.303	C30	1.500.692
All engines	FOR: (SA)								1.500.398

ENGINE				
2.0	Petrol	80	04/90-06/93	159 A6.046

Engine	Information	A10	A20	A40	A50	A70	C10 - C30	C20	E01
All engines	+automatic transmission, ->eng. 1339267, version Marelli			1.330.104					
All engines	+automatic transmission, eng. type 1339267 ->, version Marelli			1.330.114					
All engines	version Marelli			1.330.115	1.430.060	1.930.177/1			
All engines							1.990.303	C30	
All engines	->eng. 1518014								1.500.692

ENGINE				
2.0 i.e.	Petrol	83	10/90-09/96	159 A6.046

Engine	Information	A10	A20	A40	A50	A70	C10 - C30	C20	E01
All engines	+automatic transmission, ->eng. 1339267, version Marelli			1.330.104					
All engines	+automatic transmission, eng. type 1339267 ->, version Marelli			1.330.114					
All engines	version Marelli			1.330.115	1.430.060	1.930.177/1			
All engines							1.990.303	C30	
All engines	->eng. 1518014								1.500.692

ENGINE				
2.0 i.e. [BRA]	Petrol	81	04/93-12/96	159 A6.011

Engine	Information	A10	A20	A40	A50	A70	C10 - C30	C20	E01
All engines	+automatic transmission, version Marelli			1.330.114					
All engines	version Marelli			1.330.115	1.430.060	1.930.177/1			
All engines							1.990.303	C30	
All engines	->eng. 1518014								1.500.692

ENGINE				
2.0 i.e. 4x4	Petrol	83	03/92-03/95	159 A6.046

Engine	Information	A10	A20	A40	A50	A70	C10 - C30	C20	E01
All engines	+automatic transmission, ->eng. 1339267, version Marelli			1.330.104					
All engines	+automatic transmission, eng. type 1339267 ->, version Marelli			1.330.114					
All engines	version Marelli			1.330.115	1.430.060	1.930.177/1			
All engines							1.990.303	C30	
All engines	->eng. 1518014								1.500.692

TIPO I

ENGINE				
1.1	Petrol	41	01/88-10/91	160 A3.000

Engine	Information	A10	A20	A40	A50	A70	C10 - C30	C20	E01
All engines	version Ducellier			1.315.080	1.415.094			1.965.029	
All engines	version Marelli			1.330.109	1.430.060	1.930.180M		1.965.020	
All engines							1.970.108	C10	1.500.347

ENGINE				
1.1 i.e.	Petrol	37	10/94-10/95	156 C.046

Engine	Information	A10	A20	A40	A50	A70	C10 - C30	C20	E01
All engines							1.970.168	C10	1.500.694

A10 CONDENSER	A20 CONTACT SET	A40 DISTRIBUTOR CAP	A50 ROTOR	A70 PICK-UP
C10 COIL	C20 IGNITION MODULE	C30 ELECTRONIC IGNITION KIT	E01 IGNITION CABLE SET	

Vehicle	alim.	kW	Date	Engine	FUNCTIONS ON THE VEHICLE							
					A10	A20	A40	A50	A70	C10 - C30	C20	E01

ENGINE				
1.4	Petrol	52	07/87-12/89	160 A1.000, 160 A1.048

Engine	Information	A10	A20	A40	A50	A70	C10 - C30	C20	E01
Eng. 160 A1.000	version Marelli			1.330.101	1.430.047R	1.930.176M			
Eng. 160 A1.048	version Marelli			1.330.104					
Eng. 160 A1.048	->VET. 2415766, version Marelli				1.430.055R				
Eng. 160 A1.048	version Marelli, VET. 2415766 ->				1.430.059				
Eng. 160 A1.000							1.970.108	C10	1.965.020
Eng. 160 A1.048							1.970.148	C10	1.500.808

ENGINE				
1.4 i.e.	Petrol	51	05/89-04/95	160 A1.046, 836 A4.000

Engine	Information	A10	A20	A40	A50	A70	C10 - C30	C20	E01
Eng. 160 A1.046	->eng. 8503995, version Marelli			1.330.104					
Eng. 160 A1.046	eng. type 8503995 ->, version Marelli			1.330.115					
Eng. 160 A1.046	->VET. 2415766, version Marelli				1.430.055R				
Eng. 160 A1.046	version Marelli, VET. 2415766 ->				1.430.059				
Eng. 160 A1.046							1.970.148	C10	
Eng. 836 A4.000							1.970.168	C10	1.500.655
Eng. 160 A1.046	->eng. 8503995								1.500.808
Eng. 160 A1.046	eng. type 8503995 ->								1.500.815

ENGINE				
1.4 i.e.	Petrol	57	05/89-04/95	159 A2.000

Engine	Information	A10	A20	A40	A50	A70	C10 - C30	C20	E01
All engines	+automatic transmission, +air conditioning, +power steering, version Marelli			1.330.098					
All engines	version Marelli			1.330.101	1.430.060	1.930.176M			
All engines							1.970.108	C10	1.965.020

ENGINE				
1.6	Petrol	56	03/93-10/95	159 A3.048, 835 C1.000

Engine	Information	A10	A20	A40	A50	A70	C10 - C30	C20	E01
All engines	+automatic transmission, +air conditioning, +power steering, eng. type 8327193 ->, ->eng. 8503995, version Marelli			1.330.104					
All engines	+air conditioning, Selecta, 01/01/93 ->, version Marelli			1.330.114					
All engines	->eng. 8327193, version Marelli, +automatic transmission, +power steering, +air conditioning, eng. type 8503995 ->, ->year 01/01/93, 01/01/93 ->, Selecta			1.330.115					
All engines	version Marelli				1.430.059				
Eng. 159 A3.048	eng. type 8813854 ->, version Marelli					1.930.177/1			
Eng. 159 A3.048							1.970.148	C10	
Eng. 835 C1.000							1.970.168	C10	1.500.655
Eng. 159 A3.048	+automatic transmission, +power steering, ->eng. 8503995, +automatic transmission, +power steering, +air conditioning								1.500.808
Eng. 159 A3.048	->year 31/12/93, +automatic transmission, +power steering, eng. type 8503995 ->								1.500.815

ENGINE				
1.6	Petrol	58	03/88-10/92	160 A2.000

Engine	Information	A10	A20	A40	A50	A70	C10 - C30	C20	E01
All engines	version Marelli			1.330.104	1.430.055R				
All engines							1.970.148	C10	1.500.808

ENGINE				
1.6	Petrol	61	01/88-10/91	160 A2.000









Engine	Information	A10	A20	A40	A50	A70	C10 - C30	C20	E01
All engines	version Marelli			1.330.104	1.430.055R				
All engines							1.970.148	C10	1.500.808

ENGINE				
1.6 i.e.	Petrol	55	10/92-04/95	159 A3.048, 835 C1.000

Engine	Information	A10	A20	A40	A50	A70	C10 - C30	C20	E01
All engines	+automatic transmission, +air conditioning, +power steering, eng. type 8327193 ->, ->eng. 8503995, version Marelli			1.330.104					
All engines	+air conditioning, Selecta, 01/01/93 ->, version Marelli			1.330.114					
All engines	->eng. 8327193, version Marelli, +automatic transmission, +power steering, +air conditioning, eng. type 8503995 ->, ->year 01/01/93, 01/01/93 ->, Selecta			1.330.115					
All engines	version Marelli				1.430.059				
Eng. 159 A3.048	eng. type 8813854 ->, version Marelli					1.930.177/1			
Eng. 159 A3.048							1.970.148	C10	

A10	CONDENSER	A20	CONTACT SET	A40	DISTRIBUTOR CAP	A50	ROTOR	A70	PICK-UP
C10	COIL	C20	IGNITION MODULE	C30	ELECTRONIC IGNITION KIT	E01	IGNITION CABLE SET		

The present application list is a brief version. For the detailed information about the possibility of installation on a specific vehicle, please refer to our web-catalogue <http://catalogo.facet.eu/>









					FUNCTIONS ON THE VEHICLE							
Vehicle	alim.	kW	Date	Engine								
ENGINE												
1.6 i.e.	Petrol	55	10/92-04/95	159 A3.048, 835 C1.000								
Engine	Information				A10	A20	A40	A50	A70	C10 - C30	C20	E01
Eng. 835 C1.000	+automatic transmission, +power steering, ->eng. 8503995, +automatic transmission, +power steering, +air conditioning									1.970.168	C10	1.500.655
Eng. 159 A3.048	->year 31/12/93, +automatic transmission, +power steering, eng. type 8503995 ->											1.500.808
Eng. 159 A3.048	->year 31/12/93, +automatic transmission, +power steering, eng. type 8503995 ->											1.500.815
ENGINE												
1.6 i.e.	Petrol	57	07/90-01/93	159 A3.046								
Engine	Information				A10	A20	A40	A50	A70	C10 - C30	C20	E01
All engines	+automatic transmission, +air conditioning, +power steering, eng. type 8327193 ->, ->eng. 8503995, version Marelli						1.330.104					
All engines	+air conditioning, Selecta, 01/01/93 ->, version Marelli						1.330.114					
All engines	->eng. 8327193, version Marelli, +automatic transmission, +power steering, +air conditioning, eng. type 8503995 ->, ->year 01/01/93, 01/01/93 ->, Selecta version Marelli						1.330.115					
All engines	->eng. 8327193, version Marelli, +automatic transmission, +power steering, +air conditioning, eng. type 8503995 ->, ->year 01/01/93, 01/01/93 ->, Selecta version Marelli							1.430.059				
All engines	+automatic transmission, +power steering, ->eng. 8503995, +automatic transmission, +power steering, +air conditioning									1.970.148	C10	
All engines	->year 31/12/93, +automatic transmission, +power steering, eng. type 8503995 ->											1.500.808
All engines	->year 31/12/93, +automatic transmission, +power steering, eng. type 8503995 ->											1.500.815
ENGINE												
1.6 i.e. [BRA]	Petrol	60	03/93-04/95	160 E2.011								
Engine	Information				A10	A20	A40	A50	A70	C10 - C30	C20	E01
All engines	+automatic transmission, +air conditioning, +power steering, eng. type 8327193 ->, ->eng. 8503995, version Marelli						1.330.104					
All engines	+air conditioning, Selecta, 01/01/93 ->, version Marelli						1.330.114					
All engines	->eng. 8327193, version Marelli, +automatic transmission, +power steering, +air conditioning, eng. type 8503995 ->, ->year 01/01/93, 01/01/93 ->, Selecta version Marelli						1.330.115					
All engines	->eng. 8327193, version Marelli, +automatic transmission, +power steering, +air conditioning, eng. type 8503995 ->, ->year 01/01/93, 01/01/93 ->, Selecta version Marelli							1.430.059				
All engines	+automatic transmission, +power steering, ->eng. 8503995, +automatic transmission, +power steering, +air conditioning									1.970.168	C10	1.500.655
All engines	->year 31/12/93, +automatic transmission, +power steering, eng. type 8503995 ->											1.500.815
ENGINE												
1.6 SX DGT	Petrol	66	05/89-10/95	159 A3.000								
Engine	Information				A10	A20	A40	A50	A70	C10 - C30	C20	E01
All engines	+automatic transmission, +power steering, version Marelli						1.330.104					
All engines	version Marelli						1.330.115					
All engines	->eng. 8327193, version Marelli							1.430.055R				
All engines	eng. type 8327193 ->, version Marelli, +automatic transmission, +power steering							1.430.059				
All engines	+automatic transmission									1.970.148	C10	1.500.815
All engines	+automatic transmission											1.500.808
ENGINE												
1.8 i.e	Petrol	71	03/93-04/95	836 A5.000								
Engine	Information				A10	A20	A40	A50	A70	C10 - C30	C20	E01
All engines	Qty: 2									1.970.146	C10	
All engines	eng. type 1486450 ->											1.500.889
ENGINE												
1.8 i.e.	Petrol	66	03/93-10/95	835 C4.000, 836 A6.000								
Engine	Information				A10	A20	A40	A50	A70	C10 - C30	C20	E01
All engines	Qty: 2									1.970.146	C10	
All engines	eng. type 1486450 ->, eng. type 1486450 ->											1.500.889
ENGINE												
1.8 i.e.	Petrol	74	10/94-10/95	836 A5.000								
Engine	Information				A10	A20	A40	A50	A70	C10 - C30	C20	E01
All engines	Qty: 2									1.970.146	C10	
All engines	eng. type 1486450 ->											1.500.889
ENGINE												
1.8 i.e.	Petrol	76	04/93-04/95	835 C2.000								
Engine	Information				A10	A20	A40	A50	A70	C10 - C30	C20	E01
All engines	Qty: 2									1.970.146	C10	
All engines	eng. type 1486450 ->											1.500.889

A10 CONDENSER	A20 CONTACT SET	A40 DISTRIBUTOR CAP	A50 ROTOR	A70 PICK-UP
C10 COIL	C20 IGNITION MODULE	C30 ELECTRONIC IGNITION KIT	E01 IGNITION CABLE SET	

Vehicle	alim.	kW	Date	Engine	FUNCTIONS ON THE VEHICLE									
					A10	A20	A40	A50	A70	C10 - C30	C20	E01		
ENGINE														
1.8 i.e.	Petrol	77	10/90-06/93	159 A4.046										
Engine	Information			A10	A20	A40	A50	A70	C10 - C30	C20	E01			
All engines	+automatic transmission, ->eng. 1339559, version Marelli					1.330.104								
All engines	+automatic transmission, eng. type 1339559 ->, version Marelli					1.330.114								
All engines	version Marelli					1.330.115	1.430.060	1.930.177/1						
All engines									1.990.303	C30				
All engines	LHD												1.500.692	
ENGINE														
1.8 i.e.	Petrol	81	10/90-06/93	159 A4.000										
Engine	Information			A10	A20	A40	A50	A70	C10 - C30	C20	E01			
All engines	+automatic transmission, ->eng. 1339559, version Marelli					1.330.104								
All engines	+automatic transmission, eng. type 1339559 ->, version Marelli					1.330.114								
All engines	version Marelli					1.330.115	1.430.060	1.930.177/1						
All engines									1.990.303	C30				
All engines	LHD												1.500.692	
ENGINE														
1.8 i.e.16V Sport	Petrol	100	11/89-06/92	160 A5.000										
Engine	Information			A10	A20	A40	A50	A70	C10 - C30	C20	E01			
All engines	version Marelli					1.330.104	1.430.060	1.930.177/1						
All engines									1.990.303	C30				
ENGINE														
2.0	Petrol	104	03/93-04/95	836 A3.011										
Engine	Information			A10	A20	A40	A50	A70	C10 - C30	C20	E01			
All engines	version Marelli					1.330.114	1.430.060	1.930.177/1						
All engines									1.990.303	C30			1.500.650	
ENGINE														
2.0	Petrol	85	10/90-10/92	159 A5.046, 159 A6.046										
Engine	Information			A10	A20	A40	A50	A70	C10 - C30	C20	E01			
All engines	+automatic transmission, ->eng. 1339559, version Marelli					1.330.104								
All engines	+automatic transmission, +air conditioning, eng. type 1339559 ->, version Marelli					1.330.114								
All engines	version Marelli					1.330.115	1.430.060	1.930.177/1						
All engines									1.990.303	C30				
All engines	->eng. 1518014, LHD												1.500.692	
ENGINE														
2.0 16V	Petrol	107	07/91-04/95	160 A8.046										
Engine	Information			A10	A20	A40	A50	A70	C10 - C30	C20	E01			
All engines	->year 01/11/91, version Marelli					1.330.104								
All engines	01/11/91 ->, version Marelli					1.330.114								
All engines	version Marelli						1.430.060	1.930.177/1						
All engines									1.990.303	C30			1.500.650	
ENGINE														
2.0 i.e.	Petrol	80	06/90-03/92	159 A5.046										
Engine	Information			A10	A20	A40	A50	A70	C10 - C30	C20	E01			
All engines	+automatic transmission, ->eng. 1339559, version Marelli					1.330.104								
All engines	+automatic transmission, +air conditioning, eng. type 1339559 ->, version Marelli					1.330.114								
All engines	version Marelli					1.330.115	1.430.060	1.930.177/1						
All engines									1.990.303	C30				
All engines	LHD												1.500.692	
ENGINE														
2.0 i.e.	Petrol	83	03/90-04/95	159 A6.046										
Engine	Information			A10	A20	A40	A50	A70	C10 - C30	C20	E01			
All engines	+automatic transmission, ->eng. 1339559, version Marelli					1.330.104								
All engines	+automatic transmission, +air conditioning, eng. type 1339559 ->, version Marelli					1.330.114								
All engines	version Marelli					1.330.115	1.430.060	1.930.177/1						
All engines									1.990.303	C30				
All engines	->eng. 1518014												1.500.692	

A10 CONDENSER	A20 CONTACT SET	A40 DISTRIBUTOR CAP	A50 ROTOR	A70 PICK-UP
C10 COIL	C20 IGNITION MODULE	C30 ELECTRONIC IGNITION KIT	E01 IGNITION CABLE SET	

The present application list is a brief version. For the detailed information about the possibility of installation on a specific vehicle, please refer to our web-catalogue <http://catalogo.facet.eu/>

					FUNCTIONS ON THE VEHICLE							
Vehicle	alim.	kW	Date	Engine	 A10	 A20	 A40	 A50	 A70	 C10 - C30	 C20	 E01
2.0 i.e. [BRA]												
Petrol	85	03/93-10/95	ENGINE 159 A6.011									
Engine	Information	A10	A20	A40	A50	A70	C10 - C30	C20	E01			
All engines	+automatic transmission, ->eng. 1339559, version Marelli			1.330.104								
All engines	+automatic transmission, +air conditioning, eng. type 1339559 ->, version Marelli			1.330.114								
All engines	version Marelli			1.330.115	1.430.060	1.930.177/1						
All engines							1.990.303	C30				
All engines	->eng. 1518014											1.500.692
2.0 i.e. 16V Sport												
Petrol	102	03/93-04/95	ENGINE 836 A3.000									
Engine	Information	A10	A20	A40	A50	A70	C10 - C30	C20	E01			
All engines	version Marelli			1.330.114	1.430.060	1.930.177/1						
All engines							1.990.303	C30				1.500.650
TIPO II												
1.4												
Petrol	70	10/15->	ENGINE 843 A1.000									
Engine	Information	A10	A20	A40	A50	A70	C10 - C30	C20	E01			
All engines	x 4, COIL ON PLUG, incl. spark plug connector						1.970.442	C10				
ULYSSE I												
1.8												
Petrol	73	05/97-08/02	ENGINE LFW (XU7JP)									
Engine	Information	A10	A20	A40	A50	A70	C10 - C30	C20	E01			
All engines							1.970.188	C10				1.500.674
2.0												
Petrol	89	06/94-08/02	ENGINE RFU (XU10J2C)									
Engine	Information	A10	A20	A40	A50	A70	C10 - C30	C20	E01			
All engines							1.970.188	C10				1.500.494
2.0 16V												
Petrol	100	09/00-08/02	ENGINE RFN (EW10J4)									
Engine	Information	A10	A20	A40	A50	A70	C10 - C30	C20	E01			
All engines	incl. spark plug connector						1.970.408	C10				
2.0 Turbo												
Petrol	108	06/94-08/02	ENGINE RGX (XU10J2CTE)									
Engine	Information	A10	A20	A40	A50	A70	C10 - C30	C20	E01			
All engines							1.970.188	C10				1.500.494
ULYSSE II												
2.0												
Petrol	100	08/02-06/11	ENGINE RFN, RFN (EW10J4)									
Engine	Information	A10	A20	A40	A50	A70	C10 - C30	C20	E01			
Eng. RFN	x 4, COIL ON PLUG						1.970.408	C10				
Eng. RFN (EW10J4)							1.970.408	C10				
UNO												
1.0												
Petrol	31	06/89-02/92	ENGINE 156 A2.000									
Engine	Information	A10	A20	A40	A50	A70	C10 - C30	C20	E01			
All engines	Qty: 2						1.970.146	C10				
1.0												
Petrol	35	11/94-08/00	ENGINE 146 A2.166									
Engine	Information	A10	A20	A40	A50	A70	C10 - C30	C20	E01			
All engines	version Marelli			1.330.109	1.430.060	1.930.180M						
All engines											1.965.020	
1.0 i.e.												
Petrol	33	09/89-03/94	ENGINE 146 C7.000									
Engine	Information	A10	A20	A40	A50	A70	C10 - C30	C20	E01			
All engines	Qty: 2						1.970.146	C10				
1.3 Turbo i.e.												
Petrol	74	09/89-03/91	ENGINE 146 A2.246									
Engine	Information	A10	A20	A40	A50	A70	C10 - C30	C20	E01			
All engines	version Marelli			1.330.115	1.430.059							
All engines							1.990.303	C30				







A10 CONDENSER	A20 CONTACT SET	A40 DISTRIBUTOR CAP	A50 ROTOR	A70 PICK-UP
C10 COIL	C20 IGNITION MODULE	C30 ELECTRONIC IGNITION KIT	E01 IGNITION CABLE SET	

Vehicle	alim.	kW	Date	Engine	FUNCTIONS ON THE VEHICLE									
					A10	A20	A40	A50	A70	C10 - C30	C20	E01		
ENGINE														
1.3 Turbo i.e.	Petrol	77	04/85-08/89	146 A2.000										
Engine	Information				A10	A20	A40	A50	A70	C10 - C30	C20	E01		
All engines	version Marelli						1.330.098	1.430.055R						
All engines	+catalytic converter									1.990.303	C30			
ENGINE														
1.4 Turbo i.e.	Petrol	82	09/89-09/93	146 A8.046										
Engine	Information				A10	A20	A40	A50	A70	C10 - C30	C20	E01		
All engines	version Marelli						1.330.101	1.430.055R						
All engines										1.990.303	C30			
ENGINE														
1.4 Turbo i.e.	Petrol	87	12/89-12/96	146 A8.000										
Engine	Information				A10	A20	A40	A50	A70	C10 - C30	C20	E01		
All engines	version Marelli						1.330.101	1.430.055R						
All engines										1.990.303	C30			
ENGINE														
45 0.9	Petrol	33	03/83-07/96	146 A.000, 146 A1.000										
Engine	Information				A10	A20	A40	A50	A70	C10 - C30	C20	E01		
All engines	version Ducellier				1.115.039	1.215.122	1.315.058	1.415.083R						
All engines	version Marelli				1.130.128	1.230.146M	1.330.098	1.430.047R						
All engines										1.970.101D	C10			
ENGINE														
45 0.9	Petrol	34	02/84-12/88	146 A.000										
Engine	Information				A10	A20	A40	A50	A70	C10 - C30	C20	E01		
All engines	version Ducellier				1.115.039	1.215.122	1.315.058	1.415.083R						
All engines	version Marelli				1.130.128	1.230.146M	1.330.098	1.430.047R						
All engines										1.970.101D	C10			
ENGINE														
45 0.9 Trend	Petrol	33	09/89-09/92	146 A.048										
Engine	Information				A10	A20	A40	A50	A70	C10 - C30	C20	E01		
All engines	version Ducellier				1.115.039	1.215.122	1.315.058	1.415.083R						
All engines	version Marelli				1.130.128	1.230.146M	1.330.098	1.430.047R						
All engines										1.970.101D	C10		1.500.386	
ENGINE														
45 1.0	Petrol	32	06/86-12/93	156 A2.100										
Engine	Information				A10	A20	A40	A50	A70	C10 - C30	C20	E01		
All engines	version Marelli						1.330.109	1.430.060	1.930.180M		1.965.020			
All engines										1.970.108	C10		1.500.347	
All engines	version Ducellier										1.965.029			
ENGINE														
45 i.e. 1.0	Petrol	33	10/84-10/95	156 A2.246										
Engine	Information				A10	A20	A40	A50	A70	C10 - C30	C20	E01		
All engines	version Marelli						1.330.109	1.430.060	1.930.180M					
All engines										1.970.108	C10	1.965.020	1.500.347	
ENGINE														
50 1.1	Petrol	37	01/90-12/93	156 C.046										
Engine	Information				A10	A20	A40	A50	A70	C10 - C30	C20	E01		
All engines	version Marelli						1.330.109	1.430.060	1.930.180M					
All engines										1.970.108	C10	1.965.020	1.500.347	
ENGINE														
50 i.e. 1.1	Petrol	36	06/92-12/93	146 C3.000										
Engine	Information				A10	A20	A40	A50	A70	C10 - C30	C20	E01		
All engines	version Marelli						1.330.109	1.430.060	1.930.180M					
All engines										1.970.108	C10	1.965.020	1.500.347	
ENGINE														
55 1.1	Petrol	40	01/83-08/89	138 B.000										
Engine	Information				A10	A20	A40	A50	A70	C10 - C30	C20	E01		
All engines													1.500.354	

A10	CONDENSER	A20	CONTACT SET	A40	DISTRIBUTOR CAP	A50	ROTOR	A70	PICK-UP
C10	COIL	C20	IGNITION MODULE	C30	ELECTRONIC IGNITION KIT	E01	IGNITION CABLE SET		

The present application list is a brief version. For the detailed information about the possibility of installation on a specific vehicle, please refer to our web-catalogue <http://catalogo.facet.eu/>

FUNCTIONS ON THE VEHICLE

Vehicle	alim.	kW	Date	Engine	 A10	 A20	 A40	 A50	 A70	 C10 - C30	 C20	 E01
ENGINE												
60 1.1	Petrol	42	04/89-12/92	160 A3.000								
Engine	Information			A10	A20	A40	A50	A70	C10 - C30	C20	E01	
All engines	version Ducellier					1.315.080	1.415.094				1.965.029	
All engines	version Marelli					1.330.109	1.430.060	1.930.180M			1.965.020	
All engines									1.970.108	C10		1.500.347
ENGINE												
60 1.1	Petrol	43	05/85-02/92	146 A4.048, 146 A6.000								
Engine	Information			A10	A20	A40	A50	A70	C10 - C30	C20	E01	
All engines	version Marelli					1.330.101	1.430.047R	1.930.176M				
Eng. 146 A4.048	version Marelli						1.430.060					
All engines									1.970.108	C10	1.965.020	
Eng. 146 A4.048												1.500.354
ENGINE												
70 1.3	Petrol	50	01/83-04/85	138 B2.000								
Engine	Information			A10	A20	A40	A50	A70	C10 - C30	C20	E01	
All engines												1.500.354
ENGINE												
70 1.3i SX	Petrol	0	01/83-12/89	--								
Engine	Information			A10	A20	A40	A50	A70	C10 - C30	C20	E01	
All engines	version Marelli					1.330.104	1.430.055R					
All engines	version Bosch						1.406.061R	1.906.153				
All engines									1.970.103	C10		
ENGINE												
70 i.e. 1.4	Petrol	51	09/89-07/96	160 A1.046								
Engine	Information			A10	A20	A40	A50	A70	C10 - C30	C20	E01	
All engines	->eng. 8818804, version Marelli					1.330.104						
All engines	eng. type 8818804 ->, version Marelli					1.330.114						
All engines	->eng. 7768530, version Marelli						1.430.055R					
All engines	eng. type 7768530 ->, version Marelli						1.430.059					
All engines									1.970.148	C10		1.500.808
ENGINE												
70 i.e. 1.4	Petrol	53	09/89-12/93	146 C1.000								
Engine	Information			A10	A20	A40	A50	A70	C10 - C30	C20	E01	
All engines	->eng. 8818804, version Marelli					1.330.104						
All engines	eng. type 8818804 ->, version Marelli					1.330.114						
All engines	->eng. 7768530, version Marelli						1.430.055R					
All engines	eng. type 7768530 ->, version Marelli						1.430.059					
All engines									1.970.148	C10		1.500.808
ENGINE												
70 S 1.4	Petrol	52	10/88-06/06	160 A1.048								
Engine	Information			A10	A20	A40	A50	A70	C10 - C30	C20	E01	
All engines	->eng. 8818804, version Marelli					1.330.104						
All engines	eng. type 8818804 ->, version Marelli					1.330.114						
All engines	->eng. 7768530, version Marelli						1.430.055R					
All engines	eng. type 7768530 ->, version Marelli						1.430.059					
All engines									1.970.148	C10		1.500.808
ENGINE												
75 i.e. 1.5	Petrol	55	10/85-12/93	138 C2.048, 149 C1.000								
Engine	Information			A10	A20	A40	A50	A70	C10 - C30	C20	E01	
All engines	->eng. 8818804, version Marelli					1.330.104						
Eng. 149 C1.000	eng. type 8818804 ->, version Marelli					1.330.114						
Eng. 138 C2.048	version Bosch						1.406.061R	1.906.153				
All engines	->eng. 7768530, version Marelli						1.430.055R					
Eng. 149 C1.000	eng. type 7768530 ->, version Marelli						1.430.059					
Eng. 138 C2.048									1.970.103	C10		
Eng. 149 C1.000									1.970.148	C10		1.500.808
ENGINE												
CS 1.1	Petrol	43	09/87-09/91	146 A6.000								
Engine	Information			A10	A20	A40	A50	A70	C10 - C30	C20	E01	
All engines	version Marelli					1.330.101	1.430.047R	1.930.176M				
All engines									1.970.158	C10	1.965.020	

A10 CONDENSER	A20 CONTACT SET	A40 DISTRIBUTOR CAP	A50 ROTOR	A70 PICK-UP
C10 COIL	C20 IGNITION MODULE	C30 ELECTRONIC IGNITION KIT	E01 IGNITION CABLE SET	

Vehicle	alim.	kW	Date	Engine	FUNCTIONS ON THE VEHICLE							
					A10	A20	A40	A50	A70	C10 - C30	C20	E01

				ENGINE
Mondo 1.0	Petrol	33	01/98->	146 A2.166

Engine	Information	A10	A20	A40	A50	A70	C10 - C30	C20	E01
All engines	version Marelli			1.330.109	1.430.060	1.930.180M			
All engines							1.970.108	C10	1.965.020
									1.500.347

				ENGINE
Mondo 1.0 [IND]	Petrol	33	01/98->	146 A2.166

Engine	Information	A10	A20	A40	A50	A70	C10 - C30	C20	E01
All engines	version Marelli			1.330.109	1.430.060	1.930.180M			
All engines							1.970.108	C10	1.965.020
									1.500.347

				ENGINE
Mondo 1.0 i.e.	Petrol	33	01/96->	146 D8.000

Engine	Information	A10	A20	A40	A50	A70	C10 - C30	C20	E01
All engines							1.970.168	C10	1.500.694

				ENGINE
Mondo 1.2 i.e. [IND]	Petrol	44	01/96->	178 D5.066

Engine	Information	A10	A20	A40	A50	A70	C10 - C30	C20	E01
All engines	Qty: 2						1.970.146	C10	
All engines									1.500.616







X 1/9

				ENGINE
1.3	Petrol	54	10/75-06/78	128 A5.000

Engine	Information	A10	A20	A40	A50	A70	C10 - C30	C20	E01
All engines	version Marelli		1.230.140		1.430.036R				
All engines							1.970.101D	C10	

A10	CONDENSER	A20	CONTACT SET	A40	DISTRIBUTOR CAP	A50	ROTOR	A70	PICK-UP
C10	COIL	C20	IGNITION MODULE	C30	ELECTRONIC IGNITION KIT	E01	IGNITION CABLE SET		

The present application list is a brief version. For the detailed information about the possibility of installation on a specific vehicle, please refer to our web-catalogue <http://catalogo.facet.eu/>

				FUNCTIONS ON THE VEHICLE								
Vehicle	alim.	kW	Date	Engine	 A10	 A20	 A40	 A50	 A70	 C10 - C30	 C20	 E01
BRAVA												
1.6i 16v	Petrol	78	01/00->	1.6 Mpi								
Engine		Information			A10	A20	A40	A50	A70	C10 - C30	C20	E01
All engines										1.970.345	C10	1.501.503
1.8i 16v												
1.8i 16v	Petrol	97	01/00->	1.8 Mpi								
Engine		Information			A10	A20	A40	A50	A70	C10 - C30	C20	E01
All engines		Qty: 4								1.970.384	C10	
COUPÈ												
2.0i 16V	Petrol	0	01/95-12/97	2.0 Mpi								
Engine		Information			A10	A20	A40	A50	A70	C10 - C30	C20	E01
All engines		version Marelli					1.330.114	1.430.060	1.930.177/1			
All engines										1.990.303	C30	1.500.650
MAREA												
1.8i 16v	Petrol	97	01/00-12/01	1.8 Mpi								
Engine		Information			A10	A20	A40	A50	A70	C10 - C30	C20	E01
All engines		Qty: 4								1.970.384	C10	
2.0i 20v												
2.0i 20v	Petrol	104	01/99-12/00	2.0 Mpi								
Engine		Information			A10	A20	A40	A50	A70	C10 - C30	C20	E01
All engines		Qty: 5								1.970.314	C10	
PALIO												
1.0i	Petrol	0	01/96->	1.0 Mpi, 1.0 Mpi Fire								
Engine		Information			A10	A20	A40	A50	A70	C10 - C30	C20	E01
All engines		Qty: 2								1.970.146	C10	
1.0i 16v												
1.0i 16v	Petrol	0	01/01->	1.0 Mpi 16v Fire								
Engine		Information			A10	A20	A40	A50	A70	C10 - C30	C20	E01
All engines										1.970.416	C10	1.501.505
1.3i 16v												
1.3i 16v	Petrol	0	01/00->	1.3 Mpi 16v Fire								
Engine		Information			A10	A20	A40	A50	A70	C10 - C30	C20	E01
All engines										1.970.416	C10	1.501.505
1.5i												
1.5i	Petrol	0	01/96-12/00	1.5 Mpi								
Engine		Information			A10	A20	A40	A50	A70	C10 - C30	C20	E01
All engines		Qty: 2								1.970.146	C10	
1.6i												
1.6i	Petrol	0	01/99-12/00	1.6 Mpi, 1.6 Spi								
Engine		Information			A10	A20	A40	A50	A70	C10 - C30	C20	E01
Eng. 1.6 Spi		Qty: 2								1.970.146	C10	
Eng. 1.6 Mpi										1.970.345	C10	1.501.503
1.6i 16v												
1.6i 16v	Petrol	0	01/96->	1.6 Mpi 16v								
Engine		Information			A10	A20	A40	A50	A70	C10 - C30	C20	E01
All engines										1.970.345	C10	1.501.503
SIENA												
1.0i	Petrol	0	01/99-12/00	1.0 Mpi								
Engine		Information			A10	A20	A40	A50	A70	C10 - C30	C20	E01
All engines		Qty: 2								1.970.146	C10	
1.3i 16v												
1.3i 16v	Petrol	0	01/00-12/00	1.3 Mpi Fire								
Engine		Information			A10	A20	A40	A50	A70	C10 - C30	C20	E01
All engines										1.970.416	C10	1.501.505

A10 CONDENSER	A20 CONTACT SET	A40 DISTRIBUTOR CAP	A50 ROTOR	A70 PICK-UP
C10 COIL	C20 IGNITION MODULE	C30 ELECTRONIC IGNITION KIT	E01 IGNITION CABLE SET	

Vehicle	alim.	kW	Date	Engine	FUNCTIONS ON THE VEHICLE									
					A10	A20	A40	A50	A70	C10 - C30	C20	E01		
ENGINE														
1.5i	Petrol	0	01/99-12/00	1.5 Mpi										
ENGINE														
Engine	Information				A10	A20	A40	A50	A70	C10 - C30	C20	E01		
All engines	Qty: 2									1.970.146	C10			
ENGINE														
1.6i	Petrol	0	01/98-12/00	1.6 Mpi, 1.6 Spi										
ENGINE														
Engine	Information				A10	A20	A40	A50	A70	C10 - C30	C20	E01		
All engines	Qty: 2									1.970.146	C10			
ENGINE														
1.6i 16v	Petrol	0	01/98-12/99	1.6 Mpi										
ENGINE														
Engine	Information				A10	A20	A40	A50	A70	C10 - C30	C20	E01		
All engines										1.970.345	C10		1.501.503	
STRADA														
ENGINE														
1.5i	Petrol	0	01/99-12/01	1.5 Mpi										
ENGINE														
Engine	Information				A10	A20	A40	A50	A70	C10 - C30	C20	E01		
All engines	Qty: 2									1.970.146	C10			
ENGINE														
1.6i 16v	Petrol	0	01/99->	1.6 Mpi										
ENGINE														
Engine	Information				A10	A20	A40	A50	A70	C10 - C30	C20	E01		
All engines										1.970.345	C10		1.501.503	
ENGINE														
1.6i 8v	Petrol	0	01/99-12/00	1.6 Mpi										
ENGINE														
Engine	Information				A10	A20	A40	A50	A70	C10 - C30	C20	E01		
All engines	Qty: 2									1.970.146	C10			
TIPO														
ENGINE														
1.6i	Petrol	0	01/93-12/97	1.6 Mpi, 1.6 Spi										
ENGINE														
Engine	Information				A10	A20	A40	A50	A70	C10 - C30	C20	E01		
All engines										1.970.168	C10			
Eng. 1.6 Spi													1.500.655	
ENGINE														
2.0i 16V	Petrol	0	01/94-12/95	2.0 Mpi										
ENGINE														
Engine	Information				A10	A20	A40	A50	A70	C10 - C30	C20	E01		
All engines	version Marelli						1.330.114	1.430.060	1.930.177/1					
All engines										1.990.303	C30		1.500.650	
ENGINE														
2.0i 8v	Petrol	0	01/94-12/95	2.0 Mpi										
ENGINE														
Engine	Information				A10	A20	A40	A50	A70	C10 - C30	C20	E01		
All engines	version Marelli						1.330.115	1.430.060	1.930.177/1					
All engines										1.990.303	C30			
UNO														
ENGINE														
1.4i Turbo	Petrol	0	01/94-12/96	1.4 Mpi										
ENGINE														
Engine	Information				A10	A20	A40	A50	A70	C10 - C30	C20	E01		
All engines	->ch. 5.407.526, version Marelli						1.330.101	1.430.055R						
All engines	ch. 5.407.527 ->, version Marelli						1.330.115	1.430.059						
All engines										1.990.303	C30			
ENGINE														
1.5i	Petrol	0	01/92-12/96	1.5 Spi										
ENGINE														
Engine	Information				A10	A20	A40	A50	A70	C10 - C30	C20	E01		
All engines	Qty: 2									1.970.146	C10			
ENGINE														
1.5i Furgoneta	Petrol	0	01/92->	1.5 Mpi, 1.5 Spi										
ENGINE														
Engine	Information				A10	A20	A40	A50	A70	C10 - C30	C20	E01		
All engines	Qty: 2									1.970.146	C10			
ENGINE														
1.6i	Petrol	0	01/95-12/96	1.6 Mpi										
ENGINE														
Engine	Information				A10	A20	A40	A50	A70	C10 - C30	C20	E01		
All engines										1.970.168	C10			

A10	CONDENSER	A20	CONTACT SET	A40	DISTRIBUTOR CAP	A50	ROTOR	A70	PICK-UP
C10	COIL	C20	IGNITION MODULE	C30	ELECTRONIC IGNITION KIT	E01	IGNITION CABLE SET		

The present application list is a brief version. For the detailed information about the possibility of installation on a specific vehicle, please refer to our web-catalogue <http://catalogo.facet.eu/>

					FUNCTIONS ON THE VEHICLE							
Vehicle	alim.	kW	Date	Engine	 A10	 A20	 A40	 A50	 A70	 C10 - C30	 C20	 E01

UNO CS

				ENGINE
1.5i	Petrol	0	01/92-12/96	1.5 Spi

Engine	Information	A10	A20	A40	A50	A70	C10 - C30	C20	E01
All engines	Qty: 2						1.970.146	C10	

UNO MILLE

				ENGINE
1.0i	Petrol	0	01/96->	1.0 Mpi, 1.0 Mpi Fire, 1.0 Spi

Engine	Information	A10	A20	A40	A50	A70	C10 - C30	C20	E01
All engines	Qty: 2						1.970.146	C10	

A10 CONDENSER	A20 CONTACT SET	A40 DISTRIBUTOR CAP	A50 ROTOR	A70 PICK-UP
C10 COIL	C20 IGNITION MODULE	C30 ELECTRONIC IGNITION KIT	E01 IGNITION CABLE SET	

Vehicle	alim.	kW	Date	Engine	FUNCTIONS ON THE VEHICLE									
					A10	A20	A40	A50	A70	C10 - C30	C20	E01		
B-MAX														
1.0 EcoBoost	Petrol	103	02/16->	ENGINE YYJC										
Engine	Information			A10	A20	A40	A50	A70	C10 - C30	C20	E01			
All engines	x 3, COIL ON PLUG								1.970.619	C10				
1.0 EcoBoost	Petrol	74	10/12->	ENGINE SFJA, SFJB, SFJC, SFJD										
Engine	Information			A10	A20	A40	A50	A70	C10 - C30	C20	E01			
All engines	x 3, COIL ON PLUG								1.970.619	C10				
1.0 EcoBoost	Petrol	88	08/12->	ENGINE M1JA										
Engine	Information			A10	A20	A40	A50	A70	C10 - C30	C20	E01			
All engines	x 3, COIL ON PLUG								1.970.619	C10				
1.0 EcoBoost	Petrol	92	10/12->	ENGINE M1JE, M1JH										
Engine	Information			A10	A20	A40	A50	A70	C10 - C30	C20	E01			
All engines	x 3, COIL ON PLUG								1.970.619	C10				
1.4	Petrol	66	10/12->	ENGINE SPJD, SPJE										
Engine	Information			A10	A20	A40	A50	A70	C10 - C30	C20	E01			
All engines	x 1, D.I.S.								1.970.481	C10				
Eng. SPJD											1.499.242			
1.4 LPG	Petrol/ Liquified Petro- leum Gas (LPG)	64	08/13->	ENGINE RTJC										
Engine	Information			A10	A20	A40	A50	A70	C10 - C30	C20	E01			
All engines	x 1, D.I.S.								1.970.481	C10				
All engines											1.499.242			
1.4 LPG	Petrol/ Liquified Petro- leum Gas (LPG)	66	10/12->	ENGINE RTJC										
Engine	Information			A10	A20	A40	A50	A70	C10 - C30	C20	E01			
All engines	x 1, D.I.S.								1.970.481	C10				
All engines											1.499.242			
1.6 Ti	Petrol	77	10/12->	ENGINE IQJA, IQJC										
Engine	Information			A10	A20	A40	A50	A70	C10 - C30	C20	E01			
All engines	x 1, D.I.S.								1.970.481	C10				
Eng. IQJA											1.499.242			
CAPRI III														
1.3	Petrol	40	01/78-06/85	ENGINE J1E										
Engine	Information			A10	A20	A40	A50	A70	C10 - C30	C20	E01			
All engines	version Bosch					1.306.079	1.406.012R							
C-MAX I														
1.6	Petrol	74	02/07-09/10	ENGINE HWDA, HWDB, SHDA, SHDB, SHDC										
Engine	Information			A10	A20	A40	A50	A70	C10 - C30	C20	E01			
All engines	x 1, D.I.S.								1.970.481	C10				
All engines											1.499.242			
1.6	Petrol	85	04/07-09/10	ENGINE HXDA, HXDB, SIDA										
Engine	Information			A10	A20	A40	A50	A70	C10 - C30	C20	E01			
All engines	x 1, D.I.S.								1.970.481	C10				
1.8	Petrol	90	02/07-09/10	ENGINE QQDC										
Engine	Information			A10	A20	A40	A50	A70	C10 - C30	C20	E01			
All engines	x 4, COIL ON PLUG								1.970.480	C10				
A10	CONDENSER		A20	CONTACT SET		A40	DISTRIBUTOR CAP		A50	ROTOR		A70	PICK-UP	
C10	COIL		C20	IGNITION MODULE		C30	ELECTRONIC IGNITION KIT		E01	IGNITION CABLE SET				









					FUNCTIONS ON THE VEHICLE							
Vehicle	alim.	kW	Date	Engine	A10	A20	A40	A50	A70	C10 - C30	C20	E01
ENGINE												
1.8	Petrol	92	02/07-09/10	QQDA, QQDB								
ENGINE												
Engine		Information			A10	A20	A40	A50	A70	C10 - C30	C20	E01
All engines		x 4, COIL ON PLUG								1.970.480	C10	
ENGINE												
1.8 Flexifuel	Petrol/ Ethanol	92	02/07-09/10	Q7DA								
ENGINE												
Engine		Information			A10	A20	A40	A50	A70	C10 - C30	C20	E01
All engines		x 4, COIL ON PLUG								1.970.480	C10	
ENGINE												
2.0	Petrol	107	02/07-09/10	AODA, AODB, AODE, SYDA								
ENGINE												
Engine		Information			A10	A20	A40	A50	A70	C10 - C30	C20	E01
All engines		x 4, COIL ON PLUG								1.970.480	C10	
ENGINE												
2.0 CNG	Petrol/ Com- pressed Natural Gas (CNG)	107	04/09-09/10	SYDA								
ENGINE												
Engine		Information			A10	A20	A40	A50	A70	C10 - C30	C20	E01
All engines		x 4, COIL ON PLUG								1.970.480	C10	
ENGINE												
2.0 LPG	Petrol/ Liquified Petro- leum Gas (LPG)	107	06/08-09/10	SYDA								
ENGINE												
Engine		Information			A10	A20	A40	A50	A70	C10 - C30	C20	E01
All engines		x 4, COIL ON PLUG								1.970.480	C10	
C-MAX II												
ENGINE												
1.0 EcoBoost	Petrol	74	10/12-06/19	M2DA, M2DC, SFDA								
ENGINE												
Engine		Information			A10	A20	A40	A50	A70	C10 - C30	C20	E01
Eng. M2DA, M2DC		->year 01/06/15, x 3, COIL ON PLUG								1.970.619	C10	
Eng. SFDA		Qty: 3								1.970.619	C10	
ENGINE												
1.0 EcoBoost	Petrol	88	10/12->	--								
ENGINE												
Engine		Information			A10	A20	A40	A50	A70	C10 - C30	C20	E01
All engines		Qty: 3								1.970.619	C10	
ENGINE												
1.0 EcoBoost	Petrol	92	10/12-06/19	M1DA, M1DD								
ENGINE												
Engine		Information			A10	A20	A40	A50	A70	C10 - C30	C20	E01
All engines		->year 01/06/15, x 3, COIL ON PLUG								1.970.619	C10	
ENGINE												
1.5 16V	Petrol	0	03/15->	--								
ENGINE												
Engine		Information			A10	A20	A40	A50	A70	C10 - C30	C20	E01
All engines		Qty: 4								1.970.623	C10	
ENGINE												
1.5 EcoBoost	Petrol	110	03/15-06/19	M8DB, M8DF								
ENGINE												
Engine		Information			A10	A20	A40	A50	A70	C10 - C30	C20	E01
All engines		x 4, COIL ON PLUG								1.970.623	C10	
ENGINE												
1.5 EcoBoost	Petrol	134	03/15-06/19	M9DB								
ENGINE												
Engine		Information			A10	A20	A40	A50	A70	C10 - C30	C20	E01
All engines		x 4, COIL ON PLUG								1.970.623	C10	
ENGINE												
1.6 CNG	Petrol/ Com- pressed Natural Gas (CNG)	86	01/13-12/14	MUDA								
ENGINE												
Engine		Information			A10	A20	A40	A50	A70	C10 - C30	C20	E01
All engines		x 1, D.I.S.								1.970.481	C10	

A10 CONDENSER	A20 CONTACT SET	A40 DISTRIBUTOR CAP	A50 ROTOR	A70 PICK-UP
C10 COIL	C20 IGNITION MODULE	C30 ELECTRONIC IGNITION KIT	E01 IGNITION CABLE SET	

Vehicle	alim.	kW	Date	Engine	FUNCTIONS ON THE VEHICLE								
					A10	A20	A40	A50	A70	C10 - C30	C20	E01	
ENGINE													
1.6 Flexifuel	Petrol/ Ethanol	88	02/11-06/19	MUDA, MUDD									
ENGINE													
All engines											1.970.481	C10	
Information					x 1, D.I.S.								
1.6 LPG	Petrol/ Liquified Petro- leum Gas (LPG)	86	02/12-06/19	MUDA, MUDD									
ENGINE													
All engines											1.970.481	C10	
Information					x 1, D.I.S.								
1.6 LPG	Petrol/ Liquified Petro- leum Gas (LPG)	88	02/12-06/19	MUDA, MUDD									
ENGINE													
All engines											1.970.481	C10	
Information					x 1, D.I.S.								
1.6 Ti	Petrol	63	12/10-06/19	XTDA, XTDB									
ENGINE													
All engines											1.970.481	C10	
Information					x 1, D.I.S.								
Eng. XTDA													1.499.242
1.6 Ti	Petrol	77	10/10-06/19	IQDA, IQDB									
ENGINE													
All engines											1.970.481	C10	
Information					x 1, D.I.S.								
All engines													1.499.242
1.6 Ti	Petrol	88	02/12-06/19	MUDA, MUDD									
ENGINE													
All engines											1.970.481	C10	
Information					x 1, D.I.S.								
1.6 Ti	Petrol	92	12/10-06/19	PNDA, PNDD									
ENGINE													
All engines											1.970.481	C10	
Information					x 1, D.I.S.								
Eng. PNDA													1.499.242
CORSAIR													
1.5	Petrol	40	10/63-09/65	EV 15 N									
ENGINE													
All engines							1.328.070	1.428.006					
Information													
1.5	Petrol	43	10/63-09/65	EV 15 LN									
ENGINE													
All engines							1.328.070	1.428.006					
Information													
1.5 GT	Petrol	56	10/63-09/65	EV 15 LH									
ENGINE													
All engines							1.328.070	1.428.006					
Information													
CORTINA													
1200	Petrol	34	10/62-09/66	--									
ENGINE													
All engines							1.228.083MHV	1.328.070, 1.328.075	1.428.006				
Information													
1200	Petrol	35	10/62-09/66	--									
ENGINE													
All engines							1.228.083MHV	1.328.070, 1.328.075	1.428.006				
Information													

A10	CONDENSER	A20	CONTACT SET	A40	DISTRIBUTOR CAP	A50	ROTOR	A70	PICK-UP
C10	COIL	C20	IGNITION MODULE	C30	ELECTRONIC IGNITION KIT	E01	IGNITION CABLE SET		

The present application list is a brief version. For the detailed information about the possibility of installation on a specific vehicle, please refer to our web-catalogue <http://catalogo.facet.eu/>

				FUNCTIONS ON THE VEHICLE								
Vehicle	alim.	kW	Date	Engine								
				ENGINE								
1300	Petrol	42	10/70-03/72	KL 13 H								
				ENGINE								
Engine		Information		A10	A20	A40	A50	A70	C10 - C30	C20	E01	
All engines		version Ford			1.219.043HV	1.319.083	1.419.085					
All engines		version Bosch				1.306.109	1.406.025R					
All engines												1.501.078
				ENGINE								
1500	Petrol	43	10/62-09/66	--								
				ENGINE								
Engine		Information		A10	A20	A40	A50	A70	C10 - C30	C20	E01	
All engines					1.228.083MHV	1.328.070, 1.328.075	1.428.006					
				ENGINE								
1500 GT	Petrol	56	10/62-09/66	--								
				ENGINE								
Engine		Information		A10	A20	A40	A50	A70	C10 - C30	C20	E01	
All engines						1.328.070, 1.328.075	1.428.006					
				ENGINE								
GT	Petrol	56	10/62-09/66	--								
				ENGINE								
Engine		Information		A10	A20	A40	A50	A70	C10 - C30	C20	E01	
All engines					1.228.083MHV	1.328.070, 1.328.075	1.428.006					
				ENGINE								
Lotus	Petrol	78	10/62-09/70	--								
				ENGINE								
Engine		Information		A10	A20	A40	A50	A70	C10 - C30	C20	E01	
All engines							1.428.006					
				ENGINE								
Lotus Spezial	Petrol	103	10/62-09/66	--								
				ENGINE								
Engine		Information		A10	A20	A40	A50	A70	C10 - C30	C20	E01	
All engines							1.428.006					
				ENGINE								
2.0 16V	Petrol	96	08/98-12/01	EDBA, EDBB, EDBC, EDBD								
				ENGINE								
Engine		Information		A10	A20	A40	A50	A70	C10 - C30	C20	E01	
All engines		x 1, D.I.S.							1.970.532	C10		
All engines												1.501.624
				ENGINE								
2.5 ST 200	Petrol	151	01/00-12/01	SGA								
				ENGINE								
Engine		Information		A10	A20	A40	A50	A70	C10 - C30	C20	E01	
All engines		->year 01/09/00, x 1, D.I.S.							1.970.170	C10		
				ENGINE								
2.5 V6 24V	Petrol	125	08/98-12/01	JP25LCBD, LCBA, LCBB, LCBC, LCBE								
				ENGINE								
Engine		Information		A10	A20	A40	A50	A70	C10 - C30	C20	E01	
All engines		->year 01/09/00, x 1, D.I.S.							1.970.170	C10		
Eng. LCBB, LCBC, LCBE									1.970.170	C10		
				ENGINE								
1.0 EcoBoost	Petrol	103	03/16->	YYJD, YYJF								
				ENGINE								
Engine		Information		A10	A20	A40	A50	A70	C10 - C30	C20	E01	
All engines		x 3, COIL ON PLUG							1.970.619	C10		
				ENGINE								
1.0 EcoBoost	Petrol	74	04/18->	SFJL								
				ENGINE								
Engine		Information		A10	A20	A40	A50	A70	C10 - C30	C20	E01	
All engines		x 3, COIL ON PLUG							1.970.619	C10		
				ENGINE								
1.0 EcoBoost	Petrol	92	10/13->	M1JC, M1JJ, M1JU								
				ENGINE								
Engine		Information		A10	A20	A40	A50	A70	C10 - C30	C20	E01	
All engines		x 3, COIL ON PLUG							1.970.619	C10		
				ENGINE								
1.5 Ti	Petrol	82	10/13->	UEJB, UEJE								
				ENGINE								
Engine		Information		A10	A20	A40	A50	A70	C10 - C30	C20	E01	
All engines		x 1, D.I.S.							1.970.481	C10		

A10 CONDENSER	A20 CONTACT SET	A40 DISTRIBUTOR CAP	A50 ROTOR	A70 PICK-UP
C10 COIL	C20 IGNITION MODULE	C30 ELECTRONIC IGNITION KIT	E01 IGNITION CABLE SET	

Vehicle	alim.	kW	Date	Engine	FUNCTIONS ON THE VEHICLE									
					A10	A20	A40	A50	A70	C10 - C30	C20	E01		
ENGINE														
1.5 Ti-VCT	Petrol	81	10/13->	UEJB, UEJE										
Engine	Information				A10	A20	A40	A50	A70	C10 - C30	C20	E01		
All engines	x 1, D.I.S.									1.970.481	C10			
ENGINE														
1.6 Ti-VCT	Petrol	90	08/12->	HXJD, IQJB										
Engine	Information				A10	A20	A40	A50	A70	C10 - C30	C20	E01		
All engines	x 1, D.I.S.									1.970.481	C10			
ENGINE														
2.0 4x4	Petrol	103	08/12->	C20HDEA										
Engine	Information				A10	A20	A40	A50	A70	C10 - C30	C20	E01		
All engines	x 4, COIL ON PLUG									1.970.480	C10			
ESCORT I														
ENGINE														
RS 1600	Petrol	84	01/70-10/74	--										
Engine	Information				A10	A20	A40	A50	A70	C10 - C30	C20	E01		
All engines							1.328.075	1.428.006						
ENGINE														
RS 1600	Petrol	90	01/70-10/74	BDA										
Engine	Information				A10	A20	A40	A50	A70	C10 - C30	C20	E01		
All engines							1.328.075	1.428.006						
ENGINE														
Twin Cam	Petrol	80	03/68-08/71	K5										
Engine	Information				A10	A20	A40	A50	A70	C10 - C30	C20	E01		
All engines								1.428.006						
ESCORT II														
ENGINE														
1.6 RS	Petrol	62	12/74-08/80	LC										
Engine	Information				A10	A20	A40	A50	A70	C10 - C30	C20	E01		
All engines							1.328.075	1.428.006						
ENGINE														
1.8	Petrol	115	12/74-08/80	--										
Engine	Information				A10	A20	A40	A50	A70	C10 - C30	C20	E01		
All engines							1.328.075	1.428.006						
ENGINE														
RS 1800	Petrol	92	03/75-08/77	KL 18 S										
Engine	Information				A10	A20	A40	A50	A70	C10 - C30	C20	E01		
All engines							1.328.075	1.428.006						
ESCORT III														
ENGINE														
1.1	Petrol	37	08/83-07/90	GSE, GSG										
Engine	Information				A10	A20	A40	A50	A70	C10 - C30	C20	E01		
Eng. GSE	version Bosch					1.206.049HVS	1.306.079	1.406.025R						
Eng. GSG												1.501.007		
ENGINE														
1.3	Petrol	46	07/88-07/90	JBA										
Engine	Information				A10	A20	A40	A50	A70	C10 - C30	C20	E01		
All engines										1.970.312	C10			
ENGINE														
1.3	Petrol	51	09/80-02/86	JPA										
Engine	Information				A10	A20	A40	A50	A70	C10 - C30	C20	E01		
All engines	version Lucas						1.328.083							
All engines	version Bosch							1.406.060R						
All engines										1.970.169	C10			
ENGINE														
1.4 i	Petrol	54	02/86-07/90	F6B, F6D, FUC										
Engine	Information				A10	A20	A40	A50	A70	C10 - C30	C20	E01		
All engines	version Bosch						1.306.079							
Eng. F6D, FUC	version Lucas						1.328.096	1.428.026R						
Eng. F6D, FUC	version Bosch							1.406.061R						
Eng. F6B	version Bosch							1.406.121R						

A10	CONDENSER	A20	CONTACT SET	A40	DISTRIBUTOR CAP	A50	ROTOR	A70	PICK-UP
C10	COIL	C20	IGNITION MODULE	C30	ELECTRONIC IGNITION KIT	E01	IGNITION CABLE SET		

The present application list is a brief version. For the detailed information about the possibility of installation on a specific vehicle, please refer to our web-catalogue <http://catalogo.facet.eu/>

Vehicle	alim.	kW	Date	Engine	FUNCTIONS ON THE VEHICLE							
					A10	A20	A40	A50	A70	C10 - C30	C20	E01

ENGINE				
1.4 i	Petrol	54	02/86-07/90	F6B, F6D, FUC

Engine	Information	A10	A20	A40	A50	A70	C10 - C30	C20	E01
All engines							1.970.169, 1.970.312	C10	
Eng. F6D, FUC									1.501.281

ENGINE				
1.6	Petrol	58	09/80-12/85	LP1, LPA

Engine	Information	A10	A20	A40	A50	A70	C10 - C30	C20	E01
All engines	version Lucas			1.328.083					
All engines	version Bosch				1.406.060R				
All engines							1.970.169	C10	

ENGINE				
1.6 i	Petrol	77	09/83-12/85	LR1

Engine	Information	A10	A20	A40	A50	A70	C10 - C30	C20	E01
All engines	version Bosch				1.406.112R				
All engines							1.970.169	C10	

ENGINE				
1.6 XR3i	Petrol	77	10/82-12/85	LR1, LRA

Engine	Information	A10	A20	A40	A50	A70	C10 - C30	C20	E01
All engines	version Bosch				1.406.112R				
All engines							1.970.169	C10	

ESCORT IV

ENGINE				
1.1	Petrol	37	12/85-07/90	GSG

Engine	Information	A10	A20	A40	A50	A70	C10 - C30	C20	E01
All engines									1.501.007

ENGINE				
1.3	Petrol	44	01/95-08/97	J6A, JBD

Engine	Information	A10	A20	A40	A50	A70	C10 - C30	C20	E01
All engines	x 1, D.I.S.						1.970.135	C10	

ENGINE				
1.3	Petrol	46	07/88-12/94	JBA, JBD

Engine	Information	A10	A20	A40	A50	A70	C10 - C30	C20	E01
All engines							1.970.312	C10	

ENGINE				
1.4	Petrol	52	07/90-12/94	F6F, F6G

Engine	Information	A10	A20	A40	A50	A70	C10 - C30	C20	E01
All engines							1.970.135, 1.970.312	C10	1.500.864

ENGINE				
1.4	Petrol	54	01/86-08/00	F4B, F6B, F6D, FUC

Engine	Information	A10	A20	A40	A50	A70	C10 - C30	C20	E01
Eng. F6B, F6D, FUC	version Bosch			1.306.079					
Eng. F6D, FUC	version Lucas			1.328.096	1.428.026R				
Eng. F6D, FUC	version Bosch				1.406.061R				
Eng. F6B	version Bosch				1.406.121R				
Eng. F4B	x 1, D.I.S.						1.970.135	C10	
Eng. F6B, F6D, FUC							1.970.169, 1.970.312	C10	
Eng. F4B									1.500.864
Eng. F6D, FUC									1.501.281

ENGINE				
1.4	Petrol	55	01/86-07/90	FUA

Engine	Information	A10	A20	A40	A50	A70	C10 - C30	C20	E01
All engines	version Bosch			1.306.079	1.406.061R				
All engines	version Lucas			1.328.096	1.428.026R				
All engines							1.970.169, 1.970.312	C10	

ENGINE				
1.6	Petrol	65	04/89-07/90	LUG

Engine	Information	A10	A20	A40	A50	A70	C10 - C30	C20	E01
All engines							1.970.312	C10	

A10 CONDENSER	A20 CONTACT SET	A40 DISTRIBUTOR CAP	A50 ROTOR	A70 PICK-UP
C10 COIL	C20 IGNITION MODULE	C30 ELECTRONIC IGNITION KIT	E01 IGNITION CABLE SET	

Vehicle	alim.	kW	Date	Engine	FUNCTIONS ON THE VEHICLE									
					A10	A20	A40	A50	A70	C10 - C30	C20	E01		
ENGINE														
1.6 16V	Petrol	66	10/98-07/00	L1E, L1K										
Engine	Information				A10	A20	A40	A50	A70	C10 - C30	C20	E01		
All engines	x 1, D.I.S.									1.970.532	C10			
Eng. L1E													1.501.630	
ENGINE														
1.6 i	Petrol	66	01/86-07/90	L4B										
Engine	Information				A10	A20	A40	A50	A70	C10 - C30	C20	E01		
All engines										1.970.312	C10			
ENGINE														
1.6 Turbo RS	Petrol	97	01/86-07/90	LNB										
Engine	Information				A10	A20	A40	A50	A70	C10 - C30	C20	E01		
All engines	version Bosch						1.306.079	1.406.121R	1.906.233					
All engines										1.970.169, 1.970.312	C10			
ENGINE														
1.6 XR3i	Petrol	77	01/86-07/90	LR2, LRB										
Engine	Information				A10	A20	A40	A50	A70	C10 - C30	C20	E01		
All engines	version Bosch						1.306.079							
All engines	+catalytic converter, version Bosch							1.406.121R						
All engines										1.970.169, 1.970.312	C10		1.501.281	
ESCORT V														
ENGINE														
1.3	Petrol	44	07/90-01/95	J4B, J6A, JBE										
Engine	Information				A10	A20	A40	A50	A70	C10 - C30	C20	E01		
Eng. J4B, J6A										1.970.312	C10			
All engines										1.970.364	C10			
Eng. J6A, JBE													1.501.007	
ENGINE														
1.4	Petrol	52	07/90-01/95	F6F, F6G										
Engine	Information				A10	A20	A40	A50	A70	C10 - C30	C20	E01		
All engines										1.970.135, 1.970.312	C10		1.500.864	
ENGINE														
1.4	Petrol	55	09/90-01/95	F4B, FUH										
Engine	Information				A10	A20	A40	A50	A70	C10 - C30	C20	E01		
All engines										1.970.135, 1.970.312	C10		1.500.864	
ENGINE														
1.4 i	Petrol	55	07/93-01/95	F4B										
Engine	Information				A10	A20	A40	A50	A70	C10 - C30	C20	E01		
All engines										1.970.135, 1.970.312	C10		1.500.864	
ENGINE														
1.6	Petrol	66	07/90-08/92	LUJ, LUK										
Engine	Information				A10	A20	A40	A50	A70	C10 - C30	C20	E01		
All engines										1.970.135, 1.970.312	C10		1.500.864	
ENGINE														
1.6	Petrol	77	07/90-08/93	LJF										
Engine	Information				A10	A20	A40	A50	A70	C10 - C30	C20	E01		
All engines										1.970.135, 1.970.312	C10		1.500.864	
ENGINE														
1.6 16V XR3i	Petrol	66	12/92-01/95	L1E										
Engine	Information				A10	A20	A40	A50	A70	C10 - C30	C20	E01		
All engines										1.970.299, 1.970.312	C10		1.501.630	
ENGINE														
1.6 i 16V	Petrol	65	01/94-01/95	L1H										
Engine	Information				A10	A20	A40	A50	A70	C10 - C30	C20	E01		
All engines										1.970.299, 1.970.312	C10		1.501.630	

A10 CONDENSER	A20 CONTACT SET	A40 DISTRIBUTOR CAP	A50 ROTOR	A70 PICK-UP
C10 COIL	C20 IGNITION MODULE	C30 ELECTRONIC IGNITION KIT	E01 IGNITION CABLE SET	

The present application list is a brief version. For the detailed information about the possibility of installation on a specific vehicle, please refer to our web-catalogue <http://catalogo.facet.eu/>

Vehicle	alim.	kW	Date	Engine	FUNCTIONS ON THE VEHICLE							
					A10	A20	A40	A50	A70	C10 - C30	C20	E01

ENGINE				
1.6 i 16V	Petrol	66	09/92-01/95	L1E, L1K

Engine	Information	A10	A20	A40	A50	A70	C10 - C30	C20	E01
All engines							1.970.299, 1.970.312	C10	1.501.630

ENGINE				
1.8 16V	Petrol	77	02/92-01/95	RDA

Engine	Information	A10	A20	A40	A50	A70	C10 - C30	C20	E01
All engines							1.970.299	C10	1.501.630

ENGINE				
1.8 16V XR3i	Petrol	77	02/92-01/95	RDA

Engine	Information	A10	A20	A40	A50	A70	C10 - C30	C20	E01
All engines							1.970.299	C10	1.501.630

ENGINE				
1.8 16V XR3i	Petrol	96	02/92-01/95	99BFR1740

Engine	Information	A10	A20	A40	A50	A70	C10 - C30	C20	E01
All engines							1.970.299, 1.970.312	C10	1.501.630

ENGINE				
1.8 i 16V	Petrol	77	09/92-01/95	RDA

Engine	Information	A10	A20	A40	A50	A70	C10 - C30	C20	E01
All engines							1.970.299, 1.970.312	C10	1.501.630

ENGINE				
1.8 i 16V	Petrol	96	02/93-01/95	99BFR1740

Engine	Information	A10	A20	A40	A50	A70	C10 - C30	C20	E01
All engines							1.970.299, 1.970.312	C10	1.501.630

ENGINE				
1.8 XR3i 16V 4x4	Petrol	77	08/93-01/95	RDA

Engine	Information	A10	A20	A40	A50	A70	C10 - C30	C20	E01
All engines							1.970.299	C10	1.501.630

ENGINE				
1.8 XR3i 16V 4x4	Petrol	96	08/93-01/95	99BFR1740

Engine	Information	A10	A20	A40	A50	A70	C10 - C30	C20	E01
All engines							1.970.299, 1.970.312	C10	1.501.630

ENGINE				
RS 2000	Petrol	110	05/91-01/95	N7A

Engine	Information	A10	A20	A40	A50	A70	C10 - C30	C20	E01
All engines									1.501.145

ENGINE				
RS Cosworth 4x4	Petrol	162	10/91-01/95	NSF

Engine	Information	A10	A20	A40	A50	A70	C10 - C30	C20	E01
All engines	->year 01/06/94, -catalytic converter, version Marelli			1.330.098					
All engines	+catalytic converter, ->year 01/06/94, version Marelli			1.330.101					
All engines	->year 01/06/94, version Marelli				1.430.057R				
All engines	->year 30/06/94						1.970.169	C10	

ESCORT VI

ENGINE				
1.3	Petrol	44	01/95-02/99	J4B, J6A

Engine	Information	A10	A20	A40	A50	A70	C10 - C30	C20	E01
Eng. J6A							1.970.312, 1.970.364	C10	1.501.007
All engines	x 1, D.I.S.						1.970.532	C10	
Eng. J4B	01/10/98 ->								1.501.568
Eng. J4B	->year 30/09/98								1.501.639

ENGINE				
1.4	Petrol	54	01/95-12/99	F4B

Engine	Information	A10	A20	A40	A50	A70	C10 - C30	C20	E01
All engines	x 1, D.I.S.						1.970.135	C10	
All engines									1.500.864

A10 CONDENSER	A20 CONTACT SET	A40 DISTRIBUTOR CAP	A50 ROTOR	A70 PICK-UP
C10 COIL	C20 IGNITION MODULE	C30 ELECTRONIC IGNITION KIT	E01 IGNITION CABLE SET	

Vehicle	alim.	kW	Date	Engine	FUNCTIONS ON THE VEHICLE									
					A10	A20	A40	A50	A70	C10 - C30	C20	E01		
ENGINE														
1.4	Petrol	55	01/95-02/99	F4B, F6B, F6D, FUH										
Engine	Information				A10	A20	A40	A50	A70	C10 - C30	C20	E01		
All engines	x 1, D.I.S.									1.970.135	C10			
Eng. F4B										1.970.135, 1.970.312	C10		1.500.864	
ENGINE														
1.6 16V	Petrol	66	01/95-07/00	L1E, L1K										
Engine	Information				A10	A20	A40	A50	A70	C10 - C30	C20	E01		
All engines	x 1, D.I.S.									1.970.532	C10			
Eng. L1E												1.501.630		
ENGINE														
1.6 16V 4x4	Petrol	66	01/95-10/98	L1E										
Engine	Information				A10	A20	A40	A50	A70	C10 - C30	C20	E01		
All engines	x 1, D.I.S.									1.970.532	C10			
All engines												1.501.630		
ENGINE														
1.6 16V XR3i	Petrol	65	02/95-12/96	L1H										
Engine	Information				A10	A20	A40	A50	A70	C10 - C30	C20	E01		
All engines	x 1, D.I.S.									1.970.532	C10			
All engines												1.501.630		
ENGINE														
1.6 16V XR3i	Petrol	66	02/95-09/99	L1E, L1K										
Engine	Information				A10	A20	A40	A50	A70	C10 - C30	C20	E01		
All engines	x 1, D.I.S.									1.970.532	C10			
Eng. L1E												1.501.630		
ENGINE														
1.6 i 16V	Petrol	65	01/95-08/95	L1H										
Engine	Information				A10	A20	A40	A50	A70	C10 - C30	C20	E01		
All engines	x 1, D.I.S.									1.970.532	C10			
All engines												1.501.630		
ENGINE														
1.6 i 16V	Petrol	66	01/95-02/99	L1E, L1K										
Engine	Information				A10	A20	A40	A50	A70	C10 - C30	C20	E01		
All engines	x 1, D.I.S.									1.970.532	C10			
All engines												1.501.630		
ENGINE														
1.8 16V	Petrol	77	01/95-08/95	RDA										
Engine	Information				A10	A20	A40	A50	A70	C10 - C30	C20	E01		
All engines	x 1, D.I.S.									1.970.532	C10			
All engines												1.501.630		
ENGINE														
1.8 16V	Petrol	85	01/95-02/99	RKC										
Engine	Information				A10	A20	A40	A50	A70	C10 - C30	C20	E01		
All engines	x 1, D.I.S.									1.970.532	C10			
All engines												1.501.630		
ENGINE														
1.8 16V XR3i	Petrol	77	02/95-08/98	RDA										
Engine	Information				A10	A20	A40	A50	A70	C10 - C30	C20	E01		
All engines	x 1, D.I.S.									1.970.532	C10			
All engines												1.501.630		
ENGINE														
1.8 16V XR3i	Petrol	85	10/95-08/98	RKC										
Engine	Information				A10	A20	A40	A50	A70	C10 - C30	C20	E01		
All engines	x 1, D.I.S.									1.970.532	C10			
All engines												1.501.630		
ENGINE														
1.8 16V XR3i	Petrol	96	02/95-08/00	RQB										
Engine	Information				A10	A20	A40	A50	A70	C10 - C30	C20	E01		
All engines	x 1, D.I.S.									1.970.532	C10			

A10	CONDENSER	A20	CONTACT SET	A40	DISTRIBUTOR CAP	A50	ROTOR	A70	PICK-UP
C10	COIL	C20	IGNITION MODULE	C30	ELECTRONIC IGNITION KIT	E01	IGNITION CABLE SET		

The present application list is a brief version. For the detailed information about the possibility of installation on a specific vehicle, please refer to our web-catalogue <http://catalogo.facet.eu/>

					FUNCTIONS ON THE VEHICLE							
Vehicle	alim.	kW	Date	Engine	A10	A20	A40	A50	A70	C10 - C30	C20	E01
RS 2000												
Petrol 110 02/95-02/98 ENGINE N7A												
Engine	Information				A10	A20	A40	A50	A70	C10 - C30	C20	E01
All engines												1.501.145
RS 2000 4x4												
Petrol 110 02/95-10/98 ENGINE N7A												
Engine	Information				A10	A20	A40	A50	A70	C10 - C30	C20	E01
All engines												1.501.145
ESCORT-NOMADE												
1.6												
Petrol 66 01/95-04/00 ENGINE 8LH7(98CUL4), ZH16L1E												
Engine	Information				A10	A20	A40	A50	A70	C10 - C30	C20	E01
All engines	x 1, D.I.S.									1.970.532 C10		
1.8												
Petrol 77 01/95-04/00 ENGINE 0LW2(273CUV8)												
Engine	Information				A10	A20	A40	A50	A70	C10 - C30	C20	E01
All engines	x 1, D.I.S.									1.970.532 C10		
FIESTA												
1.2												
Petrol 55 01/96-04/02 ENGINE DHA, DHB, DHC, DHD, DHF, DHG												
Engine	Information				A10	A20	A40	A50	A70	C10 - C30	C20	E01
All engines	->year 01/05/98, x 1, D.I.S.									1.970.2995 C10		
All engines	01/06/98->, x 1, D.I.S.									1.970.532 C10		
1.3												
Petrol 44 09/95-08/03 ENGINE J4C, J4J, J4R												
Engine	Information				A10	A20	A40	A50	A70	C10 - C30	C20	E01
All engines	x 1, D.I.S.									1.970.532 C10		
FIESTA I												
0.9												
Petrol 29 05/76-08/83 ENGINE TKA, TKW												
Engine	Information				A10	A20	A40	A50	A70	C10 - C30	C20	E01
All engines	version Bosch					1.206.049HVS	1.306.079	1.406.025R				
All engines	version Ford					1.219.043HV	1.319.083	1.419.085				
0.9												
Petrol 33 05/76-08/83 ENGINE TLA												
Engine	Information				A10	A20	A40	A50	A70	C10 - C30	C20	E01
All engines	version Bosch					1.206.049HVS	1.306.079	1.406.025R				
All engines	version Ford					1.219.043HV	1.319.083	1.419.085				
1.1												
Petrol 39 05/76-08/83 ENGINE GLA												
Engine	Information				A10	A20	A40	A50	A70	C10 - C30	C20	E01
All engines	version Bosch					1.206.049HVS	1.306.079	1.406.025R				
1.1												
Petrol 40 02/81-08/83 ENGINE GLW												
Engine	Information				A10	A20	A40	A50	A70	C10 - C30	C20	E01
All engines	version Bosch					1.206.049HVS	1.306.079	1.406.025R				
1.3												
Petrol 49 08/77-08/83 ENGINE J3E												
Engine	Information				A10	A20	A40	A50	A70	C10 - C30	C20	E01
All engines	version Ford					1.219.043HV	1.319.083					
1.6 XR2												
Petrol 62 08/81-08/83 ENGINE L3E												
Engine	Information				A10	A20	A40	A50	A70	C10 - C30	C20	E01
All engines	version Bosch						1.306.079	1.406.025R				
FIESTA II												
1.1												
Petrol 36 05/86-02/89 ENGINE GSH												
Engine	Information				A10	A20	A40	A50	A70	C10 - C30	C20	E01
All engines	version Bosch						1.306.079	1.406.061R				

A10 CONDENSER	A20 CONTACT SET	A40 DISTRIBUTOR CAP	A50 ROTOR	A70 PICK-UP
C10 COIL	C20 IGNITION MODULE	C30 ELECTRONIC IGNITION KIT	E01 IGNITION CABLE SET	

Vehicle	alim.	kW	Date	Engine	FUNCTIONS ON THE VEHICLE									
					A10	A20	A40	A50	A70	C10 - C30	C20	E01		
ENGINE														
1.1	Petrol	37	09/83-02/89	GLC, GSF										
ENGINE														
All engines						1.206.049HVS	1.306.079	1.406.025R						
ENGINE														
1.3	Petrol	51	09/83-09/89	JPC										
ENGINE														
All engines							1.306.079	1.406.025R						
ENGINE														
1.4	Petrol	52	10/86-02/89	F6A, F6C										
ENGINE														
All engines										1.970.312	C10			
ENGINE														
1.4	Petrol	54	02/87-02/89	FUD										
ENGINE														
All engines							1.306.079	1.406.061R						
ENGINE														
All engines										1.970.169	C10		1.501.281	
ENGINE														
1.4	Petrol	55	10/85-11/89	FUB										
ENGINE														
All engines							1.306.079	1.406.061R						
ENGINE														
All engines										1.970.169	C10		1.501.281	
ENGINE														
1.6XR2	Petrol	70	03/84-02/89	LUD										
ENGINE														
All engines							1.328.096	1.428.026R						
ENGINE														
All engines										1.970.169	C10		1.501.281	
ENGINE														
1.6XR2	Petrol	71	04/84-02/89	LUB										
ENGINE														
All engines							1.328.096	1.428.026R						
ENGINE														
All engines										1.970.169	C10		1.501.281	
FIESTA III														
ENGINE														
1.0	Petrol	33	03/89-12/95	TLB										
ENGINE														
All engines										1.970.364	C10		1.501.007	
ENGINE														
1.1	Petrol	37	03/89-12/95	G6A										
ENGINE														
All engines										1.970.312, 1.970.364	C10		1.501.007	
ENGINE														
1.1	Petrol	40	03/89-12/95	GUD, GUE										
ENGINE														
All engines										1.970.312, 1.970.364	C10		1.501.007	
ENGINE														
1.3	Petrol	44	03/89-02/96	J6B, JBB, JBC										
ENGINE														
Eng. J6B, JBC										1.970.312	C10			
ENGINE														
All engines										1.970.364	C10		1.501.007	
ENGINE														
1.3 Cat	Petrol	44	05/91-01/97	J6B										
ENGINE														
All engines										1.970.312, 1.970.364	C10		1.501.007	
ENGINE														
1.4	Petrol	52	03/89-12/95	F6E										
ENGINE														
All engines							1.306.079	1.406.121R						
ENGINE														
All engines							1.328.096	1.428.026R						

A10	CONDENSER	A20	CONTACT SET	A40	DISTRIBUTOR CAP	A50	ROTOR	A70	PICK-UP
C10	COIL	C20	IGNITION MODULE	C30	ELECTRONIC IGNITION KIT	E01	IGNITION CABLE SET		

The present application list is a brief version. For the detailed information about the possibility of installation on a specific vehicle, please refer to our web-catalogue <http://catalogo.facet.eu/>

				FUNCTIONS ON THE VEHICLE															
Vehicle	alim.	kW	Date	Engine	 A10	 A20	 A40	 A50	 A70	 C10 - C30	 C20	 E01							
				ENGINE															
1.4	Petrol	52	03/89-12/95	F6E															
Engine		Information			A10	A20	A40	A50	A70	C10 - C30	C20	E01							
All engines										1.970.169, 1.970.312	C10	1.501.281							
				ENGINE															
1.4	Petrol	54	03/89-12/95	FUG, FUJ															
Engine		Information			A10	A20	A40	A50	A70	C10 - C30	C20	E01							
All engines										1.970.135, 1.970.312	C10	1.500.864							
				ENGINE															
1.4 Cat	Petrol	54	03/89-12/95	F4A															
Engine		Information			A10	A20	A40	A50	A70	C10 - C30	C20	E01							
All engines										1.970.135, 1.970.312	C10	1.500.864							
				ENGINE															
1.6	Petrol	65	01/89-01/94	LUH															
Engine		Information			A10	A20	A40	A50	A70	C10 - C30	C20	E01							
All engines										1.970.135, 1.970.312	C10	1.500.864							
				ENGINE															
1.6	Petrol	66	03/89-12/92	LUH															
Engine		Information			A10	A20	A40	A50	A70	C10 - C30	C20	E01							
All engines										1.970.135	C10	1.500.864							
				ENGINE															
1.6 i 16V	Petrol	65	01/94-12/95	L1G															
Engine		Information			A10	A20	A40	A50	A70	C10 - C30	C20	E01							
All engines										1.970.299, 1.970.312	C10	1.501.630							
				ENGINE															
1.6 Turbo	Petrol	96	03/90-10/92	LHA															
Engine		Information			A10	A20	A40	A50	A70	C10 - C30	C20	E01							
All engines										1.970.135, 1.970.312	C10								
				ENGINE															
1.6 XR2i	Petrol	76	03/89-03/93	LJD															
Engine		Information			A10	A20	A40	A50	A70	C10 - C30	C20	E01							
All engines										1.970.135, 1.970.312	C10								
				ENGINE															
1.6 XR2i	Petrol	81	03/89-01/94	LJC															
Engine		Information			A10	A20	A40	A50	A70	C10 - C30	C20	E01							
All engines										1.970.135, 1.970.312	C10								
				ENGINE															
1.8 16V	Petrol	77	02/92-12/95	RDB															
Engine		Information			A10	A20	A40	A50	A70	C10 - C30	C20	E01							
All engines										1.970.299, 1.970.312	C10	1.501.630							
				ENGINE															
1.8 XR2i 16V	Petrol	96	02/92-12/95	RQC															
Engine		Information			A10	A20	A40	A50	A70	C10 - C30	C20	E01							
All engines										1.970.299, 1.970.312	C10	1.501.630							
				FIESTA IV															
				ENGINE															
1.0 i	Petrol	38	04/96-09/99	OEAL															
Engine		Information			A10	A20	A40	A50	A70	C10 - C30	C20	E01							
All engines		->year 30/09/98								1.970.364	C10	1.501.639							
All engines		01/10/98 ->								1.970.532	C10	1.501.568							
				ENGINE															
1.25 i 16V	Petrol	55	08/95-01/02	DHA, DHB, DHC, DHD, DHE, DHF, DHG															
Engine		Information			A10	A20	A40	A50	A70	C10 - C30	C20	E01							
All engines		->year 01/05/98, x 1, D.I.S.								1.970.2995	C10								
All engines		01/06/98 ->, x 1, D.I.S.								1.970.532	C10								
All engines		->year 31/05/98										1.501.619							
				FUNCTIONS ON THE VEHICLE															
A10		CONDENSER		A20		CONTACT SET		A40		DISTRIBUTOR CAP		A50		ROTOR		A70		PICK-UP	
C10		COIL		C20		IGNITION MODULE		C30		ELECTRONIC IGNITION KIT		E01		IGNITION CABLE SET					

Vehicle	alim.	kW	Date	Engine	FUNCTIONS ON THE VEHICLE									
					A10	A20	A40	A50	A70	C10 - C30	C20	E01		
ENGINE														
1.25 i 16V	Petrol	55	08/95-01/02	DHA, DHB, DHC, DHD, DHE, DHF, DHG										
Engine	Information				A10	A20	A40	A50	A70	C10 - C30	C20	E01		
All engines	01/06/98 ->													1.501.625
ENGINE														
1.3	Petrol	44	02/96-08/03	J4C										
Engine	Information				A10	A20	A40	A50	A70	C10 - C30	C20	E01		
All engines	01/10/98 ->													1.501.568
All engines	->year 30/09/98													1.501.639
ENGINE														
1.3 i	Petrol	37	08/95-01/02	JJA, JJC, JJE, JJJ, JJK, JJM										
Engine	Information				A10	A20	A40	A50	A70	C10 - C30	C20	E01		
All engines	x 1, D.I.S.									1.970.532	C10			
All engines	01/10/98 ->													1.501.568
All engines	->year 30/09/98													1.501.639
ENGINE														
1.3 i	Petrol	44	08/95-01/02	J4C, J4J, J4L, J4Q, J4R, J4T, JBC										
Engine	Information				A10	A20	A40	A50	A70	C10 - C30	C20	E01		
Eng. JBC										1.970.312	C10			
Eng. JBC	->year 30/09/98									1.970.364	C10			
Eng. J4C, J4J, J4L, J4Q, J4R, J4T	x 1, D.I.S.									1.970.532	C10			
Eng. JBC	01/10/98 ->									1.970.532	C10			
All engines	01/10/98 ->													1.501.568
All engines	->year 30/09/98													1.501.639
ENGINE														
1.4	Petrol	66	08/98-04/02	FHA										
Engine	Information				A10	A20	A40	A50	A70	C10 - C30	C20	E01		
All engines	x 1, D.I.S.									1.970.532	C10			
ENGINE														
1.4 i 16V	Petrol	66	04/96-01/02	FHA, FHE										
Engine	Information				A10	A20	A40	A50	A70	C10 - C30	C20	E01		
All engines	x 1, D.I.S.									1.970.532	C10			
All engines	->year 31/05/98													1.501.619
All engines	01/06/98 ->													1.501.625
ENGINE														
1.6 16V Sport	Petrol	76	02/00-01/02	L1T, L1V										
Engine	Information				A10	A20	A40	A50	A70	C10 - C30	C20	E01		
All engines	x 1, D.I.S.									1.970.532	C10			
All engines														1.501.625
FIESTA V														
ENGINE														
1.25 16V	Petrol	51	03/03-06/08	M7JA, M7JB										
Engine	Information				A10	A20	A40	A50	A70	C10 - C30	C20	E01		
All engines	01/03/05 ->, x 1, D.I.S.									1.970.481	C10			
All engines	->year 01/02/05, x 1, D.I.S.									1.970.532	C10			
All engines	01/02/07 ->													1.499.242
All engines	->year 01/02/07													1.501.625
ENGINE														
1.25 16V	Petrol	55	05/02-06/08	FUJA, FUJB										
Engine	Information				A10	A20	A40	A50	A70	C10 - C30	C20	E01		
All engines	01/03/05 ->, x 1, D.I.S.									1.970.481	C10			
All engines	->year 01/02/05, x 1, D.I.S.									1.970.532	C10			
All engines	01/02/07 ->													1.499.242
All engines	->year 01/02/07													1.501.625
ENGINE														
1.3	Petrol	44	11/01-08/08	BAJA										
Engine	Information				A10	A20	A40	A50	A70	C10 - C30	C20	E01		
All engines	01/03/05 ->, x 1, D.I.S.									1.970.481	C10			
All engines	->year 01/02/05, x 1, D.I.S.									1.970.532	C10			
All engines	03/07/02 ->													1.499.208

A10 CONDENSER	A20 CONTACT SET	A40 DISTRIBUTOR CAP	A50 ROTOR	A70 PICK-UP
C10 COIL	C20 IGNITION MODULE	C30 ELECTRONIC IGNITION KIT	E01 IGNITION CABLE SET	

The present application list is a brief version. For the detailed information about the possibility of installation on a specific vehicle, please refer to our web-catalogue <http://catalogo.facet.eu/>

Vehicle	alim.	kW	Date	Engine	FUNCTIONS ON THE VEHICLE							
					A10	A20	A40	A50	A70	C10 - C30	C20	E01

ENGINE				
1.3	Petrol	51	11/01-06/08	A9JA, A9JB

Engine	Information	A10	A20	A40	A50	A70	C10 - C30	C20	E01
All engines	01/03/05 ->, 01/08/07 ->, x 1, D.I.S.						1.970.481	C10	
Eng. A9JB	23/08/07 ->						1.970.481	C10	
All engines	->year 01/02/05, ->year 01/07/07, x 1, D.I.S.						1.970.532	C10	
Eng. A9JB	->year 23/08/07						1.970.532	C10	
All engines	03/07/02 ->								1.499.208

ENGINE				
1.4	Petrol	59	05/02-09/05	FXJA

Engine	Information	A10	A20	A40	A50	A70	C10 - C30	C20	E01
All engines	01/03/05 ->, x 1, D.I.S.						1.970.481	C10	
All engines	->year 01/02/05, x 1, D.I.S.						1.970.532	C10	

ENGINE				
1.4 16V	Petrol	59	11/01-06/08	FXJA, FXJB

Engine	Information	A10	A20	A40	A50	A70	C10 - C30	C20	E01
All engines	01/03/05 ->, x 1, D.I.S.						1.970.481	C10	
All engines	->year 01/02/05, x 1, D.I.S.						1.970.532	C10	
All engines	01/02/07 ->								1.499.242
All engines	->year 01/02/07								1.501.625

ENGINE				
1.6 16V	Petrol	74	11/01-06/08	FYJA, FYJB

Engine	Information	A10	A20	A40	A50	A70	C10 - C30	C20	E01
All engines	01/03/05 ->, x 1, D.I.S.						1.970.481	C10	
All engines	->year 01/02/05, x 1, D.I.S.						1.970.532	C10	
All engines	01/02/07 ->								1.499.242
All engines	->year 01/02/07								1.501.625

ENGINE				
ST150	Petrol	110	03/05-06/08	N4JB

Engine	Information	A10	A20	A40	A50	A70	C10 - C30	C20	E01
All engines	x 1, D.I.S.						1.970.481	C10	
All engines	->year 01/02/05, x 1, D.I.S.						1.970.532	C10	

FIESTA VI

ENGINE				
1.0	Petrol	48	01/13->	XMJA, XMJB, XMJC, XMJD

Engine	Information	A10	A20	A40	A50	A70	C10 - C30	C20	E01
All engines	x 3, COIL ON PLUG						1.970.619	C10	

ENGINE				
1.0	Petrol	59	10/12->	P4JA, P4JB, P4JC, P4JD

Engine	Information	A10	A20	A40	A50	A70	C10 - C30	C20	E01
All engines	x 3, COIL ON PLUG						1.970.619	C10	

ENGINE				
1.0 EcoBoost	Petrol	103	05/14->	YYJA, YYJB

Engine	Information	A10	A20	A40	A50	A70	C10 - C30	C20	E01
All engines	x 3, COIL ON PLUG						1.970.619	C10	

ENGINE				
1.0 EcoBoost	Petrol	74	01/13->	SFJA, SFJB, SFJC, SFJD

Engine	Information	A10	A20	A40	A50	A70	C10 - C30	C20	E01
All engines	x 3, COIL ON PLUG						1.970.619	C10	

ENGINE				
1.0 EcoBoost	Petrol	92	09/12->	M1JE, M1JH

Engine	Information	A10	A20	A40	A50	A70	C10 - C30	C20	E01
All engines	Qty: 3						1.970.619	C10	
All engines	x 3, COIL ON PLUG						1.970.619	C10	

ENGINE				
1.0 Sport	Petrol	103	05/14-04/17	YYJA, YYJB

Engine	Information	A10	A20	A40	A50	A70	C10 - C30	C20	E01
All engines	x 3, COIL ON PLUG						1.970.619	C10	

A10 CONDENSER	A20 CONTACT SET	A40 DISTRIBUTOR CAP	A50 ROTOR	A70 PICK-UP
C10 COIL	C20 IGNITION MODULE	C30 ELECTRONIC IGNITION KIT	E01 IGNITION CABLE SET	

Vehicle	alim.	kW	Date	Engine	FUNCTIONS ON THE VEHICLE									
					A10	A20	A40	A50	A70	C10 - C30	C20	E01		
ENGINE														
1.25	Petrol	44	06/08->	STJA, STJB, STJC, STJD										
Engine	Information				A10	A20	A40	A50	A70	C10 - C30	C20	E01		
All engines	x 1, D.I.S.									1.970.481	C10			
Eng. STJB										1.970.481	C10			
Eng. STJA, STJB													1.499.242	
ENGINE														
1.25	Petrol	60	06/08->	SNJA, SNJB, SNJC, SNJD										
Engine	Information				A10	A20	A40	A50	A70	C10 - C30	C20	E01		
All engines	x 1, D.I.S.									1.970.481	C10			
All engines													1.499.242	
ENGINE														
1.4	Petrol	66	10/08->	--										
Engine	Information				A10	A20	A40	A50	A70	C10 - C30	C20	E01		
All engines										1.970.481	C10		1.499.242	
ENGINE														
1.4	Petrol	70	06/08->	--										
Engine	Information				A10	A20	A40	A50	A70	C10 - C30	C20	E01		
All engines										1.970.481	C10		1.499.242	
ENGINE														
1.4	Petrol	71	10/08-12/12	24KH1CT5H1, 8MA1.77, RTJA, SPJA, SPJC, SPJE										
Engine	Information				A10	A20	A40	A50	A70	C10 - C30	C20	E01		
Eng. 24KH1CT5H1, RTJA, SPJA, SPJC, SPJE	x 1, D.I.S.									1.970.481	C10			
Eng. 8MA1.77, SPJC													1.499.242	
ENGINE														
1.4 LPG	Petrol/ Liquified Petroleum Gas (LPG)	68	01/09-04/17	RTJA, RTJB, RTJD										
Engine	Information				A10	A20	A40	A50	A70	C10 - C30	C20	E01		
All engines	x 1, D.I.S.									1.970.481	C10			
Eng. RTJA, RTJB													1.499.242	
ENGINE														
1.4 LPG	Petrol/ Liquified Petroleum Gas (LPG)	71	01/09-04/17	RTJA, RTJB, RTJD, SPJA, SPJC, SPJE										
Engine	Information				A10	A20	A40	A50	A70	C10 - C30	C20	E01		
All engines	x 1, D.I.S.									1.970.481	C10			
Eng. RTJA, RTJB													1.499.242	
ENGINE														
1.6	Petrol	62	03/15->	XTJA										
Engine	Information				A10	A20	A40	A50	A70	C10 - C30	C20	E01		
All engines	x 1, D.I.S.									1.970.481	C10			
ENGINE														
1.6 Ti	Petrol	62	09/12->	--										
Engine	Information				A10	A20	A40	A50	A70	C10 - C30	C20	E01		
All engines										1.970.481	C10		1.499.242	
ENGINE														
1.6 Ti	Petrol	77	09/12->	IQJA, IQJC, IQJE										
Engine	Information				A10	A20	A40	A50	A70	C10 - C30	C20	E01		
All engines	x 1, D.I.S.									1.970.481	C10			
Eng. IQJA													1.499.242	
ENGINE														
1.6 Ti	Petrol	88	06/08->	68GR-FKS, HXJA, HXJB, HXJE, RVJA										
Engine	Information				A10	A20	A40	A50	A70	C10 - C30	C20	E01		
Eng. 68GR-FKS, HXJB										1.970.481	C10		1.499.242	
Eng. HXJA, HXJB, HXJE, RVJA	x 1, D.I.S., x 1, D.I.S.									1.970.481	C10			

A10	CONDENSER	A20	CONTACT SET	A40	DISTRIBUTOR CAP	A50	ROTOR	A70	PICK-UP
C10	COIL	C20	IGNITION MODULE	C30	ELECTRONIC IGNITION KIT	E01	IGNITION CABLE SET		

The present application list is a brief version. For the detailed information about the possibility of installation on a specific vehicle, please refer to our web-catalogue <http://catalogo.facet.eu/>

Vehicle	alim.	kW	Date	Engine	FUNCTIONS ON THE VEHICLE							
					A10	A20	A40	A50	A70	C10 - C30	C20	E01

				ENGINE
1.6 Ti	Petrol	99	12/10->	U5JA

Engine	Information	A10	A20	A40	A50	A70	C10 - C30	C20	E01
All engines	x 1, D.I.S.						1.970.481	C10	
All engines									1.499.242

				ENGINE
1.6 Ti-VCT	Petrol	88	10/08-12/12	HXJA, HXJB

Engine	Information	A10	A20	A40	A50	A70	C10 - C30	C20	E01
All engines	x 1, D.I.S.						1.970.481	C10	

FIESTA VII

				ENGINE
1.0 EcoBoost	Petrol	103	06/17->	YYJE, YYJG

Engine	Information	A10	A20	A40	A50	A70	C10 - C30	C20	E01
All engines	x 3, COIL ON PLUG						1.970.619	C10	

				ENGINE
1.0 EcoBoost	Petrol	63	04/18->	QOJA, QOJB, QOJC, QOJD

Engine	Information	A10	A20	A40	A50	A70	C10 - C30	C20	E01
All engines	x 3, COIL ON PLUG						1.970.619	C10	

				ENGINE
1.0 EcoBoost	Petrol	74	05/17->	SFJE, SFJF, SFJH, SFJJ, SFJK, SFJN, SFJP

Engine	Information	A10	A20	A40	A50	A70	C10 - C30	C20	E01
All engines	x 3, COIL ON PLUG						1.970.619	C10	

				ENGINE
1.0 EcoBoost	Petrol	92	05/17->	M1JL, M1JM, M1JP

Engine	Information	A10	A20	A40	A50	A70	C10 - C30	C20	E01
All engines	x 3, COIL ON PLUG						1.970.619	C10	

				ENGINE
1.0 EcoBoost Active	Petrol	103	04/18->	YYJE, YYJG

Engine	Information	A10	A20	A40	A50	A70	C10 - C30	C20	E01
All engines	x 3, COIL ON PLUG						1.970.619	C10	

				ENGINE
1.0 EcoBoost Active	Petrol	74	04/18->	SFJE, SFJF, SFJH, SFJJ, SFJK, SFJN, SFJP

Engine	Information	A10	A20	A40	A50	A70	C10 - C30	C20	E01
All engines	x 3, COIL ON PLUG						1.970.619	C10	

				ENGINE
1.0 EcoBoost Active	Petrol	92	04/18->	M1JL, M1JM, M1JP

Engine	Information	A10	A20	A40	A50	A70	C10 - C30	C20	E01
All engines	x 3, COIL ON PLUG						1.970.619	C10	

				ENGINE
1.0 EcoBoost mHEV	Petrol/ Electric	114	07/20->	BZJA

Engine	Information	A10	A20	A40	A50	A70	C10 - C30	C20	E01
All engines	x 4, COIL ON PLUG						1.970.619	C10	

				ENGINE
1.0 EcoBoost mHEV Active	Petrol/ Electric	114	01/21->	BZJA

Engine	Information	A10	A20	A40	A50	A70	C10 - C30	C20	E01
All engines	x 4, COIL ON PLUG						1.970.619	C10	

FOCUS C-MAX

				ENGINE
1.6	Petrol	74	10/03-03/07	HWDA, HWDB, SHDA, SHDB, SHDC

Engine	Information	A10	A20	A40	A50	A70	C10 - C30	C20	E01
All engines	01/03/05->, x 1, D.I.S.						1.970.481	C10	
All engines	->year 01/02/05, x 1, D.I.S.						1.970.532	C10	
Eng. HWDA, HWDB	26/03/07->								1.499.242
Eng. HWDA, HWDB	->year 26/03/07								1.501.625

				ENGINE
1.6 Ti	Petrol	85	08/04-03/07	HXDA, HXDB, SIDA









Engine	Information	A10	A20	A40	A50	A70	C10 - C30	C20	E01
All engines	01/03/05->, x 1, D.I.S.						1.970.481	C10	

A10 CONDENSER	A20 CONTACT SET	A40 DISTRIBUTOR CAP	A50 ROTOR	A70 PICK-UP
C10 COIL	C20 IGNITION MODULE	C30 ELECTRONIC IGNITION KIT	E01 IGNITION CABLE SET	

Vehicle	alim.	kW	Date	Engine	FUNCTIONS ON THE VEHICLE									
					A10	A20	A40	A50	A70	C10 - C30	C20	E01		
ENGINE														
1.6 Ti	Petrol	85	08/04-03/07	HXDA, HXDB, SIDA										
Engine	Information				A10	A20	A40	A50	A70	C10 - C30	C20	E01		
All engines	->year 01/02/05, x 1, D.I.S.									1.970.532	C10			
Eng. HXDA, SIDA	26/03/07 ->												1.499.242	
Eng. HXDA, SIDA	->year 26/03/07												1.501.625	
ENGINE														
1.8	Petrol	88	10/03-03/07	CSDA, CSDB										
Engine	Information				A10	A20	A40	A50	A70	C10 - C30	C20	E01		
All engines	x 4, COIL ON PLUG									1.970.480	C10			
ENGINE														
1.8	Petrol	90	09/05-03/07	QQDC										
Engine	Information				A10	A20	A40	A50	A70	C10 - C30	C20	E01		
All engines	x 4, COIL ON PLUG									1.970.480	C10			
ENGINE														
1.8	Petrol	92	04/04-03/07	Q7DA, QQDA, QQDB										
Engine	Information				A10	A20	A40	A50	A70	C10 - C30	C20	E01		
All engines	x 4, COIL ON PLUG									1.970.480	C10			
ENGINE														
1.8 Flexifuel	Petrol/ Ethanol	92	01/06-03/07	Q7DA										
Engine	Information				A10	A20	A40	A50	A70	C10 - C30	C20	E01		
All engines	x 4, COIL ON PLUG									1.970.480	C10			
ENGINE														
2.0	Petrol	107	03/04-03/07	AODA, AODB, AODE, SYDA										
Engine	Information				A10	A20	A40	A50	A70	C10 - C30	C20	E01		
All engines	x 4, COIL ON PLUG									1.970.480	C10			
FOCUS I														
ENGINE														
1.4	Petrol	55	04/99-03/05	FXDA, FXDB, FXDC, FXDD										
Engine	Information				A10	A20	A40	A50	A70	C10 - C30	C20	E01		
All engines	x 1, D.I.S.									1.970.532	C10			
ENGINE														
1.4 16V	Petrol	55	10/98-11/04	FXDA, FXDB, FXDC, FXDD										
Engine	Information				A10	A20	A40	A50	A70	C10 - C30	C20	E01		
All engines	x 1, D.I.S.									1.970.532	C10			
Eng. FXDA										1.970.532	C10			
All engines													1.501.625	
ENGINE														
1.6	Petrol	74	04/99-03/05	FYDA, FYDB, FYDC, FYDD										
Engine	Information				A10	A20	A40	A50	A70	C10 - C30	C20	E01		
All engines	x 1, D.I.S.									1.970.532	C10			
ENGINE														
1.6 16V	Petrol	66	02/01-11/04	--										
Engine	Information				A10	A20	A40	A50	A70	C10 - C30	C20	E01		
All engines										1.970.532	C10		1.501.624	
ENGINE														
1.6 16V	Petrol	74	10/98-11/04	FYDA, FYDB, FYDC, FYDD, FYDH										
Engine	Information				A10	A20	A40	A50	A70	C10 - C30	C20	E01		
All engines	x 1, D.I.S.									1.970.532	C10			
All engines													1.501.625	
ENGINE														
1.6 16V Flexifuel	Petrol/ Ethanol	75	01/02-11/04	FYDH										
Engine	Information				A10	A20	A40	A50	A70	C10 - C30	C20	E01		
All engines	x 1, D.I.S.									1.970.532	C10			
All engines													1.499.208	

A10	CONDENSER	A20	CONTACT SET	A40	DISTRIBUTOR CAP	A50	ROTOR	A70	PICK-UP
C10	COIL	C20	IGNITION MODULE	C30	ELECTRONIC IGNITION KIT	E01	IGNITION CABLE SET		

The present application list is a brief version. For the detailed information about the possibility of installation on a specific vehicle, please refer to our web-catalogue <http://catalogo.facet.eu/>

					FUNCTIONS ON THE VEHICLE							
Vehicle	alim.	kW	Date	Engine								
1.8	Petrol	85	04/99-03/05	ENGINE EYDB, EYDC, EYDD, EYDE, EYDF, EYDG								
Engine					A10	A20	A40	A50	A70	C10 - C30	C20	E01
Information										1.970.532	C10	
All engines												
All engines												1.501.624
1.8 16V	Petrol	85	10/98-11/04	ENGINE EYDB, EYDC, EYDD, EYDE, EYDF, EYDG, EYDI, EYDJ, EYDL								
Engine					A10	A20	A40	A50	A70	C10 - C30	C20	E01
Information										1.970.532	C10	
All engines												
All engines												1.501.624
1.8 16V BiFuel	Petrol/ Liquified Petroleum Gas (LPG)	85	09/02-07/04	ENGINE EYDD, EYDG, EYDI								
Engine					A10	A20	A40	A50	A70	C10 - C30	C20	E01
Information										1.970.532	C10	
All engines												
All engines												1.501.624
1.8 BiFuel	Petrol/ Liquified Petroleum Gas (LPG)	82	02/03-01/05	ENGINE EYDL								
Engine					A10	A20	A40	A50	A70	C10 - C30	C20	E01
Information										1.970.532	C10	
All engines												
All engines												1.501.624
2.0 16V	Petrol	96	10/98-11/04	ENGINE EDDB, EDDC, EDDD, EDDF								
Engine					A10	A20	A40	A50	A70	C10 - C30	C20	E01
Information										1.970.532	C10	
All engines												
All engines												1.501.624
RS	Petrol	158	10/02-11/04	ENGINE HMDA								
Engine					A10	A20	A40	A50	A70	C10 - C30	C20	E01
Information										1.970.532	C10	
All engines												
All engines												1.501.624
ST170	Petrol	127	03/02-11/04	ENGINE ALDA								
Engine					A10	A20	A40	A50	A70	C10 - C30	C20	E01
Information										1.970.532	C10	
All engines												
All engines												1.501.624
FOCUS II												
1.4	Petrol	59	07/04-09/12	ENGINE ASDA, ASDB								
Engine					A10	A20	A40	A50	A70	C10 - C30	C20	E01
Information										1.970.481	C10	
All engines												
All engines										1.970.532	C10	
All engines												1.499.242
All engines												1.501.625
1.6	Petrol	74	07/04-09/12	ENGINE HWDA, HWDB, SHDA, SHDB, SHDC								
Engine					A10	A20	A40	A50	A70	C10 - C30	C20	E01
Information										1.970.481	C10	
All engines												
All engines										1.970.532	C10	
All engines												1.499.242
All engines												1.501.625

A10 CONDENSER	A20 CONTACT SET	A40 DISTRIBUTOR CAP	A50 ROTOR	A70 PICK-UP
C10 COIL	C20 IGNITION MODULE	C30 ELECTRONIC IGNITION KIT	E01 IGNITION CABLE SET	

Vehicle	alim.	kW	Date	Engine	FUNCTIONS ON THE VEHICLE									
					A10	A20	A40	A50	A70	C10 - C30	C20	E01		
ENGINE														
1.6 LPG	Petrol/ Liquified Petroleum Gas (LPG)	85	10/09-09/12	SIDA										
Engine	Information				A10	A20	A40	A50	A70	C10 - C30	C20	E01		
All engines	x 1, D.I.S.									1.970.481	C10			
ENGINE														
1.6 Ti	Petrol	85	07/04-09/12	HXDA, HXDB, SIDA										
Engine	Information				A10	A20	A40	A50	A70	C10 - C30	C20	E01		
All engines	01/03/05 ->, 01/03/11 ->, ->year 01/02/11, x 1, D.I.S., x 1, D.I.S.									1.970.481	C10			
All engines	->year 01/02/05, x 1, D.I.S.									1.970.532	C10			
Eng. HXDA, HXDB	26/03/07 ->												1.499.242	
Eng. HXDA, HXDB	->year 26/03/07												1.501.625	
ENGINE														
1.6 Ti-VCT	Petrol	85	09/05-07/11	HXDA, HXDB, SIDA										
Engine	Information				A10	A20	A40	A50	A70	C10 - C30	C20	E01		
All engines	x 1, D.I.S.									1.970.481	C10			
ENGINE														
1.8	Petrol	92	03/06-09/12	Q7DA, QQDA, QQDB										
Engine	Information				A10	A20	A40	A50	A70	C10 - C30	C20	E01		
All engines	x 4, COIL ON PLUG									1.970.480	C10			
ENGINE														
1.8 Flexifuel	Petrol/ Ethanol	92	01/06-09/12	Q7DA, QQDA, QQDB										
Engine	Information				A10	A20	A40	A50	A70	C10 - C30	C20	E01		
All engines	x 4, COIL ON PLUG									1.970.480	C10			
ENGINE														
1.8 Flexifuel	Petrol/ Ethanol	96	12/05-01/08	--, 1LQ4(364CUV8), 4LQ2(122CUL4), QQDD										
Engine	Information				A10	A20	A40	A50	A70	C10 - C30	C20	E01		
Eng. --, QQDD	Qty: 4									1.970.480	C10			
Eng. 1LQ4(364CUV8), 4LQ2(122CUL4)	x 4, COIL ON PLUG									1.970.480	C10			
ENGINE														
1.8 Flexifuel	Petrol/ Ethanol	97	12/05-01/08	--										
Engine	Information				A10	A20	A40	A50	A70	C10 - C30	C20	E01		
All engines	Qty: 4									1.970.480	C10			
ENGINE														
2.0	Petrol	104	06/05-09/08	SYDA										
Engine	Information				A10	A20	A40	A50	A70	C10 - C30	C20	E01		
All engines	x 4, COIL ON PLUG									1.970.480	C10			
ENGINE														
2.0	Petrol	107	07/04-09/12	AODA, AODB, AODE, SYDA										
Engine	Information				A10	A20	A40	A50	A70	C10 - C30	C20	E01		
All engines	x 4, COIL ON PLUG									1.970.480	C10			
ENGINE														
2.0 CNG	Petrol/ Compressed Natural Gas (CNG)	107	04/09-07/11	SYDA										
Engine	Information				A10	A20	A40	A50	A70	C10 - C30	C20	E01		
All engines	x 4, COIL ON PLUG									1.970.480	C10			
ENGINE														
2.0 Flex	Petrol/ Ethanol	107	10/08-03/10	SYDA										
Engine	Information				A10	A20	A40	A50	A70	C10 - C30	C20	E01		
All engines	x 4, COIL ON PLUG									1.970.480	C10			

A10 CONDENSER	A20 CONTACT SET	A40 DISTRIBUTOR CAP	A50 ROTOR	A70 PICK-UP
C10 COIL	C20 IGNITION MODULE	C30 ELECTRONIC IGNITION KIT	E01 IGNITION CABLE SET	

The present application list is a brief version. For the detailed information about the possibility of installation on a specific vehicle, please refer to our web-catalogue <http://catalogo.facet.eu/>

					FUNCTIONS ON THE VEHICLE							
Vehicle	alim.	kW	Date	Engine								

				ENGINE
2.0 LPG	Petrol/ Liquified Petro- leum Gas (LPG)	107	06/08-07/11	SYDA

Engine	Information	A10	A20	A40	A50	A70	C10 - C30	C20	E01
All engines	x 4, COIL ON PLUG						1.970.480	C10	

				ENGINE
2.5 RS	Petrol	224	01/09-07/11	JZDA

Engine	Information	A10	A20	A40	A50	A70	C10 - C30	C20	E01
All engines	x 5, COIL ON PLUG						1.970.478	C10	

				ENGINE
2.5 RS 500	Petrol	257	05/10-07/11	JZDA

Engine	Information	A10	A20	A40	A50	A70	C10 - C30	C20	E01
All engines	x 5, COIL ON PLUG						1.970.478	C10	

				ENGINE
2.5 ST	Petrol	166	10/05-09/12	HYDA

Engine	Information	A10	A20	A40	A50	A70	C10 - C30	C20	E01
All engines	x 5, COIL ON PLUG						1.970.478	C10	

FOCUS III

				ENGINE
1.0 EcoBoost	Petrol	103	10/17->	M1DH

Engine	Information	A10	A20	A40	A50	A70	C10 - C30	C20	E01
All engines	x 3, COIL ON PLUG						1.970.619	C10	

				ENGINE
1.0 EcoBoost	Petrol	74	02/12->	M2DA, M2DB, M2DC, SFDA, SFDB

Engine	Information	A10	A20	A40	A50	A70	C10 - C30	C20	E01
All engines	x 3, COIL ON PLUG						1.970.619	C10	

				ENGINE
1.0 EcoBoost	Petrol	92	02/12->	M1DA, M1DC, M1DD

Engine	Information	A10	A20	A40	A50	A70	C10 - C30	C20	E01
All engines	x 3, COIL ON PLUG						1.970.619	C10	

				ENGINE
1.5 EcoBoost	Petrol	110	09/14->	M8DA, M8DB, M8DD, M8DE

Engine	Information	A10	A20	A40	A50	A70	C10 - C30	C20	E01
All engines	x 4, COIL ON PLUG						1.970.623	C10	

				ENGINE
1.5 EcoBoost	Petrol	134	09/14->	M9DA, M9DB

Engine	Information	A10	A20	A40	A50	A70	C10 - C30	C20	E01
All engines	x 4, COIL ON PLUG						1.970.623	C10	

				ENGINE
1.6 Flexifuel	Petrol/ Ethanol	88	07/10->	MUDA, MUDD

Engine	Information	A10	A20	A40	A50	A70	C10 - C30	C20	E01
All engines	x 1, D.I.S.						1.970.481	C10	
Eng. MUDA									1.499.242

				ENGINE
1.6 LPG	Petrol/ Liquified Petro- leum Gas (LPG)	86	02/12->	MUDA

Engine	Information	A10	A20	A40	A50	A70	C10 - C30	C20	E01
All engines	x 1, D.I.S.						1.970.481	C10	
All engines									1.499.242

				ENGINE
1.6 LPG	Petrol/ Liquified Petro- leum Gas (LPG)	88	02/12->	MUDA, MUDD

Engine	Information	A10	A20	A40	A50	A70	C10 - C30	C20	E01
All engines	x 1, D.I.S.						1.970.481	C10	
Eng. MUDA									1.499.242

A10	CONDENSER	A20	CONTACT SET	A40	DISTRIBUTOR CAP	A50	ROTOR	A70	PICK-UP
C10	COIL	C20	IGNITION MODULE	C30	ELECTRONIC IGNITION KIT	E01	IGNITION CABLE SET		

Vehicle	alim.	kW	Date	Engine	FUNCTIONS ON THE VEHICLE									
					A10	A20	A40	A50	A70	C10 - C30	C20	E01		
ENGINE														
1.6 Ti	Petrol	63	08/11->	XTDA, XTDB										
Engine	Information			A10	A20	A40	A50	A70	C10 - C30	C20	E01			
All engines	x 1, D.I.S.								1.970.481	C10				
Eng. XTDA														1.499.242
ENGINE														
1.6 Ti	Petrol	77	07/10->	IQDA, IQDB, IQDC										
Engine	Information			A10	A20	A40	A50	A70	C10 - C30	C20	E01			
All engines	x 1, D.I.S., x 1, D.I.S.								1.970.481	C10				
Eng. IQDB														1.499.242
ENGINE														
1.6 Ti	Petrol	88	02/12->	MUDA, MUDD										
Engine	Information			A10	A20	A40	A50	A70	C10 - C30	C20	E01			
All engines	x 1, D.I.S.								1.970.481	C10				
Eng. MUDA														1.499.242
ENGINE														
1.6 Ti	Petrol	92	07/10->	PNDA, PNDD										
Engine	Information			A10	A20	A40	A50	A70	C10 - C30	C20	E01			
All engines	x 1, D.I.S.								1.970.481	C10				
Eng. PNDA														1.499.242
ENGINE														
1.6 Ti-VCT	Petrol	90	07/10->	--										
Engine	Information			A10	A20	A40	A50	A70	C10 - C30	C20	E01			
All engines									1.970.481	C10				1.499.242
FUSION														
1.25	Petrol	51	10/02->	--										
Engine	Information			A10	A20	A40	A50	A70	C10 - C30	C20	E01			
All engines	21/02/05 ->								1.970.481	C10				
All engines	->year 21/02/05								1.970.532	C10				
All engines	01/02/07 ->													1.499.242
All engines	->year 01/02/07													1.501.625
ENGINE														
1.25	Petrol	55	08/04-12/12	FUJA, FUJB										
Engine	Information			A10	A20	A40	A50	A70	C10 - C30	C20	E01			
All engines	01/03/05 ->, x 1, D.I.S.								1.970.481	C10				
All engines	->year 01/02/05, x 1, D.I.S.								1.970.532	C10				
All engines	01/02/07 ->													1.499.242
All engines	->year 01/02/07													1.501.625
ENGINE														
1.3	Petrol	44	11/02->	BAJA										
Engine	Information			A10	A20	A40	A50	A70	C10 - C30	C20	E01			
All engines	01/03/05 ->, x 1, D.I.S.								1.970.481	C10				
All engines	23/08/07 ->								1.970.481	C10				
All engines	->year 01/02/05, x 1, D.I.S.								1.970.532	C10				
All engines	->year 23/08/07								1.970.532	C10				
All engines														1.499.208
ENGINE														
1.4	Petrol	55	08/02->	--										
Engine	Information			A10	A20	A40	A50	A70	C10 - C30	C20	E01			
All engines	21/02/05 ->								1.970.481	C10				
All engines	->year 21/02/05								1.970.532	C10				
All engines	01/02/07 ->													1.499.242
All engines	->year 01/02/07													1.501.625
ENGINE														
1.4	Petrol	59	08/02-12/12	FXJA, FXJB, FXJC										
Engine	Information			A10	A20	A40	A50	A70	C10 - C30	C20	E01			
All engines	01/03/05 ->, 01/03/11 ->, ->year 01/02/11, x 1, D.I.S., x 1, D.I.S.								1.970.481	C10				
All engines	->year 01/02/05, x 1, D.I.S.								1.970.532	C10				
All engines	01/02/07 ->													1.499.242
All engines	->year 01/02/07													1.501.625

A10	CONDENSER	A20	CONTACT SET	A40	DISTRIBUTOR CAP	A50	ROTOR	A70	PICK-UP
C10	COIL	C20	IGNITION MODULE	C30	ELECTRONIC IGNITION KIT	E01	IGNITION CABLE SET		

The present application list is a brief version. For the detailed information about the possibility of installation on a specific vehicle, please refer to our web-catalogue <http://catalogo.facet.eu/>

					FUNCTIONS ON THE VEHICLE							
Vehicle	alim.	kW	Date	Engine								

ENGINE				
1.4 LPG	Petrol/ Liquified Petro- leum Gas (LPG)	59	01/10-12/12	UTJA

Engine	Information	A10	A20	A40	A50	A70	C10 - C30	C20	E01
All engines	x 1, D.I.S.						1.970.481	C10	
All engines									1.499.242

ENGINE				
1.6	Petrol	74	08/02-11/09	FYJA, FYJB, FYJC

Engine	Information	A10	A20	A40	A50	A70	C10 - C30	C20	E01
All engines	01/03/11 ->, x 1, D.I.S.						1.970.481	C10	
All engines	->year 01/02/05, x 1, D.I.S.						1.970.532	C10	
All engines	01/02/07 ->								1.499.242
All engines	->year 01/02/07								1.501.625

ENGINE				
2.0	Petrol	85	03/96-03/06	ZVSA

Engine	Information	A10	A20	A40	A50	A70	C10 - C30	C20	E01
All engines	x 1, D.I.S.						1.970.532	C10	

ENGINE				
2.0i	Petrol	85	11/95-05/06	NSE, ZVSA

Engine	Information	A10	A20	A40	A50	A70	C10 - C30	C20	E01
All engines	x 1, D.I.S.						1.970.532	C10	
All engines	x 1, D.I.S.								1.499.242

ENGINE				
2.3	Petrol	103	11/02-03/06	ESSB

Engine	Information	A10	A20	A40	A50	A70	C10 - C30	C20	E01
All engines	x 1, D.I.S.						1.970.532	C10	

ENGINE				
2.3	Petrol	107	05/00-10/02	ESSA

Engine	Information	A10	A20	A40	A50	A70	C10 - C30	C20	E01
All engines	x 1, D.I.S.						1.970.532	C10	

ENGINE				
2.3 16V	Petrol	103	09/01-05/06	ESSB

Engine	Information	A10	A20	A40	A50	A70	C10 - C30	C20	E01
All engines	x 1, D.I.S.						1.970.532	C10	
All engines									1.501.976

ENGINE				
2.3 16V	Petrol	107	01/97-05/06	ESSA, Y5B

Engine	Information	A10	A20	A40	A50	A70	C10 - C30	C20	E01
All engines	01/04/00 ->, x 1, D.I.S.						1.970.532	C10	
All engines	01/04/00 ->, ->year 01/12/00, x 1, D.I.S.								1.501.145
Eng. Y5B	01/01/01 ->, x 1, D.I.S.								1.501.976
Eng. ESSA									1.501.976

ENGINE				
2.8	Petrol	128	11/95-07/00	AAA

Engine	Information	A10	A20	A40	A50	A70	C10 - C30	C20	E01
All engines	01/04/00 ->, x 6, COIL ON PLUG						1.970.435	C10	

ENGINE				
2.8	Petrol	150	05/00-03/06	AYL

Engine	Information	A10	A20	A40	A50	A70	C10 - C30	C20	E01
All engines	x 6, COIL ON PLUG						1.970.435	C10	

ENGINE				
2.8 i V6	Petrol	128	11/95-04/00	AAA, AMY

Engine	Information	A10	A20	A40	A50	A70	C10 - C30	C20	E01
All engines	01/04/00 ->, x 6, COIL ON PLUG						1.970.435	C10	

ENGINE				
2.8 V6	Petrol	150	04/00-05/06	AYL

Engine	Information	A10	A20	A40	A50	A70	C10 - C30	C20	E01
All engines	x 6, COIL ON PLUG						1.970.435	C10	

A10 CONDENSER	A20 CONTACT SET	A40 DISTRIBUTOR CAP	A50 ROTOR	A70 PICK-UP
C10 COIL	C20 IGNITION MODULE	C30 ELECTRONIC IGNITION KIT	E01 IGNITION CABLE SET	

Vehicle	alim.	kW	Date	Engine	FUNCTIONS ON THE VEHICLE									
					A10	A20	A40	A50	A70	C10 - C30	C20	E01		
GALAXY II														
2.0	Petrol	107	05/06-06/15	ENGINE AOWA, AOWB, TBWA, TBWB										
Engine		Information			A10	A20	A40	A50	A70	C10 - C30	C20	E01		
All engines		x 4, COIL ON PLUG								1.970.480	C10			
2.0 Flexifuel	Petrol/ Ethanol	107	05/06-06/15	ENGINE TBWA, TBWB										
Engine		Information			A10	A20	A40	A50	A70	C10 - C30	C20	E01		
All engines		x 4, COIL ON PLUG								1.970.480	C10			
2.5 ST	Petrol	162	05/06->	ENGINE HUWA										
Engine		Information			A10	A20	A40	A50	A70	C10 - C30	C20	E01		
All engines		Qty: 5								1.970.478	C10			
GALAXY III														
1.5 EcoBoost	Petrol	118	01/15-06/18	ENGINE UNCJ, UNCK										
Engine		Information			A10	A20	A40	A50	A70	C10 - C30	C20	E01		
All engines		x 4, COIL ON PLUG								1.970.623	C10			
1.5 EcoBoost	Petrol	121	07/18->	ENGINE C15HDTX										
Engine		Information			A10	A20	A40	A50	A70	C10 - C30	C20	E01		
All engines		x 4, COIL ON PLUG								1.970.623	C10			
GRANADA														
1.7	Petrol	51	08/77-05/82	ENGINE TV 17 LC										
Engine		Information			A10	A20	A40	A50	A70	C10 - C30	C20	E01		
All engines		version Bosch					1.306.079	1.406.121R						
All engines										1.970.169	C10		1.501.078	
2.0	Petrol	74	08/79-08/85	ENGINE NEP										
Engine		Information			A10	A20	A40	A50	A70	C10 - C30	C20	E01		
All engines		version Bosch					1.306.079	1.406.121R						
All engines										1.970.169	C10		1.501.078	
GRAND C-MAX														
1.0 EcoBoost	Petrol	74	10/12-06/19	ENGINE M2DA, M2DC, SFDA										
Engine		Information			A10	A20	A40	A50	A70	C10 - C30	C20	E01		
Eng. M2DA, M2DC		x 3, COIL ON PLUG								1.970.619	C10			
Eng. SFDA		Qty: 3								1.970.619	C10			
1.0 EcoBoost	Petrol	92	10/12-06/19	ENGINE M1DA, M1DD										
Engine		Information			A10	A20	A40	A50	A70	C10 - C30	C20	E01		
All engines		x 3, COIL ON PLUG								1.970.619	C10			
1.5 EcoBoost	Petrol	110	03/15-06/19	ENGINE M8DB, M8DF										
Engine		Information			A10	A20	A40	A50	A70	C10 - C30	C20	E01		
All engines		x 4, COIL ON PLUG								1.970.623	C10			
1.5 EcoBoost	Petrol	134	03/15-06/19	ENGINE M9DB										
Engine		Information			A10	A20	A40	A50	A70	C10 - C30	C20	E01		
All engines		x 4, COIL ON PLUG								1.970.623	C10			
1.6 Ti	Petrol	63	12/10-06/19	ENGINE XTDA										
Engine		Information			A10	A20	A40	A50	A70	C10 - C30	C20	E01		
All engines		x 1, D.I.S.								1.970.481	C10			
1.6 Ti	Petrol	77	12/10-06/19	ENGINE IQDA, IQDB										
Engine		Information			A10	A20	A40	A50	A70	C10 - C30	C20	E01		
All engines		x 1, D.I.S.								1.970.481	C10			
All engines													1.499.242	

A10	CONDENSER	A20	CONTACT SET	A40	DISTRIBUTOR CAP	A50	ROTOR	A70	PICK-UP
C10	COIL	C20	IGNITION MODULE	C30	ELECTRONIC IGNITION KIT	E01	IGNITION CABLE SET		

The present application list is a brief version. For the detailed information about the possibility of installation on a specific vehicle, please refer to our web-catalogue <http://catalogo.facet.eu/>

Vehicle	alim.	kW	Date	Engine	FUNCTIONS ON THE VEHICLE							
					A10	A20	A40	A50	A70	C10 - C30	C20	E01

ENGINE				
1.6 Ti	Petrol	92	12/10-06/19	PNDA, PNDD

Engine	Information	A10	A20	A40	A50	A70	C10 - C30	C20	E01
All engines	x 1, D.I.S.						1.970.481	C10	
Eng. PNDA									1.499.242

ENGINE				
1.3	Petrol	51	09/02-03/04	A9A, A9B

Engine	Information	A10	A20	A40	A50	A70	C10 - C30	C20	E01
All engines	x 1, D.I.S.						1.970.532	C10	

ENGINE				
1.3 i	Petrol	36	06/98-11/08	JJD, JJF, JJG, JJH, JJL

Engine	Information	A10	A20	A40	A50	A70	C10 - C30	C20	E01
All engines	x 1, D.I.S.						1.970.532	C10	
All engines	15/09/98 ->								1.501.568
All engines	->year 15/09/98								1.501.639

ENGINE				
1.3 i	Petrol	37	09/96-10/02	JJB

Engine	Information	A10	A20	A40	A50	A70	C10 - C30	C20	E01
All engines	x 1, D.I.S.						1.970.532	C10	
All engines	15/09/98 ->								1.501.568
All engines	->year 15/09/98								1.501.639

ENGINE				
1.3 i	Petrol	44	09/96-11/08	BAA, J4D, J4K, J4M, J4N, J4P, J4S

Engine	Information	A10	A20	A40	A50	A70	C10 - C30	C20	E01
All engines	01/08/07 ->, x 1, D.I.S.						1.970.481	C10	
All engines	->year 01/07/07, x 1, D.I.S., x 1, D.I.S.						1.970.532	C10	
Eng. BAA									1.499.208
Eng. J4D, J4K, J4M, J4N, J4P, J4S	15/09/98 ->								1.501.568
Eng. J4D, J4K, J4M, J4N, J4P, J4S	->year 15/09/98								1.501.639

ENGINE				
1.3 i ROCAM	Petrol	51	08/02-11/08	A9A, A9B

Engine	Information	A10	A20	A40	A50	A70	C10 - C30	C20	E01
All engines	01/07/07 ->, x 1, D.I.S.						1.970.481	C10	
All engines	->year 01/06/07, x 1, D.I.S.						1.970.532	C10	
All engines									1.499.208

ENGINE				
1.6	Petrol	70	09/00-11/08	CDB, CDC

Engine	Information	A10	A20	A40	A50	A70	C10 - C30	C20	E01
All engines									1.499.208

ENGINE				
1.6 i	Petrol	70	02/01-11/08	CCA, CDB, CDC

Engine	Information	A10	A20	A40	A50	A70	C10 - C30	C20	E01
Eng. CDB, CDC	01/08/07 ->, x 1, D.I.S.						1.970.481	C10	
Eng. CCA							1.970.532	C10	
Eng. CDB, CDC	->year 01/07/07, x 1, D.I.S.						1.970.532	C10	
All engines									1.499.208

ENGINE				
1.6 i	Petrol	71	11/05-09/08	HL16SL9B

Engine	Information	A10	A20	A40	A50	A70	C10 - C30	C20	E01
All engines	01/07/07 ->, x 1, D.I.S.						1.970.481	C10	
All engines	->year 01/06/07, x 1, D.I.S.						1.970.532	C10	

ENGINE				
1.2	Petrol	51	10/08-05/16	169A4000, FP4

Engine	Information	A10	A20	A40	A50	A70	C10 - C30	C20	E01
All engines	x 1, D.I.S.						1.970.423	C10	
Eng. FP4									1.499.170

A10 CONDENSER	A20 CONTACT SET	A40 DISTRIBUTOR CAP	A50 ROTOR	A70 PICK-UP
C10 COIL	C20 IGNITION MODULE	C30 ELECTRONIC IGNITION KIT	E01 IGNITION CABLE SET	

Vehicle	alim.	kW	Date	Engine	FUNCTIONS ON THE VEHICLE							
					A10	A20	A40	A50	A70	C10 - C30	C20	E01
KA+												
1.2	Petrol	51	06/16->	B2KA								
Engine	Information				A10	A20	A40	A50	A70	C10 - C30	C20	E01
All engines	x 1, D.I.S.									1.970.481	C10	
All engines												1.499.242
1.2												
1.2	Petrol	63	06/16->	YSKD, YSKE								
Engine	Information				A10	A20	A40	A50	A70	C10 - C30	C20	E01
All engines	x 1, D.I.S.									1.970.481	C10	
All engines												1.499.242
1.2 Ti-VCT												
1.2 Ti-VCT	Petrol	63	06/16->	YSKD, YSKE								
Engine	Information				A10	A20	A40	A50	A70	C10 - C30	C20	E01
All engines	x 1, D.I.S.									1.970.481	C10	
All engines												1.499.242
KUGA I												
2.5	Petrol	147	02/08-11/12	HYDB, HYDC								
Engine	Information				A10	A20	A40	A50	A70	C10 - C30	C20	E01
All engines	x 5, COIL ON PLUG									1.970.478	C10	
All engines												
2.5 4x4												
2.5 4x4	Petrol	147	02/08-11/12	HYDB								
Engine	Information				A10	A20	A40	A50	A70	C10 - C30	C20	E01
All engines	x 5, COIL ON PLUG									1.970.478	C10	
All engines												
KUGA II												
1.5 16V	Petrol	0	03/13->	--								
Engine	Information				A10	A20	A40	A50	A70	C10 - C30	C20	E01
All engines	Qty: 4									1.970.623	C10	
All engines												
1.5 EcoBoost												
1.5 EcoBoost	Petrol	110	09/14->	M8MA, M8MB, M8MC, M8MD, M8ME								
Engine	Information				A10	A20	A40	A50	A70	C10 - C30	C20	E01
All engines	x 4, COIL ON PLUG									1.970.623	C10	
All engines												
1.5 EcoBoost												
1.5 EcoBoost	Petrol	88	01/16->	BNMA								
Engine	Information				A10	A20	A40	A50	A70	C10 - C30	C20	E01
All engines	x 4, COIL ON PLUG									1.970.623	C10	
All engines												
1.5 EcoBoost 4x4												
1.5 EcoBoost 4x4	Petrol	110	07/16->	OCEAA, M8MA, M8MB, M8MD								
Engine	Information				A10	A20	A40	A50	A70	C10 - C30	C20	E01
All engines	x 4, COIL ON PLUG									1.970.623	C10	
All engines												
1.5 EcoBoost 4x4												
1.5 EcoBoost 4x4	Petrol	129	08/18->	37F3P674K, M9ME								
Engine	Information				A10	A20	A40	A50	A70	C10 - C30	C20	E01
All engines	x 4, COIL ON PLUG									1.970.623	C10	
All engines												
1.5 EcoBoost 4x4												
1.5 EcoBoost 4x4	Petrol	134	09/14->	285ZV604, 65M4R730, M9MA, M9MC								
Engine	Information				A10	A20	A40	A50	A70	C10 - C30	C20	E01
All engines	x 4, COIL ON PLUG									1.970.623	C10	
All engines												
MAVERICK												
2.0 16V	Petrol	91	02/01->	YF								
Engine	Information				A10	A20	A40	A50	A70	C10 - C30	C20	E01
All engines	x 1, D.I.S.									1.970.532	C10	
All engines												1.501.624
2.0 16V FWD												
2.0 16V FWD	Petrol	91	02/01->	YF								
Engine	Information				A10	A20	A40	A50	A70	C10 - C30	C20	E01
All engines	x 1, D.I.S.									1.970.532	C10	
All engines												

A10 CONDENSER	A20 CONTACT SET	A40 DISTRIBUTOR CAP	A50 ROTOR	A70 PICK-UP
C10 COIL	C20 IGNITION MODULE	C30 ELECTRONIC IGNITION KIT	E01 IGNITION CABLE SET	

The present application list is a brief version. For the detailed information about the possibility of installation on a specific vehicle, please refer to our web-catalogue <http://catalogo.facet.eu/>

Vehicle	alim.	kW	Date	Engine	FUNCTIONS ON THE VEHICLE							
					A10	A20	A40	A50	A70	C10 - C30	C20	E01

ENGINE				
2.3 16V	Petrol	110	03/04->	GZ, ZH23HYU

Engine	Information	A10	A20	A40	A50	A70	C10 - C30	C20	E01
Eng. GZ	Qty: 4						1.970.480	C10	
Eng. ZH23HYU	x 4, COIL ON PLUG						1.970.480	C10	

ENGINE				
2.4 i	Petrol	85	09/96-04/98	KA24

Engine	Information	A10	A20	A40	A50	A70	C10 - C30	C20	E01
All engines	version Hitachi			1.322.089	1.422.102				
All engines									1.501.789

ENGINE				
2.4 i	Petrol	87	09/96-04/98	KA24

Engine	Information	A10	A20	A40	A50	A70	C10 - C30	C20	E01
All engines	version Hitachi			1.322.089	1.422.102				
All engines									1.501.789

ENGINE				
2.4 i	Petrol	91	02/93-08/96	KA24E

Engine	Information	A10	A20	A40	A50	A70	C10 - C30	C20	E01
All engines	version Hitachi			1.322.046	1.422.070				

MONDEO I

ENGINE				
1.6 i	Petrol	66	08/96-09/00	L1J

Engine	Information	A10	A20	A40	A50	A70	C10 - C30	C20	E01
All engines	x 1, D.I.S.						1.970.532	C10	
All engines	01/05/98 ->								1.501.624
All engines	->year 01/05/98								1.501.630

ENGINE				
1.6 i 16V	Petrol	65	07/94-08/96	L1J

Engine	Information	A10	A20	A40	A50	A70	C10 - C30	C20	E01
All engines							1.970.299, 1.970.312	C10	1.501.630

ENGINE				
1.6 i 16V	Petrol	66	02/93-08/96	L1F

Engine	Information	A10	A20	A40	A50	A70	C10 - C30	C20	E01
All engines							1.970.299, 1.970.312	C10	1.501.630

ENGINE				
1.6 i 16V	Petrol	70	05/98-09/00	L1L, L1N, L1Q

Engine	Information	A10	A20	A40	A50	A70	C10 - C30	C20	E01
All engines	x 1, D.I.S.						1.970.532	C10	
All engines	01/05/98 ->								1.501.624
All engines	->year 01/05/98								1.501.630

ENGINE				
1.8 4x4	Petrol	85	02/93-08/96	RKA

Engine	Information	A10	A20	A40	A50	A70	C10 - C30	C20	E01
All engines							1.970.299	C10	1.501.630

ENGINE				
1.8 i	Petrol	85	08/96-09/00	RKA, RKB, RKF, RKH, RKJ, RKK

Engine	Information	A10	A20	A40	A50	A70	C10 - C30	C20	E01
All engines	x 1, D.I.S.						1.970.532	C10	
Eng. RKB, RKF, RKH, RKJ, RKK	01/05/98 ->								1.501.624
Eng. RKB, RKF, RKH, RKJ, RKK	->year 01/05/98								1.501.630

ENGINE				
1.8 i 16V	Petrol	82	01/94-08/96	RKB

Engine	Information	A10	A20	A40	A50	A70	C10 - C30	C20	E01
All engines							1.970.299, 1.970.312	C10	1.501.630

ENGINE				
1.8 i 16V	Petrol	85	02/93-08/96	RKA









Engine	Information	A10	A20	A40	A50	A70	C10 - C30	C20	E01
All engines							1.970.299, 1.970.312	C10	1.501.630

A10 CONDENSER	A20 CONTACT SET	A40 DISTRIBUTOR CAP	A50 ROTOR	A70 PICK-UP
C10 COIL	C20 IGNITION MODULE	C30 ELECTRONIC IGNITION KIT	E01 IGNITION CABLE SET	

Vehicle	alim.	kW	Date	Engine	FUNCTIONS ON THE VEHICLE								
					A10	A20	A40	A50	A70	C10 - C30	C20	E01	
ENGINE													
1.8 i 16V 4x4	Petrol	85	02/93-08/96	RKA									
Engine	Information												
All engines									1,970.299, 1,970.312	C10			1.501.630
ENGINE													
2.0 i	Petrol	96	08/96-09/00	NGA, NGB, NGC, NGD									
Engine	Information												
All engines	x 1, D.I.S.								1,970.532	C10			
All engines	01/05/98 ->												1.501.624
All engines	->year 01/05/98												1.501.630
ENGINE													
2.0 i 16V	Petrol	100	02/93-08/96	NGA									
Engine	Information												
All engines									1,970.299, 1,970.312	C10			1.501.630
ENGINE													
2.0 i 16V	Petrol	97	01/93-08/96	NGA									
Engine	Information												
All engines									1,970.299	C10			1.501.630
ENGINE													
2.0 i 16V 4x4	Petrol	100	02/93-08/96	NGA									
Engine	Information												
All engines									1,970.299, 1,970.312	C10			1.501.630
ENGINE													
2.0 i 16V 4x4	Petrol	97	12/94-08/96	NGA									
Engine	Information												
All engines									1,970.299, 1,970.312	C10			1.501.630
ENGINE													
2.5 24V	Petrol	125	08/96-09/00	SEA, SEB, SEC									
Engine	Information												
All engines	x 1, D.I.S.								1,970.170	C10			
ENGINE													
2.5 i 24V	Petrol	125	07/94-08/96	SEA									
Engine	Information												
All engines									1,970.170	C10			
ENGINE													
2.5 ST 200	Petrol	151	05/99-09/00	SGA									
Engine	Information												
All engines	x 1, D.I.S.								1,970.170	C10			
MONDEO II													
ENGINE													
1.8 16V	Petrol	81	10/00-03/07	CGBA, CGBB									
Engine	Information												
All engines	01/03/05 ->, x 1, D.I.S.								1,970.481	C10			
All engines	->year 01/02/05, x 1, D.I.S.								1,970.532	C10			
ENGINE													
1.8 16V	Petrol	92	10/00-03/07	CHBA, CHBB									
Engine	Information												
All engines	01/03/05 ->, x 1, D.I.S.								1,970.481	C10			
All engines	->year 01/02/05, x 1, D.I.S.								1,970.532	C10			
ENGINE													
2.0 16V	Petrol	107	10/00-03/07	CJBA, CJBB									
Engine	Information												
All engines	01/03/05 ->, x 1, D.I.S.								1,970.481	C10			
All engines	->year 01/02/05, x 1, D.I.S.								1,970.532	C10			
ENGINE													
3.0 V6 24V	Petrol	150	09/04-03/07	REBA									
Engine	Information												
All engines													1.499.214

A10 CONDENSER	A20 CONTACT SET	A40 DISTRIBUTOR CAP	A50 ROTOR	A70 PICK-UP
C10 COIL	C20 IGNITION MODULE	C30 ELECTRONIC IGNITION KIT	E01 IGNITION CABLE SET	

The present application list is a brief version. For the detailed information about the possibility of installation on a specific vehicle, please refer to our web-catalogue <http://catalogo.facet.eu/>

				FUNCTIONS ON THE VEHICLE								
Vehicle	alim.	kW	Date	Engine								
				ENGINE								
ST220	Petrol	166	04/02-03/07	MEBA								
				ENGINE	A10	A20	A40	A50	A70	C10 - C30	C20	E01
All engines				Information								1.499.214
				MONDEO III								
1.6 Ti	Petrol	81	03/07-01/15	RHBA								
				ENGINE	A10	A20	A40	A50	A70	C10 - C30	C20	E01
All engines				Information						1.970.481	C10	
All engines				x 1, D.I.S.								1.499.242
All engines				19/03/07 ->								1.501.625
All engines				->year 19/03/07								
1.6 Ti	Petrol	88	03/10-01/15	KGBA								
				ENGINE	A10	A20	A40	A50	A70	C10 - C30	C20	E01
All engines				Information						1.970.481	C10	
All engines				x 1, D.I.S.								1.499.242
All engines				19/03/07 ->								1.501.625
All engines				->year 19/03/07								
1.6 Ti	Petrol	92	03/07-01/15	PNBA								
				ENGINE	A10	A20	A40	A50	A70	C10 - C30	C20	E01
All engines				Information						1.970.481	C10	
All engines				x 1, D.I.S.								1.499.242
All engines				19/03/07 ->								1.501.625
All engines				->year 19/03/07								
2.0	Petrol	107	03/07-01/15	AOBA, AOBC, TBBA, TBBB								
				ENGINE	A10	A20	A40	A50	A70	C10 - C30	C20	E01
All engines				Information						1.970.480	C10	
All engines				x 4, COIL ON PLUG								1.499.242
All engines				19/03/07 ->								1.501.625
All engines				->year 19/03/07								
2.0 Flexifuel	Petrol/ Ethanol	107	03/09-01/15	TBBA, TBBB								
				ENGINE	A10	A20	A40	A50	A70	C10 - C30	C20	E01
All engines				Information						1.970.480	C10	
All engines				x 4, COIL ON PLUG								1.499.242
All engines				19/03/07 ->								1.501.625
All engines				->year 19/03/07								
2.0 LPG	Petrol/ Liquified Petroleum Gas (LPG)	107	07/09-01/15	TBBA, TBBB								
				ENGINE	A10	A20	A40	A50	A70	C10 - C30	C20	E01
All engines				Information						1.970.480	C10	
All engines				x 4, COIL ON PLUG								1.499.242
All engines				19/03/07 ->								1.501.625
All engines				->year 19/03/07								
2.5	Petrol	162	03/07-01/15	HUBA								
				ENGINE	A10	A20	A40	A50	A70	C10 - C30	C20	E01
All engines				Information						1.970.478	C10	
All engines				x 5, COIL ON PLUG								1.499.242
All engines				19/03/07 ->								1.501.625
All engines				->year 19/03/07								
				MONDEO IV								
1.0 EcoBoost	Petrol	92	02/15->	M1CA, M1CB								
				ENGINE	A10	A20	A40	A50	A70	C10 - C30	C20	E01
All engines				Information						1.970.619	C10	
All engines				x 3, COIL ON PLUG								1.499.242
All engines				19/03/07 ->								1.501.625
All engines				->year 19/03/07								
1.5 EcoBoost	Petrol	118	09/14->	UNCA, UNCB, UNCE, UNCF								
				ENGINE	A10	A20	A40	A50	A70	C10 - C30	C20	E01
All engines				Information						1.970.623	C10	
All engines				x 4, COIL ON PLUG								1.499.242
All engines				19/03/07 ->								1.501.625
All engines				->year 19/03/07								
1.5 EcoBoost	Petrol	121	05/18->	UNCN								
				ENGINE	A10	A20	A40	A50	A70	C10 - C30	C20	E01
All engines				Information						1.970.623	C10	
All engines				x 4, COIL ON PLUG								1.499.242
All engines				19/03/07 ->								1.501.625
All engines				->year 19/03/07								
1.5 GTDI	Petrol	0	09/14->	--								
				ENGINE	A10	A20	A40	A50	A70	C10 - C30	C20	E01
All engines				Information						1.970.623	C10	
All engines				Qty: 4								1.499.242
All engines				19/03/07 ->								1.501.625
All engines				->year 19/03/07								

A10 CONDENSER	A20 CONTACT SET	A40 DISTRIBUTOR CAP	A50 ROTOR	A70 PICK-UP
C10 COIL	C20 IGNITION MODULE	C30 ELECTRONIC IGNITION KIT	E01 IGNITION CABLE SET	

Vehicle	alim.	kW	Date	Engine	FUNCTIONS ON THE VEHICLE							
					A10	A20	A40	A50	A70	C10 - C30	C20	E01
ENGINE												
2.0	Petrol	107	03/07-09/14	A0BC								
ORION I												
1.3	Petrol	51	07/83-07/88	JPA								
ENGINE												
1.3												
Engine	Information	A10	A20	A40	A50	A70	C10 - C30	C20	E01			
All engines	x 4, COIL ON PLUG						1.970.480	C10				
ENGINE												
1.4	Petrol	54	01/86-07/90	FUC								
ENGINE												
1.4												
Engine	Information	A10	A20	A40	A50	A70	C10 - C30	C20	E01			
All engines	version Bosch			1.306.079	1.406.060R, 1.406.061R							
All engines	version Lucas			1.328.083								
All engines							1.970.169	C10				
ENGINE												
1.4	Petrol	55	12/85-07/90	FUA								
ENGINE												
1.4												
Engine	Information	A10	A20	A40	A50	A70	C10 - C30	C20	E01			
All engines	version Bosch			1.306.079	1.406.061R							
All engines	version Lucas			1.328.096	1.428.026R							
All engines							1.970.169, 1.970.312	C10				
ENGINE												
1.4 Cat	Petrol	54	02/87-07/90	F6B, F6D								
ENGINE												
1.4 Cat												
Engine	Information	A10	A20	A40	A50	A70	C10 - C30	C20	E01			
All engines	version Bosch			1.306.079								
Eng. F6D	version Lucas			1.328.096	1.428.026R							
Eng. F6D	version Bosch				1.406.061R							
Eng. F6B	version Bosch				1.406.121R							
All engines							1.970.169	C10				
Eng. F6D									1.501.281			
ENGINE												
1.6	Petrol	58	07/83-03/86	LP1, LPA								
ENGINE												
1.6												
Engine	Information	A10	A20	A40	A50	A70	C10 - C30	C20	E01			
All engines	version Lucas			1.328.083								
All engines	version Bosch				1.406.060R							
All engines							1.970.169	C10				
ENGINE												
1.6i	Petrol	77	07/83-07/90	LR1, LRA, LRB								
ENGINE												
1.6i												
Engine	Information	A10	A20	A40	A50	A70	C10 - C30	C20	E01			
Eng. LRB	version Bosch			1.306.079								
Eng. LR1, LRA	version Bosch				1.406.112R							
Eng. LRB	+catalytic converter, version Bosch				1.406.121R							
All engines							1.970.169	C10				
Eng. LRB									1.501.281			
ORION II												
1.3	Petrol	44	07/90-12/93	J4B, J6A								
ENGINE												
1.3												
Engine	Information	A10	A20	A40	A50	A70	C10 - C30	C20	E01			
All engines							1.970.312, 1.970.364	C10	1.501.007			
ENGINE												
1.4	Petrol	52	07/90-12/93	F6F, F6G								
ENGINE												
1.4												
Engine	Information	A10	A20	A40	A50	A70	C10 - C30	C20	E01			
All engines							1.970.135, 1.970.312	C10	1.500.864			
ENGINE												
1.4	Petrol	54	07/90-12/93	FUH								
ENGINE												
1.4												
Engine	Information	A10	A20	A40	A50	A70	C10 - C30	C20	E01			
All engines							1.970.312	C10				

A10	CONDENSER	A20	CONTACT SET	A40	DISTRIBUTOR CAP	A50	ROTOR	A70	PICK-UP
C10	COIL	C20	IGNITION MODULE	C30	ELECTRONIC IGNITION KIT	E01	IGNITION CABLE SET		

The present application list is a brief version. For the detailed information about the possibility of installation on a specific vehicle, please refer to our web-catalogue <http://catalogo.facet.eu/>

Vehicle	alim.	kW	Date	Engine	FUNCTIONS ON THE VEHICLE							
					A10	A20	A40	A50	A70	C10 - C30	C20	E01

ENGINE				
1.6	Petrol	66	07/90-12/92	LUJ, LUK

Engine	Information	A10	A20	A40	A50	A70	C10 - C30	C20	E01
All engines							1.970.135, 1.970.312	C10	1.500.864

ENGINE				
1.6 i	Petrol	77	07/90-09/92	HL16EFI-LJE, LJF

Engine	Information	A10	A20	A40	A50	A70	C10 - C30	C20	E01
All engines							1.970.135	C10	1.500.864
Eng. LJF							1.970.312	C10	

ENGINE				
1.6 i 16V	Petrol	66	07/92-12/93	L1E, L1K

Engine	Information	A10	A20	A40	A50	A70	C10 - C30	C20	E01
All engines							1.970.299, 1.970.312	C10	1.501.630

ENGINE				
1.8 i 16V	Petrol	77	02/92-12/93	RDA

Engine	Information	A10	A20	A40	A50	A70	C10 - C30	C20	E01
All engines							1.970.299, 1.970.312	C10	1.501.630

ENGINE				
1.8 i 16V	Petrol	96	01/92-12/93	99BFR1740

Engine	Information	A10	A20	A40	A50	A70	C10 - C30	C20	E01
All engines							1.970.299, 1.970.312	C10	1.501.630

P 100

ENGINE				
1.6	Petrol	54	04/82-09/87	LCR

Engine	Information	A10	A20	A40	A50	A70	C10 - C30	C20	E01
All engines									1.501.078

ENGINE				
2.0	Petrol	57	10/87-12/92	NAE

Engine	Information	A10	A20	A40	A50	A70	C10 - C30	C20	E01
All engines	version Bosch			1.306.109	1.406.025R				
All engines									1.501.078

PROBE

ENGINE				
2.0 16V	Petrol	85	01/93-09/97	A20LE-FS

Engine	Information	A10	A20	A40	A50	A70	C10 - C30	C20	E01
All engines	01/12/94 ->, version Mitsubishi				1.431.132				
All engines	->year 30/11/94, version Mitsubishi				1.431.137				

PUMA

ENGINE				
1.4 16V	Petrol	66	11/97-10/00	FHD, FHF

Engine	Information	A10	A20	A40	A50	A70	C10 - C30	C20	E01
All engines	->year 01/05/98, x 1, D.I.S.						1.970.299S	C10	
All engines	01/06/98 ->, x 1, D.I.S.						1.970.532	C10	
All engines	->year 15/05/98								1.501.619
All engines	15/05/98 ->								1.501.625

ENGINE				
1.6 16V	Petrol	76	08/00-06/02	L1W

Engine	Information	A10	A20	A40	A50	A70	C10 - C30	C20	E01
All engines	x 1, D.I.S.						1.970.532	C10	
All engines									1.501.625

ENGINE				
1.7 16V	Petrol	92	03/97-06/02	MHA, MHB

Engine	Information	A10	A20	A40	A50	A70	C10 - C30	C20	E01
All engines	->year 01/04/00, x 1, D.I.S.						1.970.299S	C10	
All engines	01/05/00 ->, x 1, D.I.S.						1.970.532	C10	
All engines	->year 15/05/98								1.501.619
All engines	15/05/98 ->								1.501.625

A10 CONDENSER	A20 CONTACT SET	A40 DISTRIBUTOR CAP	A50 ROTOR	A70 PICK-UP
C10 COIL	C20 IGNITION MODULE	C30 ELECTRONIC IGNITION KIT	E01 IGNITION CABLE SET	

Vehicle	alim.	kW	Date	Engine	FUNCTIONS ON THE VEHICLE							
					A10	A20	A40	A50	A70	C10 - C30	C20	E01
Racing ST 160												
ENGINE												
MHA												
Petrol 114 06/99-06/02												
Engine		Information			A10	A20	A40	A50	A70	C10 - C30	C20	E01
All engines		-> year 01/04/00, x 1, D.I.S.								1.970.2995	C10	
All engines		01/05/00 ->, x 1, D.I.S.								1.970.532	C10	
RANGER IV												
ENGINE												
2.2												
Petrol 78 03/02-09/05												
Engine		Information			A10	A20	A40	A50	A70	C10 - C30	C20	E01
Eng. --		version Mitsubishi					1.331.121					
Eng. F2D6		x 1, DISTRIBUTOR								1.970.3665	C10	
2.2 EFI												
ENGINE												
Petrol 0 03/99->												
Engine		Information			A10	A20	A40	A50	A70	C10 - C30	C20	E01
All engines		version Mitsubishi					1.331.121					
2.6												
Petrol 80 10/02-09/04												
Engine		Information			A10	A20	A40	A50	A70	C10 - C30	C20	E01
All engines		version Mitsubishi					1.331.121					
All engines		without fastening clamp								1.970.3665	C10	
4.0												
Petrol 152 10/05-06/06												
Engine		Information			A10	A20	A40	A50	A70	C10 - C30	C20	E01
All engines										1.970.289	C10	
4.0 4x4												
Petrol 152 10/05-06/06												
Engine		Information			A10	A20	A40	A50	A70	C10 - C30	C20	E01
All engines										1.970.289	C10	
SCORPIO I												
ENGINE												
1.8												
Petrol 66 04/85-02/92												
Engine		Information			A10	A20	A40	A50	A70	C10 - C30	C20	E01
All engines		version Bosch					1.306.079	1.406.121R				
All engines										1.970.169	C10	1.501.078
2.0 i												
ENGINE												
Petrol 85 04/85-09/94												
N9F, NRA, NRI												
Engine		Information			A10	A20	A40	A50	A70	C10 - C30	C20	E01
Eng. NRA, NRI		no specific info conc. application available, version Bosch					1.306.079	1.406.121R				
All engines		no specific info conc. application available, version Bosch					1.306.253	1.406.140R				
Eng. NRA, NRI		version Ford					1.319.092					
All engines										1.970.169	C10	
Eng. NRA, NRI		no specific info conc. application available										1.501.078
2.0 i												
ENGINE												
Petrol 88 05/89-09/94												
N9D												
Engine		Information			A10	A20	A40	A50	A70	C10 - C30	C20	E01
All engines		no specific info conc. application available, version Bosch					1.306.253	1.406.140R				
All engines										1.970.169	C10	
2.0 i												
ENGINE												
Petrol 90 11/92-09/94												
N9B												
Engine		Information			A10	A20	A40	A50	A70	C10 - C30	C20	E01
All engines		no specific info conc. application available, version Bosch					1.306.253	1.406.140R				
All engines										1.970.169	C10	
2.4 i												
ENGINE												
Petrol 96 09/86-09/88												
ARC												
Engine		Information			A10	A20	A40	A50	A70	C10 - C30	C20	E01
All engines		version Ford						1.419.092				
All engines										1.970.169	C10	
2.9 24V												
ENGINE												
Petrol 143 08/93-09/94												
BOA												
Engine		Information			A10	A20	A40	A50	A70	C10 - C30	C20	E01
All engines										1.970.170	C10	

A10 CONDENSER	A20 CONTACT SET	A40 DISTRIBUTOR CAP	A50 ROTOR	A70 PICK-UP
C10 COIL	C20 IGNITION MODULE	C30 ELECTRONIC IGNITION KIT	E01 IGNITION CABLE SET	

The present application list is a brief version. For the detailed information about the possibility of installation on a specific vehicle, please refer to our web-catalogue <http://catalogo.facet.eu/>

Vehicle	alim.	kW	Date	Engine	FUNCTIONS ON THE VEHICLE								
					A10	A20	A40	A50	A70	C10 - C30	C20	E01	
ENGINE													
2.9 i	Petrol	107	09/86-12/94	BRD, BRE, BRF									
Engine	Information				A10	A20	A40	A50	A70	C10 - C30	C20	E01	
All engines	version Ford							1.419.092					
All engines										1.970.169	C10		
ENGINE													
2.9 i	Petrol	110	09/86-09/94	BRC									
Engine	Information				A10	A20	A40	A50	A70	C10 - C30	C20	E01	
All engines	version Ford							1.419.092					
All engines										1.970.169	C10		
ENGINE													
2.9 i 24V	Petrol	143	04/91-09/94	BOA									
Engine	Information				A10	A20	A40	A50	A70	C10 - C30	C20	E01	
All engines										1.970.170	C10		
ENGINE													
2.9 i 4x4	Petrol	107	05/88-10/94	BRD, BRE, BRF									
Engine	Information				A10	A20	A40	A50	A70	C10 - C30	C20	E01	
All engines	version Ford							1.419.092					
All engines										1.970.169	C10		
ENGINE													
2.9 i 4x4	Petrol	110	09/86-09/94	BRC									
Engine	Information				A10	A20	A40	A50	A70	C10 - C30	C20	E01	
All engines	version Ford							1.419.092					
All engines										1.970.169	C10		
ENGINE													
2.9 i Cat	Petrol	107	10/87-09/94	BRE									
Engine	Information				A10	A20	A40	A50	A70	C10 - C30	C20	E01	
All engines	version Ford							1.419.092					
All engines										1.970.169	C10		
SCORPIO II													
ENGINE													
2.0 i 16V	Petrol	100	10/94-08/98	N3A									
Engine	Information				A10	A20	A40	A50	A70	C10 - C30	C20	E01	
All engines												1.501.145	
ENGINE													
2.3 i 16V	Petrol	108	06/96-08/98	Y5A									
Engine	Information				A10	A20	A40	A50	A70	C10 - C30	C20	E01	
All engines												1.501.145	
ENGINE													
2.9 i	Petrol	110	02/95-08/98	BRG									
Engine	Information				A10	A20	A40	A50	A70	C10 - C30	C20	E01	
All engines	version Ford							1.419.092					
All engines	x 1, Colour:Red, DISTRIBUTOR, 12 Volt, Dia: 55 mm, connector type DIN									1.970.169	C10		
ENGINE													
2.9 i 24V	Petrol	152	10/94-08/98	BOB									
Engine	Information				A10	A20	A40	A50	A70	C10 - C30	C20	E01	
All engines	x 1, D.I.S.									1.970.170	C10		
SIERRA I													
ENGINE													
1.3	Petrol	44	08/82-12/86	JCT									
Engine	Information				A10	A20	A40	A50	A70	C10 - C30	C20	E01	
All engines	version Bosch						1.306.109	1.406.025R					
All engines										1.970.169	C10		1.501.078
ENGINE													
1.8	Petrol	66	10/84-12/86	REB									
Engine	Information				A10	A20	A40	A50	A70	C10 - C30	C20	E01	
All engines	version Bosch						1.306.235	1.406.121R					
All engines										1.970.169	C10		

A10	CONDENSER	A20	CONTACT SET	A40	DISTRIBUTOR CAP	A50	ROTOR	A70	PICK-UP
C10	COIL	C20	IGNITION MODULE	C30	ELECTRONIC IGNITION KIT	E01	IGNITION CABLE SET		

Vehicle	alim.	kW	Date	Engine	FUNCTIONS ON THE VEHICLE							
					A10	A20	A40	A50	A70	C10 - C30	C20	E01
ENGINE												
2.0	Petrol	66	08/82-10/84	NYT								
Engine	Information			A10	A20	A40	A50	A70	C10 - C30	C20	E01	
All engines	01/10/85 ->, version Bosch					1.306.079						
All engines	->year 01/10/84, version Bosch					1.306.109						
All engines	01/10/84 ->, ->year 01/10/85, version Bosch					1.306.235						
All engines	version Bosch						1.406.025R					
ENGINE												
2.0	Petrol	74	10/85-12/86	NRD								
Engine	Information			A10	A20	A40	A50	A70	C10 - C30	C20	E01	
All engines	version Bosch					1.306.079	1.406.121R					
ENGINE												
2.0	Petrol	77	08/82-12/86	NET								
Engine	Information			A10	A20	A40	A50	A70	C10 - C30	C20	E01	
All engines	01/10/85 ->, version Bosch					1.306.079						
All engines	->year 01/10/84, version Bosch					1.306.109	1.406.025R					
All engines	01/10/84 ->, ->year 01/10/85, version Bosch					1.306.235						
All engines	01/10/84 ->, version Bosch						1.406.121R					
All engines								1.970.169	C10			
ENGINE												
2.0	Petrol	85	03/85-12/86	NR2								
Engine	Information			A10	A20	A40	A50	A70	C10 - C30	C20	E01	
All engines	version Bosch					1.306.079	1.406.121R					
All engines	version Ford					1.319.092						
ENGINE												
2.0 i	Petrol	85	03/85-12/86	NR2								
Engine	Information			A10	A20	A40	A50	A70	C10 - C30	C20	E01	
All engines	version Bosch					1.306.079	1.406.121R					
All engines	version Ford					1.319.092						
All engines								1.970.169	C10			
SIERRA II												
ENGINE												
1.6 i	Petrol	59	10/89-02/93	L6B								
Engine	Information			A10	A20	A40	A50	A70	C10 - C30	C20	E01	
All engines									1.970.135, 1.970.312	C10		
ENGINE												
1.8	Petrol	64	05/88-02/93	R2C, R6A								
Engine	Information			A10	A20	A40	A50	A70	C10 - C30	C20	E01	
All engines	version Ford						1.419.094R					
All engines								1.970.169, 1.970.312	C10			
ENGINE												
1.8 i	Petrol	0	01/92-12/93	HL18CFI-R6A								
Engine	Information			A10	A20	A40	A50	A70	C10 - C30	C20	E01	
All engines									1.970.135	C10		
ENGINE												
2.0	Petrol	77	01/87-02/93	N8C, NES								
Engine	Information			A10	A20	A40	A50	A70	C10 - C30	C20	E01	
All engines	version Bosch					1.306.079	1.406.121R					
All engines								1.970.169	C10			
ENGINE												
2.0 i	Petrol	85	01/87-02/93	N4A, N4I								
Engine	Information			A10	A20	A40	A50	A70	C10 - C30	C20	E01	
All engines	version Bosch					1.306.253	1.406.140R					
All engines								1.970.169	C10			
ENGINE												
2.0 i	Petrol	92	06/89-02/93	N9B								
Engine	Information			A10	A20	A40	A50	A70	C10 - C30	C20	E01	
All engines	version Bosch					1.306.253	1.406.140R					
All engines								1.970.169	C10			

A10	CONDENSER	A20	CONTACT SET	A40	DISTRIBUTOR CAP	A50	ROTOR	A70	PICK-UP
C10	COIL	C20	IGNITION MODULE	C30	ELECTRONIC IGNITION KIT	E01	IGNITION CABLE SET		

The present application list is a brief version. For the detailed information about the possibility of installation on a specific vehicle, please refer to our web-catalogue <http://catalogo.facet.eu/>

Vehicle	alim.	kW	Date	Engine	FUNCTIONS ON THE VEHICLE							
					A10	A20	A40	A50	A70	C10 - C30	C20	E01

S-MAX I

2.0	Petrol	107	05/06-12/14	ENGINE AODA, AODB, AODE, AOWA, AOWB
-----	--------	-----	-------------	---

Engine	Information	A10	A20	A40	A50	A70	C10 - C30	C20	E01
All engines	x 4, COIL ON PLUG						1.970.480	C10	

2.0 Flexifuel	Petrol/ Ethanol	107	05/06-12/14	ENGINE TBWA, TBWB
---------------	--------------------	-----	-------------	----------------------

Engine	Information	A10	A20	A40	A50	A70	C10 - C30	C20	E01
All engines	x 4, COIL ON PLUG						1.970.480	C10	

2.5 ST	Petrol	162	05/06-12/14	ENGINE HUWA
--------	--------	-----	-------------	----------------

Engine	Information	A10	A20	A40	A50	A70	C10 - C30	C20	E01
All engines	x 5, COIL ON PLUG						1.970.478	C10	

S-MAX II

1.5 EcoBoost	Petrol	118	01/15-06/18	ENGINE UNCI, UNCJ, UNCK
--------------	--------	-----	-------------	----------------------------

Engine	Information	A10	A20	A40	A50	A70	C10 - C30	C20	E01
All engines	x 4, COIL ON PLUG						1.970.623	C10	

1.5 EcoBoost	Petrol	121	07/18->	ENGINE 6CF4G15, C15HDTX
--------------	--------	-----	---------	----------------------------

Engine	Information	A10	A20	A40	A50	A70	C10 - C30	C20	E01
All engines	x 4, COIL ON PLUG						1.970.623	C10	

STREET KA

1.6	Petrol	70	05/03-07/05	ENGINE CDRA, CDRB
-----	--------	----	-------------	----------------------

Engine	Information	A10	A20	A40	A50	A70	C10 - C30	C20	E01
All engines	x 1, D.I.S.						1.970.532	C10	
All engines									1.499.208

TAUNUS

1.6	Petrol	54	07/79-07/82	ENGINE LCJ
-----	--------	----	-------------	---------------

Engine	Information	A10	A20	A40	A50	A70	C10 - C30	C20	E01
All engines	version Ford		1.219.044HV	1.319.083	1.419.085				

TAUNUS 12M

1.2	Petrol	28	12/51-02/63	ENGINE --
-----	--------	----	-------------	--------------

Engine	Information	A10	A20	A40	A50	A70	C10 - C30	C20	E01
All engines			1.206.021						

1.2	Petrol	29	07/62-04/67	ENGINE --
-----	--------	----	-------------	--------------

Engine	Information	A10	A20	A40	A50	A70	C10 - C30	C20	E01
All engines			1.206.021						

1.2	Petrol	31	09/58-08/62	ENGINE --
-----	--------	----	-------------	--------------

Engine	Information	A10	A20	A40	A50	A70	C10 - C30	C20	E01
All engines			1.206.021						

1.5	Petrol	37	07/62-04/67	ENGINE --
-----	--------	----	-------------	--------------

Engine	Information	A10	A20	A40	A50	A70	C10 - C30	C20	E01
All engines			1.206.021						

1.5	Petrol	40	09/58-02/63	ENGINE --
-----	--------	----	-------------	--------------

Engine	Information	A10	A20	A40	A50	A70	C10 - C30	C20	E01
All engines			1.206.021						

1.5 TS	Petrol	37	12/62-04/67	ENGINE --
--------	--------	----	-------------	--------------

Engine	Information	A10	A20	A40	A50	A70	C10 - C30	C20	E01
All engines			1.206.021						

A10 CONDENSER	A20 CONTACT SET	A40 DISTRIBUTOR CAP	A50 ROTOR	A70 PICK-UP
C10 COIL	C20 IGNITION MODULE	C30 ELECTRONIC IGNITION KIT	E01 IGNITION CABLE SET	

Vehicle	alim.	kW	Date	Engine	FUNCTIONS ON THE VEHICLE									
					A10	A20	A40	A50	A70	C10 - C30	C20	E01		
ENGINE														
1.5 TS	Petrol	48	12/62-04/67	--										
Engine	Information				A10	A20	A40	A50	A70	C10 - C30	C20	E01		
All engines						1.206.021								
TAUNUS 15M														
1.5	Petrol	40	12/54-07/71	--, TV 15 H										
Engine	Information				A10	A20	A40	A50	A70	C10 - C30	C20	E01		
All engines						1.206.021								
ENGINE														
1.5	Petrol	44	09/54-08/58	--										
Engine	Information				A10	A20	A40	A50	A70	C10 - C30	C20	E01		
All engines						1.206.021								
ENGINE														
1.5 XL/RS	Petrol	40	01/68-06/71	--, TV 15 H										
Engine	Information				A10	A20	A40	A50	A70	C10 - C30	C20	E01		
All engines						1.206.021								
TAUNUS 17M														
1.5	Petrol	40	09/60-01/65	--										
Engine	Information				A10	A20	A40	A50	A70	C10 - C30	C20	E01		
All engines						1.206.021								
ENGINE														
1.5	Petrol	44	09/64-10/68	--										
Engine	Information				A10	A20	A40	A50	A70	C10 - C30	C20	E01		
All engines						1.206.021	1.306.062							
ENGINE														
1.7	Petrol	44	08/57-11/60	--										
Engine	Information				A10	A20	A40	A50	A70	C10 - C30	C20	E01		
All engines						1.206.021		1.406.018R						
ENGINE														
1.7	Petrol	48	09/64-04/74	--										
Engine	Information				A10	A20	A40	A50	A70	C10 - C30	C20	E01		
All engines						1.206.021								
ENGINE														
1.7	Petrol	55	12/67-04/74	--										
Engine	Information				A10	A20	A40	A50	A70	C10 - C30	C20	E01		
All engines						1.206.021								
ENGINE														
1.7 S	Petrol	48	09/60-01/65	--										
Engine	Information				A10	A20	A40	A50	A70	C10 - C30	C20	E01		
All engines						1.206.021								
ENGINE														
1.7 S	Petrol	55	11/61-01/65	--										
Engine	Information				A10	A20	A40	A50	A70	C10 - C30	C20	E01		
All engines						1.206.021								
TOURNEO														
1.8 BiFuel	CNG	85	08/05-12/06	EYPDCNG										
Engine	Information				A10	A20	A40	A50	A70	C10 - C30	C20	E01		
All engines	x 1, D.I.S.									1.970.532	C10			
ENGINE														
1.8 LPG	LPG	85	08/05-12/06	EYPC										
Engine	Information				A10	A20	A40	A50	A70	C10 - C30	C20	E01		
All engines	x 1, D.I.S.									1.970.532	C10			
TOURNEO CONNECT I														
1.8 16V	Petrol	85	06/02-12/13	EYPA, EYPC, EYPD										
Engine	Information				A10	A20	A40	A50	A70	C10 - C30	C20	E01		
All engines	x 1, D.I.S.									1.970.532	C10			
All engines													1.501.624	

A10 CONDENSER	A20 CONTACT SET	A40 DISTRIBUTOR CAP	A50 ROTOR	A70 PICK-UP
C10 COIL	C20 IGNITION MODULE	C30 ELECTRONIC IGNITION KIT	E01 IGNITION CABLE SET	

The present application list is a brief version. For the detailed information about the possibility of installation on a specific vehicle, please refer to our web-catalogue <http://catalogo.facet.eu/>

					FUNCTIONS ON THE VEHICLE							
Vehicle	alim.	kW	Date	Engine								

TOURNEO COURIER

				ENGINE
1.0 EcoBoost	Petrol	74	02/14->	SFCA, SFCB, SFCC, SFCD, SFCE, SFCF

Engine	Information	A10	A20	A40	A50	A70	C10 - C30	C20	E01
All engines	x 3, COIL ON PLUG						1.970.619	C10	

TOURNEO CUSTOM

				ENGINE
1.0 EcoBoost PHEV	Petrol/ Electric	92	04/20->	M1FA

Engine	Information	A10	A20	A40	A50	A70	C10 - C30	C20	E01
All engines	x 3, COIL ON PLUG						1.970.619	C10	

TRANSIT

				ENGINE
1.8 CNG	CNG	85	05/02-12/13	EYPDCNG

Engine	Information	A10	A20	A40	A50	A70	C10 - C30	C20	E01
All engines	Transit Connect, x 1, D.I.S.						1.970.532	C10	

				ENGINE
2.0	CNG	84	06/94-03/00	NSHCNG

Engine	Information	A10	A20	A40	A50	A70	C10 - C30	C20	E01
All engines	Transit 100, Transit 150, -> year 01/08/94, x 1, Colour: Red, DISTRIBUTOR, 12 Volt, Dia: 55 mm, connector type DIN						1.970.169	C10	

TRANSIT CONNECT I

				ENGINE
1.8 16V	Petrol	85	06/02-12/13	EYPA, EYPC, EYPD

Engine	Information	A10	A20	A40	A50	A70	C10 - C30	C20	E01
All engines	Transit Connect, x 1, D.I.S.						1.970.532	C10	
All engines									1.501.624

				ENGINE
1.8 16V LPG	Petrol/ Liquified Petro- leum Gas (LPG)	85	06/02-12/13	EYPA, EYPC, EYPD

Engine	Information	A10	A20	A40	A50	A70	C10 - C30	C20	E01
All engines	Transit Connect, x 1, D.I.S.						1.970.532	C10	
Eng. EYPC									1.501.624

TRANSIT CONNECT II

				ENGINE
1.0 EcoBoost	Petrol	74	02/13->	M2GA, M2GB

Engine	Information	A10	A20	A40	A50	A70	C10 - C30	C20	E01
All engines	Transit Connect, x 3, COIL ON PLUG						1.970.619	C10	

TRANSIT COURIER

				ENGINE
1.0 EcoBoost	Petrol	74	02/14->	SFCA, SFCB, SFCC, SFCD, SFCE, SFCF

Engine	Information	A10	A20	A40	A50	A70	C10 - C30	C20	E01
All engines	x 3, COIL ON PLUG						1.970.619	C10	

TRANSIT CUSTOM

				ENGINE
1.0 EcoBoost PHEV	Petrol/ Electric	92	04/20->	M1FA

Engine	Information	A10	A20	A40	A50	A70	C10 - C30	C20	E01
All engines	Transit Custom 320, Transit Custom 340, x 3, COIL ON PLUG						1.970.619	C10	

TRANSIT I

				ENGINE
1.5	Petrol	40	06/58-08/65	--

Engine	Information	A10	A20	A40	A50	A70	C10 - C30	C20	E01
All engines			1.206.021						

				ENGINE
1.6	Petrol	48	11/77-10/86	4RB

Engine	Information	A10	A20	A40	A50	A70	C10 - C30	C20	E01
All engines	version Ford		1.219.044HV	1.319.083	1.419.085				
All engines	version Bosch, alternatively			1.306.079, 1.306.109					

A10 CONDENSER	A20 CONTACT SET	A40 DISTRIBUTOR CAP	A50 ROTOR	A70 PICK-UP
C10 COIL	C20 IGNITION MODULE	C30 ELECTRONIC IGNITION KIT	E01 IGNITION CABLE SET	

Vehicle	alim.	kW	Date	Engine	FUNCTIONS ON THE VEHICLE									
					A10	A20	A40	A50	A70	C10 - C30	C20	E01		
ENGINE														
1.6	Petrol	48	11/77-10/86	4RB										
ENGINE														
Engine		Information			A10	A20	A40	A50	A70	C10 - C30	C20	E01		
All engines		version Bosch						1.406.012R						
1250 S-2 Klein-LKW	Petrol	40	10/57-07/67	--										
ENGINE														
Engine		Information			A10	A20	A40	A50	A70	C10 - C30	C20	E01		
All engines						1.206.021								
2.0	Petrol	43	11/77-07/82	4RC										
ENGINE														
Engine		Information			A10	A20	A40	A50	A70	C10 - C30	C20	E01		
All engines		version Ford				1.219.044HV	1.319.083	1.419.085						
All engines		version Bosch					1.306.079	1.406.012R						
K-40 1.5	Petrol	40	04/55-04/67	--										
ENGINE														
Engine		Information			A10	A20	A40	A50	A70	C10 - C30	C20	E01		
All engines						1.206.021								
TRANSIT II														
1.6	Petrol	46	09/85-09/92	LAC, LAT										
ENGINE														
Engine		Information			A10	A20	A40	A50	A70	C10 - C30	C20	E01		
All engines		version Bosch				1.206.049HVS		1.406.025R						
All engines		version Bosch, alternatively					1.306.079, 1.306.109							
All engines										1.970.169	C10		1.501.078	
2.0	Petrol	56	10/85-03/91	NAW										
ENGINE														
Engine		Information			A10	A20	A40	A50	A70	C10 - C30	C20	E01		
All engines		version Bosch				1.206.049HVS		1.406.025R						
All engines		version Bosch, alternatively					1.306.079, 1.306.109							
All engines										1.970.169	C10			
All engines		->year 31/08/91											1.501.078	
2.0	Petrol	57	09/85-09/92	NAT, NAV										
ENGINE														
Engine		Information			A10	A20	A40	A50	A70	C10 - C30	C20	E01		
All engines		version Bosch				1.206.049HVS		1.406.025R						
All engines		version Bosch, alternatively					1.306.079, 1.306.109							
All engines										1.970.169	C10			
All engines		->year 31/08/91											1.501.078	
2.0	Petrol	60	10/85-03/91	N6TS										
ENGINE														
Engine		Information			A10	A20	A40	A50	A70	C10 - C30	C20	E01		
All engines		version Bosch					1.306.079	1.406.121R						
All engines										1.970.169	C10			
All engines		->year 31/08/91											1.501.078	
2.0	Petrol	66	09/91-09/94	NBA										
ENGINE														
Engine		Information			A10	A20	A40	A50	A70	C10 - C30	C20	E01		
All engines		version Bosch, alternatively					1.306.079, 1.306.109							
All engines		version Bosch						1.406.025R						
All engines										1.970.169	C10			
2.0	Petrol	72	09/91-08/94	NCA										
ENGINE														
Engine		Information			A10	A20	A40	A50	A70	C10 - C30	C20	E01		
All engines		version Bosch, alternatively					1.306.079, 1.306.109							
All engines		version Bosch						1.406.025R						
All engines										1.970.169	C10			

A10	CONDENSER	A20	CONTACT SET	A40	DISTRIBUTOR CAP	A50	ROTOR	A70	PICK-UP
C10	COIL	C20	IGNITION MODULE	C30	ELECTRONIC IGNITION KIT	E01	IGNITION CABLE SET		

The present application list is a brief version. For the detailed information about the possibility of installation on a specific vehicle, please refer to our web-catalogue <http://catalogo.facet.eu/>

					FUNCTIONS ON THE VEHICLE							
Vehicle	alim.	kW	Date	Engine								

ENGINE				
2.0	Petrol	84	06/94-03/00	NSF, NSG, NSH

Engine	Information	A10	A20	A40	A50	A70	C10 - C30	C20	E01
Eng. NSF, NSG	version Bosch			1.306.253	1.406.140R				
All engines	Transit 100, Transit 80, -> year 01/08/94, x 1, Colour:Red, DISTRIBUTOR, 12 Volt, Dia: 55 mm, connector type DIN						1.970.169	C10	

ENGINE				
2.0 Cat	Petrol	57	11/85-09/92	N6T

Engine	Information	A10	A20	A40	A50	A70	C10 - C30	C20	E01
All engines	version Bosch			1.306.079	1.406.121R				
All engines							1.970.169	C10	
All engines	-> year 31/08/91								1.501.078

ENGINE				
2.0 CNG	Petrol/ Com- pressed Natural Gas (CNG)	84	06/94-03/00	NSH

Engine	Information	A10	A20	A40	A50	A70	C10 - C30	C20	E01
All engines	version Bosch			1.306.253	1.406.140R				

ENGINE				
2.0 i	Petrol	72	09/91-07/94	NCA

Engine	Information	A10	A20	A40	A50	A70	C10 - C30	C20	E01
All engines	version Bosch, alternatively			1.306.079, 1.306.109					
All engines	version Bosch				1.406.025R				
All engines							1.970.169	C10	

ENGINE				
2.0 L	Petrol	56	10/85-03/91	NAW, NAX

Engine	Information	A10	A20	A40	A50	A70	C10 - C30	C20	E01
All engines	version Bosch		1.206.049HVS		1.406.025R				
All engines	version Bosch, alternatively			1.306.079, 1.306.109					
All engines							1.970.169	C10	1.501.078

ENGINE				
2.9 i	Petrol	107	01/91-09/94	BRT

Engine	Information	A10	A20	A40	A50	A70	C10 - C30	C20	E01
All engines	version Bosch			1.306.081					
All engines							1.970.169	C10	

TRANSIT III

ENGINE				
2.3	Petrol	105	03/01-03/06	ESFC

Engine	Information	A10	A20	A40	A50	A70	C10 - C30	C20	E01
All engines	version Bosch								1.501.145

ENGINE				
2.3	Petrol	107	08/00-03/06	ESFA

Engine	Information	A10	A20	A40	A50	A70	C10 - C30	C20	E01
All engines	version Bosch								1.501.145

ENGINE				
2.3 16V	Petrol	107	04/01-05/06	ESFA, ESFC

Engine	Information	A10	A20	A40	A50	A70	C10 - C30	C20	E01
All engines	version Bosch								1.501.145

ENGINE				
2.3 16V CNG RWD	Petrol/ Com- pressed Natural Gas (CNG)	100	04/06-08/14	GZFC

Engine	Information	A10	A20	A40	A50	A70	C10 - C30	C20	E01
All engines	Transit 300, x 4, COIL ON PLUG						1.970.480	C10	

A10 CONDENSER	A20 CONTACT SET	A40 DISTRIBUTOR CAP	A50 ROTOR	A70 PICK-UP
C10 COIL	C20 IGNITION MODULE	C30 ELECTRONIC IGNITION KIT	E01 IGNITION CABLE SET	

Vehicle	alim.	kW	Date	Engine	FUNCTIONS ON THE VEHICLE									
					A10	A20	A40	A50	A70	C10 - C30	C20	E01		
ENGINE														
2.3 16V LPG RWD	Petrol/ Liquified Petro- leum Gas (LPG)	107	04/06-08/14	GZFC										
Engine		Information			A10	A20	A40	A50	A70	C10 - C30	C20	E01		
All engines		Transit 300, x 4, COIL ON PLUG								1.970.480	C10			
ENGINE														
2.3 16V RWD	Petrol	107	08/00-08/14	ESFA, ESFC, GZFA, GZFB, GZFC										
Engine		Information			A10	A20	A40	A50	A70	C10 - C30	C20	E01		
Eng. GZFA, GZFB, GZFC		Transit 300, x 4, COIL ON PLUG								1.970.480	C10			
Eng. ESFA, ESFC		version Bosch											1.501.145	
TRANSIT TOURNEO														
ENGINE														
2.0	Petrol	84	11/94-12/00	NSF, NSG, NSH										
Engine		Information			A10	A20	A40	A50	A70	C10 - C30	C20	E01		
Eng. NSH		version Bosch					1.306.253	1.406.140R						
All engines		->year 01/08/94, x 1, Colour:Red, DISTRIBUTOR, 12 Volt, Dia: 55 mm, connector type DIN								1.970.169	C10			
WINDSTAR														
ENGINE														
3.0i 12V	Petrol	109	04/95-07/97	99U										
Engine		Information			A10	A20	A40	A50	A70	C10 - C30	C20	E01		
All engines										1.970.170	C10			
ENGINE														
3.0i 12V S	Petrol	112	08/97->	99U										
Engine		Information			A10	A20	A40	A50	A70	C10 - C30	C20	E01		
All engines										1.970.170	C10			
ZEPHYR														
ENGINE														
1.7	Petrol	41	12/62-10/66	--										
Engine		Information			A10	A20	A40	A50	A70	C10 - C30	C20	E01		
All engines							1.328.070	1.428.006						
ENGINE														
1.7	Petrol	44	03/62-03/68	--, EL 17 L										
Engine		Information			A10	A20	A40	A50	A70	C10 - C30	C20	E01		
All engines							1.328.070	1.428.006						
ENGINE														
1.7	Petrol	48	03/62-03/68	EL 17 L										
Engine		Information			A10	A20	A40	A50	A70	C10 - C30	C20	E01		
All engines							1.328.070	1.428.006						
ENGINE														
2.0	Petrol	57	03/68-10/72	EV 20 A										
Engine		Information			A10	A20	A40	A50	A70	C10 - C30	C20	E01		
All engines								1.428.007						
ENGINE														
2.0	Petrol	61	03/68-10/72	EV 20 B										
Engine		Information			A10	A20	A40	A50	A70	C10 - C30	C20	E01		
All engines								1.428.007						
ENGINE														
2.5	Petrol	65	03/62-03/68	EL25										
Engine		Information			A10	A20	A40	A50	A70	C10 - C30	C20	E01		
All engines								1.428.007						
ENGINE														
2.5	Petrol	68	03/62-03/68	EL 25 L										
Engine		Information			A10	A20	A40	A50	A70	C10 - C30	C20	E01		
All engines								1.428.007						
ENGINE														
2.5	Petrol	73	03/68-10/72	EV 25 B										
Engine		Information			A10	A20	A40	A50	A70	C10 - C30	C20	E01		
All engines								1.428.007						

A10	CONDENSER	A20	CONTACT SET	A40	DISTRIBUTOR CAP	A50	ROTOR	A70	PICK-UP
C10	COIL	C20	IGNITION MODULE	C30	ELECTRONIC IGNITION KIT	E01	IGNITION CABLE SET		

The present application list is a brief version. For the detailed information about the possibility of installation on a specific vehicle, please refer to our web-catalogue <http://catalogo.facet.eu/>

Vehicle	alim.	kW	Date	Engine	FUNCTIONS ON THE VEHICLE							
					A10	A20	A40	A50	A70	C10 - C30	C20	E01

ENGINE				
2.5	Petrol	76	03/68-10/72	EV 25 L

Engine	Information	A10	A20	A40	A50	A70	C10 - C30	C20	E01
All engines					1.428.007				

ENGINE				
3.0	Petrol	88	03/68-10/72	EV 30 A

Engine	Information	A10	A20	A40	A50	A70	C10 - C30	C20	E01
All engines					1.428.007				

ENGINE				
3.0	Petrol	94	03/68-10/72	EV30B

Engine	Information	A10	A20	A40	A50	A70	C10 - C30	C20	E01
All engines					1.428.007				

ZODIAK

ENGINE				
2.5	Petrol	73	03/62-10/72	EL 25 LV

Engine	Information	A10	A20	A40	A50	A70	C10 - C30	C20	E01
All engines					1.428.007				

ENGINE				
2.5	Petrol	78	03/62-10/72	EL 25 HV

Engine	Information	A10	A20	A40	A50	A70	C10 - C30	C20	E01
All engines					1.428.007				

A10 CONDENSER	A20 CONTACT SET	A40 DISTRIBUTOR CAP	A50 ROTOR	A70 PICK-UP
C10 COIL	C20 IGNITION MODULE	C30 ELECTRONIC IGNITION KIT	E01 IGNITION CABLE SET	

Vehicle	alim.	kW	Date	Engine	FUNCTIONS ON THE VEHICLE							
					 A10	 A20	 A40	 A50	 A70	 C10 - C30	 C20	 E01

FIESTA

1.0i	Petrol	48	07/99->	ENGINE ZL10
------	--------	----	---------	----------------

Engine	Information	A10	A20	A40	A50	A70	C10 - C30	C20	E01
All engines							1.970.532	C10	1.501.691

1.6i	Petrol	70	07/99->	ENGINE ZL16
------	--------	----	---------	----------------

Engine	Information	A10	A20	A40	A50	A70	C10 - C30	C20	E01
All engines							1.970.532	C10	1.501.691

A10	CONDENSER	A20	CONTACT SET	A40	DISTRIBUTOR CAP	A50	ROTOR	A70	PICK-UP
C10	COIL	C20	IGNITION MODULE	C30	ELECTRONIC IGNITION KIT	E01	IGNITION CABLE SET		

The present application list is a brief version. For the detailed information about the possibility of installation on a specific vehicle, please refer to our web-catalogue <http://catalogo.facet.eu/>

					FUNCTIONS ON THE VEHICLE									
Vehicle	alim.	kW	Date	Engine	 A10	 A20	 A40	 A50	 A70	 C10 - C30	 C20	 E01		
CORTINA														
2.0	Petrol	66	06/77-08/82	ENGINE --										
Engine	Information				A10	A20	A40	A50	A70	C10 - C30	C20	E01		
All engines	version Bosch					1.206.034HVS	1.306.079	1.406.012R						
FAIRLANE														
3.2i Efi	Petrol	0	01/89->	ENGINE --										
Engine	Information				A10	A20	A40	A50	A70	C10 - C30	C20	E01		
All engines	version Bosch						1.306.244	1.406.131						
3.9i Efi	Petrol	0	01/89->	ENGINE --										
Engine	Information				A10	A20	A40	A50	A70	C10 - C30	C20	E01		
All engines	version Bosch						1.306.244	1.406.131						
3.9i MPEFi	Petrol	0	01/89->	ENGINE --										
Engine	Information				A10	A20	A40	A50	A70	C10 - C30	C20	E01		
All engines	version Bosch						1.306.244	1.406.131						
4.0i MPEFi	Petrol	0	01/89->	ENGINE --										
Engine	Information				A10	A20	A40	A50	A70	C10 - C30	C20	E01		
All engines	version Bosch						1.306.244	1.406.131						
FALCON														
3.2 Efi	Petrol	90	03/88-12/88	ENGINE --										
Engine	Information				A10	A20	A40	A50	A70	C10 - C30	C20	E01		
All engines	version Bosch						1.306.244	1.406.131						
3.3	Petrol	88	02/86-12/87	ENGINE --										
Engine	Information				A10	A20	A40	A50	A70	C10 - C30	C20	E01		
All engines	version Bosch						1.306.244							
3.3	Petrol	90	10/84-02/86	ENGINE --										
Engine	Information				A10	A20	A40	A50	A70	C10 - C30	C20	E01		
All engines	version Bosch						1.306.244							
3.9 Efi	Petrol	120	07/91-04/92	ENGINE --										
Engine	Information				A10	A20	A40	A50	A70	C10 - C30	C20	E01		
All engines	version Bosch						1.306.244	1.406.131						
3.9 MPFi	Petrol	139	03/88-04/92	ENGINE --										
Engine	Information				A10	A20	A40	A50	A70	C10 - C30	C20	E01		
All engines	version Bosch						1.306.244	1.406.131						
3.9 SPFFi	Petrol	120	03/88-04/92	ENGINE --										
Engine	Information				A10	A20	A40	A50	A70	C10 - C30	C20	E01		
All engines	version Bosch						1.306.244	1.406.131						
4.1	Petrol	103	10/84-02/86	ENGINE --										
Engine	Information				A10	A20	A40	A50	A70	C10 - C30	C20	E01		
All engines	version Bosch						1.306.244							
LASER														
1.3	Petrol	49	03/81-09/87	ENGINE E3										
Engine	Information				A10	A20	A40	A50	A70	C10 - C30	C20	E01		
All engines	version Mitsubishi						1.331.003/00, 1.331.109, 1.331.118	1.431.023						
1.5	Petrol	54	03/81-09/85	ENGINE E5										
Engine	Information				A10	A20	A40	A50	A70	C10 - C30	C20	E01		
All engines	version Mitsubishi						1.331.003/00, 1.331.109	1.431.023						
A10	CONDENSER		A20	CONTACT SET		A40	DISTRIBUTOR CAP		A50	ROTOR		A70	PICK-UP	
C10	COIL		C20	IGNITION MODULE		C30	ELECTRONIC IGNITION KIT		E01	IGNITION CABLE SET				

Vehicle	alim.	kW	Date	Engine	FUNCTIONS ON THE VEHICLE									
					A10	A20	A40	A50	A70	C10 - C30	C20	E01		
ENGINE														
1.5	Petrol	59	03/83-09/85	E5										
Engine		Information			A10	A20	A40	A50	A70	C10 - C30	C20	E01		
All engines		version Mitsubishi					1.331.109							
ENGINE														
1.5 Sport	Petrol	58	03/81-02/83	E5										
Engine		Information			A10	A20	A40	A50	A70	C10 - C30	C20	E01		
All engines		version Mitsubishi					1.331.003/00	1.431.023						
ENGINE														
1.6	Petrol	64	03/90-09/91	B6 (SOHC 16 V)										
Engine		Information			A10	A20	A40	A50	A70	C10 - C30	C20	E01		
All engines		version Mitsubishi					1.331.131	1.431.119						
ENGINE														
1.6 i	Petrol	80	10/94-03/99	B6 (DOHC 16 V)										
Engine		Information			A10	A20	A40	A50	A70	C10 - C30	C20	E01		
All engines		version Mitsubishi					1.331.150	1.431.132						
ENGINE														
1.8 i	Petrol	92	10/94-03/99	BP (DOHC)										
Engine		Information			A10	A20	A40	A50	A70	C10 - C30	C20	E01		
All engines		version Mitsubishi					1.331.150	1.431.132						
METEOR														
ENGINE														
1.5	Petrol	54	04/82-09/85	E5										
Engine		Information			A10	A20	A40	A50	A70	C10 - C30	C20	E01		
All engines		version Mitsubishi					1.331.109							
ENGINE														
1.5	Petrol	59	04/82-09/85	E5										
Engine		Information			A10	A20	A40	A50	A70	C10 - C30	C20	E01		
All engines		version Mitsubishi					1.331.109							
TAURUS														
ENGINE														
3.0i V6	Petrol	0	01/96->	--										
Engine		Information			A10	A20	A40	A50	A70	C10 - C30	C20	E01		
All engines										1.970.170	C10			
TELSTAR														
ENGINE														
2.0 Efi	Petrol	85	10/94-11/96	F5										
Engine		Information			A10	A20	A40	A50	A70	C10 - C30	C20	E01		
All engines		version Hitachi, no specific info conc. application available					1.322.077, 1.322.092	1.422.094, 1.422.102						
ENGINE														
2.0 TX5	Petrol	70	05/83-10/87	FE										
Engine		Information			A10	A20	A40	A50	A70	C10 - C30	C20	E01		
All engines		version Mitsubishi					1.331.109							
ENGINE														
2.5	Petrol	120	01/92-08/94	KL-ZE										
Engine		Information			A10	A20	A40	A50	A70	C10 - C30	C20	E01		
All engines		version Mitsubishi, no specific info conc. application available					1.331.137, 1.331.149	1.431.133, 1.431.134						
ENGINE														
2.5	Petrol	123	01/92-10/95	KL-ZE										
Engine		Information			A10	A20	A40	A50	A70	C10 - C30	C20	E01		
All engines		version Mitsubishi, no specific info conc. application available					1.331.137, 1.331.149	1.431.133, 1.431.134						
ENGINE														
2.5 TX5 Efi	Petrol	120	10/94-11/96	KL-ZE										
Engine		Information			A10	A20	A40	A50	A70	C10 - C30	C20	E01		
All engines		version Mitsubishi, no specific info conc. application available					1.331.137, 1.331.149	1.431.133, 1.431.134						

A10	CONDENSER	A20	CONTACT SET	A40	DISTRIBUTOR CAP	A50	ROTOR	A70	PICK-UP
C10	COIL	C20	IGNITION MODULE	C30	ELECTRONIC IGNITION KIT	E01	IGNITION CABLE SET		

The present application list is a brief version. For the detailed information about the possibility of installation on a specific vehicle, please refer to our web-catalogue <http://catalogo.facet.eu/>

Vehicle	alim.	kW	Date	Engine	FUNCTIONS ON THE VEHICLE							
					A10	A20	A40	A50	A70	C10 - C30	C20	E01
EXPLORER												
4.0 V6 4WD	Petrol	115	03/95-12/01	--								
Engine	Information				A10	A20	A40	A50	A70	C10 - C30	C20	E01
All engines										1.970.289	C10	
4.0 V6 4WD												
4.0 V6 4WD	Petrol	121	01/93-12/94	--								
Engine	Information				A10	A20	A40	A50	A70	C10 - C30	C20	E01
All engines										1.970.289	C10	
4.0 V6 4WD												
4.0 V6 4WD	Petrol	150	10/98-12/01	--								
Engine	Information				A10	A20	A40	A50	A70	C10 - C30	C20	E01
All engines										1.970.289	C10	
4.0 V6 4WD												
4.0 V6 4WD	Petrol	152	10/96-12/01	--								
Engine	Information				A10	A20	A40	A50	A70	C10 - C30	C20	E01
All engines										1.970.289	C10	
MUSTANG												
4.0 V6	Petrol	157	12/04-12/10	--								
Engine	Information				A10	A20	A40	A50	A70	C10 - C30	C20	E01
All engines										1.970.289	C10	
PROBE II												
2.5 V6 24V	Petrol	119	10/93-03/98	KL								
Engine	Information				A10	A20	A40	A50	A70	C10 - C30	C20	E01
All engines	->year 30/11/94, version Mitsubishi						1.331.137	1.431.133				
All engines	01/12/94 ->, version Mitsubishi							1.431.134				
2.5 V6 24V												
2.5 V6 24V	Petrol	120	12/94-03/98	KL								
Engine	Information				A10	A20	A40	A50	A70	C10 - C30	C20	E01
All engines	->year 30/11/94, version Mitsubishi						1.331.137	1.431.133				
All engines	01/12/94 ->, version Mitsubishi							1.431.134				
WINDSTAR												
3.0 V6	Petrol	108	01/95-12/00	99U30								
Engine	Information				A10	A20	A40	A50	A70	C10 - C30	C20	E01
All engines	x 1, D.I.S.									1.970.170	C10	
3.0 V6												
3.0 V6	Petrol	109	03/95-02/99	--, 99U30								
Engine	Information				A10	A20	A40	A50	A70	C10 - C30	C20	E01
Eng. --										1.970.170	C10	
Eng. 99U30	x 1, D.I.S.									1.970.170	C10	

A10 CONDENSER	A20 CONTACT SET	A40 DISTRIBUTOR CAP	A50 ROTOR	A70 PICK-UP
C10 COIL	C20 IGNITION MODULE	C30 ELECTRONIC IGNITION KIT	E01 IGNITION CABLE SET	

Vehicle	alim.	kW	Date	Engine	FUNCTIONS ON THE VEHICLE							
					A10	A20	A40	A50	A70	C10 - C30	C20	E01

126P				ENGINE
0.6	Petrol	17	09/72-07/77	--

Engine	Information	A10	A20	A40	A50	A70	C10 - C30	C20	E01
All engines	->year 31/07/77, version Marelli		1.230.120	1.330.086	1.430.040				
All engines	->year 31/07/77						1.970.101D	C10	

ENGINE				
0.6	Petrol	22	07/77-12/91	126 A1.048





Engine	Information	A10	A20	A40	A50	A70	C10 - C30	C20	E01
All engines	01/08/77 ->, version Marelli	1.130.128							
All engines	01/01/87 ->, version Marelli		1.230.146M						
All engines	01/08/77 ->, ->year 31/12/86, version Marelli		1.230.150M						
All engines	version Zelmot		1.249.350						

POLONEZ I				ENGINE
1.5	Petrol	55	10/77-08/88	AA

Engine	Information	A10	A20	A40	A50	A70	C10 - C30	C20	E01
All engines	version Marelli		1.230.127						
All engines							1.970.101D	C10	

A10	CONDENSER	A20	CONTACT SET	A40	DISTRIBUTOR CAP	A50	ROTOR	A70	PICK-UP
C10	COIL	C20	IGNITION MODULE	C30	ELECTRONIC IGNITION KIT	E01	IGNITION CABLE SET		

The present application list is a brief version. For the detailed information about the possibility of installation on a specific vehicle, please refer to our web-catalogue <http://catalogo.facet.eu/>

					FUNCTIONS ON THE VEHICLE							
Vehicle	alim.	kW	Date	Engine								
					A10	A20	A40	A50	A70	C10 - C30	C20	E01

G15				
				ENGINE
0.9	Petrol	38	01/67-12/75	--









Engine	Information	A10	A20	A40	A50	A70	C10 - C30	C20	E01
All engines					1.428.006				

A10	CONDENSER	A20	CONTACT SET	A40	DISTRIBUTOR CAP	A50	ROTOR	A70	PICK-UP
C10	COIL	C20	IGNITION MODULE	C30	ELECTRONIC IGNITION KIT	E01	IGNITION CABLE SET		

Vehicle	alim.	kW	Date	Engine	FUNCTIONS ON THE VEHICLE							
					A10	A20	A40	A50	A70	C10 - C30	C20	E01
APOLLO												
2.0	Petrol	82	08/89-08/91	3S-FC								
Engine	Information			A10	A20	A40	A50	A70	C10 - C30	C20	E01	
All engines	version Denso					1.313.278	1.413.029					
All engines								1.970.199	C10			
2.0 i												
Engine	Information			A10	A20	A40	A50	A70	C10 - C30	C20	E01	
All engines	version Denso						1.413.029					
All engines								1.970.197	C10			
2.2 i												
Engine	Information			A10	A20	A40	A50	A70	C10 - C30	C20	E01	
All engines	01/10/93 ->, version Denso					1.313.267						
All engines	version Denso						1.413.029					
All engines								1.970.198	C10			
All engines	01/10/93 ->										1.501.793	
ASTRA LB												
1.5	Petrol	51	08/84-01/86	E15								
Engine	Information			A10	A20	A40	A50	A70	C10 - C30	C20	E01	
All engines	->year 31/01/85, version Hitachi				1.222.056HV	1.322.003						
All engines	01/02/85 ->, version Hitachi					1.322.057	1.422.052					
ASTRA LC												
1.6	Petrol	52	02/86-06/87	E16S								
Engine	Information			A10	A20	A40	A50	A70	C10 - C30	C20	E01	
All engines	version Hitachi					1.322.057	1.422.052					
ASTRA LD												
1.6i	Petrol	55	07/87-07/89	16LE								
Engine	Information			A10	A20	A40	A50	A70	C10 - C30	C20	E01	
All engines	version Delco Remy					1.312.075	1.412.098					
1.8i Hatchback												
Engine	Information			A10	A20	A40	A50	A70	C10 - C30	C20	E01	
All engines	version Delco Remy					1.312.075	1.412.098					
1.8i Sedan												
Engine	Information			A10	A20	A40	A50	A70	C10 - C30	C20	E01	
All engines	version Delco Remy					1.312.075	1.412.098					
ASTRA TR												
1.8i 16v Hatchback	Petrol	85	09/96-09/98	C18SEL								
Engine	Information			A10	A20	A40	A50	A70	C10 - C30	C20	E01	
All engines									1.970.272	C10	1.501.562	
1.8i 16v Sedan												
Engine	Information			A10	A20	A40	A50	A70	C10 - C30	C20	E01	
All engines									1.970.272	C10	1.501.562	
2.0i 16V Hatchback												
Engine	Information			A10	A20	A40	A50	A70	C10 - C30	C20	E01	
All engines									1.970.272	C10	1.501.562	
BARINA												
1.3	Petrol	50	08/86-12/89	G13A								
Engine	Information			A10	A20	A40	A50	A70	C10 - C30	C20	E01	
All engines	version Denso						1.413.028					

A10 CONDENSER	A20 CONTACT SET	A40 DISTRIBUTOR CAP	A50 ROTOR	A70 PICK-UP
C10 COIL	C20 IGNITION MODULE	C30 ELECTRONIC IGNITION KIT	E01 IGNITION CABLE SET	

The present application list is a brief version. For the detailed information about the possibility of installation on a specific vehicle, please refer to our web-catalogue <http://catalogo.facet.eu/>

				FUNCTIONS ON THE VEHICLE								
Vehicle	alim.	kW	Date	Engine								
				ENGINE								
1.3 GL	Petrol	50	02/89-05/94	410UF01 5G02								
Engine	Information			A10	A20	A40	A50	A70	C10 - C30	C20	E01	
All engines	ch. JSAE8MG6800148088 ->, ch. JSAE8MS7700141225 ->, version Mitsubishi					1.331.131						
All engines	->ch. JSAE8MG6800148087, ->ch. JSAE8MS7700141225, version Mitsubishi					1.331.132	1.431.108					
All engines	ch. JSAE8MG6800148088 ->, ch. JSAE8MS7700141226 ->, version Mitsubishi						1.431.119					
				ENGINE								
1.3 GL	Petrol	52	02/85-08/86	G13A								
Engine	Information			A10	A20	A40	A50	A70	C10 - C30	C20	E01	
All engines	version Denso						1.413.028					
				ENGINE								
1.4 i	Petrol	44	04/94-07/97	C14 NZ								
Engine	Information			A10	A20	A40	A50	A70	C10 - C30	C20	E01	
All engines	version Bosch					1.306.256	1.406.121R					
All engines	version Lucas					1.328.100	1.428.028R					
All engines								1.970.140	C10	1.965.036	1.501.237	
				ENGINE								
1.6	Petrol	78	05/97-08/00	X16 XE								
Engine	Information			A10	A20	A40	A50	A70	C10 - C30	C20	E01	
All engines											1.500.688	
				ENGINE								
BARINA_SB				ENGINE								
1.2i	Petrol	33	04/94-07/97	C12NZ								
Engine	Information			A10	A20	A40	A50	A70	C10 - C30	C20	E01	
All engines	version Bosch					1.306.256	1.406.121R					
All engines	version Lucas					1.328.100	1.428.028R					
All engines								1.970.140	C10	1.965.036	1.501.237	
				ENGINE								
1.6i	Petrol	78	12/95-09/98	X16XE								
Engine	Information			A10	A20	A40	A50	A70	C10 - C30	C20	E01	
All engines											1.500.688	
				ENGINE								
1.6i	Petrol	80	04/94-11/95	C16XE								
Engine	Information			A10	A20	A40	A50	A70	C10 - C30	C20	E01	
All engines											1.500.688	
				ENGINE								
CALAIS				ENGINE								
3.0 Executive	Petrol	114	10/88-09/90	--								
Engine	Information			A10	A20	A40	A50	A70	C10 - C30	C20	E01	
All engines									1.970.219	C10		
				ENGINE								
CALAIS_VL				ENGINE								
2.0i	Petrol	95	01/86-07/88	2.0 PFI								
Engine	Information			A10	A20	A40	A50	A70	C10 - C30	C20	E01	
All engines									1.970.219	C10		
				ENGINE								
3.0i Turbo	Petrol	154	01/86-07/88	3.0 EFI TURBO								
Engine	Information			A10	A20	A40	A50	A70	C10 - C30	C20	E01	
All engines									1.970.219	C10		
				ENGINE								
CALAIS_VN				ENGINE								
5.0i	Petrol	165	08/88-09/91	5.0 V8 EFI								
Engine	Information			A10	A20	A40	A50	A70	C10 - C30	C20	E01	
All engines	version Bosch					1.306.112	1.406.131					
				ENGINE								
CALAIS_VP				ENGINE								
5.0i Sedan	Petrol	165	10/91-07/93	5.0 V8 EFI								
Engine	Information			A10	A20	A40	A50	A70	C10 - C30	C20	E01	
All engines	version Bosch					1.306.112	1.406.131					

A10 CONDENSER	A20 CONTACT SET	A40 DISTRIBUTOR CAP	A50 ROTOR	A70 PICK-UP
C10 COIL	C20 IGNITION MODULE	C30 ELECTRONIC IGNITION KIT	E01 IGNITION CABLE SET	

Vehicle	alim.	kW	Date	Engine	FUNCTIONS ON THE VEHICLE							
					A10	A20	A40	A50	A70	C10 - C30	C20	E01

CALAIS_VR

				ENGINE
5.0i Sedan	Petrol	165	07/93-04/95	5.0 PFI V8

Engine	Information	A10	A20	A40	A50	A70	C10 - C30	C20	E01
All engines	version Bosch			1.306.112	1.406.131				

CALAIS_VS

				ENGINE
5.0i Sedan	Petrol	165	04/95-05/96	5.0 V8 PFI

Engine	Information	A10	A20	A40	A50	A70	C10 - C30	C20	E01
All engines	version Bosch			1.306.112	1.406.131				

CALAIS_VS-II

				ENGINE
5.0i Sedan	Petrol	165	06/96-08/97	5.0 V8 PFI

Engine	Information	A10	A20	A40	A50	A70	C10 - C30	C20	E01
All engines	version Bosch			1.306.112	1.406.131				

CALIBRA_YE

				ENGINE
2.0i	Petrol	85	09/91-07/95	C20NE

Engine	Information	A10	A20	A40	A50	A70	C10 - C30	C20	E01
All engines	version Bosch			1.306.257	1.406.127R				
All engines	eng. type 14672353 ->								1.500.689

				ENGINE
2.0i 16V	Petrol	100	08/95-10/97	X20XEV

Engine	Information	A10	A20	A40	A50	A70	C10 - C30	C20	E01
All engines							1.970.272	C10	1.501.562

				ENGINE
2.0i 16V	Petrol	110	09/91-07/95	C20XE

Engine	Information	A10	A20	A40	A50	A70	C10 - C30	C20	E01
All engines	version Bosch			1.306.257					
All engines	ch. P1000001, P9000001 ->						1.970.273	C10	1.500.688

				ENGINE
2.0i 16V Turbo	Petrol	150	06/94-10/97	C20LET

Engine	Information	A10	A20	A40	A50	A70	C10 - C30	C20	E01
All engines	version Bosch			1.306.257					

CAMIRA

				ENGINE
1.6	Petrol	64	08/82-02/86	16JH

Engine	Information	A10	A20	A40	A50	A70	C10 - C30	C20	E01
All engines	version Bosch			1.306.080	1.406.056R				

				ENGINE
1.8 MPFI	Petrol	83	11/84-01/86	6TZ204XS85K01

Engine	Information	A10	A20	A40	A50	A70	C10 - C30	C20	E01
All engines	version Bosch			1.306.080	1.406.056R				

				ENGINE
1.8 SPFI	Petrol	63	02/86-03/87	6TZ204XS85K01

Engine	Information	A10	A20	A40	A50	A70	C10 - C30	C20	E01
All engines	version Bosch			1.306.080	1.406.056R				
All engines	version Delco Remy			1.312.075	1.412.098				

				ENGINE
2.0 i	Petrol	85	04/87-07/89	C 20 JE

Engine	Information	A10	A20	A40	A50	A70	C10 - C30	C20	E01
All engines	version Delco Remy			1.312.075	1.412.098				

CAPRICE_VQ

				ENGINE
5.0i Sedan	Petrol	165	03/90-11/93	5.0 V8 EFI

Engine	Information	A10	A20	A40	A50	A70	C10 - C30	C20	E01
All engines	version Bosch			1.306.112	1.406.131				

CAPRICE_VR

				ENGINE
5.0i Sedan	Petrol	165	12/93-04/95	5.0 PFI V8

Engine	Information	A10	A20	A40	A50	A70	C10 - C30	C20	E01
All engines	version Bosch			1.306.112	1.406.131				

A10	CONDENSER	A20	CONTACT SET	A40	DISTRIBUTOR CAP	A50	ROTOR	A70	PICK-UP
C10	COIL	C20	IGNITION MODULE	C30	ELECTRONIC IGNITION KIT	E01	IGNITION CABLE SET		

Vehicle	alim.	kW	Date	Engine	FUNCTIONS ON THE VEHICLE							
					A10	A20	A40	A50	A70	C10 - C30	C20	E01

CAPRICE_VS

5.0i Sedan	Petrol	165	03/95-08/96	ENGINE
				5.0 V8 PFI

Engine	Information	A10	A20	A40	A50	A70	C10 - C30	C20	E01
All engines	version Bosch			1.306.112	1.406.131				

CAPRICE_VS-II

5.0i Sedan	Petrol	165	09/96-08/97	ENGINE
				5.0 V8 PFI

Engine	Information	A10	A20	A40	A50	A70	C10 - C30	C20	E01
All engines	version Bosch			1.306.112	1.406.131				

COMBO

1.4i	Petrol	44	03/96-07/97	ENGINE
				C14 NZ

Engine	Information	A10	A20	A40	A50	A70	C10 - C30	C20	E01	
All engines	version Bosch			1.306.256	1.406.121R					
All engines	version Lucas			1.328.100	1.428.028R					
All engines							1.970.140	C10	1.965.036	1.501.237

COMBO_SB

1.4i	Petrol	44	04/94-07/97	ENGINE
				C14NZ

Engine	Information	A10	A20	A40	A50	A70	C10 - C30	C20	E01	
All engines	version Bosch			1.306.256	1.406.121R					
All engines	version Lucas			1.328.100	1.428.028R					
All engines							1.970.140	C10	1.965.036	1.501.237

COMMODORE

1.9	Petrol	54	09/78-04/86	ENGINE
				--, 1X

Engine	Information	A10	A20	A40	A50	A70	C10 - C30	C20	E01
All engines	version Bosch		1.206.034HVS						

1.9	Petrol	58	04/80-09/81	ENGINE
				1X

Engine	Information	A10	A20	A40	A50	A70	C10 - C30	C20	E01
All engines	version Bosch		1.206.034HVS						

3.0 Efi	Petrol	114	03/86-09/88	ENGINE
				2552 63 088

Engine	Information	A10	A20	A40	A50	A70	C10 - C30	C20	E01
All engines							1.970.219	C10	

3.0 Efi Turbo	Petrol	150	01/86-08/88	ENGINE
				RB30ET

Engine	Information	A10	A20	A40	A50	A70	C10 - C30	C20	E01
All engines							1.970.219	C10	

VR 5.0i	Petrol	165	07/93-04/95	ENGINE
				5.0 PFI V8

Engine	Information	A10	A20	A40	A50	A70	C10 - C30	C20	E01
All engines	version Bosch			1.306.112	1.406.131				

VR 5.0i Wagon	Petrol	165	07/93-04/95	ENGINE
				5.0 PFI V8

Engine	Information	A10	A20	A40	A50	A70	C10 - C30	C20	E01
All engines	version Bosch			1.306.112	1.406.131				

VS 5.0i	Petrol	165	04/95-05/96	ENGINE
				5.0 V8 PFI

Engine	Information	A10	A20	A40	A50	A70	C10 - C30	C20	E01
All engines	version Bosch			1.306.112	1.406.131				

VS-II 5.0i	Petrol	165	06/96-08/97	ENGINE
				5.0 V8 PFI

Engine	Information	A10	A20	A40	A50	A70	C10 - C30	C20	E01
All engines	version Bosch			1.306.112	1.406.131				

COMMODORE_VL

2.0i	Petrol	95	01/86-07/88	ENGINE
				2.0 PFI





Engine	Information	A10	A20	A40	A50	A70	C10 - C30	C20	E01
All engines							1.970.219	C10	

A10 CONDENSER	A20 CONTACT SET	A40 DISTRIBUTOR CAP	A50 ROTOR	A70 PICK-UP
C10 COIL	C20 IGNITION MODULE	C30 ELECTRONIC IGNITION KIT	E01 IGNITION CABLE SET	

Vehicle	alim.	kW	Date	Engine	FUNCTIONS ON THE VEHICLE									
					A10	A20	A40	A50	A70	C10 - C30	C20	E01		
ENGINE														
2.0i Wagon	Petrol	95	01/86-07/88	2.0 PFI										
Engine	Information				A10	A20	A40	A50	A70	C10 - C30	C20	E01		
All engines										1.970.219	C10			
ENGINE														
5.0i Group A SS	Petrol	122	02/87-07/88	5.0 V8 EFI										
Engine	Information				A10	A20	A40	A50	A70	C10 - C30	C20	E01		
All engines	version Bosch						1.306.112	1.406.131						
COMMODORE_VN														
ENGINE														
5.0i	Petrol	165	08/88-09/91	5.0 V8 EFI										
Engine	Information				A10	A20	A40	A50	A70	C10 - C30	C20	E01		
All engines	version Bosch						1.306.112	1.406.131						
ENGINE														
5.0i Group A SS	Petrol	215	08/88-09/91	5.0 V8 EFI										
Engine	Information				A10	A20	A40	A50	A70	C10 - C30	C20	E01		
All engines	version Bosch						1.306.112	1.406.131						
COMMODORE_VP														
ENGINE														
5.0i	Petrol	165	10/91-07/93	5.0 V8 EFI										
Engine	Information				A10	A20	A40	A50	A70	C10 - C30	C20	E01		
All engines	version Bosch						1.306.112	1.406.131						
DROVER														
ENGINE														
QB 1.3	Petrol	47	02/85-12/87	G13A										
Engine	Information				A10	A20	A40	A50	A70	C10 - C30	C20	E01		
All engines	version Denso						1.313.093	1.413.030						
All engines													1.499.020	
FORMULA_VR (8VK19)														
ENGINE														
5.0i	Petrol	165	07/93-04/95	5.0 PFI V8										
Engine	Information				A10	A20	A40	A50	A70	C10 - C30	C20	E01		
All engines	version Bosch						1.306.112	1.406.131						
FRONTERA_UT (8MB25)														
ENGINE														
2.0i	Petrol	85	10/95-03/99	X20SE										
Engine	Information				A10	A20	A40	A50	A70	C10 - C30	C20	E01		
All engines										1.970.273	C10		1.501.947	
GEMINI_RB (8RB69)														
ENGINE														
1.5	Petrol	52	04/85-06/87	4XC1										
Engine	Information				A10	A20	A40	A50	A70	C10 - C30	C20	E01		
All engines	version Denso						1.313.092	1.413.030						
JACKAROO_UBS														
ENGINE														
2.2 4x4	Petrol	68	03/87-10/88	4ZD1										
Engine	Information				A10	A20	A40	A50	A70	C10 - C30	C20	E01		
All engines	version Denso						1.313.093	1.413.014						
ENGINE														
2.6i 4x4	Petrol	84	11/88-12/91	4ZE1										
Engine	Information				A10	A20	A40	A50	A70	C10 - C30	C20	E01		
All engines	version Hitachi							1.422.069						
NOVA_LF														
ENGINE														
1.6i Hatchback	Petrol	76	08/91-03/93	4AFE										
Engine	Information				A10	A20	A40	A50	A70	C10 - C30	C20	E01		
All engines	version Denso							1.413.029						
ENGINE														
1.6i Sedan	Petrol	76	08/91-03/93	4AFE										
Engine	Information				A10	A20	A40	A50	A70	C10 - C30	C20	E01		
All engines	version Denso							1.413.029						

A10 CONDENSER	A20 CONTACT SET	A40 DISTRIBUTOR CAP	A50 ROTOR	A70 PICK-UP
C10 COIL	C20 IGNITION MODULE	C30 ELECTRONIC IGNITION KIT	E01 IGNITION CABLE SET	

The present application list is a brief version. For the detailed information about the possibility of installation on a specific vehicle, please refer to our web-catalogue <http://catalogo.facet.eu/>

				FUNCTIONS ON THE VEHICLE								
Vehicle	alim.	kW	Date	Engine	 A10	 A20	 A40	 A50	 A70	 C10 - C30	 C20	 E01
				ENGINE								
1.8i Hatchback	Petrol	86	08/91-03/93	7AFE								
Engine	Information			A10	A20	A40	A50	A70	C10 - C30	C20	E01	
All engines	version Denso					1.313.265	1.413.029					
All engines									1.970.199	C10		1.501.209
				ENGINE								
1.8i Sedan	Petrol	86	08/91-03/93	7AFE								
Engine	Information			A10	A20	A40	A50	A70	C10 - C30	C20	E01	
All engines	version Denso					1.313.265	1.413.029					
All engines									1.970.199	C10		1.501.209
				ENGINE								
NOVA_LG												
1.6i Hatchback	Petrol	76	09/94-09/96	4AFE								
Engine	Information			A10	A20	A40	A50	A70	C10 - C30	C20	E01	
All engines	version Denso					1.313.265	1.413.029					
All engines									1.970.199	C10		1.501.209
				ENGINE								
1.6i Sedan	Petrol	76	09/94-09/96	4AFE								
Engine	Information			A10	A20	A40	A50	A70	C10 - C30	C20	E01	
All engines	version Denso					1.313.265	1.413.029					
All engines									1.970.199	C10		1.501.209
				ENGINE								
1.8i Hatchback	Petrol	86	09/94-09/96	7AFE								
Engine	Information			A10	A20	A40	A50	A70	C10 - C30	C20	E01	
All engines	version Denso					1.313.265	1.413.029					
All engines									1.970.199	C10		1.501.209
				ENGINE								
1.8i Sedan	Petrol	86	09/94-09/96	7AFE								
Engine	Information			A10	A20	A40	A50	A70	C10 - C30	C20	E01	
All engines	version Denso					1.313.265	1.413.029					
All engines									1.970.199	C10		1.501.209
				ENGINE								
PIAZZA_YB												
2.0i Turbo	Petrol	110	04/86-12/87	2L H.C.								
Engine	Information			A10	A20	A40	A50	A70	C10 - C30	C20	E01	
All engines	version Denso						1.413.027					
				ENGINE								
RODEO_TF												
2.2	Petrol	69	03/91-08/93	4ZD1								
Engine	Information			A10	A20	A40	A50	A70	C10 - C30	C20	E01	
All engines	version Denso					1.313.254	1.413.014					
				ENGINE								
2.6i	Petrol	88	08/88-03/96	4ZE1								
Engine	Information			A10	A20	A40	A50	A70	C10 - C30	C20	E01	
All engines	version Hitachi					1.322.060	1.422.069					
				ENGINE								
2.6i 4x4	Petrol	88	08/88-03/96	4ZE1								
Engine	Information			A10	A20	A40	A50	A70	C10 - C30	C20	E01	
All engines	version Hitachi					1.322.060	1.422.069					
				ENGINE								
SCURRY_NB												
1.0	Petrol	33	10/85-05/86	F10A								
Engine	Information			A10	A20	A40	A50	A70	C10 - C30	C20	E01	
All engines	version Denso					1.213.011HV	1.313.093	1.413.030				
				ENGINE								
SHUTTLE_WFR												
2.0	Petrol	69	06/86-06/89	4ZC1								
Engine	Information			A10	A20	A40	A50	A70	C10 - C30	C20	E01	
All engines	version Denso					1.313.093						
All engines	->year 31/10/87, version Denso						1.413.014					
All engines	01/11/87 ->, version Denso						1.413.030					

A10 CONDENSER	A20 CONTACT SET	A40 DISTRIBUTOR CAP	A50 ROTOR	A70 PICK-UP
C10 COIL	C20 IGNITION MODULE	C30 ELECTRONIC IGNITION KIT	E01 IGNITION CABLE SET	

Vehicle	alim.	kW	Date	Engine	FUNCTIONS ON THE VEHICLE							
					A10	A20	A40	A50	A70	C10 - C30	C20	E01

STATESMAN_VQ

5.0i	Petrol	165	03/90-11/93	ENGINE
				5.0 V8 EFI

Engine	Information	A10	A20	A40	A50	A70	C10 - C30	C20	E01
All engines	version Bosch			1.306.112	1.406.131				

STATESMAN_VR

5.0i	Petrol	165	12/93-04/95	ENGINE
				5.0 PFI V8

Engine	Information	A10	A20	A40	A50	A70	C10 - C30	C20	E01
All engines	version Bosch			1.306.112	1.406.131				

STATESMAN_VS

5.0i	Petrol	165	03/95-08/96	ENGINE
				5.0 V8 PFI

Engine	Information	A10	A20	A40	A50	A70	C10 - C30	C20	E01
All engines	version Bosch			1.306.112	1.406.131				

STATESMAN_VS-II

5.0i	Petrol	165	09/96-08/97	ENGINE
				5.0 V8 PFI

Engine	Information	A10	A20	A40	A50	A70	C10 - C30	C20	E01
All engines	version Bosch			1.306.112	1.406.131				

UTILITY_VG (8VK80)

5.0i	Petrol	165	08/88-09/91	ENGINE
				5.0 V8 EFI

Engine	Information	A10	A20	A40	A50	A70	C10 - C30	C20	E01
All engines	version Bosch			1.306.112	1.406.131				

UTILITY_VP (8VK80)

5.0i	Petrol	165	10/91-07/93	ENGINE
				5.0 V8 EFI

Engine	Information	A10	A20	A40	A50	A70	C10 - C30	C20	E01
All engines	version Bosch			1.306.112	1.406.131				

UTILITY_VR COUPÈ (8VK80)

5.0i	Petrol	165	07/93-04/95	ENGINE
				5.0 PFI V8

Engine	Information	A10	A20	A40	A50	A70	C10 - C30	C20	E01
All engines	version Bosch			1.306.112	1.406.131				

A10	CONDENSER	A20	CONTACT SET	A40	DISTRIBUTOR CAP	A50	ROTOR	A70	PICK-UP
C10	COIL	C20	IGNITION MODULE	C30	ELECTRONIC IGNITION KIT	E01	IGNITION CABLE SET		

Vehicle	alim.	kW	Date	Engine	FUNCTIONS ON THE VEHICLE							
					A10	A20	A40	A50	A70	C10 - C30	C20	E01

ACCORD

1.6	Petrol	79	10/98-12/01	ENGINE
				D16B7

Engine	Information	A10	A20	A40	A50	A70	C10 - C30	C20	E01
All engines	->year 01/12/99, x 1, D.I.S.						1.970.168	C10	

ACCORD III

1.6 L	Petrol	65	11/85-12/89	ENGINE
				A16A1

Engine	Information	A10	A20	A40	A50	A70	C10 - C30	C20	E01
All engines	version Hitachi			1.322.022	1.422.056				

2.0	Petrol	101	01/86-12/86	ENGINE
				A20A2

Engine	Information	A10	A20	A40	A50	A70	C10 - C30	C20	E01
All engines	version Hitachi			1.322.022					
All engines	version Hitachi, no specific info conc. application available				1.422.056				

2.0 12V	Petrol	75	01/86-03/88	ENGINE
				A20A1

Engine	Information	A10	A20	A40	A50	A70	C10 - C30	C20	E01
All engines	version Hitachi, no specific info conc. application available				1.422.056				

2.0 12V	Petrol	85	01/87-12/89	ENGINE
				A20A3

Engine	Information	A10	A20	A40	A50	A70	C10 - C30	C20	E01
All engines	version Hitachi, no specific info conc. application available				1.422.056				

2.0 16V EXS	Petrol	101	01/88-12/89	ENGINE
				B20A2

Engine	Information	A10	A20	A40	A50	A70	C10 - C30	C20	E01
All engines	version Hitachi			1.322.022	1.422.056				

2.0 EX	Petrol	75	11/85-12/89	ENGINE
				A20A1

Engine	Information	A10	A20	A40	A50	A70	C10 - C30	C20	E01
All engines	version Hitachi, no specific info conc. application available				1.422.056				

2.0 EX	Petrol	76	11/85-12/89	ENGINE
				A20A1

Engine	Information	A10	A20	A40	A50	A70	C10 - C30	C20	E01
All engines	version Hitachi, no specific info conc. application available				1.422.056				

2.0 EX	Petrol	78	11/85-05/89	ENGINE
				A20A2

Engine	Information	A10	A20	A40	A50	A70	C10 - C30	C20	E01
All engines	version Hitachi			1.322.022					
All engines	version Hitachi, no specific info conc. application available				1.422.056				

2.0 EXi	Petrol	85	01/86-12/89	ENGINE
				A20A3

Engine	Information	A10	A20	A40	A50	A70	C10 - C30	C20	E01
All engines	version Hitachi, no specific info conc. application available				1.422.056				

2.0 EXi	Petrol	90	11/85-12/87	ENGINE
				A20A4

Engine	Information	A10	A20	A40	A50	A70	C10 - C30	C20	E01
All engines	version Hitachi, no specific info conc. application available				1.422.056				

2.0 i 16V	Petrol	101	01/87-12/87	ENGINE
				B20A2

Engine	Information	A10	A20	A40	A50	A70	C10 - C30	C20	E01
All engines	version Hitachi			1.322.022	1.422.056				

2.0 i 16V	Petrol	98	10/87-12/89	ENGINE
				B20A8

Engine	Information	A10	A20	A40	A50	A70	C10 - C30	C20	E01
All engines	version Hitachi			1.322.022	1.422.056				

A10 CONDENSER	A20 CONTACT SET	A40 DISTRIBUTOR CAP	A50 ROTOR	A70 PICK-UP
C10 COIL	C20 IGNITION MODULE	C30 ELECTRONIC IGNITION KIT	E01 IGNITION CABLE SET	

Vehicle	alim.	kW	Date	Engine	FUNCTIONS ON THE VEHICLE							
					A10	A20	A40	A50	A70	C10 - C30	C20	E01

ACCORD IV

				ENGINE
1.8	Petrol	77	01/90-12/91	--

Engine	Information	A10	A20	A40	A50	A70	C10 - C30	C20	E01
All engines	version Hitachi			1.322.071	1.422.081				
All engines							1.970.216	C10	1.501.711

				ENGINE
2.0 16V	Petrol	66	01/90-03/93	F20A6

Engine	Information	A10	A20	A40	A50	A70	C10 - C30	C20	E01
All engines	version Hitachi			1.322.071	1.422.081				
All engines							1.970.216	C10	1.501.711

				ENGINE
2.0 16V	Petrol	81	01/90-03/93	F20A2, F20A3

Engine	Information	A10	A20	A40	A50	A70	C10 - C30	C20	E01
All engines	version Hitachi			1.322.071	1.422.081				
All engines							1.970.216	C10	1.501.711

				ENGINE
2.0 16V	Petrol	98	01/90-12/93	F20A5

Engine	Information	A10	A20	A40	A50	A70	C10 - C30	C20	E01
All engines	version Hitachi			1.322.068	1.422.092				
All engines							1.970.214	C10	1.965.052

				ENGINE
2.0 i 16V	Petrol	98	01/90-12/93	F20A4, F20A7, F20A8, F20Z3

Engine	Information	A10	A20	A40	A50	A70	C10 - C30	C20	E01
All engines	version Hitachi			1.322.068					
Eng. F20A7, F20A8, F20Z3	version Hitachi				1.422.092				
All engines							1.970.214	C10	1.965.052

				ENGINE
2.2	Petrol	103	05/92-12/93	F22A6

Engine	Information	A10	A20	A40	A50	A70	C10 - C30	C20	E01
All engines	version Hitachi			1.322.068	1.422.092				
All engines							1.970.214	C10	1.965.052

				ENGINE
2.2 i 16V	Petrol	108	01/91-12/93	F22A8

Engine	Information	A10	A20	A40	A50	A70	C10 - C30	C20	E01
All engines	version Hitachi			1.322.068	1.422.092				
All engines							1.970.214	C10	1.965.052

				ENGINE
2.2 i 16V	Petrol	110	01/90-12/93	F22A3, F22A7

Engine	Information	A10	A20	A40	A50	A70	C10 - C30	C20	E01
All engines	version Hitachi			1.322.068	1.422.092				
All engines							1.970.214	C10	1.965.052

				ENGINE
2.2 i 16V Automatik	Petrol	108	01/90-03/93	F22A3

Engine	Information	A10	A20	A40	A50	A70	C10 - C30	C20	E01
All engines	version Hitachi			1.322.068	1.422.092				
All engines							1.970.214	C10	1.965.052

ACCORD V

				ENGINE
1.8 16V	Petrol	85	01/94-12/95	F18A3

Engine	Information	A10	A20	A40	A50	A70	C10 - C30	C20	E01
All engines	version Hitachi			1.322.068	1.422.095				
All engines							1.970.214	C10	1.501.711

				ENGINE
1.9 i	Petrol	85	02/96-10/98	F18A3

Engine	Information	A10	A20	A40	A50	A70	C10 - C30	C20	E01
All engines	version Hitachi			1.322.082	1.422.098				
All engines							1.970.347	C10	1.501.711

A10 CONDENSER	A20 CONTACT SET	A40 DISTRIBUTOR CAP	A50 ROTOR	A70 PICK-UP
C10 COIL	C20 IGNITION MODULE	C30 ELECTRONIC IGNITION KIT	E01 IGNITION CABLE SET	

The present application list is a brief version. For the detailed information about the possibility of installation on a specific vehicle, please refer to our web-catalogue <http://catalogo.facet.eu/>

Vehicle	alim.	kW	Date	Engine	FUNCTIONS ON THE VEHICLE							
					A10	A20	A40	A50	A70	C10 - C30	C20	E01

ENGINE				
2.0	Petrol	100	09/93-12/97	F20B3

Engine	Information	A10	A20	A40	A50	A70	C10 - C30	C20	E01
All engines	->year 31/12/96, version Hitachi			1.322.068					
All engines	01/01/97 ->, version Hitachi			1.322.076					
All engines	version Hitachi				1.422.095				
All engines							1.970.214	C10	1.501.711
All engines	->year 31/12/96							1.965.052	

ENGINE				
2.0 i	Petrol	85	03/93-01/96	F20Z2

Engine	Information	A10	A20	A40	A50	A70	C10 - C30	C20	E01
All engines	version Hitachi			1.322.068	1.422.095				
All engines							1.970.214	C10	1.501.711
All engines	->eng. E100030							1.965.052	

ENGINE				
2.0 i LS	Petrol	96	02/96-10/98	F20Z1

Engine	Information	A10	A20	A40	A50	A70	C10 - C30	C20	E01
All engines	version Hitachi			1.322.082	1.422.098				
All engines							1.970.347	C10	1.501.711

ENGINE				
2.0 i LS 16V	Petrol	100	09/93-02/98	F20B3

Engine	Information	A10	A20	A40	A50	A70	C10 - C30	C20	E01
All engines	->year 31/12/96, version Hitachi			1.322.068					
All engines	01/01/97 ->, version Hitachi			1.322.076					
All engines	version Hitachi				1.422.095				
All engines							1.970.214	C10	1.501.711
All engines	->year 31/12/96							1.965.052	

ENGINE				
2.0 i S	Petrol	96	03/93-01/96	F20Z1

Engine	Information	A10	A20	A40	A50	A70	C10 - C30	C20	E01
All engines	version Hitachi			1.322.068	1.422.095				
All engines							1.970.214	C10	1.501.711
All engines	->eng. E100030							1.965.052	

ENGINE				
2.2	Petrol	103	04/96-12/97	F22Z2

Engine	Information	A10	A20	A40	A50	A70	C10 - C30	C20	E01
All engines	version Hitachi			1.322.082	1.422.098				
All engines							1.970.347	C10	

ENGINE				
2.2	Petrol	107	10/93-12/97	F22B1

Engine	Information	A10	A20	A40	A50	A70	C10 - C30	C20	E01
All engines	version Hitachi			1.322.082	1.422.098				
All engines							1.970.347	C10	

ENGINE				
2.2 16V	Petrol	96	01/96-09/98	F22Z1

Engine	Information	A10	A20	A40	A50	A70	C10 - C30	C20	E01
All engines	version Hitachi			1.322.082	1.422.098				
All engines							1.970.347	C10	1.501.711

ENGINE				
2.2 i [USA]	Petrol	110	01/94-12/95	--

Engine	Information	A10	A20	A40	A50	A70	C10 - C30	C20	E01
All engines	version Hitachi, no specific info conc. application available			1.322.076, 1.322.082	1.422.095, 1.422.098				
All engines								1.965.052	
All engines	no specific info conc. application available								1.501.711

ENGINE				
2.2 i 16V	Petrol	110	08/95-12/97	F22B4









Engine	Information	A10	A20	A40	A50	A70	C10 - C30	C20	E01
All engines	->year 31/12/96, version Hitachi			1.322.068					
All engines	01/01/97 ->, version Hitachi			1.322.076					
All engines	version Hitachi				1.422.095				
All engines							1.970.214	C10	1.501.711
All engines	->year 31/12/96							1.965.052	

A10 CONDENSER	A20 CONTACT SET	A40 DISTRIBUTOR CAP	A50 ROTOR	A70 PICK-UP
C10 COIL	C20 IGNITION MODULE	C30 ELECTRONIC IGNITION KIT	E01 IGNITION CABLE SET	

Vehicle	alim.	kW	Date	Engine	FUNCTIONS ON THE VEHICLE							
					A10	A20	A40	A50	A70	C10 - C30	C20	E01
ENGINE												
2.2 i ES	Petrol	110	09/93-02/98	F22B5								
Engine	Information			A10	A20	A40	A50	A70	C10 - C30	C20	E01	
All engines	->year 31/12/96, version Hitachi					1.322.068						
All engines	01/01/97 ->, version Hitachi					1.322.076						
All engines	version Hitachi						1.422.095					
All engines								1.970.214	C10		1.501.711	
All engines	->year 31/12/96									1.965.052		
ENGINE												
2.2 i VTEC	Petrol	110	02/96-10/98	F22Z2								
Engine	Information			A10	A20	A40	A50	A70	C10 - C30	C20	E01	
All engines	version Hitachi					1.322.082	1.422.098					
All engines								1.970.347	C10			
ENGINE												
2.3 i SR	Petrol	116	03/93-01/96	H23A3								
Engine	Information			A10	A20	A40	A50	A70	C10 - C30	C20	E01	
All engines	version Hitachi					1.322.068	1.422.095					
All engines								1.970.214	C10			
ACCORD VI												
ENGINE												
1.6	Petrol	65	10/98-12/02	A16A5								
Engine	Information			A10	A20	A40	A50	A70	C10 - C30	C20	E01	
All engines	version Hitachi					1.322.022	1.422.056					
ENGINE												
1.6	Petrol	85	12/99-12/02	D16B6								
Engine	Information			A10	A20	A40	A50	A70	C10 - C30	C20	E01	
All engines	->year 01/12/99, x 1, D.I.S.								1.970.168	C10		
ENGINE												
1.6 i	Petrol	85	10/98-12/02	D16B6								
Engine	Information			A10	A20	A40	A50	A70	C10 - C30	C20	E01	
All engines	->year 01/12/99, x 1, D.I.S.								1.970.168	C10		
ENGINE												
1.6 LS	Petrol	79	10/98-12/02	D16B7								
Engine	Information			A10	A20	A40	A50	A70	C10 - C30	C20	E01	
All engines	->year 01/12/99, x 1, D.I.S.								1.970.168	C10		
ENGINE												
1.8 16V Vtec	Petrol	100	04/99->	3B630WM, F18B3								
Engine	Information			A10	A20	A40	A50	A70	C10 - C30	C20	E01	
All engines	version Hitachi						1.422.098					
All engines								1.970.347	C10			
ENGINE												
1.8 i	Petrol	100	10/98-12/02	3B630WM, F18B2, F18B4								
Engine	Information			A10	A20	A40	A50	A70	C10 - C30	C20	E01	
Eng. 3B630WM	version Hitachi						1.422.098					
Eng. F18B2, F18B4	x 1, HITACHI, LUCAS, x 1, DISTRIBUTOR, HITACHI, LUCAS, DISTRIBUTOR								1.970.347	C10		
ENGINE												
1.8 i 16V Vtec	Petrol	100	11/98-12/99	F18B4								
Engine	Information			A10	A20	A40	A50	A70	C10 - C30	C20	E01	
All engines	version Hitachi						1.422.098					
All engines								1.970.347	C10			
ENGINE												
2.0	Petrol	107	11/99-10/02	F20B7								
Engine	Information			A10	A20	A40	A50	A70	C10 - C30	C20	E01	
All engines	version Hitachi						1.422.098					
All engines	x 1, DISTRIBUTOR								1.970.347	C10		
ENGINE												
2.0	Petrol	108	12/99-12/02	F20B6								
Engine	Information			A10	A20	A40	A50	A70	C10 - C30	C20	E01	
All engines	version Hitachi						1.422.098					
All engines	x 1, HITACHI, LUCAS, DISTRIBUTOR								1.970.347	C10		

A10 CONDENSER	A20 CONTACT SET	A40 DISTRIBUTOR CAP	A50 ROTOR	A70 PICK-UP
C10 COIL	C20 IGNITION MODULE	C30 ELECTRONIC IGNITION KIT	E01 IGNITION CABLE SET	

The present application list is a brief version. For the detailed information about the possibility of installation on a specific vehicle, please refer to our web-catalogue <http://catalogo.facet.eu/>

				FUNCTIONS ON THE VEHICLE								
Vehicle	alim.	kW	Date	Engine								
				ENGINE								
2.0 16V Vtec	Petrol	108	04/99->	F20B6								
Engine	Information				A10	A20	A40	A50	A70	C10 - C30	C20	E01
All engines	version Hitachi							1.422.098				
All engines										1.970.347	C10	
				ENGINE								
2.0 i	Petrol	108	10/98-01/01	F20B6								
Engine	Information				A10	A20	A40	A50	A70	C10 - C30	C20	E01
All engines	version Hitachi							1.422.098				
All engines	x 1, HITACHI, LUCAS, DISTRIBUTOR									1.970.347	C10	
				ENGINE								
2.0 i 16V	Petrol	108	02/98-06/03	F20B5, F20B7								
Engine	Information				A10	A20	A40	A50	A70	C10 - C30	C20	E01
All engines	version Hitachi							1.422.098				
All engines	x 1, DISTRIBUTOR									1.970.347	C10	
				ENGINE								
2.2 Type-R	Petrol	156	02/99-12/02	H22A7								
Engine	Information				A10	A20	A40	A50	A70	C10 - C30	C20	E01
All engines	version Hitachi						1.322.068	1.422.095				
All engines	x 1, TEC, DISTRIBUTOR									1.970.214	C10	
				ENGINE								
2.3	Petrol	113	11/00-06/03	F23Z5								
Engine	Information				A10	A20	A40	A50	A70	C10 - C30	C20	E01
All engines	version Hitachi							1.422.098				
All engines	x 1, HITACHI, LUCAS, DISTRIBUTOR									1.970.347	C10	
				ENGINE								
2.3 i 16V Vtec	Petrol	113	11/00->	F23Z5								
Engine	Information				A10	A20	A40	A50	A70	C10 - C30	C20	E01
All engines	version Hitachi							1.422.098				
All engines										1.970.347	C10	
				ENGINE								
2.3 VTi	Petrol	113	02/98-10/02	F23A3								
Engine	Information				A10	A20	A40	A50	A70	C10 - C30	C20	E01
All engines	version Hitachi							1.422.098				
All engines										1.970.347	C10	
				ENGINE								
3.0 V6 24V	Petrol	147	02/98-06/03	J30A1								
Engine	Information				A10	A20	A40	A50	A70	C10 - C30	C20	E01
All engines	01/01/01->, x 1, DISTRIBUTOR									1.970.457	C10	
				ENGINE								
3.0 Vtec	Petrol	147	03/97-12/03	J30A1								
Engine	Information				A10	A20	A40	A50	A70	C10 - C30	C20	E01
All engines	01/01/01->, Qty: 6									1.970.457	C10	
				ENGINE								
3.0 Vtec	Petrol	152	10/01-06/03	J30A2								
Engine	Information				A10	A20	A40	A50	A70	C10 - C30	C20	E01
All engines	Qty: 6									1.970.457	C10	
				ENGINE								
				ENGINE								
				ENGINE								
2.0 i	Petrol	115	06/08-06/15	R20A3								
Engine	Information				A10	A20	A40	A50	A70	C10 - C30	C20	E01
All engines	x 4, COIL ON PLUG									1.970.522	C10	
				ENGINE								
				ENGINE								
				ENGINE								
1.6i	Petrol	118	01/97-02/01	B16A6								
Engine	Information				A10	A20	A40	A50	A70	C10 - C30	C20	E01
All engines	version Hitachi						1.322.068	1.422.095				
All engines										1.970.214	C10	

A10 CONDENSER	A20 CONTACT SET	A40 DISTRIBUTOR CAP	A50 ROTOR	A70 PICK-UP
C10 COIL	C20 IGNITION MODULE	C30 ELECTRONIC IGNITION KIT	E01 IGNITION CABLE SET	

Vehicle	alim.	kW	Date	Engine	FUNCTIONS ON THE VEHICLE									
					A10	A20	A40	A50	A70	C10 - C30	C20	E01		
ENGINE														
1.6i	Petrol	89	01/96-02/01	D16Y9										
Engine	Information				A10	A20	A40	A50	A70	C10 - C30	C20	E01		
All engines	version Hitachi						1.322.093	1.422.102						
All engines													1.501.702	
ENGINE														
1.8 i	Petrol	103	01/96-02/01	B18B4										
Engine	Information				A10	A20	A40	A50	A70	C10 - C30	C20	E01		
All engines	version Hitachi						1.322.068	1.422.095						
All engines										1.970.214	C10		1.501.709	
CITY														
ENGINE														
1.2	Petrol	58	05/03-09/05	L12A2										
Engine	Information				A10	A20	A40	A50	A70	C10 - C30	C20	E01		
All engines	Qty: 4									1.970.529, 1.970.608	C10			
ENGINE														
1.3	Petrol	60	10/05-07/08	L13A3										
Engine	Information				A10	A20	A40	A50	A70	C10 - C30	C20	E01		
All engines	Qty: 4, version A									1.970.529	C10			
All engines	Qty: 4, version B									1.970.608	C10			
ENGINE														
1.4 i-VTEC	Petrol	73	09/08->	L13Z1										
Engine	Information				A10	A20	A40	A50	A70	C10 - C30	C20	E01		
All engines	x 4, COIL ON PLUG									1.970.603	C10			
ENGINE														
1.5 i i-DSI	Petrol	66	11/02->	L15A2										
Engine	Information				A10	A20	A40	A50	A70	C10 - C30	C20	E01		
All engines	Qty: 4, version A									1.970.529	C10			
All engines	Qty: 4, version B									1.970.608	C10			
ENGINE														
1.5 i-VTEC	Petrol	85	08/09->	L15-A7										
Engine	Information				A10	A20	A40	A50	A70	C10 - C30	C20	E01		
All engines	Qty: 4									1.970.603	C10			
CIVIC III														
ENGINE														
1.5 i Si [USA]	Petrol	0	01/84-12/87	--										
Engine	Information				A10	A20	A40	A50	A70	C10 - C30	C20	E01		
All engines	version Hitachi						1.322.022	1.422.056						
All engines										1.970.212	C10			
CIVIC IV														
ENGINE														
1.2	Petrol	41	01/88-12/91	D12B1										
Engine	Information				A10	A20	A40	A50	A70	C10 - C30	C20	E01		
All engines	version Hitachi						1.322.071	1.422.081						
All engines										1.970.216	C10			
ENGINE														
1.3	Petrol	55	10/87-12/89	D13B1										
Engine	Information				A10	A20	A40	A50	A70	C10 - C30	C20	E01		
All engines	version Hitachi						1.322.071	1.422.081						
All engines										1.970.216	C10			
ENGINE														
1.3 16V Cat	Petrol	55	09/89-09/91	D13B2										
Engine	Information				A10	A20	A40	A50	A70	C10 - C30	C20	E01		
All engines	version Hitachi						1.322.071	1.422.081						
All engines										1.970.216	C10			
ENGINE														
1.4 L	Petrol	66	10/87-12/89	D14A1										
Engine	Information				A10	A20	A40	A50	A70	C10 - C30	C20	E01		
All engines	version Hitachi						1.322.071	1.422.081						
All engines										1.970.216	C10			

A10	CONDENSER	A20	CONTACT SET	A40	DISTRIBUTOR CAP	A50	ROTOR	A70	PICK-UP
C10	COIL	C20	IGNITION MODULE	C30	ELECTRONIC IGNITION KIT	E01	IGNITION CABLE SET		

The present application list is a brief version. For the detailed information about the possibility of installation on a specific vehicle, please refer to our web-catalogue <http://catalogo.facet.eu/>







				FUNCTIONS ON THE VEHICLE								
Vehicle	alim.	kW	Date	Engine	 A10	 A20	 A40	 A50	 A70	 C10 - C30	 C20	 E01
				ENGINE								
1.4i 16V	Petrol	66	01/90-12/91	D14A1								
Engine	Information											
All engines	version Hitachi					1.322.071	1.422.081					
All engines										1.970.216	C10	
				ENGINE								
1.5	Petrol	60	01/88-12/89	D15B1								
Engine	Information											
All engines	->eng. 4700494, version Hitachi						1.422.082					
All engines										1.970.215	C10	1.965.052
				ENGINE								
1.5i 16V	Petrol	66	10/87-09/91	D15B2								
Engine	Information											
All engines	version Hitachi					1.322.069						
All engines	->eng. 4700494, version Hitachi						1.422.082					
All engines	->year 31/12/89									1.970.213	C10	
All engines	01/01/90 ->									1.970.215	C10	
All engines												1.965.052
				ENGINE								
1.5i 16V	Petrol	69	10/87-09/91	D15B2								
Engine	Information											
All engines	version Hitachi					1.322.069						
All engines	->eng. 4700494, version Hitachi						1.422.082					
All engines	->year 31/12/89									1.970.213	C10	
All engines	01/01/90 ->									1.970.215	C10	
All engines												1.965.052
				ENGINE								
1.6 16V 4x4	Petrol	79	11/87-09/91	D16A6								
Engine	Information											
All engines	version Hitachi						1.422.082					
All engines	->year 31/12/89									1.970.213	C10	
All engines	01/01/90 ->									1.970.216	C10	
All engines												1.965.052
				ENGINE								
1.6i 16V	Petrol	80	10/87-09/91	D16A6								
Engine	Information											
All engines	->eng. 1600956, version Hitachi						1.422.082					
All engines	->year 31/12/89									1.970.213	C10	
All engines	01/01/90 ->									1.970.216	C10	
All engines												1.965.052
				ENGINE								
1.6i 16V	Petrol	81	10/87-09/91	D16Z2								
Engine	Information											
All engines	->eng. 1600956, version Hitachi						1.422.082					
All engines										1.970.215	C10	1.965.052
				ENGINE								
1.6i 16V	Petrol	96	09/87-09/91	D16A9								
Engine	Information											
All engines	->eng. 1600956, version Hitachi						1.422.082					
All engines										1.970.213	C10	1.965.052
				ENGINE								
1.6i 16V 4x4	Petrol	80	10/89-09/91	D16A6								
Engine	Information											
All engines	version Hitachi						1.422.082					
All engines	->year 31/12/89									1.970.213	C10	
All engines	01/01/90 ->									1.970.216	C10	
All engines												1.965.052
				ENGINE								
1.6i 16V 4x4	Petrol	81	01/89-12/91	D16Z2								
Engine	Information											
All engines	->eng. 1600956, version Hitachi						1.422.082					
All engines										1.970.215	C10	1.965.052

A10	CONDENSER	A20	CONTACT SET	A40	DISTRIBUTOR CAP	A50	ROTOR	A70	PICK-UP
C10	COIL	C20	IGNITION MODULE	C30	ELECTRONIC IGNITION KIT	E01	IGNITION CABLE SET		

Vehicle	alim.	kW	Date	Engine	FUNCTIONS ON THE VEHICLE							
					A10	A20	A40	A50	A70	C10 - C30	C20	E01
ENGINE												
1.6i	Petrol	0	01/90-12/91	--								
Engine	Information			A10	A20	A40	A50	A70	C10 - C30	C20	E01	
All engines	01/01/92 ->, version Hitachi					1.322.068	1.422.095					
All engines	->year 31/12/91, version Hitachi					1.322.069	1.422.097R					
All engines	01/01/92 ->								1.970.214	C10		
All engines	->year 31/12/91								1.970.215	C10		
All engines										1.965.052		
ENGINE												
1.6i 16V	Petrol	118	01/88-12/91	D16A1								
Engine	Information			A10	A20	A40	A50	A70	C10 - C30	C20	E01	
All engines									1.970.215	C10	1.965.052	
ENGINE												
1.6i 16V	Petrol	79	01/90-05/92	D16A7								
Engine	Information			A10	A20	A40	A50	A70	C10 - C30	C20	E01	
All engines	version Hitachi, no specific info conc. application available						1.422.082					
All engines									1.970.213	C10	1.965.052	
ENGINE												
1.6i 16V	Petrol	91	01/88-05/92	D16A8, D16A9								
Engine	Information			A10	A20	A40	A50	A70	C10 - C30	C20	E01	
All engines	->eng. 1600956, version Hitachi, no specific info conc. application available						1.422.082					
All engines									1.970.213	C10	1.965.052	
ENGINE												
1.6i 16V 4WD	Petrol	118	01/88-12/89	D16A1								
Engine	Information			A10	A20	A40	A50	A70	C10 - C30	C20	E01	
All engines	version Hitachi						1.422.082					
All engines	->year 31/12/89								1.970.213	C10		
All engines	01/01/90 ->								1.970.216	C10		
All engines											1.965.052	
ENGINE												
1.6i 16V 4WD	Petrol	81	01/89-12/91	D16Z2								
Engine	Information			A10	A20	A40	A50	A70	C10 - C30	C20	E01	
All engines	version Hitachi						1.422.082					
All engines	->year 31/12/89								1.970.213	C10		
All engines	01/01/90 ->								1.970.216	C10		
All engines											1.965.052	
CIVIC IV SHUTTLE												
ENGINE												
1.4i 16V	Petrol	66	01/88-12/92	D14A1								
Engine	Information			A10	A20	A40	A50	A70	C10 - C30	C20	E01	
All engines	version Hitachi					1.322.071	1.422.081					
All engines									1.970.216	C10		
ENGINE												
1.5i 16V	Petrol	69	01/88-11/91	D15B2								
Engine	Information			A10	A20	A40	A50	A70	C10 - C30	C20	E01	
All engines	version Hitachi					1.322.069						
All engines	->eng. 4708638, version Hitachi						1.422.082					
All engines	->year 31/12/89								1.970.213	C10		
All engines	01/01/90 ->								1.970.215	C10		
All engines											1.965.052	
ENGINE												
1.6 4x4	Petrol	85	01/88-12/92	D16A, D16A7								
Engine	Information			A10	A20	A40	A50	A70	C10 - C30	C20	E01	
All engines	version Hitachi						1.422.082					
All engines									1.970.213	C10	1.965.052	
ENGINE												
1.6i 16V 4WD	Petrol	80	01/88-12/89	D16A6								
Engine	Information			A10	A20	A40	A50	A70	C10 - C30	C20	E01	
All engines	version Hitachi						1.422.082					
All engines	->year 31/12/89								1.970.213	C10		
All engines	01/01/90 ->								1.970.216	C10		

A10 CONDENSER	A20 CONTACT SET	A40 DISTRIBUTOR CAP	A50 ROTOR	A70 PICK-UP
C10 COIL	C20 IGNITION MODULE	C30 ELECTRONIC IGNITION KIT	E01 IGNITION CABLE SET	

The present application list is a brief version. For the detailed information about the possibility of installation on a specific vehicle, please refer to our web-catalogue <http://catalogo.facet.eu/>

				FUNCTIONS ON THE VEHICLE								
Vehicle	alim.	kW	Date	Engine	 A10	 A20	 A40	 A50	 A70	 C10 - C30	 C20	 E01
				ENGINE								
1.6 i 16V 4WD	Petrol	80	01/88-12/89	D16A6								
				ENGINE								
				ENGINE								
1.6 i 16V 4WD	Petrol	81	01/88-02/95	D16A6								
				ENGINE								
				ENGINE								
1.6i	Petrol	0	01/88-12/91	--								
				ENGINE								
				ENGINE								
1.6i 16V 4WD	Petrol	81	01/88-12/92	D16Z2								
				ENGINE								
				ENGINE								
				ENGINE								
1.4 i-VTEC	Petrol	73	02/12->	L13Z4								
				ENGINE								
				ENGINE								
				ENGINE								
1.3	Petrol	55	01/92-12/92	D13B2								
				ENGINE								
				ENGINE								
1.3 16V	Petrol	55	10/91-11/95	D13B2								
				ENGINE								
				ENGINE								
1.5	Petrol	61	01/92-12/92	D15B2								
				ENGINE								
				ENGINE								
1.5	Petrol	69	08/93-12/95	D15B7								
				ENGINE								
				ENGINE								
1.5 i 16V	Petrol	66	10/91-11/95	D15B2								
				ENGINE								
				ENGINE								
1.5 i 16V	Petrol	69	10/91-11/95	D15B2, D15Z1								
				ENGINE								
				ENGINE								

A10 CONDENSER	A20 CONTACT SET	A40 DISTRIBUTOR CAP	A50 ROTOR	A70 PICK-UP
C10 COIL	C20 IGNITION MODULE	C30 ELECTRONIC IGNITION KIT	E01 IGNITION CABLE SET	

Vehicle	alim.	kW	Date	Engine	FUNCTIONS ON THE VEHICLE							
					A10	A20	A40	A50	A70	C10 - C30	C20	E01

				ENGINE
1.5 i LSi	Petrol	74	08/93-11/95	D15B7

Engine	Information	A10	A20	A40	A50	A70	C10 - C30	C20	E01
All engines	version Hitachi			1.322.068	1.422.095				
All engines							1.970.214	C10	

				ENGINE
1.6 16V Vtec	Petrol	92	10/91-11/95	D16Z6, D16Z7

Engine	Information	A10	A20	A40	A50	A70	C10 - C30	C20	E01
All engines	version Hitachi			1.322.068	1.422.095				
All engines							1.970.214	C10	
All engines	->year 31/12/93							1.965.052	

				ENGINE
1.6 4x4	Petrol	92	01/92-10/95	D16Z7

Engine	Information	A10	A20	A40	A50	A70	C10 - C30	C20	E01
All engines	version Hitachi			1.322.068	1.422.095				
All engines							1.970.214	C10	
All engines	->year 31/12/93							1.965.052	

				ENGINE
1.6 EX	Petrol	88	08/93-10/95	D16A7

Engine	Information	A10	A20	A40	A50	A70	C10 - C30	C20	E01
All engines	version Hitachi			1.322.068	1.422.095				
All engines							1.970.214	C10	

				ENGINE
1.6 i	Petrol	77	01/94-11/95	D16Y7

Engine	Information	A10	A20	A40	A50	A70	C10 - C30	C20	E01
All engines	version Hitachi			1.322.068	1.422.095				
All engines							1.970.214	C10	1.501.702

				ENGINE
1.6 i Vtec	Petrol	118	01/94-11/95	B16A2

Engine	Information	A10	A20	A40	A50	A70	C10 - C30	C20	E01
All engines	version Hitachi			1.322.068	1.422.095				
All engines							1.970.214	C10	
All engines	->eng. 1109264							1.965.052	

				ENGINE
1.6 i Vtec	Petrol	92	01/94-03/96	D16Y6, D16Z9

Engine	Information	A10	A20	A40	A50	A70	C10 - C30	C20	E01
Eng. D16Z9	version Hitachi			1.322.068	1.422.095				
Eng. D16Y6	version Hitachi			1.322.082	1.422.098				
Eng. D16Z9							1.970.214	C10	
Eng. D16Y6							1.970.347	C10	1.501.702

				ENGINE
1.6 VTi	Petrol	118	10/91-11/95	B16A2

Engine	Information	A10	A20	A40	A50	A70	C10 - C30	C20	E01
All engines	version Hitachi			1.322.068	1.422.095				
All engines							1.970.214	C10	
All engines	->eng. 1109264							1.965.052	

				ENGINE
1.6 VTi 16V	Petrol	118	10/91-11/95	B16A2

Engine	Information	A10	A20	A40	A50	A70	C10 - C30	C20	E01
All engines	version Hitachi			1.322.068	1.422.095				
All engines							1.970.214	C10	
All engines	->eng. 1109264							1.965.052	

CIVIC VI

				ENGINE
1.4	Petrol	55	11/95-10/98	D14A4









Engine	Information	A10	A20	A40	A50	A70	C10 - C30	C20	E01
All engines	version Hitachi			1.322.093	1.422.102				
All engines									1.501.702

				ENGINE
1.4 16V	Petrol	55	01/97-02/01	D14A7, D14Z3

Engine	Information	A10	A20	A40	A50	A70	C10 - C30	C20	E01
Eng. D14A7	version Hitachi			1.328.106	1.422.102				

A10 CONDENSER	A20 CONTACT SET	A40 DISTRIBUTOR CAP	A50 ROTOR	A70 PICK-UP
C10 COIL	C20 IGNITION MODULE	C30 ELECTRONIC IGNITION KIT	E01 IGNITION CABLE SET	

FUNCTIONS ON THE VEHICLE

Vehicle	alim.	kW	Date	Engine								
ENGINE												
1.4 16V	Petrol	55	01/97-02/01	D14A7, D14Z3								
Engine	Information			A10	A20	A40	A50	A70	C10 - C30		C20	E01
All engines	x 1, HITACHI, DISTRIBUTOR									1.970.347	C10	
Eng. D14A7												1.501.686
ENGINE												
1.4 16V	Petrol	66	04/98-02/01	D14A8								
Engine	Information			A10	A20	A40	A50	A70	C10 - C30		C20	E01
All engines	version Hitachi					1.328.106	1.422.102					
All engines												1.501.686
ENGINE												
1.4 i	Petrol	55	09/95-02/01	D14A3, D14A5, D14A7, D14Z1, D14Z3								
Engine	Information			A10	A20	A40	A50	A70	C10 - C30		C20	E01
Eng. D14A5	->year 31/12/95, version Hitachi					1.322.068	1.422.095					
Eng. D14A5	01/01/96->, version Hitachi					1.322.082	1.422.098					
Eng. D14A3, D14Z1	version Hitachi					1.322.093	1.422.102					
Eng. D14A3, D14Z1	x 1, TEC, DISTRIBUTOR									1.970.214	C10	
All engines	x 1, HITACHI, DISTRIBUTOR									1.970.347	C10	
Eng. D14A3, D14Z1												1.501.702
ENGINE												
1.4 i	Petrol	66	06/95-02/01	D14A2, D14A4, D14A8, D14Z2, D14Z4								
Engine	Information			A10	A20	A40	A50	A70	C10 - C30		C20	E01
Eng. D14A2, D14Z2	->year 31/12/95, version Hitachi					1.322.068	1.422.095					
Eng. D14A2	01/01/96->, version Hitachi					1.322.082	1.422.098					
Eng. D14A4	version Hitachi					1.322.093						
Eng. D14A8	version Hitachi					1.328.106						
Eng. D14A4, D14A8	version Hitachi						1.422.102					
Eng. D14A2, D14Z2, D14Z4	x 1, TEC, DISTRIBUTOR									1.970.214	C10	
Eng. D14Z2										1.970.214	C10	
Eng. D14Z4	x 1, HITACHI, DISTRIBUTOR									1.970.347	C10	
Eng. D14A8												1.501.686
Eng. D14A4, D14Z2												1.501.702
ENGINE												
1.4 i S	Petrol	66	11/95-02/01	D14A2, D14A4, D14Z2, D14Z4								
Engine	Information			A10	A20	A40	A50	A70	C10 - C30		C20	E01
Eng. D14Z2	version Hitachi					1.322.068	1.422.095					
Eng. D14A4	version Hitachi					1.322.093	1.422.102					
Eng. D14A2, D14Z2, D14Z4	x 1, TEC, DISTRIBUTOR									1.970.214	C10	
Eng. D14Z4	x 1, HITACHI, DISTRIBUTOR									1.970.347	C10	
Eng. D14A4, D14Z2												1.501.702
ENGINE												
1.4 LPG	Petrol/ Liquified Petro- leum Gas (LPG)	66	01/97-02/01	D14A4, D14Z4								
Engine	Information			A10	A20	A40	A50	A70	C10 - C30		C20	E01
All engines	x 1, HITACHI, DISTRIBUTOR									1.970.347	C10	
ENGINE												
1.4 i	Petrol	66	01/99->	D14A6								
Engine	Information			A10	A20	A40	A50	A70	C10 - C30		C20	E01
All engines	version Hitachi					1.328.106	1.422.102					
All engines												1.501.686
ENGINE												
1.4 i 16V	Petrol	55	11/98-03/01	D14Z1, D14Z3								
Engine	Information			A10	A20	A40	A50	A70	C10 - C30		C20	E01
Eng. D14Z1	version Hitachi					1.322.068	1.422.095					
Eng. D14Z3	version Hitachi					1.322.082	1.422.098					
Eng. D14Z1										1.970.214	C10	1.501.702
Eng. D14Z3										1.970.347	C10	1.501.686



A10	CONDENSER	A20	CONTACT SET	A40	DISTRIBUTOR CAP	A50	ROTOR	A70	PICK-UP
C10	COIL	C20	IGNITION MODULE	C30	ELECTRONIC IGNITION KIT	E01	IGNITION CABLE SET		

Vehicle	alim.	kW	Date	Engine	FUNCTIONS ON THE VEHICLE									
					A10	A20	A40	A50	A70	C10 - C30	C20	E01		
ENGINE														
1.4i 16V	Petrol	66	11/98-10/00	D14Z4										
Engine	Information				A10	A20	A40	A50	A70	C10 - C30	C20	E01		
All engines	version Hitachi						1.322.082	1.422.098						
All engines										1.970.347	C10		1.501.686	
ENGINE														
1.4i 16V Vtec	Petrol	66	01/99->	D14Z4										
Engine	Information				A10	A20	A40	A50	A70	C10 - C30	C20	E01		
All engines	version Hitachi						1.322.082	1.422.098						
All engines										1.970.347	C10		1.501.686	
ENGINE														
1.5	Petrol	66	11/95-12/96	D15Z3										
Engine	Information				A10	A20	A40	A50	A70	C10 - C30	C20	E01		
All engines	x 1, TEC, DISTRIBUTOR									1.970.214	C10			
ENGINE														
1.5 16V	Petrol	84	01/97-02/01	D15Z6, D15Z8										
Engine	Information				A10	A20	A40	A50	A70	C10 - C30	C20	E01		
Eng. D15Z8	version Hitachi						1.322.082	1.422.098						
All engines	x 1, TEC, DISTRIBUTOR									1.970.214	C10			
Eng. D15Z8	x 1, HITACHI, x 1, DISTRIBUTOR, HITACHI, DISTRIBUTOR									1.970.347	C10			
Eng. D15Z8													1.501.686	
ENGINE														
1.5 i	Petrol	84	11/95-02/01	D15Z6, D15Z8										
Engine	Information				A10	A20	A40	A50	A70	C10 - C30	C20	E01		
Eng. D15Z6	version Hitachi						1.322.068	1.422.095						
All engines	x 1, TEC, x 1, DISTRIBUTOR, TEC, DISTRIBUTOR									1.970.214	C10			
Eng. D15Z8	x 1, HITACHI, DISTRIBUTOR									1.970.347	C10			
Eng. D15Z6													1.501.702	
ENGINE														
1.5 i Vtec-E	Petrol	66	09/94-01/97	D15Z3										
Engine	Information				A10	A20	A40	A50	A70	C10 - C30	C20	E01		
All engines	version Hitachi						1.322.068	1.422.095						
All engines	x 1, TEC, DISTRIBUTOR									1.970.214	C10			
ENGINE														
1.6	Petrol	79	10/95-12/00	--, D16Y2										
Engine	Information				A10	A20	A40	A50	A70	C10 - C30	C20	E01		
Eng. --	version Hitachi						1.322.068	1.422.095						
Eng. --										1.970.214	C10		1.501.702	
Eng. D16Y2	x 1, TEC, DISTRIBUTOR									1.970.214	C10			
Eng. D16Y2	x 1, HITACHI, DISTRIBUTOR									1.970.347	C10			
ENGINE														
1.6	Petrol	92	11/98-03/01	D16W4										
Engine	Information				A10	A20	A40	A50	A70	C10 - C30	C20	E01		
All engines	version Hitachi						1.322.082	1.422.098						
All engines	x 1, HITACHI, DISTRIBUTOR									1.970.347	C10			
All engines													1.501.686	
ENGINE														
1.6	Petrol	93	10/95-03/01	D16Y2										
Engine	Information				A10	A20	A40	A50	A70	C10 - C30	C20	E01		
All engines	x 1, TEC, DISTRIBUTOR									1.970.214	C10			
ENGINE														
1.6 16V	Petrol	85	01/97-02/01	D16B2, D16W3										
Engine	Information				A10	A20	A40	A50	A70	C10 - C30	C20	E01		
Eng. D16B2	version Hitachi						1.328.106	1.422.102						
All engines	x 1, TEC, DISTRIBUTOR									1.970.214	C10			
All engines	x 1, HITACHI, DISTRIBUTOR									1.970.347	C10			
Eng. D16B2													1.501.686	
ENGINE														
1.6 16V	Petrol	92	04/98-02/01	D16W4										
Engine	Information				A10	A20	A40	A50	A70	C10 - C30	C20	E01		
All engines	x 1, HITACHI, DISTRIBUTOR									1.970.347	C10			

A10	CONDENSER	A20	CONTACT SET	A40	DISTRIBUTOR CAP	A50	ROTOR	A70	PICK-UP
C10	COIL	C20	IGNITION MODULE	C30	ELECTRONIC IGNITION KIT	E01	IGNITION CABLE SET		

The present application list is a brief version. For the detailed information about the possibility of installation on a specific vehicle, please refer to our web-catalogue <http://catalogo.facet.eu/>

FUNCTIONS ON THE VEHICLE









Vehicle	alim.	kW	Date	Engine	 A10	 A20	 A40	 A50	 A70	 C10 - C30	 C20	 E01
ENGINE												
1.6i	Petrol	77	03/96-03/00	D16Y7								
Engine	Information											
All engines	version Hitachi					1.322.068	1.422.095					
All engines	x 1, TEC, DISTRIBUTOR									1.970.214	C10	
All engines												1.501.702
ENGINE												
1.6i	Petrol	83	09/94-01/97	D16Y3								
Engine	Information											
All engines	->year 31/12/95, version Hitachi					1.322.068	1.422.095					
All engines	01/01/96 ->, version Hitachi					1.322.082	1.422.098					
All engines	x 1, TEC, DISTRIBUTOR									1.970.214	C10	
ENGINE												
1.6i	Petrol	84	11/95-02/01	D16Y5								
Engine	Information											
All engines	version Hitachi					1.322.082	1.422.098					
All engines	x 1, HITACHI, DISTRIBUTOR									1.970.347	C10	
All engines												1.501.702
ENGINE												
1.6i Vtec	Petrol	118	04/99-12/00	B16A2								
Engine	Information											
All engines	version Hitachi					1.322.068	1.422.095					
All engines	x 1, TEC, DISTRIBUTOR									1.970.214	C10	
ENGINE												
1.6i Vtec	Petrol	92	11/95-02/01	D16Y6, D16Y8								
Engine	Information											
Eng. D16Y8	version Hitachi					1.322.068	1.422.095					
Eng. D16Y6	version Hitachi					1.322.082	1.422.098					
Eng. D16Y8	x 1, TEC, DISTRIBUTOR									1.970.214	C10	
Eng. D16Y6										1.970.347	C10	
All engines												1.501.702
ENGINE												
1.6i Vtec	Petrol	93	09/94-01/97	D16Y2								
Engine	Information											
All engines	version Hitachi					1.322.068	1.422.095					
All engines										1.970.214	C10	
ENGINE												
1.6 VTi	Petrol	118	11/95-02/01	B16A2								
Engine	Information											
All engines	version Hitachi					1.322.068	1.422.095					
All engines	x 1, TEC, DISTRIBUTOR									1.970.214	C10	
All engines	->year 31/12/98											1.501.702
ENGINE												
1.6i 16V	Petrol	77	01/96->	D16Y7								
Engine	Information											
All engines	version Hitachi					1.322.068	1.422.095					
All engines										1.970.214	C10	1.501.702
ENGINE												
1.6i 16V	Petrol	85	11/98-12/00	D16W3								
Engine	Information											
All engines	version Hitachi					1.322.082	1.422.098					
All engines										1.970.347	C10	1.501.686
ENGINE												
1.6i 16V Vtec	Petrol	92	01/96-09/99	D16Y8								
Engine	Information											
All engines	version Hitachi					1.322.068	1.422.095					
All engines										1.970.214	C10	1.501.702
ENGINE												
1.8 16V	Petrol	124	01/97-02/01	B18C4								
Engine	Information											
All engines	x 1, TEC, DISTRIBUTOR									1.970.214	C10	
All engines	x 1, HITACHI, DISTRIBUTOR									1.970.347	C10	

A10 CONDENSER	A20 CONTACT SET	A40 DISTRIBUTOR CAP	A50 ROTOR	A70 PICK-UP
C10 COIL	C20 IGNITION MODULE	C30 ELECTRONIC IGNITION KIT	E01 IGNITION CABLE SET	

Vehicle	alim.	kW	Date	Engine	FUNCTIONS ON THE VEHICLE									
					A10	A20	A40	A50	A70	C10 - C30	C20	E01		
ENGINE														
1.8 i 16V Vtec	Petrol	124	01/97-12/98	D18C4										
Engine	Information				A10	A20	A40	A50	A70	C10 - C30	C20	E01		
All engines										1,970.214	C10			
CIVIC VII														
ENGINE														
1.3 IMA	Petrol/ Electric	61	10/03-09/05	LDA1										
Engine	Information				A10	A20	A40	A50	A70	C10 - C30	C20	E01		
All engines	FP: Front, x 4, COIL ON PLUG									1,970.529	C10			
All engines	FP: Rear, x 4, COIL ON PLUG									1,970.608	C10			
ENGINE														
1.4	Petrol	66	12/00-09/05	D14Z5										
Engine	Information				A10	A20	A40	A50	A70	C10 - C30	C20	E01		
All engines	x 4, COIL ON PLUG									1,970.457	C10			
ENGINE														
1.4 i	Petrol	55	02/01-09/05	D14Z6										
Engine	Information				A10	A20	A40	A50	A70	C10 - C30	C20	E01		
All engines	x 4, COIL ON PLUG									1,970.457	C10			
ENGINE														
1.4 iS	Petrol	66	02/01-09/05	D14Z5, D14Z6										
Engine	Information				A10	A20	A40	A50	A70	C10 - C30	C20	E01		
Eng. D14Z5	Qty: 4									1,970.457	C10			
Eng. D14Z6	x 4, COIL ON PLUG									1,970.457	C10			
ENGINE														
1.4i 16V	Petrol	66	02/01->	D14Z6										
Engine	Information				A10	A20	A40	A50	A70	C10 - C30	C20	E01		
All engines	Qty: 4									1,970.457	C10			
ENGINE														
1.5	Petrol	82	02/03-09/05	D15Y3										
Engine	Information				A10	A20	A40	A50	A70	C10 - C30	C20	E01		
All engines	x 4, COIL ON PLUG									1,970.457	C10			
ENGINE														
1.5 i 16V	Petrol	0	01/01->	D15Y2, D15Y3										
Engine	Information				A10	A20	A40	A50	A70	C10 - C30	C20	E01		
All engines	Qty: 4									1,970.457	C10			
ENGINE														
1.6	Petrol	81	02/01-09/05	D16V1, D16W7										
Engine	Information				A10	A20	A40	A50	A70	C10 - C30	C20	E01		
Eng. D16V1	Qty: 4									1,970.457	C10			
Eng. D16W7	x 4, COIL ON PLUG									1,970.457	C10			
ENGINE														
1.6 i	Petrol	81	02/01-12/05	D16V1, D16W7										
Engine	Information				A10	A20	A40	A50	A70	C10 - C30	C20	E01		
All engines	x 4, COIL ON PLUG									1,970.457	C10			
Eng. D16V1	Qty: 4									1,970.457	C10			
ENGINE														
1.6i 16V	Petrol	81	04/01->	D16W7										
Engine	Information				A10	A20	A40	A50	A70	C10 - C30	C20	E01		
All engines	Qty: 4									1,970.457	C10			
ENGINE														
1.6i 16V Vtec	Petrol	81	04/01->	D16V3										
Engine	Information				A10	A20	A40	A50	A70	C10 - C30	C20	E01		
All engines	Qty: 4									1,970.457	C10			
ENGINE														
1.7	Petrol	85	02/01-09/05	D17A6										
Engine	Information				A10	A20	A40	A50	A70	C10 - C30	C20	E01		
All engines	Qty: 4									1,970.457	C10			

A10	CONDENSER	A20	CONTACT SET	A40	DISTRIBUTOR CAP	A50	ROTOR	A70	PICK-UP
C10	COIL	C20	IGNITION MODULE	C30	ELECTRONIC IGNITION KIT	E01	IGNITION CABLE SET		

The present application list is a brief version. For the detailed information about the possibility of installation on a specific vehicle, please refer to our web-catalogue <http://catalogo.facet.eu/>

					FUNCTIONS ON THE VEHICLE							
Vehicle	alim.	kW	Date	Engine								
ENGINE												
1.7	Petrol	92	01/00-08/05	D17A6								
Engine		Information			A10	A20	A40	A50	A70	C10 - C30	C20	E01
All engines		Qty: 4								1.970.457	C10	
ENGINE												
1.7 i	Petrol	88	05/01-12/05	D17A8								
Engine		Information			A10	A20	A40	A50	A70	C10 - C30	C20	E01
All engines		x 4, COIL ON PLUG								1.970.457	C10	
ENGINE												
1.7 i 16V VTi	Petrol	0	11/01->	D17Z4								
Engine		Information			A10	A20	A40	A50	A70	C10 - C30	C20	E01
All engines		Qty: 4								1.970.457	C10	
ENGINE												
1.7 i 16V VTi	Petrol	92	02/01->	D17A5								
Engine		Information			A10	A20	A40	A50	A70	C10 - C30	C20	E01
All engines		Qty: 4								1.970.457	C10	
ENGINE												
1.7 i VTEC	Petrol	92	05/01-12/05	D17A5, D17A9								
Engine		Information			A10	A20	A40	A50	A70	C10 - C30	C20	E01
All engines		x 4, COIL ON PLUG								1.970.457	C10	
CIVIC VIII												
ENGINE												
1.3 IMA	Petrol/ Electric	70	01/06->	LDA2								
Engine		Information			A10	A20	A40	A50	A70	C10 - C30	C20	E01
All engines		FP: Front, x 4, COIL ON PLUG								1.970.529	C10	
All engines		FP: Rear, x 4, COIL ON PLUG								1.970.608	C10	
ENGINE												
1.3 IMA	Petrol/ Electric	85	01/10-02/12	LDA2								
Engine		Information			A10	A20	A40	A50	A70	C10 - C30	C20	E01
All engines		FP: Front, x 4, COIL ON PLUG								1.970.529	C10	
All engines		FP: Rear, x 4, COIL ON PLUG								1.970.608	C10	
ENGINE												
1.4	Petrol	61	09/05->	L13A7								
Engine		Information			A10	A20	A40	A50	A70	C10 - C30	C20	E01
All engines		FP: Front, x 4, COIL ON PLUG								1.970.529	C10	
All engines		FP: Rear, x 4, COIL ON PLUG								1.970.608	C10	
ENGINE												
1.4	Petrol	73	10/08->	L13Z1								
Engine		Information			A10	A20	A40	A50	A70	C10 - C30	C20	E01
All engines		x 4, COIL ON PLUG								1.970.603	C10	
ENGINE												
1.6	Petrol	84	09/05->	R16A1, R16A2								
Engine		Information			A10	A20	A40	A50	A70	C10 - C30	C20	E01
Eng. R16A1		Qty: 4								1.970.522	C10	
Eng. R16A2		x 4, COIL ON PLUG								1.970.522	C10	
ENGINE												
1.6	Petrol	92	09/05->	R16A1								
Engine		Information			A10	A20	A40	A50	A70	C10 - C30	C20	E01
All engines		x 4, COIL ON PLUG								1.970.522	C10	
ENGINE												
1.8	Petrol	103	09/05->	R18A1, R18A2								
Engine		Information			A10	A20	A40	A50	A70	C10 - C30	C20	E01
All engines		x 4, COIL ON PLUG								1.970.522	C10	
Eng. R18A2		Qty: 4								1.970.522	C10	
ENGINE												
1.8 EXS Flex	Petrol/ Ethanol	103	11/06->	R18A1								
Engine		Information			A10	A20	A40	A50	A70	C10 - C30	C20	E01
All engines		x 4, COIL ON PLUG								1.970.522	C10	

A10 CONDENSER	A20 CONTACT SET	A40 DISTRIBUTOR CAP	A50 ROTOR	A70 PICK-UP
C10 COIL	C20 IGNITION MODULE	C30 ELECTRONIC IGNITION KIT	E01 IGNITION CABLE SET	

Vehicle	alim.	kW	Date	Engine	FUNCTIONS ON THE VEHICLE							
					A10	A20	A40	A50	A70	C10 - C30	C20	E01
CONCERTO												
1.4	Petrol	61	10/89-10/92	D14A1								
ENGINE												
Engine	Information			A10	A20	A40	A50	A70	C10 - C30	C20	E01	
All engines	version Hitachi					1.322.071	1.422.081					
All engines								1.970.216	C10			
1.4	Petrol	66	08/89-10/91	D14A1								
ENGINE												
Engine	Information			A10	A20	A40	A50	A70	C10 - C30	C20	E01	
All engines	version Hitachi					1.322.071	1.422.081					
All engines								1.970.216	C10			
1.5 i	Petrol	0	01/90-12/91	--								
ENGINE												
Engine	Information			A10	A20	A40	A50	A70	C10 - C30	C20	E01	
All engines	version Hitachi					1.322.069	1.422.082					
All engines								1.970.215	C10			
1.5 i 16V	Petrol	66	08/89-05/95	D15B2								
ENGINE												
Engine	Information			A10	A20	A40	A50	A70	C10 - C30	C20	E01	
All engines									1.970.215	C10	1.965.052	
1.6 16V	Petrol	78	08/89-03/95	D16Z2								
ENGINE												
Engine	Information			A10	A20	A40	A50	A70	C10 - C30	C20	E01	
All engines									1.970.213	C10	1.965.052	
1.6 i 16V	Petrol	82	08/89-03/95	D16Z2								
ENGINE												
Engine	Information			A10	A20	A40	A50	A70	C10 - C30	C20	E01	
All engines									1.970.213	C10	1.965.052	
1.6 i 16V	Petrol	90	08/89-03/95	D16A8								
ENGINE												
Engine	Information			A10	A20	A40	A50	A70	C10 - C30	C20	E01	
All engines									1.970.213	C10	1.965.052	
1.6i	Petrol	88	01/90-12/91	D16A								
ENGINE												
Engine	Information			A10	A20	A40	A50	A70	C10 - C30	C20	E01	
All engines	version Hitachi					1.322.071	1.422.081					
All engines								1.970.216	C10			
1.6i DOHC	Petrol	0	01/90-12/91	--								
ENGINE												
Engine	Information			A10	A20	A40	A50	A70	C10 - C30	C20	E01	
All engines	version Hitachi					1.322.069	1.422.082					
All engines								1.970.213	C10	1.965.052		
1.6i SOHC	Petrol	0	01/90-12/91	--								
ENGINE												
Engine	Information			A10	A20	A40	A50	A70	C10 - C30	C20	E01	
All engines	version Hitachi					1.322.069	1.422.082					
All engines								1.970.213	C10			
CR-V I												
2.0	Petrol	98	04/99-02/02	B20Z1								
ENGINE												
Engine	Information			A10	A20	A40	A50	A70	C10 - C30	C20	E01	
All engines	version Hitachi					1.322.068	1.422.095					
All engines								1.970.214	C10		1.501.709	
2.0 16V 4WD	Petrol	108	01/99-02/02	B20Z1, B20Z3								
ENGINE												
Engine	Information			A10	A20	A40	A50	A70	C10 - C30	C20	E01	
Eng. B20Z1	version Hitachi					1.322.068	1.422.095					
All engines	x 1, TEC, DISTRIBUTOR								1.970.214	C10		
Eng. B20Z1											1.501.709	

A10	CONDENSER	A20	CONTACT SET	A40	DISTRIBUTOR CAP	A50	ROTOR	A70	PICK-UP
C10	COIL	C20	IGNITION MODULE	C30	ELECTRONIC IGNITION KIT	E01	IGNITION CABLE SET		

The present application list is a brief version. For the detailed information about the possibility of installation on a specific vehicle, please refer to our web-catalogue <http://catalogo.facet.eu/>

Vehicle	alim.	kW	Date	Engine	FUNCTIONS ON THE VEHICLE							
					A10	A20	A40	A50	A70	C10 - C30	C20	E01

ENGINE				
2.0 16V 4WD	Petrol	94	10/95-12/01	B20B, B20B3, B20B9

Engine	Information	A10	A20	A40	A50	A70	C10 - C30	C20	E01
Eng. B20B	version Hitachi			1.322.068	1.422.095				
Eng. B20B							1.970.214	C10	1.501.709
Eng. B20B3, B20B9	x 1, TEC, DISTRIBUTOR						1.970.214	C10	

ENGINE				
2.0i 16V	Petrol	108	02/97-02/02	B20B3, B20Z3

Engine	Information	A10	A20	A40	A50	A70	C10 - C30	C20	E01
All engines	version Hitachi			1.322.068	1.422.095				
All engines							1.970.214	C10	1.501.709

ENGINE				
2.0i 16V	Petrol	94	02/98-04/99	B20B4

Engine	Information	A10	A20	A40	A50	A70	C10 - C30	C20	E01
All engines	version Hitachi			1.322.068	1.422.095				
All engines							1.970.214	C10	1.501.709

ENGINE				
2.0i 16V	Petrol	98	04/99-02/02	B20B9

Engine	Information	A10	A20	A40	A50	A70	C10 - C30	C20	E01
All engines	version Hitachi			1.322.068	1.422.095				
All engines							1.970.214	C10	1.501.709

ENGINE				
2.0	Petrol	110	06/04->	R20A1

Engine	Information	A10	A20	A40	A50	A70	C10 - C30	C20	E01
All engines	Qty: 4						1.970.522	C10	

ENGINE				
2.0i	Petrol	110	01/07->	R20A2

Engine	Information	A10	A20	A40	A50	A70	C10 - C30	C20	E01
All engines	Qty: 4						1.970.522	C10	

ENGINE				
2.0i-VTEC	Petrol	110	01/07-06/12	R20A2

Engine	Information	A10	A20	A40	A50	A70	C10 - C30	C20	E01
All engines	x 4, COIL ON PLUG						1.970.522	C10	

ENGINE				
2.0i-VTEC 4WD	Petrol	110	10/06-06/12	R20A2

Engine	Information	A10	A20	A40	A50	A70	C10 - C30	C20	E01
All engines	x 4, COIL ON PLUG						1.970.522	C10	

ENGINE				
2.0	Petrol	110	01/12->	R20A9

Engine	Information	A10	A20	A40	A50	A70	C10 - C30	C20	E01
All engines	->year 01/12/12, x 4, COIL ON PLUG						1.970.522	C10	

ENGINE				
1.6i 16V	Petrol	91	10/87-02/92	D16Z5

Engine	Information	A10	A20	A40	A50	A70	C10 - C30	C20	E01
All engines	->eng. 1401684, version Hitachi				1.422.082				
All engines							1.970.213	C10	1.965.052

ENGINE				
1.6i 16V	Petrol	96	10/87-12/89	D16A9

Engine	Information	A10	A20	A40	A50	A70	C10 - C30	C20	E01
All engines	->eng. 1401684, version Hitachi				1.422.082				
All engines							1.970.213	C10	1.965.052

ENGINE				
1.6i 16V Vtec	Petrol	110	10/89-02/92	B16A1

Engine	Information	A10	A20	A40	A50	A70	C10 - C30	C20	E01
All engines							1.970.215	C10	1.965.052

A10	CONDENSER	A20	CONTACT SET	A40	DISTRIBUTOR CAP	A50	ROTOR	A70	PICK-UP
C10	COIL	C20	IGNITION MODULE	C30	ELECTRONIC IGNITION KIT	E01	IGNITION CABLE SET		

Vehicle	alim.	kW	Date	Engine	FUNCTIONS ON THE VEHICLE							
					A10	A20	A40	A50	A70	C10 - C30	C20	E01
CRX III												
1.6 ESi	Petrol	92	03/92-12/98	D16Y8, D16Z6								
Engine	Information			A10	A20	A40	A50	A70	C10 - C30	C20	E01	
All engines	version Hitachi					1.322.068	1.422.095					
All engines								1.970.214	C10			
All engines	->year 31/12/93									1.965.052		
1.6 i Vti												
Engine	Information			A10	A20	A40	A50	A70	C10 - C30	C20	E01	
All engines	version Hitachi					1.322.068	1.422.095					
All engines								1.970.214	C10			
All engines	->eng. 1109264									1.965.052		
CR-Z												
1.5 IMA	Petrol/ Electric	84	06/10->	LEA1								
Engine	Information			A10	A20	A40	A50	A70	C10 - C30	C20	E01	
All engines	x 4, COIL ON PLUG								1.970.603	C10		
1.5 IMA												
Engine	Information			A10	A20	A40	A50	A70	C10 - C30	C20	E01	
All engines	x 4, COIL ON PLUG								1.970.603	C10		
FR-V												
1.7	Petrol	92	08/04->	D17A2								
Engine	Information			A10	A20	A40	A50	A70	C10 - C30	C20	E01	
All engines	x 4, COIL ON PLUG								1.970.457	C10		
1.8												
Engine	Information			A10	A20	A40	A50	A70	C10 - C30	C20	E01	
All engines	x 4, COIL ON PLUG								1.970.522	C10		
HR-V												
1.6 16V	Petrol	77	03/99->	350Y, D16W1								
Engine	Information			A10	A20	A40	A50	A70	C10 - C30	C20	E01	
Eng. 350Y	version Hitachi					1.322.068	1.422.095					
Eng. D16W1	x 1, TEC, DISTRIBUTOR								1.970.214	C10		
Eng. 350Y											1.501.699	
1.6 16V 4WD												
Engine	Information			A10	A20	A40	A50	A70	C10 - C30	C20	E01	
Eng. 350Y	version Hitachi					1.322.068	1.422.095					
Eng. D16W1	x 1, TEC, DISTRIBUTOR								1.970.214	C10		
Eng. 350Y											1.501.699	
1.6 16V 4WD												
Engine	Information			A10	A20	A40	A50	A70	C10 - C30	C20	E01	
All engines	version Hitachi					1.322.068	1.422.095					
All engines	x 1, TEC, DISTRIBUTOR								1.970.214	C10		
All engines											1.501.699	
1.6i 16V												
Engine	Information			A10	A20	A40	A50	A70	C10 - C30	C20	E01	
All engines	version Hitachi					1.322.068	1.422.095					
All engines									1.970.214	C10	1.501.699	
INSIGHT												
1.3 IMA	Petrol/ Electric	65	04/09->	LDA3								
Engine	Information			A10	A20	A40	A50	A70	C10 - C30	C20	E01	
All engines	FP: Upper, x 4, COIL ON PLUG								1.970.527	C10		

A10 CONDENSER	A20 CONTACT SET	A40 DISTRIBUTOR CAP	A50 ROTOR	A70 PICK-UP
C10 COIL	C20 IGNITION MODULE	C30 ELECTRONIC IGNITION KIT	E01 IGNITION CABLE SET	

The present application list is a brief version. For the detailed information about the possibility of installation on a specific vehicle, please refer to our web-catalogue <http://catalogo.facet.eu/>

Vehicle	alim.	kW	Date	Engine	FUNCTIONS ON THE VEHICLE							
					A10	A20	A40	A50	A70	C10 - C30	C20	E01

ENGINE				
1.3 IMA	Petrol/ Electric	73	04/09->	LDA3

Engine	Information	A10	A20	A40	A50	A70	C10 - C30	C20	E01
All engines	FP: Upper, x 4, COIL ON PLUG						1.970.527	C10	

INTEGRA

ENGINE				
1.8 i	Petrol	106	01/98->	B18B1, B18C3

Engine	Information	A10	A20	A40	A50	A70	C10 - C30	C20	E01
Eng. B18B1	version Hitachi			1.322.068	1.422.095				
All engines							1.970.214	C10	
Eng. B18B1									1.501.709

ENGINE				
1.8 Type-R	Petrol	140	11/97-10/01	B18C6

Engine	Information	A10	A20	A40	A50	A70	C10 - C30	C20	E01
All engines	x 1, TEC, DISTRIBUTOR						1.970.214	C10	

JAZZ I

ENGINE				
1.2 i-DSI	Petrol	57	03/02-07/08	L12A1, L12A3, L12A4

Engine	Information	A10	A20	A40	A50	A70	C10 - C30	C20	E01
All engines	FP: Front, x 4, COIL ON PLUG						1.970.529	C10	
All engines	FP: Rear, x 4, COIL ON PLUG						1.970.608	C10	

ENGINE				
1.3 iDSi	Petrol	61	03/02-07/08	L13A1, L13A6

Engine	Information	A10	A20	A40	A50	A70	C10 - C30	C20	E01
All engines	FP: Front, x 4, COIL ON PLUG						1.970.529	C10	
All engines	FP: Rear, x 4, COIL ON PLUG						1.970.608	C10	

ENGINE				
1.4	Petrol	65	04/05-07/08	L13A5

Engine	Information	A10	A20	A40	A50	A70	C10 - C30	C20	E01
All engines	Qty: 4						1.970.529, 1.970.608	C10	

ENGINE				
1.4 iDSi	Petrol	61	12/06-10/08	L13A1, L13A6

Engine	Information	A10	A20	A40	A50	A70	C10 - C30	C20	E01
All engines	FP: Front, x 4, COIL ON PLUG						1.970.529	C10	
All engines	FP: Rear, x 4, COIL ON PLUG						1.970.608	C10	

ENGINE				
45 1.2	Petrol	33	02/84-10/86	ER2

Engine	Information	A10	A20	A40	A50	A70	C10 - C30	C20	E01
All engines	version Hitachi				1.422.056				

JAZZ III

ENGINE				
1.2	Petrol	66	07/08->	L12B1, L12B2

Engine	Information	A10	A20	A40	A50	A70	C10 - C30	C20	E01
All engines	x 4, COIL ON PLUG						1.970.603	C10	

ENGINE				
1.3 HYBRID	Petrol/ Electric	65	04/11->	LDA3

Engine	Information	A10	A20	A40	A50	A70	C10 - C30	C20	E01
All engines	FP: Upper, x 4, COIL ON PLUG						1.970.527	C10	

ENGINE				
1.3 i	Petrol	73	07/08->	L13Z1, L13Z2

Engine	Information	A10	A20	A40	A50	A70	C10 - C30	C20	E01
All engines	x 4, COIL ON PLUG						1.970.603	C10	

ENGINE				
1.4	Petrol	74	11/08->	L13Z1

Engine	Information	A10	A20	A40	A50	A70	C10 - C30	C20	E01
All engines	x 4, COIL ON PLUG						1.970.603	C10	

ENGINE				
1.5 i-VTEC	Petrol	88	07/08-06/14	L15-A7

Engine	Information	A10	A20	A40	A50	A70	C10 - C30	C20	E01
All engines	Qty: 4						1.970.603	C10	

A10 CONDENSER	A20 CONTACT SET	A40 DISTRIBUTOR CAP	A50 ROTOR	A70 PICK-UP
C10 COIL	C20 IGNITION MODULE	C30 ELECTRONIC IGNITION KIT	E01 IGNITION CABLE SET	

Vehicle	alim.	kW	Date	Engine	FUNCTIONS ON THE VEHICLE							
					A10	A20	A40	A50	A70	C10 - C30	C20	E01

LEGEND I

				ENGINE
2.7 i 24V	Petrol	124	10/87-12/90	C27A1

Engine	Information	A10	A20	A40	A50	A70	C10 - C30	C20	E01
All engines	version Hitachi						1.970.211	C10	

LEGEND IV

				ENGINE
3.5 i	Petrol	217	10/04->	J35A8

Engine	Information	A10	A20	A40	A50	A70	C10 - C30	C20	E01
All engines	Qty: 6						1.970.457	C10	

				ENGINE
3.5 V6 4WD	Petrol	217	05/06-12/12	J35A8

Engine	Information	A10	A20	A40	A50	A70	C10 - C30	C20	E01
All engines	x 6, COIL ON PLUG						1.970.457	C10	

				ENGINE
3.5 VTEC V6	Petrol	221	10/04-06/09	C35A8

Engine	Information	A10	A20	A40	A50	A70	C10 - C30	C20	E01
All engines	Qty: 6						1.970.457	C10	

				ENGINE
3.7 VTEC V6 4WD	Petrol	226	08/08-12/13	J37A3

Engine	Information	A10	A20	A40	A50	A70	C10 - C30	C20	E01
All engines	->year 01/12/08, x 6, COIL ON PLUG						1.970.457	C10	

LOGO

				ENGINE
1.3	Petrol	48	03/99-03/02	D13B7

Engine	Information	A10	A20	A40	A50	A70	C10 - C30	C20	E01
All engines	version Hitachi			1.322.068	1.422.095				
All engines	x 1, TEC, DISTRIBUTOR						1.970.214	C10	

MR-V

				ENGINE
3.5	Petrol	179	01/03->	J35A4, J35A6, J35A9

Engine	Information	A10	A20	A40	A50	A70	C10 - C30	C20	E01
All engines	Qty: 6						1.970.457	C10	

ODYSSEY

				ENGINE
2.3	Petrol	110	10/97-09/03	F23A, F23A7

Engine	Information	A10	A20	A40	A50	A70	C10 - C30	C20	E01
All engines	version Hitachi				1.422.098				
All engines							1.970.347	C10	

				ENGINE
2.3 4x4	Petrol	110	10/97-09/03	F23A

Engine	Information	A10	A20	A40	A50	A70	C10 - C30	C20	E01
All engines	version Hitachi				1.422.098				
All engines							1.970.347	C10	

				ENGINE
3.5	Petrol	171	01/05->	J35A6

Engine	Information	A10	A20	A40	A50	A70	C10 - C30	C20	E01
All engines	Qty: 6						1.970.457	C10	

				ENGINE
3.5	Petrol	179	01/02-08/04	J35A4

Engine	Information	A10	A20	A40	A50	A70	C10 - C30	C20	E01
All engines	Qty: 6						1.970.457	C10	

PASSPORT

				ENGINE
2.6 i [USA]	Petrol	88	01/94->	4ZE1

Engine	Information	A10	A20	A40	A50	A70	C10 - C30	C20	E01
All engines	version Hitachi			1.322.060	1.422.069				

PRELUDE IV

				ENGINE
2.0 i 16V	Petrol	98	02/92-09/96	F20A4

Engine	Information	A10	A20	A40	A50	A70	C10 - C30	C20	E01
All engines	version Hitachi			1.322.068	1.422.095				

A10 CONDENSER	A20 CONTACT SET	A40 DISTRIBUTOR CAP	A50 ROTOR	A70 PICK-UP
C10 COIL	C20 IGNITION MODULE	C30 ELECTRONIC IGNITION KIT	E01 IGNITION CABLE SET	

FUNCTIONS ON THE VEHICLE

Vehicle	alim.	kW	Date	Engine								
---------	-------	----	------	--------	---	---	---	--	---	---	---	---

PRELUDE IV

2.0 i 16V	Petrol	98	02/92-09/96	ENGINE F20A4
-----------	--------	----	-------------	-----------------

Engine	Information	A10	A20	A40	A50	A70	C10 - C30	C20	E01
All engines							1.970.214	C10	1.501.711
All engines	->eng. 9204631							1.965.052	

2.2 i 16V Vtec	Petrol	136	02/93-09/96	ENGINE H22A2
----------------	--------	-----	-------------	-----------------

Engine	Information	A10	A20	A40	A50	A70	C10 - C30	C20	E01
All engines	version Hitachi			1.322.068	1.422.095				
All engines							1.970.214	C10	
All engines	->eng. 1001957							1.965.052	

2.3 i 16V	Petrol	118	02/92-09/96	ENGINE H23A2
-----------	--------	-----	-------------	-----------------

Engine	Information	A10	A20	A40	A50	A70	C10 - C30	C20	E01
All engines	version Hitachi			1.322.068	1.422.095				
All engines							1.970.214	C10	
All engines	->eng. 2001742							1.965.052	

PRELUDE V

2.0 16V	Petrol	98	10/96-10/00	ENGINE F20A4
---------	--------	----	-------------	-----------------

Engine	Information	A10	A20	A40	A50	A70	C10 - C30	C20	E01
All engines	version Hitachi			1.322.068	1.422.095				
All engines	x 1, TEC, DISTRIBUTOR						1.970.214	C10	
All engines									1.501.711

2.2 16V	Petrol	136	10/96-10/00	ENGINE H22A5
---------	--------	-----	-------------	-----------------

Engine	Information	A10	A20	A40	A50	A70	C10 - C30	C20	E01
All engines	version Hitachi			1.322.068	1.422.095				
All engines	x 1, TEC, DISTRIBUTOR						1.970.214	C10	

2.2 16V	Petrol	147	10/96-10/00	ENGINE H22A5, H22A8
---------	--------	-----	-------------	------------------------

Engine	Information	A10	A20	A40	A50	A70	C10 - C30	C20	E01
Eng. H22A5	version Hitachi			1.322.068	1.422.095				
All engines	x 1, TEC, DISTRIBUTOR						1.970.214	C10	

2.2 i 16V	Petrol	136	10/96-10/01	ENGINE F22A2
-----------	--------	-----	-------------	-----------------

Engine	Information	A10	A20	A40	A50	A70	C10 - C30	C20	E01
All engines	version Hitachi			1.322.068	1.422.095				
All engines							1.970.214	C10	1.501.711

2.2 i 16V VTi-R	Petrol	147	10/96-12/01	ENGINE H22A4, H22A8, H22Z1
-----------------	--------	-----	-------------	-------------------------------

Engine	Information	A10	A20	A40	A50	A70	C10 - C30	C20	E01
Eng. H22A8	version Hitachi			1.322.068					
Eng. H22A4, H22Z1	version Hitachi			1.322.076					
All engines	version Hitachi				1.422.095				
Eng. H22A8							1.970.214	C10	

2.2 Si	Petrol	118	03/97-07/02	ENGINE F22Z6
--------	--------	-----	-------------	-----------------

Engine	Information	A10	A20	A40	A50	A70	C10 - C30	C20	E01
All engines	version Hitachi			1.322.068	1.422.095				
All engines							1.970.214	C10	

SHUTTLE

2.2 16V	Petrol	110	10/94-02/98	ENGINE F22B8
---------	--------	-----	-------------	-----------------

Engine	Information	A10	A20	A40	A50	A70	C10 - C30	C20	E01
All engines	version Hitachi			1.322.068	1.422.095				
All engines							1.970.214	C10	1.501.711

2.3 16V	Petrol	110	10/97-06/04	ENGINE F23A7
---------	--------	-----	-------------	-----------------

Engine	Information	A10	A20	A40	A50	A70	C10 - C30	C20	E01
All engines	version Hitachi				1.422.098				

A10 CONDENSER	A20 CONTACT SET	A40 DISTRIBUTOR CAP	A50 ROTOR	A70 PICK-UP
C10 COIL	C20 IGNITION MODULE	C30 ELECTRONIC IGNITION KIT	E01 IGNITION CABLE SET	

Vehicle	alim.	kW	Date	Engine	FUNCTIONS ON THE VEHICLE							
					 A10	 A20	 A40	 A50	 A70	 C10 - C30	 C20	 E01

					ENGINE
2.3 16V	Petrol	110	10/97-06/04		F23A7

Engine	Information	A10	A20	A40	A50	A70	C10 - C30	C20	E01
All engines							1.970.347	C10	

STREAM

					ENGINE
1.7 16V	Petrol	92	05/01-09/06		D17A2

Engine	Information	A10	A20	A40	A50	A70	C10 - C30	C20	E01
All engines	x 4, COIL ON PLUG						1.970.457	C10	

A10 CONDENSER	A20 CONTACT SET	A40 DISTRIBUTOR CAP	A50 ROTOR	A70 PICK-UP
C10 COIL	C20 IGNITION MODULE	C30 ELECTRONIC IGNITION KIT	E01 IGNITION CABLE SET	

The present application list is a brief version. For the detailed information about the possibility of installation on a specific vehicle, please refer to our web-catalogue <http://catalogo.facet.eu/>

Vehicle	alim.	kW	Date	Engine	FUNCTIONS ON THE VEHICLE							
					A10	A20	A40	A50	A70	C10 - C30	C20	E01

ACCENT

1.4 CVT	Petrol	79	11/10->	ENGINE G4FA
---------	--------	----	---------	----------------

Engine	Information	A10	A20	A40	A50	A70	C10 - C30	C20	E01
All engines	x 4, COIL ON PLUG						1.970.543	C10	

ACCENT I

1.3	Petrol	44	10/94-01/00	ENGINE G4EH
-----	--------	----	-------------	----------------

Engine	Information	A10	A20	A40	A50	A70	C10 - C30	C20	E01
All engines									1.499.119

1.3	Petrol	55	10/94-01/00	ENGINE G4EH
-----	--------	----	-------------	----------------

Engine	Information	A10	A20	A40	A50	A70	C10 - C30	C20	E01
All engines									1.499.119

1.3 i 12V	Petrol	62	10/94-01/00	ENGINE G4EH
-----------	--------	----	-------------	----------------

Engine	Information	A10	A20	A40	A50	A70	C10 - C30	C20	E01
All engines									1.499.119

1.5	Petrol	63	10/94-07/99	ENGINE G4EK
-----	--------	----	-------------	----------------

Engine	Information	A10	A20	A40	A50	A70	C10 - C30	C20	E01
All engines									1.499.119

1.5 i 12V	Petrol	65	10/94-01/00	ENGINE G4EK
-----------	--------	----	-------------	----------------

Engine	Information	A10	A20	A40	A50	A70	C10 - C30	C20	E01
All engines									1.499.119

1.5 i 16V	Petrol	73	10/95-01/00	ENGINE G4ER
-----------	--------	----	-------------	----------------

Engine	Information	A10	A20	A40	A50	A70	C10 - C30	C20	E01
All engines	09/12/96 ->								1.499.111

ACCENT II

1.3	Petrol	55	01/00-11/05	ENGINE G4EA
-----	--------	----	-------------	----------------

Engine	Information	A10	A20	A40	A50	A70	C10 - C30	C20	E01
All engines	FP: Left, FP: Left Front, x 1, D.I.S.						1.970.583	C10	
All engines	FP: right, x 1, D.I.S.						1.970.585	C10	
All engines									1.499.119

1.3	Petrol	61	01/00-11/05	ENGINE G4EA
-----	--------	----	-------------	----------------

Engine	Information	A10	A20	A40	A50	A70	C10 - C30	C20	E01
All engines	FP: Left, FP: Left Front, x 1, D.I.S.						1.970.583	C10	
All engines	FP: right, x 1, D.I.S.						1.970.585	C10	
All engines									1.499.119

1.3	Petrol	62	08/02-11/05	ENGINE G4EA, G4EH
-----	--------	----	-------------	----------------------

Engine	Information	A10	A20	A40	A50	A70	C10 - C30	C20	E01
Eng. G4EH							1.970.582, 1.970.583	C10	1.499.119
Eng. G4EA	FP: Left, FP: Left Front, x 1, D.I.S.						1.970.583	C10	
Eng. G4EA	FP: right, x 1, D.I.S.						1.970.585	C10	
Eng. G4EH	Kit						1.970.585	C10	

1.3	Petrol	63	01/00-11/05	ENGINE G4EA
-----	--------	----	-------------	----------------

Engine	Information	A10	A20	A40	A50	A70	C10 - C30	C20	E01
All engines	FP: Left, FP: Left Front, x 1, D.I.S.						1.970.583	C10	
All engines	FP: right, x 1, D.I.S.						1.970.585	C10	
All engines									1.499.119

1.5	Petrol	65	09/99-10/02	ENGINE G4EK
-----	--------	----	-------------	----------------

Engine	Information	A10	A20	A40	A50	A70	C10 - C30	C20	E01
All engines							1.970.582, 1.970.583	C10	1.499.119
All engines	Kit						1.970.585	C10	

A10 CONDENSER	A20 CONTACT SET	A40 DISTRIBUTOR CAP	A50 ROTOR	A70 PICK-UP
C10 COIL	C20 IGNITION MODULE	C30 ELECTRONIC IGNITION KIT	E01 IGNITION CABLE SET	

Vehicle	alim.	kW	Date	Engine	FUNCTIONS ON THE VEHICLE									
					A10	A20	A40	A50	A70	C10 - C30	C20	E01		
ENGINE														
1.5	Petrol	66	01/00-11/05	G4EB										
Engine	Information				A10	A20	A40	A50	A70	C10 - C30	C20	E01		
All engines	FP: Left, FP: Left Front, x 1, D.I.S.									1.970.583	C10			
All engines	FP: right, x 1, D.I.S.									1.970.585	C10			
All engines													1.499.119	
ENGINE														
1.5	Petrol	68	01/00-10/02	G4EK										
Engine	Information				A10	A20	A40	A50	A70	C10 - C30	C20	E01		
All engines	FP: Left, FP: Left Front, x 1, D.I.S.									1.970.583	C10			
All engines	FP: right, x 1, D.I.S.									1.970.585	C10			
ENGINE														
1.5	Petrol	69	01/00-12/06	G4EK										
Engine	Information				A10	A20	A40	A50	A70	C10 - C30	C20	E01		
All engines	FP: Left, FP: Left Front, x 1, D.I.S.									1.970.583	C10			
All engines	FP: right, x 1, D.I.S.									1.970.585	C10			
ENGINE														
1.5	Petrol	73	09/99-10/02	G4FK										
Engine	Information				A10	A20	A40	A50	A70	C10 - C30	C20	E01		
All engines	x 1, D.I.S.									1.970.585	C10			
ENGINE														
1.5	Petrol	75	09/99-11/05	G4EC-G, G4FK										
Engine	Information				A10	A20	A40	A50	A70	C10 - C30	C20	E01		
Eng. G4FK	FP: right, x 1, D.I.S.									1.970.582	C10			
Eng. G4FK	FP: Left, FP: Left Front, x 1, D.I.S.									1.970.584	C10			
Eng. G4EC-G	x 1, D.I.S.									1.970.585	C10			
All engines													1.499.111	
ENGINE														
1.5	Petrol	77	09/99-10/02	G4FK										
Engine	Information				A10	A20	A40	A50	A70	C10 - C30	C20	E01		
All engines	x 1, D.I.S.									1.970.585	C10			
ENGINE														
1.6	Petrol	77	12/02-11/05	G4ED, G4ED-G										
Engine	Information				A10	A20	A40	A50	A70	C10 - C30	C20	E01		
Eng. G4ED-G										1.970.582, 1.970.584	C10		1.499.111	
Eng. G4ED	x 1, D.I.S.									1.970.586	C10			
Eng. G4ED-G	Kit									1.970.586	C10			
ACCENT III														
ENGINE														
1.4 GL	Petrol	71	11/05-11/10	G4EE										
Engine	Information				A10	A20	A40	A50	A70	C10 - C30	C20	E01		
All engines	Fitting Position:for cylinder 1, Fitting Position:for cylinder 4, x 1, D.I.S.									1.970.582	C10			
All engines	Fitting Position:for cylinder 2, Fitting Position:for cylinder 3, x 1, D.I.S.									1.970.584	C10			
All engines													1.499.111	
ENGINE														
1.6 GLS	Petrol	82	11/05-11/10	G4ED										
Engine	Information				A10	A20	A40	A50	A70	C10 - C30	C20	E01		
All engines													1.499.111	
ACCENT IV														
ENGINE														
1.4	Petrol	74	11/10->	G4LC										
Engine	Information				A10	A20	A40	A50	A70	C10 - C30	C20	E01		
All engines	x 4, COIL ON PLUG									1.970.622	C10			
ENGINE														
1.4	Petrol	79	11/10->	G4FA										
Engine	Information				A10	A20	A40	A50	A70	C10 - C30	C20	E01		
All engines	x 4, COIL ON PLUG									1.970.543	C10			

A10	CONDENSER	A20	CONTACT SET	A40	DISTRIBUTOR CAP	A50	ROTOR	A70	PICK-UP
C10	COIL	C20	IGNITION MODULE	C30	ELECTRONIC IGNITION KIT	E01	IGNITION CABLE SET		

The present application list is a brief version. For the detailed information about the possibility of installation on a specific vehicle, please refer to our web-catalogue <http://catalogo.facet.eu/>

					FUNCTIONS ON THE VEHICLE							
Vehicle	alim.	kW	Date	Engine								
1.4 CVT												
Petrol 0 11/10-> ENGINE												
All engines					A10	A20	A40	A50	A70	C10 - C30	C20	E01
Information												
Qty: 4										1.970.622	C10	
1.6												
Petrol 90 11/10-> ENGINE												
All engines					A10	A20	A40	A50	A70	C10 - C30	C20	E01
Information												
x 4, COIL ON PLUG										1.970.543	C10	
1.6												
Petrol 91 11/10-> ENGINE												
All engines					A10	A20	A40	A50	A70	C10 - C30	C20	E01
Information												
Qty: 4										1.970.543	C10	
ACCENT V												
1.4												
Petrol 74 07/18-> ENGINE												
All engines					A10	A20	A40	A50	A70	C10 - C30	C20	E01
Information												
x 4, COIL ON PLUG										1.970.622	C10	
ATOS												
1.0 i												
Petrol 40 02/98-12/00 ENGINE												
All engines					A10	A20	A40	A50	A70	C10 - C30	C20	E01
Information												
->year 13/11/98, version Mitsubishi							1.331.121					
All engines							1.331.170	1.431.138				
Information												
x 1, D.I.S., connector type DIN										1.970.394	C10	
Information												
->year 01/08/00, x 1, D.I.S., connector type DIN										1.970.496	C10	
All engines												1.499.120
Information												
01/09/01 ->, x 2, D.I.S., connector type DIN												1.499.235
All engines												1.499.235
Information												
->year 14/08/00												1.499.235
All engines												1.499.235
Information												
14/08/00 ->												1.499.235
1.0 i												
Petrol 41 02/98-03/02 ENGINE												
All engines					A10	A20	A40	A50	A70	C10 - C30	C20	E01
Information												
->year 13/11/98, version Mitsubishi							1.331.121					
All engines							1.331.170	1.431.138				
Information												
13/11/98 ->, ->year 14/08/00, version Mitsubishi												
All engines												1.499.120
Information												
->year 14/08/00												1.499.235
All engines												1.499.235
Information												
14/08/00 ->												1.499.235
1.0 i												
Petrol 43 03/01-07/03 ENGINE												
Eng. G4HC					A10	A20	A40	A50	A70	C10 - C30	C20	E01
Information												
x 2, D.I.S., connector type DIN										1.970.496	C10	
Eng. G4HC-E												1.499.119
Information												
15/04/03 ->												1.499.235
Eng. G4HC-E												1.499.235
Information												
->year 15/04/03												1.499.235
1.1												
Petrol 43 08/03-12/08 ENGINE												
All engines					A10	A20	A40	A50	A70	C10 - C30	C20	E01
Information												
Fitting Position:for cylinder 1-4, Fitting Position:for cylinder 2, x 1, D.I.S., Fitting Position:for cylinder 3, x 1, D.I.S., x 1, D.I.S.										1.970.496	C10	
All engines												1.499.119
1.1												
Petrol 45 06/03-12/10 ENGINE												
All engines					A10	A20	A40	A50	A70	C10 - C30	C20	E01
Information												
Qty: 2										1.970.496	C10	
All engines												1.499.119
1.1												
Petrol 46 08/03-12/08 ENGINE												
All engines					A10	A20	A40	A50	A70	C10 - C30	C20	E01
Information												
x 1, D.I.S.										1.970.496	C10	
All engines												1.499.119
ATOS PRIME												
1.0 i												
Petrol 40 08/99-> ENGINE												
All engines					A10	A20	A40	A50	A70	C10 - C30	C20	E01
Information												
->year 13/11/98, version Mitsubishi							1.331.121					

A10 CONDENSER	A20 CONTACT SET	A40 DISTRIBUTOR CAP	A50 ROTOR	A70 PICK-UP
C10 COIL	C20 IGNITION MODULE	C30 ELECTRONIC IGNITION KIT	E01 IGNITION CABLE SET	

Vehicle	alim.	kW	Date	Engine	FUNCTIONS ON THE VEHICLE							
					A10	A20	A40	A50	A70	C10 - C30	C20	E01

ATOS PRIME

				ENGINE
1.0 i	Petrol	40	08/99->	G4HC

Engine	Information	A10	A20	A40	A50	A70	C10 - C30	C20	E01
All engines	13/11/98 ->, ->year 14/08/00, version Mitsubishi			1.331.170	1.431.138				
All engines	->year 14/08/00								1.499.120
All engines	14/08/00 ->								1.499.235

				ENGINE
1.0 i	Petrol	43	03/01-07/03	G4HC-E

Engine	Information	A10	A20	A40	A50	A70	C10 - C30	C20	E01
All engines	Qty: 2						1.970.496	C10	
All engines	15/04/03 ->								1.499.119
All engines	->year 15/04/03								1.499.235

				ENGINE
1.1	Petrol	43	08/03-05/05	G4HD

Engine	Information	A10	A20	A40	A50	A70	C10 - C30	C20	E01
All engines	Qty: 2						1.970.496	C10	
All engines									1.499.119

				ENGINE
1.1	Petrol	46	01/97-12/08	G4HG

Engine	Information	A10	A20	A40	A50	A70	C10 - C30	C20	E01
All engines	Qty: 2						1.970.496	C10	
All engines									1.499.119

BAYON

				ENGINE
1.4 MPI	Petrol	74	05/21->	G4LC

Engine	Information	A10	A20	A40	A50	A70	C10 - C30	C20	E01
All engines	x 4, COIL ON PLUG						1.970.622	C10	

COUPE I

				ENGINE
1.6 16V	Petrol	85	03/98-04/02	G4GR

Engine	Information	A10	A20	A40	A50	A70	C10 - C30	C20	E01
All engines	Coupe, 01/07/00 ->, x 1, D.I.S.						1.970.586	C10	
All engines	01/06/00 ->								1.499.111
All engines	->year 01/06/00								1.501.385

				ENGINE
1.6 i 16V	Petrol	84	12/96-04/02	G4G1, G4GR

Engine	Information	A10	A20	A40	A50	A70	C10 - C30	C20	E01
Eng. 4G61	01/06/00 ->, Kit						1.970.586	C10	
Eng. G4GR	Coupe, 01/07/00 ->, x 1, D.I.S.						1.970.586	C10	
Eng. 4G61	01/06/00 ->								1.499.111
Eng. 4G61	->year 01/06/00								1.501.385

				ENGINE
2.0 16V	Petrol	102	08/96-04/02	G4GF

Engine	Information	A10	A20	A40	A50	A70	C10 - C30	C20	E01
All engines									1.501.385

COUPE II

				ENGINE
1.6 16V	Petrol	77	03/02-08/09	G4ED, G4ED-G

Engine	Information	A10	A20	A40	A50	A70	C10 - C30	C20	E01
Eng. G4ED-G							1.970.582, 1.970.584	C10	1.499.111
Eng. G4ED	Coupe, x 1, D.I.S.						1.970.586	C10	
Eng. G4ED-G	Kit						1.970.586	C10	

				ENGINE
1.6 16V	Petrol	79	03/02-08/09	G4ED, G4ED-G

Engine	Information	A10	A20	A40	A50	A70	C10 - C30	C20	E01
Eng. G4ED-G							1.970.582, 1.970.584	C10	1.499.111
Eng. G4ED	Coupe, x 1, D.I.S.						1.970.586	C10	
Eng. G4ED-G	Kit						1.970.586	C10	

A10	CONDENSER	A20	CONTACT SET	A40	DISTRIBUTOR CAP	A50	ROTOR	A70	PICK-UP
C10	COIL	C20	IGNITION MODULE	C30	ELECTRONIC IGNITION KIT	E01	IGNITION CABLE SET		









Vehicle				FUNCTIONS ON THE VEHICLE								
alim.	kW	Date	Engine	A10	A20	A40	A50	A70	C10 - C30	C20	E01	
2.0				ENGINE								
Petrol	100	08/01-08/09	G4GC, G4GC-G									
Engine	Information			A10	A20	A40	A50	A70	C10 - C30	C20	E01	
Eng. G4GC	Coupe, 01/09/02 ->, x 1, D.I.S.								1.970.581	C10		
Eng. G4GC-G	01/09/02 ->, Qty: 2								1.970.581	C10		
Eng. G4GC-G											1.501.385	
2.0				ENGINE								
Petrol	102	03/02-08/09	G4GC, G4GC-G									
Engine	Information			A10	A20	A40	A50	A70	C10 - C30	C20	E01	
Eng. G4GC	Coupe, 01/09/02 ->, x 1, D.I.S.								1.970.581	C10		
Eng. G4GC-G	01/09/02 ->, Qty: 2								1.970.581	C10		
Eng. G4GC-G											1.501.385	
2.0 GLS				ENGINE								
Petrol	105	02/03-08/09	G4GC, G4GC-G									
Engine	Information			A10	A20	A40	A50	A70	C10 - C30	C20	E01	
Eng. G4GC	Coupe, x 1, D.I.S.								1.970.581	C10		
Eng. G4GC-G	Qty: 2								1.970.581	C10		
Eng. G4GC-G											1.501.385	
2.7 V6				ENGINE								
Petrol	121	01/01-08/09	G6BA-G									
Engine	Information			A10	A20	A40	A50	A70	C10 - C30	C20	E01	
All engines											1.499.236	
2.7 V6				ENGINE								
Petrol	123	03/02-08/09	G6BA-G									
Engine	Information			A10	A20	A40	A50	A70	C10 - C30	C20	E01	
All engines											1.499.236	
CRETA				ENGINE								
1.6				G4FG								
Petrol	90	01/16->										
Engine	Information			A10	A20	A40	A50	A70	C10 - C30	C20	E01	
All engines	x 4, COIL ON PLUG								1.970.543	C10		
1.6 4WD				ENGINE								
Petrol	90	08/16->	G4FG									
Engine	Information			A10	A20	A40	A50	A70	C10 - C30	C20	E01	
All engines	euro 5, x 4, COIL ON PLUG								1.970.543	C10		
ELANTRA I				ENGINE								
1.5 i GL				G4DJ								
Petrol	62	12/90-08/94										
Engine	Information			A10	A20	A40	A50	A70	C10 - C30	C20	E01	
All engines	SOHC/OHC, version Mitsubishi					1.331.003/00	1.431.107					
All engines	DOHC										1.501.401	
1.6i 16V				ENGINE								
Petrol	84	12/90-05/95	G4CR									
Engine	Information			A10	A20	A40	A50	A70	C10 - C30	C20	E01	
All engines											1.501.401	
1.8i 16V				ENGINE								
Petrol	93	06/92-12/95	G4CN									
Engine	Information			A10	A20	A40	A50	A70	C10 - C30	C20	E01	
All engines											1.501.401	
ELANTRA II				ENGINE								
1.6i 16V				G4GR								
Petrol	84	06/95-05/00										
Engine	Information			A10	A20	A40	A50	A70	C10 - C30	C20	E01	
All engines											1.501.385	
1.8i 16V				ENGINE								
Petrol	93	05/95-05/00	G4GM									
Engine	Information			A10	A20	A40	A50	A70	C10 - C30	C20	E01	
All engines											1.501.385	

A10 CONDENSER	A20 CONTACT SET	A40 DISTRIBUTOR CAP	A50 ROTOR	A70 PICK-UP
C10 COIL	C20 IGNITION MODULE	C30 ELECTRONIC IGNITION KIT	E01 IGNITION CABLE SET	

Vehicle	alim.	kW	Date	Engine	FUNCTIONS ON THE VEHICLE									
					A10	A20	A40	A50	A70	C10 - C30	C20	E01		
ENGINE														
1.8 i 16V	Petrol	94	09/95-05/00	G4GM										
Engine	Information				A10	A20	A40	A50	A70	C10 - C30	C20	E01		
All engines													1.501.385	
ENGINE														
2.0 i 16V	Petrol	102	06/97-05/00	G4DF										
Engine	Information				A10	A20	A40	A50	A70	C10 - C30	C20	E01		
All engines													1.501.385	
ELANTRA III														
ENGINE														
1.6	Petrol	66	06/00-07/06	G4GR										
Engine	Information				A10	A20	A40	A50	A70	C10 - C30	C20	E01		
All engines	x 1, D.I.S.									1.970.586	C10			
All engines													1.499.111	
ENGINE														
1.6	Petrol	77	05/03-07/06	G4ED, G4ED-G										
Engine	Information				A10	A20	A40	A50	A70	C10 - C30	C20	E01		
Eng. G4ED-G										1.970.582, 1.970.584	C10		1.499.111	
Eng. G4ED	x 1, D.I.S.									1.970.586	C10			
Eng. G4ED-G	Kit									1.970.586	C10			
ENGINE														
1.6	Petrol	79	06/00-07/06	G4ED, G4ED-G										
Engine	Information				A10	A20	A40	A50	A70	C10 - C30	C20	E01		
Eng. G4ED-G										1.970.582, 1.970.584	C10		1.499.111	
Eng. G4ED	x 1, D.I.S.									1.970.586	C10			
Eng. G4ED-G	Kit									1.970.586	C10			
ENGINE														
1.6	Petrol	82	09/03-07/06	G4GA										
Engine	Information				A10	A20	A40	A50	A70	C10 - C30	C20	E01		
All engines										1.970.582, 1.970.584	C10		1.499.111	
All engines	Kit									1.970.586	C10			
All engines	x 1, D.I.S.									1.970.586	C10			
ENGINE														
1.8	Petrol	79	06/00-07/03	G4BB										
Engine	Information				A10	A20	A40	A50	A70	C10 - C30	C20	E01		
All engines	01/09/02 ->, Qty: 2									1.970.581	C10			
All engines	01/10/02 ->, x 1, D.I.S.									1.970.581	C10			
All engines													1.501.385	
ENGINE														
1.8	Petrol	97	06/00-07/06	G4BB, G4GB										
Engine	Information				A10	A20	A40	A50	A70	C10 - C30	C20	E01		
All engines	01/10/02 ->, x 1, D.I.S.									1.970.581	C10			
All engines													1.501.385	
ENGINE														
1.8	Petrol	98	11/02-07/06	G4GB										
Engine	Information				A10	A20	A40	A50	A70	C10 - C30	C20	E01		
All engines	Qty: 2									1.970.581	C10			
All engines													1.501.385	
ENGINE														
2.0	Petrol	102	06/00-07/06	G4GC, G4GC-G										
Engine	Information				A10	A20	A40	A50	A70	C10 - C30	C20	E01		
Eng. G4GC	01/10/02 ->, x 1, D.I.S.									1.970.581	C10			
Eng. G4GC-G	01/09/02 ->, Qty: 2									1.970.581	C10			
Eng. G4GC-G													1.501.385	
ENGINE														
2.0	Petrol	104	06/00-07/06	G4GC										
Engine	Information				A10	A20	A40	A50	A70	C10 - C30	C20	E01		
All engines	01/10/02 ->, x 1, D.I.S.									1.970.581	C10			
All engines													1.501.385	

A10 CONDENSER	A20 CONTACT SET	A40 DISTRIBUTOR CAP	A50 ROTOR	A70 PICK-UP
C10 COIL	C20 IGNITION MODULE	C30 ELECTRONIC IGNITION KIT	E01 IGNITION CABLE SET	

The present application list is a brief version. For the detailed information about the possibility of installation on a specific vehicle, please refer to our web-catalogue <http://catalogo.facet.eu/>









					FUNCTIONS ON THE VEHICLE							
Vehicle	alim.	kW	Date	Engine								
EXCEL												
2.0	Petrol	105	10/03-07/06	ENGINE G4GC								
Engine	Information				A10	A20	A40	A50	A70	C10 - C30	C20	E01
All engines	x 1, D.I.S.									1.970.581	C10	
All engines												1.501.385
ELANTRA IV												
1.6 CVT	Petrol	90	06/06-06/11	ENGINE G4FC								
Engine	Information				A10	A20	A40	A50	A70	C10 - C30	C20	E01
All engines	x 4, COIL ON PLUG									1.970.495	C10	
2.0 CVT	Petrol	103	06/06-05/10	ENGINE G4GC								
Engine	Information				A10	A20	A40	A50	A70	C10 - C30	C20	E01
All engines	x 1, D.I.S.									1.970.581	C10	
All engines												1.501.385
2.0 CVT	Petrol	105	06/06-06/11	ENGINE G4GC								
Engine	Information				A10	A20	A40	A50	A70	C10 - C30	C20	E01
All engines	Qty: 2									1.970.581	C10	
All engines	x 1, D.I.S.									1.970.581	C10	
All engines												1.501.385
ELANTRA V												
1.6	Petrol	94	04/11->	ENGINE G4FG								
Engine	Information				A10	A20	A40	A50	A70	C10 - C30	C20	E01
All engines	Qty: 4									1.970.543	C10	
All engines	x 4, COIL ON PLUG									1.970.543	C10	
1.6	Petrol	96	06/11-12/15	ENGINE G4FG								
Engine	Information				A10	A20	A40	A50	A70	C10 - C30	C20	E01
All engines	x 4, COIL ON PLUG									1.970.543	C10	
1.6	Petrol	97	06/11-12/15	ENGINE G4FG								
Engine	Information				A10	A20	A40	A50	A70	C10 - C30	C20	E01
All engines	x 4, COIL ON PLUG									1.970.543	C10	
EQUUS / CENTENNIAL II												
3.8	Petrol	246	01/13->	ENGINE --								
Engine	Information				A10	A20	A40	A50	A70	C10 - C30	C20	E01
All engines	Qty: 6									1.970.492	C10	
4.6 V8	Petrol	274	03/09->	ENGINE G8BA								
Engine	Information				A10	A20	A40	A50	A70	C10 - C30	C20	E01
All engines	Qty: 8									1.970.556	C10	
EXCEL												
1.3	Petrol	51	09/89-07/91	ENGINE G4DG								
Engine	Information				A10	A20	A40	A50	A70	C10 - C30	C20	E01
All engines	version Mitsubishi						1.331.003/00	1.431.023				
1.3 i 12V	Petrol	63	09/94-08/99	ENGINE G4EH								
Engine	Information				A10	A20	A40	A50	A70	C10 - C30	C20	E01
All engines												1.499.119
1.5 i 12V	Petrol	65	09/94-08/99	ENGINE G4EK								
Engine	Information				A10	A20	A40	A50	A70	C10 - C30	C20	E01
All engines												1.499.119
1.5 i 16V GT	Petrol	73	10/96-08/99	ENGINE G4ER								
Engine	Information				A10	A20	A40	A50	A70	C10 - C30	C20	E01
All engines	09/12/96 ->											1.499.111

A10 CONDENSER	A20 CONTACT SET	A40 DISTRIBUTOR CAP	A50 ROTOR	A70 PICK-UP
C10 COIL	C20 IGNITION MODULE	C30 ELECTRONIC IGNITION KIT	E01 IGNITION CABLE SET	

Vehicle	alim.	kW	Date	Engine	FUNCTIONS ON THE VEHICLE									
					A10	A20	A40	A50	A70	C10 - C30	C20	E01		
GALLOPER														
3.0 V6	Petrol	104	08/98-12/03	G6AT										
Engine	Information				A10	A20	A40	A50	A70	C10 - C30	C20	E01		
All engines							1.331.116							
All engines	version Mitsubishi						1.431.109							
GENESIS														
2.0	Petrol	191	01/13->	G4KF										
Engine	Information				A10	A20	A40	A50	A70	C10 - C30	C20	E01		
All engines	x 4, COIL ON PLUG									1.970.556	C10			
2.0 CVVT	Petrol	154	06/08-02/14	G4KF										
Engine	Information				A10	A20	A40	A50	A70	C10 - C30	C20	E01		
All engines	x 4, COIL ON PLUG									1.970.556	C10			
2.0 CVVT	Petrol	184	02/13-02/14	G4KF										
Engine	Information				A10	A20	A40	A50	A70	C10 - C30	C20	E01		
All engines	x 4, COIL ON PLUG									1.970.556	C10			
2.0 T	Petrol	157	01/08-12/12	G4KF										
Engine	Information				A10	A20	A40	A50	A70	C10 - C30	C20	E01		
All engines	x 4, COIL ON PLUG									1.970.556	C10			
2.0 T	Petrol	202	11/11-12/14	G4KF										
Engine	Information				A10	A20	A40	A50	A70	C10 - C30	C20	E01		
All engines	x 4, COIL ON PLUG									1.970.556	C10			
2.0 TCI	Petrol	191	01/11->	--										
Engine	Information				A10	A20	A40	A50	A70	C10 - C30	C20	E01		
All engines	Qty: 4									1.970.556	C10			
3.0 GDI	Petrol	183	06/14->	G6DG										
Engine	Information				A10	A20	A40	A50	A70	C10 - C30	C20	E01		
All engines	x 6, COIL ON PLUG									1.970.492	C10			
3.0 GDI 4WD	Petrol	183	06/14->	G6DG										
Engine	Information				A10	A20	A40	A50	A70	C10 - C30	C20	E01		
All engines	x 6, COIL ON PLUG									1.970.492	C10			
3.8	Petrol	228	09/09->	G6DA										
Engine	Information				A10	A20	A40	A50	A70	C10 - C30	C20	E01		
All engines	Qty: 6									1.970.492	C10			
3.8 GDI	Petrol	232	06/14->	G6DJ										
Engine	Information				A10	A20	A40	A50	A70	C10 - C30	C20	E01		
All engines	x 6, COIL ON PLUG									1.970.492	C10			
3.8 GDI 4WD	Petrol	232	06/14->	G6DJ										
Engine	Information				A10	A20	A40	A50	A70	C10 - C30	C20	E01		
All engines	x 6, COIL ON PLUG									1.970.492	C10			
3.8 V6	Petrol	213	01/08-12/14	G6DA										
Engine	Information				A10	A20	A40	A50	A70	C10 - C30	C20	E01		
All engines	x 6, COIL ON PLUG									1.970.492	C10			
3.8 V6	Petrol	223	01/08-02/14	G6DA										
Engine	Information				A10	A20	A40	A50	A70	C10 - C30	C20	E01		
All engines	x 6, COIL ON PLUG									1.970.492	C10			

A10 CONDENSER	A20 CONTACT SET	A40 DISTRIBUTOR CAP	A50 ROTOR	A70 PICK-UP
C10 COIL	C20 IGNITION MODULE	C30 ELECTRONIC IGNITION KIT	E01 IGNITION CABLE SET	

The present application list is a brief version. For the detailed information about the possibility of installation on a specific vehicle, please refer to our web-catalogue <http://catalogo.facet.eu/>

				FUNCTIONS ON THE VEHICLE								
Vehicle	alim.	kW	Date	Engine								
				ENGINE								
3.8 V6	Petrol	246	01/11-12/14	G6DJ								
Engine		Information			A10	A20	A40	A50	A70	C10 - C30	C20	E01
All engines		x 6, COIL ON PLUG								1.970.492	C10	
				ENGINE								
3.8 V6	Petrol	255	11/11-12/14	G6DJ								
Engine		Information			A10	A20	A40	A50	A70	C10 - C30	C20	E01
All engines		x 6, COIL ON PLUG								1.970.492	C10	
				ENGINE								
3.8 V6	Petrol	260	04/12->	G6DJ								
Engine		Information			A10	A20	A40	A50	A70	C10 - C30	C20	E01
All engines		Qty: 6								1.970.492	C10	
				ENGINE								
1.1	Petrol	46	09/02-09/05	G4HD								
Engine		Information			A10	A20	A40	A50	A70	C10 - C30	C20	E01
All engines		Fitting Position:for cylinder 1, Fitting Position:for cylinder 2, Fitting Position:for cylinder 3, Fitting Position:for cylinder 4, x 1, D.I.S.								1.970.587	C10	
All engines		15/04/03 ->										1.499.119
All engines		->year 15/04/03										1.499.235
				ENGINE								
1.1	Petrol	49	09/05-06/09	G4HD								
Engine		Information			A10	A20	A40	A50	A70	C10 - C30	C20	E01
All engines		Fitting Position:for cylinder 1-2, Fitting Position:for cylinder 3-4, x 1, D.I.S.								1.970.587	C10	
All engines												1.499.235
				ENGINE								
1.3	Petrol	61	09/04-06/09	G4EA								
Engine		Information			A10	A20	A40	A50	A70	C10 - C30	C20	E01
All engines										1.970.582, 1.970.583	C10	1.499.119
All engines		Kit								1.970.585	C10	
				ENGINE								
1.3	Petrol	63	09/03-09/05	G4EA								
Engine		Information			A10	A20	A40	A50	A70	C10 - C30	C20	E01
All engines		Fitting Position:for cylinder 1, Fitting Position:for cylinder 4, x 1, D.I.S.								1.970.582	C10	
All engines		Fitting Position:for cylinder 2, Fitting Position:for cylinder 3, x 1, D.I.S.								1.970.583	C10	
All engines												1.499.119
				ENGINE								
1.3 i	Petrol	60	09/02-03/04	G4EA								
Engine		Information			A10	A20	A40	A50	A70	C10 - C30	C20	E01
All engines		FP: right, x 1, D.I.S.								1.970.582	C10	
All engines		FP: Left, FP: Left Front, x 1, D.I.S.								1.970.583	C10	
All engines												1.499.119
				ENGINE								
1.4 i	Petrol	71	08/05-12/10	G4EE								
Engine		Information			A10	A20	A40	A50	A70	C10 - C30	C20	E01
All engines		Fitting Position:for cylinder 1, Fitting Position:for cylinder 4, x 1, D.I.S.								1.970.582	C10	
All engines		Fitting Position:for cylinder 2, Fitting Position:for cylinder 3, x 1, D.I.S.								1.970.584	C10	
All engines												1.499.111
				ENGINE								
1.6	Petrol	77	09/02-09/05	G4ED, G4ED-G								
Engine		Information			A10	A20	A40	A50	A70	C10 - C30	C20	E01
Eng. G4ED		Fitting Position:for cylinder 1, Fitting Position:for cylinder 4, x 1, D.I.S.								1.970.582	C10	
Eng. G4ED-G										1.970.582, 1.970.584	C10	1.499.111
Eng. G4ED		Fitting Position:for cylinder 2, Fitting Position:for cylinder 3, x 1, D.I.S.								1.970.584	C10	
Eng. G4ED-G		Kit								1.970.586	C10	

A10 CONDENSER	A20 CONTACT SET	A40 DISTRIBUTOR CAP	A50 ROTOR	A70 PICK-UP
C10 COIL	C20 IGNITION MODULE	C30 ELECTRONIC IGNITION KIT	E01 IGNITION CABLE SET	

Vehicle	alim.	kW	Date	Engine	FUNCTIONS ON THE VEHICLE									
					A10	A20	A40	A50	A70	C10 - C30	C20	E01		
ENGINE														
1.6	Petrol	78	06/05-06/09	G4ED, G4ED-G										
Engine	Information			A10	A20	A40	A50	A70	C10 - C30	C20	E01			
Eng. G4ED	Fitting Position:for cylinder 1, Fitting Position:for cylinder 4, x 1, D.I.S.								1.970.582	C10				
Eng. G4ED-G									1.970.582, 1.970.584	C10		1.499.111		
Eng. G4ED	Fitting Position:for cylinder 2, Fitting Position:for cylinder 3, x 1, D.I.S.								1.970.584	C10				
Eng. G4ED-G	Kit								1.970.586	C10				
GRAND SANTA FE														
ENGINE														
3.0 GDi Trazione integrale	Petrol	183	07/13->	G6DG										
Engine	Information			A10	A20	A40	A50	A70	C10 - C30	C20	E01			
All engines	x 6, COIL ON PLUG								1.970.492	C10				
ENGINE														
3.3	Petrol	183	01/14->	G6DF										
Engine	Information			A10	A20	A40	A50	A70	C10 - C30	C20	E01			
All engines	x 6, COIL ON PLUG								1.970.492	C10				
ENGINE														
3.3 Trazione integrale	Petrol	199	02/14->	G6DF										
Engine	Information			A10	A20	A40	A50	A70	C10 - C30	C20	E01			
All engines	x 6, COIL ON PLUG								1.970.492	C10				
GRANDEUR														
ENGINE														
2.4	Petrol	132	07/11->	G4KE										
Engine	Information			A10	A20	A40	A50	A70	C10 - C30	C20	E01			
All engines	Grandeur, x 4, COIL ON PLUG								1.970.556	C10				
ENGINE														
3.3	Petrol	173	04/05-12/10	G6DB										
Engine	Information			A10	A20	A40	A50	A70	C10 - C30	C20	E01			
All engines	Grandeur, x 6, COIL ON PLUG								1.970.492	C10				
ENGINE														
3.3	Petrol	191	11/10-12/11	G6DB										
Engine	Information			A10	A20	A40	A50	A70	C10 - C30	C20	E01			
All engines	Grandeur, x 6, COIL ON PLUG								1.970.492	C10				
H1														
ENGINE														
2.4 CVT	Petrol	127	01/10->	G4KC										
Engine	Information			A10	A20	A40	A50	A70	C10 - C30	C20	E01			
All engines	x 4, COIL ON PLUG								1.970.556	C10				
H-1 I														
ENGINE														
2.4	Petrol	101	02/03-04/04	G4JS										
Engine	Information			A10	A20	A40	A50	A70	C10 - C30	C20	E01			
All engines												1.499.241		
ENGINE														
2.4	Petrol	107	11/01-04/04	G4JS										
Engine	Information			A10	A20	A40	A50	A70	C10 - C30	C20	E01			
All engines												1.499.241		
ENGINE														
2.4	Petrol	82	06/97-04/04	G4CS										
Engine	Information			A10	A20	A40	A50	A70	C10 - C30	C20	E01			
All engines	version Mitsubishi					1.331.003/00	1.431.107							
ENGINE														
2.4 4WD	Petrol	82	02/98-04/04	G4CS										
Engine	Information			A10	A20	A40	A50	A70	C10 - C30	C20	E01			
All engines	version Mitsubishi					1.331.003/00	1.431.107							

A10 CONDENSER	A20 CONTACT SET	A40 DISTRIBUTOR CAP	A50 ROTOR	A70 PICK-UP
C10 COIL	C20 IGNITION MODULE	C30 ELECTRONIC IGNITION KIT	E01 IGNITION CABLE SET	

The present application list is a brief version. For the detailed information about the possibility of installation on a specific vehicle, please refer to our web-catalogue <http://catalogo.facet.eu/>

Vehicle	alim.	kW	Date	Engine	FUNCTIONS ON THE VEHICLE							
					A10	A20	A40	A50	A70	C10 - C30	C20	E01

H-1 II

2.4	Petrol	129	02/08->	ENGINE --, G4KC
-----	--------	-----	---------	--------------------

Engine	Information	A10	A20	A40	A50	A70	C10 - C30	C20	E01
Eng. --	Qty: 4						1.970.556	C10	
Eng. G4KC	x 4, COIL ON PLUG						1.970.556	C10	

2.4 i	Petrol	129	02/08->	ENGINE G4KC
-------	--------	-----	---------	----------------

Engine	Information	A10	A20	A40	A50	A70	C10 - C30	C20	E01
All engines	x 4, COIL ON PLUG						1.970.556	C10	

H100

2.4	Petrol	82	10/97-12/04	ENGINE G4CS
-----	--------	----	-------------	----------------

Engine	Information	A10	A20	A40	A50	A70	C10 - C30	C20	E01
All engines	->year 15/03/96, version Mitsubishi			1.331.003/00	1.431.107				

2.4	Petrol	84	05/96-03/00	ENGINE G4CS
-----	--------	----	-------------	----------------

Engine	Information	A10	A20	A40	A50	A70	C10 - C30	C20	E01
All engines	->year 15/03/96, version Mitsubishi			1.331.003/00	1.431.107				

2.4	Petrol	90	07/93-03/00	ENGINE G4CS
-----	--------	----	-------------	----------------

Engine	Information	A10	A20	A40	A50	A70	C10 - C30	C20	E01
All engines	->year 15/03/96, version Mitsubishi			1.331.003/00	1.431.107				

HIGHWAY VAN

2.0 16V	Petrol	100	03/00-03/04	ENGINE G4JP
---------	--------	-----	-------------	----------------

Engine	Information	A10	A20	A40	A50	A70	C10 - C30	C20	E01
All engines									1.499.241

I10 I

1.0	Petrol	51	01/11-12/17	ENGINE G3LA
-----	--------	----	-------------	----------------

Engine	Information	A10	A20	A40	A50	A70	C10 - C30	C20	E01
All engines	x 3, COIL ON PLUG						1.970.614	C10	

1.1	Petrol	48	12/07-12/13	ENGINE G4HG
-----	--------	----	-------------	----------------

Engine	Information	A10	A20	A40	A50	A70	C10 - C30	C20	E01
All engines	Fitting Position:for cylinder 1, Fitting Position:for cylinder 2, Fitting Position:for cylinder 3, Fitting Position:for cylinder 4, x 1, D.I.S.						1.970.496	C10	
All engines									1.499.235

1.1	Petrol	49	01/08-12/13	ENGINE G4HG
-----	--------	----	-------------	----------------

Engine	Information	A10	A20	A40	A50	A70	C10 - C30	C20	E01
All engines	Fitting Position:for cylinder 1, Fitting Position:for cylinder 2, Fitting Position:for cylinder 3, Fitting Position:for cylinder 4, x 1, D.I.S.						1.970.496	C10	
All engines									1.499.235

1.1	Petrol	50	11/08-12/13	ENGINE G4HG
-----	--------	----	-------------	----------------

Engine	Information	A10	A20	A40	A50	A70	C10 - C30	C20	E01
All engines	Fitting Position:for cylinder 1, Fitting Position:for cylinder 2, Fitting Position:for cylinder 3, Fitting Position:for cylinder 4, x 1, D.I.S.						1.970.496	C10	
All engines									1.499.235



1.1	Petrol	51	04/11-12/13	ENGINE G4HG
-----	--------	----	-------------	----------------

Engine	Information	A10	A20	A40	A50	A70	C10 - C30	C20	E01
All engines	Fitting Position:for cylinder 1, Fitting Position:for cylinder 2, Fitting Position:for cylinder 3, Fitting Position:for cylinder 4, x 1, D.I.S.						1.970.496	C10	
All engines									1.499.235

A10 CONDENSER	A20 CONTACT SET	A40 DISTRIBUTOR CAP	A50 ROTOR	A70 PICK-UP
C10 COIL	C20 IGNITION MODULE	C30 ELECTRONIC IGNITION KIT	E01 IGNITION CABLE SET	

Vehicle	alim.	kW	Date	Engine	FUNCTIONS ON THE VEHICLE								
					A10	A20	A40	A50	A70	C10 - C30	C20	E01	
ENGINE													
1.1 LPG	Petrol/ Liquified Petro- leum Gas (LPG)	48	01/09-12/13	G4HG									
Engine					Information	A10	A20	A40	A50	A70	C10 - C30	C20	E01
All engines					Fitting Position:for cylinder 1, Fitting Position:for cylinder 2, Fitting Position:for cylinder 3, Fitting Position:for cylinder 4, x 1, D.I.S.						1.970.496	C10	
ENGINE													
1.1 LPG	Petrol/ Liquified Petro- leum Gas (LPG)	51	04/11-12/13	G4HG									
Engine					Information	A10	A20	A40	A50	A70	C10 - C30	C20	E01
All engines					Fitting Position:for cylinder 1-4, Fitting Position:for cylinder 2, Fitting Position:for cylinder 3, x 1, D.I.S., x 1, D.I.S.						1.970.496	C10	
ENGINE													
1.2	Petrol	57	11/08-12/11	G4LA									
Engine					Information	A10	A20	A40	A50	A70	C10 - C30	C20	E01
All engines					Fitting Position:for cylinder 1-2, Fitting Position:for cylinder 3-4, x 1, D.I.S.						1.970.579	C10	
All engines													1.499.255
ENGINE													
1.2	Petrol	63	04/11-12/13	G4LA									
Engine					Information	A10	A20	A40	A50	A70	C10 - C30	C20	E01
All engines					Fitting Position:for cylinder 1-2, Fitting Position:for cylinder 3-4, x 1, D.I.S.						1.970.579	C10	
All engines													1.499.255
ENGINE													
1.2	Petrol	64	12/15->	G4LA									
Engine					Information	A10	A20	A40	A50	A70	C10 - C30	C20	E01
All engines					Fitting Position:for cylinder 1-2, Fitting Position:for cylinder 3-4, x 1, D.I.S.						1.970.579	C10	
ENGINE													
1.2 LPG	Petrol/ Liquified Petro- leum Gas (LPG)	57	01/10-12/13	G4LA									
Engine					Information	A10	A20	A40	A50	A70	C10 - C30	C20	E01
All engines					Fitting Position:for cylinder 1-2, Fitting Position:for cylinder 2, Fitting Position:for cylinder 3, x 1, D.I.S., Fitting Position:for cylinder 4, x 1, D.I.S.						1.970.579	C10	
I10 II													
ENGINE													
1.0	Petrol	49	08/13->	G3LA									
Engine					Information	A10	A20	A40	A50	A70	C10 - C30	C20	E01
All engines					x 3, COIL ON PLUG						1.970.614	C10	
ENGINE													
1.0 LPG	Petrol/ Liquified Petro- leum Gas (LPG)	49	02/14->	B3LA									
Engine					Information	A10	A20	A40	A50	A70	C10 - C30	C20	E01
All engines					x 3, COIL ON PLUG						1.970.614	C10	
ENGINE													
1.0 LPG	Petrol/ Liquified Petro- leum Gas (LPG)	51	07/14-08/16	B3LA									
Engine					Information	A10	A20	A40	A50	A70	C10 - C30	C20	E01
All engines					x 3, COIL ON PLUG						1.970.614	C10	
ENGINE													
1.2	Petrol	64	12/13->	G4LA									
Engine					Information	A10	A20	A40	A50	A70	C10 - C30	C20	E01
All engines					x 1, COIL ON PLUG						1.970.579	C10	
All engines													1.499.255
A10 CONDENSER		A20 CONTACT SET		A40 DISTRIBUTOR CAP		A50 ROTOR		A70 PICK-UP					
C10 COIL		C20 IGNITION MODULE		C30 ELECTRONIC IGNITION KIT		E01 IGNITION CABLE SET							









The present application list is a brief version. For the detailed information about the possibility of installation on a specific vehicle, please refer to our web-catalogue <http://catalogo.facet.eu/>

					FUNCTIONS ON THE VEHICLE												
Vehicle	alim.	kW	Date	Engine													
I20 I																	
1.2	Petrol	56	12/08-08/14	ENGINE G4AG													
Engine					Information	A10	A20	A40	A50	A70	C10 - C30	C20	E01				
All engines					x 1, D.I.S.						1.970.579	C10					
1.2	Petrol	57	09/08-12/12	ENGINE G4LA													
Engine					Information	A10	A20	A40	A50	A70	C10 - C30	C20	E01				
All engines					x 1, D.I.S.						1.970.579	C10					
All engines					-start-stop function								1.499.255				
1.2	Petrol	63	03/12-12/15	ENGINE G4LA													
Engine					Information	A10	A20	A40	A50	A70	C10 - C30	C20	E01				
All engines					Fitting Position:for cylinder 1-2, Fitting Position:for cylinder 3-4, x 4, COIL ON PLUG, x 1, D.I.S., incl. spark plug connector						1.970.579	C10					
All engines					x 4, +start-stop function, COIL ON PLUG, incl. spark plug connector						1.970.612	C10					
All engines					-start-stop function								1.499.255				
1.2 LPG	Petrol/ Liquified Petro- leum Gas (LPG)	60	01/09-08/14	ENGINE G4LA													
Engine					Information	A10	A20	A40	A50	A70	C10 - C30	C20	E01				
All engines					Fitting Position:for cylinder 1-2, Fitting Position:for cylinder 3-4, x 1, D.I.S.						1.970.579	C10					
1.4	Petrol	74	09/08-12/15	ENGINE G4FA													
Engine					Information	A10	A20	A40	A50	A70	C10 - C30	C20	E01				
All engines					x 4, COIL ON PLUG						1.970.543	C10					
1.4 LPG	Petrol/ Liquified Petro- leum Gas (LPG)	75	12/08-12/12	ENGINE G4FA													
Engine					Information	A10	A20	A40	A50	A70	C10 - C30	C20	E01				
All engines					x 4, COIL ON PLUG						1.970.543	C10					
1.6	Petrol	93	09/08-12/12	ENGINE G4FC													
Engine					Information	A10	A20	A40	A50	A70	C10 - C30	C20	E01				
All engines					x 4, COIL ON PLUG						1.970.543	C10					
I20 II																	
1.0 T-GDI	Petrol	74	09/15->	ENGINE G3LC													
Engine					Information	A10	A20	A40	A50	A70	C10 - C30	C20	E01				
All engines					x 3, COIL ON PLUG						1.970.638	C10					
1.0 T-GDI	Petrol	88	09/15->	ENGINE G3LC													
Engine					Information	A10	A20	A40	A50	A70	C10 - C30	C20	E01				
All engines					x 3, COIL ON PLUG						1.970.638	C10					
1.2	Petrol	55	11/14->	ENGINE G4LA													
Engine					Information	A10	A20	A40	A50	A70	C10 - C30	C20	E01				
All engines					x 4, Fitting Position:for cylinder 1-2, Fitting Position:for cylinder 3-4, -start-stop function, COIL ON PLUG, x 1, -start-stop function, D.I.S.						1.970.579	C10					
All engines					x 4, +start-stop function, COIL ON PLUG, incl. spark plug connector						1.970.612	C10					
All engines					-start-stop function								1.499.255				
1.2	Petrol	62	11/14->	ENGINE G4LA													
Engine					Information	A10	A20	A40	A50	A70	C10 - C30	C20	E01				
All engines					Qty: 2, -start-stop function						1.970.579	C10					
All engines					x 4, Fitting Position:for cylinder 1-2, Fitting Position:for cylinder 3-4, -start-stop function, COIL ON PLUG, x 1, -start-stop function, D.I.S.						1.970.579	C10					
All engines					+start-stop function, Qty: 4						1.970.612	C10					
A10	CONDENSER	A20	CONTACT SET	A40	DISTRIBUTOR CAP	A50	ROTOR	A70	PICK-UP	C10	COIL	C20	IGNITION MODULE	C30	ELECTRONIC IGNITION KIT	E01	IGNITION CABLE SET

Vehicle	alim.	kW	Date	Engine	FUNCTIONS ON THE VEHICLE									
					A10	A20	A40	A50	A70	C10 - C30	C20	E01		
ENGINE														
1.2	Petrol	62	11/14->	G4LA										
Engine	Information				A10	A20	A40	A50	A70	C10 - C30	C20	E01		
All engines	x 4, +start-stop function, COIL ON PLUG, incl. spark plug connector									1.970.612	C10			
All engines	-start-stop function												1.499.255	
ENGINE														
1.2 LPG	Petrol/ Liquified Petro- leum Gas (LPG)	55	01/19->	G4LA										
Engine	Information				A10	A20	A40	A50	A70	C10 - C30	C20	E01		
All engines	x 4, COIL ON PLUG, incl. spark plug connector									1.970.612	C10			
ENGINE														
1.2 LPGI	Petrol/ Liquified Petro- leum Gas (LPG)	61	11/14->	G4LA										
Engine	Information				A10	A20	A40	A50	A70	C10 - C30	C20	E01		
All engines	x 4, Fitting Position:for cylinder 1-2, Fitting Position:for cylinder 3-4, -start-stop function, COIL ON PLUG, x 1, -start-stop function, D.I.S.									1.970.579	C10			
All engines	x 4, +start-stop function, COIL ON PLUG, incl. spark plug connector									1.970.612	C10			
ENGINE														
1.2 MPI	Petrol	55	05/15->	G4LA										
Engine	Information				A10	A20	A40	A50	A70	C10 - C30	C20	E01		
All engines	x 4, Fitting Position:for cylinder 1-2, Fitting Position:for cylinder 3-4, -start-stop function, COIL ON PLUG, x 1, -start-stop function, D.I.S.									1.970.579	C10			
All engines	x 4, +start-stop function, COIL ON PLUG, incl. spark plug connector									1.970.612	C10			
ENGINE														
1.2 MPI	Petrol	62	05/15->	G4LA										
Engine	Information				A10	A20	A40	A50	A70	C10 - C30	C20	E01		
All engines	x 4, Fitting Position:for cylinder 1-2, Fitting Position:for cylinder 3-4, -start-stop function, COIL ON PLUG, x 1, -start-stop function, D.I.S.									1.970.579	C10			
All engines	x 4, +start-stop function, COIL ON PLUG, incl. spark plug connector									1.970.612	C10			
ENGINE														
1.4	Petrol	74	11/14->	G4LC										
Engine	Information				A10	A20	A40	A50	A70	C10 - C30	C20	E01		
All engines	x 4, COIL ON PLUG									1.970.622	C10			
ENGINE														
1.4 MPI	Petrol	74	05/15->	G4LC										
Engine	Information				A10	A20	A40	A50	A70	C10 - C30	C20	E01		
All engines	x 4, COIL ON PLUG									1.970.622	C10			
I30 I														
ENGINE														
1.4	Petrol	77	10/07-06/12	G4FA										
Engine	Information				A10	A20	A40	A50	A70	C10 - C30	C20	E01		
All engines	->year 01/11/08, MADE BY: (ROK), MADE BY: (CZ), x 4, COIL ON PLUG, x 4, COIL ON PLUG ----- MADE BY: (ROK), x 4, COIL ON PLUG									1.970.495	C10			
All engines	01/12/08 ->, MADE BY: (CZ), MADE BY: (CZ), x 4, COIL ON PLUG, x 4, COIL ON PLUG									1.970.543	C10			
ENGINE														
1.4	Petrol	80	10/07-06/12	G4FA										
Engine	Information				A10	A20	A40	A50	A70	C10 - C30	C20	E01		
All engines	->year 01/11/08, MADE BY: (ROK), MADE BY: (CZ), x 4, COIL ON PLUG, x 4, COIL ON PLUG ----- MADE BY: (ROK), x 4, COIL ON PLUG									1.970.495	C10			
All engines	01/12/08 ->, MADE BY: (CZ), MADE BY: (CZ), x 4, COIL ON PLUG, x 4, COIL ON PLUG									1.970.543	C10			

A10 CONDENSER	A20 CONTACT SET	A40 DISTRIBUTOR CAP	A50 ROTOR	A70 PICK-UP
C10 COIL	C20 IGNITION MODULE	C30 ELECTRONIC IGNITION KIT	E01 IGNITION CABLE SET	

The present application list is a brief version. For the detailed information about the possibility of installation on a specific vehicle, please refer to our web-catalogue <http://catalogo.facet.eu/>

					FUNCTIONS ON THE VEHICLE												
Vehicle	alim.	kW	Date	Engine													
ENGINE																	
1.4 LPG	Petrol/ Liquified Petro- leum Gas (LPG)	80	01/09-06/12	G4FA													
Engine	Information				A10	A20	A40	A50	A70	C10 - C30	C20	E01					
All engines	MADE BY: (ROK), x 4, COIL ON PLUG									1.970.495	C10						
All engines	MADE BY: (CZ), x 4, COIL ON PLUG									1.970.543	C10						
ENGINE																	
1.6	Petrol	85	10/07-06/12	G4FC													
Engine	Information				A10	A20	A40	A50	A70	C10 - C30	C20	E01					
All engines	->year 01/11/08, MADE BY: (CZ), x 4, COIL ON PLUG MADE BY: (ROK), x 4, COIL ON PLUG									1.970.495	C10						
All engines	01/12/08 ->, MADE BY: (CZ), x 4, COIL ON PLUG									1.970.543	C10						
ENGINE																	
1.6	Petrol	90	10/07-06/12	G4FC													
Engine	Information				A10	A20	A40	A50	A70	C10 - C30	C20	E01					
All engines	->year 01/11/08, MADE BY: (CZ), x 4, COIL ON PLUG MADE BY: (ROK), x 4, COIL ON PLUG									1.970.495	C10						
All engines	01/12/08 ->, MADE BY: (CZ), x 4, COIL ON PLUG									1.970.543	C10						
ENGINE																	
1.6	Petrol	93	02/08-06/12	G4FC													
Engine	Information				A10	A20	A40	A50	A70	C10 - C30	C20	E01					
All engines	->year 01/11/08, MADE BY: (CZ), x 4, COIL ON PLUG MADE BY: (ROK), x 4, COIL ON PLUG									1.970.495	C10						
All engines	01/12/08 ->, MADE BY: (CZ), x 4, COIL ON PLUG									1.970.543	C10						
ENGINE																	
2.0	Petrol	105	10/07-06/12	G4GC, G4GC-G													
Engine	Information				A10	A20	A40	A50	A70	C10 - C30	C20	E01					
Eng. G4GC	x 1, D.I.S.									1.970.581	C10						
Eng. G4GC-G	Qty: 2									1.970.581	C10						
All engines												1.501.385					
I30 II																	
ENGINE																	
1.4	Petrol	73	12/11->	G4FA													
Engine	Information				A10	A20	A40	A50	A70	C10 - C30	C20	E01					
All engines	x 4, COIL ON PLUG									1.970.543	C10						
ENGINE																	
1.4	Petrol	74	12/14->	G4LC													
Engine	Information				A10	A20	A40	A50	A70	C10 - C30	C20	E01					
All engines	->year 01/12/14, x 4, COIL ON PLUG									1.970.543	C10						
All engines	x 4, COIL ON PLUG, x 4, COIL ON PLUG									1.970.622	C10						
ENGINE																	
1.4 LPG	Petrol/ Liquified Petro- leum Gas (LPG)	73	01/13->	G4FA													
Engine	Information				A10	A20	A40	A50	A70	C10 - C30	C20	E01					
All engines	x 4, COIL ON PLUG									1.970.543	C10						
ENGINE																	
1.4 MPI	Petrol	74	05/15->	G4LC													
Engine	Information				A10	A20	A40	A50	A70	C10 - C30	C20	E01					
All engines	x 4, COIL ON PLUG									1.970.622	C10						
ENGINE																	
1.6	Petrol	88	01/12->	G4FC, G4FG													
Engine	Information				A10	A20	A40	A50	A70	C10 - C30	C20	E01					
All engines	x 4, COIL ON PLUG									1.970.543, 1.970.611	C10						
ENGINE																	
1.6	Petrol	95	12/11-12/15	G4FC, G4FD, G4FG													
Engine	Information				A10	A20	A40	A50	A70	C10 - C30	C20	E01					
Eng. G4FG	no specific info conc. application available, Qty: 4									1.970.543, 1.970.611	C10						
Eng. G4FC, G4FD	x 4, COIL ON PLUG									1.970.611	C10						
A10	CONDENSER	A20	CONTACT SET	A40	DISTRIBUTOR CAP	A50	ROTOR	A70	PICK-UP	C10	COIL	C20	IGNITION MODULE	C30	ELECTRONIC IGNITION KIT	E01	IGNITION CABLE SET

Vehicle	alim.	kW	Date	Engine	FUNCTIONS ON THE VEHICLE								
					A10	A20	A40	A50	A70	C10 - C30	C20	E01	
ENGINE													
1.6	Petrol	96	06/14->	G4FC									
ENGINE													
All engines										1,970.543	C10		
ENGINE													
1.6 GDI	Petrol	99	12/11->	G4FD									
ENGINE													
All engines										1,970.611	C10		
ENGINE													
1.6 MPI	Petrol	88	11/16->	G4FC									
ENGINE													
All engines										1,970.543	C10		
ENGINE													
1.6 MPI	Petrol	96	06/14->	G4FC									
ENGINE													
All engines										1,970.543	C10		
I30 III													
ENGINE													
1.0 T-GDi	Petrol	88	11/16->	G3LC									
ENGINE													
All engines										1,970.638	C10		
ENGINE													
1.4 MPI	Petrol	73	05/17->	G4LC									
ENGINE													
All engines										1,970.622	C10		
ENGINE													
1.4 MPI	Petrol	74	11/16->	G4LC									
ENGINE													
All engines										1,970.622	C10		
I40													
ENGINE													
1.6 GDI	Petrol	99	07/11->	G4FD									
ENGINE													
All engines										1,970.611	C10		
INNOVATION													
ENGINE													
3.0 V6	Petrol	104	05/00->	G6AT									
ENGINE													
All engines							1,331.116						
All engines							1,431.109						
IONIQ													
ENGINE													
1.6 GDI Hybrid	Petrol/ Electric	104	03/16->	G4LE									
ENGINE													
All engines										1,970.647	C10		
ENGINE													
1.6 GDI Hybrid	Petrol/ Electric	77	03/16->	G4LE									
ENGINE													
All engines										1,970.647	C10		
ENGINE													
1.6 GDI Plug-in Hybrid	Petrol/ Electric	77	03/16->	G4LE									
ENGINE													
All engines										1,970.647	C10		
IX20													
ENGINE													
1.4	Petrol	66	11/10->	G4FA									
ENGINE													
All engines										1,970.543	C10		

A10 CONDENSER	A20 CONTACT SET	A40 DISTRIBUTOR CAP	A50 ROTOR	A70 PICK-UP
C10 COIL	C20 IGNITION MODULE	C30 ELECTRONIC IGNITION KIT	E01 IGNITION CABLE SET	

The present application list is a brief version. For the detailed information about the possibility of installation on a specific vehicle, please refer to our web-catalogue <http://catalogo.facet.eu/>





Vehicle	alim.	kW	Date	Engine	FUNCTIONS ON THE VEHICLE								
					A10	A20	A40	A50	A70	C10 - C30	C20	E01	
ENGINE													
1.4	Petrol	74	11/10->	G4FA									
Engine		Information			A10	A20	A40	A50	A70	C10 - C30	C20	E01	
All engines		x 4, COIL ON PLUG								1.970.543	C10		
ENGINE													
1.4 LPG	Petrol/ Liquified Petro- leum Gas (LPG)	66	11/10->	G4FA									
Engine		Information			A10	A20	A40	A50	A70	C10 - C30	C20	E01	
All engines		x 4, COIL ON PLUG								1.970.543	C10		
ENGINE													
1.6	Petrol	92	11/10->	G4FC									
Engine		Information			A10	A20	A40	A50	A70	C10 - C30	C20	E01	
All engines		x 4, COIL ON PLUG								1.970.543	C10		
ENGINE													
1.6 LPG	Petrol/ Liquified Petro- leum Gas (LPG)	92	11/10->	G4FC									
Engine		Information			A10	A20	A40	A50	A70	C10 - C30	C20	E01	
All engines		x 4, COIL ON PLUG								1.970.543	C10		
IX35													
ENGINE													
1.6	Petrol	99	11/10->	G4FD									
Engine		Information			A10	A20	A40	A50	A70	C10 - C30	C20	E01	
All engines		x 4, COIL ON PLUG								1.970.611	C10		
ENGINE													
2.0	Petrol	120	01/10-07/13	G4KD									
Engine		Information			A10	A20	A40	A50	A70	C10 - C30	C20	E01	
All engines		x 4, COIL ON PLUG								1.970.556	C10		
ENGINE													
2.0	Petrol	122	01/10->	G4KD									
Engine		Information			A10	A20	A40	A50	A70	C10 - C30	C20	E01	
All engines		x 4, COIL ON PLUG								1.970.556	C10		
ENGINE													
2.0 4WD	Petrol	120	01/10->	G4KD									
Engine		Information			A10	A20	A40	A50	A70	C10 - C30	C20	E01	
All engines		x 4, COIL ON PLUG								1.970.556	C10		
ENGINE													
2.0 CVT	Petrol	110	08/09-07/13	G4KD									
Engine		Information			A10	A20	A40	A50	A70	C10 - C30	C20	E01	
All engines		x 4, COIL ON PLUG								1.970.556	C10		
ENGINE													
2.0 CVT AWD	Petrol	110	08/09-07/13	G4KD									
Engine		Information			A10	A20	A40	A50	A70	C10 - C30	C20	E01	
All engines		x 4, COIL ON PLUG								1.970.556	C10		
ENGINE													
2.4 DCVVT-I 4WD	Petrol	128	07/10-12/13	G4KE									
Engine		Information			A10	A20	A40	A50	A70	C10 - C30	C20	E01	
All engines		Qty: 4								1.970.556	C10		
ENGINE													
2.4 GDi 4WD	Petrol	136	01/13->	G4KJ									
Engine		Information			A10	A20	A40	A50	A70	C10 - C30	C20	E01	
All engines		Qty: 4								1.970.556	C10		
ENGINE													
GDi	Petrol	99	05/15-12/15	G4FD									
Engine		Information			A10	A20	A40	A50	A70	C10 - C30	C20	E01	
All engines		x 4, COIL ON PLUG								1.970.611	C10		

A10 CONDENSER	A20 CONTACT SET	A40 DISTRIBUTOR CAP	A50 ROTOR	A70 PICK-UP
C10 COIL	C20 IGNITION MODULE	C30 ELECTRONIC IGNITION KIT	E01 IGNITION CABLE SET	

Vehicle	alim.	kW	Date	Engine	FUNCTIONS ON THE VEHICLE							
					A10	A20	A40	A50	A70	C10 - C30	C20	E01
IX55												
3.8 V6	Petrol	194	01/11->	G6DA								
Engine	Information			A10	A20	A40	A50	A70	C10 - C30	C20	E01	
All engines	Qty: 6								1.970.492	C10		
3.8 V6 4WD	Petrol	191	01/07->	G6DA								
Engine	Information			A10	A20	A40	A50	A70	C10 - C30	C20	E01	
All engines	x 6, COIL ON PLUG								1.970.492	C10		
KONA												
1.0 T-GDi	Petrol	88	07/17->	G3LC								
Engine	Information			A10	A20	A40	A50	A70	C10 - C30	C20	E01	
All engines	x 3, COIL ON PLUG								1.970.638	C10		
1.6 GDi Hybrid	Petrol/ Electric	77	06/19->	G4LE								
Engine	Information			A10	A20	A40	A50	A70	C10 - C30	C20	E01	
All engines	x 4, COIL ON PLUG								1.970.647	C10		
LANTRA												
1.8	Petrol	97	06/00->	G4GB								
Engine	Information			A10	A20	A40	A50	A70	C10 - C30	C20	E01	
All engines	01/09/02 ->, Qty: 2								1.970.581	C10		
All engines											1.501.385	
2.0	Petrol	102	06/00->	G4GC-G								
Engine	Information			A10	A20	A40	A50	A70	C10 - C30	C20	E01	
All engines	01/09/02 ->, Qty: 2								1.970.581	C10		
All engines											1.501.385	
LANTRA I												
1.5	Petrol	53	10/90-04/95	G4DJ								
Engine	Information			A10	A20	A40	A50	A70	C10 - C30	C20	E01	
All engines	version Mitsubishi					1.331.003/00	1.431.023					
1.5 i.e.	Petrol	63	10/90-11/95	G4DJ								
Engine	Information			A10	A20	A40	A50	A70	C10 - C30	C20	E01	
All engines	SOHC/OHC, version Mitsubishi					1.331.003/00	1.431.107					
All engines	DOHC										1.501.401	
1.6 i.e. 16V	Petrol	78	10/90-11/95	G4CR								
Engine	Information			A10	A20	A40	A50	A70	C10 - C30	C20	E01	
All engines											1.501.401	
1.6 i.e. 16V	Petrol	84	10/90-11/95	G4CR								
Engine	Information			A10	A20	A40	A50	A70	C10 - C30	C20	E01	
All engines											1.501.401	
1.8 i.e. 16V	Petrol	93	10/90-11/95	G4CN								
Engine	Information			A10	A20	A40	A50	A70	C10 - C30	C20	E01	
All engines											1.501.401	
LANTRA II												
1.5 12V	Petrol	65	12/96-10/00	G4EK								
Engine	Information			A10	A20	A40	A50	A70	C10 - C30	C20	E01	
All engines											1.499.119	
1.6 16V	Petrol	84	11/95-10/00	4G61								
Engine	Information			A10	A20	A40	A50	A70	C10 - C30	C20	E01	
All engines											1.501.385	

A10 CONDENSER	A20 CONTACT SET	A40 DISTRIBUTOR CAP	A50 ROTOR	A70 PICK-UP
C10 COIL	C20 IGNITION MODULE	C30 ELECTRONIC IGNITION KIT	E01 IGNITION CABLE SET	

The present application list is a brief version. For the detailed information about the possibility of installation on a specific vehicle, please refer to our web-catalogue <http://catalogo.facet.eu/>

				FUNCTIONS ON THE VEHICLE								
Vehicle	alim.	kW	Date	Engine								
				ENGINE								
1.6i	Petrol	66	11/95-10/00	G4GR								
				ENGINE								
Engine		Information			A10	A20	A40	A50	A70	C10 - C30	C20	E01
All engines												1.501.385
				ENGINE								
1.8 16V	Petrol	94	11/95-10/00	G4GM								
				ENGINE								
Engine		Information			A10	A20	A40	A50	A70	C10 - C30	C20	E01
All engines												1.501.385
				ENGINE								
2.0 16V	Petrol	102	11/95-10/00	G4GF								
				ENGINE								
Engine		Information			A10	A20	A40	A50	A70	C10 - C30	C20	E01
All engines												1.501.385
MATRIX												
				ENGINE								
1.6	Petrol	66	01/02-12/05	G4ED-L								
				ENGINE								
Engine		Information			A10	A20	A40	A50	A70	C10 - C30	C20	E01
All engines										1.970.582, 1.970.584	C10	1.499.111
All engines		Kit								1.970.586	C10	
				ENGINE								
1.6	Petrol	76	06/01-08/10	G4ED, G4ED-G								
				ENGINE								
Engine		Information			A10	A20	A40	A50	A70	C10 - C30	C20	E01
Eng. G4ED		x 1, D.I.S.								1.970.582	C10	
Eng. G4ED-G										1.970.582, 1.970.584	C10	1.499.111
Eng. G4ED-G		Kit								1.970.586	C10	
				ENGINE								
1.6 [TUR]	Petrol	76	04/08->	G4ED								
				ENGINE								
Engine		Information			A10	A20	A40	A50	A70	C10 - C30	C20	E01
All engines										1.970.582, 1.970.584	C10	1.499.111
All engines		Kit								1.970.586	C10	
				ENGINE								
1.8	Petrol	90	06/01-08/10	G4GB, G4GB-G								
				ENGINE								
Engine		Information			A10	A20	A40	A50	A70	C10 - C30	C20	E01
Eng. G4GB		01/10/02->, x 1, D.I.S.								1.970.581	C10	
Eng. G4GB-G		01/09/02->, Qty: 2								1.970.581	C10	
Eng. G4GB-G												1.501.385
				ENGINE								
1.8 [TUR]	Petrol	90	04/08->	G4GB								
				ENGINE								
Engine		Information			A10	A20	A40	A50	A70	C10 - C30	C20	E01
All engines		Qty: 2								1.970.581	C10	
All engines												1.501.385
NF												
				ENGINE								
2.0 CVT	Petrol	111	05/05-12/10	G4BPE								
				ENGINE								
Engine		Information			A10	A20	A40	A50	A70	C10 - C30	C20	E01
All engines		NF, ->year 01/12/07, x 4, COIL ON PLUG								1.970.492	C10	
All engines		NF, 01/01/08->, x 4, COIL ON PLUG								1.970.556	C10	
PONY												
				ENGINE								
1.3	Petrol	43	10/89-01/95	G4DG								
				ENGINE								
Engine		Information			A10	A20	A40	A50	A70	C10 - C30	C20	E01
All engines		version Mitsubishi					1.331.003/00	1.431.023				
				ENGINE								
1.3	Petrol	49	10/89-01/95	G4DG								
				ENGINE								
Engine		Information			A10	A20	A40	A50	A70	C10 - C30	C20	E01
All engines		version Mitsubishi					1.331.003/00	1.431.023				
				ENGINE								
1.3	Petrol	50	10/85-09/89	G13B								
				ENGINE								
Engine		Information			A10	A20	A40	A50	A70	C10 - C30	C20	E01
All engines		version Mitsubishi					1.331.003/00	1.431.023				

A10 CONDENSER	A20 CONTACT SET	A40 DISTRIBUTOR CAP	A50 ROTOR	A70 PICK-UP
C10 COIL	C20 IGNITION MODULE	C30 ELECTRONIC IGNITION KIT	E01 IGNITION CABLE SET	

Vehicle	alim.	kW	Date	Engine	FUNCTIONS ON THE VEHICLE									
					A10	A20	A40	A50	A70	C10 - C30	C20	E01		
ENGINE														
1.5	Petrol	53	10/85-01/95	G15B, G4DJ										
Engine		Information			A10	A20	A40	A50	A70	C10 - C30	C20	E01		
All engines		version Mitsubishi					1.331.003/00	1.431.023						
ENGINE														
1.5 i	Petrol	61	10/89-01/95	G15B, G4DJ										
Engine		Information			A10	A20	A40	A50	A70	C10 - C30	C20	E01		
All engines		version Mitsubishi					1.331.003/00	1.431.107						
ENGINE														
1.5 i	Petrol	62	10/89-01/95	G15B, G4DJ										
Engine		Information			A10	A20	A40	A50	A70	C10 - C30	C20	E01		
All engines		version Mitsubishi					1.331.003/00	1.431.107						
PONY / EXCEL														
ENGINE														
1.3	Petrol	48	12/92-09/94	G4DG										
Engine		Information			A10	A20	A40	A50	A70	C10 - C30	C20	E01		
All engines		version Mitsubishi					1.331.003/00	1.431.023						
ENGINE														
1.3	Petrol	49	01/90-01/95	G4DG										
Engine		Information			A10	A20	A40	A50	A70	C10 - C30	C20	E01		
All engines		version Mitsubishi					1.331.003/00	1.431.023						
ENGINE														
1.5	Petrol	53	01/90-01/95	G15B, G4DJ										
Engine		Information			A10	A20	A40	A50	A70	C10 - C30	C20	E01		
All engines		version Mitsubishi					1.331.003/00	1.431.023						
ENGINE														
1.5 i	Petrol	61	01/90-01/95	G15B, G4DJ										
Engine		Information			A10	A20	A40	A50	A70	C10 - C30	C20	E01		
All engines		version Mitsubishi					1.331.003/00	1.431.107						
ENGINE														
1.5 i	Petrol	62	01/90-01/95	G15B, G4DJ										
Engine		Information			A10	A20	A40	A50	A70	C10 - C30	C20	E01		
All engines		version Mitsubishi					1.331.003/00	1.431.107						
PORTER I														
ENGINE														
2.4	Petrol	82	03/96-04/04	G4CS										
Engine		Information			A10	A20	A40	A50	A70	C10 - C30	C20	E01		
All engines		version Mitsubishi					1.331.003/00	1.431.107						
PRECIS														
ENGINE														
1.5 i [USA]	Petrol	0	01/89->	G4DJ										
Engine		Information			A10	A20	A40	A50	A70	C10 - C30	C20	E01		
All engines		version Mitsubishi					1.331.003/00	1.431.107						
S COUPE														
ENGINE														
1.5 i	Petrol	62	02/90-05/96	G4DJ										
Engine		Information			A10	A20	A40	A50	A70	C10 - C30	C20	E01		
All engines		version Mitsubishi					1.331.003/00	1.431.107						
ENGINE														
1.5 i	Petrol	65	04/92-05/96	G4EK										
Engine		Information			A10	A20	A40	A50	A70	C10 - C30	C20	E01		
All engines		->year 01/04/94, version Bosch					1.306.124	1.406.121R	1.906.244					
All engines		01/04/94 ->											1.499.119	
ENGINE														
1.5 i Turbo	Petrol	85	04/91-05/96	G4EK-TC										
Engine		Information			A10	A20	A40	A50	A70	C10 - C30	C20	E01		
All engines		->year 01/04/94, version Bosch					1.306.124	1.406.121R	1.906.244					
All engines		01/04/94 ->											1.499.119	

A10	CONDENSER	A20	CONTACT SET	A40	DISTRIBUTOR CAP	A50	ROTOR	A70	PICK-UP
C10	COIL	C20	IGNITION MODULE	C30	ELECTRONIC IGNITION KIT	E01	IGNITION CABLE SET		

The present application list is a brief version. For the detailed information about the possibility of installation on a specific vehicle, please refer to our web-catalogue <http://catalogo.facet.eu/>

Vehicle	alim.	kW	Date	Engine	FUNCTIONS ON THE VEHICLE							
					A10	A20	A40	A50	A70	C10 - C30	C20	E01

SANTA FE I

Vehicle	alim.	kW	Date	ENGINE	A10	A20	A40	A50	A70	C10 - C30	C20	E01
2.0	Petrol	99	08/01-03/06	G4BP								
Engine Information					A10	A20	A40	A50	A70	C10 - C30	C20	E01
All engines												1.499.241
2.4 16V	Petrol	100	02/01-03/06	G4JS-G								
Engine Information					A10	A20	A40	A50	A70	C10 - C30	C20	E01
All engines												1.499.241
2.4 16V	Petrol	107	02/01-03/06	G4JS-G								
Engine Information					A10	A20	A40	A50	A70	C10 - C30	C20	E01
All engines												1.499.241
2.4 16V 4x4	Petrol	100	02/01-03/06	G4JS-G								
Engine Information					A10	A20	A40	A50	A70	C10 - C30	C20	E01
All engines												1.499.241
2.4 16V 4x4	Petrol	107	02/01-03/06	G4JS-G								
Engine Information					A10	A20	A40	A50	A70	C10 - C30	C20	E01
All engines												1.499.241
2.7 4x4	Petrol	129	09/02-12/04	G6BA								
Engine Information					A10	A20	A40	A50	A70	C10 - C30	C20	E01
All engines										1.970.580	C10	
All engines										1.970.587	C10	
2.7 V6 4x4	Petrol	127	02/01-03/06	G6BA, G6BA-G								
Engine Information					A10	A20	A40	A50	A70	C10 - C30	C20	E01
Eng. G6BA										1.970.579	C10	
Eng. G6BA-G										1.970.579	C10	
Eng. G6BA										1.970.580	C10	
Eng. G6BA-G										1.970.580	C10	
Eng. G6BA										1.970.587	C10	
Eng. G6BA-G										1.970.587	C10	
Eng. G6BA-G												1.499.236

SANTA FE II









Vehicle	alim.	kW	Date	ENGINE	A10	A20	A40	A50	A70	C10 - C30	C20	E01
2.4	Petrol	128	11/10-12/12	G4KE								
Engine Information					A10	A20	A40	A50	A70	C10 - C30	C20	E01
All engines										1.970.556	C10	
2.4 4x4	Petrol	128	07/10-12/12	G4KE								
Engine Information					A10	A20	A40	A50	A70	C10 - C30	C20	E01
All engines										1.970.556	C10	
3.3	Petrol	180	07/07-11/08	G6DB								
Engine Information					A10	A20	A40	A50	A70	C10 - C30	C20	E01
All engines										1.970.492	C10	
3.3 Dynamic 4x4	Petrol	173	03/06-12/12	G6DB								
Engine Information					A10	A20	A40	A50	A70	C10 - C30	C20	E01
All engines										1.970.492	C10	
3.5	Petrol	147	01/10->	--								
Engine Information					A10	A20	A40	A50	A70	C10 - C30	C20	E01
All engines										1.970.492	C10	
3.5 4x4	Petrol	203	08/11-12/12	G6DC								
Engine Information					A10	A20	A40	A50	A70	C10 - C30	C20	E01
All engines										1.970.492	C10	

A10 CONDENSER	A20 CONTACT SET	A40 DISTRIBUTOR CAP	A50 ROTOR	A70 PICK-UP
C10 COIL	C20 IGNITION MODULE	C30 ELECTRONIC IGNITION KIT	E01 IGNITION CABLE SET	

Vehicle	alim.	kW	Date	Engine	FUNCTIONS ON THE VEHICLE									
					A10	A20	A40	A50	A70	C10 - C30	C20	E01		
ENGINE														
3.5 4x4	Petrol	204	08/11-12/12	G6DC										
Engine	Information				A10	A20	A40	A50	A70	C10 - C30	C20	E01		
All engines	x 6, COIL ON PLUG									1.970.492	C10			
SANTA FE III														
ENGINE														
2.4	Petrol	141	09/12-12/15	G4KJ										
Engine	Information				A10	A20	A40	A50	A70	C10 - C30	C20	E01		
All engines	x 4, COIL ON PLUG									1.970.556	C10			
ENGINE														
2.4 4WD	Petrol	141	09/12->	G4KJ										
Engine	Information				A10	A20	A40	A50	A70	C10 - C30	C20	E01		
All engines	x 4, COIL ON PLUG									1.970.556	C10			
ENGINE														
2.4 CCVT	Petrol	126	07/18->	G4KE										
Engine	Information				A10	A20	A40	A50	A70	C10 - C30	C20	E01		
All engines	x 4, COIL ON PLUG									1.970.556	C10			
ENGINE														
2.4 CCVT	Petrol	129	09/12->	G4KE										
Engine	Information				A10	A20	A40	A50	A70	C10 - C30	C20	E01		
All engines	x 4, COIL ON PLUG									1.970.556	C10			
ENGINE														
2.4 CCVT AWD	Petrol	126	06/15->	G4KE										
Engine	Information				A10	A20	A40	A50	A70	C10 - C30	C20	E01		
All engines	x 4, COIL ON PLUG									1.970.556	C10			
ENGINE														
2.4 CCVT AWD	Petrol	129	09/12->	G4KE										
Engine	Information				A10	A20	A40	A50	A70	C10 - C30	C20	E01		
All engines	x 4, COIL ON PLUG									1.970.556	C10			
ENGINE														
2.4 GDI 4WD	Petrol	138	05/15->	G4KJ										
Engine	Information				A10	A20	A40	A50	A70	C10 - C30	C20	E01		
All engines	->year 01/01/17, euro 5, x 4, COIL ON PLUG									1.970.556	C10			
SANTA FE IV														
ENGINE														
2.4 AWD	Petrol	127	07/18->	G4KE										
Engine	Information				A10	A20	A40	A50	A70	C10 - C30	C20	E01		
All engines	x 4, COIL ON PLUG									1.970.556	C10			
ENGINE														
2.4 GDI AWD	Petrol	138	07/18->	G4KJ										
Engine	Information				A10	A20	A40	A50	A70	C10 - C30	C20	E01		
All engines	x 4, COIL ON PLUG									1.970.556	C10			
ENGINE														
3.5 MPI AWD	Petrol	183	07/19->	G6DC										
Engine	Information				A10	A20	A40	A50	A70	C10 - C30	C20	E01		
All engines	x 6, COIL ON PLUG									1.970.492	C10			
SANTAMO														
ENGINE														
2.0 16V	Petrol	102	05/99-12/02	G4JP										
Engine	Information				A10	A20	A40	A50	A70	C10 - C30	C20	E01		
All engines	SOHC/OHC, version Mitsubishi						1.331.003/00	1.431.107						
All engines	DOHC											1.501.401		
ENGINE														
2.0 16V 4x4	Petrol	102	05/99-12/02	G4CP-D										
Engine	Information				A10	A20	A40	A50	A70	C10 - C30	C20	E01		
All engines	SOHC/OHC, version Mitsubishi						1.331.003/00	1.431.107						
All engines	DOHC											1.501.401		

A10 CONDENSER	A20 CONTACT SET	A40 DISTRIBUTOR CAP	A50 ROTOR	A70 PICK-UP
C10 COIL	C20 IGNITION MODULE	C30 ELECTRONIC IGNITION KIT	E01 IGNITION CABLE SET	

The present application list is a brief version. For the detailed information about the possibility of installation on a specific vehicle, please refer to our web-catalogue <http://catalogo.facet.eu/>









					FUNCTIONS ON THE VEHICLE								
Vehicle	alim.	kW	Date	Engine	 A10	 A20	 A40	 A50	 A70	 C10 - C30	 C20	 E01	
SANTRO													
1.1	Petrol	0	01/03->	ENGINE G4HD									
Engine Information					A10	A20	A40	A50	A70	C10 - C30	C20	E01	
All engines Qty: 2										1.970.496	C10		
All engines												1.499.119	
SB 11													
1.4	Petrol	79	01/11->	ENGINE --									
Engine Information					A10	A20	A40	A50	A70	C10 - C30	C20	E01	
All engines Qty: 4										1.970.543	C10		
SOLARIS													
1.4	Petrol	74	01/17->	ENGINE G4LC									
Engine Information					A10	A20	A40	A50	A70	C10 - C30	C20	E01	
All engines Solaris, x 4, COIL ON PLUG										1.970.622	C10		
1.4 16V													
1.4 16V	Petrol	79	01/11->	ENGINE --									
Engine Information					A10	A20	A40	A50	A70	C10 - C30	C20	E01	
All engines Qty: 4										1.970.543	C10		
1.4 VVTi													
1.4 VVTi	Petrol	79	11/10->	ENGINE G4FA									
Engine Information					A10	A20	A40	A50	A70	C10 - C30	C20	E01	
All engines Solaris, x 4, COIL ON PLUG										1.970.543	C10		
1.6													
1.6	Petrol	90	01/17->	ENGINE G4FG									
Engine Information					A10	A20	A40	A50	A70	C10 - C30	C20	E01	
All engines Solaris, x 4, COIL ON PLUG										1.970.543	C10		
1.6 16V													
1.6 16V	Petrol	90	01/11->	ENGINE --									
Engine Information					A10	A20	A40	A50	A70	C10 - C30	C20	E01	
All engines Qty: 4										1.970.543	C10		
SONATA II													
2.0 i 16V	Petrol	96	01/91-10/93	ENGINE G4CP-D									
Engine Information					A10	A20	A40	A50	A70	C10 - C30	C20	E01	
All engines												1.501.401	
2.4 i													
2.4 i	Petrol	83	09/88-08/91	ENGINE G4CS									
Engine Information					A10	A20	A40	A50	A70	C10 - C30	C20	E01	
All engines version Mitsubishi							1.331.003/00	1.431.107					
3.0 i V6 [USA]													
3.0 i V6 [USA]	Petrol	106	01/88->	ENGINE G6AT									
Engine Information					A10	A20	A40	A50	A70	C10 - C30	C20	E01	
All engines version Mitsubishi								1.431.109					
SONATA III													
1.8 GLS	Petrol	63	07/96-05/98	ENGINE G4DM									
Engine Information					A10	A20	A40	A50	A70	C10 - C30	C20	E01	
All engines version Mitsubishi							1.331.003/00	1.431.107					
1.8 i													
1.8 i	Petrol	72	05/93-06/98	ENGINE G4CM									
Engine Information					A10	A20	A40	A50	A70	C10 - C30	C20	E01	
All engines version Mitsubishi							1.331.003/00	1.431.107					

A10 CONDENSER	A20 CONTACT SET	A40 DISTRIBUTOR CAP	A50 ROTOR	A70 PICK-UP
C10 COIL	C20 IGNITION MODULE	C30 ELECTRONIC IGNITION KIT	E01 IGNITION CABLE SET	

Vehicle	alim.	kW	Date	Engine	FUNCTIONS ON THE VEHICLE									
					A10	A20	A40	A50	A70	C10 - C30	C20	E01		
ENGINE														
2.0 i	Petrol	70	08/96-06/98	G4EP										
Engine		Information			A10	A20	A40	A50	A70	C10 - C30	C20	E01		
All engines		version Mitsubishi					1.331.003/00	1.431.107						
ENGINE														
2.0 i	Petrol	77	06/94-08/96	G4CP										
Engine		Information			A10	A20	A40	A50	A70	C10 - C30	C20	E01		
All engines		version Mitsubishi					1.331.003/00	1.431.107						
ENGINE														
2.0 i 16V	Petrol	102	05/93-06/98	G4CP-D										
Engine		Information			A10	A20	A40	A50	A70	C10 - C30	C20	E01		
All engines												1.501.401		
ENGINE														
2.0 i 16V	Petrol	92	06/96-06/98	G4CP-DM										
Engine		Information			A10	A20	A40	A50	A70	C10 - C30	C20	E01		
All engines												1.501.401		
ENGINE														
3.0 i V6	Petrol	107	05/93-06/98	G6AT										
Engine		Information			A10	A20	A40	A50	A70	C10 - C30	C20	E01		
All engines		version Mitsubishi						1.431.109						
SONATA IV														
ENGINE														
2.0 16V	Petrol	100	06/98-10/01	G4JP-G										
Engine		Information			A10	A20	A40	A50	A70	C10 - C30	C20	E01		
All engines												1.499.241		
ENGINE														
2.0 16V	Petrol	96	10/01-11/04	G4JP-EG										
Engine		Information			A10	A20	A40	A50	A70	C10 - C30	C20	E01		
All engines												1.499.241		
ENGINE														
2.4 16V	Petrol	105	03/98-10/01	G4BS										
Engine		Information			A10	A20	A40	A50	A70	C10 - C30	C20	E01		
All engines												1.499.241		
SONATA V														
ENGINE														
2.0 [RUS]	Petrol	0	01/05-04/06	--										
Engine		Information			A10	A20	A40	A50	A70	C10 - C30	C20	E01		
All engines												1.499.241		
ENGINE														
2.0 GLSI	Petrol	119	07/08-12/10	G4KD										
Engine		Information			A10	A20	A40	A50	A70	C10 - C30	C20	E01		
All engines		x 4, COIL ON PLUG								1.970.556	C10			
ENGINE														
2.0 i [RUS]	Petrol	0	04/06-12/10	--										
Engine		Information			A10	A20	A40	A50	A70	C10 - C30	C20	E01		
All engines		Qty: 2								1.970.581	C10			
All engines												1.501.385		
ENGINE														
2.0 VVTi GLS	Petrol	106	05/05-12/10	G4KA										
Engine		Information			A10	A20	A40	A50	A70	C10 - C30	C20	E01		
All engines		->year 01/12/07, x 4, COIL ON PLUG								1.970.492	C10			
All engines		01/01/08 ->, x 4, COIL ON PLUG								1.970.556	C10			
ENGINE														
2.0 VVTi GLS	Petrol	121	01/08-12/10	G4KD										
Engine		Information			A10	A20	A40	A50	A70	C10 - C30	C20	E01		
All engines		x 4, COIL ON PLUG								1.970.556	C10			
ENGINE														
2.4	Petrol	119	01/05-12/10	G4KC										
Engine		Information			A10	A20	A40	A50	A70	C10 - C30	C20	E01		
All engines		->year 01/11/07, x 4, COIL ON PLUG								1.970.492	C10			
All engines		01/12/07 ->, x 4, COIL ON PLUG								1.970.556	C10			

A10	CONDENSER	A20	CONTACT SET	A40	DISTRIBUTOR CAP	A50	ROTOR	A70	PICK-UP
C10	COIL	C20	IGNITION MODULE	C30	ELECTRONIC IGNITION KIT	E01	IGNITION CABLE SET		

The present application list is a brief version. For the detailed information about the possibility of installation on a specific vehicle, please refer to our web-catalogue <http://catalogo.facet.eu/>

				FUNCTIONS ON THE VEHICLE								
Vehicle	alim.	kW	Date	Engine								
				ENGINE								
2.4	Petrol	125	06/08-12/09	G4KC								
		Engine Information			A10	A20	A40	A50	A70	C10 - C30	C20	E01
		All engines Qty: 4								1.970.492	C10	
				ENGINE								
2.4	Petrol	128	06/08-12/10	G4KE								
		Engine Information			A10	A20	A40	A50	A70	C10 - C30	C20	E01
		All engines Qty: 4								1.970.556	C10	
				ENGINE								
2.4	Petrol	132	11/07-12/10	G4KC								
		Engine Information			A10	A20	A40	A50	A70	C10 - C30	C20	E01
		All engines Qty: 4								1.970.492	C10	
				ENGINE								
3.3	Petrol	171	01/05-12/10	G6DB								
		Engine Information			A10	A20	A40	A50	A70	C10 - C30	C20	E01
		All engines x 6, COIL ON PLUG								1.970.492	C10	
				ENGINE								
3.3	Petrol	173	06/05-12/10	G6DB								
		Engine Information			A10	A20	A40	A50	A70	C10 - C30	C20	E01
		All engines x 6, COIL ON PLUG								1.970.492	C10	
				ENGINE								
3.3	Petrol	184	01/08-12/10	G6DB								
		Engine Information			A10	A20	A40	A50	A70	C10 - C30	C20	E01
		All engines x 6, COIL ON PLUG								1.970.492	C10	
				ENGINE								
3.3	Petrol	186	09/07-12/08	G6DB								
		Engine Information			A10	A20	A40	A50	A70	C10 - C30	C20	E01
		All engines x 6, COIL ON PLUG								1.970.492	C10	
				ENGINE								
2.0	Petrol	110	06/09-06/14	G4KD								
		Engine Information			A10	A20	A40	A50	A70	C10 - C30	C20	E01
		All engines x 4, COIL ON PLUG								1.970.556	C10	
				ENGINE								
2.0 i	Petrol	121	01/11-06/14	G4KD								
		Engine Information			A10	A20	A40	A50	A70	C10 - C30	C20	E01
		All engines Qty: 4								1.970.556	C10	
				ENGINE								
2.4	Petrol	128	06/09-11/10	G4KC								
		Engine Information			A10	A20	A40	A50	A70	C10 - C30	C20	E01
		All engines x 4, COIL ON PLUG								1.970.556	C10	
				ENGINE								
2.4	Petrol	131	11/10-12/15	G4KC								
		Engine Information			A10	A20	A40	A50	A70	C10 - C30	C20	E01
		All engines x 4, COIL ON PLUG								1.970.556	C10	
				ENGINE								
3.3 CVT	Petrol	186	03/09-12/10	G6DB								
		Engine Information			A10	A20	A40	A50	A70	C10 - C30	C20	E01
		All engines Sonica, x 6, COIL ON PLUG								1.970.492	C10	
				ENGINE								
1.4	Petrol	50	10/83-08/86	4G33								
		Engine Information			A10	A20	A40	A50	A70	C10 - C30	C20	E01
		All engines version Mitsubishi				1.231.084	1.331.003/00	1.431.023				
				ENGINE								
1.6	Petrol	56	10/83-12/91	G32B								
		Engine Information			A10	A20	A40	A50	A70	C10 - C30	C20	E01
		All engines version Mitsubishi				1.231.084	1.331.003/00	1.431.023				

A10 CONDENSER	A20 CONTACT SET	A40 DISTRIBUTOR CAP	A50 ROTOR	A70 PICK-UP
C10 COIL	C20 IGNITION MODULE	C30 ELECTRONIC IGNITION KIT	E01 IGNITION CABLE SET	

Vehicle	alim.	kW	Date	Engine	FUNCTIONS ON THE VEHICLE							
					A10	A20	A40	A50	A70	C10 - C30	C20	E01

TIBURON

1.6 i 16V	Petrol	79	08/00->	ENGINE G4GL
-----------	--------	----	---------	----------------

Engine	Information	A10	A20	A40	A50	A70	C10 - C30	C20	E01
All engines									1.501.385

1.6 i 16V	Petrol	84	08/99->	ENGINE G4GR
-----------	--------	----	---------	----------------

Engine	Information	A10	A20	A40	A50	A70	C10 - C30	C20	E01
All engines									1.501.385

2.0 i 16V	Petrol	101	08/99->	ENGINE G4DF
-----------	--------	-----	---------	----------------

Engine	Information	A10	A20	A40	A50	A70	C10 - C30	C20	E01
All engines									1.501.385

TRAJET

2.0	Petrol	100	03/00-07/08	ENGINE G4JP-G
-----	--------	-----	-------------	------------------

Engine	Information	A10	A20	A40	A50	A70	C10 - C30	C20	E01
All engines	01/02/04 ->, Qty: 2						1.970.581	C10	
All engines	->year 01/02/04								1.499.241
All engines	01/02/04 ->								1.501.385

2.0	Petrol	103	01/04-07/08	ENGINE G4GC, G4GC-G
-----	--------	-----	-------------	------------------------

Engine	Information	A10	A20	A40	A50	A70	C10 - C30	C20	E01
Eng. G4GC	01/03/04 ->, x 1, D.I.S.						1.970.581	C10	
Eng. G4GC-G	01/02/04 ->, Qty: 2						1.970.581	C10	
Eng. G4GC-G	->year 01/02/04								1.499.241
Eng. G4GC-G	01/02/04 ->								1.501.385

2.0	Petrol	104	11/03-07/08	ENGINE G4GC
-----	--------	-----	-------------	----------------

Engine	Information	A10	A20	A40	A50	A70	C10 - C30	C20	E01
All engines	01/03/04 ->, x 1, D.I.S.						1.970.581	C10	
All engines	->year 01/02/04								1.499.241
All engines	01/02/04 ->								1.501.385

2.0 CRDi	Diesel	92	08/05-07/08	ENGINE D4EA
----------	--------	----	-------------	----------------

Engine	Information	A10	A20	A40	A50	A70	C10 - C30	C20	E01
All engines	01/02/04 ->, Qty: 2						1.970.581	C10	
All engines	->year 01/02/04								1.499.241
All engines	01/02/04 ->								1.501.385

CWT	Petrol	103	01/04-07/08	ENGINE G4GC
-----	--------	-----	-------------	----------------

Engine	Information	A10	A20	A40	A50	A70	C10 - C30	C20	E01
All engines	01/03/04 ->, x 1, D.I.S.						1.970.581	C10	

TUCSON

1.6 GDi	Petrol	97	06/15-09/20	ENGINE G4FD
---------	--------	----	-------------	----------------

Engine	Information	A10	A20	A40	A50	A70	C10 - C30	C20	E01
All engines	Tucson, x 4, COIL ON PLUG						1.970.611	C10	

2.0	Petrol	104	08/04->	ENGINE G4GC
-----	--------	-----	---------	----------------

Engine	Information	A10	A20	A40	A50	A70	C10 - C30	C20	E01
All engines	Tucson, x 1, D.I.S.						1.970.581	C10	
All engines									1.501.385

2.0	Petrol	105	01/07-01/12	ENGINE G4GC
-----	--------	-----	-------------	----------------

Engine	Information	A10	A20	A40	A50	A70	C10 - C30	C20	E01
All engines	Qty: 2						1.970.581	C10	
All engines									1.501.385









A10	CONDENSER	A20	CONTACT SET	A40	DISTRIBUTOR CAP	A50	ROTOR	A70	PICK-UP
C10	COIL	C20	IGNITION MODULE	C30	ELECTRONIC IGNITION KIT	E01	IGNITION CABLE SET		

The present application list is a brief version. For the detailed information about the possibility of installation on a specific vehicle, please refer to our web-catalogue <http://catalogo.facet.eu/>

Vehicle	alim.	kW	Date	Engine	FUNCTIONS ON THE VEHICLE								
					A10	A20	A40	A50	A70	C10 - C30	C20	E01	
ENGINE													
1.5	Petrol	66	09/99->	G4EB									
ENGINE													
G4EB													
ENGINE													
G4EC-G													
1.5	Petrol	75	09/99->	G4EC-G									
ENGINE													
G4EC-G													
ENGINE													
G4ED-G													
1.6	Petrol	77	12/02->	G4ED-G									
ENGINE													
G4ED-G													
ENGINE													
G4ED-G													

A10	CONDENSER	A20	CONTACT SET	A40	DISTRIBUTOR CAP	A50	ROTOR	A70	PICK-UP
C10	COIL	C20	IGNITION MODULE	C30	ELECTRONIC IGNITION KIT	E01	IGNITION CABLE SET		

The present application list is a brief version. For the detailed information about the possibility of installation on a specific vehicle, please refer to our web-catalogue <http://catalogo.facet.eu/>









					FUNCTIONS ON THE VEHICLE							
Vehicle	alim.	kW	Date	Engine	 A10	 A20	 A40	 A50	 A70	 C10 - C30	 C20	 E01
EX35												
3.5 V6	Petrol	221	04/08->	ENGINE VQ35HR								
Engine	Information				A10	A20	A40	A50	A70	C10 - C30	C20	E01
All engines	Qty: 6									1.970.533	C10	
FX												
35	Petrol	205	07/08-10/09	ENGINE VQ35HR								
Engine	Information				A10	A20	A40	A50	A70	C10 - C30	C20	E01
All engines	FX35, x 6, COIL ON PLUG									1.970.533	C10	
35	Petrol	226	10/08-12/11	ENGINE VQ35HR								
Engine	Information				A10	A20	A40	A50	A70	C10 - C30	C20	E01
All engines	FX35, x 6, COIL ON PLUG									1.970.533	C10	
35 AWD	Petrol	205	07/08-05/09	ENGINE VQ35HR								
Engine	Information				A10	A20	A40	A50	A70	C10 - C30	C20	E01
All engines	FX35, x 6, COIL ON PLUG									1.970.533	C10	
35 AWD	Petrol	226	02/09-12/10	ENGINE VQ35HR								
Engine	Information				A10	A20	A40	A50	A70	C10 - C30	C20	E01
All engines	FX35, x 6, COIL ON PLUG									1.970.533	C10	
50 AWD	Petrol	287	10/08->	ENGINE VK50VE								
Engine	Information				A10	A20	A40	A50	A70	C10 - C30	C20	E01
All engines	FX50, ->year 01/12/10, x 8, COIL ON PLUG									1.970.552	C10	
50 AWD	Petrol	291	10/08->	ENGINE VK50VE								
Engine	Information				A10	A20	A40	A50	A70	C10 - C30	C20	E01
All engines	FX50, ->year 01/12/10, x 8, COIL ON PLUG									1.970.552	C10	
50 AWD	Petrol	309	06/13-07/13	ENGINE VK50VE								
Engine	Information				A10	A20	A40	A50	A70	C10 - C30	C20	E01
All engines	FX50, Fitting Position:for cylinder 1, Fitting Position:for cylinder 2, Fitting Position:for cylinder 3, Fitting Position:for cylinder 5, Fitting Position:for cylinder 6, Fitting Position:for cylinder 7, x 8, COIL ON PLUG									1.970.552	C10	
G												
25	Petrol	163	01/11->	ENGINE VQ25HR								
Engine	Information				A10	A20	A40	A50	A70	C10 - C30	C20	E01
All engines	G25, x 6, COIL ON PLUG									1.970.533	C10	
35 X	Petrol	228	01/07-12/08	ENGINE VQ35HR								
Engine	Information				A10	A20	A40	A50	A70	C10 - C30	C20	E01
All engines	G35, x 6, COIL ON PLUG									1.970.533	C10	
G SERIES												
3.5 V6	Petrol	228	12/06->	ENGINE VQ35HR								
Engine	Information				A10	A20	A40	A50	A70	C10 - C30	C20	E01
All engines	Qty: 6									1.970.533	C10	
G20												
2.0	Petrol	85	01/90-12/97	ENGINE SR20DE								
Engine	Information				A10	A20	A40	A50	A70	C10 - C30	C20	E01
All engines	->year 31/12/93, version Hitachi						1.322.073	1.422.085				
All engines	01/01/94 ->, version Mitsubishi						1.331.151	1.431.136				
JX												
3.5 AWD	Petrol	195	11/12-09/13	ENGINE VQ35DE								
Engine	Information				A10	A20	A40	A50	A70	C10 - C30	C20	E01
All engines	JX35, x 6, COIL ON PLUG									1.970.533	C10	

A10 CONDENSER	A20 CONTACT SET	A40 DISTRIBUTOR CAP	A50 ROTOR	A70 PICK-UP
C10 COIL	C20 IGNITION MODULE	C30 ELECTRONIC IGNITION KIT	E01 IGNITION CABLE SET	

Vehicle	alim.	kW	Date	Engine	FUNCTIONS ON THE VEHICLE									
					A10	A20	A40	A50	A70	C10 - C30	C20	E01		
M														
25	Petrol	163	07/10->	ENGINE VQ25HR										
Engine		Information			A10	A20	A40	A50	A70	C10 - C30	C20	E01		
All engines		M25, x 6, COIL ON PLUG								1.970.533	C10			
35h														
35h	Petrol/ Electric	225	04/11->	ENGINE VQ35HR										
Engine		Information			A10	A20	A40	A50	A70	C10 - C30	C20	E01		
All engines		M35h, x 6, COIL ON PLUG								1.970.533	C10			
56														
56	Petrol	300	03/10->	ENGINE VK56VD										
Engine		Information			A10	A20	A40	A50	A70	C10 - C30	C20	E01		
All engines		M56, Fitting Position:for cylinder 1-6, x 8, COIL ON PLUG								1.970.552	C10			
56 X														
56 X	Petrol	300	03/10->	ENGINE VK56VD										
Engine		Information			A10	A20	A40	A50	A70	C10 - C30	C20	E01		
All engines		M56, Fitting Position:for cylinder 1, Fitting Position:for cylinder 2, Fitting Position:for cylinder 3, Fitting Position:for cylinder 5, Fitting Position:for cylinder 6, Fitting Position:for cylinder 7, x 8, COIL ON PLUG								1.970.552	C10			
M35														
3.5	Petrol	226	09/08-12/10	ENGINE VQ35HR										
Engine		Information			A10	A20	A40	A50	A70	C10 - C30	C20	E01		
All engines		x 6, COIL ON PLUG								1.970.533	C10			
3.5 h														
3.5 h	Petrol/ Electric	268	01/10->	ENGINE VQ35HR										
Engine		Information			A10	A20	A40	A50	A70	C10 - C30	C20	E01		
All engines		M35h, x 6, COIL ON PLUG								1.970.533	C10			
3.5 X														
3.5 X	Petrol	226	09/08-12/10	ENGINE VQ35HR										
Engine		Information			A10	A20	A40	A50	A70	C10 - C30	C20	E01		
All engines		x 6, COIL ON PLUG								1.970.533	C10			
Q30														
2.0 T	Petrol	155	11/15->	ENGINE 270920										
Engine		Information			A10	A20	A40	A50	A70	C10 - C30	C20	E01		
All engines		x 4, COIL ON PLUG								1.970.626	C10			
2.0 T AWD														
2.0 T AWD	Petrol	155	11/15->	ENGINE 270920										
Engine		Information			A10	A20	A40	A50	A70	C10 - C30	C20	E01		
All engines		x 4, COIL ON PLUG								1.970.626	C10			
Q50														
2.0 T	Petrol	155	04/14->	ENGINE M 274										
Engine		Information			A10	A20	A40	A50	A70	C10 - C30	C20	E01		
All engines		x 4, COIL ON PLUG								1.970.626	C10			
50 Hybrid														
50 Hybrid	Petrol/ Electric	219	06/13->	ENGINE VQ35HR										
Engine		Information			A10	A20	A40	A50	A70	C10 - C30	C20	E01		
All engines		x 6, COIL ON PLUG								1.970.533	C10			
50 Hybrid														
50 Hybrid	Petrol/ Electric	225	04/13->	ENGINE VQ35HR										
Engine		Information			A10	A20	A40	A50	A70	C10 - C30	C20	E01		
All engines		x 6, COIL ON PLUG								1.970.533	C10			
50 Hybrid														
50 Hybrid	Petrol/ Electric	268	04/13->	ENGINE VQ35HR										
Engine		Information			A10	A20	A40	A50	A70	C10 - C30	C20	E01		
All engines		x 6, COIL ON PLUG								1.970.533	C10			

A10 CONDENSER	A20 CONTACT SET	A40 DISTRIBUTOR CAP	A50 ROTOR	A70 PICK-UP
C10 COIL	C20 IGNITION MODULE	C30 ELECTRONIC IGNITION KIT	E01 IGNITION CABLE SET	

The present application list is a brief version. For the detailed information about the possibility of installation on a specific vehicle, please refer to our web-catalogue <http://catalogo.facet.eu/>

					FUNCTIONS ON THE VEHICLE							
Vehicle	alim.	kW	Date	Engine								
QX70												
50 Hybrid AWD	Petrol/ Electric	219	06/13->	ENGINE VQ35HR								
Engine Information					A10	A20	A40	A50	A70	C10 - C30	C20	E01
All engines x 6, COIL ON PLUG										1,970.533	C10	
50 Hybrid AWD	Petrol/ Electric	225	04/13->	ENGINE VQ35HR								
Engine Information					A10	A20	A40	A50	A70	C10 - C30	C20	E01
All engines x 6, COIL ON PLUG										1,970.533	C10	
50 Hybrid AWD	Petrol/ Electric	268	04/13->	ENGINE VQ35HR								
Engine Information					A10	A20	A40	A50	A70	C10 - C30	C20	E01
All engines x 6, COIL ON PLUG										1,970.533	C10	
QX60												
2.0 T	Petrol	155	09/16->	ENGINE M 274								
Engine Information					A10	A20	A40	A50	A70	C10 - C30	C20	E01
All engines x 4, COIL ON PLUG										1,970.626	C10	
QX70												
2.5	Petrol	163	05/15->	ENGINE VQ25HR								
Engine Information					A10	A20	A40	A50	A70	C10 - C30	C20	E01
All engines x 6, COIL ON PLUG										1,970.533	C10	
3.5 Hybrid	Petrol/ Electric	225	03/13->	ENGINE VQ35HR								
Engine Information					A10	A20	A40	A50	A70	C10 - C30	C20	E01
All engines x 6, COIL ON PLUG										1,970.533	C10	
5.6 AWD	Petrol	300	01/15->	ENGINE VK56VD								
Engine Information					A10	A20	A40	A50	A70	C10 - C30	C20	E01
All engines Fitting Position:for cylinder 1, Fitting Position:for cylinder 2, Fitting Position:for cylinder 3, Fitting Position:for cylinder 5, Fitting Position:for cylinder 6, Fitting Position:for cylinder 7, x 6, COIL ON PLUG										1,970.552	C10	
QX30												
2.0 AWD	Petrol	155	09/16->	ENGINE 270920								
Engine Information					A10	A20	A40	A50	A70	C10 - C30	C20	E01
All engines x 4, COIL ON PLUG										1,970.626	C10	
QX50												
2.5 AWD	Petrol	163	02/14->	ENGINE VQ25HR								
Engine Information					A10	A20	A40	A50	A70	C10 - C30	C20	E01
All engines x 6, COIL ON PLUG										1,970.533	C10	
QX60												
3.5 AWD	Petrol	193	10/13->	ENGINE VQ35DE								
Engine Information					A10	A20	A40	A50	A70	C10 - C30	C20	E01
All engines x 6, COIL ON PLUG										1,970.533	C10	
QX70												
50 AWD	Petrol	287	08/13->	ENGINE VK50VE								
Engine Information					A10	A20	A40	A50	A70	C10 - C30	C20	E01
All engines x 8, COIL ON PLUG										1,970.552	C10	
50 AWD	Petrol	294	08/13->	ENGINE VK50VE								
Engine Information					A10	A20	A40	A50	A70	C10 - C30	C20	E01
All engines Fitting Position:for cylinder 1, Fitting Position:for cylinder 2, Fitting Position:for cylinder 3, Fitting Position:for cylinder 5, Fitting Position:for cylinder 6, Fitting Position:for cylinder 7, x 8, COIL ON PLUG										1,970.552	C10	

A10 CONDENSER	A20 CONTACT SET	A40 DISTRIBUTOR CAP	A50 ROTOR	A70 PICK-UP
C10 COIL	C20 IGNITION MODULE	C30 ELECTRONIC IGNITION KIT	E01 IGNITION CABLE SET	

Vehicle	alim.	kW	Date	Engine	FUNCTIONS ON THE VEHICLE							
					A10	A20	A40	A50	A70	C10 - C30	C20	E01

ELBA

				ENGINE
1.3	Petrol	49	08/91-12/96	146 A5.000

Engine	Information	A10	A20	A40	A50	A70	C10 - C30	C20	E01
All engines	version Marelli			1.330.101		1.930.176M			
All engines	no specific info conc. application available, version Marelli				1.430.047R, 1.430.060				
All engines							1.970.158	C10	1.965.020

				ENGINE
1.4 i.e.	Petrol	49	09/94-12/96	146 C5.000, 146 D5.000

Engine	Information	A10	A20	A40	A50	A70	C10 - C30	C20	E01
Eng. 146 C5.000	version Marelli			1.330.114	1.430.060				
Eng. 146 C5.000							1.970.148	C10	
Eng. 146 D5.000							1.970.188	C10	1.500.655

				ENGINE
1.5 i.e.	Petrol	55	08/92-09/94	149 C1.000

Engine	Information	A10	A20	A40	A50	A70	C10 - C30	C20	E01
All engines	->year 31/05/93, version Marelli			1.330.104					
All engines	01/06/93 ->, version Marelli			1.330.114					
All engines	version Marelli				1.430.059				
All engines							1.970.148	C10	

				ENGINE
1.6 i.e.	Petrol	55	09/94-12/96	146 C6.000, 146 D6.000

Engine	Information	A10	A20	A40	A50	A70	C10 - C30	C20	E01
Eng. 146 C6.000	version Marelli			1.330.115	1.430.059	1.930.177/1			
Eng. 146 C6.000							1.970.148	C10	
Eng. 146 D6.000							1.970.188	C10	1.500.655

MILLE

				ENGINE
1.0i	Petrol	35	02/93-02/98	146 C7.000

Engine	Information	A10	A20	A40	A50	A70	C10 - C30	C20	E01
All engines	Qty: 2						1.970.146	C10	

A10	CONDENSER	A20	CONTACT SET	A40	DISTRIBUTOR CAP	A50	ROTOR	A70	PICK-UP
C10	COIL	C20	IGNITION MODULE	C30	ELECTRONIC IGNITION KIT	E01	IGNITION CABLE SET		

The present application list is a brief version. For the detailed information about the possibility of installation on a specific vehicle, please refer to our web-catalogue <http://catalogo.facet.eu/>

Vehicle	alim.	kW	Date	Engine	FUNCTIONS ON THE VEHICLE							
					A10	A20	A40	A50	A70	C10 - C30	C20	E01

IMPULSE

1.6i [USA]	Petrol	0	01/90->	ENGINE
				RLK

Engine	Information	A10	A20	A40	A50	A70	C10 - C30	C20	E01
All engines	version Delco Remy			1.312.075	1.412.098				

1.8i [USA]	Petrol	0	01/91->	ENGINE
				RLX

Engine	Information	A10	A20	A40	A50	A70	C10 - C30	C20	E01
All engines	version Delco Remy			1.312.075	1.412.098				

PICK-UP

3.1i V6 [USA]	Petrol	0	01/90->	ENGINE
				LG 6

Engine	Information	A10	A20	A40	A50	A70	C10 - C30	C20	E01
All engines								1.965.025	

RODEO

3.1i V6 [USA]	Petrol	0	01/90-12/92	ENGINE
				LG 6

Engine	Information	A10	A20	A40	A50	A70	C10 - C30	C20	E01
All engines								1.965.025	

STYLUS

1.6i DOHC [USA]	Petrol	0	01/90-12/91	ENGINE
				RLK

Engine	Information	A10	A20	A40	A50	A70	C10 - C30	C20	E01
All engines	version Delco Remy			1.312.075	1.412.098				

1.6i SOHC [USA]	Petrol	0	01/90->	ENGINE
				RLR

Engine	Information	A10	A20	A40	A50	A70	C10 - C30	C20	E01
All engines	version Delco Remy			1.312.075	1.412.098				

1.8i DOHC [USA]	Petrol	0	01/91->	ENGINE
				RLX

Engine	Information	A10	A20	A40	A50	A70	C10 - C30	C20	E01
All engines	version Delco Remy			1.312.075	1.412.098				

TROOPER

2.3	Petrol	66	11/85-12/91	ENGINE
				4ZD1

Engine	Information	A10	A20	A40	A50	A70	C10 - C30	C20	E01
All engines							1.970.219	C10	

2.6 4WD	Petrol	85	11/86-07/91	ENGINE
				4ZE1

Engine	Information	A10	A20	A40	A50	A70	C10 - C30	C20	E01
All engines	version Hitachi				1.422.069				

2.6 i	Petrol	85	10/87-12/91	ENGINE
				4ZE1

Engine	Information	A10	A20	A40	A50	A70	C10 - C30	C20	E01
All engines	version Hitachi				1.422.069				

3.2i V6 [USA]	Petrol	0	01/88-12/91	ENGINE
				--

Engine	Information	A10	A20	A40	A50	A70	C10 - C30	C20	E01
All engines								1.965.025	

A10 CONDENSER	A20 CONTACT SET	A40 DISTRIBUTOR CAP	A50 ROTOR	A70 PICK-UP
C10 COIL	C20 IGNITION MODULE	C30 ELECTRONIC IGNITION KIT	E01 IGNITION CABLE SET	

Vehicle	alim.	kW	Date	Engine	FUNCTIONS ON THE VEHICLE							
					A10	A20	A40	A50	A70	C10 - C30	C20	E01
DAILY												
2.8 CNG	CNG	78	07/99-12/06	ENGINE 8149.03								
Engine	Information				A10	A20	A40	A50	A70	C10 - C30	C20	E01
All engines	Daily 35C11, Daily 35C11P, Daily 35S11, Daily 35S11P, Daily 40C11, Daily 40C11P, Daily 60C11, Daily 65C11, Daily 65C11P, x 1, D.I.S.									1.970.345	C10	
3.0 CNG	CNG	100	06/06-02/14	ENGINE F1CE0441A								
Engine	Information				A10	A20	A40	A50	A70	C10 - C30	C20	E01
All engines	Daily 50C14, Daily 50C14P, Daily 60C14, x 4, COIL ON PLUG									1.970.442	C10	
3.0 CNG	CNG	103	09/09-08/11	ENGINE F1CE0441A								
Engine	Information				A10	A20	A40	A50	A70	C10 - C30	C20	E01
All engines	Daily 70C14, Daily 70C14P, x 4, COIL ON PLUG									1.970.442	C10	
DAILY II												
2.8 CNG	CNG	78	05/99-07/07	ENGINE 8149.03								
Engine	Information				A10	A20	A40	A50	A70	C10 - C30	C20	E01
All engines	Daily 35C11, x 1, D.I.S.									1.970.345	C10	
50 C 11 Natural Power	CNG	78	05/99-04/06	ENGINE 8149.03								
Engine	Information				A10	A20	A40	A50	A70	C10 - C30	C20	E01
All engines	Daily 50C11, x 1, D.I.S.									1.970.345	C10	
DAILY III												
50 C 11 Natural Power	CNG	78	05/02-05/06	ENGINE 8149.03								
Engine	Information				A10	A20	A40	A50	A70	C10 - C30	C20	E01
All engines	Daily 50C11, x 1, D.I.S.									1.970.345	C10	
DAILY IV												
35C14 G, 35C14 G/P, 35S14 G, 35S14 G/P, 35C14 GD,...	CNG	100	07/07-08/11	ENGINE F1CE0441A								
Engine	Information				A10	A20	A40	A50	A70	C10 - C30	C20	E01
All engines	Daily 35C14, x 4, COIL ON PLUG									1.970.442	C10	
35C14 GV, 35C14 GV/P, 35S14 GV, 35S14 GV/P	CNG	100	07/07-08/11	ENGINE F1CE0441A								
Engine	Information				A10	A20	A40	A50	A70	C10 - C30	C20	E01
All engines	Daily 35C14, x 4, COIL ON PLUG									1.970.442	C10	
40C14 G, 40C14 G/P	CNG	100	07/07-08/11	ENGINE F1CE0441A								
Engine	Information				A10	A20	A40	A50	A70	C10 - C30	C20	E01
All engines	Daily 40C14, x 4, COIL ON PLUG									1.970.442	C10	
40C14 GV, 40C14 GV/P	CNG	100	07/07-08/11	ENGINE F1CE0441A								
Engine	Information				A10	A20	A40	A50	A70	C10 - C30	C20	E01
All engines	Daily 40C14, x 4, COIL ON PLUG									1.970.442	C10	
50C14 G, 50C14 G/P, 50C14 GD, 50C14 GD/P	CNG	100	07/07-08/11	ENGINE F1CE0441A								
Engine	Information				A10	A20	A40	A50	A70	C10 - C30	C20	E01
All engines	Daily 50C14, x 4, COIL ON PLUG									1.970.442	C10	
50C14 GV, 50C14 GV/P	CNG	100	07/07-08/11	ENGINE F1CE0441A								
Engine	Information				A10	A20	A40	A50	A70	C10 - C30	C20	E01
All engines	Daily 50C14, x 4, COIL ON PLUG									1.970.442	C10	

A10 CONDENSER	A20 CONTACT SET	A40 DISTRIBUTOR CAP	A50 ROTOR	A70 PICK-UP
C10 COIL	C20 IGNITION MODULE	C30 ELECTRONIC IGNITION KIT	E01 IGNITION CABLE SET	

The present application list is a brief version. For the detailed information about the possibility of installation on a specific vehicle, please refer to our web-catalogue <http://catalogo.facet.eu/>

Vehicle	alim.	kW	Date	Engine	FUNCTIONS ON THE VEHICLE									
					A10	A20	A40	A50	A70	C10 - C30	C20	E01		
ENGINE														
65C14 G, 65C14 G/P, 65C14 GD, 65C14 GD/P	CNG	100	07/07-08/11	F1CE0441A										
Engine		Information			A10	A20	A40	A50	A70	C10 - C30	C20	E01		
All engines		Daily 65C14, x 4, COIL ON PLUG								1.970.442	C10			
ENGINE														
Natural Power 35S14, 35C14, 40C14, 50C14, 65C14, 70C14	CNG	100	09/11-02/14	F1CE0441A										
Engine		Information			A10	A20	A40	A50	A70	C10 - C30	C20	E01		
All engines		Daily 35C14, x 4, COIL ON PLUG								1.970.442	C10			
ENGINE														
Natural Power 35S14, 35C14, 40C14, 50C14, 60C14, 65C14,...	CNG	100	09/11-02/14	F1CE0441A										
Engine		Information			A10	A20	A40	A50	A70	C10 - C30	C20	E01		
All engines		Daily 35C14, x 4, COIL ON PLUG								1.970.442	C10			
DAILY V														
ENGINE														
Natural Power 35S14, 35C14, 40C14, 50C14, 60C14, 65C14,...	CNG	100	03/14->	F1CFA401A, F1CFA401B, F1CFA401C										
Engine		Information			A10	A20	A40	A50	A70	C10 - C30	C20	E01		
All engines		Daily 35C14, Daily 50C14, x 4, COIL ON PLUG								1.970.442	C10			
ENGINE														
Natural Power 40C14, 50C14, 60C14	CNG	100	03/14->	F1CFA401A, F1CFA401C										
Engine		Information			A10	A20	A40	A50	A70	C10 - C30	C20	E01		
All engines		Daily 50C14, x 4, COIL ON PLUG								1.970.442	C10			

A10	CONDENSER	A20	CONTACT SET	A40	DISTRIBUTOR CAP	A50	ROTOR	A70	PICK-UP
C10	COIL	C20	IGNITION MODULE	C30	ELECTRONIC IGNITION KIT	E01	IGNITION CABLE SET		

Vehicle	alim.	kW	Date	Engine	FUNCTIONS ON THE VEHICLE									
					A10	A20	A40	A50	A70	C10 - C30	C20	E01		
E-TYPE														
3.8	Petrol	195	04/61-07/64	ENGINE --, 7R										
Engine	Information				A10	A20	A40	A50	A70	C10 - C30	C20	E01		
All engines								1.428.007						
4.2	Petrol	127	03/71-04/75	ENGINE --, 8L (85-87)										
Engine	Information				A10	A20	A40	A50	A70	C10 - C30	C20	E01		
All engines								1.428.007						
4.2	Petrol	195	05/64-09/70	ENGINE XK 4.2 (82-87)										
Engine	Information				A10	A20	A40	A50	A70	C10 - C30	C20	E01		
All engines						1.228.083MHV		1.428.007						
4.2	Petrol	198	07/68-05/71	ENGINE XK 4.2 (82-87)										
Engine	Information				A10	A20	A40	A50	A70	C10 - C30	C20	E01		
All engines								1.428.007						
E-TYPE 2+2														
4.2	Petrol	127	05/68-04/75	ENGINE --, 8LC										
Engine	Information				A10	A20	A40	A50	A70	C10 - C30	C20	E01		
All engines								1.428.007						
4.2	Petrol	195	06/66-09/68	ENGINE --, 7L										
Engine	Information				A10	A20	A40	A50	A70	C10 - C30	C20	E01		
All engines								1.428.007						
S-TYPE														
3.4	Petrol	150	05/63-08/68	ENGINE --										
Engine	Information				A10	A20	A40	A50	A70	C10 - C30	C20	E01		
All engines								1.428.007						
3.8	Petrol	164	05/63-08/68	ENGINE --										
Engine	Information				A10	A20	A40	A50	A70	C10 - C30	C20	E01		
All engines								1.428.007						
XJ														
12 6.0	Petrol	229	09/94-09/97	ENGINE 8E										
Engine	Information				A10	A20	A40	A50	A70	C10 - C30	C20	E01		
All engines	Qty: 2									1.970.170	C10			
2.8	Petrol	132	10/68-10/73	ENGINE --										
Engine	Information				A10	A20	A40	A50	A70	C10 - C30	C20	E01		
All engines								1.428.007						
3.6	Petrol	136	10/86-08/89	ENGINE 9DPANA										
Engine	Information				A10	A20	A40	A50	A70	C10 - C30	C20	E01		
All engines	version Lucas						1.328.098	1.428.027R						
3.6	Petrol	146	01/88-05/91	ENGINE 9DPALA, 9DPANA										
Engine	Information				A10	A20	A40	A50	A70	C10 - C30	C20	E01		
All engines	version Lucas						1.328.098	1.428.027R						
4.0	Petrol	163	05/91-09/94	ENGINE 9EPCNA										
Engine	Information				A10	A20	A40	A50	A70	C10 - C30	C20	E01		
All engines	version Lucas						1.328.098	1.428.027R						
4.0	Petrol	166	10/89-08/94	ENGINE 9EPCNA										
Engine	Information				A10	A20	A40	A50	A70	C10 - C30	C20	E01		
All engines	version Lucas						1.328.098	1.428.027R						

A10 CONDENSER	A20 CONTACT SET	A40 DISTRIBUTOR CAP	A50 ROTOR	A70 PICK-UP
C10 COIL	C20 IGNITION MODULE	C30 ELECTRONIC IGNITION KIT	E01 IGNITION CABLE SET	

The present application list is a brief version. For the detailed information about the possibility of installation on a specific vehicle, please refer to our web-catalogue <http://catalogo.facet.eu/>









Vehicle	alim.	kW	Date	Engine	FUNCTIONS ON THE VEHICLE									
					A10	A20	A40	A50	A70	C10 - C30	C20	E01		
ENGINE														
4.0	Petrol	171	07/94-03/96	9LPFRB										
Engine		Information			A10	A20	A40	A50	A70	C10 - C30	C20	E01		
All engines		version Lucas					1.328.098	1.428.027R						
ENGINE														
4.0	Petrol	187	10/89-08/94	9EPCNA										
Engine		Information			A10	A20	A40	A50	A70	C10 - C30	C20	E01		
All engines		version Lucas					1.328.098	1.428.027R						
ENGINE														
5.3	Petrol	207	05/91-08/93	8S (92-93)										
Engine		Information			A10	A20	A40	A50	A70	C10 - C30	C20	E01		
All engines		version Marelli					1.330.110	1.430.058						
ENGINE														
62.8	Petrol	110	09/68-10/75	--										
Engine		Information			A10	A20	A40	A50	A70	C10 - C30	C20	E01		
All engines								1.428.007						
ENGINE														
6 3.2 24V	Petrol	146	09/90-11/94	9BPMNA										
Engine		Information			A10	A20	A40	A50	A70	C10 - C30	C20	E01		
All engines		version Lucas					1.328.098	1.428.027R						
ENGINE														
6 3.6	Petrol	145	10/86-08/89	9DPANA										
Engine		Information			A10	A20	A40	A50	A70	C10 - C30	C20	E01		
All engines		version Lucas					1.328.098	1.428.027R						
ENGINE														
6 3.6	Petrol	156	10/86-08/89	9DPANA, AJ 6 (3.6, 156KW)										
Engine		Information			A10	A20	A40	A50	A70	C10 - C30	C20	E01		
All engines		version Lucas					1.328.098	1.428.027R						
ENGINE														
6 4.0	Petrol	163	09/89-11/94	9EPCNA										
Engine		Information			A10	A20	A40	A50	A70	C10 - C30	C20	E01		
All engines		version Lucas					1.328.098	1.428.027R						
ENGINE														
6 4.2	Petrol	137	10/69-05/75	XK 4.2 (-79)										
Engine		Information			A10	A20	A40	A50	A70	C10 - C30	C20	E01		
All engines								1.428.007						
ENGINE														
6.0	Petrol	222	05/93-03/96	8D										
Engine		Information			A10	A20	A40	A50	A70	C10 - C30	C20	E01		
All engines		version Marelli					1.330.110	1.430.058						
ENGINE														
V12 6.0	Petrol	229	03/93-11/94	8C (92-94)										
Engine		Information			A10	A20	A40	A50	A70	C10 - C30	C20	E01		
All engines		version Marelli					1.330.110	1.430.058						
XJSC														
ENGINE														
3.6	Petrol	136	08/87-05/91	9DPANA										
Engine		Information			A10	A20	A40	A50	A70	C10 - C30	C20	E01		
All engines		version Lucas					1.328.098	1.428.027R						
ENGINE														
3.6	Petrol	146	10/87-02/91	9DPALA, 9DPANA										
Engine		Information			A10	A20	A40	A50	A70	C10 - C30	C20	E01		
All engines		version Lucas					1.328.098	1.428.027R						
ENGINE														
4.0	Petrol	163	05/91-09/94	9EPCNA										
Engine		Information			A10	A20	A40	A50	A70	C10 - C30	C20	E01		
All engines		version Lucas					1.328.098	1.428.027R						

A10 CONDENSER	A20 CONTACT SET	A40 DISTRIBUTOR CAP	A50 ROTOR	A70 PICK-UP
C10 COIL	C20 IGNITION MODULE	C30 ELECTRONIC IGNITION KIT	E01 IGNITION CABLE SET	

Vehicle	alim.	kW	Date	Engine	FUNCTIONS ON THE VEHICLE									
					A10	A20	A40	A50	A70	C10 - C30	C20	E01		
ENGINE														
4.0	Petrol	171	07/94-03/96	9LPFRB										
Engine		Information			A10	A20	A40	A50	A70	C10 - C30	C20	E01		
All engines		version Lucas					1.328.098	1.428.027R						
ENGINE														
5.3	Petrol	207	05/91-08/93	85 (92-93)										
Engine		Information			A10	A20	A40	A50	A70	C10 - C30	C20	E01		
All engines		version Marelli					1.330.110	1.430.058						
ENGINE														
6.0	Petrol	222	05/93-03/96	8D										
Engine		Information			A10	A20	A40	A50	A70	C10 - C30	C20	E01		
All engines		version Marelli					1.330.110	1.430.058						
XK														
ENGINE														
120	Petrol	118	01/50-10/54	--										
Engine		Information			A10	A20	A40	A50	A70	C10 - C30	C20	E01		
All engines								1.428.007						
ENGINE														
120	Petrol	134	01/50-10/54	--										
Engine		Information			A10	A20	A40	A50	A70	C10 - C30	C20	E01		
All engines								1.428.007						
ENGINE														
120	Petrol	157	01/50-10/54	--										
Engine		Information			A10	A20	A40	A50	A70	C10 - C30	C20	E01		
All engines								1.428.007						
ENGINE														
150	Petrol	187	09/57-10/60	--										
Engine		Information			A10	A20	A40	A50	A70	C10 - C30	C20	E01		
All engines								1.428.007						
ENGINE														
150	Petrol	198	09/57-10/60	--										
Engine		Information			A10	A20	A40	A50	A70	C10 - C30	C20	E01		
All engines								1.428.007						
ENGINE														
150 S	Petrol	164	09/57-10/60	--										
Engine		Information			A10	A20	A40	A50	A70	C10 - C30	C20	E01		
All engines								1.428.007						

A10 CONDENSER	A20 CONTACT SET	A40 DISTRIBUTOR CAP	A50 ROTOR	A70 PICK-UP
C10 COIL	C20 IGNITION MODULE	C30 ELECTRONIC IGNITION KIT	E01 IGNITION CABLE SET	

The present application list is a brief version. For the detailed information about the possibility of installation on a specific vehicle, please refer to our web-catalogue <http://catalogo.facet.eu/>

					FUNCTIONS ON THE VEHICLE							
Vehicle	alim.	kW	Date	Engine								
CHEROKEE II												
2.5	Petrol	90	10/86-09/90	EPE								
Engine	Information				A10	A20	A40	A50	A70	C10 - C30	C20	E01
All engines	petrol injection									1.970.107	C10	
2.5 4x4	Petrol	90	10/86-09/90	EPE								
Engine	Information				A10	A20	A40	A50	A70	C10 - C30	C20	E01
All engines	petrol injection									1.970.107	C10	
4.0 i	Petrol	127	07/98-09/01	--								
Engine	Information				A10	A20	A40	A50	A70	C10 - C30	C20	E01
All engines	version Ford						1.319.093	1.419.092				
4.0 i	Petrol	130	10/86-09/90	1Z7K								
Engine	Information				A10	A20	A40	A50	A70	C10 - C30	C20	E01
All engines	version Ford						1.319.093	1.419.092				
All engines									1.970.107	C10		
4.0 i	Petrol	135	12/91-09/01	MX								
Engine	Information				A10	A20	A40	A50	A70	C10 - C30	C20	E01
All engines	version Ford						1.319.093	1.419.092				
4.0 i	Petrol	136	01/88-09/01	ERH								
Engine	Information				A10	A20	A40	A50	A70	C10 - C30	C20	E01
All engines	version Ford						1.319.093	1.419.092				
All engines									1.970.107	C10		
4.0 i 4x4	Petrol	131	01/95-09/01	ERH								
Engine	Information				A10	A20	A40	A50	A70	C10 - C30	C20	E01
All engines	version Ford						1.319.093	1.419.092				
COMANCHE												
2.5	Petrol	90	10/86-09/90	EPE								
Engine	Information				A10	A20	A40	A50	A70	C10 - C30	C20	E01
All engines	petrol injection									1.970.107	C10	
4.0 i	Petrol	130	10/87-09/90	1Z7K								
Engine	Information				A10	A20	A40	A50	A70	C10 - C30	C20	E01
All engines	version Ford						1.319.093	1.419.092				
All engines									1.970.107	C10		
COMPASS												
1.4 MultiAir	Petrol	103	03/17->	EAQ(55263624)								
Engine	Information				A10	A20	A40	A50	A70	C10 - C30	C20	E01
All engines	x 4, PLUG ON PLUG									1.970.549	C10	
1.4 MultiAir Trazione integrale	Petrol	125	03/17->	EAQ(55263623)								
Engine	Information				A10	A20	A40	A50	A70	C10 - C30	C20	E01
All engines	x 4, COIL ON PLUG									1.970.549	C10	
GRAND CHEROKEE												
4.0 Laredo	Petrol	131	10/96-09/98	ERH								
Engine	Information				A10	A20	A40	A50	A70	C10 - C30	C20	E01
All engines	version Ford						1.319.093					
5.2	Petrol	164	10/96-09/98	ELF								
Engine	Information				A10	A20	A40	A50	A70	C10 - C30	C20	E01
All engines												1.499.181

A10 CONDENSER	A20 CONTACT SET	A40 DISTRIBUTOR CAP	A50 ROTOR	A70 PICK-UP
C10 COIL	C20 IGNITION MODULE	C30 ELECTRONIC IGNITION KIT	E01 IGNITION CABLE SET	

Vehicle	alim.	kW	Date	Engine	FUNCTIONS ON THE VEHICLE							
					A10	A20	A40	A50	A70	C10 - C30	C20	E01
5.2 4x4												
ENGINE												
Petrol 164 10/96-09/98 ELF												
Engine	Information				A10	A20	A40	A50	A70	C10 - C30	C20	E01
All engines												1.499.181
GRAND WAGONEER												
4.0 i												
Petrol 130 10/86-09/90 1Z7K												
Engine	Information				A10	A20	A40	A50	A70	C10 - C30	C20	E01
All engines	version Ford						1.319.093	1.419.092				
All engines										1.970.107	C10	
RENEGADE												
1.4												
Petrol 100 01/16-> 552 63 624												
Engine	Information				A10	A20	A40	A50	A70	C10 - C30	C20	E01
All engines	->year 01/11/16, x 4, COIL ON PLUG ----- production date 2019 ->, x 4, COIL ON PLUG									1.970.549	C10	
ENGINE												
Petrol 103 07/14-> EAM, EAM(55263624)												
Engine	Information				A10	A20	A40	A50	A70	C10 - C30	C20	E01
Eng. EAM	Qty: 4									1.970.549	C10	
Eng. EAM(55263624)	->year 01/11/14, 01/12/14 ->, ->year 01/11/16, x 4, COIL ON PLUG, x 4, COIL ON PLUG ----- production date 2019 ->, x 4, COIL ON PLUG									1.970.549	C10	
ENGINE												
Petrol 125 07/14-> EAM, EAM(55263623)												
Engine	Information				A10	A20	A40	A50	A70	C10 - C30	C20	E01
Eng. EAM	Qty: 4									1.970.549	C10	
Eng. EAM(55263623)	->year 01/11/14, 01/12/14 ->, ->year 01/11/16, x 4, COIL ON PLUG, x 4, COIL ON PLUG ----- production date 2019 ->, x 4, COIL ON PLUG									1.970.549	C10	
WAGONEER												
2.5												
Petrol 90 10/86-09/90 EPE												
Engine	Information				A10	A20	A40	A50	A70	C10 - C30	C20	E01
All engines	petrol injection									1.970.107	C10	
ENGINE												
Petrol 130 10/86-09/90 1Z7K												
Engine	Information				A10	A20	A40	A50	A70	C10 - C30	C20	E01
All engines	version Ford						1.319.093	1.419.092				
All engines										1.970.107	C10	
WRANGLER												
2.5												
Petrol 89 12/91-08/96 EPE												
Engine	Information				A10	A20	A40	A50	A70	C10 - C30	C20	E01
All engines	version Ford							1.419.092				
ENGINE												
Petrol 130 10/86-09/90 1Z7K												
Engine	Information				A10	A20	A40	A50	A70	C10 - C30	C20	E01
All engines	version Ford						1.319.093	1.419.092				
All engines										1.970.107	C10	
ENGINE												
Petrol 131 10/90-09/96 1Z7K, ERH												
Engine	Information				A10	A20	A40	A50	A70	C10 - C30	C20	E01
All engines	version Ford						1.319.093					
Eng. ERH	version Ford							1.419.092				

A10 CONDENSER	A20 CONTACT SET	A40 DISTRIBUTOR CAP	A50 ROTOR	A70 PICK-UP
C10 COIL	C20 IGNITION MODULE	C30 ELECTRONIC IGNITION KIT	E01 IGNITION CABLE SET	

The present application list is a brief version. For the detailed information about the possibility of installation on a specific vehicle, please refer to our web-catalogue <http://catalogo.facet.eu/>

Vehicle	alim.	kW	Date	Engine	FUNCTIONS ON THE VEHICLE							
					A10	A20	A40	A50	A70	C10 - C30	C20	E01

GT				
2.0	Petrol	104	06/75-12/76	ENGINE

Engine	Information	A10	A20	A40	A50	A70	C10 - C30	C20	E01
All engines				1.328.075	1.428.006				

HEALEY				
2.0	Petrol	104	01/72-12/75	ENGINE

Engine	Information	A10	A20	A40	A50	A70	C10 - C30	C20	E01
All engines				1.328.075	1.428.006				

A10 CONDENSER	A20 CONTACT SET	A40 DISTRIBUTOR CAP	A50 ROTOR	A70 PICK-UP
C10 COIL	C20 IGNITION MODULE	C30 ELECTRONIC IGNITION KIT	E01 IGNITION CABLE SET	

Vehicle	alim.	kW	Date	Engine	FUNCTIONS ON THE VEHICLE							
					A10	A20	A40	A50	A70	C10 - C30	C20	E01

AVELLA

ENGINE
1.3 Petrol 55 11/95-12/01 B3

Engine	Information	A10	A20	A40	A50	A70	C10 - C30	C20	E01
All engines	version Mitsubishi			1.331.121					

ENGINE
1.5 Petrol 55 02/97-12/01 --

Engine	Information	A10	A20	A40	A50	A70	C10 - C30	C20	E01
All engines	version Mitsubishi			1.331.121					

BORREGO

ENGINE
3.8 Petrol 202 06/08-12/13 --

Engine	Information	A10	A20	A40	A50	A70	C10 - C30	C20	E01
All engines	Qty: 6						1.970.492	C10	

ENGINE
4.6 Petrol 250 09/08-12/11 G8BA

Engine	Information	A10	A20	A40	A50	A70	C10 - C30	C20	E01
All engines	Qty: 8						1.970.556	C10	

CADENZA

ENGINE
3.5 CVT Petrol 213 01/10-> G6DC

Engine	Information	A10	A20	A40	A50	A70	C10 - C30	C20	E01
All engines	Qty: 6						1.970.492	C10	

CARENS I

ENGINE
1.6 Petrol 77 07/02-> GA6D

Engine	Information	A10	A20	A40	A50	A70	C10 - C30	C20	E01
All engines									1.499.239

ENGINE
1.8 Petrol 93 07/02-> TB

Engine	Information	A10	A20	A40	A50	A70	C10 - C30	C20	E01
All engines									1.501.841

ENGINE
1.8 i Petrol 81 11/00-07/02 T8

Engine	Information	A10	A20	A40	A50	A70	C10 - C30	C20	E01
All engines									1.501.841

ENGINE
2.0 CVT Petrol 102 08/04-> G4GC

Engine	Information	A10	A20	A40	A50	A70	C10 - C30	C20	E01
All engines	x 1, D.I.S.						1.970.581	C10	
All engines									1.501.385

CARENS II

ENGINE
1.6 CVT Petrol 93 10/10-> G4FC

Engine	Information	A10	A20	A40	A50	A70	C10 - C30	C20	E01
All engines	x 4, COIL ON PLUG						1.970.543	C10	

ENGINE
1.6 CVT Petrol 97 08/09-> G4FC

Engine	Information	A10	A20	A40	A50	A70	C10 - C30	C20	E01
All engines	x 4, COIL ON PLUG						1.970.543	C10	

ENGINE
2.0 CVT Petrol 106 09/06-> G4KA

Engine	Information	A10	A20	A40	A50	A70	C10 - C30	C20	E01
All engines	x 4, COIL ON PLUG						1.970.492	C10	

CARENS III

ENGINE
1.6 GDi Petrol 99 03/13-> G4FD

Engine	Information	A10	A20	A40	A50	A70	C10 - C30	C20	E01
All engines	x 4, COIL ON PLUG						1.970.611	C10	

A10 CONDENSER	A20 CONTACT SET	A40 DISTRIBUTOR CAP	A50 ROTOR	A70 PICK-UP
C10 COIL	C20 IGNITION MODULE	C30 ELECTRONIC IGNITION KIT	E01 IGNITION CABLE SET	

The present application list is a brief version. For the detailed information about the possibility of installation on a specific vehicle, please refer to our web-catalogue <http://catalogo.facet.eu/>

Vehicle	alim.	kW	Date	Engine	FUNCTIONS ON THE VEHICLE							
					A10	A20	A40	A50	A70	C10 - C30	C20	E01

CEED I				ENGINE
1.4	Petrol	77	12/06-12/12	G4FA

Engine	Information	A10	A20	A40	A50	A70	C10 - C30	C20	E01
All engines	->year 01/01/09, x 4, COIL ON PLUG						1.970.495	C10	
All engines	01/02/09->, x 4, COIL ON PLUG, x 4, COIL ON PLUG						1.970.543	C10	

CEED I				ENGINE
1.4	Petrol	80	12/06-12/12	G4FA

Engine	Information	A10	A20	A40	A50	A70	C10 - C30	C20	E01
All engines	->year 01/01/09, x 4, COIL ON PLUG						1.970.495	C10	
All engines	01/02/09->, x 4, COIL ON PLUG						1.970.543	C10	

CEED I				ENGINE
1.4 CVT	Petrol	66	07/09-12/12	G4FA, G4FA-L

Engine	Information	A10	A20	A40	A50	A70	C10 - C30	C20	E01
Eng. G4FA	x 4, COIL ON PLUG						1.970.543	C10	
Eng. G4FA-L	Qty: 4						1.970.543	C10	

CEED I				ENGINE
1.4 LPG	Petrol/ Liquified Petro- leum Gas (LPG)	64	06/11-04/12	G4FA

Engine	Information	A10	A20	A40	A50	A70	C10 - C30	C20	E01
All engines	x 4, COIL ON PLUG						1.970.543	C10	

CEED I				ENGINE
1.4 LPG	Petrol/ Liquified Petro- leum Gas (LPG)	80	01/09-12/10	G4FA

Engine	Information	A10	A20	A40	A50	A70	C10 - C30	C20	E01
All engines	x 4, COIL ON PLUG						1.970.543	C10	

CEED I				ENGINE
1.6	Petrol	85	09/07-12/12	G4FC

Engine	Information	A10	A20	A40	A50	A70	C10 - C30	C20	E01
All engines	->year 01/03/09, x 4, COIL ON PLUG						1.970.495	C10	
All engines	01/04/09->, x 4, COIL ON PLUG						1.970.543	C10	

CEED I				ENGINE
1.6	Petrol	90	12/06-12/12	G4FC

Engine	Information	A10	A20	A40	A50	A70	C10 - C30	C20	E01
All engines	x 4, COIL ON PLUG						1.970.543	C10	

CEED I				ENGINE
1.6	Petrol	93	09/07-12/12	G4FC

Engine	Information	A10	A20	A40	A50	A70	C10 - C30	C20	E01
All engines	x 4, COIL ON PLUG						1.970.543	C10	

CEED I				ENGINE
1.6 CVT	Petrol	92	06/09-12/12	G4FC

Engine	Information	A10	A20	A40	A50	A70	C10 - C30	C20	E01
All engines	x 4, COIL ON PLUG						1.970.543	C10	

CEED I				ENGINE
1.6 LPG	Petrol/ Liquified Petro- leum Gas (LPG)	87	06/11-12/11	G4FC

Engine	Information	A10	A20	A40	A50	A70	C10 - C30	C20	E01
All engines	x 4, COIL ON PLUG						1.970.543	C10	

CEED I				ENGINE
1.6 LPG	Petrol/ Liquified Petro- leum Gas (LPG)	91	06/07-09/12	G4FC

Engine	Information	A10	A20	A40	A50	A70	C10 - C30	C20	E01
All engines	->year 01/03/09, x 4, COIL ON PLUG						1.970.495	C10	
All engines	01/04/09->, x 4, COIL ON PLUG, x 4, COIL ON PLUG						1.970.543	C10	

A10 CONDENSER	A20 CONTACT SET	A40 DISTRIBUTOR CAP	A50 ROTOR	A70 PICK-UP
C10 COIL	C20 IGNITION MODULE	C30 ELECTRONIC IGNITION KIT	E01 IGNITION CABLE SET	

Vehicle	alim.	kW	Date	Engine	FUNCTIONS ON THE VEHICLE									
					A10	A20	A40	A50	A70	C10 - C30	C20	E01		
ENGINE														
2.0	Petrol	105	12/06-12/12	G4GC										
ENGINE														
All engines					A10	A20	A40	A50	A70	C10 - C30	C20	E01		
All engines										1.970.581	C10			1.501.385
CEED II														
ENGINE														
1.0 T-GDI	Petrol	74	04/15-07/18	G3LC										
ENGINE														
All engines					A10	A20	A40	A50	A70	C10 - C30	C20	E01		
All engines										1.970.638	C10			
ENGINE														
1.0 T-GDI	Petrol	88	04/15-07/18	G3LC										
ENGINE														
All engines					A10	A20	A40	A50	A70	C10 - C30	C20	E01		
All engines										1.970.638	C10			
ENGINE														
1.4 CVVT	Petrol	66	05/12-07/18	G4FA, G4FA-L										
ENGINE														
Eng. G4FA					A10	A20	A40	A50	A70	C10 - C30	C20	E01		
Eng. G4FA-L										1.970.543	C10			
Qty: 4										1.970.543	C10			
ENGINE														
1.4 CVVT	Petrol	73	05/12-07/18	G4FA										
ENGINE														
All engines					A10	A20	A40	A50	A70	C10 - C30	C20	E01		
All engines										1.970.543	C10			
ENGINE														
1.4 LPG	Petrol/ Liquified Petroleum Gas (LPG)	72	05/12-07/18	G4FA										
ENGINE														
All engines					A10	A20	A40	A50	A70	C10 - C30	C20	E01		
All engines										1.970.543	C10			
ENGINE														
1.4 MPI	Petrol	74	04/15-07/18	G4LC										
ENGINE														
All engines					A10	A20	A40	A50	A70	C10 - C30	C20	E01		
All engines										1.970.622	C10			
ENGINE														
1.6 CVVT	Petrol	92	05/12->	G4FC										
ENGINE														
All engines					A10	A20	A40	A50	A70	C10 - C30	C20	E01		
All engines										1.970.543	C10			
ENGINE														
1.6 CVVT	Petrol	95	01/13-07/18	G4FC										
ENGINE														
All engines					A10	A20	A40	A50	A70	C10 - C30	C20	E01		
All engines										1.970.543	C10			
ENGINE														
1.6 CVVT	Petrol	96	11/14-07/18	G4FC										
ENGINE														
All engines					A10	A20	A40	A50	A70	C10 - C30	C20	E01		
All engines										1.970.543	C10			
ENGINE														
1.6 GDI	Petrol	99	05/12-07/18	G4FD										
ENGINE														
All engines					A10	A20	A40	A50	A70	C10 - C30	C20	E01		
All engines										1.970.611	C10			
CEED III														
ENGINE														
1.0 T-GDI	Petrol	74	09/19->	G3LC										
ENGINE														
All engines					A10	A20	A40	A50	A70	C10 - C30	C20	E01		
All engines										1.970.638	C10			
ENGINE														
1.0 T-GDI	Petrol	88	03/18->	G3LC										
ENGINE														
All engines					A10	A20	A40	A50	A70	C10 - C30	C20	E01		
All engines										1.970.638	C10			

A10 CONDENSER	A20 CONTACT SET	A40 DISTRIBUTOR CAP	A50 ROTOR	A70 PICK-UP
C10 COIL	C20 IGNITION MODULE	C30 ELECTRONIC IGNITION KIT	E01 IGNITION CABLE SET	

The present application list is a brief version. For the detailed information about the possibility of installation on a specific vehicle, please refer to our web-catalogue <http://catalogo.facet.eu/>

					FUNCTIONS ON THE VEHICLE							
Vehicle	alim.	kW	Date	Engine	A10	A20	A40	A50	A70	C10 - C30	C20	E01
ENGINE												
1.4	Petrol	73	03/18->	G4LC								
ENGINE												
Engine		Information			A10	A20	A40	A50	A70	C10 - C30	C20	E01
All engines		x 4, COIL ON PLUG								1.970.622	C10	
ENGINE												
1.4 LPG	Petrol/ Liquified Petroleum Gas (LPG)	71	12/18->	G4LC								
ENGINE												
Engine		Information			A10	A20	A40	A50	A70	C10 - C30	C20	E01
All engines		x 4, COIL ON PLUG								1.970.622	C10	
ENGINE												
1.6	Petrol	94	03/18->	G4FG								
ENGINE												
Engine		Information			A10	A20	A40	A50	A70	C10 - C30	C20	E01
All engines		x 4, COIL ON PLUG								1.970.543	C10	
ENGINE												
1.6 GDI Hybrid	Petrol/ Electric	104	12/19->	G4LE								
ENGINE												
Engine		Information			A10	A20	A40	A50	A70	C10 - C30	C20	E01
All engines		x 4, COIL ON PLUG								1.970.647	C10	
ENGINE												
1.6 GDI Hybrid	Petrol/ Electric	77	12/19->	G4LE								
ENGINE												
Engine		Information			A10	A20	A40	A50	A70	C10 - C30	C20	E01
All engines		x 4, COIL ON PLUG								1.970.647	C10	
ENGINE												
GDI Hybrid	Petrol/ Electric	104	12/19->	G4LE								
ENGINE												
Engine		Information			A10	A20	A40	A50	A70	C10 - C30	C20	E01
All engines		x 4, COIL ON PLUG								1.970.647	C10	
ENGINE												
GDI Hybrid	Petrol/ Electric	77	12/19->	G4LE								
ENGINE												
Engine		Information			A10	A20	A40	A50	A70	C10 - C30	C20	E01
All engines		x 4, COIL ON PLUG								1.970.647	C10	
ENGINE												
T-GDI	Petrol	88	03/18->	G3LC								
ENGINE												
Engine		Information			A10	A20	A40	A50	A70	C10 - C30	C20	E01
All engines		x 3, COIL ON PLUG								1.970.638	C10	
ENGINE												
2.0 CVT	Petrol	110	07/09-02/14	G4KD								
ENGINE												
Engine		Information			A10	A20	A40	A50	A70	C10 - C30	C20	E01
All engines		x 4, COIL ON PLUG								1.970.556	C10	
ENGINE												
1.6	Petrol	77	04/04-12/09	G4ED								
ENGINE												
Engine		Information			A10	A20	A40	A50	A70	C10 - C30	C20	E01
All engines		01/11/06 ->, x 4, COIL ON PLUG								1.970.495	C10	
All engines		->year 01/10/06, x 1, D.I.S.								1.970.586	C10	
All engines												1.499.111
ENGINE												
1.6	Petrol	90	04/04->	G4FC, G4GR								
ENGINE												
Engine		Information			A10	A20	A40	A50	A70	C10 - C30	C20	E01
All engines		x 4, COIL ON PLUG								1.970.495	C10	
Eng. G4FC		->year 25/01/08, Qty: 4								1.970.495	C10	
Eng. G4FC		25/01/08 ->, Qty: 4								1.970.543	C10	
ENGINE												
2.0	Petrol	105	03/04-05/07	G4GC								
ENGINE												
Engine		Information			A10	A20	A40	A50	A70	C10 - C30	C20	E01
All engines		x 1, D.I.S.								1.970.581	C10	
All engines												1.501.385

A10 CONDENSER	A20 CONTACT SET	A40 DISTRIBUTOR CAP	A50 ROTOR	A70 PICK-UP
C10 COIL	C20 IGNITION MODULE	C30 ELECTRONIC IGNITION KIT	E01 IGNITION CABLE SET	

Vehicle	alim.	kW	Date	Engine	FUNCTIONS ON THE VEHICLE							
					A10	A20	A40	A50	A70	C10 - C30	C20	E01

CERATO II

1.6	Petrol	90	01/10->	ENGINE G4FC
-----	--------	----	---------	----------------

Engine	Information	A10	A20	A40	A50	A70	C10 - C30	C20	E01
All engines	x 4, COIL ON PLUG						1.970.556	C10	

1.6	Petrol	93	01/10-06/13	ENGINE G4FC
-----	--------	----	-------------	----------------

Engine	Information	A10	A20	A40	A50	A70	C10 - C30	C20	E01
All engines	x 4, COIL ON PLUG						1.970.543	C10	

1.6 CVVT	Petrol	91	02/09->	ENGINE G4FC
----------	--------	----	---------	----------------

Engine	Information	A10	A20	A40	A50	A70	C10 - C30	C20	E01
All engines	Qty: 4						1.970.543	C10	
All engines	x 4, COIL ON PLUG						1.970.543	C10	

1.6 CVVT	Petrol	93	01/10-06/13	ENGINE G4FC
----------	--------	----	-------------	----------------

Engine	Information	A10	A20	A40	A50	A70	C10 - C30	C20	E01
All engines	x 4, COIL ON PLUG						1.970.543	C10	

2.0	Petrol	115	01/09->	ENGINE G4KD
-----	--------	-----	---------	----------------

Engine	Information	A10	A20	A40	A50	A70	C10 - C30	C20	E01
All engines	x 4, COIL ON PLUG						1.970.556	C10	

2.0	Petrol	116	07/10->	ENGINE G4KD
-----	--------	-----	---------	----------------

Engine	Information	A10	A20	A40	A50	A70	C10 - C30	C20	E01
All engines	Qty: 4						1.970.556	C10	

2.0 CVVT	Petrol	110	07/09-06/13	ENGINE G4KD
----------	--------	-----	-------------	----------------

Engine	Information	A10	A20	A40	A50	A70	C10 - C30	C20	E01
All engines	x 4, COIL ON PLUG						1.970.556	C10	

2.0 CVVT	Petrol	115	01/09->	ENGINE --, G4KD
----------	--------	-----	---------	--------------------

Engine	Information	A10	A20	A40	A50	A70	C10 - C30	C20	E01
Eng. G4KD	x 4, COIL ON PLUG						1.970.556	C10	
Eng. --							1.970.581	C10	1.501.385

CERATO III

1.6	Petrol	91	07/12->	ENGINE --
-----	--------	----	---------	--------------

Engine	Information	A10	A20	A40	A50	A70	C10 - C30	C20	E01
All engines	no specific info conc. application available, Qty: 4						1.970.543	C10	

1.6 CVVT	Petrol	95	07/16->	ENGINE G4FC
----------	--------	----	---------	----------------

Engine	Information	A10	A20	A40	A50	A70	C10 - C30	C20	E01
All engines	x 4, COIL ON PLUG						1.970.543	C10	

1.6 MPi	Petrol	96	06/13->	ENGINE G4FG
---------	--------	----	---------	----------------

Engine	Information	A10	A20	A40	A50	A70	C10 - C30	C20	E01
All engines	x 4, COIL ON PLUG						1.970.543	C10	

CLARUS

1.8 i 16V	Petrol	85	07/96->	ENGINE T8
-----------	--------	----	---------	--------------

Engine	Information	A10	A20	A40	A50	A70	C10 - C30	C20	E01
All engines									1.501.841

2.0 i 16V	Petrol	98	07/96->	ENGINE FE (16V)
-----------	--------	----	---------	--------------------

Engine	Information	A10	A20	A40	A50	A70	C10 - C30	C20	E01
All engines	version Mitsubishi			1.331.121					

A10	CONDENSER	A20	CONTACT SET	A40	DISTRIBUTOR CAP	A50	ROTOR	A70	PICK-UP
C10	COIL	C20	IGNITION MODULE	C30	ELECTRONIC IGNITION KIT	E01	IGNITION CABLE SET		

The present application list is a brief version. For the detailed information about the possibility of installation on a specific vehicle, please refer to our web-catalogue <http://catalogo.facet.eu/>

Vehicle	alim.	kW	Date	Engine	FUNCTIONS ON THE VEHICLE							
					A10	A20	A40	A50	A70	C10 - C30	C20	E01
FORTE												
1.6	Petrol	91	07/12->	ENGINE								
Engine		Information			A10	A20	A40	A50	A70	C10 - C30	C20	E01
All engines		no specific info conc. application available, Qty: 4								1.970.543	C10	
JOICE												
2.0	Petrol	102	02/00->	ENGINE								
Engine		Information			A10	A20	A40	A50	A70	C10 - C30	C20	E01
All engines												1.501.401
2.0	Petrol	88	09/01->	ENGINE								
Engine		Information			A10	A20	A40	A50	A70	C10 - C30	C20	E01
All engines												1.501.401
MAGENTIS I												
2.0	Petrol	100	05/01-09/05	ENGINE								
Engine		Information			A10	A20	A40	A50	A70	C10 - C30	C20	E01
All engines												1.499.241
2.4 [USA]	Petrol	0	01/01-12/04	ENGINE								
Engine		Information			A10	A20	A40	A50	A70	C10 - C30	C20	E01
All engines												1.499.241
MAGENTIS II												
2.0	Petrol	100	09/06->	ENGINE								
Engine		Information			A10	A20	A40	A50	A70	C10 - C30	C20	E01
All engines		Qty: 4								1.970.492	C10	
2.0	Petrol	106	11/05-12/10	ENGINE								
Engine		Information			A10	A20	A40	A50	A70	C10 - C30	C20	E01
All engines		x 4, COIL ON PLUG								1.970.492	C10	
2.0	Petrol	121	09/09-12/10	ENGINE								
Engine		Information			A10	A20	A40	A50	A70	C10 - C30	C20	E01
All engines		x 4, COIL ON PLUG								1.970.556	C10	
MOHAVE												
3.8	Petrol	202	12/08->	ENGINE								
Engine		Information			A10	A20	A40	A50	A70	C10 - C30	C20	E01
All engines		Qty: 6								1.970.492	C10	
4.6	Petrol	251	09/08->	ENGINE								
Engine		Information			A10	A20	A40	A50	A70	C10 - C30	C20	E01
All engines		Qty: 8								1.970.556	C10	
NIRO												
1.6 GDI Hybrid	Petrol/ Electric	104	09/16->	ENGINE								
Engine		Information			A10	A20	A40	A50	A70	C10 - C30	C20	E01
All engines		x 4, COIL ON PLUG								1.970.647	C10	
1.6 GDI Hybrid	Petrol/ Electric	107	09/16->	ENGINE								
Engine		Information			A10	A20	A40	A50	A70	C10 - C30	C20	E01
All engines		x 4, COIL ON PLUG								1.970.647	C10	
1.6 GDI Hybrid	Petrol/ Electric	77	09/16->	ENGINE								
Engine		Information			A10	A20	A40	A50	A70	C10 - C30	C20	E01
All engines		x 4, COIL ON PLUG								1.970.647	C10	

A10 CONDENSER	A20 CONTACT SET	A40 DISTRIBUTOR CAP	A50 ROTOR	A70 PICK-UP
C10 COIL	C20 IGNITION MODULE	C30 ELECTRONIC IGNITION KIT	E01 IGNITION CABLE SET	

Vehicle	alim.	kW	Date	Engine	FUNCTIONS ON THE VEHICLE								
					A10	A20	A40	A50	A70	C10 - C30	C20	E01	
ENGINE													
GDI Hybrid	Petrol/ Electric	77	09/16->	G4LE									
Engine		Information			A10	A20	A40	A50	A70	C10 - C30	C20	E01	
All engines		x 4, COIL ON PLUG								1.970.647	C10		
OPIRUS													
3.8 V6	Petrol	196	10/06->	G6DA									
Engine		Information			A10	A20	A40	A50	A70	C10 - C30	C20	E01	
All engines		x 6, COIL ON PLUG								1.970.492	C10		
OPTIMA II													
2.0	Petrol	106	05/08->	G4KA									
Engine		Information			A10	A20	A40	A50	A70	C10 - C30	C20	E01	
All engines		Qty: 4								1.970.492	C10		
OPTIMA III													
2.0	Petrol	121	03/10->	--									
Engine		Information			A10	A20	A40	A50	A70	C10 - C30	C20	E01	
All engines		Qty: 4								1.970.556	C10		
2.0	Petrol	125	03/12->	G4KD									
Engine		Information			A10	A20	A40	A50	A70	C10 - C30	C20	E01	
All engines		Optima, x 4, COIL ON PLUG								1.970.556	C10		
2.0 CVVL	Petrol	121	03/12->	G4KD									
Engine		Information			A10	A20	A40	A50	A70	C10 - C30	C20	E01	
All engines		Optima, x 4, COIL ON PLUG								1.970.556	C10		
2.0 CVVT	Petrol	110	01/11-12/15	G4KD									
Engine		Information			A10	A20	A40	A50	A70	C10 - C30	C20	E01	
All engines		Optima, x 4, COIL ON PLUG								1.970.556	C10		
2.4	Petrol	129	06/10-12/15	G4KC									
Engine		Information			A10	A20	A40	A50	A70	C10 - C30	C20	E01	
All engines		Optima, x 4, COIL ON PLUG								1.970.556	C10		
2.4	Petrol	132	03/10->	--, G4KE, G4KJ									
Engine		Information			A10	A20	A40	A50	A70	C10 - C30	C20	E01	
Eng. --		Qty: 4								1.970.556	C10		
Eng. G4KE, G4KJ		Optima, x 4, COIL ON PLUG								1.970.556	C10		
2.4	Petrol	149	09/10->	G4KJ									
Engine		Information			A10	A20	A40	A50	A70	C10 - C30	C20	E01	
All engines		Qty: 4								1.970.556	C10		
2.4 CVVT	Petrol	132	01/12->	G4KE, G4KJ									
Engine		Information			A10	A20	A40	A50	A70	C10 - C30	C20	E01	
All engines		Optima, x 4, COIL ON PLUG								1.970.556	C10		
2.4 Hybrid	Petrol/ Electric	154	09/11->	G4KC									
Engine		Information			A10	A20	A40	A50	A70	C10 - C30	C20	E01	
All engines		Qty: 4								1.970.556	C10		
OPTIMA IV													
2.4 MPi	Petrol	126	09/15->	G4KE									
Engine		Information			A10	A20	A40	A50	A70	C10 - C30	C20	E01	
All engines		Optima, x 4, COIL ON PLUG								1.970.556	C10		

A10	CONDENSER	A20	CONTACT SET	A40	DISTRIBUTOR CAP	A50	ROTOR	A70	PICK-UP
C10	COIL	C20	IGNITION MODULE	C30	ELECTRONIC IGNITION KIT	E01	IGNITION CABLE SET		

The present application list is a brief version. For the detailed information about the possibility of installation on a specific vehicle, please refer to our web-catalogue <http://catalogo.facet.eu/>

Vehicle	alim.	kW	Date	Engine	FUNCTIONS ON THE VEHICLE							
					A10	A20	A40	A50	A70	C10 - C30	C20	E01

PICANTO I

1.0	Petrol	45	04/04-04/11	ENGINE G4HE
-----	--------	----	-------------	----------------

Engine	Information	A10	A20	A40	A50	A70	C10 - C30	C20	E01
All engines	01/10/06 ->, Fitting Position:for cylinder 2, Fitting Position:for cylinder 3, x 1, D.I.S.						1.970.580	C10	
All engines	01/10/06 ->, Fitting Position:for cylinder 1, Fitting Position:for cylinder 4, x 1, D.I.S.						1.970.587	C10	
All engines	->year 01/09/06, Fitting Position:for cylinder 1-4, x 1, D.I.S.						1.970.589	C10	
All engines									1.499.119

1.0	Petrol	46	09/07-04/11	ENGINE G4HE
-----	--------	----	-------------	----------------

Engine	Information	A10	A20	A40	A50	A70	C10 - C30	C20	E01
All engines	Fitting Position:for cylinder 2, Fitting Position:for cylinder 3, x 1, D.I.S.						1.970.580	C10	
All engines	Fitting Position:for cylinder 1, Fitting Position:for cylinder 4, x 1, D.I.S.						1.970.587	C10	
All engines									1.499.235

1.0 LPG	Petrol/ Liquified Petro- leum Gas (LPG)	45	01/09-04/11	ENGINE G4HE
---------	---	----	-------------	----------------

Engine	Information	A10	A20	A40	A50	A70	C10 - C30	C20	E01
All engines	Fitting Position:for cylinder 2, Fitting Position:for cylinder 3, x 1, D.I.S.						1.970.580	C10	
All engines	Fitting Position:for cylinder 1, Fitting Position:for cylinder 4, x 1, D.I.S.						1.970.587	C10	

1.1	Petrol	48	04/04-09/11	ENGINE G4HG
-----	--------	----	-------------	----------------

Engine	Information	A10	A20	A40	A50	A70	C10 - C30	C20	E01
All engines	01/10/06 ->, Fitting Position:for cylinder 2, Fitting Position:for cylinder 3, x 1, D.I.S.						1.970.580	C10	
All engines	01/10/06 ->, Fitting Position:for cylinder 1, Fitting Position:for cylinder 4, x 1, D.I.S.						1.970.587	C10	
All engines	->year 01/09/06, Fitting Position:for cylinder 1-4, x 1, D.I.S.						1.970.589	C10	
All engines									1.499.119

1.1	Petrol	71	08/07->	ENGINE --
-----	--------	----	---------	--------------

Engine	Information	A10	A20	A40	A50	A70	C10 - C30	C20	E01
All engines	no specific info conc. application available						1.970.580, 1.970.587	C10	
All engines	Kit						1.970.589	C10	
All engines									1.499.235

1.1 LPG	Petrol/ Liquified Petro- leum Gas (LPG)	48	01/09-04/11	ENGINE G4HG
---------	---	----	-------------	----------------

Engine	Information	A10	A20	A40	A50	A70	C10 - C30	C20	E01
All engines	Fitting Position:for cylinder 2, Fitting Position:for cylinder 3, x 1, D.I.S.						1.970.580	C10	
All engines	Fitting Position:for cylinder 1, Fitting Position:for cylinder 4, x 1, D.I.S.						1.970.587	C10	

PICANTO II

1.0	Petrol	49	05/11-03/17	ENGINE G3LA
-----	--------	----	-------------	----------------









Engine	Information	A10	A20	A40	A50	A70	C10 - C30	C20	E01
All engines	x 3, COIL ON PLUG						1.970.614	C10	

1.0	Petrol	51	05/11-03/17	ENGINE G3LA
-----	--------	----	-------------	----------------

Engine	Information	A10	A20	A40	A50	A70	C10 - C30	C20	E01
All engines	x 3, COIL ON PLUG						1.970.614	C10	

A10 CONDENSER	A20 CONTACT SET	A40 DISTRIBUTOR CAP	A50 ROTOR	A70 PICK-UP
C10 COIL	C20 IGNITION MODULE	C30 ELECTRONIC IGNITION KIT	E01 IGNITION CABLE SET	

Vehicle	alim.	kW	Date	Engine	FUNCTIONS ON THE VEHICLE									
					A10	A20	A40	A50	A70	C10 - C30	C20	E01		
ENGINE														
1.0 Bi-Fuel	Petrol/ Liquified Petro- leum Gas (LPG)	60	05/11-10/14	B3LA										
Engine	Information				A10	A20	A40	A50	A70	C10 - C30	C20	E01		
All engines	x 3, COIL ON PLUG									1.970.614	C10			
ENGINE														
1.0 LPG	Petrol/ Liquified Petro- leum Gas (LPG)	49	08/13-03/17	B3LA										
Engine	Information				A10	A20	A40	A50	A70	C10 - C30	C20	E01		
All engines	x 3, COIL ON PLUG									1.970.614	C10			
ENGINE														
1.2	Petrol	63	09/11-03/17	G4LA										
Engine	Information				A10	A20	A40	A50	A70	C10 - C30	C20	E01		
All engines	x 1, -start-stop function, D.I.S.									1.970.579	C10			
All engines	x 4, +start-stop function, COIL ON PLUG									1.970.612	C10			
ENGINE														
1.2	Petrol	64	09/11-02/17	G4LA										
Engine	Information				A10	A20	A40	A50	A70	C10 - C30	C20	E01		
All engines	x 1, D.I.S.									1.970.579	C10			
All engines	x 4, +start-stop function, COIL ON PLUG									1.970.612	C10			
PICANTO III														
ENGINE														
1.0	Petrol	49	03/17->	G3LA, G3LD										
Engine	Information				A10	A20	A40	A50	A70	C10 - C30	C20	E01		
All engines	x 3, COIL ON PLUG									1.970.638	C10			
ENGINE														
1.0	Petrol	51	03/17->	G3LA										
Engine	Information				A10	A20	A40	A50	A70	C10 - C30	C20	E01		
All engines	x 3, COIL ON PLUG									1.970.638	C10			
ENGINE														
1.0 LPG	Petrol/ Liquified Petro- leum Gas (LPG)	48	11/18->	G3LA										
Engine	Information				A10	A20	A40	A50	A70	C10 - C30	C20	E01		
All engines	x 3, COIL ON PLUG									1.970.638	C10			
ENGINE														
1.0 T-GDi	Petrol	74	03/17->	G3LC										
Engine	Information				A10	A20	A40	A50	A70	C10 - C30	C20	E01		
All engines	x 3, COIL ON PLUG									1.970.638	C10			
ENGINE														
1.2	Petrol	62	03/17->	G4LA										
Engine	Information				A10	A20	A40	A50	A70	C10 - C30	C20	E01		
All engines	x 4, COIL ON PLUG									1.970.612	C10			
PRIDE														
ENGINE														
1.1 i	Petrol	38	01/91-10/00	B1										
Engine	Information				A10	A20	A40	A50	A70	C10 - C30	C20	E01		
All engines	version Mitsubishi						1.331.122	1.431.108						
All engines	alternatively											1.501.398		
ENGINE														
1.3	Petrol	44	01/90-10/00	B3										
Engine	Information				A10	A20	A40	A50	A70	C10 - C30	C20	E01		
All engines	version Mitsubishi						1.331.121							
All engines	alternatively											1.501.398		
ENGINE														
1.3	Petrol	47	10/96-05/01	B3, B3A5										
Engine	Information				A10	A20	A40	A50	A70	C10 - C30	C20	E01		
All engines	version Mitsubishi						1.331.121							
A10	CONDENSER	A20	CONTACT SET	A40	DISTRIBUTOR CAP	A50	ROTOR	A70	PICK-UP					
C10	COIL	C20	IGNITION MODULE	C30	ELECTRONIC IGNITION KIT	E01	IGNITION CABLE SET							



					FUNCTIONS ON THE VEHICLE								
Vehicle	alim.	kW	Date	Engine									
PRO CEE'D I													
1.3	Petrol	47	10/96-05/01	ENGINE B3, B3A5									
ENGINE													
Engine	Information				A10	A20	A40	A50	A70	C10 - C30	C20	E01	
All engines	alternatively											1.501.398	
1.3	Petrol	53	01/90-09/01	ENGINE B3									
ENGINE													
Engine	Information				A10	A20	A40	A50	A70	C10 - C30	C20	E01	
All engines	version Mitsubishi						1.331.121						
All engines	alternatively											1.501.398	
1.3 i	Petrol	51	01/90-05/97	ENGINE --									
ENGINE													
Engine	Information				A10	A20	A40	A50	A70	C10 - C30	C20	E01	
All engines	version Mitsubishi						1.331.122	1.431.108					
All engines	alternatively											1.501.398	
PRO CEE'D													
1.4 CVT	Petrol	73	05/12-07/18	ENGINE G4FA									
ENGINE													
Engine	Information				A10	A20	A40	A50	A70	C10 - C30	C20	E01	
All engines	x 4, COIL ON PLUG									1.970.543	C10		
1.6 GDI	Petrol	99	04/15-07/18	ENGINE G4FD									
ENGINE													
Engine	Information				A10	A20	A40	A50	A70	C10 - C30	C20	E01	
All engines	x 4, COIL ON PLUG									1.970.611	C10		
PRO CEE'D I													
1.4	Petrol	77	02/08-09/12	ENGINE G4FA									
ENGINE													
Engine	Information				A10	A20	A40	A50	A70	C10 - C30	C20	E01	
All engines	->year 01/03/09, x 4, COIL ON PLUG									1.970.495	C10		
All engines	01/04/09 ->, x 4, COIL ON PLUG									1.970.543	C10		
1.4	Petrol	80	02/08-09/12	ENGINE G4FA									
ENGINE													
Engine	Information				A10	A20	A40	A50	A70	C10 - C30	C20	E01	
All engines	x 4, COIL ON PLUG									1.970.543	C10		
1.4 CVT	Petrol	66	06/10-09/12	ENGINE G4FA, G4FA-L									
ENGINE													
Engine	Information				A10	A20	A40	A50	A70	C10 - C30	C20	E01	
Eng. G4FA	x 4, COIL ON PLUG									1.970.543	C10		
Eng. G4FA-L	Qty: 4									1.970.543	C10		
1.6	Petrol	90	02/08-09/12	ENGINE G4FC									
ENGINE													
Engine	Information				A10	A20	A40	A50	A70	C10 - C30	C20	E01	
All engines	->year 01/03/09, x 4, COIL ON PLUG									1.970.495	C10		
All engines	01/04/09 ->, x 4, COIL ON PLUG									1.970.543	C10		
1.6	Petrol	93	02/08-09/12	ENGINE G4FC									
ENGINE													
Engine	Information				A10	A20	A40	A50	A70	C10 - C30	C20	E01	
All engines	x 4, COIL ON PLUG									1.970.543	C10		
1.6 CVT	Petrol	85	02/08-09/12	ENGINE G4FC									
ENGINE													
Engine	Information				A10	A20	A40	A50	A70	C10 - C30	C20	E01	
All engines	->year 01/03/09, x 4, COIL ON PLUG									1.970.495	C10		
All engines	01/04/09 ->, x 4, COIL ON PLUG									1.970.543	C10		
1.6 CVT	Petrol	92	10/10-02/13	ENGINE G4FC									
ENGINE													
Engine	Information				A10	A20	A40	A50	A70	C10 - C30	C20	E01	
All engines	x 4, COIL ON PLUG									1.970.543	C10		
2.0	Petrol	105	02/08-09/12	ENGINE G4GC									
ENGINE													
Engine	Information				A10	A20	A40	A50	A70	C10 - C30	C20	E01	
All engines	x 1, D.I.S.									1.970.581	C10		
All engines												1.501.385	

A10 CONDENSER	A20 CONTACT SET	A40 DISTRIBUTOR CAP	A50 ROTOR	A70 PICK-UP
C10 COIL	C20 IGNITION MODULE	C30 ELECTRONIC IGNITION KIT	E01 IGNITION CABLE SET	

Vehicle	alim.	kW	Date	Engine	FUNCTIONS ON THE VEHICLE									
					A10	A20	A40	A50	A70	C10 - C30	C20	E01		
ENGINE														
2.0 LPG	Petrol/ Liquified Petro- leum Gas (LPG)	105	01/09-12/09	G4GC										
Engine	Information				A10	A20	A40	A50	A70	C10 - C30	C20	E01		
All engines	x 1, D.I.S.									1.970.581	C10			
PRO CEE'D II														
ENGINE														
1.0 T-GDI	Petrol	74	07/15-07/18	G3LC										
Engine	Information				A10	A20	A40	A50	A70	C10 - C30	C20	E01		
All engines	x 3, COIL ON PLUG									1.970.638	C10			
ENGINE														
1.0 T-GDI	Petrol	88	07/15-07/18	G3LC										
Engine	Information				A10	A20	A40	A50	A70	C10 - C30	C20	E01		
All engines	x 3, COIL ON PLUG									1.970.638	C10			
ENGINE														
1.4 CVT	Petrol	73	03/13-07/15	G4FA										
Engine	Information				A10	A20	A40	A50	A70	C10 - C30	C20	E01		
All engines	x 4, COIL ON PLUG									1.970.543	C10			
ENGINE														
1.4 CVT	Petrol	74	07/13-07/18	G4FA										
Engine	Information				A10	A20	A40	A50	A70	C10 - C30	C20	E01		
All engines	x 4, COIL ON PLUG									1.970.543	C10			
ENGINE														
1.4 MPI	Petrol	73	07/13-07/18	G4LC										
Engine	Information				A10	A20	A40	A50	A70	C10 - C30	C20	E01		
All engines	->year 01/05/15, x 4, COIL ON PLUG									1.970.543	C10			
All engines	01/06/15 ->, x 4, COIL ON PLUG									1.970.622	C10			
ENGINE														
1.4 MPI	Petrol	74	04/15-07/18	G4LC										
Engine	Information				A10	A20	A40	A50	A70	C10 - C30	C20	E01		
All engines	x 4, COIL ON PLUG									1.970.622	C10			
ENGINE														
1.6 CVT	Petrol	95	03/13-07/18	G4FC										
Engine	Information				A10	A20	A40	A50	A70	C10 - C30	C20	E01		
All engines	x 4, COIL ON PLUG									1.970.543	C10			
ENGINE														
1.6 GDI	Petrol	99	03/13-07/18	G4FD										
Engine	Information				A10	A20	A40	A50	A70	C10 - C30	C20	E01		
All engines	x 4, COIL ON PLUG									1.970.611	C10			
PROCEED														
ENGINE														
1.0 T-GDI	Petrol	88	10/18->	G3LC										
Engine	Information				A10	A20	A40	A50	A70	C10 - C30	C20	E01		
All engines	x 3, COIL ON PLUG									1.970.638	C10			
QUORIS														
ENGINE														
3.8	Petrol	213	01/13->	G6DK										
Engine	Information				A10	A20	A40	A50	A70	C10 - C30	C20	E01		
All engines	x 6, COIL ON PLUG									1.970.492	C10			
ENGINE														
3.8	Petrol	216	03/17->	G6DK										
Engine	Information				A10	A20	A40	A50	A70	C10 - C30	C20	E01		
All engines	x 6, COIL ON PLUG									1.970.492	C10			
ENGINE														
3.8 GDI	Petrol	246	04/15->	G6DJ										
Engine	Information				A10	A20	A40	A50	A70	C10 - C30	C20	E01		
All engines	x 6, COIL ON PLUG									1.970.492	C10			

A10	CONDENSER	A20	CONTACT SET	A40	DISTRIBUTOR CAP	A50	ROTOR	A70	PICK-UP
C10	COIL	C20	IGNITION MODULE	C30	ELECTRONIC IGNITION KIT	E01	IGNITION CABLE SET		

The present application list is a brief version. For the detailed information about the possibility of installation on a specific vehicle, please refer to our web-catalogue <http://catalogo.facet.eu/>

				FUNCTIONS ON THE VEHICLE								
Vehicle	alim.	kW	Date	Engine	 A10	 A20	 A40	 A50	 A70	 C10 - C30	 C20	 E01
				ENGINE								
5.0 GDI	Petrol	312	05/15->	G8BE								
Engine		Information			A10	A20	A40	A50	A70	C10 - C30	C20	E01
All engines		x 8, COIL ON PLUG								1.970.556	C10	
				ENGINE								
RIO I												
1.3	Petrol	55	08/00-02/05	A3E								
Engine		Information			A10	A20	A40	A50	A70	C10 - C30	C20	E01
All engines												1.501.851
				ENGINE								
1.3	Petrol	60	08/00-02/05	A3E								
Engine		Information			A10	A20	A40	A50	A70	C10 - C30	C20	E01
All engines												1.501.851
				ENGINE								
1.5 16V	Petrol	71	09/02-02/05	A5D								
Engine		Information			A10	A20	A40	A50	A70	C10 - C30	C20	E01
All engines												1.499.239
				ENGINE								
1.5 16V	Petrol	72	08/00-02/05	A5D								
Engine		Information			A10	A20	A40	A50	A70	C10 - C30	C20	E01
All engines												1.499.239
				ENGINE								
1.6 [CAN] [USA]	Petrol	0	06/00-02/05	--								
Engine		Information			A10	A20	A40	A50	A70	C10 - C30	C20	E01
All engines												1.499.239
				ENGINE								
RIO II												
1.4	Petrol	55	01/10-12/11	G4EE								
Engine		Information			A10	A20	A40	A50	A70	C10 - C30	C20	E01
All engines		Fitting Position:for cylinder 1, Fitting Position:for cylinder 4, x 1, D.I.S.								1.970.582	C10	
All engines		Fitting Position:for cylinder 2, Fitting Position:for cylinder 3, x 1, D.I.S.								1.970.584	C10	
				ENGINE								
1.4 16V	Petrol	71	03/05-12/11	G4EE								
Engine		Information			A10	A20	A40	A50	A70	C10 - C30	C20	E01
All engines		Fitting Position:for cylinder 1, Fitting Position:for cylinder 4, x 1, D.I.S.								1.970.582	C10	
All engines		Fitting Position:for cylinder 2, Fitting Position:for cylinder 3, x 1, D.I.S.								1.970.584	C10	
All engines												1.499.111
				ENGINE								
1.6 16V	Petrol	82	03/05-12/11	G4ED								
Engine		Information			A10	A20	A40	A50	A70	C10 - C30	C20	E01
All engines												1.499.111
				ENGINE								
1.6 CVT	Petrol	82	03/05-12/11	G4ED								
Engine		Information			A10	A20	A40	A50	A70	C10 - C30	C20	E01
All engines												1.499.111
				ENGINE								
RIO III												
1.2	Petrol	51	09/11-12/17	G4LA								
Engine		Information			A10	A20	A40	A50	A70	C10 - C30	C20	E01
All engines		x 1, D.I.S.								1.970.579	C10	
				ENGINE								
1.2 CVT	Petrol	62	11/14-12/17	G4LA								
Engine		Information			A10	A20	A40	A50	A70	C10 - C30	C20	E01
All engines		Fitting Position:for cylinder 1-2, Fitting Position:for cylinder 3-4, x 4, -start-stop function, x 1, COIL ON PLUG, D.I.S.								1.970.579	C10	
All engines		x 4, +start-stop function, COIL ON PLUG								1.970.612	C10	

A10 CONDENSER	A20 CONTACT SET	A40 DISTRIBUTOR CAP	A50 ROTOR	A70 PICK-UP
C10 COIL	C20 IGNITION MODULE	C30 ELECTRONIC IGNITION KIT	E01 IGNITION CABLE SET	

Vehicle	alim.	kW	Date	Engine	FUNCTIONS ON THE VEHICLE							
					A10	A20	A40	A50	A70	C10 - C30	C20	E01
ENGINE												
1.2 CVVT	Petrol	63	04/15-12/17	G4LA								
Engine	Information				A10	A20	A40	A50	A70	C10 - C30	C20	E01
All engines	Fitting Position:for cylinder 1-2, Fitting Position:for cylinder 3-4, x 4, -start-stop function, x 1, COIL ON PLUG, -start-stop function, D.I.S.									1.970.579	C10	
All engines	x 4, +start-stop function, COIL ON PLUG									1.970.612	C10	
ENGINE												
1.2 CVVT	Petrol	64	11/14-12/17	G4LA								
Engine	Information				A10	A20	A40	A50	A70	C10 - C30	C20	E01
All engines	x 1, x 4, D.I.S., -start-stop function, COIL ON PLUG									1.970.579	C10	
All engines	x 4, +start-stop function, COIL ON PLUG									1.970.612	C10	
ENGINE												
1.25 CVVT	Petrol	63	09/11-12/17	G4LA								
Engine	Information				A10	A20	A40	A50	A70	C10 - C30	C20	E01
All engines	Fitting Position:for cylinder 1-2, Fitting Position:for cylinder 3-4, x 1, x 4, D.I.S., -start-stop function, x 1, COIL ON PLUG, D.I.S.									1.970.579	C10	
All engines	x 4, +start-stop function, COIL ON PLUG									1.970.612	C10	
ENGINE												
1.25 CVVT	Petrol	65	06/11-12/17	G4LA								
Engine	Information				A10	A20	A40	A50	A70	C10 - C30	C20	E01
All engines	Fitting Position:for cylinder 1-2, Fitting Position:for cylinder 2, x 4, Fitting Position:for cylinder 3, -start-stop function, x 1, COIL ON PLUG, D.I.S., x 1, D.I.S.									1.970.579	C10	
All engines	Qty: 2, -start-stop function, without fastening clamp									1.970.579	C10	
All engines	+start-stop function, Qty: 4									1.970.612	C10	
All engines	x 4, +start-stop function, COIL ON PLUG									1.970.612	C10	
ENGINE												
1.25 LPG	Petrol/ Liquified Petro- leum Gas (LPG)	63	09/11-12/17	G4LA								
Engine	Information				A10	A20	A40	A50	A70	C10 - C30	C20	E01
All engines	Fitting Position:for cylinder 1, Fitting Position:for cylinder 2, x 4, Fitting Position:for cylinder 3, Fitting Position:for cylinder 4, -start-stop function, COIL ON PLUG, x 1, -start-stop function, D.I.S.									1.970.579	C10	
All engines	x 4, +start-stop function, COIL ON PLUG									1.970.612	C10	
ENGINE												
1.4 CVVT	Petrol	78	10/11->	G4FA								
Engine	Information				A10	A20	A40	A50	A70	C10 - C30	C20	E01
All engines	Qty: 4									1.970.543	C10	
ENGINE												
1.4 CVVT	Petrol	79	06/11-12/17	G4FA								
Engine	Information				A10	A20	A40	A50	A70	C10 - C30	C20	E01
All engines	x 4, COIL ON PLUG									1.970.543	C10	
ENGINE												
1.4 CVVT	Petrol	80	09/11->	G4FA								
Engine	Information				A10	A20	A40	A50	A70	C10 - C30	C20	E01
All engines	x 4, COIL ON PLUG									1.970.543	C10	
ENGINE												
1.6 CVVT	Petrol	90	06/12-12/17	G4FC								
Engine	Information				A10	A20	A40	A50	A70	C10 - C30	C20	E01
All engines	x 4, COIL ON PLUG									1.970.543	C10	
RIO IV												
ENGINE												
1.0 T-GDI 100	Petrol	74	01/17->	G3LC, G3LE								
Engine	Information				A10	A20	A40	A50	A70	C10 - C30	C20	E01
All engines	x 3, COIL ON PLUG									1.970.638	C10	
ENGINE												
1.0 T-GDI 100 Eco-Dynamics+	Petrol/ Electric	74	02/17->	G3LF								
Engine	Information				A10	A20	A40	A50	A70	C10 - C30	C20	E01
All engines	x 3, COIL ON PLUG									1.970.638	C10	









A10 CONDENSER	A20 CONTACT SET	A40 DISTRIBUTOR CAP	A50 ROTOR	A70 PICK-UP
C10 COIL	C20 IGNITION MODULE	C30 ELECTRONIC IGNITION KIT	E01 IGNITION CABLE SET	

The present application list is a brief version. For the detailed information about the possibility of installation on a specific vehicle, please refer to our web-catalogue <http://catalogo.facet.eu/>

Vehicle	alim.	kW	Date	Engine	FUNCTIONS ON THE VEHICLE									
					A10	A20	A40	A50	A70	C10 - C30	C20	E01		
ENGINE														
1.0 T-GDI 120	Petrol	88	01/17->	G3LC										
Engine	Information				A10	A20	A40	A50	A70	C10 - C30	C20	E01		
All engines	x 3, COIL ON PLUG									1.970.638	C10			
ENGINE														
1.25	Petrol	62	01/17->	G4LA										
Engine	Information				A10	A20	A40	A50	A70	C10 - C30	C20	E01		
All engines	x 4, COIL ON PLUG									1.970.612	C10			
ENGINE														
1.4	Petrol	73	01/17->	G4LC										
Engine	Information				A10	A20	A40	A50	A70	C10 - C30	C20	E01		
All engines	x 4, COIL ON PLUG									1.970.622	C10			
ENGINE														
1.4	Petrol	74	01/17->	G4LC										
Engine	Information				A10	A20	A40	A50	A70	C10 - C30	C20	E01		
All engines	x 4, COIL ON PLUG									1.970.622	C10			
ENGINE														
1.6	Petrol	90	01/17->	G4FG										
Engine	Information				A10	A20	A40	A50	A70	C10 - C30	C20	E01		
All engines	euro 5, x 4, COIL ON PLUG, x 4, COIL ON PLUG									1.970.543	C10			
SEPHIA														
ENGINE														
1.5 i 16V	Petrol	0	09/97->	--										
Engine	Information				A10	A20	A40	A50	A70	C10 - C30	C20	E01		
All engines														1.501.841
ENGINE														
1.6 i 16V	Petrol	0	07/00->	--										
Engine	Information				A10	A20	A40	A50	A70	C10 - C30	C20	E01		
All engines														1.499.239
ENGINE														
1.8 i 16V	Petrol	0	09/97->	--										
Engine	Information				A10	A20	A40	A50	A70	C10 - C30	C20	E01		
All engines														1.501.841
SEPHIA I														
ENGINE														
1.5 i	Petrol	59	02/96-10/97	B5										
Engine	Information				A10	A20	A40	A50	A70	C10 - C30	C20	E01		
All engines														1.501.841
ENGINE														
1.6 i	Petrol	59	09/93-10/97	B6										
Engine	Information				A10	A20	A40	A50	A70	C10 - C30	C20	E01		
All engines	version Mitsubishi						1.331.121							
All engines														1.501.398
ENGINE														
1.8 i 16V	Petrol	0	01/95-10/97	--										
Engine	Information				A10	A20	A40	A50	A70	C10 - C30	C20	E01		
All engines														1.501.841
ENGINE														
1.8 i 16V	Petrol	82	01/95-10/97	OK24N, OK26Y										
Engine	Information				A10	A20	A40	A50	A70	C10 - C30	C20	E01		
All engines														1.501.841
SHUMA I														
ENGINE														
1.5	Petrol	59	03/96-12/98	OK280										
Engine	Information				A10	A20	A40	A50	A70	C10 - C30	C20	E01		
All engines														1.501.841
ENGINE														
1.5 i 16V	Petrol	65	10/97-10/01	BFD, ZY-VE										
Engine	Information				A10	A20	A40	A50	A70	C10 - C30	C20	E01		
All engines														1.501.841

A10 CONDENSER	A20 CONTACT SET	A40 DISTRIBUTOR CAP	A50 ROTOR	A70 PICK-UP
C10 COIL	C20 IGNITION MODULE	C30 ELECTRONIC IGNITION KIT	E01 IGNITION CABLE SET	

Vehicle	alim.	kW	Date	Engine	FUNCTIONS ON THE VEHICLE														
					A10	A20	A40	A50	A70	C10 - C30	C20	E01							
ENGINE																			
1.6	Petrol	75	01/01-12/01	GA6D															
Engine		Information			A10	A20	A40	A50	A70	C10 - C30	C20	E01							
All engines													1.499.239						
ENGINE																			
1.8 i 16V	Petrol	81	10/97-03/01	T8															
Engine		Information			A10	A20	A40	A50	A70	C10 - C30	C20	E01							
All engines													1.501.841						
SHUMA II																			
ENGINE																			
1.6	Petrol	75	05/01-08/04	GA6D															
Engine		Information			A10	A20	A40	A50	A70	C10 - C30	C20	E01							
All engines													1.499.239						
ENGINE																			
1.8	Petrol	81	05/01-06/04	T8															
Engine		Information			A10	A20	A40	A50	A70	C10 - C30	C20	E01							
All engines													1.501.841						
ENGINE																			
1.8	Petrol	84	04/03-08/04	T8															
Engine		Information			A10	A20	A40	A50	A70	C10 - C30	C20	E01							
All engines													1.501.841						
SORENTO I																			
ENGINE																			
3.3 V6	Petrol	177	12/06->	--															
Engine		Information			A10	A20	A40	A50	A70	C10 - C30	C20	E01							
All engines		Qty: 6								1.970.492	C10								
ENGINE																			
3.3 V6 4WD	Petrol	182	02/07-12/11	G6DB															
Engine		Information			A10	A20	A40	A50	A70	C10 - C30	C20	E01							
All engines		x 6, COIL ON PLUG								1.970.492	C10								
SORENTO II																			
ENGINE																			
2.4 CVVT	Petrol	128	11/09-12/15	G4KE															
Engine		Information			A10	A20	A40	A50	A70	C10 - C30	C20	E01							
All engines		x 4, COIL ON PLUG								1.970.556	C10								
ENGINE																			
2.4 CVVT	Petrol	141	10/12-12/15	G4KJ															
Engine		Information			A10	A20	A40	A50	A70	C10 - C30	C20	E01							
All engines		x 4, COIL ON PLUG								1.970.556	C10								
ENGINE																			
2.4 CVVT 4WD	Petrol	128	11/09-12/15	G4KE															
Engine		Information			A10	A20	A40	A50	A70	C10 - C30	C20	E01							
All engines		x 4, COIL ON PLUG								1.970.556	C10								
ENGINE																			
2.4 CVVT 4WD	Petrol	141	10/12-12/15	G4KJ															
Engine		Information			A10	A20	A40	A50	A70	C10 - C30	C20	E01							
All engines		x 4, COIL ON PLUG								1.970.556	C10								
ENGINE																			
2.4 GDI	Petrol	141	10/12-12/15	G4KJ															
Engine		Information			A10	A20	A40	A50	A70	C10 - C30	C20	E01							
All engines		x 4, COIL ON PLUG								1.970.556	C10								
ENGINE																			
2.4 GDI 4WD	Petrol	141	10/12-12/15	G4KJ															
Engine		Information			A10	A20	A40	A50	A70	C10 - C30	C20	E01							
All engines		x 4, COIL ON PLUG								1.970.556	C10								
ENGINE																			
2.4 LPG	Petrol/ Liquified Petroleum Gas (LPG)	126	04/10-12/15	G4KE															
Engine		Information			A10	A20	A40	A50	A70	C10 - C30	C20	E01							
All engines		x 4, COIL ON PLUG								1.970.556	C10								
A10	CONDENSER			A20	CONTACT SET			A40	DISTRIBUTOR CAP			A50	ROTOR			A70	PICK-UP		
C10	COIL			C20	IGNITION MODULE			C30	ELECTRONIC IGNITION KIT			E01	IGNITION CABLE SET						









					FUNCTIONS ON THE VEHICLE							
Vehicle	alim.	kW	Date	Engine	 A10	 A20	 A40	 A50	 A70	 C10 - C30	 C20	 E01
ENGINE												
2.4 LPG 4WD	Petrol/ Liquified Petroleum Gas (LPG)	126	04/10-12/15	G4KE								
Engine	Information				A10	A20	A40	A50	A70	C10 - C30	C20	E01
All engines	x 4, COIL ON PLUG									1.970.556	C10	
ENGINE												
3.3 GDI	Petrol	0	10/12->	--								
Engine	Information				A10	A20	A40	A50	A70	C10 - C30	C20	E01
All engines	Qty: 6									1.970.492	C10	
ENGINE												
3.5	Petrol	204	05/13-12/15	G6DC								
Engine	Information				A10	A20	A40	A50	A70	C10 - C30	C20	E01
All engines	Qty: 6									1.970.492	C10	
ENGINE												
3.5	Petrol	207	11/09->	G6DC								
Engine	Information				A10	A20	A40	A50	A70	C10 - C30	C20	E01
All engines	Qty: 6									1.970.492	C10	
ENGINE												
3.5 4WD	Petrol	203	11/09->	G6DC								
Engine	Information				A10	A20	A40	A50	A70	C10 - C30	C20	E01
All engines	Qty: 6									1.970.492	C10	
ENGINE												
3.5 4WD	Petrol	204	05/13-12/15	G6DC								
Engine	Information				A10	A20	A40	A50	A70	C10 - C30	C20	E01
All engines	Qty: 6									1.970.492	C10	
ENGINE												
CVVT	Petrol	128	06/09-12/15	G4KE								
Engine	Information				A10	A20	A40	A50	A70	C10 - C30	C20	E01
All engines	x 4, COIL ON PLUG									1.970.556	C10	
ENGINE												
CVVT 4WD	Petrol	128	06/09-12/15	G4KE								
Engine	Information				A10	A20	A40	A50	A70	C10 - C30	C20	E01
All engines	x 4, COIL ON PLUG									1.970.556	C10	
SORENTO III												
ENGINE												
3.5 D-CVVT	Petrol	183	12/18->	G6DC								
Engine	Information				A10	A20	A40	A50	A70	C10 - C30	C20	E01
All engines	x 6, COIL ON PLUG									1.970.492	C10	
ENGINE												
3.5 D-CVVT 4WD	Petrol	183	12/18->	G6DC								
Engine	Information				A10	A20	A40	A50	A70	C10 - C30	C20	E01
All engines	x 6, COIL ON PLUG									1.970.492	C10	
SOUL I												
ENGINE												
1.6	Petrol	91	09/09-12/14	G4FC								
Engine	Information				A10	A20	A40	A50	A70	C10 - C30	C20	E01
All engines	x 4, COIL ON PLUG									1.970.543	C10	
ENGINE												
1.6 CVVT	Petrol	77	02/09-12/11	G4FC								
Engine	Information				A10	A20	A40	A50	A70	C10 - C30	C20	E01
All engines	x 4, COIL ON PLUG									1.970.543	C10	
ENGINE												
1.6 CVVT	Petrol	93	02/09-12/11	G4FC								
Engine	Information				A10	A20	A40	A50	A70	C10 - C30	C20	E01
All engines	x 4, COIL ON PLUG									1.970.543	C10	
ENGINE												
1.6 CVVT	Petrol	95	06/11-12/14	G4FC								
Engine	Information				A10	A20	A40	A50	A70	C10 - C30	C20	E01
All engines	x 4, COIL ON PLUG									1.970.543	C10	

A10 CONDENSER	A20 CONTACT SET	A40 DISTRIBUTOR CAP	A50 ROTOR	A70 PICK-UP
C10 COIL	C20 IGNITION MODULE	C30 ELECTRONIC IGNITION KIT	E01 IGNITION CABLE SET	

Vehicle	alim.	kW	Date	Engine	FUNCTIONS ON THE VEHICLE							
					A10	A20	A40	A50	A70	C10 - C30	C20	E01
ENGINE												
1.6 Flex	Flexfuel	94	01/11->	--								
ENGINE												
Engine	Information			A10	A20	A40	A50	A70	C10 - C30	C20	E01	
All engines	Qty: 4, no specific info conc. application available								1.970.543, 1.970.611	C10		
ENGINE												
1.6 GDI	Petrol	103	06/11-12/14	G4FD								
ENGINE												
Engine	Information			A10	A20	A40	A50	A70	C10 - C30	C20	E01	
All engines	x 4, COIL ON PLUG								1.970.611	C10		
ENGINE												
1.6 LPG	Petrol/ Liquified Petroleum Gas (LPG)	87	06/11-12/14	G4FC								
ENGINE												
Engine	Information			A10	A20	A40	A50	A70	C10 - C30	C20	E01	
All engines	x 4, COIL ON PLUG								1.970.543	C10		
ENGINE												
1.6 LPG	Petrol/ Liquified Petroleum Gas (LPG)	92	02/09-12/11	G4FC								
ENGINE												
Engine	Information			A10	A20	A40	A50	A70	C10 - C30	C20	E01	
All engines	x 4, COIL ON PLUG								1.970.543	C10		
SOUL II												
ENGINE												
1.6 CVT	Petrol	91	02/14->	G4FG								
ENGINE												
Engine	Information			A10	A20	A40	A50	A70	C10 - C30	C20	E01	
All engines	x 4, COIL ON PLUG								1.970.543	C10		
ENGINE												
1.6 GDI	Petrol	97	02/14->	G4FD								
ENGINE												
Engine	Information			A10	A20	A40	A50	A70	C10 - C30	C20	E01	
All engines	x 4, COIL ON PLUG								1.970.611	C10		
ENGINE												
1.6 LPG	Petrol/ Liquified Petroleum Gas (LPG)	96	12/14->	G4FG								
ENGINE												
Engine	Information			A10	A20	A40	A50	A70	C10 - C30	C20	E01	
All engines	x 4, COIL ON PLUG								1.970.543	C10		
SOUL III												
ENGINE												
1.6 MPi	Petrol	91	01/19->	G4FG								
ENGINE												
Engine	Information			A10	A20	A40	A50	A70	C10 - C30	C20	E01	
All engines	x 4, COIL ON PLUG								1.970.543	C10		
SPECTRA												
ENGINE												
1.5 i	Petrol	0	09/97->	--								
ENGINE												
Engine	Information			A10	A20	A40	A50	A70	C10 - C30	C20	E01	
All engines											1.501.841	
ENGINE												
1.5 i 16V	Petrol	65	09/97->	--								
ENGINE												
Engine	Information			A10	A20	A40	A50	A70	C10 - C30	C20	E01	
All engines											1.501.841	
ENGINE												
1.6 i 16V	Petrol	75	07/00->	--								
ENGINE												
Engine	Information			A10	A20	A40	A50	A70	C10 - C30	C20	E01	
All engines											1.499.239	
ENGINE												
1.8 i 16V	Petrol	93	09/97->	--								
ENGINE												
Engine	Information			A10	A20	A40	A50	A70	C10 - C30	C20	E01	
All engines											1.501.841	

A10	CONDENSER	A20	CONTACT SET	A40	DISTRIBUTOR CAP	A50	ROTOR	A70	PICK-UP
C10	COIL	C20	IGNITION MODULE	C30	ELECTRONIC IGNITION KIT	E01	IGNITION CABLE SET		

The present application list is a brief version. For the detailed information about the possibility of installation on a specific vehicle, please refer to our web-catalogue <http://catalogo.facet.eu/>

					FUNCTIONS ON THE VEHICLE							
Vehicle	alim.	kW	Date	Engine								
SPORTAGE I												
2.0 4WD	Petrol	70	06/95-11/98	FE (8V)								
ENGINE												
Engine		Information			A10	A20	A40	A50	A70	C10 - C30	C20	E01
All engines		x 1, D.I.S., connector type, saw teeth								1.970.168	C10	
2.0 i 4WD	Petrol	70	04/94-08/99	FE (8V)								
ENGINE												
Engine		Information			A10	A20	A40	A50	A70	C10 - C30	C20	E01
All engines		x 1, D.I.S., connector type, saw teeth								1.970.168	C10	
SPORTAGE II												
2.0	Petrol	122	01/09-05/10	G4KD								
ENGINE												
Engine		Information			A10	A20	A40	A50	A70	C10 - C30	C20	E01
All engines		x 1, D.I.S.								1.970.581	C10	
2.0 16V 4WD	Petrol	104	09/04->	G4GC								
ENGINE												
Engine		Information			A10	A20	A40	A50	A70	C10 - C30	C20	E01
All engines		x 1, D.I.S.								1.970.581	C10	
All engines												1.501.385
2.0 i 16V	Petrol	104	09/04->	G4GC								
ENGINE												
Engine		Information			A10	A20	A40	A50	A70	C10 - C30	C20	E01
All engines		x 1, D.I.S.								1.970.581	C10	
All engines												1.501.385
2.0 LPG	Petrol/ Liquified Petro- leum Gas (LPG)	101	06/09-05/10	G4GC								
ENGINE												
Engine		Information			A10	A20	A40	A50	A70	C10 - C30	C20	E01
All engines		x 1, D.I.S.								1.970.581	C10	
2.7 V6 4WD	Petrol	129	09/04->	G6BA								
ENGINE												
Engine		Information			A10	A20	A40	A50	A70	C10 - C30	C20	E01
All engines												1.499.236
SPORTAGE III												
1.6 GDI	Petrol	99	02/11->	G4FD								
ENGINE												
Engine		Information			A10	A20	A40	A50	A70	C10 - C30	C20	E01
All engines		x 4, COIL ON PLUG								1.970.611	C10	
1.6 LPG	Petrol/ Liquified Petro- leum Gas (LPG)	99	01/14-12/15	G4FD								
ENGINE												
Engine		Information			A10	A20	A40	A50	A70	C10 - C30	C20	E01
All engines		x 4, COIL ON PLUG								1.970.611	C10	
2.0 CVT	Petrol	110	06/10-12/13	G4KD								
ENGINE												
Engine		Information			A10	A20	A40	A50	A70	C10 - C30	C20	E01
All engines		x 4, COIL ON PLUG								1.970.556	C10	
2.0 CVT	Petrol	120	07/10->	G4KD								
ENGINE												
Engine		Information			A10	A20	A40	A50	A70	C10 - C30	C20	E01
All engines		x 4, COIL ON PLUG								1.970.556	C10	
2.0 CVT	Petrol	122	07/10->	G4KD								
ENGINE												
Engine		Information			A10	A20	A40	A50	A70	C10 - C30	C20	E01
All engines		x 4, COIL ON PLUG								1.970.556	C10	

A10 CONDENSER	A20 CONTACT SET	A40 DISTRIBUTOR CAP	A50 ROTOR	A70 PICK-UP
C10 COIL	C20 IGNITION MODULE	C30 ELECTRONIC IGNITION KIT	E01 IGNITION CABLE SET	

Vehicle	alim.	kW	Date	Engine	FUNCTIONS ON THE VEHICLE								
					A10	A20	A40	A50	A70	C10 - C30	C20	E01	
ENGINE													
2.0 CVVT AWD	Petrol	110	06/10-12/13	G4KD									
ENGINE													
All engines					x 4, COIL ON PLUG						1.970.556	C10	
2.0 CVVT AWD	Petrol	120	07/10->	G4KD									
ENGINE													
All engines					x 4, COIL ON PLUG						1.970.556	C10	
2.0 CVVT AWD	Petrol	122	07/10->	G4KD, G4NC									
ENGINE													
Eng. G4KD					x 4, COIL ON PLUG						1.970.556	C10	
Eng. G4NC					Qty: 4						1.970.556	C10	
2.4 i 4WD	Petrol	130	08/10->	G4KE									
ENGINE													
All engines					Qty: 4						1.970.556	C10	
SPORTAGE IV													
1.6 GDI	Petrol	97	09/15->	G4FD									
ENGINE													
All engines					x 4, COIL ON PLUG						1.970.611	C10	
1.6 LPG	Petrol/ Liquified Petro- leum Gas (LPG)	93	07/20->	G4FD									
ENGINE													
All engines					x 4, COIL ON PLUG						1.970.611	C10	
STONIC													
1.0 T-GDi	Petrol	74	08/18->	G3LC									
ENGINE													
All engines					x 3, COIL ON PLUG						1.970.638	C10	
1.0 T-GDi	Petrol	88	07/17->	G3LC									
ENGINE													
All engines					x 3, COIL ON PLUG						1.970.638	C10	
1.2 CVVT	Petrol	62	07/17->	G4LA									
ENGINE													
All engines					x 4, COIL ON PLUG						1.970.612	C10	
1.4 CVVT	Petrol	73	07/17->	G4LC									
ENGINE													
All engines					x 4, COIL ON PLUG						1.970.622	C10	
1.4 LPG	Petrol/ Liquified Petro- leum Gas (LPG)	71	11/18->	G4LC									
ENGINE													
All engines					x 4, COIL ON PLUG						1.970.622	C10	
TOWNER													
0.8 Gasoline	Petrol	31	10/97->	--									
ENGINE													
All engines											1.970.219	C10	

A10	CONDENSER	A20	CONTACT SET	A40	DISTRIBUTOR CAP	A50	ROTOR	A70	PICK-UP
C10	COIL	C20	IGNITION MODULE	C30	ELECTRONIC IGNITION KIT	E01	IGNITION CABLE SET		

The present application list is a brief version. For the detailed information about the possibility of installation on a specific vehicle, please refer to our web-catalogue <http://catalogo.facet.eu/>

Vehicle	alim.	kW	Date	Engine	FUNCTIONS ON THE VEHICLE							
					A10	A20	A40	A50	A70	C10 - C30	C20	E01

VENGA

				ENGINE
1.4 CVT	Petrol	66	02/10->	G4FA, G4FA-L

Engine	Information	A10	A20	A40	A50	A70	C10 - C30	C20	E01
Eng. G4FA	x 4, COIL ON PLUG						1.970.543	C10	
Eng. G4FA-L	Qty: 4						1.970.543	C10	

				ENGINE
1.4 LPG	Petrol/ Liquified Petroleum Gas (LPG)	66	02/10->	G4FA

Engine	Information	A10	A20	A40	A50	A70	C10 - C30	C20	E01
All engines	x 4, COIL ON PLUG						1.970.543	C10	

				ENGINE
1.6 CVT	Petrol	92	02/10->	G4FC

Engine	Information	A10	A20	A40	A50	A70	C10 - C30	C20	E01
All engines	x 4, COIL ON PLUG						1.970.543	C10	

				ENGINE
CVT	Petrol	66	04/15->	G4FA

Engine	Information	A10	A20	A40	A50	A70	C10 - C30	C20	E01
All engines	x 4, COIL ON PLUG						1.970.543	C10	

				ENGINE
CVT	Petrol	92	02/15->	G4FC

Engine	Information	A10	A20	A40	A50	A70	C10 - C30	C20	E01
All engines	x 4, COIL ON PLUG						1.970.543	C10	

XCEED

				ENGINE
1.0 T-GDI	Petrol	88	06/19->	G3LC

Engine	Information	A10	A20	A40	A50	A70	C10 - C30	C20	E01
All engines	x 3, COIL ON PLUG						1.970.638	C10	

				ENGINE
1.6 GDI Hybrid	Petrol/ Electric	104	12/19->	G4LE

Engine	Information	A10	A20	A40	A50	A70	C10 - C30	C20	E01
All engines	x 4, COIL ON PLUG						1.970.647	C10	

				ENGINE
1.6 GDI Hybrid	Petrol/ Electric	77	12/19->	G4LE

Engine	Information	A10	A20	A40	A50	A70	C10 - C30	C20	E01
All engines	x 4, COIL ON PLUG						1.970.647	C10	

A10 CONDENSER	A20 CONTACT SET	A40 DISTRIBUTOR CAP	A50 ROTOR	A70 PICK-UP
C10 COIL	C20 IGNITION MODULE	C30 ELECTRONIC IGNITION KIT	E01 IGNITION CABLE SET	

Vehicle	alim.	kW	Date	Engine	FUNCTIONS ON THE VEHICLE									
					A10	A20	A40	A50	A70	C10 - C30	C20	E01		
LARGUS														
1.6	Petrol	62	03/12->	ENGINE K7M										
Engine		Information			A10	A20	A40	A50	A70	C10 - C30	C20	E01		
All engines		x 1, D.I.S.								1.970.596	C10			
1.6	Petrol	64	04/16->	ENGINE 11189										
Engine		Information			A10	A20	A40	A50	A70	C10 - C30	C20	E01		
All engines		x 1, D.I.S.								1.970.596	C10			
1.6	Petrol	75	04/16->	ENGINE K4M										
Engine		Information			A10	A20	A40	A50	A70	C10 - C30	C20	E01		
All engines		x 4, COIL ON PLUG								1.970.432	C10			
1.6	Petrol	77	03/12->	ENGINE K4M										
Engine		Information			A10	A20	A40	A50	A70	C10 - C30	C20	E01		
All engines		x 4, COIL ON PLUG								1.970.432	C10			
1.6	Petrol	78	09/17->	ENGINE 21129										
Engine		Information			A10	A20	A40	A50	A70	C10 - C30	C20	E01		
All engines		x 4, COIL ON PLUG								1.970.432	C10			
NIVA I														
1600	Petrol	56	12/76-12/93	ENGINE BA3 2121										
Engine		Information			A10	A20	A40	A50	A70	C10 - C30	C20	E01		
All engines		version Russian distributor				1.246.070								
All engines		version Hungarian distributor				1.246.071								
All engines		version U.D.S.S.R.					1.347.025	1.446.014R						
All engines										1.970.101D	C10		1.500.511	
RIVA														
1.5	Petrol	55	01/85->	ENGINE --										
Engine		Information			A10	A20	A40	A50	A70	C10 - C30	C20	E01		
All engines						1.246.070	1.347.025	1.446.014R						
1.6	Petrol	63	01/85->	ENGINE --										
Engine		Information			A10	A20	A40	A50	A70	C10 - C30	C20	E01		
All engines						1.246.070	1.347.025	1.446.014R						
SAMARA														
1.5	Petrol	52	01/97->	ENGINE --										
Engine		Information			A10	A20	A40	A50	A70	C10 - C30	C20	E01		
All engines		version U.D.S.S.R.					1.347.027	1.446.016R						
1100	Petrol	39	02/88-12/94	ENGINE BA3 21081										
Engine		Information			A10	A20	A40	A50	A70	C10 - C30	C20	E01		
All engines		version U.D.S.S.R.					1.347.027	1.446.016R						
1300	Petrol	48	01/86-12/94	ENGINE BA3 2108										
Engine		Information			A10	A20	A40	A50	A70	C10 - C30	C20	E01		
All engines		version U.D.S.S.R.					1.347.027	1.446.016R						
1500	Petrol	53	09/87-12/96	ENGINE BA3 21083										
Engine		Information			A10	A20	A40	A50	A70	C10 - C30	C20	E01		
All engines		version U.D.S.S.R.					1.347.027	1.446.016R						
VESTA														
1.6	Petrol	83	11/19->	ENGINE H4M										
Engine		Information			A10	A20	A40	A50	A70	C10 - C30	C20	E01		
All engines		x 4, COIL ON PLUG								1.970.613	C10			

A10	CONDENSER	A20	CONTACT SET	A40	DISTRIBUTOR CAP	A50	ROTOR	A70	PICK-UP
C10	COIL	C20	IGNITION MODULE	C30	ELECTRONIC IGNITION KIT	E01	IGNITION CABLE SET		

The present application list is a brief version. For the detailed information about the possibility of installation on a specific vehicle, please refer to our web-catalogue <http://catalogo.facet.eu/>

Vehicle	alim.	kW	Date	Engine	FUNCTIONS ON THE VEHICLE							
					A10	A20	A40	A50	A70	C10 - C30	C20	E01

A 112

				ENGINE
0.9 Junior	Petrol	29	03/81-06/86	A112 A5.000

Engine	Information	A10	A20	A40	A50	A70	C10 - C30	C20	E01
All engines	version Ducellier	1.115.023	1.215.101	1.315.058	1.415.083R				
All engines							1.970.101D C10		

				ENGINE
1.0 Abarth	Petrol	51	03/78-02/84	A112 A2.000

Engine	Information	A10	A20	A40	A50	A70	C10 - C30	C20	E01
All engines	version Marelli			1.330.093	1.430.054R	1.930.161/1			

BETA

				ENGINE
1600	Petrol	74	08/73-07/82	828 B.000

Engine	Information	A10	A20	A40	A50	A70	C10 - C30	C20	E01
All engines	version Bosch			1.306.079	1.406.025R				
All engines	version Marelli				1.430.054R	1.930.163/1			
All engines							1.970.103 C10		

DEDRA

				ENGINE
1.6	Petrol	66	10/94-07/99	159 B9.000

Engine	Information	A10	A20	A40	A50	A70	C10 - C30	C20	E01
All engines									1.500.888

				ENGINE
1.6 16V	Petrol	76	01/96-07/99	182 A4.000

Engine	Information	A10	A20	A40	A50	A70	C10 - C30	C20	E01
All engines							1.970.345 C10		1.501.503

				ENGINE
1.6 i.e.	Petrol	55	04/93-07/99	835 C1.000

Engine	Information	A10	A20	A40	A50	A70	C10 - C30	C20	E01
All engines							1.970.168 C10		1.500.655

				ENGINE
1.6 i.e.	Petrol	57	08/89-03/93	835 A1.046

Engine	Information	A10	A20	A40	A50	A70	C10 - C30	C20	E01
All engines	-> eng. 7852632, version Marelli			1.330.104					
All engines	eng. type 7852632 ->, version Marelli			1.330.115					
All engines	version Marelli, no specific info conc. application available				1.430.055R, 1.430.059				
All engines							1.970.148 C10		

				ENGINE
1.6 i.e.	Petrol	66	08/89-06/94	835 A1.000

Engine	Information	A10	A20	A40	A50	A70	C10 - C30	C20	E01
All engines	version Marelli			1.330.104					
All engines	version Marelli, no specific info conc. application available				1.430.055R, 1.430.059				
All engines							1.990.303 C30		

				ENGINE
1.6 LE Cat	Petrol	66	07/94-07/99	159 B9.000

Engine	Information	A10	A20	A40	A50	A70	C10 - C30	C20	E01
All engines									1.500.888

				ENGINE
1.8 i.e.	Petrol	66	08/93-07/99	835 C5.000

Engine	Information	A10	A20	A40	A50	A70	C10 - C30	C20	E01
All engines	version Marelli			1.330.115	1.430.060	1.930.177/1			
All engines							1.990.303 C30		1.500.692

				ENGINE
1.8 i.e.	Petrol	74	07/94-07/99	836 A5.000

Engine	Information	A10	A20	A40	A50	A70	C10 - C30	C20	E01
All engines	Qty: 2						1.970.146 C10		
All engines									1.500.889

				ENGINE
1.8 i.e.	Petrol	77	09/89-07/99	835 A2.046

Engine	Information	A10	A20	A40	A50	A70	C10 - C30	C20	E01
All engines	version Marelli			1.330.115	1.430.060	1.930.177/1			

A10 CONDENSER	A20 CONTACT SET	A40 DISTRIBUTOR CAP	A50 ROTOR	A70 PICK-UP
C10 COIL	C20 IGNITION MODULE	C30 ELECTRONIC IGNITION KIT	E01 IGNITION CABLE SET	

Vehicle	alim.	kW	Date	Engine	FUNCTIONS ON THE VEHICLE									
					A10	A20	A40	A50	A70	C10 - C30	C20	E01		
ENGINE														
1.8 i.e.	Petrol	77	09/89-07/99	835 A2.046										
Engine	Information				A10	A20	A40	A50	A70	C10 - C30	C20	E01		
All engines										1.990.303	C30		1.500.692	
ENGINE														
1.8 i.e.	Petrol	80	09/89-06/94	835 A2.000										
Engine	Information				A10	A20	A40	A50	A70	C10 - C30	C20	E01		
All engines	version Marelli						1.330.115	1.430.060	1.930.177/1					
All engines										1.990.303	C30		1.500.692	
ENGINE														
2.0 16V	Petrol	102	07/94-07/99	836 A3.000										
Engine	Information				A10	A20	A40	A50	A70	C10 - C30	C20	E01		
All engines	version Marelli						1.330.114	1.430.060	1.930.177/1					
All engines										1.990.303	C30		1.500.650	
ENGINE														
2.0 HF Integrale	Petrol	124	11/90-07/94	835 A7.046										
Engine	Information				A10	A20	A40	A50	A70	C10 - C30	C20	E01		
All engines	version Marelli						1.330.115	1.430.060	1.930.177/1					
All engines										1.990.303	C30		1.500.692	
ENGINE														
2.0 i.e.	Petrol	83	09/89-07/99	835 A5.046										
Engine	Information				A10	A20	A40	A50	A70	C10 - C30	C20	E01		
All engines	01/07/94 -> version Marelli, +automatic transmission, eng. type 1339290 ->						1.330.114							
All engines	version Marelli							1.430.060	1.930.177/1					
All engines										1.990.303	C30			
All engines	+automatic transmission, ->eng. 1303624												1.500.692	
ENGINE														
2.0 i.e.	Petrol	86	09/89-07/92	835 A5.000										
Engine	Information				A10	A20	A40	A50	A70	C10 - C30	C20	E01		
All engines	version Marelli						1.330.115	1.430.060	1.930.177/1					
All engines										1.990.303	C30		1.500.692	
ENGINE														
2.0 i.e. Turbo	Petrol	119	04/91-07/99	835 A8.046										
Engine	Information				A10	A20	A40	A50	A70	C10 - C30	C20	E01		
All engines	version Marelli						1.330.115	1.430.060	1.930.177/1					
All engines										1.990.303	C30		1.500.692	
ENGINE														
2.0 i.e. Turbo Integrale	Petrol	121	04/90-08/91	835 A7.000										
Engine	Information				A10	A20	A40	A50	A70	C10 - C30	C20	E01		
All engines	version Marelli						1.330.115	1.430.060	1.930.177/1					
All engines										1.990.303	C30		1.500.692	
ENGINE														
2.0 Integrale	Petrol	102	07/94-07/99	836 A3.000										
Engine	Information				A10	A20	A40	A50	A70	C10 - C30	C20	E01		
All engines	version Marelli						1.330.114	1.430.060	1.930.177/1					
All engines										1.990.303	C30		1.500.650	
ENGINE														
2.0 Turbo	Petrol	130	11/90-06/94	835 A8.000										
Engine	Information				A10	A20	A40	A50	A70	C10 - C30	C20	E01		
All engines	version Marelli						1.330.115	1.430.060	1.930.177/1					
All engines										1.990.303	C30		1.500.692	
DELTA I														
ENGINE														
1.1	Petrol	47	01/86-12/90	831 B8.000										
Engine	Information				A10	A20	A40	A50	A70	C10 - C30	C20	E01		
All engines	version Marelli						1.330.101	1.430.047R	1.930.176M					
All engines										1.970.158	C10	1.965.020	1.500.354	

A10 CONDENSER	A20 CONTACT SET	A40 DISTRIBUTOR CAP	A50 ROTOR	A70 PICK-UP
C10 COIL	C20 IGNITION MODULE	C30 ELECTRONIC IGNITION KIT	E01 IGNITION CABLE SET	

The present application list is a brief version. For the detailed information about the possibility of installation on a specific vehicle, please refer to our web-catalogue <http://catalogo.facet.eu/>

FUNCTIONS ON THE VEHICLE

Vehicle	alim.	kW	Date	Engine	A10	A20	A40	A50	A70	C10 - C30	C20	E01
ENGINE												
1.3	Petrol	55	09/79-08/92	831 A2.000, 831 B.000								
Engine	Information			A10	A20	A40	A50	A70	C10 - C30	C20	E01	
All engines	version Marelli, no specific info conc. application available					1.330.101, 1.330.104						
All engines	->eng. 6651557, version Marelli						1.430.047R					
All engines	eng. type 6651557 ->, version Marelli						1.430.060					
All engines	version Marelli							1.930.176M				
All engines									1.970.158	C10	1.965.020	1.500.354
ENGINE												
1.3	Petrol	58	09/83-08/92	831 A2.000								
Engine	Information			A10	A20	A40	A50	A70	C10 - C30	C20	E01	
All engines	version Marelli, no specific info conc. application available					1.330.101						
All engines	->eng. 6651557, version Marelli						1.430.047R					
All engines	eng. type 6651557 ->, version Marelli						1.430.060					
All engines	version Marelli							1.930.176M				
All engines									1.970.158	C10	1.965.020	1.500.354
ENGINE												
1.5	Petrol	63	09/79-12/92	831 A1.000, 831 B1.000								
Engine	Information			A10	A20	A40	A50	A70	C10 - C30	C20	E01	
All engines	version Marelli					1.330.104	1.430.055R					
All engines									1.970.103	C10		
All engines	VET. 6119941 ->, ->VET. 0626853											1.500.354
ENGINE												
1.6 GT i.e.	Petrol	66	05/87-08/92	149 C2.000								
Engine	Information			A10	A20	A40	A50	A70	C10 - C30	C20	E01	
All engines	version Marelli					1.330.115		1.930.177/1				
All engines	version Marelli, no specific info conc. application available						1.430.057R, 1.430.060					
ENGINE												
1.6 GT i.e.	Petrol	80	08/86-08/88	831 B7.000								
Engine	Information			A10	A20	A40	A50	A70	C10 - C30	C20	E01	
All engines	version Marelli					1.330.115		1.930.177/1				
All engines	version Marelli, no specific info conc. application available						1.430.057R, 1.430.060					
All engines	VET. 0651166 ->											1.500.398
ENGINE												
1.6 HF Turbo	Petrol	103	08/86-08/88	831 B3.000								
Engine	Information			A10	A20	A40	A50	A70	C10 - C30	C20	E01	
All engines	version Marelli					1.330.115		1.930.177/1				
All engines	->eng. 957187, version Marelli						1.430.057R					
All engines	eng. type 957187 ->, version Marelli						1.430.060					
ENGINE												
1.6 HF Turbo	Petrol	97	04/87-03/89	831 B7.046								
Engine	Information			A10	A20	A40	A50	A70	C10 - C30	C20	E01	
All engines	version Marelli					1.330.115		1.930.177/1				
All engines	->eng. 957187, version Marelli						1.430.057R					
All engines	eng. type 957187 ->, version Marelli						1.430.060					
ENGINE												
2.0 16V HF Evo Integrale	Petrol	155	06/93-01/94	831 E5.000, 831 E5.046								
Engine	Information			A10	A20	A40	A50	A70	C10 - C30	C20	E01	
Eng. 831 E5.000	version Marelli					1.330.115	1.430.060	1.930.177/1				
Eng. 831 E5.046	Qty: 2								1.970.146	C10		
Eng. 831 E5.000												1.500.471
ENGINE												
2.0 16V HF Integrale	Petrol	144	03/89-09/91	831 D5.000								
Engine	Information			A10	A20	A40	A50	A70	C10 - C30	C20	E01	
All engines	version Marelli					1.330.115	1.430.057R	1.930.177/1				
All engines									1.990.303	C30		1.500.471

A10 CONDENSER	A20 CONTACT SET	A40 DISTRIBUTOR CAP	A50 ROTOR	A70 PICK-UP
C10 COIL	C20 IGNITION MODULE	C30 ELECTRONIC IGNITION KIT	E01 IGNITION CABLE SET	

Vehicle	alim.	kW	Date	Engine	FUNCTIONS ON THE VEHICLE							
					A10	A20	A40	A50	A70	C10 - C30	C20	E01

ENGINE				
2.0 HF Integrale	Petrol	122	11/86-08/88	831 B5.000

Engine	Information	A10	A20	A40	A50	A70	C10 - C30	C20	E01
All engines	version Marelli			1.330.115	1.430.057R	1.930.177/1			

ENGINE				
2.0 HF Integrale	Petrol	130	12/86-12/92	831 C5.046

Engine	Information	A10	A20	A40	A50	A70	C10 - C30	C20	E01
All engines	version Marelli			1.330.115		1.930.177/1			
All engines	->year 30/06/91, version Marelli				1.430.057R				
All engines	01/07/91 ->, version Marelli				1.430.060				
All engines	->year 30/06/91						1.990.303	C30	1.500.471

ENGINE				
2.0 HF Integrale	Petrol	133	10/87-12/91	831 C5.000

Engine	Information	A10	A20	A40	A50	A70	C10 - C30	C20	E01
All engines	version Marelli			1.330.115	1.430.057R	1.930.177/1			

DELTA II

ENGINE				
1.4 i.e.	Petrol	51	10/94-08/99	160 A1.046, 836 A4.000

Engine	Information	A10	A20	A40	A50	A70	C10 - C30	C20	E01
Eng. 160 A1.046	version Marelli			1.330.115	1.430.059	1.930.177/1			
Eng. 160 A1.046							1.970.148	C10	
Eng. 836 A4.000							1.970.168	C10	1.500.655

ENGINE				
1.6 i.e.	Petrol	55	06/93-08/99	835 C1.000

Engine	Information	A10	A20	A40	A50	A70	C10 - C30	C20	E01
All engines							1.970.168	C10	1.500.655

ENGINE				
1.6 i.e.	Petrol	66	03/96-08/99	182 A6.000

Engine	Information	A10	A20	A40	A50	A70	C10 - C30	C20	E01
All engines							1.970.345	C10	1.501.503

ENGINE				
1.6 i.e. 16V	Petrol	76	01/96-08/99	182 A4.000

Engine	Information	A10	A20	A40	A50	A70	C10 - C30	C20	E01
All engines							1.970.345	C10	1.501.503

ENGINE				
1.8 i.e.	Petrol	66	07/94-08/99	835 C4.000, 836 A6.000, 836 C4.000

Engine	Information	A10	A20	A40	A50	A70	C10 - C30	C20	E01
All engines	Qty: 2						1.970.146	C10	
All engines	eng. type 1486839 ->								1.500.889

ENGINE				
1.8 i.e.	Petrol	74	02/96-08/99	836 A5.000

Engine	Information	A10	A20	A40	A50	A70	C10 - C30	C20	E01
All engines	Qty: 2						1.970.146	C10	
All engines	eng. type 1486839 ->								1.500.889

ENGINE				
1.8 i.e.	Petrol	76	06/93-08/99	835 C2.000

Engine	Information	A10	A20	A40	A50	A70	C10 - C30	C20	E01
All engines	Qty: 2						1.970.146	C10	
All engines	eng. type 1486839 ->								1.500.889

ENGINE				
1.8 i.e. 16V GT	Petrol	96	03/96-08/99	183 A1.000

Engine	Information	A10	A20	A40	A50	A70	C10 - C30	C20	E01
All engines	01/05/98 ->, Qty: 4						1.970.384	C10	

ENGINE				
2.0 16V	Petrol	102	06/93-08/99	836 A3.000

Engine	Information	A10	A20	A40	A50	A70	C10 - C30	C20	E01
All engines	version Marelli			1.330.114	1.430.060	1.930.177/1			
All engines							1.990.303	C30	1.500.650

A10 CONDENSER	A20 CONTACT SET	A40 DISTRIBUTOR CAP	A50 ROTOR	A70 PICK-UP
C10 COIL	C20 IGNITION MODULE	C30 ELECTRONIC IGNITION KIT	E01 IGNITION CABLE SET	

The present application list is a brief version. For the detailed information about the possibility of installation on a specific vehicle, please refer to our web-catalogue <http://catalogo.facet.eu/>

					FUNCTIONS ON THE VEHICLE							
Vehicle	alim.	kW	Date	Engine	A10	A20	A40	A50	A70	C10 - C30	C20	E01
2.0 16V Turbo												
	Petrol	137	06/93-08/99	836 A2.000								
ENGINE												
Engine	Information				A10	A20	A40	A50	A70	C10 - C30	C20	E01
All engines	Qty: 2									1.970.146	C10	
All engines												1.500.456
2.0 16V Turbo												
	Petrol	142	07/96-08/99	175 A4.000								
ENGINE												
Engine	Information				A10	A20	A40	A50	A70	C10 - C30	C20	E01
All engines	Qty: 2									1.970.146	C10	
All engines												1.500.456
DELTA III												
1.4 16V												
	Petrol	103	07/10-08/14	198 A7.000								
ENGINE												
Engine	Information				A10	A20	A40	A50	A70	C10 - C30	C20	E01
All engines	x 4, COIL ON PLUG									1.970.549	C10	
1.8												
	Petrol	147	01/09-08/14	939 B1.000								
ENGINE												
Engine	Information				A10	A20	A40	A50	A70	C10 - C30	C20	E01
All engines	x 4, COIL ON PLUG									1.970.549	C10	
KAPPA												
2.0 16V Turbo												
	Petrol	151	02/95-10/01	834 A4.000, 838 A4.000								
ENGINE												
Engine	Information				A10	A20	A40	A50	A70	C10 - C30	C20	E01
All engines	x 1, D.I.S., connector type, saw teeth									1.970.168	C10	
Eng. 834 A4.000										1.970.168	C10	
All engines												1.500.700
2.0 20V												
	Petrol	107	10/94-10/01	838 A1.000								
ENGINE												
Engine	Information				A10	A20	A40	A50	A70	C10 - C30	C20	E01
All engines	x 5, COIL ON PLUG, incl. spark plug connector									1.970.314	C10	
2.0 20V												
	Petrol	114	07/96-10/01	838 A6.000								
ENGINE												
Engine	Information				A10	A20	A40	A50	A70	C10 - C30	C20	E01
All engines	->ch. 2092439, x 5, COIL ON PLUG, incl. spark plug connector									1.970.314	C10	
2.0 20V Turbo												
	Petrol	162	06/98-10/01	175 A3.000								
ENGINE												
Engine	Information				A10	A20	A40	A50	A70	C10 - C30	C20	E01
All engines	x 5, COIL ON PLUG, incl. spark plug connector									1.970.314	C10	
2.4 20V												
	Petrol	129	08/94-10/01	838 A2.000, 838 A2.027								
ENGINE												
Engine	Information				A10	A20	A40	A50	A70	C10 - C30	C20	E01
All engines	x 5, COIL ON PLUG, incl. spark plug connector									1.970.314	C10	
3.0 24V												
	Petrol	150	10/94-10/01	838 B.000								
ENGINE												
Engine	Information				A10	A20	A40	A50	A70	C10 - C30	C20	E01
All engines	x 6, COIL ON PLUG									1.970.313	C10	
LYBRA												
1.6												
	Petrol	76	10/00-10/05	182 B6.000								
ENGINE												
Engine	Information				A10	A20	A40	A50	A70	C10 - C30	C20	E01
All engines	x 1, D.I.S., connector type, saw teeth									1.970.345	C10	
All engines												1.501.503
1.6 16V												
	Petrol	76	07/99-10/05	182 A4.000								
ENGINE												
Engine	Information				A10	A20	A40	A50	A70	C10 - C30	C20	E01
All engines	x 1, D.I.S., connector type, saw teeth									1.970.345	C10	
All engines												1.501.503

A10 CONDENSER	A20 CONTACT SET	A40 DISTRIBUTOR CAP	A50 ROTOR	A70 PICK-UP
C10 COIL	C20 IGNITION MODULE	C30 ELECTRONIC IGNITION KIT	E01 IGNITION CABLE SET	

Vehicle	alim.	kW	Date	Engine	FUNCTIONS ON THE VEHICLE									
					A10	A20	A40	A50	A70	C10 - C30	C20	E01		
ENGINE														
1.8 16V	Petrol	96	07/99-10/05	839 A4.000, 839 A7.000, 839 A9.000										
Engine	Information				A10	A20	A40	A50	A70	C10 - C30	C20	E01		
All engines	x 4, COIL ON PLUG, incl. spark plug connector									1.970.384	C10			
MUSA														
ENGINE														
1.4	Petrol	57	09/05-09/12	350 A1.000										
Engine	Information				A10	A20	A40	A50	A70	C10 - C30	C20	E01		
All engines	x 1, D.I.S.									1.970.423	C10			
All engines													1.499.170	
ENGINE														
1.4	Petrol	66	10/07-09/12	192 B2.000										
Engine	Information				A10	A20	A40	A50	A70	C10 - C30	C20	E01		
All engines	x 4, COIL ON PLUG, incl. spark plug connector									1.970.442	C10			
ENGINE														
1.4	Petrol	70	10/04-09/12	843 A 1.000										
Engine	Information				A10	A20	A40	A50	A70	C10 - C30	C20	E01		
All engines	x 4, COIL ON PLUG, incl. spark plug connector									1.970.442	C10			
ENGINE														
1.4 16V	Petrol	70	01/11-12/12	--										
Engine	Information				A10	A20	A40	A50	A70	C10 - C30	C20	E01		
All engines	Qty: 4									1.970.442	C10			
ENGINE														
1.4 8V	Petrol	57	01/11-12/12	--										
Engine	Information				A10	A20	A40	A50	A70	C10 - C30	C20	E01		
All engines										1.970.423	C10		1.499.170	
ENGINE														
1.4 LPG	Petrol/ Liquified Petro- leum Gas (LPG)	57	11/10-09/12	350 A1.000										
Engine	Information				A10	A20	A40	A50	A70	C10 - C30	C20	E01		
All engines	x 1, D.I.S.									1.970.423	C10			
PHEDRA														
ENGINE														
2.0	Petrol	100	09/02-11/10	RFN, RFN (EW10J4)										
Engine	Information				A10	A20	A40	A50	A70	C10 - C30	C20	E01		
Eng. RFN	x 4, COIL ON PLUG									1.970.408	C10			
Eng. RFN (EW10J4)										1.970.408	C10			
PRISMA														
ENGINE														
1.3	Petrol	58	01/83-12/89	831 A2.000										
Engine	Information				A10	A20	A40	A50	A70	C10 - C30	C20	E01		
All engines	version Marelli						1.330.101		1.930.176M					
All engines	->year 28/02/88, version Marelli						1.430.047R							
All engines	01/03/88 ->, version Marelli						1.430.060							
All engines											1.965.020	1.500.354		
ENGINE														
1.5	Petrol	59	05/86-07/89	831 B1.000										
Engine	Information				A10	A20	A40	A50	A70	C10 - C30	C20	E01		
All engines	version Marelli						1.330.104	1.430.055R						
All engines									1.970.103	C10				
ENGINE														
1.5	Petrol	63	01/83-04/86	831 A1.000										
Engine	Information				A10	A20	A40	A50	A70	C10 - C30	C20	E01		
All engines	version Marelli						1.330.104	1.430.047R						
ENGINE														
1.6	Petrol	71	08/87-08/88	831 B6.000										
Engine	Information				A10	A20	A40	A50	A70	C10 - C30	C20	E01		
All engines	version Marelli						1.330.098	1.430.055R						
All engines									1.970.103	C10		1.500.398		

A10 CONDENSER	A20 CONTACT SET	A40 DISTRIBUTOR CAP	A50 ROTOR	A70 PICK-UP
C10 COIL	C20 IGNITION MODULE	C30 ELECTRONIC IGNITION KIT	E01 IGNITION CABLE SET	

The present application list is a brief version. For the detailed information about the possibility of installation on a specific vehicle, please refer to our web-catalogue <http://catalogo.facet.eu/>

Vehicle	alim.	kW	Date	Engine	FUNCTIONS ON THE VEHICLE							
					A10	A20	A40	A50	A70	C10 - C30	C20	E01

ENGINE				
1.6	Petrol	73	08/86-02/92	831 B6.000

Engine	Information	A10	A20	A40	A50	A70	C10 - C30	C20	E01
All engines	version Marelli			1.330.098	1.430.055R				
All engines							1.970.103	C10	1.500.398

ENGINE				
1.6 i.e.	Petrol	80	05/86-12/89	831 B7.000

Engine	Information	A10	A20	A40	A50	A70	C10 - C30	C20	E01
All engines	version Marelli			1.330.098	1.430.057R	1.930.177/1			

ENGINE				
2.0 i.e. Trazione integrale	Petrol	85	04/86-12/89	831 B4.000

Engine	Information	A10	A20	A40	A50	A70	C10 - C30	C20	E01
All engines	version Marelli			1.330.098	1.430.057R	1.930.177/1			

THEMA

ENGINE				
2000 16V	Petrol	112	05/92-07/94	834 F1.000

Engine	Information	A10	A20	A40	A50	A70	C10 - C30	C20	E01
All engines							1.970.168	C10	1.500.700

ENGINE				
2000 16V Turbo	Petrol	133	12/88-06/90	834 C1.000

Engine	Information	A10	A20	A40	A50	A70	C10 - C30	C20	E01
All engines	Qty: 2						1.970.146	C10	
All engines									1.500.456

ENGINE				
2000 16V Turbo	Petrol	148	10/92-07/94	834 F2.000

Engine	Information	A10	A20	A40	A50	A70	C10 - C30	C20	E01
All engines							1.970.168	C10	1.500.700

ENGINE				
2000 i.e.	Petrol	86	09/88-05/92	834 B1.000

Engine	Information	A10	A20	A40	A50	A70	C10 - C30	C20	E01
All engines	version Marelli			1.330.115					
All engines	->eng. 112486, version Marelli				1.430.055R				
All engines	eng. type 112486 ->, version Marelli				1.430.059				
All engines							1.970.148	C10	1.500.398

ENGINE				
2000 i.e.	Petrol	85	09/87-05/92	834 B.146

Engine	Information	A10	A20	A40	A50	A70	C10 - C30	C20	E01
All engines	version Marelli			1.330.115					
All engines	->eng. 112486, version Marelli				1.430.055R				
All engines	eng. type 112486 ->, version Marelli				1.430.059				
All engines							1.970.148	C10	1.500.398

ENGINE				
2000 i.e. 16V	Petrol	104	02/89-05/92	834 B2.246

Engine	Information	A10	A20	A40	A50	A70	C10 - C30	C20	E01
All engines	Qty: 2						1.970.146	C10	
All engines									1.500.456

ENGINE				
2000 i.e. 16V	Petrol	108	05/88-08/92	834 B2.000

Engine	Information	A10	A20	A40	A50	A70	C10 - C30	C20	E01
All engines	Qty: 2						1.970.146	C10	
All engines									1.500.456

ENGINE				
2000 i.e. 16V Turbo	Petrol	130	04/89-03/93	834 C1.246



Engine	Information	A10	A20	A40	A50	A70	C10 - C30	C20	E01
All engines	Qty: 2						1.970.146	C10	
All engines									1.500.456

ENGINE				
2000 i.e. 16V Turbo	Petrol	133	12/88-06/90	834 C1.000

Engine	Information	A10	A20	A40	A50	A70	C10 - C30	C20	E01
All engines	Qty: 2						1.970.146	C10	
All engines									1.500.456

A10 CONDENSER	A20 CONTACT SET	A40 DISTRIBUTOR CAP	A50 ROTOR	A70 PICK-UP
C10 COIL	C20 IGNITION MODULE	C30 ELECTRONIC IGNITION KIT	E01 IGNITION CABLE SET	

Vehicle	alim.	kW	Date	Engine	FUNCTIONS ON THE VEHICLE									
					A10	A20	A40	A50	A70	C10 - C30	C20	E01		
ENGINE														
2000 i.e.Turbo	Petrol	110	07/86-05/90	834 C.146										
Engine	Information				A10	A20	A40	A50	A70	C10 - C30	C20	E01		
All engines	version Marelli						1.330.115							
All engines	->eng. 112486, version Marelli							1.430.055R						
All engines	eng. type 112486 -, version Marelli							1.430.059						
All engines										1.970.148	C10		1.500.398	
ENGINE														
2000 Turbo	Petrol	110	12/88-03/92	834 C.146										
Engine	Information				A10	A20	A40	A50	A70	C10 - C30	C20	E01		
All engines	version Marelli						1.330.115							
All engines	->eng. 112486, version Marelli							1.430.055R						
All engines	eng. type 112486 -, version Marelli							1.430.059						
All engines										1.970.148	C10		1.500.398	
ENGINE														
2000 Turbo 16V	Petrol	148	11/92-07/94	834 F2.000										
Engine	Information				A10	A20	A40	A50	A70	C10 - C30	C20	E01		
All engines										1.970.168	C10		1.500.700	
ENGINE														
2850 V6 i.e.	Petrol	108	06/88-05/92	834 E.146										
Engine	Information				A10	A20	A40	A50	A70	C10 - C30	C20	E01		
All engines	version Bosch						1.306.236	1.406.119R						
All engines										1.970.126	C10			
ENGINE														
2850 V6 i.e.	Petrol	110	11/84-09/88	834 E.000										
Engine	Information				A10	A20	A40	A50	A70	C10 - C30	C20	E01		
All engines	version Bosch							1.406.023R						
ENGINE														
8.32	Petrol	151	10/87-05/92	F 105 L.046										
Engine	Information				A10	A20	A40	A50	A70	C10 - C30	C20	E01		
All engines	Qty: 2									1.990.303	C30			
ENGINE														
8.32	Petrol	158	09/87-05/89	F 105 L										
Engine	Information				A10	A20	A40	A50	A70	C10 - C30	C20	E01		
All engines										1.970.126	C10			
All engines	Qty: 2									1.990.303	C30			
THESIS														
ENGINE														
3.0 V6	Petrol	158	07/02-07/09	841 A.000										
Engine	Information				A10	A20	A40	A50	A70	C10 - C30	C20	E01		
All engines	x 6, COIL ON PLUG									1.970.313	C10			
ENGINE														
3.2 V6	Petrol	169	05/03-07/09	841 L.000										
Engine	Information				A10	A20	A40	A50	A70	C10 - C30	C20	E01		
All engines	x 6, COIL ON PLUG									1.970.313	C10			
Y I														
ENGINE														
1.1	Petrol	40	11/95-09/03	176 B2.000										
Engine	Information				A10	A20	A40	A50	A70	C10 - C30	C20	E01		
All engines	x 1, D.I.S., connector type DIN									1.970.146	C10			
All engines													1.500.616	
ENGINE														
1.2	Petrol	44	03/96-09/03	188 A4.000, 840 A3.000										
Engine	Information				A10	A20	A40	A50	A70	C10 - C30	C20	E01		
All engines	x 1, D.I.S., connector type DIN									1.970.146	C10			
Eng. 840 A3.000													1.500.616	
Eng. 188 A4.000													1.501.451	
ENGINE														
1.2 16V	Petrol	59	10/00-09/03	188 A5.000										
Engine	Information				A10	A20	A40	A50	A70	C10 - C30	C20	E01		
All engines	x 1, D.I.S., connector type, saw teeth									1.970.168	C10			
All engines													1.501.505	
A10	CONDENSER		A20	CONTACT SET		A40	DISTRIBUTOR CAP		A50	ROTOR		A70	PICK-UP	
C10	COIL		C20	IGNITION MODULE		C30	ELECTRONIC IGNITION KIT		E01	IGNITION CABLE SET				

				FUNCTIONS ON THE VEHICLE								
Vehicle	alim.	kW	Date	Engine								
				ENGINE								
1.2 16V	Petrol	63	04/97-09/03	176 B9.000								
Engine	Information			A10	A20	A40	A50	A70	C10 - C30		C20	E01
All engines	->year 01/12/99, x 1, D.I.S., connector type DIN								1.970.146	C10		
All engines	01/01/00 ->, x 1, D.I.S., connector type, saw teeth								1.970.168	C10		
All engines												1.501.504
1.4 12V	Petrol	55	03/96-09/03	840 A4.000								
Engine	Information			A10	A20	A40	A50	A70	C10 - C30		C20	E01
All engines	x 1, D.I.S., connector type, saw teeth								1.970.168	C10		
All engines												1.501.363
1.4 12V	Petrol	59	10/96-09/03	840 A2.000								
Engine	Information			A10	A20	A40	A50	A70	C10 - C30		C20	E01
All engines	x 1, D.I.S., connector type, saw teeth								1.970.168	C10		
All engines												1.501.363
Y10				ENGINE								
1.0 Fire	Petrol	32	06/85-06/91	156 A2.100								
Engine	Information			A10	A20	A40	A50	A70	C10 - C30		C20	E01
All engines	version Marelli					1.330.109	1.430.060	1.930.180M				
All engines									1.970.108	C10	1.965.020	1.500.347
1.0 Fire Catalytic-Conv	Petrol	33	10/87-02/92	156 A2.246								
Engine	Information			A10	A20	A40	A50	A70	C10 - C30		C20	E01
All engines	version Marelli					1.330.109	1.430.060	1.930.180M				
All engines									1.970.108	C10	1.965.020	1.500.347
1.0 Fire Trazione integrale	Petrol	32	12/86-02/89	156 A2.100								
Engine	Information			A10	A20	A40	A50	A70	C10 - C30		C20	E01
All engines	version Ducellier					1.315.080	1.415.094					
All engines	version Marelli					1.330.109	1.430.060	1.930.180M				
All engines									1.970.108	C10	1.965.020	1.500.347
1.0 Fire Trazione integrale	Petrol	33	12/87-02/92	156 A2.246								
Engine	Information			A10	A20	A40	A50	A70	C10 - C30		C20	E01
All engines	version Ducellier					1.315.080	1.415.094					
All engines	version Marelli					1.330.109	1.430.060	1.930.180M				
All engines									1.970.108	C10	1.965.020	
1.0 Fire Trazione integrale	Petrol	37	12/87-02/90	156 A2.000								
Engine	Information			A10	A20	A40	A50	A70	C10 - C30		C20	E01
All engines	version Ducellier					1.315.080	1.415.094				1.965.029	
All engines	version Marelli					1.330.109	1.430.060	1.930.180M			1.965.020	
All engines									1.970.108	C10		1.500.347
1.1 Fire	Petrol	40	01/95-12/95	176 B2.000								
Engine	Information			A10	A20	A40	A50	A70	C10 - C30		C20	E01
All engines									1.970.168	C10		1.500.694
1.1 Fire Trazione integrale	Petrol	40	01/95-12/95	176 B2.000								
Engine	Information			A10	A20	A40	A50	A70	C10 - C30		C20	E01
All engines									1.970.168	C10		1.500.694
1.1 i.e Fire	Petrol	42	08/89-06/92	156 C.000								
Engine	Information			A10	A20	A40	A50	A70	C10 - C30		C20	E01
All engines	version Ducellier					1.315.080	1.415.094				1.965.029	
All engines	version Marelli					1.330.109	1.430.060	1.930.180M			1.965.020	

A10 CONDENSER	A20 CONTACT SET	A40 DISTRIBUTOR CAP	A50 ROTOR	A70 PICK-UP
C10 COIL	C20 IGNITION MODULE	C30 ELECTRONIC IGNITION KIT	E01 IGNITION CABLE SET	

Vehicle	alim.	kW	Date	Engine	FUNCTIONS ON THE VEHICLE							
					A10	A20	A40	A50	A70	C10 - C30	C20	E01
ENGINE												
1.1 i.e Fire	Petrol	42	08/89-06/92	156 C.000								
Engine	Information				A10	A20	A40	A50	A70	C10 - C30	C20	E01
All engines										1.970.108	C10	1.500.347
ENGINE												
1.1 i.e Fire Trazione integrale	Petrol	42	08/89-06/92	156 C.000								
Engine	Information				A10	A20	A40	A50	A70	C10 - C30	C20	E01
All engines	version Ducellier						1.315.080	1.415.094			1.965.029	
All engines	version Marelli						1.330.109	1.430.060	1.930.180M		1.965.020	
All engines										1.970.108	C10	
ENGINE												
1.1 i.e. Fire	Petrol	37	07/89-09/95	156 C.046								
Engine	Information				A10	A20	A40	A50	A70	C10 - C30	C20	E01
All engines	version Marelli						1.330.109	1.430.060	1.930.180M			
All engines										1.970.108	C10	1.965.020
All engines												1.500.347
ENGINE												
1.1 i.e. Fire Trazione integrale	Petrol	37	09/92-12/95	156 C.046								
Engine	Information				A10	A20	A40	A50	A70	C10 - C30	C20	E01
All engines										1.970.168	C10	1.500.694
ENGINE												
1.3 i.e.	Petrol	53	02/89-12/95	146 A 5.046, 156 B.000								
Engine	Information				A10	A20	A40	A50	A70	C10 - C30	C20	E01
All engines	version Marelli						1.330.101					
All engines	version Marelli, version Marelli							1.430.055R				
All engines										1.970.148	C10	
ENGINE												
1.3 i.e.	Petrol	56	11/87-05/93	156 B.000								
Engine	Information				A10	A20	A40	A50	A70	C10 - C30	C20	E01
All engines	version Marelli						1.330.101	1.430.055R				
All engines										1.970.148	C10	
YPSILON II												
ENGINE												
1.2	Petrol	44	10/03-12/11	188 A4.000								
Engine	Information				A10	A20	A40	A50	A70	C10 - C30	C20	E01
All engines	euro 4 (D4), x 1, D.I.S., connector type DIN									1.970.146	C10	
All engines	euro 5, x 1, D.I.S.									1.970.423	C10	
All engines												1.501.451
ENGINE												
1.2	Petrol	51	08/10-12/11	169 A4.000								
Engine	Information				A10	A20	A40	A50	A70	C10 - C30	C20	E01
All engines	euro 4 (D4), x 1, D.I.S., connector type DIN									1.970.146	C10	
All engines	euro 5, x 1, D.I.S.									1.970.423	C10	
All engines												1.501.451
ENGINE												
1.2	Petrol	59	10/03-12/11	188 A5.000								
Engine	Information				A10	A20	A40	A50	A70	C10 - C30	C20	E01
All engines	x 4, COIL ON PLUG, incl. spark plug connector									1.970.442	C10	
ENGINE												
1.4	Petrol	57	02/06-12/11	350 A1.000								
Engine	Information				A10	A20	A40	A50	A70	C10 - C30	C20	E01
All engines	x 1, D.I.S.									1.970.423	C10	
All engines												1.499.170
ENGINE												
1.4 16V	Petrol	70	10/03-12/11	843 A 1.000								
Engine	Information				A10	A20	A40	A50	A70	C10 - C30	C20	E01
All engines	x 4, COIL ON PLUG, incl. spark plug connector									1.970.442	C10	

A10	CONDENSER	A20	CONTACT SET	A40	DISTRIBUTOR CAP	A50	ROTOR	A70	PICK-UP
C10	COIL	C20	IGNITION MODULE	C30	ELECTRONIC IGNITION KIT	E01	IGNITION CABLE SET		

The present application list is a brief version. For the detailed information about the possibility of installation on a specific vehicle, please refer to our web-catalogue <http://catalogo.facet.eu/>

Vehicle	alim.	kW	Date	Engine	FUNCTIONS ON THE VEHICLE							
					A10	A20	A40	A50	A70	C10 - C30	C20	E01

ENGINE				
1.4 LPG	Petrol/ Liquified Petro- leum Gas (LPG)	57	11/10-12/11	350 A1.000

Engine	Information	A10	A20	A40	A50	A70	C10 - C30	C20	E01
All engines	x 1, D.I.S.						1.970.423	C10	
All engines									1.499.170

YPSILON III				
ENGINE				
1.2	Petrol	51	05/11->	169 A4.000

Engine	Information	A10	A20	A40	A50	A70	C10 - C30	C20	E01
All engines	x 1, D.I.S.						1.970.423	C10	
All engines									1.499.170

ENGINE				
1.2 Bi-fuel	Petrol/ Liquified Petro- leum Gas (LPG)	49	05/11->	169 A4.000

Engine	Information	A10	A20	A40	A50	A70	C10 - C30	C20	E01
All engines	x 1, D.I.S.						1.970.423	C10	
All engines									1.499.170

ENGINE				
1.2 Bi-fuel	Petrol/ Liquified Petro- leum Gas (LPG)	51	05/11->	169 A4.000

Engine	Information	A10	A20	A40	A50	A70	C10 - C30	C20	E01
All engines	x 1, D.I.S.						1.970.423	C10	
All engines									1.499.170

ZETA				
ENGINE				
2.0 Turbo	Petrol	108	05/95-09/02	RGX (XU10J2TE)

Engine	Information	A10	A20	A40	A50	A70	C10 - C30	C20	E01
All engines							1.970.188	C10	

A10 CONDENSER	A20 CONTACT SET	A40 DISTRIBUTOR CAP	A50 ROTOR	A70 PICK-UP
C10 COIL	C20 IGNITION MODULE	C30 ELECTRONIC IGNITION KIT	E01 IGNITION CABLE SET	

Vehicle	alim.	kW	Date	Engine	FUNCTIONS ON THE VEHICLE									
					A10	A20	A40	A50	A70	C10 - C30	C20	E01		
110/127														
2.5 4x4	Petrol	61	10/85-07/90	17 H										
Engine	Information				A10	A20	A40	A50	A70	C10 - C30	C20	E01		
All engines	version Duellier				1.115.034		1.315.054	1.415.091						
All engines	version Lucas					1.228.089	1.328.078	1.428.012						
All engines										1.970.101D	C10			
88/109														
2.3 4x4	Petrol	51	09/61-12/86	10 H, 11H										
Engine	Information				A10	A20	A40	A50	A70	C10 - C30	C20	E01		
All engines						1.228.083MHV	1.328.070, 1.328.075	1.428.006						
90														
2.5 4x4	Petrol	62	09/85-08/90	17 H										
Engine	Information				A10	A20	A40	A50	A70	C10 - C30	C20	E01		
All engines	version Duellier				1.115.034		1.315.054	1.415.091						
All engines	version Lucas					1.228.089	1.328.078	1.428.012						
All engines										1.970.101D	C10			
DEFENDER														
3.5 4x4	Petrol	100	09/90-12/98	15G, 21 G, 22 D										
Engine	Information				A10	A20	A40	A50	A70	C10 - C30	C20	E01		
All engines	version Lucas						1.328.091	1.428.021, 1.428.022						
DISCOVERY I														
3.5 4x4	Petrol	113	06/89-06/94	22 D										
Engine	Information				A10	A20	A40	A50	A70	C10 - C30	C20	E01		
All engines	version Lucas						1.328.091	1.428.022						
DISCOVERY II														
4.0 4x4	Petrol	134	09/93-10/98	35 D, 36 D										
Engine	Information				A10	A20	A40	A50	A70	C10 - C30	C20	E01		
All engines	-> ch. SA163099, SA501919, version Lucas						1.328.091	1.428.022						
DISCOVERY II														
4.0 V8 4x4	Petrol	136	11/98-06/04	35 D, 56 D, 94 D										
Engine	Information				A10	A20	A40	A50	A70	C10 - C30	C20	E01		
Eng. 35 D, 94 D	Qty: 2									1.970.168	C10			
Eng. 56 D	x 1, D.I.S.									1.970.168	C10			
All engines													1.499.107	
4.6 V8 [USA]														
4.6 V8 [USA]	Petrol	162	01/03-06/04	--										
Engine	Information				A10	A20	A40	A50	A70	C10 - C30	C20	E01		
All engines	Qty: 2									1.970.168	C10			
All engines													1.499.107	
FREELANDER														
1.8 16V 4x4	Petrol	86	04/98-10/06	18 K4F										
Engine	Information				A10	A20	A40	A50	A70	C10 - C30	C20	E01		
All engines	-> ch. YA999999, version Lucas						1.328.093	1.428.029R						
All engines	ch. 1A000001 ->, x 1, DISTRIBUTOR									1.970.374	C10			
All engines	ch. 1A000001 ->												1.501.889	
All engines	-> ch. YA999999												1.501.900	
1.8 4x4														
1.8 4x4	Petrol	86	10/00-10/06	18 K4F										
Engine	Information				A10	A20	A40	A50	A70	C10 - C30	C20	E01		
All engines	ch. 1A000001 ->, x 1, DISTRIBUTOR									1.970.374	C10			
1.8 i 16V 4x4														
1.8 i 16V 4x4	Petrol	88	02/98-10/06	18 K4F										
Engine	Information				A10	A20	A40	A50	A70	C10 - C30	C20	E01		
All engines	-> ch. YA999999, version Lucas						1.328.093	1.428.029R						

A10 CONDENSER	A20 CONTACT SET	A40 DISTRIBUTOR CAP	A50 ROTOR	A70 PICK-UP
C10 COIL	C20 IGNITION MODULE	C30 ELECTRONIC IGNITION KIT	E01 IGNITION CABLE SET	









The present application list is a brief version. For the detailed information about the possibility of installation on a specific vehicle, please refer to our web-catalogue <http://catalogo.facet.eu/>

Vehicle	alim.	kW	Date	Engine	FUNCTIONS ON THE VEHICLE												
					A10	A20	A40	A50	A70	C10 - C30	C20	E01					
ENGINE																	
1.8 i 16V 4x4	Petrol	88	02/98-10/06	18 K4F													
Engine	Information				A10	A20	A40	A50	A70	C10 - C30	C20	E01					
All engines	ch. 1A000001 ->, x 1, DISTRIBUTOR									1.970.374	C10						
All engines	ch. 1A000001 ->													1.501.889			
All engines	->ch. YA999999													1.501.900			
ENGINE																	
2.5 V6 4x4	Petrol	130	11/00-10/06	25KV6													
Engine	Information				A10	A20	A40	A50	A70	C10 - C30	C20	E01					
All engines	->ch. 3A224999, x 1, D.I.S.									1.970.352	C10						
All engines	->ch. 3A224999, x 6, COIL ON PLUG									1.970.413	C10						
RANGE ROVER I																	
ENGINE																	
3.5 4x4	Petrol	107	01/87-09/90	31 D													
Engine	Information				A10	A20	A40	A50	A70	C10 - C30	C20	E01					
All engines	version Lucas						1.328.091	1.428.022									
ENGINE																	
3.5 Vogue 4x4	Petrol	120	10/85-09/90	24 D, 25 D													
Engine	Information				A10	A20	A40	A50	A70	C10 - C30	C20	E01					
All engines	version Lucas						1.328.091	1.428.022									
ENGINE																	
3.5 Vogue 4x4	Petrol	93	08/81-09/90	11 D													
Engine	Information				A10	A20	A40	A50	A70	C10 - C30	C20	E01					
All engines	version Lucas						1.328.091										
ENGINE																	
3.9 4x4	Petrol	134	11/88-12/92	35 D													
Engine	Information				A10	A20	A40	A50	A70	C10 - C30	C20	E01					
All engines	version Lucas						1.328.091	1.428.022									
ENGINE																	
3.9 Cat 4x4	Petrol	127	11/88-07/94	37 D, 38 D													
Engine	Information				A10	A20	A40	A50	A70	C10 - C30	C20	E01					
All engines	version Lucas						1.328.091	1.428.022									
ENGINE																	
3.9 Vogue SEI 4x4	Petrol	134	11/88-07/94	35 D, 36 D													
Engine	Information				A10	A20	A40	A50	A70	C10 - C30	C20	E01					
All engines	version Lucas						1.328.091	1.428.022									
ENGINE																	
4.3 Vogue LSE 4x4	Petrol	149	09/92-07/94	40 D													
Engine	Information				A10	A20	A40	A50	A70	C10 - C30	C20	E01					
All engines	version Lucas						1.328.091	1.428.022									
RANGE ROVER II																	
ENGINE																	
3.9 4x4	Petrol	140	07/94-03/02	42 D													
Engine	Information				A10	A20	A40	A50	A70	C10 - C30	C20	E01					
All engines	ch. XA410482 ->, x 1, D.I.S.									1.970.168	C10						
All engines	ch. XA410482 ->													1.499.107			
ENGINE																	
4.0 4x4	Petrol	136	01/95-03/02	42 D, 46698710													
Engine	Information				A10	A20	A40	A50	A70	C10 - C30	C20	E01					
Eng. 42 D	ch. XA410482 ->, Qty: 2									1.970.168	C10						
Eng. 46698710	ch. XA410482 ->, x 1, D.I.S.									1.970.168	C10						
Eng. 42 D	ch. XA410482 ->													1.499.107			
ENGINE																	
4.6 4x4	Petrol	160	06/98-03/02	60 D													
Engine	Information				A10	A20	A40	A50	A70	C10 - C30	C20	E01					
All engines	ch. XA410482 ->, x 1, D.I.S.									1.970.168	C10						
ENGINE																	
4.6 4x4	Petrol	165	07/94-03/02	46 D, 48 D, 60 D													
Engine	Information				A10	A20	A40	A50	A70	C10 - C30	C20	E01					
Eng. 46 D	ch. XA410482 ->, Qty: 2									1.970.168	C10						
Eng. 48 D, 60 D	ch. XA410482 ->, x 1, D.I.S.									1.970.168	C10						
FUNCTIONS ON THE VEHICLE																	
A10	CONDENSER	A20	CONTACT SET	A40	DISTRIBUTOR CAP	A50	ROTOR	A70	PICK-UP	C10	COIL	C20	IGNITION MODULE	C30	ELECTRONIC IGNITION KIT	E01	IGNITION CABLE SET

Vehicle	alim.	kW	Date	Engine	FUNCTIONS ON THE VEHICLE									
					A10	A20	A40	A50	A70	C10 - C30	C20	E01		
ENGINE														
4.6 4x4	Petrol	165	07/94-03/02	46 D, 48 D, 60 D										
Engine	Information				A10	A20	A40	A50	A70	C10 - C30	C20	E01		
Eng. 46 D	ch. XA410482 ->												1.499.107	
ENGINE														
4.6 4x4	Petrol	168	09/95-03/02	46 D										
Engine	Information				A10	A20	A40	A50	A70	C10 - C30	C20	E01		
All engines	ch. XA410482 ->, Qty: 2									1.970.168	C10			
All engines	ch. XA410482 ->												1.499.107	
RANGE ROVER III														
ENGINE														
4.4 4x4	Petrol	210	03/02-08/05	44SDEX, M62 B44										
Engine	Information				A10	A20	A40	A50	A70	C10 - C30	C20	E01		
Eng. 44SDEX	x 8, COIL ON PLUG									1.970.352	C10			
Eng. M62 B44	Qty: 8									1.970.352	C10			
ENGINE														
4.4 4x4	Petrol	220	08/04-08/12	448PN										
Engine	Information				A10	A20	A40	A50	A70	C10 - C30	C20	E01		
All engines	x 8, COIL ON PLUG									1.970.352	C10			

A10	CONDENSER	A20	CONTACT SET	A40	DISTRIBUTOR CAP	A50	ROTOR	A70	PICK-UP
C10	COIL	C20	IGNITION MODULE	C30	ELECTRONIC IGNITION KIT	E01	IGNITION CABLE SET		









The present application list is a brief version. For the detailed information about the possibility of installation on a specific vehicle, please refer to our web-catalogue <http://catalogo.facet.eu/>

					FUNCTIONS ON THE VEHICLE									
Vehicle	alim.	kW	Date	Engine										
CT														
200h	Petrol/ Electric	100	09/11->	2ZR-FXE										
ENGINE														
Engine		Information			A10	A20	A40	A50	A70	C10 - C30	C20	E01		
All engines		CT 200h, x 4, COIL ON PLUG								1.970.536	C10			
200h	Petrol/ Electric	73	12/10->	2ZR-FXE										
ENGINE														
Engine		Information			A10	A20	A40	A50	A70	C10 - C30	C20	E01		
All engines		CT 200h, x 4, COIL ON PLUG								1.970.536	C10			
ES														
200	Petrol	110	08/15->	6AR-FSE										
ENGINE														
Engine		Information			A10	A20	A40	A50	A70	C10 - C30	C20	E01		
All engines		ES 200, x 4, COIL ON PLUG, FOR: (J)								1.970.537	C10			
250	Petrol	118	12/89-12/91	2VZ-FE										
ENGINE														
Engine		Information			A10	A20	A40	A50	A70	C10 - C30	C20	E01		
All engines										1.970.202	C10			
250	Petrol	135	06/12-06/18	2AR-FE										
ENGINE														
Engine		Information			A10	A20	A40	A50	A70	C10 - C30	C20	E01		
All engines		ES 250, x 4, COIL ON PLUG, FOR: (J)								1.970.537	C10			
3.5	Petrol	204	05/06-06/12	2GR-FE										
ENGINE														
Engine		Information			A10	A20	A40	A50	A70	C10 - C30	C20	E01		
All engines		ES 350, x 6, COIL ON PLUG								1.970.538	C10			
300h	Petrol/ Electric	118	06/12-06/18	2AR-FXE										
ENGINE														
Engine		Information			A10	A20	A40	A50	A70	C10 - C30	C20	E01		
All engines		ES 300h, x 4, COIL ON PLUG, FOR: (J)								1.970.537	C10			
350	Petrol	183	06/12-06/18	2GR-FE										
ENGINE														
Engine		Information			A10	A20	A40	A50	A70	C10 - C30	C20	E01		
All engines		ES 350, x 6, COIL ON PLUG								1.970.538	C10			
350	Petrol	204	06/12-06/18	2GR-FE										
ENGINE														
Engine		Information			A10	A20	A40	A50	A70	C10 - C30	C20	E01		
All engines		ES 350, x 6, COIL ON PLUG								1.970.538	C10			
GS														
250	Petrol	154	01/12->	4GR-FSE										
ENGINE														
Engine		Information			A10	A20	A40	A50	A70	C10 - C30	C20	E01		
All engines		GS 250, x 6, COIL ON PLUG, FOR: (J)								1.970.537	C10			
3.5 450h	Petrol/ Electric	213	03/12-09/18	2GR-FXE										
ENGINE														
Engine		Information			A10	A20	A40	A50	A70	C10 - C30	C20	E01		
All engines		GS 450h, x 6, COIL ON PLUG, FOR: (J)								1.970.537	C10			
3.5 VVTi	Petrol	223	04/05-12/12	2GR-FSE										
ENGINE														
Engine		Information			A10	A20	A40	A50	A70	C10 - C30	C20	E01		
All engines		GS 350, x 6, COIL ON PLUG, FOR: (J)								1.970.537	C10			
300	Petrol	156	01/93-08/97	2JZ-GE										
ENGINE														
Engine		Information			A10	A20	A40	A50	A70	C10 - C30	C20	E01		
All engines										1.970.203	C10			
300	Petrol	170	04/05-11/11	3GR-FE										
ENGINE														
Engine		Information			A10	A20	A40	A50	A70	C10 - C30	C20	E01		
All engines		GS 300, x 6, COIL ON PLUG, FOR: (J)								1.970.537	C10			
A10	CONDENSER		A20	CONTACT SET		A40	DISTRIBUTOR CAP		A50	ROTOR		A70	PICK-UP	
C10	COIL		C20	IGNITION MODULE		C30	ELECTRONIC IGNITION KIT		E01	IGNITION CABLE SET				

Vehicle	alim.	kW	Date	Engine	FUNCTIONS ON THE VEHICLE									
					A10	A20	A40	A50	A70	C10 - C30	C20	E01		
ENGINE														
300	Petrol	183	04/05-11/11	3GR-FSE										
Engine Information					A10	A20	A40	A50	A70	C10 - C30	C20	E01		
All engines										1.970.537	C10			
ENGINE														
300h	Petrol/ Electric	133	10/13->	2AR-FSE										
Engine Information					A10	A20	A40	A50	A70	C10 - C30	C20	E01		
All engines										1.970.537	C10			
ENGINE														
350	Petrol	226	09/06-11/11	2GR-FSE										
Engine Information					A10	A20	A40	A50	A70	C10 - C30	C20	E01		
All engines										1.970.537	C10			
ENGINE														
350	Petrol	233	03/12->	2GR-FSE										
Engine Information					A10	A20	A40	A50	A70	C10 - C30	C20	E01		
All engines										1.970.537	C10			
ENGINE														
350	Petrol	234	01/12->	2GR-FSE										
Engine Information					A10	A20	A40	A50	A70	C10 - C30	C20	E01		
All engines										1.970.537	C10			
ENGINE														
350 AWD	Petrol	226	09/06-11/11	2GR-FSE										
Engine Information					A10	A20	A40	A50	A70	C10 - C30	C20	E01		
All engines										1.970.537	C10			
ENGINE														
350 AWD	Petrol	232	05/08-11/11	2GR-FSE										
Engine Information					A10	A20	A40	A50	A70	C10 - C30	C20	E01		
All engines										1.970.537	C10			
ENGINE														
350 AWD	Petrol	233	03/12->	2GR-FSE										
Engine Information					A10	A20	A40	A50	A70	C10 - C30	C20	E01		
All engines										1.970.537	C10			
ENGINE														
350 AWD	Petrol	234	12/11->	2GR-FKS, 2GR-FSE										
Engine Information					A10	A20	A40	A50	A70	C10 - C30	C20	E01		
All engines										1.970.537	C10			
ENGINE														
450h	Petrol/ Electric	215	01/12->	2GR-FXE										
Engine Information					A10	A20	A40	A50	A70	C10 - C30	C20	E01		
All engines										1.970.537	C10			
ENGINE														
450h	Petrol/ Electric	218	02/06-11/11	2GR-FSE										
Engine Information					A10	A20	A40	A50	A70	C10 - C30	C20	E01		
All engines										1.970.537	C10			
ENGINE														
450h	Petrol/ Electric	254	02/06-09/18	2GR-FSE, 2GR-FXE										
Engine Information					A10	A20	A40	A50	A70	C10 - C30	C20	E01		
All engines										1.970.537	C10			
ENGINE														
F	Petrol	351	09/15->	2UR-GSE										
Engine Information					A10	A20	A40	A50	A70	C10 - C30	C20	E01		
All engines										1.970.458	C10			
ENGINE														
GX														
460 4WD	Petrol	218	01/10->	1UR-FE										
Engine Information					A10	A20	A40	A50	A70	C10 - C30	C20	E01		
All engines										1.970.537	C10			

A10	CONDENSER	A20	CONTACT SET	A40	DISTRIBUTOR CAP	A50	ROTOR	A70	PICK-UP
C10	COIL	C20	IGNITION MODULE	C30	ELECTRONIC IGNITION KIT	E01	IGNITION CABLE SET		

The present application list is a brief version. For the detailed information about the possibility of installation on a specific vehicle, please refer to our web-catalogue <http://catalogo.facet.eu/>









					FUNCTIONS ON THE VEHICLE							
Vehicle	alim.	kW	Date	Engine								
460 4WD												
ENGINE												
Petrol 225 01/10-> 1UR-FE												
Engine	Information				A10	A20	A40	A50	A70	C10 - C30	C20	E01
All engines	GX 460, x 8, COIL ON PLUG, FOR: (J)									1.970.537	C10	
HS												
ENGINE												
250h Petrol/Electric 110 07/09-01/18 2AZ-FXE												
Engine	Information				A10	A20	A40	A50	A70	C10 - C30	C20	E01
All engines	HS 250h, x 4, COIL ON PLUG, FOR: (J)									1.970.466	C10	
IS II												
ENGINE												
250 Petrol 153 08/05-06/15 4GR-FSE												
Engine	Information				A10	A20	A40	A50	A70	C10 - C30	C20	E01
All engines	IS 250, IS 250 C, x 6, COIL ON PLUG, FOR: (J)									1.970.537	C10	
ENGINE												
250 Petrol 157 08/10-> 4GR-FSE												
Engine	Information				A10	A20	A40	A50	A70	C10 - C30	C20	E01
All engines	Qty: 6									1.970.537	C10	
ENGINE												
250 Petrol 158 11/10-03/13 4GR-FSE												
Engine	Information				A10	A20	A40	A50	A70	C10 - C30	C20	E01
All engines	Qty: 6									1.970.537	C10	
ENGINE												
250 AWD Petrol 153 10/05-03/13 4GR-FSE												
Engine	Information				A10	A20	A40	A50	A70	C10 - C30	C20	E01
All engines	IS 250, x 6, COIL ON PLUG, FOR: (J)									1.970.537	C10	
ENGINE												
250 AWD Petrol 158 11/10-03/13 4GR-FSE												
Engine	Information				A10	A20	A40	A50	A70	C10 - C30	C20	E01
All engines	Qty: 6									1.970.537	C10	
ENGINE												
350 Petrol 228 04/09-> 2GR-FSE												
Engine	Information				A10	A20	A40	A50	A70	C10 - C30	C20	E01
All engines	Qty: 6									1.970.537	C10	
ENGINE												
350 Petrol 234 01/08-> 2GR-FSE												
Engine	Information				A10	A20	A40	A50	A70	C10 - C30	C20	E01
All engines	Qty: 6									1.970.537	C10	
IS III												
ENGINE												
250 Petrol 153 04/13-> 4GR-FSE												
Engine	Information				A10	A20	A40	A50	A70	C10 - C30	C20	E01
All engines	IS 250, x 6, COIL ON PLUG, FOR: (J)									1.970.537	C10	
ENGINE												
300h Petrol/Electric 131 04/13-> 2AR-FSE												
Engine	Information				A10	A20	A40	A50	A70	C10 - C30	C20	E01
All engines	IS 300h, x 4, COIL ON PLUG, FOR: (J)									1.970.537	C10	
ENGINE												
300h Petrol/Electric 133 04/13-> 2AR-FSE												
Engine	Information				A10	A20	A40	A50	A70	C10 - C30	C20	E01
All engines	IS 300h, x 4, COIL ON PLUG, FOR: (J)									1.970.537	C10	
LC												
ENGINE												
500 Petrol 341 11/18-> 2UR-GSE												
Engine	Information				A10	A20	A40	A50	A70	C10 - C30	C20	E01
All engines	LC 500, x 8, COIL ON PLUG, FOR: (J)									1.970.458	C10	

A10 CONDENSER	A20 CONTACT SET	A40 DISTRIBUTOR CAP	A50 ROTOR	A70 PICK-UP
C10 COIL	C20 IGNITION MODULE	C30 ELECTRONIC IGNITION KIT	E01 IGNITION CABLE SET	

Vehicle	alim.	kW	Date	Engine	FUNCTIONS ON THE VEHICLE									
					A10	A20	A40	A50	A70	C10 - C30	C20	E01		
ENGINE														
500	Petrol	351	11/16->	2UR-GSE										
Engine		Information			A10	A20	A40	A50	A70	C10 - C30	C20	E01		
All engines		LC 500, x 8, COIL ON PLUG, FOR: (J)								1.970.458	C10			
LS I														
400	Petrol	180	12/89-12/95	1UZ-FE										
Engine		Information			A10	A20	A40	A50	A70	C10 - C30	C20	E01		
All engines		Qty: 2								1.970.203	C10			
LS II														
400	Petrol	194	12/94-08/97	1UZ-FE										
Engine		Information			A10	A20	A40	A50	A70	C10 - C30	C20	E01		
All engines		LS 400, x 1, DISTRIBUTOR								1.970.203	C10			
LS IV														
460	Petrol	255	08/06->	1UR-FE										
Engine		Information			A10	A20	A40	A50	A70	C10 - C30	C20	E01		
All engines		LS 460, x 8, COIL ON PLUG, FOR: (J)								1.970.537	C10			
460	Petrol	280	04/06->	1UR-FE - E4, 1UR-FE - E5, 1UR-FSE, 1UR-FSE - E4, 1UR-FSE - E5										
Engine		Information			A10	A20	A40	A50	A70	C10 - C30	C20	E01		
Eng. 1UR-FE - E4, 1UR-FE - E5, 1UR-FSE - E4, 1UR-FSE - E5		Qty: 6								1.970.537	C10			
Eng. 1UR-FSE		LS 460, x 8, COIL ON PLUG, FOR: (J)								1.970.537	C10			
460	Petrol	285	09/12->	1UR-FSE										
Engine		Information			A10	A20	A40	A50	A70	C10 - C30	C20	E01		
All engines		LS 460, x 8, COIL ON PLUG, FOR: (J)								1.970.537	C10			
460 4WD	Petrol	280	08/06->	1UR-FSE										
Engine		Information			A10	A20	A40	A50	A70	C10 - C30	C20	E01		
All engines		LS 460, x 8, COIL ON PLUG, FOR: (J)								1.970.537	C10			
460 AWD	Petrol	270	12/08->	1UR-FE - E4, 1UR-FSE										
Engine		Information			A10	A20	A40	A50	A70	C10 - C30	C20	E01		
Eng. 1UR-FE - E4		Qty: 8								1.970.537	C10			
Eng. 1UR-FSE		LS 460, x 8, COIL ON PLUG, FOR: (J)								1.970.537	C10			
460 AWD	Petrol	272	09/12->	1UR-FSE										
Engine		Information			A10	A20	A40	A50	A70	C10 - C30	C20	E01		
All engines		LS 460, x 8, COIL ON PLUG, FOR: (J)								1.970.537	C10			
460 AWD	Petrol	283	10/09->	1UR-FSE										
Engine		Information			A10	A20	A40	A50	A70	C10 - C30	C20	E01		
All engines		LS 460, x 8, COIL ON PLUG, FOR: (J)								1.970.537	C10			
600h AWD	Petrol/ Electric	272	07/12-07/17	2UR-FSE										
Engine		Information			A10	A20	A40	A50	A70	C10 - C30	C20	E01		
All engines		LS 600h, x 8, COIL ON PLUG, FOR: (J)								1.970.537	C10			
600h AWD	Petrol/ Electric	290	04/07->	2UR-FSE, 2URFSE - E4, 2UR-FSE - E5										
Engine		Information			A10	A20	A40	A50	A70	C10 - C30	C20	E01		
Eng. 2UR-FSE		LS 600h, x 8, COIL ON PLUG, FOR: (J)								1.970.537	C10			
Eng. 2URFSE - E4, 2UR-FSE - E5		Qty: 6								1.970.537	C10			

A10	CONDENSER	A20	CONTACT SET	A40	DISTRIBUTOR CAP	A50	ROTOR	A70	PICK-UP
C10	COIL	C20	IGNITION MODULE	C30	ELECTRONIC IGNITION KIT	E01	IGNITION CABLE SET		

The present application list is a brief version. For the detailed information about the possibility of installation on a specific vehicle, please refer to our web-catalogue <http://catalogo.facet.eu/>

					FUNCTIONS ON THE VEHICLE							
Vehicle	alim.	kW	Date	Engine	 A10	 A20	 A40	 A50	 A70	 C10 - C30	 C20	 E01
600h AWD												
	Petrol/ Electric	327	09/07->	ENGINE 2UR-FSE								
Engine	Information				A10	A20	A40	A50	A70	C10 - C30	C20	E01
All engines	LS 600h, x 8, COIL ON PLUG, FOR: (J)									1.970.537	C10	
LX												
570												
	Petrol	270	11/07->	ENGINE 3UR-FE								
Engine	Information				A10	A20	A40	A50	A70	C10 - C30	C20	E01
All engines	LX 570, x 8, COIL ON PLUG, FOR: (J)									1.970.537	C10	
570												
	Petrol	282	11/07->	ENGINE 3UR-FE								
Engine	Information				A10	A20	A40	A50	A70	C10 - C30	C20	E01
All engines	LX 570, x 8, COIL ON PLUG, FOR: (J)									1.970.537	C10	
570												
	Petrol	285	08/07->	ENGINE 3UR-FE								
Engine	Information				A10	A20	A40	A50	A70	C10 - C30	C20	E01
All engines	LX 570, x 8, COIL ON PLUG, FOR: (J)									1.970.537	C10	
NX												
200												
	Petrol	110	11/14->	ENGINE 3ZR-FAE								
Engine	Information				A10	A20	A40	A50	A70	C10 - C30	C20	E01
All engines	NX 200, x 4, COIL ON PLUG									1.970.536	C10	
200 AWD												
	Petrol	110	11/14->	ENGINE 3ZR-FAE								
Engine	Information				A10	A20	A40	A50	A70	C10 - C30	C20	E01
All engines	NX 200, x 4, COIL ON PLUG									1.970.536	C10	
300h												
	Petrol/ Electric	114	07/14->	ENGINE 2AR-FXE								
Engine	Information				A10	A20	A40	A50	A70	C10 - C30	C20	E01
All engines	NX 300h, x 4, COIL ON PLUG, FOR: (J)									1.970.537	C10	
300h												
	Petrol/ Electric	145	11/14->	ENGINE 2AR-FXE								
Engine	Information				A10	A20	A40	A50	A70	C10 - C30	C20	E01
All engines	NX 300h, x 4, COIL ON PLUG, FOR: (J)									1.970.537	C10	
300h AWD												
	Petrol/ Electric	114	07/14->	ENGINE 2AR-FXE								
Engine	Information				A10	A20	A40	A50	A70	C10 - C30	C20	E01
All engines	NX 300h, x 4, COIL ON PLUG, FOR: (J)									1.970.537	C10	
300h AWD												
	Petrol/ Electric	145	07/14->	ENGINE 2AR-FXE								
Engine	Information				A10	A20	A40	A50	A70	C10 - C30	C20	E01
All engines	NX 300h, x 4, COIL ON PLUG, FOR: (J)									1.970.537	C10	
300h AWD												
	Petrol/ Electric	147	11/18->	ENGINE 2AR-FXE								
Engine	Information				A10	A20	A40	A50	A70	C10 - C30	C20	E01
All engines	NX 300h, x 4, COIL ON PLUG, FOR: (J)									1.970.537	C10	
RC												
300h												
	Petrol/ Electric	133	09/14->	ENGINE 2AR-FSE								
Engine	Information				A10	A20	A40	A50	A70	C10 - C30	C20	E01
All engines	RC 300h, x 4, COIL ON PLUG, FOR: (J)									1.970.537	C10	
350												
	Petrol	234	08/14->	ENGINE 2GR-FSE								
Engine	Information				A10	A20	A40	A50	A70	C10 - C30	C20	E01
All engines	RC 350, x 6, COIL ON PLUG, FOR: (J)									1.970.537	C10	

A10 CONDENSER	A20 CONTACT SET	A40 DISTRIBUTOR CAP	A50 ROTOR	A70 PICK-UP
C10 COIL	C20 IGNITION MODULE	C30 ELECTRONIC IGNITION KIT	E01 IGNITION CABLE SET	

Vehicle	alim.	kW	Date	Engine	FUNCTIONS ON THE VEHICLE								
					A10	A20	A40	A50	A70	C10 - C30	C20	E01	
ENGINE													
F	Petrol	330	08/14->	2UR-GSE									
ENGINE													
All engines											1.970.458	C10	
F	Petrol	341	03/18->	2UR-GSE									
ENGINE													
All engines											1.970.458	C10	
F	Petrol	344	08/14->	2UR-GSE									
ENGINE													
All engines											1.970.458	C10	
F	Petrol	351	08/14->	2UR-GSE									
ENGINE													
All engines											1.970.458	C10	
RX II													
350	Petrol	203	01/06-12/08	2GR-FE									
ENGINE													
All engines											1.970.538	C10	
350 AWD	Petrol	203	02/06-12/08	2GR-FE, 2GRFE(276)									
ENGINE													
Eng. 2GR-FE											1.970.538	C10	
Eng. 2GRFE(276)											1.970.538	C10	
RX III													
270	Petrol	138	12/08-10/15	1AR-FE									
ENGINE													
All engines											1.970.537	C10	
350	Petrol	202	01/09-09/15	2GR-FE									
ENGINE													
All engines											1.970.538	C10	
350 AWD	Petrol	204	12/08-08/15	2GR-FE									
ENGINE													
All engines											1.970.538	C10	
350 AWD	Petrol	206	03/09-02/12	2GR-FE									
ENGINE													
All engines											1.970.538	C10	
450h	Petrol/ Electric	183	12/08-10/15	2GR-FXE									
ENGINE													
All engines											1.970.538	C10	
450h	Petrol/ Electric	220	12/08-10/15	2GR-FXE									
ENGINE													
All engines											1.970.538	C10	
450h AWD	Petrol/ Electric	183	12/08-10/15	2GR-FXE, 2GRFXE(299H) - E4									
ENGINE													
Eng. 2GRFXE(299H) - E4											1.970.537	C10	
Eng. 2GR-FXE											1.970.538	C10	

A10 CONDENSER	A20 CONTACT SET	A40 DISTRIBUTOR CAP	A50 ROTOR	A70 PICK-UP
C10 COIL	C20 IGNITION MODULE	C30 ELECTRONIC IGNITION KIT	E01 IGNITION CABLE SET	

The present application list is a brief version. For the detailed information about the possibility of installation on a specific vehicle, please refer to our web-catalogue <http://catalogo.facet.eu/>

Vehicle	alim.	kW	Date	Engine	FUNCTIONS ON THE VEHICLE							
					A10	A20	A40	A50	A70	C10 - C30	C20	E01

				ENGINE
450h AWD	Petrol/ Electric	220	12/08-10/15	2GR-FXE

Engine	Information	A10	A20	A40	A50	A70	C10 - C30	C20	E01
All engines	Qty: 6						1.970.537	C10	

				ENGINE
4.0i	Petrol	0	01/91->	1UZFE

Engine	Information	A10	A20	A40	A50	A70	C10 - C30	C20	E01
All engines	Qty: 2						1.970.203	C10	

A10	CONDENSER	A20	CONTACT SET	A40	DISTRIBUTOR CAP	A50	ROTOR	A70	PICK-UP
C10	COIL	C20	IGNITION MODULE	C30	ELECTRONIC IGNITION KIT	E01	IGNITION CABLE SET		

Vehicle	alim.	kW	Date	Engine	FUNCTIONS ON THE VEHICLE							
					A10	A20	A40	A50	A70	C10 - C30	C20	E01

ECLAT

2.0	Petrol	119	10/75-05/80	ENGINE
				907

Engine	Information	A10	A20	A40	A50	A70	C10 - C30	C20	E01
All engines				1.328.075					

ELITE

2.0	Petrol	119	05/74-05/80	ENGINE
				907

Engine	Information	A10	A20	A40	A50	A70	C10 - C30	C20	E01
All engines				1.328.075					



ESPRIT

2.0	Petrol	119	10/75-05/80	ENGINE
				907

Engine	Information	A10	A20	A40	A50	A70	C10 - C30	C20	E01
All engines				1.328.075					

A10	CONDENSER	A20	CONTACT SET	A40	DISTRIBUTOR CAP	A50	ROTOR	A70	PICK-UP
C10	COIL	C20	IGNITION MODULE	C30	ELECTRONIC IGNITION KIT	E01	IGNITION CABLE SET		

The present application list is a brief version. For the detailed information about the possibility of installation on a specific vehicle, please refer to our web-catalogue <http://catalogo.facet.eu/>

				FUNCTIONS ON THE VEHICLE								
Vehicle	alim.	kW	Date	Engine	 A10	 A20	 A40	 A50	 A70	 C10 - C30	 C20	 E01
E2000				ENGINE								
E2000		170	05/00->	E 2866 DF 01								
Engine	Information				A10	A20	A40	A50	A70	C10 - C30	C20	E01
All engines	->year 200209						1.306.081					
F2000				ENGINE								
F2000		170	09/96->	E 2866 DF 01								
Engine	Information				A10	A20	A40	A50	A70	C10 - C30	C20	E01
All engines	->year 200112, ->year 200208						1.306.081					
LION'S CITY				ENGINE								
LION'S CITY		184	06/96->	D 0826 LUH								
Engine	Information				A10	A20	A40	A50	A70	C10 - C30	C20	E01
All engines	200903 ->									1.970.417	C10	
LION'S CITY				ENGINE								
LION'S CITY		228	05/07->	E 2876 LUH 02								
Engine	Information				A10	A20	A40	A50	A70	C10 - C30	C20	E01
All engines										1.970.417	C10	
LION'S CITY				ENGINE								
LION'S CITY		235	10/09->	E 2876 LUH 03								
Engine	Information				A10	A20	A40	A50	A70	C10 - C30	C20	E01
All engines										1.970.417	C10	
NG				ENGINE								
NG		170	01/95-07/99	E 2866 DUH 01								
Engine	Information				A10	A20	A40	A50	A70	C10 - C30	C20	E01
All engines							1.306.081, 1.306.258			1.970.417	C10	
NG				ENGINE								
NG		228	05/07-12/14	E 2876 LUH 02								
Engine	Information				A10	A20	A40	A50	A70	C10 - C30	C20	E01
All engines										1.970.417	C10	
NL				ENGINE								
NL		170	05/93-06/00	E 2866 DUH 01, E 2866 DUH 02								
Engine	Information				A10	A20	A40	A50	A70	C10 - C30	C20	E01
All engines	199404 ->						1.306.081, 1.306.258			1.970.417	C10	
NL				ENGINE								
NL		180	05/07-12/14	E 2866 DUH 03								
Engine	Information				A10	A20	A40	A50	A70	C10 - C30	C20	E01
All engines										1.970.417	C10	
NL				ENGINE								
NL		228	04/99-12/14	E 2866 LUH 02, E 2876 LUH 02								
Engine	Information				A10	A20	A40	A50	A70	C10 - C30	C20	E01
All engines										1.970.417	C10	

A10 CONDENSER	A20 CONTACT SET	A40 DISTRIBUTOR CAP	A50 ROTOR	A70 PICK-UP
C10 COIL	C20 IGNITION MODULE	C30 ELECTRONIC IGNITION KIT	E01 IGNITION CABLE SET	

Vehicle	alim.	kW	Date	Engine	FUNCTIONS ON THE VEHICLE							
					 A10	 A20	 A40	 A50	 A70	 C10 - C30	 C20	 E01

800				ENGINE
0.8	Petrol	26	01/91-12/06	F8B

Engine	Information	A10	A20	A40	A50	A70	C10 - C30	C20	E01
All engines	version Denso		1.213.011HV	1.313.107	1.413.030				

A10	CONDENSER	A20	CONTACT SET	A40	DISTRIBUTOR CAP	A50	ROTOR	A70	PICK-UP
C10	COIL	C20	IGNITION MODULE	C30	ELECTRONIC IGNITION KIT	E01	IGNITION CABLE SET		

The present application list is a brief version. For the detailed information about the possibility of installation on a specific vehicle, please refer to our web-catalogue <http://catalogo.facet.eu/>

					FUNCTIONS ON THE VEHICLE							
Vehicle	alim.	kW	Date	Engine	 A10	 A20	 A40	 A50	 A70	 C10 - C30	 C20	 E01

BITURBO				ENGINE
i	Petrol	136	07/85-04/87	AM 452



Engine	Information	A10	A20	A40	A50	A70	C10 - C30	C20	E01
All engines	version Marelli				1.430.054R				

A10	CONDENSER	A20	CONTACT SET	A40	DISTRIBUTOR CAP	A50	ROTOR	A70	PICK-UP
C10	COIL	C20	IGNITION MODULE	C30	ELECTRONIC IGNITION KIT	E01	IGNITION CABLE SET		

Vehicle	alim.	kW	Date	Engine	FUNCTIONS ON THE VEHICLE							
					A10	A20	A40	A50	A70	C10 - C30	C20	E01
121												
1.3	Petrol	37	07/96-10/02	1E03								
Engine	Information				A10	A20	A40	A50	A70	C10 - C30	C20	E01
All engines	x 1, DENSO, x 1, D.I.S., x 1, D.I.S.									1.970.532	C10	
1.3												
1.3	Petrol	44	01/96-05/97	1E04								
Engine	Information				A10	A20	A40	A50	A70	C10 - C30	C20	E01
All engines	x 1, D.I.S., DENSO, D.I.S.									1.970.532	C10	
121 I												
1.1	Petrol	42	10/87-10/90	B1, B116								
Engine	Information				A10	A20	A40	A50	A70	C10 - C30	C20	E01
Eng. B116	for manuf. exhaust norm US-83, version Mitsubishi						1.331.122					
Eng. B116	super unlead (95), version Mitsubshi						1.331.131					
All engines	version Mitsubishi						1.331.132					
All engines	for manuf. exhaust norm US-83, version Mitsubishi							1.431.108				
Eng. B116	super unlead (95), version Mitsubishi							1.431.119				
Eng. B116	super unlead (95)										1.965.073	
1.3												
1.3	Petrol	40	04/89-10/90	B3								
Engine	Information				A10	A20	A40	A50	A70	C10 - C30	C20	E01
All engines	version Mitsubishi						1.331.122					
All engines	version Mitsubshi						1.331.131					
All engines	version Mitsubishi, no specific info conc. application available							1.431.108, 1.431.119				
All engines											1.965.073	
1.3												
1.3	Petrol	44	10/87-06/91	B3								
Engine	Information				A10	A20	A40	A50	A70	C10 - C30	C20	E01
All engines	FOR: (S), FOR: (CH), version Mitsubishi						1.331.122					
All engines	FOR: (EU), NOT FOR: (S), NOT FOR: (CH), version Mitsubishi						1.331.132					
All engines	version Mitsubishi, no specific info conc. application available							1.431.108, 1.431.119				
121 II												
1.1	Petrol	40	11/90-10/93	B1								
Engine	Information				A10	A20	A40	A50	A70	C10 - C30	C20	E01
All engines	version Mitsubishi						1.331.131	1.431.119				
All engines											1.965.073	
1.3 16V												
1.3 16V	Petrol	39	11/90-03/96	B3 (16V)								
Engine	Information				A10	A20	A40	A50	A70	C10 - C30	C20	E01
All engines	version Hitachi						1.322.088	1.422.094				
1.3 i 16V												
1.3 i 16V	Petrol	53	11/90-03/96	B3 (16V)								
Engine	Information				A10	A20	A40	A50	A70	C10 - C30	C20	E01
All engines	version Hitachi						1.322.088	1.422.094				
121 III												
1.25	Petrol	55	03/96-04/03	1E05, DHF, DHG								
Engine	Information				A10	A20	A40	A50	A70	C10 - C30	C20	E01
Eng. 1E05	->year 01/05/98, 01/06/98 ->, ->year 01/11/00, x 1, D.I.S., x 1, D.I.S.									1.970.299	C10	
Eng. DHF, DHG										1.970.299, 1.970.312	C10	
Eng. 1E05	01/12/00 ->, x 1, D.I.S.									1.970.532	C10	
1.3												
1.3	Petrol	37	03/96-04/03	1E03, JJK, JJM								
Engine	Information				A10	A20	A40	A50	A70	C10 - C30	C20	E01
Eng. 1E03	x 1, DENSO, x 1, D.I.S., x 1, D.I.S.									1.970.532	C10	
Eng. JJK, JJM										1.970.532	C10	

A10 CONDENSER	A20 CONTACT SET	A40 DISTRIBUTOR CAP	A50 ROTOR	A70 PICK-UP
C10 COIL	C20 IGNITION MODULE	C30 ELECTRONIC IGNITION KIT	E01 IGNITION CABLE SET	

The present application list is a brief version. For the detailed information about the possibility of installation on a specific vehicle, please refer to our web-catalogue <http://catalogo.facet.eu/>

					FUNCTIONS ON THE VEHICLE							
Vehicle	alim.	kW	Date	Engine								
2 I												
1.3	Petrol	44	03/96-04/03	ENGINE 1E04, 1E09, J4R, J4T								
Engine					A10	A20	A40	A50	A70	C10 - C30	C20	E01
Eng. 1E04, 1E09										1.970.532	C10	
Eng. J4R, J4T										1.970.532	C10	
2 I												
1.2	Petrol	55	02/03-06/07	ENGINE FUJA								
Engine					A10	A20	A40	A50	A70	C10 - C30	C20	E01
All engines										1.970.481	C10	
All engines										1.970.532	C10	
All engines												1.499.242
1.25	Petrol	55	04/03-06/07	ENGINE FUJA								
Engine					A10	A20	A40	A50	A70	C10 - C30	C20	E01
All engines										1.970.481	C10	
All engines										1.970.532	C10	
All engines												1.499.242
1.3 L	Petrol	67	04/03-06/07	ENGINE ZJ-04								
Engine					A10	A20	A40	A50	A70	C10 - C30	C20	E01
All engines										1.970.481	C10	
All engines										1.970.532	C10	
All engines												1.499.242
1.4	Petrol	59	02/03-06/07	ENGINE FXJA								
Engine					A10	A20	A40	A50	A70	C10 - C30	C20	E01
All engines										1.970.481	C10	
All engines										1.970.532	C10	
All engines												1.499.242
1.5	Petrol	82	04/03-06/07	ENGINE ZY-VE								
Engine					A10	A20	A40	A50	A70	C10 - C30	C20	E01
All engines										1.970.481	C10	
All engines										1.970.532	C10	
All engines												1.499.242
1.6	Petrol	74	02/03-06/07	ENGINE FYJA								
Engine					A10	A20	A40	A50	A70	C10 - C30	C20	E01
All engines										1.970.481	C10	
All engines										1.970.532	C10	
All engines												1.499.242
2 II												
1.3	Petrol	55	10/07-06/15	ENGINE ZJ-46, ZJ-VE								
Engine					A10	A20	A40	A50	A70	C10 - C30	C20	E01
Eng. ZJ-46										1.970.514	C10	
Eng. ZJ-46										1.970.516	C10	
Eng. ZJ-VE										1.970.516	C10	
1.3	Petrol	63	10/07-06/15	ENGINE ZJ-46, ZJ-VE								
Engine					A10	A20	A40	A50	A70	C10 - C30	C20	E01
Eng. ZJ-46										1.970.514	C10	
Eng. ZJ-46										1.970.516	C10	
Eng. ZJ-VE										1.970.516	C10	
1.3	Petrol	67	07/07-11/14	ENGINE ZJ-VE								
Engine					A10	A20	A40	A50	A70	C10 - C30	C20	E01
All engines										1.970.516	C10	

A10 CONDENSER	A20 CONTACT SET	A40 DISTRIBUTOR CAP	A50 ROTOR	A70 PICK-UP
C10 COIL	C20 IGNITION MODULE	C30 ELECTRONIC IGNITION KIT	E01 IGNITION CABLE SET	

Vehicle	alim.	kW	Date	Engine	FUNCTIONS ON THE VEHICLE									
					A10	A20	A40	A50	A70	C10 - C30	C20	E01		
ENGINE														
1.3 BiFuel	Petrol/ Liquified Petro- leum Gas (LPG)	55	05/11-11/14	ZJ-46										
Engine	Information				A10	A20	A40	A50	A70	C10 - C30	C20	E01		
All engines	x 4, version 2, COIL ON PLUG									1.970.514	C10			
All engines	x 4, version 1, COIL ON PLUG									1.970.516	C10			
ENGINE														
1.3 BiFuel	Petrol/ Liquified Petro- leum Gas (LPG)	62	05/11-11/14	ZJ-46										
Engine	Information				A10	A20	A40	A50	A70	C10 - C30	C20	E01		
All engines	x 4, COIL ON PLUG									1.970.516	C10			
ENGINE														
1.3 MZR	Petrol	62	01/10-06/15	ZJ-46, ZJ-VE										
Engine	Information				A10	A20	A40	A50	A70	C10 - C30	C20	E01		
Eng. ZJ-46	x 4, COIL ON PLUG									1.970.516	C10			
Eng. ZJ-VE	Qty: 4									1.970.516	C10			
ENGINE														
1.5	Petrol	76	07/07-06/15	ZY66, ZY-DE, ZY-VE										
Engine	Information				A10	A20	A40	A50	A70	C10 - C30	C20	E01		
Eng. ZY66	->year 01/11/09, x 4, COIL ON PLUG									1.970.514	C10			
Eng. ZY66	01/12/09 ->, x 4, COIL ON PLUG									1.970.516	C10			
Eng. ZY-DE, ZY-VE	Qty: 4									1.970.516	C10			
ENGINE														
1.5	Petrol	83	10/07-06/15	ZY06										
Engine	Information				A10	A20	A40	A50	A70	C10 - C30	C20	E01		
All engines	x 4, COIL ON PLUG									1.970.516	C10			
ENGINE														
1.5 i	Petrol	76	05/10-06/15	ZY-DE										
Engine	Information				A10	A20	A40	A50	A70	C10 - C30	C20	E01		
All engines	Qty: 4									1.970.516	C10			
ENGINE														
1.5 MZR	Petrol	75	06/11-06/15	ZY05, ZY66										
Engine	Information				A10	A20	A40	A50	A70	C10 - C30	C20	E01		
Eng. ZY05	Qty: 4									1.970.516	C10			
Eng. ZY66	x 4, COIL ON PLUG									1.970.516	C10			
2 III														
ENGINE														
1.5	Petrol	55	08/14-11/17	P5X0, P5X2, P5Y5, P5Y8, P5Z7, P5Z8, P5Z9										
Engine	Information				A10	A20	A40	A50	A70	C10 - C30	C20	E01		
All engines	x 4, COIL ON PLUG									1.970.627	C10			
ENGINE														
1.5	Petrol	79	11/14->	P5Y4										
Engine	Information				A10	A20	A40	A50	A70	C10 - C30	C20	E01		
All engines	+start-stop function, Qty: 4									1.970.627	C10			
All engines	x 4, +start-stop function, COIL ON PLUG									1.970.627	C10			
ENGINE														
1.5	Petrol	81	11/14->	P5Y4, P5Y6										
Engine	Information				A10	A20	A40	A50	A70	C10 - C30	C20	E01		
All engines	+start-stop function, Qty: 4									1.970.627	C10			
ENGINE														
1.5	Petrol	85	01/15->	P5Y5										
Engine	Information				A10	A20	A40	A50	A70	C10 - C30	C20	E01		
All engines	+start-stop function, Qty: 4									1.970.627	C10			

A10	CONDENSER	A20	CONTACT SET	A40	DISTRIBUTOR CAP	A50	ROTOR	A70	PICK-UP
C10	COIL	C20	IGNITION MODULE	C30	ELECTRONIC IGNITION KIT	E01	IGNITION CABLE SET		

The present application list is a brief version. For the detailed information about the possibility of installation on a specific vehicle, please refer to our web-catalogue <http://catalogo.facet.eu/>

Vehicle	alim.	kW	Date	Engine	FUNCTIONS ON THE VEHICLE									
					A10	A20	A40	A50	A70	C10 - C30	C20	E01		
ENGINE														
1.5 SKYACTIV-G	Petrol	66	08/14-11/17	P5X0, P5X2, P5Y5, P5Y6, P5Y8, P5Z2, P5Z3, P5Z7, P5Z8, P5Z9										
Engine	Information				A10	A20	A40	A50	A70	C10 - C30	C20	E01		
All engines	x 4, COIL ON PLUG									1.970.627	C10			
ENGINE														
1.5 SKYACTIV-G	Petrol	85	08/14->	P5X0, P5X2, P5Y5, P5Z3, P5Z7, P5Z8, P5Z9										
Engine	Information				A10	A20	A40	A50	A70	C10 - C30	C20	E01		
All engines	x 4, COIL ON PLUG									1.970.627	C10			
3														
ENGINE														
2.0	Petrol	108	09/03-06/06	LF17										
Engine	Information				A10	A20	A40	A50	A70	C10 - C30	C20	E01		
All engines	x 4, COIL ON PLUG									1.970.480	C10			
3 I														
ENGINE														
1.3	Petrol	62	10/03-06/09	ZJ07, ZJ30, ZJ-VE										
Engine	Information				A10	A20	A40	A50	A70	C10 - C30	C20	E01		
Eng. ZJ07, ZJ30	x 4, COIL ON PLUG									1.970.514	C10			
Eng. ZJ-VE	FOR MODEL: 2003, Qty: 4									1.970.514	C10			
Eng. ZJ-VE	FOR MODEL: 2006, Qty: 4									1.970.516	C10			
ENGINE														
1.4	Petrol	59	02/04-06/09	FXJA										
Engine	Information				A10	A20	A40	A50	A70	C10 - C30	C20	E01		
All engines	FOR MODEL: 2003, Qty: 4									1.970.514	C10			
All engines	FOR MODEL: 2006, Qty: 4									1.970.516	C10			
ENGINE														
1.6	Petrol	77	10/03-06/09	B6ZE, Z6, Z601, Z627										
Engine	Information				A10	A20	A40	A50	A70	C10 - C30	C20	E01		
Eng. B6ZE, Z6	FOR MODEL: 2003, Qty: 4									1.970.514	C10			
Eng. Z601, Z627	->year 01/02/06, x 4, COIL ON PLUG									1.970.514	C10			
Eng. B6ZE, Z6	FOR MODEL: 2006, Qty: 4									1.970.516	C10			
Eng. Z601, Z627	01/03/06->, x 4, COIL ON PLUG									1.970.516	C10			
ENGINE														
2.0	Petrol	104	10/03-06/06	LF17										
Engine	Information				A10	A20	A40	A50	A70	C10 - C30	C20	E01		
All engines	FOR MODEL: 2003, Qty: 4									1.970.480	C10			
ENGINE														
2.0	Petrol	108	10/03-06/06	LF17										
Engine	Information				A10	A20	A40	A50	A70	C10 - C30	C20	E01		
All engines	FOR MODEL: 2003, Qty: 4									1.970.480	C10			
ENGINE														
2.0	Petrol	110	10/03-12/09	LF17, LF50, LF72, LFN7, LFN8										
Engine	Information				A10	A20	A40	A50	A70	C10 - C30	C20	E01		
Eng. LF17	FOR MODEL: 2003, Qty: 4									1.970.480	C10			
Eng. LF50, LF72, LFN7, LFN8	->year 01/02/06, x 4, COIL ON PLUG									1.970.480	C10			
3 II														
ENGINE														
1.6 MZR	Petrol	77	12/08-09/14	Z6, Z668, Z682, Z683										
Engine	Information				A10	A20	A40	A50	A70	C10 - C30	C20	E01		
Eng. Z668, Z682, Z683	x 4, COIL ON PLUG									1.970.514	C10			
Eng. Z6	Qty: 4									1.970.516	C10			
ENGINE														
1.6 MZR	Petrol	79	01/10-12/13	Z6, Z682										
Engine	Information				A10	A20	A40	A50	A70	C10 - C30	C20	E01		
Eng. Z682	x 4, COIL ON PLUG									1.970.514	C10			
Eng. Z6	Qty: 4									1.970.516	C10			

A10 CONDENSER	A20 CONTACT SET	A40 DISTRIBUTOR CAP	A50 ROTOR	A70 PICK-UP
C10 COIL	C20 IGNITION MODULE	C30 ELECTRONIC IGNITION KIT	E01 IGNITION CABLE SET	

Vehicle	alim.	kW	Date	Engine	FUNCTIONS ON THE VEHICLE							
					A10	A20	A40	A50	A70	C10 - C30	C20	E01

3 III

				ENGINE
1.5	Petrol	74	09/13->	P5Y1, P5Y4, P5Y5, P5Z3

Engine	Information	A10	A20	A40	A50	A70	C10 - C30	C20	E01
All engines	x 4, COIL ON PLUG						1.970.627	C10	

				ENGINE
1.5	Petrol	82	09/13->	P5-VPS

Engine	Information	A10	A20	A40	A50	A70	C10 - C30	C20	E01
All engines	Qty: 4						1.970.627	C10	

				ENGINE
1.5	Petrol	88	10/13->	P5Y1, P5Y4, P5Y5, P5Z3

Engine	Information	A10	A20	A40	A50	A70	C10 - C30	C20	E01
All engines	x 4, COIL ON PLUG						1.970.627	C10	

				ENGINE
1.6	Petrol	77	09/13->	Z6Y1, Z6Y3

Engine	Information	A10	A20	A40	A50	A70	C10 - C30	C20	E01
All engines	x 4, COIL ON PLUG						1.970.516	C10	

				ENGINE
2.0	Petrol	110	11/13->	PEY7

Engine	Information	A10	A20	A40	A50	A70	C10 - C30	C20	E01
All engines	x 4, COIL ON PLUG						1.970.627	C10	

				ENGINE
2.0	Petrol	114	11/13->	LFX

Engine	Information	A10	A20	A40	A50	A70	C10 - C30	C20	E01
All engines	Qty: 4						1.970.627	C10	

				ENGINE
2.0	Petrol	121	07/13->	PEX2, PEXL, PEY5, PEY7

Engine	Information	A10	A20	A40	A50	A70	C10 - C30	C20	E01
All engines	x 4, COIL ON PLUG						1.970.627	C10	

				ENGINE
2.0	Petrol	88	09/13->	PEXL, PEY5, PEY7

Engine	Information	A10	A20	A40	A50	A70	C10 - C30	C20	E01
All engines	x 4, COIL ON PLUG						1.970.627	C10	

				ENGINE
2.0 Hybrid	Petrol/ Electric	60	10/14->	--

Engine	Information	A10	A20	A40	A50	A70	C10 - C30	C20	E01
All engines	Qty: 4						1.970.627	C10	

				ENGINE
2.0 Hybrid	Petrol/ Electric	73	10/14->	PE-VPH

Engine	Information	A10	A20	A40	A50	A70	C10 - C30	C20	E01
All engines	Qty: 4						1.970.627	C10	

3 IV

				ENGINE
1.5 SKYACTIV-G	Petrol	88	11/18->	P5X4

Engine	Information	A10	A20	A40	A50	A70	C10 - C30	C20	E01
All engines	x 4, Vehicle Equipment:for vehicles with cylinder shut-down, Vehicle Equipment:for vehicles without cylinder shutdown, COIL ON PLUG						1.970.627	C10	

				ENGINE
2.0 SKYACTIV-G	Petrol	110	11/18->	PEXN, PEXP









Engine	Information	A10	A20	A40	A50	A70	C10 - C30	C20	E01
All engines	x 4, Vehicle Equipment:for vehicles with cylinder shut-down, Vehicle Equipment:for vehicles without cylinder shutdown, COIL ON PLUG						1.970.627	C10	

				ENGINE
2.0 SKYACTIV-G M Hybrid	Petrol/ Electric	110	01/20->	PEXN

Engine	Information	A10	A20	A40	A50	A70	C10 - C30	C20	E01
All engines	x 4, COIL ON PLUG						1.970.627	C10	

A10	CONDENSER	A20	CONTACT SET	A40	DISTRIBUTOR CAP	A50	ROTOR	A70	PICK-UP
C10	COIL	C20	IGNITION MODULE	C30	ELECTRONIC IGNITION KIT	E01	IGNITION CABLE SET		

The present application list is a brief version. For the detailed information about the possibility of installation on a specific vehicle, please refer to our web-catalogue <http://catalogo.facet.eu/>

					FUNCTIONS ON THE VEHICLE												
Vehicle	alim.	kW	Date	Engine													
2.0 SKYACTIV-G M Hybrid					ENGINE												
Petrol/ Electric	90	11/18->	PEXN														
Engine	Information			A10	A20	A40	A50	A70	C10 - C30	C20	E01						
All engines	x 4, COIL ON PLUG								1.970.627	C10							
2.0 SKYACTIV-X M Hybrid					ENGINE												
Petrol/ Electric	137	02/21->	HFY7														
Engine	Information			A10	A20	A40	A50	A70	C10 - C30	C20	E01						
All engines	x 4, COIL ON PLUG								1.970.627	C10							
SKYACTIV-X M Hybrid					ENGINE												
Petrol/ Electric	137	02/21->	HFY7														
Engine	Information			A10	A20	A40	A50	A70	C10 - C30	C20	E01						
All engines	x 4, COIL ON PLUG								1.970.627	C10							
SKYACTIV-X M Hybrid AWD					ENGINE												
Petrol/ Electric	137	02/21->	HFY7														
Engine	Information			A10	A20	A40	A50	A70	C10 - C30	C20	E01						
All engines	x 4, COIL ON PLUG								1.970.627	C10							
323 IV					ENGINE												
1.1	Petrol	40	11/80-10/85	E1													
Engine	Information			A10	A20	A40	A50	A70	C10 - C30	C20	E01						
All engines	version Mitsubishi					1.331.109											
1.3					ENGINE												
Petrol	44	09/81-10/85	E3														
Engine	Information			A10	A20	A40	A50	A70	C10 - C30	C20	E01						
All engines	version Mitsubishi					1.331.132	1.431.108										
323 V					ENGINE												
1.1	Petrol	40	09/85-10/89	E1													
Engine	Information			A10	A20	A40	A50	A70	C10 - C30	C20	E01						
All engines	version Mitsubishi					1.331.118											
1.3					ENGINE												
Petrol	44	08/85-05/89	E3														
Engine	Information			A10	A20	A40	A50	A70	C10 - C30	C20	E01						
All engines	version Mitsubishi, no specific info conc. application available					1.331.118, 1.331.132	1.431.108										
1.3					ENGINE												
Petrol	50	01/86-06/87	E393														
Engine	Information			A10	A20	A40	A50	A70	C10 - C30	C20	E01						
All engines	version Mitsubishi, no specific info conc. application available					1.331.118, 1.331.132	1.431.108										
1.3					ENGINE												
Petrol	52	01/86-06/87	E391														
Engine	Information			A10	A20	A40	A50	A70	C10 - C30	C20	E01						
All engines	version Mitsubishi, no specific info conc. application available					1.331.118, 1.331.132	1.431.108										
1.3 i					ENGINE												
Petrol	49	09/85-08/89	B3E														
Engine	Information			A10	A20	A40	A50	A70	C10 - C30	C20	E01						
All engines	version Mitsubishi, no specific info conc. application available					1.331.118, 1.331.132	1.431.108										
1.5					ENGINE												
Petrol	54	01/87-10/89	B5, B50, B53														
Engine	Information			A10	A20	A40	A50	A70	C10 - C30	C20	E01						
All engines	version Mitsubishi, no specific info conc. application available					1.331.118, 1.331.132	1.431.108										
1.5					ENGINE												
Petrol	55	08/85-05/89	B50, B53, E5														
Engine	Information			A10	A20	A40	A50	A70	C10 - C30	C20	E01						
All engines	version Mitsubishi, no specific info conc. application available					1.331.118, 1.331.132	1.431.108										
A10	CONDENSER	A20	CONTACT SET	A40	DISTRIBUTOR CAP	A50	ROTOR	A70	PICK-UP	C10	COIL	C20	IGNITION MODULE	C30	ELECTRONIC IGNITION KIT	E01	IGNITION CABLE SET

Vehicle	alim.	kW	Date	Engine	FUNCTIONS ON THE VEHICLE							
					A10	A20	A40	A50	A70	C10 - C30	C20	E01

ENGINE				
1.6	Petrol	63	09/86-10/95	93AF1006, B6E

Engine	Information	A10	A20	A40	A50	A70	C10 - C30	C20	E01
All engines	version Mitsubishi, no specific info conc. application available			1.331.122, 1.331.132					
All engines	version Hitachi				1.422.073				
All engines	version Mitsubishi				1.431.108				

ENGINE				
1.6 4x4	Petrol	63	05/90-03/93	B65M, B6E

Engine	Information	A10	A20	A40	A50	A70	C10 - C30	C20	E01
All engines	version Mitsubishi			1.331.122	1.431.108				

ENGINE				
1.6 GT	Petrol	63	11/86-10/89	93AF1006

Engine	Information	A10	A20	A40	A50	A70	C10 - C30	C20	E01
All engines	super unlead (95), version Mitsubishi			1.331.122	1.431.108				
All engines	Super (98), version Mitsubishi			1.331.125					
All engines	super unlead (95), version Hitachi				1.422.073				

ENGINE				
1.6 GT	Petrol	77	01/86-12/88	93AF1006

Engine	Information	A10	A20	A40	A50	A70	C10 - C30	C20	E01
All engines	super unlead (95), version Mitsubishi			1.331.122	1.431.108				
All engines	Super (98), version Mitsubishi			1.331.125					
All engines	super unlead (95), version Hitachi				1.422.073				

ENGINE				
1.6i	Petrol	54	06/86-07/87	B681, B682

Engine	Information	A10	A20	A40	A50	A70	C10 - C30	C20	E01
All engines	Super (98), version Mitsubishi			1.331.125					
All engines	super unlead (95), version Hitachi				1.422.073				

ENGINE				
1.6i 16v 4x4	Petrol	100	06/86-07/87	B595

Engine	Information	A10	A20	A40	A50	A70	C10 - C30	C20	E01
All engines	Super (98), version Mitsubishi			1.331.125					
All engines	super unlead (95), version Hitachi				1.422.073				

ENGINE				
1.6i 16v Formula 4	Petrol	110	08/87-05/89	B6F2

Engine	Information	A10	A20	A40	A50	A70	C10 - C30	C20	E01
All engines	super unlead (95), version Mitsubishi			1.331.122	1.431.108				
All engines	Super (98), version Mitsubishi			1.331.125					

323 VI

ENGINE				
1.3 16V	Petrol	55	06/89-03/91	B384, B386, B387

Engine	Information	A10	A20	A40	A50	A70	C10 - C30	C20	E01
All engines	version Mitsubishi			1.331.131	1.431.119				
All engines							1.970.233	C10	1.965.073

ENGINE				
1.8i 16v 4x4	Petrol	78	06/89-03/91	BP51

Engine	Information	A10	A20	A40	A50	A70	C10 - C30	C20	E01
All engines	version Mitsubishi			1.331.121					
All engines							1.970.233	C10	

ENGINE				
1.8i 16v GRSi	Petrol	103	06/89-03/91	BP22

Engine	Information	A10	A20	A40	A50	A70	C10 - C30	C20	E01
All engines	version Mitsubishi			1.331.121					
All engines							1.970.233	C10	

ENGINE				
1.8i 16v GT Formula 4	Petrol	122	04/91-04/94	BP55

Engine	Information	A10	A20	A40	A50	A70	C10 - C30	C20	E01
All engines	version Mitsubishi			1.331.121					
All engines							1.970.233	C10	

A10 CONDENSER	A20 CONTACT SET	A40 DISTRIBUTOR CAP	A50 ROTOR	A70 PICK-UP
C10 COIL	C20 IGNITION MODULE	C30 ELECTRONIC IGNITION KIT	E01 IGNITION CABLE SET	

The present application list is a brief version. For the detailed information about the possibility of installation on a specific vehicle, please refer to our web-catalogue <http://catalogo.facet.eu/>

Vehicle	alim.	kW	Date	Engine	FUNCTIONS ON THE VEHICLE								
					A10	A20	A40	A50	A70	C10 - C30	C20	E01	
ENGINE													
1.8i 16v GT-R Formula 4	Petrol	138	04/91-04/94	BP5J									
Engine	Information				A10	A20	A40	A50	A70	C10 - C30	C20	E01	
All engines	version Mitsubishi						1.331.121						
All engines										1.970.233	C10		
ENGINE													
1.8i 16v Turbo 4x4	Petrol	122	06/89-03/91	BP55									
Engine	Information				A10	A20	A40	A50	A70	C10 - C30	C20	E01	
All engines	version Mitsubishi						1.331.121						
All engines										1.970.233	C10		
323 VI C													
ENGINE													
1.3	Petrol	49	09/89-07/94	B3E									
Engine	Information				A10	A20	A40	A50	A70	C10 - C30	C20	E01	
All engines								1.431.113					
ENGINE													
1.6	Petrol	62	09/89-06/91	B6E									
Engine	Information				A10	A20	A40	A50	A70	C10 - C30	C20	E01	
All engines	version Mitsubishi						1.331.121						
All engines	version Mitsubishi, no specific info conc. application available							1.431.119					
All engines										1.970.233	C10	1.965.073	
ENGINE													
1.6 16V	Petrol	65	03/91-10/94	B6									
Engine	Information				A10	A20	A40	A50	A70	C10 - C30	C20	E01	
All engines	version Mitsubishi						1.331.121						
All engines										1.970.233	C10	1.965.073	
All engines	no specific info conc. application available												1.501.398
ENGINE													
1.8 16V 4WD	Petrol	76	11/91-12/93	BP									
Engine	Information				A10	A20	A40	A50	A70	C10 - C30	C20	E01	
All engines								1.431.113					
ENGINE													
1.8 16V GT	Petrol	94	09/89-03/93	BP (DOHC)									
Engine	Information				A10	A20	A40	A50	A70	C10 - C30	C20	E01	
All engines								1.431.113					
ENGINE													
1.8 16V Turbo 4WD	Petrol	120	09/90-12/92	BP Turbo									
Engine	Information				A10	A20	A40	A50	A70	C10 - C30	C20	E01	
All engines								1.431.113					
323 VI F													
ENGINE													
1.6	Petrol	62	09/89-06/91	B6E									
Engine	Information				A10	A20	A40	A50	A70	C10 - C30	C20	E01	
All engines	version Mitsubishi						1.331.121						
All engines	version Mitsubishi, no specific info conc. application available							1.431.119					
All engines										1.970.233	C10	1.965.073	
ENGINE													
1.6 16V	Petrol	65	03/91-10/94	B6									
Engine	Information				A10	A20	A40	A50	A70	C10 - C30	C20	E01	
All engines	version Mitsubishi						1.331.121						
All engines										1.970.233	C10	1.965.073	
All engines	no specific info conc. application available												1.501.398
ENGINE													
1.8 16V	Petrol	76	08/89-07/94	BP									
Engine	Information				A10	A20	A40	A50	A70	C10 - C30	C20	E01	
All engines	version Mitsubishi						1.331.121						
All engines										1.970.233	C10		1.501.398

A10 CONDENSER	A20 CONTACT SET	A40 DISTRIBUTOR CAP	A50 ROTOR	A70 PICK-UP
C10 COIL	C20 IGNITION MODULE	C30 ELECTRONIC IGNITION KIT	E01 IGNITION CABLE SET	

Vehicle	alim.	kW	Date	Engine	FUNCTIONS ON THE VEHICLE							
					A10	A20	A40	A50	A70	C10 - C30	C20	E01

				ENGINE
1.8 16V GT	Petrol	94	08/89-07/94	BP (DOHC)

Engine	Information	A10	A20	A40	A50	A70	C10 - C30	C20	E01
All engines	version Mitsubishi			1.331.121					
All engines							1.970.233	C10	1.501.398

				ENGINE
1.8i 16v GR5i	Petrol	103	06/89-03/91	BP31

Engine	Information	A10	A20	A40	A50	A70	C10 - C30	C20	E01
All engines	version Mitsubishi			1.331.121					
All engines							1.970.233	C10	1.501.398

323 VI S

				ENGINE
1.3	Petrol	49	09/89-06/91	B383, B3E

Engine	Information	A10	A20	A40	A50	A70	C10 - C30	C20	E01
All engines	version Mitsubishi			1.331.131	1.431.119				
All engines								1.965.073	

				ENGINE
1.3 16V	Petrol	54	04/91-07/94	B3 (16V)

Engine	Information	A10	A20	A40	A50	A70	C10 - C30	C20	E01
All engines	version Mitsubishi			1.331.121, 1.331.131					
All engines	version Mitsubishi, no specific info conc. application available				1.431.119				
All engines							1.970.233	C10	1.501.398
All engines	->ch. 853897							1.965.073	

				ENGINE
1.6	Petrol	62	09/89-06/91	B6E

Engine	Information	A10	A20	A40	A50	A70	C10 - C30	C20	E01
All engines	version Mitsubishi			1.331.121					
All engines	version Mitsubishi, no specific info conc. application available				1.431.119				
All engines							1.970.233	C10	1.965.073

				ENGINE
1.6 16V	Petrol	65	08/89-10/96	B6

Engine	Information	A10	A20	A40	A50	A70	C10 - C30	C20	E01
All engines	version Mitsubishi			1.331.121, 1.331.131					
All engines	version Mitsubishi, no specific info conc. application available				1.431.119				
All engines							1.970.233	C10	1.501.398
All engines	->ch. 853897							1.965.073	

				ENGINE
1.8 16V	Petrol	76	08/89-07/94	BP52

Engine	Information	A10	A20	A40	A50	A70	C10 - C30	C20	E01
All engines	version Mitsubishi			1.331.121					
All engines							1.970.233	C10	1.501.398

				ENGINE
1.8 16V 4WD	Petrol	76	09/91-07/94	BP52

Engine	Information	A10	A20	A40	A50	A70	C10 - C30	C20	E01
All engines	version Mitsubishi			1.331.121					
All engines							1.970.233	C10	1.501.398

				ENGINE
1.8 16V Turbo 4WD	Petrol	120	01/91-07/94	BP Turbo

Engine	Information	A10	A20	A40	A50	A70	C10 - C30	C20	E01
All engines	version Mitsubishi			1.331.121					
All engines							1.970.233	C10	

323 VII

				ENGINE
1.5 16V	Petrol	65	07/94-09/98	Z5-DE

Engine	Information	A10	A20	A40	A50	A70	C10 - C30	C20	E01
All engines	version Mitsubishi			1.331.150	1.431.132				
All engines									1.501.738

A10 CONDENSER	A20 CONTACT SET	A40 DISTRIBUTOR CAP	A50 ROTOR	A70 PICK-UP
C10 COIL	C20 IGNITION MODULE	C30 ELECTRONIC IGNITION KIT	E01 IGNITION CABLE SET	

The present application list is a brief version. For the detailed information about the possibility of installation on a specific vehicle, please refer to our web-catalogue <http://catalogo.facet.eu/>









Vehicle	alim.	kW	Date	Engine	FUNCTIONS ON THE VEHICLE									
					A10	A20	A40	A50	A70	C10 - C30	C20	E01		
ENGINE														
1.8 16V	Petrol	84	08/94-09/98	BP-ZE										
Engine	Information				A10	A20	A40	A50	A70	C10 - C30	C20	E01		
All engines	version Mitsubishi						1.331.150	1.431.132						
All engines													1.501.231	
ENGINE														
2.0 24V	Petrol	106	08/94-09/98	KF										
Engine	Information				A10	A20	A40	A50	A70	C10 - C30	C20	E01		
All engines	version Mitsubishi						1.331.149	1.431.134						
All engines													1.501.760	
323 VII C														
ENGINE														
1.3 16V	Petrol	54	08/94-09/98	B3 (16V)										
Engine	Information				A10	A20	A40	A50	A70	C10 - C30	C20	E01		
All engines	version Mitsubishi						1.331.154	1.431.132						
ENGINE														
1.5 16V	Petrol	65	08/94-09/98	Z5-DE										
Engine	Information				A10	A20	A40	A50	A70	C10 - C30	C20	E01		
All engines	version Mitsubishi						1.331.150	1.431.132						
All engines													1.501.738	
ENGINE														
1.8 16V	Petrol	84	08/94-09/98	BP-ZE										
Engine	Information				A10	A20	A40	A50	A70	C10 - C30	C20	E01		
All engines	version Mitsubishi						1.331.150	1.431.132						
All engines													1.501.231	
323 VII P														
ENGINE														
1.3 16V	Petrol	54	10/96-09/98	B3 (16V)										
Engine	Information				A10	A20	A40	A50	A70	C10 - C30	C20	E01		
All engines	version Mitsubishi						1.331.154	1.431.132						
ENGINE														
1.5 16V	Petrol	65	10/96-09/98	Z5-DE										
Engine	Information				A10	A20	A40	A50	A70	C10 - C30	C20	E01		
All engines	version Mitsubishi						1.331.150	1.431.132						
All engines													1.501.738	
323 VIII F														
ENGINE														
1.4	Petrol	53	01/01-05/04	B3 (16V)										
Engine	Information				A10	A20	A40	A50	A70	C10 - C30	C20	E01		
All engines	version Mitsubishi						1.331.154	1.431.132						
All engines													1.501.741	
ENGINE														
1.4 16V	Petrol	54	09/98-01/01	B3 ME										
Engine	Information				A10	A20	A40	A50	A70	C10 - C30	C20	E01		
All engines	version Mitsubishi						1.331.154	1.431.132						
All engines													1.501.741	
ENGINE														
1.5 16V	Petrol	65	09/98-01/01	ZL05, ZL06										
Engine	Information				A10	A20	A40	A50	A70	C10 - C30	C20	E01		
All engines														1.501.729
ENGINE														
1.6	Petrol	70	01/01-05/04	ZM										
Engine	Information				A10	A20	A40	A50	A70	C10 - C30	C20	E01		
All engines														1.501.729
ENGINE														
1.6	Petrol	72	01/01-05/04	ZM										
Engine	Information				A10	A20	A40	A50	A70	C10 - C30	C20	E01		
All engines														1.501.729

A10 CONDENSER	A20 CONTACT SET	A40 DISTRIBUTOR CAP	A50 ROTOR	A70 PICK-UP
C10 COIL	C20 IGNITION MODULE	C30 ELECTRONIC IGNITION KIT	E01 IGNITION CABLE SET	

Vehicle	alim.	kW	Date	Engine	FUNCTIONS ON THE VEHICLE									
					A10	A20	A40	A50	A70	C10 - C30	C20	E01		
ENGINE														
1.8 Astina	Petrol	92	09/98-05/04	BP (DOHC)										
Engine	Information				A10	A20	A40	A50	A70	C10 - C30	C20	E01		
All engines													1.501.767	
ENGINE														
1.9 16V	Petrol	84	09/98-01/01	FP, FP55										
Engine	Information				A10	A20	A40	A50	A70	C10 - C30	C20	E01		
All engines													1.501.740	
ENGINE														
2.0	Petrol	96	01/01-05/04	FS7E, FS7G										
Engine	Information				A10	A20	A40	A50	A70	C10 - C30	C20	E01		
All engines													1.501.767	
ENGINE														
2.0	Petrol	98	02/00-09/04	FS										
Engine	Information				A10	A20	A40	A50	A70	C10 - C30	C20	E01		
All engines													1.501.767	
323 VIII S														
ENGINE														
1.3	Petrol	53	01/01-05/04	B3 (16V)										
Engine	Information				A10	A20	A40	A50	A70	C10 - C30	C20	E01		
All engines	version Mitsubishi						1.331.154	1.431.132						
All engines													1.501.741	
ENGINE														
1.3 16V	Petrol	54	08/94-01/01	B3 (16V), B3 ME										
Engine	Information				A10	A20	A40	A50	A70	C10 - C30	C20	E01		
All engines	version Mitsubishi						1.331.154	1.431.132						
Eng. B3 ME													1.501.741	
ENGINE														
1.5 16V	Petrol	65	08/94-01/01	Z5-DE, ZL05, ZL06										
Engine	Information				A10	A20	A40	A50	A70	C10 - C30	C20	E01		
Eng. Z5-DE	version Mitsubishi						1.331.150	1.431.132						
Eng. ZL05, ZL06													1.501.729	
Eng. Z5-DE													1.501.738	
ENGINE														
1.6	Petrol	70	01/01-05/04	ZM										
Engine	Information				A10	A20	A40	A50	A70	C10 - C30	C20	E01		
All engines													1.501.729	
ENGINE														
1.6	Petrol	72	01/01-05/04	ZM										
Engine	Information				A10	A20	A40	A50	A70	C10 - C30	C20	E01		
All engines													1.501.729	
ENGINE														
1.8 16V	Petrol	84	08/94-09/98	BP-ZE										
Engine	Information				A10	A20	A40	A50	A70	C10 - C30	C20	E01		
All engines	version Mitsubishi						1.331.150	1.431.132						
All engines													1.501.231	
ENGINE														
1.8 Protege	Petrol	92	05/98-05/04	BP (DOHC)										
Engine	Information				A10	A20	A40	A50	A70	C10 - C30	C20	E01		
All engines													1.501.767	
ENGINE														
1.9 16V	Petrol	84	09/98-05/04	FP, FP55										
Engine	Information				A10	A20	A40	A50	A70	C10 - C30	C20	E01		
All engines													1.501.740	
ENGINE														
2.0	Petrol	96	01/01-05/04	FS7E, FS7G										
Engine	Information				A10	A20	A40	A50	A70	C10 - C30	C20	E01		
All engines													1.501.767	

A10 CONDENSER	A20 CONTACT SET	A40 DISTRIBUTOR CAP	A50 ROTOR	A70 PICK-UP
C10 COIL	C20 IGNITION MODULE	C30 ELECTRONIC IGNITION KIT	E01 IGNITION CABLE SET	

The present application list is a brief version. For the detailed information about the possibility of installation on a specific vehicle, please refer to our web-catalogue <http://catalogo.facet.eu/>

				FUNCTIONS ON THE VEHICLE								
Vehicle	alim.	kW	Date	Engine	 A10	 A20	 A40	 A50	 A70	 C10 - C30	 C20	 E01
				ENGINE								
2.0	Petrol	98	02/00-05/04	FS								
				ENGINE								
Engine Information				A10	A20	A40	A50	A70	C10 - C30	C20	E01	
All engines												1.501.767
				6 I								
				ENGINE								
1.8	Petrol	88	08/02-08/07	L813, L823, L828								
				ENGINE								
Engine Information				A10	A20	A40	A50	A70	C10 - C30	C20	E01	
All engines FOR MODEL: 2002												1.499.245
				ENGINE								
2.0	Petrol	104	06/02-08/07	LF17, LF18								
				ENGINE								
Engine Information				A10	A20	A40	A50	A70	C10 - C30	C20	E01	
All engines												1.499.245
				ENGINE								
2.3	Petrol	122	01/02-02/08	L3C1								
				ENGINE								
Engine Information				A10	A20	A40	A50	A70	C10 - C30	C20	E01	
All engines												1.499.245
				ENGINE								
2.3 AWD	Petrol	119	11/02-08/07	L3C1								
				ENGINE								
Engine Information				A10	A20	A40	A50	A70	C10 - C30	C20	E01	
All engines												1.499.245
				6 III								
				ENGINE								
2.0	Petrol	107	01/13->	PEXB, PEXL, PEY5, PEY7								
				ENGINE								
Engine Information				A10	A20	A40	A50	A70	C10 - C30	C20	E01	
All engines x 4, COIL ON PLUG									1.970.627	C10		
				ENGINE								
2.0	Petrol	110	12/12->	PEXL, PEY5, PEY7								
				ENGINE								
Engine Information				A10	A20	A40	A50	A70	C10 - C30	C20	E01	
All engines x 4, COIL ON PLUG									1.970.627	C10		
				ENGINE								
2.0	Petrol	114	12/12->	PE-VPR, PEY5, PEY7								
				ENGINE								
Engine Information				A10	A20	A40	A50	A70	C10 - C30	C20	E01	
All engines Qty: 4									1.970.627	C10		
				ENGINE								
2.0	Petrol	121	01/13->	PEXB, PEXL, PEY5, PEY7								
				ENGINE								
Engine Information				A10	A20	A40	A50	A70	C10 - C30	C20	E01	
All engines x 4, COIL ON PLUG									1.970.627	C10		
				ENGINE								
2.5	Petrol	138	12/12->	PYY1								
				ENGINE								
Engine Information				A10	A20	A40	A50	A70	C10 - C30	C20	E01	
All engines Qty: 4									1.970.627	C10		
				ENGINE								
2.5	Petrol	140	03/18->	PYZC								
				ENGINE								
Engine Information				A10	A20	A40	A50	A70	C10 - C30	C20	E01	
All engines x 4, Vehicle Equipment:for vehicles with cylinder shutdown, Vehicle Equipment:for vehicles without cylinder shutdown, COIL ON PLUG									1.970.627	C10		
				ENGINE								
2.5	Petrol	141	12/12->	PYY1, PYY3, PY-Y8, PY-ZA								
				ENGINE								
Engine Information				A10	A20	A40	A50	A70	C10 - C30	C20	E01	
All engines x 4, COIL ON PLUG									1.970.627	C10		
				ENGINE								
2.5	Petrol	143	03/18->	PYZ8, PYZC								
				ENGINE								
Engine Information				A10	A20	A40	A50	A70	C10 - C30	C20	E01	
All engines x 4, +brake energy recovery, -brake energy recovery, COIL ON PLUG									1.970.627	C10		

A10 CONDENSER	A20 CONTACT SET	A40 DISTRIBUTOR CAP	A50 ROTOR	A70 PICK-UP
C10 COIL	C20 IGNITION MODULE	C30 ELECTRONIC IGNITION KIT	E01 IGNITION CABLE SET	

Vehicle	alim.	kW	Date	Engine	FUNCTIONS ON THE VEHICLE									
					A10	A20	A40	A50	A70	C10 - C30	C20	E01		
ENGINE														
2.5	Petrol	170	03/18->	PYZ4										
ENGINE														
Engine	Information			A10	A20	A40	A50	A70	C10 - C30	C20	E01			
All engines	LHD, x 4, Vehicle Equipment:for vehicles with cylinder shutdown, Vehicle Equipment:for vehicles without cylinder shutdown, COIL ON PLUG RHD, x 4, +brake energy recovery, -brake energy recovery, COIL ON PLUG								1.970.627	C10				
626 III														
ENGINE														
1.6	Petrol	59	11/82-09/87	F6										
ENGINE														
Engine	Information			A10	A20	A40	A50	A70	C10 - C30	C20	E01			
All engines	version Mitsubishi					1.331.109								
ENGINE														
2.0	Petrol	68	01/85-01/90	FE (8V)										
ENGINE														
Engine	Information			A10	A20	A40	A50	A70	C10 - C30	C20	E01			
All engines	version Mitsubishi					1.331.109								
ENGINE														
2.0	Petrol	74	03/83-09/87	FE (8V)										
ENGINE														
Engine	Information			A10	A20	A40	A50	A70	C10 - C30	C20	E01			
All engines	version Mitsubishi					1.331.109								
ENGINE														
2.0	Petrol	88	01/86-09/87	FE (8V)										
ENGINE														
Engine	Information			A10	A20	A40	A50	A70	C10 - C30	C20	E01			
All engines	version Mitsubishi					1.331.109								
626 IV														
ENGINE														
1.8	Petrol	65	09/87-05/92	F8 (12V)										
ENGINE														
Engine	Information			A10	A20	A40	A50	A70	C10 - C30	C20	E01			
All engines	version Mitsubishi, no specific info conc. application available					1.331.125, 1.331.132	1.431.108							
ENGINE														
1.8	Petrol	69	11/87-05/92	F8 (12V)										
ENGINE														
Engine	Information			A10	A20	A40	A50	A70	C10 - C30	C20	E01			
All engines	version Mitsubishi, no specific info conc. application available					1.331.125, 1.331.132	1.431.108							
ENGINE														
2.0	Petrol	66	09/87-10/90	FE (12V), FE (8V)										
ENGINE														
Engine	Information			A10	A20	A40	A50	A70	C10 - C30	C20	E01			
All engines	-catalytic converter, version Mitsubishi					1.331.125								
All engines	+catalytic converter, version Mitsubishi					1.331.132	1.431.108							
ENGINE														
2.0 12V	Petrol	79	09/87-05/92	FE (12V)										
ENGINE														
Engine	Information			A10	A20	A40	A50	A70	C10 - C30	C20	E01			
All engines	-catalytic converter, version Mitsubishi					1.331.125								
All engines	+catalytic converter, version Mitsubishi					1.331.132								
All engines	super unlead (95), version Mitsubishi						1.431.108							
ENGINE														
2.0 16V	Petrol	103	11/87-05/92	FE (16V)										
ENGINE														
Engine	Information			A10	A20	A40	A50	A70	C10 - C30	C20	E01			
All engines	version Mitsubishi					1.331.121								
ENGINE														
2.0 16V	Petrol	109	06/87-09/89	FE (16V)										
ENGINE														
Engine	Information			A10	A20	A40	A50	A70	C10 - C30	C20	E01			
All engines	version Mitsubishi					1.331.121								
ENGINE														
2.2 12V	Petrol	85	11/87-04/92	F2										
ENGINE														
Engine	Information			A10	A20	A40	A50	A70	C10 - C30	C20	E01			
All engines	4WD, version Mitsubishi					1.331.121	1.431.108							
All engines	version Mitsubishi					1.331.125								
ENGINE														
2.2 12V 4WD	Petrol	85	11/87-07/90	F2										
ENGINE														
Engine	Information			A10	A20	A40	A50	A70	C10 - C30	C20	E01			
All engines	4WD, version Mitsubishi					1.331.121	1.431.108							
ENGINE														
A10	CONDENSER		A20	CONTACT SET		A40	DISTRIBUTOR CAP		A50	ROTOR		A70	PICK-UP	
C10	COIL		C20	IGNITION MODULE		C30	ELECTRONIC IGNITION KIT		E01	IGNITION CABLE SET				









				FUNCTIONS ON THE VEHICLE								
Vehicle	alim.	kW	Date	Engine								
				ENGINE								
2.2 12V 4WD	Petrol	85	11/87-07/90	F2								
Engine	Information			A10	A20	A40	A50	A70	C10 - C30	C20	E01	
All engines	version Mitsubishi					1.331.125						
				626 V								
				ENGINE								
1.8	Petrol	66	08/94-04/97	FP01LP								
Engine	Information			A10	A20	A40	A50	A70	C10 - C30	C20	E01	
All engines	version Hitachi, no specific info conc. application available					1.322.077, 1.322.092	1.422.094, 1.422.102					
All engines	version Mitsubishi, no specific info conc. application available						1.431.132, 1.431.137					
All engines											1.500.884	
				ENGINE								
1.8	Petrol	77	08/91-04/97	FP								
Engine	Information			A10	A20	A40	A50	A70	C10 - C30	C20	E01	
All engines	version Hitachi, no specific info conc. application available					1.322.077, 1.322.092	1.422.094, 1.422.102					
All engines	version Mitsubishi, no specific info conc. application available						1.431.132, 1.431.137					
All engines											1.500.884	
				ENGINE								
1.8 i	Petrol	66	08/94-04/97	--								
Engine	Information			A10	A20	A40	A50	A70	C10 - C30	C20	E01	
All engines	version Hitachi, no specific info conc. application available					1.322.077, 1.322.092	1.422.094, 1.422.102					
All engines	version Mitsubishi, no specific info conc. application available						1.431.132, 1.431.137					
All engines											1.500.884	
				ENGINE								
1.8 i	Petrol	77	08/91-04/97	FP								
Engine	Information			A10	A20	A40	A50	A70	C10 - C30	C20	E01	
All engines	version Hitachi, no specific info conc. application available					1.322.077, 1.322.092	1.422.094, 1.422.102					
All engines	version Mitsubishi, no specific info conc. application available						1.431.132, 1.431.137					
All engines											1.500.884	
				ENGINE								
1.8 i	Petrol	78	05/94-06/97	FP								
Engine	Information			A10	A20	A40	A50	A70	C10 - C30	C20	E01	
All engines	version Hitachi, no specific info conc. application available					1.322.077, 1.322.092	1.422.094, 1.422.102					
All engines	version Mitsubishi, no specific info conc. application available						1.431.132, 1.431.137					
All engines											1.500.884	
				ENGINE								
2.0 i	Petrol	85	08/91-04/97	FS								
Engine	Information			A10	A20	A40	A50	A70	C10 - C30	C20	E01	
All engines	->year 30/04/94, version Hitachi					1.322.077	1.422.094					
All engines	01/05/94 ->, version Hitachi					1.322.092	1.422.102					
All engines	01/05/94 ->, version Mitsubishi						1.431.132					
All engines	->year 30/04/94, version Mitsubishi						1.431.137					
All engines											1.500.884	
				ENGINE								
2.0 i 4WD	Petrol	85	04/92-04/97	FS								
Engine	Information			A10	A20	A40	A50	A70	C10 - C30	C20	E01	
All engines	->year 30/04/94, version Hitachi					1.322.077	1.422.094					
All engines	01/05/94 ->, version Hitachi					1.322.092	1.422.102					
All engines	01/05/94 ->, version Mitsubishi						1.431.132					
All engines	->year 30/04/94, version Mitsubishi						1.431.137					
All engines											1.500.884	
				ENGINE								
2.5 24V	Petrol	120	08/94-04/97	KL								
Engine	Information			A10	A20	A40	A50	A70	C10 - C30	C20	E01	
All engines	version Mitsubishi					1.331.149	1.431.134					
All engines	->ch. 498325										1.501.760	

A10 CONDENSER	A20 CONTACT SET	A40 DISTRIBUTOR CAP	A50 ROTOR	A70 PICK-UP
C10 COIL	C20 IGNITION MODULE	C30 ELECTRONIC IGNITION KIT	E01 IGNITION CABLE SET	

Vehicle	alim.	kW	Date	Engine	FUNCTIONS ON THE VEHICLE									
					A10	A20	A40	A50	A70	C10 - C30	C20	E01		
ENGINE														
2.5 24V	Petrol	121	01/92-04/97	KL										
Engine	Information				A10	A20	A40	A50	A70	C10 - C30	C20	E01		
All engines	version Mitsubishi						1.331.137	1.431.133						
All engines													1.501.760	
626 VI														
ENGINE														
1.8	Petrol	66	05/97-01/00	FPY3										
Engine	Information				A10	A20	A40	A50	A70	C10 - C30	C20	E01		
All engines										1.970.135	C10		1.501.739	
ENGINE														
1.8	Petrol	74	12/99-10/02	FP, FP9A										
Engine	Information				A10	A20	A40	A50	A70	C10 - C30	C20	E01		
All engines										1.970.135	C10			
All engines	->ch. 211589												1.501.739	
ENGINE														
2.0	Petrol	100	04/98-10/02	FS2C										
Engine	Information				A10	A20	A40	A50	A70	C10 - C30	C20	E01		
All engines	->ch. 211589												1.501.739	
ENGINE														
2.0	Petrol	85	05/97-10/02	FS										
Engine	Information				A10	A20	A40	A50	A70	C10 - C30	C20	E01		
All engines										1.970.135, 1.970.312	C10			
All engines	->ch. 211589												1.501.739	
ENGINE														
2.0 H.P.	Petrol	100	02/98-10/02	FS2C										
Engine	Information				A10	A20	A40	A50	A70	C10 - C30	C20	E01		
All engines	->ch. 211589												1.501.739	
929 I														
ENGINE														
2.0	Petrol	66	05/79-07/86	MA										
Engine	Information				A10	A20	A40	A50	A70	C10 - C30	C20	E01		
All engines	version Mitsubishi					1.231.084	1.331.003/00	1.431.023						
929 II														
ENGINE														
2.0	Petrol	74	03/84-07/87	FE (8V)										
Engine	Information				A10	A20	A40	A50	A70	C10 - C30	C20	E01		
All engines	version Mitsubishi						1.331.109	1.431.023						
929 III														
ENGINE														
2.0	Petrol	85	06/87-05/89	FE (8V), FEFA										
Engine	Information				A10	A20	A40	A50	A70	C10 - C30	C20	E01		
All engines	version Mitsubishi						1.331.132	1.431.108						
ENGINE														
2.2 12V	Petrol	85	01/88-04/89	F2, F21, F2E										
Engine	Information				A10	A20	A40	A50	A70	C10 - C30	C20	E01		
All engines	->ch. 102442, version Mitsubishi						1.331.117							
All engines	ch. 102442 ->, version Mitsubishi						1.331.132							
All engines	version Mitsubishi							1.431.108						
ENGINE														
2.2i	Petrol	100	05/87-12/88	F2-EG1										
Engine	Information				A10	A20	A40	A50	A70	C10 - C30	C20	E01		
All engines	->ch. 102442, version Mitsubishi						1.331.117							
All engines	ch. 102442 ->, version Mitsubishi						1.331.132							
All engines	version Mitsubishi							1.431.108						
ENGINE														
2.2i 12v	Petrol	100	06/89-09/92	F2E6, F2E7										
Engine	Information				A10	A20	A40	A50	A70	C10 - C30	C20	E01		
All engines	version Mitsubishi						1.331.132	1.431.108						

A10 CONDENSER	A20 CONTACT SET	A40 DISTRIBUTOR CAP	A50 ROTOR	A70 PICK-UP
C10 COIL	C20 IGNITION MODULE	C30 ELECTRONIC IGNITION KIT	E01 IGNITION CABLE SET	

The present application list is a brief version. For the detailed information about the possibility of installation on a specific vehicle, please refer to our web-catalogue <http://catalogo.facet.eu/>

					FUNCTIONS ON THE VEHICLE							
Vehicle	alim.	kW	Date	Engine	 A10	 A20	 A40	 A50	 A70	 C10 - C30	 C20	 E01
B-SERIE												
2.2 4WD	Petrol	60	02/99-11/06	ENGINE R5A2								
Engine	Information				A10	A20	A40	A50	A70	C10 - C30	C20	E01
All engines	version Mitsubishi						1.331.121					
BT-50												
2.2	Petrol	73	10/06-06/13	ENGINE --								
Engine	Information				A10	A20	A40	A50	A70	C10 - C30	C20	E01
All engines	version Mitsubishi						1.331.121					
2.2	Petrol	75	09/06->	ENGINE F2E								
Engine	Information				A10	A20	A40	A50	A70	C10 - C30	C20	E01
All engines	version Mitsubishi						1.331.121					
2.6	Petrol	90	10/06-06/13	ENGINE G6Y1								
Engine	Information				A10	A20	A40	A50	A70	C10 - C30	C20	E01
All engines	version Mitsubishi						1.331.121					
2.6	Petrol	92	10/06-12/15	ENGINE G6Y1								
Engine	Information				A10	A20	A40	A50	A70	C10 - C30	C20	E01
All engines	version Mitsubishi						1.331.121					
2.6	Petrol	99	09/06->	ENGINE G6								
Engine	Information				A10	A20	A40	A50	A70	C10 - C30	C20	E01
All engines	version Mitsubishi						1.331.121					
CX-3												
2.0 SKYACTIV-G	Petrol	110	05/18->	ENGINE PEXB								
Engine	Information				A10	A20	A40	A50	A70	C10 - C30	C20	E01
All engines	x 4, COIL ON PLUG									1.970.627	C10	
2.0 SKYACTIV-G	Petrol	88	05/15->	ENGINE PEX3, PEXB								
Engine	Information				A10	A20	A40	A50	A70	C10 - C30	C20	E01
All engines	x 4, COIL ON PLUG									1.970.627	C10	
2.0 SKYACTIV-G	Petrol	89	02/18->	ENGINE PEXB, PEXT								
Engine	Information				A10	A20	A40	A50	A70	C10 - C30	C20	E01
All engines	x 4, COIL ON PLUG									1.970.627	C10	
2.0 SKYACTIV-G AWD	Petrol	110	05/15->	ENGINE PEX3, PEXB, PEXT								
Engine	Information				A10	A20	A40	A50	A70	C10 - C30	C20	E01
All engines	x 4, COIL ON PLUG									1.970.627	C10	
CX-30												
e-SKYACTIV-X M Hybrid	Petrol/ Electric	137	06/21->	ENGINE HFY7								
Engine	Information				A10	A20	A40	A50	A70	C10 - C30	C20	E01
All engines	x 4, Vehicle Equipment:for vehicles with cylinder shutdown, COIL ON PLUG									1.970.627	C10	
e-SKYACTIV-X M Hybrid AWD	Petrol/ Electric	137	06/21->	ENGINE HFY7								
Engine	Information				A10	A20	A40	A50	A70	C10 - C30	C20	E01
All engines	x 4, Vehicle Equipment:for vehicles with cylinder shutdown, COIL ON PLUG									1.970.627	C10	
SKYACTIV-G M Hybrid	Petrol/ Electric	110	01/20->	ENGINE PEXW								
Engine	Information				A10	A20	A40	A50	A70	C10 - C30	C20	E01
All engines	x 4, COIL ON PLUG									1.970.627	C10	

A10 CONDENSER	A20 CONTACT SET	A40 DISTRIBUTOR CAP	A50 ROTOR	A70 PICK-UP
C10 COIL	C20 IGNITION MODULE	C30 ELECTRONIC IGNITION KIT	E01 IGNITION CABLE SET	

Vehicle	alim.	kW	Date	Engine	FUNCTIONS ON THE VEHICLE							
					A10	A20	A40	A50	A70	C10 - C30	C20	E01
ENGINE												
SKYACTIV-G M Hybrid	Petrol/ Electric	90	07/19->	PEXN								
Engine	Information				A10	A20	A40	A50	A70	C10 - C30	C20	E01
All engines	x 4, Vehicle Equipment:for vehicles with cylinder shutdown, COIL ON PLUG									1.970.627	C10	
ENGINE												
SKYACTIV-G M Hybrid AWD	Petrol/ Electric	110	01/20->	PEXW								
Engine	Information				A10	A20	A40	A50	A70	C10 - C30	C20	E01
All engines	x 4, COIL ON PLUG									1.970.627	C10	
ENGINE												
SKYACTIV-G M Hybrid AWD	Petrol/ Electric	90	07/19->	PEXN								
Engine	Information				A10	A20	A40	A50	A70	C10 - C30	C20	E01
All engines	x 4, Vehicle Equipment:for vehicles with cylinder shutdown, COIL ON PLUG									1.970.627	C10	
ENGINE												
SKYACTIV-X M Hybrid	Petrol/ Electric	132	07/19->	HFY1								
Engine	Information				A10	A20	A40	A50	A70	C10 - C30	C20	E01
All engines	x 4, Vehicle Equipment:for vehicles with cylinder shutdown, COIL ON PLUG									1.970.627	C10	
ENGINE												
SKYACTIV-X M Hybrid AWD	Petrol/ Electric	132	07/19->	HFY1								
Engine	Information				A10	A20	A40	A50	A70	C10 - C30	C20	E01
All engines	x 4, Vehicle Equipment:for vehicles with cylinder shutdown, COIL ON PLUG									1.970.627	C10	
CX-5												
2.0	Petrol	110	02/12->	PEXB, PEXP, PEYS								
Engine	Information				A10	A20	A40	A50	A70	C10 - C30	C20	E01
All engines	x 4, COIL ON PLUG									1.970.627	C10	
ENGINE												
2.0	Petrol	114	07/12->	PEY4, PEY5								
Engine	Information				A10	A20	A40	A50	A70	C10 - C30	C20	E01
All engines	Qty: 4									1.970.627	C10	
All engines	x 4, COIL ON PLUG									1.970.627	C10	
ENGINE												
2.0	Petrol	115	01/12->	PE-VPS, PEY7								
Engine	Information				A10	A20	A40	A50	A70	C10 - C30	C20	E01
Eng. PE-VPS	Qty: 4									1.970.627	C10	
Eng. PEY7	x 4, COIL ON PLUG									1.970.627	C10	
ENGINE												
2.0	Petrol	121	11/11->	PEX3, PEXB, PEXP, PEY6, PEY7								
Engine	Information				A10	A20	A40	A50	A70	C10 - C30	C20	E01
All engines	LHD, x 4, COIL ON PLUG, x 4, +brake energy recovery, -brake energy recovery, COIL ON PLUG ----- RHD, x 4, COIL ON PLUG									1.970.627	C10	
ENGINE												
2.0 AWD	Petrol	110	02/12->	PEXB, PEXP, PEYS								
Engine	Information				A10	A20	A40	A50	A70	C10 - C30	C20	E01
All engines	x 4, COIL ON PLUG									1.970.627	C10	
ENGINE												
2.0 AWD	Petrol	113	02/12->	PEY4, PEY5								
Engine	Information				A10	A20	A40	A50	A70	C10 - C30	C20	E01
All engines	Qty: 4									1.970.627	C10	
All engines	x 4, COIL ON PLUG									1.970.627	C10	
ENGINE												
2.0 AWD	Petrol	114	07/12->	PEY4, PEY5								
Engine	Information				A10	A20	A40	A50	A70	C10 - C30	C20	E01
All engines	Qty: 4									1.970.627	C10	

A10 CONDENSER	A20 CONTACT SET	A40 DISTRIBUTOR CAP	A50 ROTOR	A70 PICK-UP
C10 COIL	C20 IGNITION MODULE	C30 ELECTRONIC IGNITION KIT	E01 IGNITION CABLE SET	

The present application list is a brief version. For the detailed information about the possibility of installation on a specific vehicle, please refer to our web-catalogue <http://catalogo.facet.eu/>

Vehicle	alim.	kW	Date	Engine	FUNCTIONS ON THE VEHICLE							
					A10	A20	A40	A50	A70	C10 - C30	C20	E01
ENGINE												
2.0 AWD	Petrol	115	01/12->	PE-VPS, PEY7								
Engine	Information				A10	A20	A40	A50	A70	C10 - C30	C20	E01
Eng. PE-VPS	Qty: 4									1.970.627	C10	
Eng. PEY7	x 4, COIL ON PLUG									1.970.627	C10	
ENGINE												
2.0 AWD	Petrol	118	11/11->	PEX3, PEY6, PEY7								
Engine	Information				A10	A20	A40	A50	A70	C10 - C30	C20	E01
All engines	x 4, +brake energy recovery, -brake energy recovery, COIL ON PLUG, COIL ON PLUG									1.970.627	C10	
ENGINE												
2.0 AWD	Petrol	121	06/18->	PEXB, PEXP								
Engine	Information				A10	A20	A40	A50	A70	C10 - C30	C20	E01
All engines	x 4, COIL ON PLUG									1.970.627	C10	
ENGINE												
2.0 SKYACTIV-G	Petrol	120	03/18->	PEXB, PEXP								
Engine	Information				A10	A20	A40	A50	A70	C10 - C30	C20	E01
All engines	x 4, COIL ON PLUG									1.970.627	C10	
ENGINE												
2.0 SKYACTIV-G AWD	Petrol	120	03/18->	PEXB, PEXP								
Engine	Information				A10	A20	A40	A50	A70	C10 - C30	C20	E01
All engines	x 4, COIL ON PLUG									1.970.627	C10	
ENGINE												
2.5	Petrol	138	02/13->	PY-VPS								
Engine	Information				A10	A20	A40	A50	A70	C10 - C30	C20	E01
All engines	Qty: 4									1.970.627	C10	
ENGINE												
2.5	Petrol	141	03/15->	PYY1								
Engine	Information				A10	A20	A40	A50	A70	C10 - C30	C20	E01
All engines	Qty: 4									1.970.627	C10	
ENGINE												
2.5	Petrol	143	05/17->	PYZ8, PYZC								
Engine	Information				A10	A20	A40	A50	A70	C10 - C30	C20	E01
All engines	x 4, Vehicle Equipment:for vehicles with cylinder shut-down, Vehicle Equipment:for vehicles without cylinder shutdown, COIL ON PLUG									1.970.627	C10	
ENGINE												
2.5 4WD	Petrol	135	07/14->	PY-VPS								
Engine	Information				A10	A20	A40	A50	A70	C10 - C30	C20	E01
All engines	Qty: 4									1.970.627	C10	
ENGINE												
2.5 AWD	Petrol	141	02/15-02/17	PYY1								
Engine	Information				A10	A20	A40	A50	A70	C10 - C30	C20	E01
All engines	x 4, COIL ON PLUG									1.970.627	C10	
ENGINE												
2.5 AWD	Petrol	143	05/17->	PY-Y8, PYZ8, PY-ZA, PYZC								
Engine	Information				A10	A20	A40	A50	A70	C10 - C30	C20	E01
All engines	x 4, +brake energy recovery, -brake energy recovery, COIL ON PLUG									1.970.627	C10	
ENGINE												
SKYACTIV-G	Petrol	121	04/15-02/17	PEY7								
Engine	Information				A10	A20	A40	A50	A70	C10 - C30	C20	E01
All engines	x 4, COIL ON PLUG									1.970.627	C10	
ENGINE												
SKYACTIV-G AWD	Petrol	118	04/15-02/17	PEY7								
Engine	Information				A10	A20	A40	A50	A70	C10 - C30	C20	E01
All engines	x 4, COIL ON PLUG									1.970.627	C10	
ENGINE												
SKYACTIV-G AWD	Petrol	141	04/15-02/17	PYY1								
Engine	Information				A10	A20	A40	A50	A70	C10 - C30	C20	E01
All engines	x 4, COIL ON PLUG									1.970.627	C10	

A10 CONDENSER	A20 CONTACT SET	A40 DISTRIBUTOR CAP	A50 ROTOR	A70 PICK-UP
C10 COIL	C20 IGNITION MODULE	C30 ELECTRONIC IGNITION KIT	E01 IGNITION CABLE SET	

Vehicle	alim.	kW	Date	Engine	FUNCTIONS ON THE VEHICLE							
					A10	A20	A40	A50	A70	C10 - C30	C20	E01
CX-9												
2.5 T AWD	Petrol	170	06/16->	PY24								
ENGINE												
Engine	Information				A10	A20	A40	A50	A70	C10 - C30	C20	E01
All engines	x 4, COIL ON PLUG									1.970.627	C10	
DEMIO												
1.3 16V	Petrol	46	08/98-07/03	B3 ME								
ENGINE												
Engine	Information				A10	A20	A40	A50	A70	C10 - C30	C20	E01
All engines	version Mitsubishi						1.331.150	1.431.132				
1.5 16V												
1.5 16V	Petrol	55	04/00-07/03	B5 E								
ENGINE												
Engine	Information				A10	A20	A40	A50	A70	C10 - C30	C20	E01
All engines	version Mitsubishi						1.331.150	1.431.132				
E												
E2000 4WD												
E2000 4WD	Petrol	60	10/88-09/89	FEBN								
ENGINE												
Engine	Information				A10	A20	A40	A50	A70	C10 - C30	C20	E01
All engines	version Mitsubishi						1.331.132	1.431.108				
E2000												
2.0	Petrol	60	10/89-05/95	FEBN								
ENGINE												
Engine	Information				A10	A20	A40	A50	A70	C10 - C30	C20	E01
All engines	version Mitsubishi						1.331.132	1.431.108				
2.0i 12v												
2.0i 12v	Petrol	71	04/97->	FERW, FEY9								
ENGINE												
Engine	Information				A10	A20	A40	A50	A70	C10 - C30	C20	E01
All engines	version Mitsubishi						1.331.121					
All engines										1.970.3665	C10	
2.0i 12v 4x4												
2.0i 12v 4x4	Petrol	71	09/90-08/99	FEJM, FEY9								
ENGINE												
Engine	Information				A10	A20	A40	A50	A70	C10 - C30	C20	E01
All engines	version Mitsubishi						1.331.121					
All engines										1.970.3665	C10	
MIATA												
1.6i 16v												
1.6i 16v	Petrol	85	03/90-08/93	CE16I								
ENGINE												
Engine	Information				A10	A20	A40	A50	A70	C10 - C30	C20	E01
All engines												1.501.745
1.6i 16v GT												
1.6i 16v GT	Petrol	95	11/90-08/93	CE16T								
ENGINE												
Engine	Information				A10	A20	A40	A50	A70	C10 - C30	C20	E01
All engines												1.501.745
1.8i [USA]												
1.8i [USA]	Petrol	0	01/94->	--								
ENGINE												
Engine	Information				A10	A20	A40	A50	A70	C10 - C30	C20	E01
All engines												1.501.745
MPV I												
3.0												
3.0	Petrol	112	09/88-12/91	JE94								
ENGINE												
Engine	Information				A10	A20	A40	A50	A70	C10 - C30	C20	E01
All engines	version Mitsubishi							1.431.134				
3.0 i V6												
3.0 i V6	Petrol	109	11/89-09/99	JE94								
ENGINE												
Engine	Information				A10	A20	A40	A50	A70	C10 - C30	C20	E01
All engines	version Mitsubishi							1.431.134				
3.0 i V6												
3.0 i V6	Petrol	113	11/88-05/99	JE94								
ENGINE												
Engine	Information				A10	A20	A40	A50	A70	C10 - C30	C20	E01
All engines	version Mitsubishi							1.431.134				

A10 CONDENSER	A20 CONTACT SET	A40 DISTRIBUTOR CAP	A50 ROTOR	A70 PICK-UP
C10 COIL	C20 IGNITION MODULE	C30 ELECTRONIC IGNITION KIT	E01 IGNITION CABLE SET	

The present application list is a brief version. For the detailed information about the possibility of installation on a specific vehicle, please refer to our web-catalogue <http://catalogo.facet.eu/>

Vehicle	alim.	kW	Date	Engine	FUNCTIONS ON THE VEHICLE							
					A10	A20	A40	A50	A70	C10 - C30	C20	E01

MPV II

				ENGINE
2.0	Petrol	90	09/99-08/00	FS-DS

Engine	Information	A10	A20	A40	A50	A70	C10 - C30	C20	E01
All engines									1.501.767

				ENGINE
2.3	Petrol	104	07/02-02/06	L3

Engine	Information	A10	A20	A40	A50	A70	C10 - C30	C20	E01
All engines									1.499.245

MX-3

				ENGINE
1.6	Petrol	66	05/91-10/93	B69

Engine	Information	A10	A20	A40	A50	A70	C10 - C30	C20	E01
All engines	version Mitsubishi			1.331.121					
All engines							1.970.233	C10	

				ENGINE
1.6 i	Petrol	79	11/93-09/98	B6D

Engine	Information	A10	A20	A40	A50	A70	C10 - C30	C20	E01
All engines	version Mitsubishi			1.331.150	1.431.132				
All engines									1.501.231

				ENGINE
1.8 i V6	Petrol	95	01/94-10/97	K838

Engine	Information	A10	A20	A40	A50	A70	C10 - C30	C20	E01
All engines	version Mitsubishi			1.331.149	1.431.134				
All engines									1.501.760

				ENGINE
1.8 i V6	Petrol	98	01/92-01/94	K819

Engine	Information	A10	A20	A40	A50	A70	C10 - C30	C20	E01
All engines	version Mitsubishi			1.331.137	1.431.133				

				ENGINE
1.8 i V6	Petrol	99	01/96-10/97	K8-ZE

Engine	Information	A10	A20	A40	A50	A70	C10 - C30	C20	E01
All engines	version Mitsubishi			1.331.149	1.431.134				
All engines									1.501.760

MX-5 I

				ENGINE
1.6	Petrol	66	01/95-04/98	8AN1

Engine	Information	A10	A20	A40	A50	A70	C10 - C30	C20	E01
All engines									1.501.745

				ENGINE
1.6	Petrol	85	05/90-01/94	B64F

Engine	Information	A10	A20	A40	A50	A70	C10 - C30	C20	E01
All engines	ch. 118792 ->								1.501.745

				ENGINE
1.8	Petrol	96	01/93-04/98	BPF1

Engine	Information	A10	A20	A40	A50	A70	C10 - C30	C20	E01
All engines									1.501.745

MX-5 II

				ENGINE
1.6 16V	Petrol	81	05/98-10/05	B6D

Engine	Information	A10	A20	A40	A50	A70	C10 - C30	C20	E01
All engines									1.501.745

				ENGINE
1.8	Petrol	103	01/98-07/02	BPD

Engine	Information	A10	A20	A40	A50	A70	C10 - C30	C20	E01
All engines									1.501.745

				ENGINE
1.8	Petrol	107	08/02-10/05	BP6J

Engine	Information	A10	A20	A40	A50	A70	C10 - C30	C20	E01
All engines									1.501.745

A10 CONDENSER	A20 CONTACT SET	A40 DISTRIBUTOR CAP	A50 ROTOR	A70 PICK-UP
C10 COIL	C20 IGNITION MODULE	C30 ELECTRONIC IGNITION KIT	E01 IGNITION CABLE SET	

Vehicle	alim.	kW	Date	Engine	FUNCTIONS ON THE VEHICLE							
					A10	A20	A40	A50	A70	C10 - C30	C20	E01

ENGINE				
1.8 16V	Petrol	102	11/00-10/05	BPD

Engine	Information	A10	A20	A40	A50	A70	C10 - C30	C20	E01
All engines									1.501.745

ENGINE				
1.8 16V	Petrol	103	05/98-10/05	BP-ZE

Engine	Information	A10	A20	A40	A50	A70	C10 - C30	C20	E01
All engines									1.501.745

ENGINE				
1.8 16V	Petrol	107	11/00-10/05	BPD, BP-ZE

Engine	Information	A10	A20	A40	A50	A70	C10 - C30	C20	E01
All engines									1.501.745

MX-5 IV

ENGINE				
1.5	Petrol	96	06/15->	P5-VPR, P5Z1

Engine	Information	A10	A20	A40	A50	A70	C10 - C30	C20	E01
All engines	x 4, COIL ON PLUG						1.970.627	C10	

ENGINE				
1.5	Petrol	97	05/18->	P5X1

Engine	Information	A10	A20	A40	A50	A70	C10 - C30	C20	E01
All engines	x 4, COIL ON PLUG						1.970.627	C10	

ENGINE				
2.0	Petrol	118	06/15->	PEX4, PEX6

Engine	Information	A10	A20	A40	A50	A70	C10 - C30	C20	E01
All engines	x 4, COIL ON PLUG						1.970.627	C10	

ENGINE				
2.0	Petrol	135	05/18->	PEXF

Engine	Information	A10	A20	A40	A50	A70	C10 - C30	C20	E01
All engines	x 4, COIL ON PLUG						1.970.627	C10	

MX-6

ENGINE				
2.0	Petrol	85	02/92-02/97	FS

Engine	Information	A10	A20	A40	A50	A70	C10 - C30	C20	E01
All engines	->year 30/04/94, version Hitachi			1.322.077	1.422.094				
All engines	01/05/94 ->, version Hitachi			1.322.092	1.422.102				
All engines	01/05/94 ->, version Mitsubishi				1.431.132				
All engines									1.500.884

ENGINE				
2.5 24V	Petrol	121	02/92-09/97	KL

Engine	Information	A10	A20	A40	A50	A70	C10 - C30	C20	E01
All engines	->year 30/04/94, version Mitsubishi			1.331.137	1.431.133				
All engines	01/05/94 ->, version Mitsubishi			1.331.149	1.431.134				
All engines	->ch. 498325								1.501.760

ENGINE				
2.5 24V	Petrol	123	02/93-11/95	KL

Engine	Information	A10	A20	A40	A50	A70	C10 - C30	C20	E01
All engines	->year 30/04/94, version Mitsubishi			1.331.137	1.431.133				
All engines	01/05/94 ->, version Mitsubishi			1.331.149	1.431.134				
All engines	->ch. 498325								1.501.760

ENGINE				
2.5 i 24V	Petrol	120	08/94-02/97	KL

Engine	Information	A10	A20	A40	A50	A70	C10 - C30	C20	E01
All engines	version Mitsubishi			1.331.149	1.431.134				
All engines	->ch. 498325								1.501.760

NAVAJO

ENGINE				
4.0i [USA]	Petrol	0	01/91->	--

Engine	Information	A10	A20	A40	A50	A70	C10 - C30	C20	E01
All engines							1.970.289	C10	

A10	CONDENSER	A20	CONTACT SET	A40	DISTRIBUTOR CAP	A50	ROTOR	A70	PICK-UP
C10	COIL	C20	IGNITION MODULE	C30	ELECTRONIC IGNITION KIT	E01	IGNITION CABLE SET		

					FUNCTIONS ON THE VEHICLE							
Vehicle	alim.	kW	Date	Engine								

PREMACY

				ENGINE
1.9	Petrol	74	07/99-03/05	FP

Engine	Information	A10	A20	A40	A50	A70	C10 - C30	C20	E01
All engines									1.501.767

				ENGINE
1.9	Petrol	84	07/99-03/05	FP

Engine	Information	A10	A20	A40	A50	A70	C10 - C30	C20	E01
All engines									1.501.767

PROTEGE

				ENGINE
1.6i [USA]	Petrol	0	06/98->	--

Engine	Information	A10	A20	A40	A50	A70	C10 - C30	C20	E01
All engines									1.501.729

				ENGINE
1.8i [USA]	Petrol	0	06/98->	--

Engine	Information	A10	A20	A40	A50	A70	C10 - C30	C20	E01
All engines									1.501.740

				ENGINE
1.8i DOHC [USA]	Petrol	0	01/90->	--

Engine	Information	A10	A20	A40	A50	A70	C10 - C30	C20	E01
All engines	version Mitsubishi			1.331.121					
All engines							1.970.233	C10	

				ENGINE
1.8i OHC [USA]	Petrol	0	01/90->	--

Engine	Information	A10	A20	A40	A50	A70	C10 - C30	C20	E01
All engines	version Mitsubishi			1.331.121					
All engines							1.970.233	C10	1.501.398

TRIBUTE

				ENGINE
2.0	Petrol	91	03/00-05/08	0L65(396CUV8)

Engine	Information	A10	A20	A40	A50	A70	C10 - C30	C20	E01
All engines	x 1, D.I.S.						1.970.532	C10	

				ENGINE
2.0 4WD	Petrol	91	03/00-05/08	1L33(425CUV8)

Engine	Information	A10	A20	A40	A50	A70	C10 - C30	C20	E01
All engines	x 1, D.I.S.						1.970.532	C10	

				ENGINE
2.0i [USA]	Petrol	91	05/00->	B

Engine	Information	A10	A20	A40	A50	A70	C10 - C30	C20	E01
All engines							1.970.532	C10	

				ENGINE
2.0i 4x4 [USA]	Petrol	91	05/00->	B

Engine	Information	A10	A20	A40	A50	A70	C10 - C30	C20	E01
All engines							1.970.532	C10	

				ENGINE
2.3 AWD	Petrol	110	04/04-05/08	L3-VE

Engine	Information	A10	A20	A40	A50	A70	C10 - C30	C20	E01
All engines	x 4, COIL ON PLUG						1.970.480	C10	

				ENGINE
2.3 GX	Petrol	110	12/03-10/04	L3-VE

Engine	Information	A10	A20	A40	A50	A70	C10 - C30	C20	E01
All engines	x 4, COIL ON PLUG						1.970.480	C10	

XEDOS 6

				ENGINE
1.6 16V	Petrol	79	04/94-10/99	B6 (DOHC)







Engine	Information	A10	A20	A40	A50	A70	C10 - C30	C20	E01
All engines	->eng. 210758								1.501.231

A10 CONDENSER	A20 CONTACT SET	A40 DISTRIBUTOR CAP	A50 ROTOR	A70 PICK-UP
C10 COIL	C20 IGNITION MODULE	C30 ELECTRONIC IGNITION KIT	E01 IGNITION CABLE SET	

Vehicle	alim.	kW	Date	Engine	FUNCTIONS ON THE VEHICLE									
					A10	A20	A40	A50	A70	C10 - C30	C20	E01		
ENGINE														
1.6 16V	Petrol	83	01/92-03/94	B69										
ENGINE														
All engines														1.501.231
ENGINE														
2.0 V6	Petrol	103	06/94-10/99	KF1										
ENGINE														
All engines														1.501.760
ENGINE														
2.0 V6	Petrol	106	01/92-05/94	KF1										
ENGINE														
All engines														1.501.760
XEDOS 9														
ENGINE														
2.0	Petrol	118	08/98-08/00	KF										
ENGINE														
All engines							1.331.149	1.431.134						
All engines														1.501.760
ENGINE														
2.0 24V	Petrol	105	08/93-01/00	KF										
ENGINE														
All engines							1.331.149	1.431.134						
All engines														1.501.760
ENGINE														
2.5 24V	Petrol	123	07/93-07/00	KL										
ENGINE														
All engines							1.331.149	1.431.134						
All engines														1.501.760
ENGINE														
2.5 V6	Petrol	120	07/00-09/02	KL										
ENGINE														
All engines							1.331.149	1.431.134						

A10	CONDENSER	A20	CONTACT SET	A40	DISTRIBUTOR CAP	A50	ROTOR	A70	PICK-UP
C10	COIL	C20	IGNITION MODULE	C30	ELECTRONIC IGNITION KIT	E01	IGNITION CABLE SET		

The present application list is a brief version. For the detailed information about the possibility of installation on a specific vehicle, please refer to our web-catalogue <http://catalogo.facet.eu/>

				FUNCTIONS ON THE VEHICLE								
Vehicle	alim.	kW	Date	Engine	 A10	 A20	 A40	 A50	 A70	 C10 - C30	 C20	 E01
/8												
200	Petrol	70	01/68-01/77	ENGINE M 115.923, M 115.926								
Engine	Information				A10	A20	A40	A50	A70	C10 - C30	C20	E01
All engines								1.406.021R				
230.6												
Petrol	88	01/68-11/76	ENGINE M 180.954									
Engine	Information				A10	A20	A40	A50	A70	C10 - C30	C20	E01
All engines						1.206.029HV		1.406.018R				
250												
Petrol	85	01/68-08/72	ENGINE M 114.920									
Engine	Information				A10	A20	A40	A50	A70	C10 - C30	C20	E01
All engines						1.206.029HV		1.406.018R				
250												
Petrol	96	07/68-08/72	ENGINE M 114.920									
Engine	Information				A10	A20	A40	A50	A70	C10 - C30	C20	E01
All engines						1.206.029HV		1.406.018R				
250 2.8												
Petrol	96	06/72-11/76	ENGINE M 130.923									
Engine	Information				A10	A20	A40	A50	A70	C10 - C30	C20	E01
All engines								1.406.018R				
250 C												
Petrol	96	04/69-06/72	ENGINE M 114.920									
Engine	Information				A10	A20	A40	A50	A70	C10 - C30	C20	E01
All engines						1.206.029HV		1.406.018R				
250 C 2.8												
Petrol	96	06/72-11/76	ENGINE M 130.923									
Engine	Information				A10	A20	A40	A50	A70	C10 - C30	C20	E01
All engines								1.406.018R				
250 CE												
Petrol	110	04/69-04/72	ENGINE M 114.980									
Engine	Information				A10	A20	A40	A50	A70	C10 - C30	C20	E01
All engines						1.206.029HV						
280												
Petrol	118	06/72-11/76	ENGINE M 110.921									
Engine	Information				A10	A20	A40	A50	A70	C10 - C30	C20	E01
All engines						1.206.029HV, 1.206.062						
280 C												
Petrol	118	06/72-02/77	ENGINE M 110.921									
Engine	Information				A10	A20	A40	A50	A70	C10 - C30	C20	E01
All engines						1.206.029HV, 1.206.062						
280 CE												
Petrol	136	06/72-01/77	ENGINE M 110.981									
Engine	Information				A10	A20	A40	A50	A70	C10 - C30	C20	E01
All engines						1.206.062						
280 E												
Petrol	136	06/72-11/76	ENGINE M 110.981									
Engine	Information				A10	A20	A40	A50	A70	C10 - C30	C20	E01
All engines						1.206.062						
123												
280 CE												
Petrol	136	03/77-11/85	ENGINE M 110.988									
Engine	Information				A10	A20	A40	A50	A70	C10 - C30	C20	E01
All engines	version Bosch						1.306.123	1.406.060R				
All engines												1.501.323
124												
200 CE												
Petrol	90	09/89-06/93	ENGINE M 102.963									
Engine	Information				A10	A20	A40	A50	A70	C10 - C30	C20	E01
All engines	-catalytic converter, version Bosch						1.306.108	1.406.055R				

A10 CONDENSER	A20 CONTACT SET	A40 DISTRIBUTOR CAP	A50 ROTOR	A70 PICK-UP
C10 COIL	C20 IGNITION MODULE	C30 ELECTRONIC IGNITION KIT	E01 IGNITION CABLE SET	

Vehicle	alim.	kW	Date	Engine	FUNCTIONS ON THE VEHICLE							
					A10	A20	A40	A50	A70	C10 - C30	C20	E01

124

ENGINE				
200 CE	Petrol	90	09/89-06/93	M 102.963

Engine	Information	A10	A20	A40	A50	A70	C10 - C30	C20	E01
All engines	+catalytic converter, version Bosch			1.306.234	1.406.121R				
All engines	+catalytic converter						1.970.178	C10	
All engines	-catalytic converter						1.970.180	C10	
All engines									1.501.654

ENGINE				
220 CE	Petrol	110	10/92-05/93	M 111.960

Engine	Information	A10	A20	A40	A50	A70	C10 - C30	C20	E01
All engines	Qty: 2						1.970.317	C10	

ENGINE				
230 CE	Petrol	100	03/87-12/92	M 102.982

Engine	Information	A10	A20	A40	A50	A70	C10 - C30	C20	E01
All engines	-catalytic converter, version Bosch			1.306.108	1.406.055R				
All engines	+catalytic converter, version Bosch			1.306.234	1.406.121R				
All engines	+catalytic converter						1.970.178	C10	
All engines	-catalytic converter						1.970.180	C10	
All engines									1.501.654

ENGINE				
230 CE	Petrol	97	03/87-12/92	M 102.982

Engine	Information	A10	A20	A40	A50	A70	C10 - C30	C20	E01
All engines	-catalytic converter, version Bosch			1.306.108	1.406.055R				
All engines	+catalytic converter, version Bosch			1.306.234	1.406.121R				
All engines	+catalytic converter						1.970.178	C10	
All engines	-catalytic converter						1.970.180	C10	
All engines									1.501.654

ENGINE				
230 CE Cat	Petrol	97	06/89-12/92	M 102.982

Engine	Information	A10	A20	A40	A50	A70	C10 - C30	C20	E01
All engines	-catalytic converter, version Bosch			1.306.108	1.406.055R				
All engines	+catalytic converter, version Bosch			1.306.234	1.406.121R				
All engines	+catalytic converter						1.970.178	C10	
All engines	-catalytic converter						1.970.180	C10	
All engines									1.501.654

ENGINE				
300 CE	Petrol	132	03/87-05/93	M 103.983

Engine	Information	A10	A20	A40	A50	A70	C10 - C30	C20	E01
All engines	version Bosch			1.306.237	1.406.125R				
All engines							1.970.178	C10	1.501.657

ENGINE				
300 CE	Petrol	138	03/87-12/89	M 103.983

Engine	Information	A10	A20	A40	A50	A70	C10 - C30	C20	E01
All engines	version Bosch			1.306.237	1.406.125R				
All engines							1.970.178	C10	

ENGINE				
300 CE-24	Petrol	162	09/89-06/93	M 104.980

Engine	Information	A10	A20	A40	A50	A70	C10 - C30	C20	E01
All engines							1.970.179	C10	

ENGINE				
300 CE-24	Petrol	170	09/89-06/93	M 104.980

Engine	Information	A10	A20	A40	A50	A70	C10 - C30	C20	E01
All engines							1.970.179	C10	

ENGINE				
320 CE	Petrol	162	10/92-05/93	M 104.992

Engine	Information	A10	A20	A40	A50	A70	C10 - C30	C20	E01
All engines	Qty: 3, without spark plug connector						1.970.316	C10	
All engines	incl. spark plug connector, Qty: 3						1.970.316K	C10	

A10 CONDENSER	A20 CONTACT SET	A40 DISTRIBUTOR CAP	A50 ROTOR	A70 PICK-UP
C10 COIL	C20 IGNITION MODULE	C30 ELECTRONIC IGNITION KIT	E01 IGNITION CABLE SET	

The present application list is a brief version. For the detailed information about the possibility of installation on a specific vehicle, please refer to our web-catalogue <http://catalogo.facet.eu/>







					FUNCTIONS ON THE VEHICLE							
Vehicle	alim.	kW	Date	Engine	 A10	 A20	 A40	 A50	 A70	 C10 - C30	 C20	 E01
190												
2.0	Petrol	66	10/82-10/84	ENGINE M 102.921								
Engine	Information				A10	A20	A40	A50	A70	C10 - C30	C20	E01
All engines	version Bosch						1.306.108	1.406.055R				
All engines										1.970.180	C10	
2.0												
2.0	Petrol	75	01/86-05/90	ENGINE M 102.924								
Engine	Information				A10	A20	A40	A50	A70	C10 - C30	C20	E01
All engines	version Bosch						1.306.108					
All engines	-catalytic converter, version Bosch							1.406.055R				
All engines	+catalytic converter, version Bosch							1.406.121R				
All engines	+catalytic converter									1.970.178	C10	
All engines	-catalytic converter									1.970.180	C10	
All engines												1.501.654
2.0												
2.0	Petrol	77	08/83-05/90	ENGINE M 102.924								
Engine	Information				A10	A20	A40	A50	A70	C10 - C30	C20	E01
All engines	version Bosch						1.306.108					
All engines	-catalytic converter, version Bosch							1.406.055R				
All engines	+catalytic converter, version Bosch							1.406.121R				
All engines	+catalytic converter									1.970.178	C10	
All engines	-catalytic converter									1.970.180	C10	
All engines												1.501.654
2.3												
2.3	Petrol	97	09/87-09/88	ENGINE M 102.985								
Engine	Information				A10	A20	A40	A50	A70	C10 - C30	C20	E01
All engines	-catalytic converter, version Bosch						1.306.108	1.406.055R				
All engines	+catalytic converter, version Bosch						1.306.234	1.406.121R				
All engines	+catalytic converter									1.970.178	C10	
All engines	-catalytic converter									1.970.180	C10	
All engines												1.501.300
2.3 E												
2.3 E	Petrol	100	10/82-09/88	ENGINE M 102.985								
Engine	Information				A10	A20	A40	A50	A70	C10 - C30	C20	E01
All engines	-catalytic converter, version Bosch						1.306.108	1.406.055R				
All engines	+catalytic converter, version Bosch						1.306.234	1.406.121R				
All engines	+catalytic converter									1.970.178	C10	
All engines	-catalytic converter									1.970.180	C10	
All engines												1.501.300
2.6												
2.6	Petrol	118	10/82-09/88	ENGINE M 103.942								
Engine	Information				A10	A20	A40	A50	A70	C10 - C30	C20	E01
All engines	version Bosch						1.306.237	1.406.125R				
All engines										1.970.178	C10	
E 1.8												
E 1.8	Petrol	77	01/92-12/93	ENGINE M 102.919								
Engine	Information				A10	A20	A40	A50	A70	C10 - C30	C20	E01
All engines	version Bosch						1.306.234	1.406.121R				
All engines										1.970.178	C10	1.501.300
E 1.8												
E 1.8	Petrol	80	04/90-08/93	ENGINE M 102.910								
Engine	Information				A10	A20	A40	A50	A70	C10 - C30	C20	E01
All engines	version Bosch						1.306.234	1.406.121R				
All engines										1.970.178	C10	1.501.300
E 2.0												
E 2.0	Petrol	83	02/85-12/86	ENGINE M 102.962								
Engine	Information				A10	A20	A40	A50	A70	C10 - C30	C20	E01
All engines	-catalytic converter, version Bosch						1.306.108	1.406.055R				
All engines	+catalytic converter, version Bosch						1.306.234	1.406.121R				
All engines	+catalytic converter									1.970.178	C10	
All engines	-catalytic converter									1.970.180	C10	

A10 CONDENSER	A20 CONTACT SET	A40 DISTRIBUTOR CAP	A50 ROTOR	A70 PICK-UP
C10 COIL	C20 IGNITION MODULE	C30 ELECTRONIC IGNITION KIT	E01 IGNITION CABLE SET	

Vehicle	alim.	kW	Date	Engine	FUNCTIONS ON THE VEHICLE									
					A10	A20	A40	A50	A70	C10 - C30	C20	E01		
E2.0					ENGINE									
	Petrol	83	02/85-12/86	M 102.962										
Engine	Information				A10	A20	A40	A50	A70	C10 - C30	C20	E01		
All engines	01/01/90 ->													1.501.300
E2.0					ENGINE									
	Petrol	85	02/85-12/86	M 102.962										
Engine	Information				A10	A20	A40	A50	A70	C10 - C30	C20	E01		
All engines	-catalytic converter, version Bosch						1.306.108	1.406.055R						
All engines	+catalytic converter, version Bosch						1.306.234	1.406.121R						
All engines	+catalytic converter									1.970.178	C10			
All engines	-catalytic converter									1.970.180	C10			
All engines	01/01/90 ->													1.501.300
E2.0					ENGINE									
	Petrol	87	01/85-08/93	M 102.962										
Engine	Information				A10	A20	A40	A50	A70	C10 - C30	C20	E01		
All engines	-catalytic converter, version Bosch						1.306.108	1.406.055R						
All engines	+catalytic converter, version Bosch						1.306.234	1.406.121R						
All engines	+catalytic converter									1.970.178	C10			
All engines	-catalytic converter									1.970.180	C10			
All engines	01/01/90 ->													1.501.300
E2.0					ENGINE									
	Petrol	90	10/82-06/93	M 102.962										
Engine	Information				A10	A20	A40	A50	A70	C10 - C30	C20	E01		
All engines	-catalytic converter, version Bosch						1.306.108	1.406.055R						
All engines	+catalytic converter, version Bosch						1.306.234	1.406.121R						
All engines	+catalytic converter									1.970.178	C10			
All engines	-catalytic converter									1.970.180	C10			
All engines	01/01/90 ->													1.501.300
E2.3					ENGINE									
	Petrol	100	10/86-08/93	M 102.985										
Engine	Information				A10	A20	A40	A50	A70	C10 - C30	C20	E01		
All engines	-catalytic converter, version Bosch						1.306.108	1.406.055R						
All engines	+catalytic converter, version Bosch						1.306.234	1.406.121R						
All engines	+catalytic converter									1.970.178	C10			
All engines	-catalytic converter									1.970.180	C10			
All engines	01/01/90 ->													1.501.300
E2.3					ENGINE									
	Petrol	97	09/86-08/91	M 102.985										
Engine	Information				A10	A20	A40	A50	A70	C10 - C30	C20	E01		
All engines	-catalytic converter, version Bosch						1.306.108	1.406.055R						
All engines	+catalytic converter, version Bosch						1.306.234	1.406.121R						
All engines	+catalytic converter									1.970.178	C10			
All engines	-catalytic converter									1.970.180	C10			
All engines	01/01/90 ->													1.501.300
E2.3-16					ENGINE									
	Petrol	125	09/85-12/87	M 102.983										
Engine	Information				A10	A20	A40	A50	A70	C10 - C30	C20	E01		
All engines	version Bosch						1.306.234	1.406.121R						
All engines										1.970.178	C10			
E2.3-16					ENGINE									
	Petrol	130	09/85-08/88	M 102.983										
Engine	Information				A10	A20	A40	A50	A70	C10 - C30	C20	E01		
All engines	version Bosch						1.306.234	1.406.121R						
All engines										1.970.178	C10			
E2.3-16					ENGINE									
	Petrol	136	04/84-01/87	M 102.983										
Engine	Information				A10	A20	A40	A50	A70	C10 - C30	C20	E01		
All engines	version Bosch						1.306.234	1.406.121R						
All engines										1.970.178	C10			









A10	CONDENSER	A20	CONTACT SET	A40	DISTRIBUTOR CAP	A50	ROTOR	A70	PICK-UP
C10	COIL	C20	IGNITION MODULE	C30	ELECTRONIC IGNITION KIT	E01	IGNITION CABLE SET		

The present application list is a brief version. For the detailed information about the possibility of installation on a specific vehicle, please refer to our web-catalogue <http://catalogo.facet.eu/>

				FUNCTIONS ON THE VEHICLE								
Vehicle	alim.	kW	Date	Engine								
				ENGINE								
E 2.5-16	Petrol	150	09/88-08/93	M 102.990								
Engine	Information			A10	A20	A40	A50	A70	C10 - C30	C20	E01	
All engines	version Bosch					1.306.234	1.406.121R					
All engines									1.970.178	C10		
				ENGINE								
E 2.5-16 Evolution	Petrol	143	03/89-08/93	M 102.991								
Engine	Information			A10	A20	A40	A50	A70	C10 - C30	C20	E01	
All engines	version Bosch					1.306.234	1.406.121R					
All engines									1.970.178	C10		
				ENGINE								
E 2.5-16 Evolution II	Petrol	173	05/90-08/93	M 102.992								
Engine	Information			A10	A20	A40	A50	A70	C10 - C30	C20	E01	
All engines	version Bosch					1.306.234						
All engines									1.970.178	C10		
				ENGINE								
E 2.6	Petrol	118	09/86-08/93	M 103.942								
Engine	Information			A10	A20	A40	A50	A70	C10 - C30	C20	E01	
All engines	version Bosch					1.306.237	1.406.125R					
All engines									1.970.178	C10		
				ENGINE								
E 2.6	Petrol	122	09/86-12/89	M 103.942								
Engine	Information			A10	A20	A40	A50	A70	C10 - C30	C20	E01	
All engines	version Bosch					1.306.237	1.406.125R					
All engines									1.970.178	C10		
				ENGINE								
E 3.2 AMG	Petrol	132	01/88->	M 103.983								
Engine	Information			A10	A20	A40	A50	A70	C10 - C30	C20	E01	
All engines	version Bosch					1.306.237	1.406.125R					
All engines									1.970.178	C10		
				CITAN								
				ENGINE								
112	Petrol	84	06/13-08/21	M 200.711								
Engine	Information			A10	A20	A40	A50	A70	C10 - C30	C20	E01	
All engines	x 4, COIL ON PLUG								1.970.613	C10		
				CLASSE A II								
				ENGINE								
A 150	Petrol	70	09/04-06/12	M 266.920								
Engine	Information			A10	A20	A40	A50	A70	C10 - C30	C20	E01	
All engines	x 2, COIL ON PLUG								1.970.417	C10		
All engines												1.499.234
				ENGINE								
A 160	Petrol	70	04/09-06/12	M 266.920								
Engine	Information			A10	A20	A40	A50	A70	C10 - C30	C20	E01	
All engines	x 2, COIL ON PLUG								1.970.417	C10		
All engines												1.499.234
				ENGINE								
A 170	Petrol	85	09/04-06/12	M 266.940								
Engine	Information			A10	A20	A40	A50	A70	C10 - C30	C20	E01	
All engines	x 2, COIL ON PLUG								1.970.417	C10		
All engines												1.499.234
				ENGINE								
A 180	Petrol	85	04/09-06/12	M 266.940								
Engine	Information			A10	A20	A40	A50	A70	C10 - C30	C20	E01	
All engines	x 2, COIL ON PLUG								1.970.417	C10		
All engines												1.499.234
				ENGINE								
A 200	Petrol	100	09/04-06/12	M 266.960								
Engine	Information			A10	A20	A40	A50	A70	C10 - C30	C20	E01	
All engines	x 2, COIL ON PLUG								1.970.417	C10		
All engines												1.499.234

A10 CONDENSER	A20 CONTACT SET	A40 DISTRIBUTOR CAP	A50 ROTOR	A70 PICK-UP
C10 COIL	C20 IGNITION MODULE	C30 ELECTRONIC IGNITION KIT	E01 IGNITION CABLE SET	

Vehicle	alim.	kW	Date	Engine	FUNCTIONS ON THE VEHICLE									
					A10	A20	A40	A50	A70	C10 - C30	C20	E01		
ENGINE														
A 200 TURBO	Petrol	142	09/05-06/12	M 266.980										
Engine	Information				A10	A20	A40	A50	A70	C10 - C30	C20	E01		
All engines	x 2, COIL ON PLUG									1.970.417	C10			
All engines													1.499.232	
CLASSE A III														
ENGINE														
A 160	Petrol	75	07/15-05/18	M 270.910										
Engine	Information				A10	A20	A40	A50	A70	C10 - C30	C20	E01		
All engines	x 4, without protection hose, COIL ON PLUG, FOR: (TJ)									1.970.626	C10			
ENGINE														
A 180	Petrol	90	09/12-05/18	M 270.910										
Engine	Information				A10	A20	A40	A50	A70	C10 - C30	C20	E01		
All engines	x 4, without protection hose, COIL ON PLUG, FOR: (TJ)									1.970.626	C10			
ENGINE														
A 200	Petrol	115	06/12-05/18	M 270.910										
Engine	Information				A10	A20	A40	A50	A70	C10 - C30	C20	E01		
All engines	x 4, without protection hose, COIL ON PLUG, FOR: (TJ)									1.970.626	C10			
ENGINE														
A 220 4-matic	Petrol	135	05/14-05/18	M 270.920										
Engine	Information				A10	A20	A40	A50	A70	C10 - C30	C20	E01		
All engines	x 4, version 1, without protection hose, COIL ON PLUG, DELPHI, FOR: (TJ), without protection hose, COIL ON PLUG									1.970.626	C10			
ENGINE														
A 250	Petrol	155	06/12-05/18	M 270.920										
Engine	Information				A10	A20	A40	A50	A70	C10 - C30	C20	E01		
All engines	x 4, version 1, without protection hose, COIL ON PLUG, DELPHI, FOR: (TJ), without protection hose, COIL ON PLUG									1.970.626	C10			
ENGINE														
A 250	Petrol	160	07/15-05/18	M 270.920										
Engine	Information				A10	A20	A40	A50	A70	C10 - C30	C20	E01		
All engines	x 4, version 1, without protection hose, COIL ON PLUG, DELPHI, FOR: (TJ), without protection hose, COIL ON PLUG									1.970.626	C10			
ENGINE														
A 250 4-matic	Petrol	155	06/13-05/18	M 270.920										
Engine	Information				A10	A20	A40	A50	A70	C10 - C30	C20	E01		
All engines	x 4, version 1, without protection hose, COIL ON PLUG, DELPHI, FOR: (TJ), without protection hose, COIL ON PLUG									1.970.626	C10			
ENGINE														
A 250 4-matic	Petrol	160	07/15-05/18	M 270.920										
Engine	Information				A10	A20	A40	A50	A70	C10 - C30	C20	E01		
All engines	x 4, version 1, without protection hose, COIL ON PLUG, DELPHI, FOR: (TJ), without protection hose, COIL ON PLUG									1.970.626	C10			
ENGINE														
A 45 AMG 4-matic	Petrol	265	06/13-05/18	M 133.980										
Engine	Information				A10	A20	A40	A50	A70	C10 - C30	C20	E01		
All engines	x 4, DELPHI, without protection hose, COIL ON PLUG									1.970.626	C10			
ENGINE														
AMG A 45 4-matic	Petrol	280	07/15-05/18	M 133.980										
Engine	Information				A10	A20	A40	A50	A70	C10 - C30	C20	E01		
All engines	x 4, DELPHI, without protection hose, COIL ON PLUG									1.970.626	C10			
CLASSE B I														
ENGINE														
B 150	Petrol	70	03/05-11/11	M 266.920										
Engine	Information				A10	A20	A40	A50	A70	C10 - C30	C20	E01		
All engines	x 2, COIL ON PLUG									1.970.417	C10			
All engines													1.499.234	
ENGINE														
B 160	Petrol	70	04/09-11/11	M 266.920										
Engine	Information				A10	A20	A40	A50	A70	C10 - C30	C20	E01		
All engines	x 2, COIL ON PLUG									1.970.417	C10			
All engines													1.499.234	
A10	CONDENSER		A20	CONTACT SET		A40	DISTRIBUTOR CAP		A50	ROTOR		A70	PICK-UP	
C10	COIL		C20	IGNITION MODULE		C30	ELECTRONIC IGNITION KIT		E01	IGNITION CABLE SET				

					FUNCTIONS ON THE VEHICLE												
Vehicle	alim.	kW	Date	Engine	 A10	 A20	 A40	 A50	 A70	 C10 - C30	 C20	 E01					
B 170																	
	Petrol	85	03/05-11/11	M 266.940													
ENGINE																	
Engine	Information			A10	A20	A40	A50	A70	C10 - C30		C20	E01					
All engines	x 2, COIL ON PLUG								1.970.417	C10							
All engines												1.499.234					
B 170 NGT																	
	Petrol/ Com- pressed Natural Gas (CNG)	85	04/08-11/11	M 266.960, M 266960NGT													
ENGINE																	
Engine	Information			A10	A20	A40	A50	A70	C10 - C30		C20	E01					
Eng. M 266.960	Qty: 2								1.970.417	C10							
Eng. M 266960NGT	x 2, COIL ON PLUG								1.970.417	C10							
Eng. M 266.960												1.499.234					
B 180																	
	Petrol	85	04/09-11/11	M 266.940													
ENGINE																	
Engine	Information			A10	A20	A40	A50	A70	C10 - C30		C20	E01					
All engines	x 2, COIL ON PLUG								1.970.417	C10							
All engines												1.499.234					
B 180 NGT																	
	Petrol/ Com- pressed Natural Gas (CNG)	85	04/08-11/11	M 266.960, M 266960NGT													
ENGINE																	
Engine	Information			A10	A20	A40	A50	A70	C10 - C30		C20	E01					
Eng. M 266.960	Qty: 2								1.970.417	C10							
Eng. M 266960NGT	x 2, COIL ON PLUG								1.970.417	C10							
Eng. M 266.960												1.499.234					
B 200																	
	Petrol	100	03/05-11/11	M 266.960													
ENGINE																	
Engine	Information			A10	A20	A40	A50	A70	C10 - C30		C20	E01					
All engines	x 2, COIL ON PLUG								1.970.417	C10							
All engines												1.499.234					
B 200 TURBO																	
	Petrol	142	03/05-11/11	M 266.980													
ENGINE																	
Engine	Information			A10	A20	A40	A50	A70	C10 - C30		C20	E01					
All engines	x 2, COIL ON PLUG								1.970.417	C10							
All engines												1.499.232					
CLASSE B II																	
B 160																	
	Petrol	75	07/15-12/18	M 270.910													
ENGINE																	
Engine	Information			A10	A20	A40	A50	A70	C10 - C30		C20	E01					
All engines	SA A701, MADE BY: (TJ), x 4, without protection hose, COIL ON PLUG, FOR: (TJ)								1.970.626	C10							
B 180																	
	Petrol	90	11/11-12/18	M 270.910													
ENGINE																	
Engine	Information			A10	A20	A40	A50	A70	C10 - C30		C20	E01					
All engines	MADE BY: (TJ), x 4, without protection hose, COIL ON PLUG, FOR: (TJ)								1.970.626	C10							
B 200																	
	Petrol	115	11/11-12/18	M 270.910													
ENGINE																	
Engine	Information			A10	A20	A40	A50	A70	C10 - C30		C20	E01					
All engines	MADE BY: (TJ), x 4, without protection hose, COIL ON PLUG, FOR: (TJ)								1.970.626	C10							
B 200 Natural Gas Drive / B 200 c																	
	Petrol/ Com- pressed Natural Gas (CNG)	115	11/12-12/17	M 270.920, M 270920NGT													
ENGINE																	
Engine	Information			A10	A20	A40	A50	A70	C10 - C30		C20	E01					
Eng. M 270.920	-protective sheath, Qty: 4								1.970.626	C10							
Eng. M 270920NGT	x 4, DELPHI, without protection hose, COIL ON PLUG								1.970.626	C10							
A10	CONDENSER	A20	CONTACT SET	A40	DISTRIBUTOR CAP	A50	ROTOR	A70	PICK-UP	C10	COIL	C20	IGNITION MODULE	C30	ELECTRONIC IGNITION KIT	E01	IGNITION CABLE SET

Vehicle	alim.	kW	Date	Engine	FUNCTIONS ON THE VEHICLE							
					A10	A20	A40	A50	A70	C10 - C30	C20	E01
B 220 4-matic Petrol 135 05/13-12/18 M 270.920					ENGINE							
Engine Information					A10	A20	A40	A50	A70	C10 - C30	C20	E01
All engines										1.970.626	C10	
B 250 Petrol 155 05/12-12/18 M 270.920					ENGINE							
Engine Information					A10	A20	A40	A50	A70	C10 - C30	C20	E01
All engines										1.970.626	C10	
B 250 4-matic Petrol 155 08/14-12/18 M 270.920					ENGINE							
Engine Information					A10	A20	A40	A50	A70	C10 - C30	C20	E01
All engines										1.970.626	C10	
CLASSE C I					ENGINE							
C 180 Petrol 89 11/94-05/00 M 111.921					ENGINE							
Engine Information					A10	A20	A40	A50	A70	C10 - C30	C20	E01
All engines										1.970.316	C10	
All engines										1.970.316K	C10	
C 180 Petrol 90 03/93-05/00 M 111.920, M 111.921					ENGINE							
Engine Information					A10	A20	A40	A50	A70	C10 - C30	C20	E01
Eng. M 111.921										1.970.316	C10	
Eng. M 111.921										1.970.316K	C10	
Eng. M 111.920										1.970.317	C10	
Eng. M 111.920												1.501.305
C 180 T Petrol 90 06/96-09/00 M 111.920, M 111.921					ENGINE							
Engine Information					A10	A20	A40	A50	A70	C10 - C30	C20	E01
Eng. M 111.921										1.970.316	C10	
Eng. M 111.921										1.970.316K	C10	
Eng. M 111.920										1.970.317	C10	
Eng. M 111.920												1.501.305
C 200 Petrol 100 01/94-05/00 M 111.941, M 111.945					ENGINE							
Engine Information					A10	A20	A40	A50	A70	C10 - C30	C20	E01
Eng. M 111.945										1.970.316	C10	
Eng. M 111.945										1.970.316K	C10	
Eng. M 111.941										1.970.317	C10	
Eng. M 111.941												1.501.305
C 200 Kompressor Petrol 132 10/95-05/00 M 111.944					ENGINE							
Engine Information					A10	A20	A40	A50	A70	C10 - C30	C20	E01
All engines										1.970.316	C10	
All engines										1.970.316K	C10	
C 200 Kompressor Petrol 141 11/96-05/00 M 111.944					ENGINE							
Engine Information					A10	A20	A40	A50	A70	C10 - C30	C20	E01
All engines										1.970.316	C10	
All engines										1.970.316K	C10	
C 200 T Petrol 100 06/96-03/01 M 111.941, M 111.945					ENGINE							
Engine Information					A10	A20	A40	A50	A70	C10 - C30	C20	E01
Eng. M 111.945										1.970.316	C10	
Eng. M 111.945										1.970.316K	C10	
Eng. M 111.941										1.970.317	C10	
Eng. M 111.941												1.501.305
C 200 T Kompressor Petrol 141 11/96-03/01 M 111.944					ENGINE							
Engine Information					A10	A20	A40	A50	A70	C10 - C30	C20	E01
All engines										1.970.316	C10	
All engines										1.970.316K	C10	

A10 CONDENSER	A20 CONTACT SET	A40 DISTRIBUTOR CAP	A50 ROTOR	A70 PICK-UP
C10 COIL	C20 IGNITION MODULE	C30 ELECTRONIC IGNITION KIT	E01 IGNITION CABLE SET	

The present application list is a brief version. For the detailed information about the possibility of installation on a specific vehicle, please refer to our web-catalogue <http://catalogo.facet.eu/>

					FUNCTIONS ON THE VEHICLE							
Vehicle	alim.	kW	Date	Engine	A10	A20	A40	A50	A70	C10 - C30	C20	E01
C220												
	Petrol	110	03/93-05/00	ENGINE M 111.961								
Engine	Information				A10	A20	A40	A50	A70	C10 - C30	C20	E01
All engines	Qty: 2									1.970.317	C10	
C230												
	Petrol	110	06/96-06/97	ENGINE M 111.974								
Engine	Information				A10	A20	A40	A50	A70	C10 - C30	C20	E01
All engines	Qty: 2, without spark plug connector									1.970.316	C10	
All engines	incl. spark plug connector, Qty: 2									1.970.316K	C10	
C230 Kompressor												
	Petrol	142	10/95-05/00	ENGINE M 111.975								
Engine	Information				A10	A20	A40	A50	A70	C10 - C30	C20	E01
All engines	Qty: 2, without spark plug connector									1.970.316	C10	
All engines	incl. spark plug connector, Qty: 2									1.970.316K	C10	
C230 T												
	Petrol	110	06/96-06/98	ENGINE M 111.974								
Engine	Information				A10	A20	A40	A50	A70	C10 - C30	C20	E01
All engines	Qty: 2, without spark plug connector									1.970.316	C10	
All engines	incl. spark plug connector, Qty: 2									1.970.316K	C10	
C230 T Kompressor												
	Petrol	142	06/97-09/00	ENGINE M 111.975								
Engine	Information				A10	A20	A40	A50	A70	C10 - C30	C20	E01
All engines	Qty: 2, without spark plug connector									1.970.316	C10	
All engines	incl. spark plug connector, Qty: 2									1.970.316K	C10	
C240												
	Petrol	125	06/97-05/00	ENGINE M 112.910								
Engine	Information				A10	A20	A40	A50	A70	C10 - C30	C20	E01
All engines	Qty: 6									1.970.417	C10	
All engines												1.501.649
C240 T												
	Petrol	125	06/97-03/01	ENGINE M 112.910, M 112.915								
Engine	Information				A10	A20	A40	A50	A70	C10 - C30	C20	E01
All engines	Qty: 6									1.970.417	C10	
All engines												1.501.649
C280												
	Petrol	142	05/93-05/00	ENGINE M 104.941								
Engine	Information				A10	A20	A40	A50	A70	C10 - C30	C20	E01
All engines	Qty: 3, without spark plug connector									1.970.316	C10	
All engines	incl. spark plug connector, Qty: 3									1.970.316K	C10	
C280												
	Petrol	145	06/97-05/00	ENGINE M 112.920								
Engine	Information				A10	A20	A40	A50	A70	C10 - C30	C20	E01
All engines	Qty: 6									1.970.417	C10	
All engines												1.501.649
C280 T												
	Petrol	145	06/97-03/01	ENGINE M 112.920								
Engine	Information				A10	A20	A40	A50	A70	C10 - C30	C20	E01
All engines	Qty: 6									1.970.417	C10	
All engines												1.501.649
C36 AMG												
	Petrol	206	05/94-05/00	ENGINE M 104.941 (AMG 3.6)								
Engine	Information				A10	A20	A40	A50	A70	C10 - C30	C20	E01
All engines	Qty: 3, without spark plug connector									1.970.316	C10	
All engines	incl. spark plug connector, Qty: 3									1.970.316K	C10	
C43 AMG												
	Petrol	225	08/97-03/01	ENGINE M 113.944								
Engine	Information				A10	A20	A40	A50	A70	C10 - C30	C20	E01
All engines	Qty: 8									1.970.417	C10	

A10 CONDENSER	A20 CONTACT SET	A40 DISTRIBUTOR CAP	A50 ROTOR	A70 PICK-UP
C10 COIL	C20 IGNITION MODULE	C30 ELECTRONIC IGNITION KIT	E01 IGNITION CABLE SET	

Vehicle	alim.	kW	Date	Engine	FUNCTIONS ON THE VEHICLE							
					A10	A20	A40	A50	A70	C10 - C30	C20	E01

CLASSE C II

				ENGINE
C 160 Kompressor	Petrol	90	05/02-05/08	M 271.921

Engine	Information	A10	A20	A40	A50	A70	C10 - C30	C20	E01
All engines	x 4, COIL ON PLUG						1.970.420	C10	

				ENGINE
C 180 Kompressor	Petrol	105	05/02-05/08	M 271.946

Engine	Information	A10	A20	A40	A50	A70	C10 - C30	C20	E01
All engines	->eng. 30853899 (+31019397), eng. type 30853900 (+30821903) ->, x 4, COIL ON PLUG, x 4, COIL ON PLUG						1.970.420	C10	

				ENGINE
C 200 CGI Kompressor	Petrol	125	03/03-05/08	M 271.942

Engine	Information	A10	A20	A40	A50	A70	C10 - C30	C20	E01
All engines	x 4, COIL ON PLUG						1.970.420	C10	

				ENGINE
C 200 Kompressor	Petrol	120	05/02-05/08	M 271.940

Engine	Information	A10	A20	A40	A50	A70	C10 - C30	C20	E01
All engines	x 4, COIL ON PLUG, x 4, COIL ON PLUG						1.970.420	C10	

				ENGINE
C 220	Petrol	120	05/02-05/08	M 271.948

Engine	Information	A10	A20	A40	A50	A70	C10 - C30	C20	E01
All engines	x 4, COIL ON PLUG						1.970.420	C10	

				ENGINE
C 230	Petrol	150	01/05-05/08	M 272.920

Engine	Information	A10	A20	A40	A50	A70	C10 - C30	C20	E01
All engines	x 6, COIL ON PLUG						1.970.487	C10	

				ENGINE
C 230 Kompressor	Petrol	141	05/02-05/08	M 271.948

Engine	Information	A10	A20	A40	A50	A70	C10 - C30	C20	E01
All engines	x 4, ->eng. 30853899, COIL ON PLUG, eng. type 30853900 ->, x 4, COIL ON PLUG, x 4, COIL ON PLUG						1.970.420	C10	

				ENGINE
C 240	Petrol	125	05/00-08/07	M 112.912

Engine	Information	A10	A20	A40	A50	A70	C10 - C30	C20	E01
All engines	x 6, COIL ON PLUG						1.970.417	C10	
All engines									1.501.649

				ENGINE
C 240 4-matic	Petrol	125	07/02-08/07	M 112.916

Engine	Information	A10	A20	A40	A50	A70	C10 - C30	C20	E01
All engines	x 6, COIL ON PLUG						1.970.417	C10	
All engines									1.501.649

				ENGINE
C 280	Petrol	170	01/05-08/07	M 272.940

Engine	Information	A10	A20	A40	A50	A70	C10 - C30	C20	E01
All engines	x 6, COIL ON PLUG						1.970.487	C10	

				ENGINE
C 280 4-matic	Petrol	170	01/05-08/07	M 272.941

Engine	Information	A10	A20	A40	A50	A70	C10 - C30	C20	E01
All engines	x 6, COIL ON PLUG						1.970.487	C10	

				ENGINE
C 32 AMG Kompressor	Petrol	260	02/01-08/07	M 112.961

Engine	Information	A10	A20	A40	A50	A70	C10 - C30	C20	E01
All engines	x 6, COIL ON PLUG						1.970.417	C10	
All engines									1.501.649

				ENGINE
C 320	Petrol	160	05/00-05/08	M 112.946

Engine	Information	A10	A20	A40	A50	A70	C10 - C30	C20	E01
All engines	x 6, COIL ON PLUG						1.970.417	C10	
All engines									1.501.649

A10 CONDENSER	A20 CONTACT SET	A40 DISTRIBUTOR CAP	A50 ROTOR	A70 PICK-UP
C10 COIL	C20 IGNITION MODULE	C30 ELECTRONIC IGNITION KIT	E01 IGNITION CABLE SET	

The present application list is a brief version. For the detailed information about the possibility of installation on a specific vehicle, please refer to our web-catalogue <http://catalogo.facet.eu/>

					FUNCTIONS ON THE VEHICLE												
Vehicle	alim.	kW	Date	Engine	A10	A20	A40	A50	A70	C10 - C30	C20	E01					
ENGINE																	
C 320 4-matic	Petrol	160	07/02-08/07	M 112.953													
Engine	Information				A10	A20	A40	A50	A70	C10 - C30	C20	E01					
All engines	x 6, COIL ON PLUG									1.970.417	C10						
All engines												1.501.649					
ENGINE																	
C 350	Petrol	200	01/05-05/08	M 272.960													
Engine	Information				A10	A20	A40	A50	A70	C10 - C30	C20	E01					
All engines	x 6, COIL ON PLUG									1.970.487	C10						
ENGINE																	
C 350 4-matic	Petrol	200	01/05-08/07	M 272.970													
Engine	Information				A10	A20	A40	A50	A70	C10 - C30	C20	E01					
All engines	x 6, COIL ON PLUG									1.970.487	C10						
ENGINE																	
C 55 AMG	Petrol	270	02/04-08/07	M 113.988													
Engine	Information				A10	A20	A40	A50	A70	C10 - C30	C20	E01					
All engines	x 8, COIL ON PLUG									1.970.417	C10						
CLASSE C III																	
ENGINE																	
C 180	Petrol	115	06/11->	M 271.820, M 274.910													
Engine	Information				A10	A20	A40	A50	A70	C10 - C30	C20	E01					
Eng. M 271.820	x 4, COIL ON PLUG									1.970.420	C10						
Eng. M 274.910	MADE BY: (TJ), x 4, DELPHI, without protection hose, x 4, COIL ON PLUG, without protection hose, COIL ON PLUG, FOR: (TJ), FOR: (TJ)									1.970.626	C10						
ENGINE																	
C 180 CGI	Petrol	115	01/07-08/14	M 271.820, M 271.952, M 274.910													
Engine	Information				A10	A20	A40	A50	A70	C10 - C30	C20	E01					
Eng. M 271.820, M 271.952	x 4, COIL ON PLUG									1.970.420	C10						
Eng. M 274.910	MADE BY: (TJ), x 4, DELPHI, x 4, without protection hose, COIL ON PLUG, FOR: (TJ)									1.970.626	C10						
ENGINE																	
C 180 Kompressor	Petrol	115	01/07-08/14	M 271.820, M 271.910, M 271.952													
Engine	Information				A10	A20	A40	A50	A70	C10 - C30	C20	E01					
All engines	x 4, COIL ON PLUG									1.970.420	C10						
ENGINE																	
C 200	Petrol	137	05/11-01/14	M 271.820													
Engine	Information				A10	A20	A40	A50	A70	C10 - C30	C20	E01					
All engines	x 4, COIL ON PLUG									1.970.420	C10						
ENGINE																	
C 200 CGI	Petrol	135	01/07->	M 271.820, M 271.860, M 271.950													
Engine	Information				A10	A20	A40	A50	A70	C10 - C30	C20	E01					
All engines	x 4, COIL ON PLUG									1.970.420	C10						
Eng. M 271.860	Qty: 4									1.970.420	C10						
ENGINE																	
C 200 Kompressor	Petrol	135	01/07-08/14	M 271.820, M 271.860, M 271.950													
Engine	Information				A10	A20	A40	A50	A70	C10 - C30	C20	E01					
All engines	x 4, COIL ON PLUG									1.970.420	C10						
ENGINE																	
C 230	Petrol	150	01/07-08/14	M 272.921													
Engine	Information				A10	A20	A40	A50	A70	C10 - C30	C20	E01					
All engines	x 6, COIL ON PLUG									1.970.487	C10						
ENGINE																	
C 230 4-matic	Petrol	150	07/07-01/14	M 272.911													
Engine	Information				A10	A20	A40	A50	A70	C10 - C30	C20	E01					
All engines	x 6, COIL ON PLUG									1.970.487	C10						
ENGINE																	
C 250	Petrol	150	01/07->	M 271.860, M 272.921													
Engine	Information				A10	A20	A40	A50	A70	C10 - C30	C20	E01					
Eng. M 271.860	x 4, COIL ON PLUG									1.970.420	C10						
A10	CONDENSER	A20	CONTACT SET	A40	DISTRIBUTOR CAP	A50	ROTOR	A70	PICK-UP	C10	COIL	C20	IGNITION MODULE	C30	ELECTRONIC IGNITION KIT	E01	IGNITION CABLE SET

Vehicle	alim.	kW	Date	Engine	FUNCTIONS ON THE VEHICLE									
					A10	A20	A40	A50	A70	C10 - C30	C20	E01		
C250														
	Petrol	150	01/07->	ENGINE M 271.860, M 272.921										
Engine	Information				A10	A20	A40	A50	A70	C10 - C30	C20	E01		
Eng. M 272.921	Qty: 6									1.970.487	C10			
Eng. M 272.921	x 6, COIL ON PLUG									1.970.487	C10			
C250 4-matic														
	Petrol	150	07/07->	ENGINE M 272.911										
Engine	Information				A10	A20	A40	A50	A70	C10 - C30	C20	E01		
All engines	Qty: 6									1.970.487	C10			
C250 CGI														
	Petrol	150	07/09-08/14	ENGINE M 271.860										
Engine	Information				A10	A20	A40	A50	A70	C10 - C30	C20	E01		
All engines	x 4, COIL ON PLUG									1.970.420	C10			
C280														
	Petrol	170	01/07-08/14	ENGINE M 272.947										
Engine	Information				A10	A20	A40	A50	A70	C10 - C30	C20	E01		
All engines	x 6, COIL ON PLUG									1.970.487	C10			
C280 4-matic														
	Petrol	170	07/07-01/14	ENGINE M 272.948										
Engine	Information				A10	A20	A40	A50	A70	C10 - C30	C20	E01		
All engines	x 6, COIL ON PLUG									1.970.487	C10			
C300														
	Petrol	170	08/07-08/14	ENGINE M 272.947										
Engine	Information				A10	A20	A40	A50	A70	C10 - C30	C20	E01		
All engines	x 6, COIL ON PLUG									1.970.487	C10			
C300 4-matic														
	Petrol	170	07/07-01/14	ENGINE M 272.948										
Engine	Information				A10	A20	A40	A50	A70	C10 - C30	C20	E01		
All engines	x 6, COIL ON PLUG									1.970.487	C10			
C350														
	Petrol	200	01/07-08/14	ENGINE M 272.961										
Engine	Information				A10	A20	A40	A50	A70	C10 - C30	C20	E01		
All engines	x 6, COIL ON PLUG									1.970.487	C10			
C350 4-matic														
	Petrol	200	07/07-01/14	ENGINE M 272.971										
Engine	Information				A10	A20	A40	A50	A70	C10 - C30	C20	E01		
All engines	x 6, COIL ON PLUG									1.970.487	C10			
CLASSE C IV														
C160														
	Petrol	95	04/15->	ENGINE M 274.910										
Engine	Information				A10	A20	A40	A50	A70	C10 - C30	C20	E01		
All engines	SA A701, x 4, DELPHI, x 4, without protection hose, COIL ON PLUG, FOR: (TJ)									1.970.626	C10			
C180														
	Petrol	110	10/18->	ENGINE M 274.910										
Engine	Information				A10	A20	A40	A50	A70	C10 - C30	C20	E01		
All engines	x 4, DELPHI, without protection hose, COIL ON PLUG, without protection hose, COIL ON PLUG, FOR: (TJ)									1.970.626	C10			
C180														
	Petrol	115	03/14->	ENGINE M 274.910										
Engine	Information				A10	A20	A40	A50	A70	C10 - C30	C20	E01		
All engines	MADE BY: (TJ), SA A701, SA A701/784K, x 4, DELPHI, MADE BY: (TJ), x 4, without protection hose, x 4, COIL ON PLUG, without protection hose, COIL ON PLUG, FOR: (TJ), FOR: (TJ)									1.970.626	C10			
C200														
	Petrol	135	12/13-08/18	ENGINE M 274.920										
Engine	Information				A10	A20	A40	A50	A70	C10 - C30	C20	E01		
All engines	MADE BY: (TJ), SA A701, x 4, DELPHI, MADE BY: (TJ), without protection hose, x 4, COIL ON PLUG, without protection hose, x 4, COIL ON PLUG, FOR: (TJ), without protection hose, COIL ON PLUG, FOR: (TJ), FOR: (TJ)									1.970.626	C10			

A10 CONDENSER	A20 CONTACT SET	A40 DISTRIBUTOR CAP	A50 ROTOR	A70 PICK-UP
C10 COIL	C20 IGNITION MODULE	C30 ELECTRONIC IGNITION KIT	E01 IGNITION CABLE SET	

The present application list is a brief version. For the detailed information about the possibility of installation on a specific vehicle, please refer to our web-catalogue <http://catalogo.facet.eu/>

Vehicle	alim.	kW	Date	Engine	FUNCTIONS ON THE VEHICLE							
					A10	A20	A40	A50	A70	C10 - C30	C20	E01

ENGINE				
C200 4-matic	Petrol	135	04/15-08/18	M 274.920

Engine	Information	A10	A20	A40	A50	A70	C10 - C30	C20	E01
All engines	SA A701/784K, x 4, DELPHI, MADE BY: (TJ), without protection hose, COIL ON PLUG, without protection hose, x 4, COIL ON PLUG, FOR: (TJ), without protection hose, COIL ON PLUG, FOR: (TJ)						1.970.626	C10	

ENGINE				
C250	Petrol	155	03/14-05/18	M 274.920

Engine	Information	A10	A20	A40	A50	A70	C10 - C30	C20	E01
All engines	MADE BY: (TJ), SA A701/784K, x 4, DELPHI, without protection hose, x 4, COIL ON PLUG, without protection hose, COIL ON PLUG, FOR: (TJ), FOR: (TJ)						1.970.626	C10	

ENGINE				
C300	Petrol	180	09/15-12/18	M 274.920

Engine	Information	A10	A20	A40	A50	A70	C10 - C30	C20	E01
All engines	SA A701/784K, x 4, DELPHI, without protection hose, x 4, COIL ON PLUG, without protection hose, COIL ON PLUG, FOR: (TJ), FOR: (TJ)						1.970.626	C10	

ENGINE				
C300 4-matic	Petrol	180	12/13-08/18	M 274.920

Engine	Information	A10	A20	A40	A50	A70	C10 - C30	C20	E01
All engines	SA A701/784K, x 4, DELPHI, MADE BY: (TJ), without protection hose, x 4, COIL ON PLUG, without protection hose, COIL ON PLUG, FOR: (TJ)						1.970.626	C10	

ENGINE				
C300 e	Petrol/ Electric	155	07/19->	M 274.920

Engine	Information	A10	A20	A40	A50	A70	C10 - C30	C20	E01
All engines	x 4, DELPHI, without protection hose, COIL ON PLUG, without protection hose, COIL ON PLUG, FOR: (TJ)						1.970.626	C10	

ENGINE				
C300 e	Petrol/ Electric	235	07/19->	M 274.920

Engine	Information	A10	A20	A40	A50	A70	C10 - C30	C20	E01
All engines	x 4, DELPHI, without protection hose, COIL ON PLUG, without protection hose, COIL ON PLUG, FOR: (TJ)						1.970.626	C10	

ENGINE				
C300 e 4-matic	Petrol/ Electric	155	07/19->	M 274.920

Engine	Information	A10	A20	A40	A50	A70	C10 - C30	C20	E01
All engines	x 4, DELPHI, without protection hose, COIL ON PLUG, without protection hose, COIL ON PLUG, FOR: (TJ)						1.970.626	C10	

ENGINE				
C350 e	Petrol/ Electric	155	02/15-08/18	M 274.920

Engine	Information	A10	A20	A40	A50	A70	C10 - C30	C20	E01
All engines	MADE BY: (TJ), x 4, DELPHI, x 4, without protection hose, COIL ON PLUG, FOR: (TJ)						1.970.626	C10	

ENGINE				
C350 e	Petrol/ Electric	205	02/15-08/18	M 274.920

Engine	Information	A10	A20	A40	A50	A70	C10 - C30	C20	E01
All engines	MADE BY: (TJ), x 4, DELPHI, x 4, without protection hose, COIL ON PLUG, FOR: (TJ)						1.970.626	C10	

CLASSE CLA

ENGINE				
AMG CLA 45 4-matic	Petrol	280	07/15-03/19	M 133.980

Engine	Information	A10	A20	A40	A50	A70	C10 - C30	C20	E01
All engines	x 4, DELPHI, without protection hose, COIL ON PLUG						1.970.626	C10	

ENGINE				
CLA 180	Petrol	90	01/13-03/19	M 270.910

Engine	Information	A10	A20	A40	A50	A70	C10 - C30	C20	E01
All engines	MADE BY: (TJ), x 4, without protection hose, COIL ON PLUG, FOR: (TJ)						1.970.626	C10	

ENGINE				
CLA 200	Petrol	110	07/18-03/19	M 270.910

Engine	Information	A10	A20	A40	A50	A70	C10 - C30	C20	E01
All engines	x 4, without protection hose, COIL ON PLUG, FOR: (TJ)						1.970.626	C10	

A10 CONDENSER	A20 CONTACT SET	A40 DISTRIBUTOR CAP	A50 ROTOR	A70 PICK-UP
C10 COIL	C20 IGNITION MODULE	C30 ELECTRONIC IGNITION KIT	E01 IGNITION CABLE SET	

Vehicle	alim.	kW	Date	Engine	FUNCTIONS ON THE VEHICLE									
					A10	A20	A40	A50	A70	C10 - C30	C20	E01		
ENGINE														
CLA 200	Petrol	115	01/13-03/19	M 270.910										
Engine	Information				A10	A20	A40	A50	A70	C10 - C30	C20	E01		
All engines	MADE BY: (TJ), x 4, without protection hose, x 4, COIL ON PLUG, without protection hose, COIL ON PLUG, FOR: (TJ), FOR: (TJ)									1.970.626	C10			
ENGINE														
CLA 220 4-matic	Petrol	135	01/15->	M 270.910, M 270.920										
Engine	Information				A10	A20	A40	A50	A70	C10 - C30	C20	E01		
Eng. M 270.910	MADE BY: (TJ), Qty: 4									1.970.626	C10			
Eng. M 270.920	SA A701, x 4, DELPHI, without protection hose, x 4, COIL ON PLUG, without protection hose, COIL ON PLUG, FOR: (TJ), FOR: (TJ)									1.970.626	C10			
ENGINE														
CLA 250	Petrol	155	01/13-03/19	M 270.920										
Engine	Information				A10	A20	A40	A50	A70	C10 - C30	C20	E01		
All engines	x 4, DELPHI, without protection hose, COIL ON PLUG									1.970.626	C10			
ENGINE														
CLA 250	Petrol	160	07/15-03/19	M 270.920										
Engine	Information				A10	A20	A40	A50	A70	C10 - C30	C20	E01		
All engines	x 4, DELPHI, without protection hose, COIL ON PLUG									1.970.626	C10			
ENGINE														
CLA 250 4-matic	Petrol	155	07/13-03/19	M 270.920										
Engine	Information				A10	A20	A40	A50	A70	C10 - C30	C20	E01		
All engines	x 4, DELPHI, without protection hose, COIL ON PLUG									1.970.626	C10			
ENGINE														
CLA 250 4-matic	Petrol	160	07/15-03/19	M 270.920										
Engine	Information				A10	A20	A40	A50	A70	C10 - C30	C20	E01		
All engines	x 4, DELPHI, without protection hose, COIL ON PLUG									1.970.626	C10			
ENGINE														
CLA 45 AMG 4-matic	Petrol	265	07/13-03/19	M 133.980										
Engine	Information				A10	A20	A40	A50	A70	C10 - C30	C20	E01		
All engines	x 4, DELPHI, without protection hose, COIL ON PLUG									1.970.626	C10			
CLASSE CLC														
ENGINE														
CLC 160	Petrol	95	02/09-06/11	M 271.911, M 271.921										
Engine	Information				A10	A20	A40	A50	A70	C10 - C30	C20	E01		
Eng. M 271.911	x 4, COIL ON PLUG									1.970.420	C10			
Eng. M 271.921	Qty: 4									1.970.420	C10			
ENGINE														
CLC 180 Kompressor	Petrol	0	05/08-06/11	M 271.940										
Engine	Information				A10	A20	A40	A50	A70	C10 - C30	C20	E01		
All engines	Qty: 4									1.970.420	C10			
ENGINE														
CLC 180 Kompressor	Petrol	105	05/08-06/11	M 271.946										
Engine	Information				A10	A20	A40	A50	A70	C10 - C30	C20	E01		
All engines	x 4, COIL ON PLUG									1.970.420	C10			
ENGINE														
CLC 200 Kompressor	Petrol	135	05/08-06/11	M 271.957										
Engine	Information				A10	A20	A40	A50	A70	C10 - C30	C20	E01		
All engines	x 4, COIL ON PLUG									1.970.420	C10			
ENGINE														
CLC 230	Petrol	150	05/08-06/11	M 272.920										
Engine	Information				A10	A20	A40	A50	A70	C10 - C30	C20	E01		
All engines	x 6, COIL ON PLUG									1.970.487	C10			
ENGINE														
CLC 250	Petrol	150	06/09-06/11	M 272.920										
Engine	Information				A10	A20	A40	A50	A70	C10 - C30	C20	E01		
All engines	x 6, COIL ON PLUG									1.970.487	C10			
ENGINE														
CLC 350	Petrol	200	05/08-06/11	M 272.960										
Engine	Information				A10	A20	A40	A50	A70	C10 - C30	C20	E01		
All engines	x 6, COIL ON PLUG									1.970.487	C10			
A10	CONDENSER	A20	CONTACT SET	A40	DISTRIBUTOR CAP	A50	ROTOR	A70	PICK-UP					
C10	COIL	C20	IGNITION MODULE	C30	ELECTRONIC IGNITION KIT	E01	IGNITION CABLE SET							

Vehicle	alim.	kW	Date	Engine	FUNCTIONS ON THE VEHICLE							
					A10	A20	A40	A50	A70	C10 - C30	C20	E01

CLASSE CLK I

				ENGINE										
200	Petrol	100	06/97-06/02	M 111.945										
Engine		Information			A10	A20	A40	A50	A70	C10 - C30	C20	E01		
All engines		x 2, SEMI-DIRECT, Dia: 4 mm, connector type, saw teeth								1.970.316	C10			
				ENGINE										
200 Kompressor	Petrol	141	06/97-06/00	M 111.944										
Engine		Information			A10	A20	A40	A50	A70	C10 - C30	C20	E01		
All engines		x 2, SEMI-DIRECT, Dia: 4 mm, connector type, saw teeth								1.970.316	C10			
				ENGINE										
230 Kompressor	Petrol	142	06/97-06/00	M 111.975										
Engine		Information			A10	A20	A40	A50	A70	C10 - C30	C20	E01		
All engines		x 2, SEMI-DIRECT, Dia: 4 mm, connector type, saw teeth								1.970.316	C10			
				ENGINE										
320	Petrol	160	06/97-06/02	M 112.940										
Engine		Information			A10	A20	A40	A50	A70	C10 - C30	C20	E01		
All engines		x 6, COIL ON PLUG								1.970.417	C10			
All engines													1.501.649	
				ENGINE										
430	Petrol	205	07/98-06/02	M 113.943										
Engine		Information			A10	A20	A40	A50	A70	C10 - C30	C20	E01		
All engines		x 8, COIL ON PLUG								1.970.417	C10			
				ENGINE										
55 AMG	Petrol	255	08/99-12/03	M 113.984										
Engine		Information			A10	A20	A40	A50	A70	C10 - C30	C20	E01		
All engines		x 8, COIL ON PLUG								1.970.417	C10			

CLASSE CLK II

				ENGINE										
200 CGI	Petrol	125	07/03-05/09	M 271.942										
Engine		Information			A10	A20	A40	A50	A70	C10 - C30	C20	E01		
All engines		x 4, COIL ON PLUG								1.970.420	C10			
				ENGINE										
200 Kompressor	Petrol	120	09/02-05/09	M 271.940										
Engine		Information			A10	A20	A40	A50	A70	C10 - C30	C20	E01		
All engines		x 4, COIL ON PLUG								1.970.420	C10			
				ENGINE										
200 Kompressor	Petrol	135	10/06-05/09	M 271.955										
Engine		Information			A10	A20	A40	A50	A70	C10 - C30	C20	E01		
All engines		x 4, COIL ON PLUG								1.970.420	C10			
				ENGINE										
240	Petrol	120	06/02-05/09	M 112.912										
Engine		Information			A10	A20	A40	A50	A70	C10 - C30	C20	E01		
All engines		x 6, COIL ON PLUG								1.970.417	C10			
All engines													1.501.649	
				ENGINE										
240	Petrol	125	06/02-05/09	M 112.912										
Engine		Information			A10	A20	A40	A50	A70	C10 - C30	C20	E01		
All engines		x 6, COIL ON PLUG								1.970.417	C10			
All engines													1.501.649	
				ENGINE										
280	Petrol	170	01/05-05/09	M 272.940										
Engine		Information			A10	A20	A40	A50	A70	C10 - C30	C20	E01		
All engines		x 6, COIL ON PLUG								1.970.487	C10			
				ENGINE										
320	Petrol	160	06/02-05/09	M 112.955										
Engine		Information			A10	A20	A40	A50	A70	C10 - C30	C20	E01		
All engines		x 6, COIL ON PLUG								1.970.417	C10			
All engines													1.501.649	

A10 CONDENSER	A20 CONTACT SET	A40 DISTRIBUTOR CAP	A50 ROTOR	A70 PICK-UP
C10 COIL	C20 IGNITION MODULE	C30 ELECTRONIC IGNITION KIT	E01 IGNITION CABLE SET	

Vehicle	alim.	kW	Date	Engine	FUNCTIONS ON THE VEHICLE									
					A10	A20	A40	A50	A70	C10 - C30	C20	E01		
ENGINE														
350	Petrol	200	01/05-05/09	M 272.960										
ENGINE														
Engine Information					A10	A20	A40	A50	A70	C10 - C30	C20	E01		
All engines x 6, COIL ON PLUG										1.970.487	C10			
500	Petrol	225	06/02-05/09	M 113.968										
ENGINE														
Engine Information					A10	A20	A40	A50	A70	C10 - C30	C20	E01		
All engines x 8, COIL ON PLUG										1.970.417	C10			
500	Petrol	285	06/06->	M 273.967										
ENGINE														
Engine Information					A10	A20	A40	A50	A70	C10 - C30	C20	E01		
All engines Qty: 8										1.970.487	C10			
All engines x 8, COIL ON PLUG										1.970.487	C10			
55 AMG	Petrol	270	09/02-05/09	M 113.987										
ENGINE														
Engine Information					A10	A20	A40	A50	A70	C10 - C30	C20	E01		
All engines x 8, COIL ON PLUG										1.970.417	C10			
550	Petrol	285	06/06->	M 273.967										
ENGINE														
Engine Information					A10	A20	A40	A50	A70	C10 - C30	C20	E01		
All engines Qty: 8										1.970.487	C10			
CLK 200 CGI	Petrol	125	07/03-03/10	M 271.942										
ENGINE														
Engine Information					A10	A20	A40	A50	A70	C10 - C30	C20	E01		
All engines ->eng. 30853899, eng. type 30853900 ->, x 4, COIL ON PLUG										1.970.420	C10			
CLK 200 Kompressor	Petrol	120	02/03-03/10	M 271.940										
ENGINE														
Engine Information					A10	A20	A40	A50	A70	C10 - C30	C20	E01		
All engines x 4, COIL ON PLUG										1.970.420	C10			
CLK 200 Kompressor	Petrol	135	10/06-03/10	M 271.955										
ENGINE														
Engine Information					A10	A20	A40	A50	A70	C10 - C30	C20	E01		
All engines x 4, COIL ON PLUG										1.970.420	C10			
CLK 240	Petrol	125	02/03-03/10	M 112.912										
ENGINE														
Engine Information					A10	A20	A40	A50	A70	C10 - C30	C20	E01		
All engines x 6, COIL ON PLUG										1.970.417	C10			
All engines													1.501.649	
CLK 280	Petrol	170	01/05-03/10	M 272.940										
ENGINE														
Engine Information					A10	A20	A40	A50	A70	C10 - C30	C20	E01		
All engines x 6, COIL ON PLUG										1.970.487	C10			
CLK 320	Petrol	160	02/03-03/10	M 112.955										
ENGINE														
Engine Information					A10	A20	A40	A50	A70	C10 - C30	C20	E01		
All engines x 6, COIL ON PLUG										1.970.417	C10			
All engines													1.501.649	
CLK 350	Petrol	200	01/05-03/10	M 272.960										
ENGINE														
Engine Information					A10	A20	A40	A50	A70	C10 - C30	C20	E01		
All engines x 6, COIL ON PLUG										1.970.487	C10			
CLK 500	Petrol	225	02/03-03/10	M 113.968										
ENGINE														
Engine Information					A10	A20	A40	A50	A70	C10 - C30	C20	E01		
All engines x 8, COIL ON PLUG										1.970.417	C10			
CLK 500	Petrol	285	06/06-03/10	M 273.967										
ENGINE														
Engine Information					A10	A20	A40	A50	A70	C10 - C30	C20	E01		
All engines x 8, COIL ON PLUG										1.970.487	C10			

A10	CONDENSER	A20	CONTACT SET	A40	DISTRIBUTOR CAP	A50	ROTOR	A70	PICK-UP
C10	COIL	C20	IGNITION MODULE	C30	ELECTRONIC IGNITION KIT	E01	IGNITION CABLE SET		

The present application list is a brief version. For the detailed information about the possibility of installation on a specific vehicle, please refer to our web-catalogue <http://catalogo.facet.eu/>









Vehicle	alim.	kW	Date	Engine	FUNCTIONS ON THE VEHICLE								
					A10	A20	A40	A50	A70	C10 - C30	C20	E01	
CLASSE CLK													
CLK 55 AMG	Petrol	270	06/02-03/10	ENGINE M 113.987									
Engine	Information				A10	A20	A40	A50	A70	C10 - C30	C20	E01	
All engines	x 8, COIL ON PLUG									1.970.417	C10		
CLASSE CLS I													
CLS 280	Petrol	170	07/08-12/10	ENGINE M 272.943									
Engine	Information				A10	A20	A40	A50	A70	C10 - C30	C20	E01	
All engines	x 6, COIL ON PLUG									1.970.487	C10		
CLS 300	Petrol	170	04/09-12/10	ENGINE M 272.943									
Engine	Information				A10	A20	A40	A50	A70	C10 - C30	C20	E01	
All engines	x 6, COIL ON PLUG									1.970.487	C10		
CLS 350	Petrol	200	10/04-12/10	ENGINE M 272.964									
Engine	Information				A10	A20	A40	A50	A70	C10 - C30	C20	E01	
All engines	x 6, COIL ON PLUG									1.970.487	C10		
CLS 500	Petrol	225	10/04-12/10	ENGINE M 113.967									
Engine	Information				A10	A20	A40	A50	A70	C10 - C30	C20	E01	
All engines	x 8, COIL ON PLUG									1.970.417	C10		
CLS 500	Petrol	285	04/06-12/10	ENGINE M 273.960									
Engine	Information				A10	A20	A40	A50	A70	C10 - C30	C20	E01	
All engines	x 8, COIL ON PLUG									1.970.487	C10		
CLS 55 AMG	Petrol	350	01/05-12/10	ENGINE M 113.990									
Engine	Information				A10	A20	A40	A50	A70	C10 - C30	C20	E01	
All engines	x 8, COIL ON PLUG									1.970.417	C10		
CLS 550	Petrol	285	04/06-02/11	ENGINE M 273.960									
Engine	Information				A10	A20	A40	A50	A70	C10 - C30	C20	E01	
All engines	Qty: 8									1.970.487	C10		
CLASSE CLS II													
CLS 250	Petrol	0	05/14->	ENGINE M 274.920									
Engine	Information				A10	A20	A40	A50	A70	C10 - C30	C20	E01	
All engines	Qty: 4, version Delphi									1.970.626	C10		
CLASSE E													
E 280	Petrol	150	07/99-11/02	ENGINE M 112.921									
Engine	Information				A10	A20	A40	A50	A70	C10 - C30	C20	E01	
All engines	x 6, COIL ON PLUG									1.970.417	C10		
CLASSE E I													
E 200	Petrol	100	06/93-03/98	ENGINE M 111.940									
Engine	Information				A10	A20	A40	A50	A70	C10 - C30	C20	E01	
All engines	Qty: 2									1.970.317	C10		
E 200 T	Petrol	100	06/93-06/96	ENGINE M 111.940									
Engine	Information				A10	A20	A40	A50	A70	C10 - C30	C20	E01	
All engines	Qty: 2									1.970.317	C10		
E 220	Petrol	110	06/93-03/98	ENGINE M 111.960									
Engine	Information				A10	A20	A40	A50	A70	C10 - C30	C20	E01	
All engines	Qty: 2									1.970.317	C10		
E 220 T	Petrol	110	06/93-06/96	ENGINE M 111.960									
Engine	Information				A10	A20	A40	A50	A70	C10 - C30	C20	E01	
All engines	Qty: 2									1.970.317	C10		

A10 CONDENSER	A20 CONTACT SET	A40 DISTRIBUTOR CAP	A50 ROTOR	A70 PICK-UP
C10 COIL	C20 IGNITION MODULE	C30 ELECTRONIC IGNITION KIT	E01 IGNITION CABLE SET	

Vehicle	alim.	kW	Date	Engine	FUNCTIONS ON THE VEHICLE									
					A10	A20	A40	A50	A70	C10 - C30	C20	E01		
ENGINE														
E 280	Petrol	142	06/93-06/95	M 104.942										
Engine	Information				A10	A20	A40	A50	A70	C10 - C30	C20	E01		
All engines	Qty: 3, without spark plug connector									1.970.316	C10			
All engines	incl. spark plug connector, Qty: 3									1.970.316K	C10			
ENGINE														
E 280	Petrol	145	06/93-06/95	M 104.942										
Engine	Information				A10	A20	A40	A50	A70	C10 - C30	C20	E01		
All engines	Qty: 3, without spark plug connector									1.970.316	C10			
All engines	incl. spark plug connector, Qty: 3									1.970.316K	C10			
ENGINE														
E 280 T	Petrol	142	06/93-06/96	M 104.942										
Engine	Information				A10	A20	A40	A50	A70	C10 - C30	C20	E01		
All engines	Qty: 3, without spark plug connector									1.970.316	C10			
All engines	incl. spark plug connector, Qty: 3									1.970.316K	C10			
ENGINE														
E 280 T	Petrol	145	06/93-06/96	M 104.942										
Engine	Information				A10	A20	A40	A50	A70	C10 - C30	C20	E01		
All engines	Qty: 3, without spark plug connector									1.970.316	C10			
All engines	incl. spark plug connector, Qty: 3									1.970.316K	C10			
ENGINE														
E 300 4-matic	Petrol	132	06/93-06/95	M 103.985										
Engine	Information				A10	A20	A40	A50	A70	C10 - C30	C20	E01		
All engines	version Bosch						1.306.237	1.406.125R						
All engines										1.970.178	C10		1.501.657	
ENGINE														
E 300 T 4-matic	Petrol	132	06/93-06/96	M 103.985										
Engine	Information				A10	A20	A40	A50	A70	C10 - C30	C20	E01		
All engines	version Bosch						1.306.237	1.406.125R						
All engines										1.970.178	C10		1.501.657	
ENGINE														
E 320	Petrol	162	06/93-03/98	M 104.992										
Engine	Information				A10	A20	A40	A50	A70	C10 - C30	C20	E01		
All engines	Qty: 3, without spark plug connector									1.970.316	C10			
All engines	incl. spark plug connector, Qty: 3									1.970.316K	C10			
ENGINE														
E 320 T	Petrol	162	06/93-06/96	M 104.992										
Engine	Information				A10	A20	A40	A50	A70	C10 - C30	C20	E01		
All engines	Qty: 3, without spark plug connector									1.970.316	C10			
All engines	incl. spark plug connector, Qty: 3									1.970.316K	C10			
ENGINE														
E 36 AMG	Petrol	195	06/93-04/95	M 104.992 (AMG 3.6)										
Engine	Information				A10	A20	A40	A50	A70	C10 - C30	C20	E01		
All engines	Qty: 3, without spark plug connector									1.970.316	C10			
All engines	incl. spark plug connector, Qty: 3									1.970.316K	C10			
ENGINE														
E 36 AMG	Petrol	200	05/94-03/98	M 104.992 (AMG 3.6)										
Engine	Information				A10	A20	A40	A50	A70	C10 - C30	C20	E01		
All engines	Qty: 3, without spark plug connector									1.970.316	C10			
All engines	incl. spark plug connector, Qty: 3									1.970.316K	C10			
ENGINE														
E 36 T AMG	Petrol	200	05/94-06/96	M 104.992 (AMG 3.6)										
Engine	Information				A10	A20	A40	A50	A70	C10 - C30	C20	E01		
All engines	Qty: 3, without spark plug connector									1.970.316	C10			
All engines	incl. spark plug connector, Qty: 3									1.970.316K	C10			
ENGINE														
E 420	Petrol	205	06/93-06/95	M 119.975										
Engine	Information				A10	A20	A40	A50	A70	C10 - C30	C20	E01		
All engines	Qty: 2, version Bosch							1.406.146R						
All engines	-> ch. B 568955, Qty: 2									1.970.178	C10			
All engines	ch. B 568956 ->									1.970.179	C10			

A10	CONDENSER	A20	CONTACT SET	A40	DISTRIBUTOR CAP	A50	ROTOR	A70	PICK-UP
C10	COIL	C20	IGNITION MODULE	C30	ELECTRONIC IGNITION KIT	E01	IGNITION CABLE SET		

The present application list is a brief version. For the detailed information about the possibility of installation on a specific vehicle, please refer to our web-catalogue <http://catalogo.facet.eu/>









				FUNCTIONS ON THE VEHICLE								
Vehicle	alim.	kW	Date	Engine								
				ENGINE								
E 500	Petrol	235	06/93-06/95	M 119.974								
Engine	Information											
All engines	Qty: 2, version Bosch						1.406.146R					
All engines	->ch. B 568955, Qty: 2								1.970.178	C10		
All engines	ch. B 568956 ->								1.970.179	C10		
				ENGINE								
E 60 AMG	Petrol	280	05/94-06/95	M 119.974 (AMG 6.0)								
Engine	Information											
All engines	Qty: 2, version Bosch						1.406.146R					
All engines	->ch. B 568955, Qty: 2								1.970.178	C10		
All engines	ch. B 568956 ->								1.970.179	C10		
				ENGINE								
E 200	Petrol	100	06/95-08/00	M 111.942								
Engine	Information											
All engines	x 2, SEMI-DIRECT, Dia: 4 mm, connector type, saw teeth									1.970.316	C10	
				ENGINE								
E 200 Kompressor	Petrol	137	06/97-03/02	M 111.947								
Engine	Information											
All engines	x 2, SEMI-DIRECT, Dia: 4 mm, connector type, saw teeth									1.970.316	C10	
				ENGINE								
E 200 T	Petrol	100	06/96-08/00	M 111.942								
Engine	Information											
All engines	x 2, SEMI-DIRECT, Dia: 4 mm, connector type, saw teeth									1.970.316	C10	
				ENGINE								
E 200 T Kompressor	Petrol	137	06/97-03/03	M 111.947								
Engine	Information											
All engines	x 2, SEMI-DIRECT, Dia: 4 mm, connector type, saw teeth									1.970.316	C10	
				ENGINE								
E 230	Petrol	110	06/95-06/97	M 111.970								
Engine	Information											
All engines	x 2, SEMI-DIRECT, Dia: 4 mm, connector type, saw teeth									1.970.316	C10	
				ENGINE								
E 230 T	Petrol	110	06/96-06/97	M 111.970								
Engine	Information											
All engines	x 2, SEMI-DIRECT, Dia: 4 mm, connector type, saw teeth									1.970.316	C10	
				ENGINE								
E 240	Petrol	125	06/97-03/02	M 112.911, M 112.914								
Engine	Information											
All engines	x 6, COIL ON PLUG									1.970.417	C10	
All engines												1.501.649
				ENGINE								
E 240 T	Petrol	125	06/97-03/03	M 112.911, M 112.914								
Engine	Information											
All engines	x 6, COIL ON PLUG									1.970.417	C10	
All engines												1.501.649
				ENGINE								
E 280	Petrol	142	01/96-06/97	M 104.945								
Engine	Information											
All engines	x 3, SEMI-DIRECT, Dia: 4 mm, connector type, saw teeth									1.970.316	C10	
				ENGINE								
E 280	Petrol	150	12/96-03/02	M 112.921								
Engine	Information											
All engines	x 6, COIL ON PLUG									1.970.417	C10	
All engines												1.501.649
				ENGINE								
E 280 4-matic	Petrol	150	12/96-03/02	M 112.921								
Engine	Information											
All engines	x 6, COIL ON PLUG									1.970.417	C10	
All engines												1.501.649

A10 CONDENSER	A20 CONTACT SET	A40 DISTRIBUTOR CAP	A50 ROTOR	A70 PICK-UP
C10 COIL	C20 IGNITION MODULE	C30 ELECTRONIC IGNITION KIT	E01 IGNITION CABLE SET	

Vehicle	alim.	kW	Date	Engine	FUNCTIONS ON THE VEHICLE							
					A10	A20	A40	A50	A70	C10 - C30	C20	E01
E 280 T					ENGINE							
Petrol	150	12/96-03/03	M 112.921		A10	A20	A40	A50	A70	C10 - C30	C20	E01
Engine	Information				A10	A20	A40	A50	A70	C10 - C30	C20	E01
All engines	x 6, COIL ON PLUG									1.970.417	C10	
All engines												1.501.649
E 280 T 4-matic					ENGINE							
Petrol	150	12/96-03/03	M 112.921		A10	A20	A40	A50	A70	C10 - C30	C20	E01
Engine	Information				A10	A20	A40	A50	A70	C10 - C30	C20	E01
All engines	x 6, COIL ON PLUG									1.970.417	C10	
All engines												1.501.649
E 320					ENGINE							
Petrol	162	06/95-06/97	M 104.995		A10	A20	A40	A50	A70	C10 - C30	C20	E01
Engine	Information				A10	A20	A40	A50	A70	C10 - C30	C20	E01
All engines	x 3, SEMI-DIRECT, Dia: 4 mm, connector type, saw teeth									1.970.316	C10	
All engines												
E 320					ENGINE							
Petrol	165	06/97-03/02	M 112.941		A10	A20	A40	A50	A70	C10 - C30	C20	E01
Engine	Information				A10	A20	A40	A50	A70	C10 - C30	C20	E01
All engines	x 6, COIL ON PLUG									1.970.417	C10	
All engines												1.501.649
E 320 4-matic					ENGINE							
Petrol	165	06/97-03/02	M 112.941		A10	A20	A40	A50	A70	C10 - C30	C20	E01
Engine	Information				A10	A20	A40	A50	A70	C10 - C30	C20	E01
All engines	x 6, COIL ON PLUG									1.970.417	C10	
All engines												1.501.649
E 320 T					ENGINE							
Petrol	165	12/96-03/03	M 112.941		A10	A20	A40	A50	A70	C10 - C30	C20	E01
Engine	Information				A10	A20	A40	A50	A70	C10 - C30	C20	E01
All engines	x 6, COIL ON PLUG									1.970.417	C10	
All engines												1.501.649
E 320 T 4-matic					ENGINE							
Petrol	165	12/96-03/03	M 112.941		A10	A20	A40	A50	A70	C10 - C30	C20	E01
Engine	Information				A10	A20	A40	A50	A70	C10 - C30	C20	E01
All engines	x 6, COIL ON PLUG									1.970.417	C10	
All engines												1.501.649
E 36 AMG					ENGINE							
Petrol	200	04/96-01/98	M 104995AMG		A10	A20	A40	A50	A70	C10 - C30	C20	E01
Engine	Information				A10	A20	A40	A50	A70	C10 - C30	C20	E01
All engines	x 3, SEMI-DIRECT, Dia: 4 mm, connector type, saw teeth									1.970.316	C10	
All engines												
E 430					ENGINE							
Petrol	205	06/97-03/02	M 113.940		A10	A20	A40	A50	A70	C10 - C30	C20	E01
Engine	Information				A10	A20	A40	A50	A70	C10 - C30	C20	E01
All engines	x 8, COIL ON PLUG									1.970.417	C10	
All engines												
E 430 4-matic					ENGINE							
Petrol	205	05/99-03/02	M 113.940		A10	A20	A40	A50	A70	C10 - C30	C20	E01
Engine	Information				A10	A20	A40	A50	A70	C10 - C30	C20	E01
All engines	x 8, COIL ON PLUG									1.970.417	C10	
All engines												
E 430 T					ENGINE							
Petrol	205	06/97-03/03	M 113.940		A10	A20	A40	A50	A70	C10 - C30	C20	E01
Engine	Information				A10	A20	A40	A50	A70	C10 - C30	C20	E01
All engines	x 8, COIL ON PLUG									1.970.417	C10	
All engines												
E 430 T 4-matic					ENGINE							
Petrol	205	05/99-03/03	M 113.940		A10	A20	A40	A50	A70	C10 - C30	C20	E01
Engine	Information				A10	A20	A40	A50	A70	C10 - C30	C20	E01
All engines	x 8, COIL ON PLUG									1.970.417	C10	
All engines												
E 55 AMG					ENGINE							
Petrol	260	08/97-03/02	M 113.980		A10	A20	A40	A50	A70	C10 - C30	C20	E01
Engine	Information				A10	A20	A40	A50	A70	C10 - C30	C20	E01
All engines	x 8, COIL ON PLUG									1.970.417	C10	
All engines												

A10 CONDENSER	A20 CONTACT SET	A40 DISTRIBUTOR CAP	A50 ROTOR	A70 PICK-UP
C10 COIL	C20 IGNITION MODULE	C30 ELECTRONIC IGNITION KIT	E01 IGNITION CABLE SET	

The present application list is a brief version. For the detailed information about the possibility of installation on a specific vehicle, please refer to our web-catalogue <http://catalogo.facet.eu/>

					FUNCTIONS ON THE VEHICLE							
Vehicle	alim.	kW	Date	Engine								
E 55 T AMG												
	Petrol	260	08/97-03/03	ENGINE M 113.980								
Engine		Information			A10	A20	A40	A50	A70	C10 - C30	C20	E01
All engines		x 8, COIL ON PLUG								1.970.417	C10	
CLASSE E III												
350 CGI												
	Petrol	215	05/06-07/09	ENGINE M 272.985								
Engine		Information			A10	A20	A40	A50	A70	C10 - C30	C20	E01
All engines		->year 01/09/06, x 6, COIL ON PLUG								1.970.487	C10	
E 200 Kompressor												
	Petrol	120	11/02-12/08	ENGINE M 271.941								
Engine		Information			A10	A20	A40	A50	A70	C10 - C30	C20	E01
All engines		x 4, COIL ON PLUG								1.970.420	C10	
E 200 Kompressor												
	Petrol	135	04/06-07/09	ENGINE M 271.956								
Engine		Information			A10	A20	A40	A50	A70	C10 - C30	C20	E01
All engines		->eng. 30853899, x 4, COIL ON PLUG								1.970.420	C10	
E 200 NGT												
	Petrol/ Compressed Natural Gas (CNG)	120	03/04-12/08	ENGINE M 271.941, M 271941NGT								
Engine		Information			A10	A20	A40	A50	A70	C10 - C30	C20	E01
Eng. M 271.941		Qty: 4								1.970.420	C10	
Eng. M 271941NGT		->eng. 30853899, x 4, COIL ON PLUG								1.970.420	C10	
E 200 T Kompressor												
	Petrol	120	03/03-07/09	ENGINE M 271.941								
Engine		Information			A10	A20	A40	A50	A70	C10 - C30	C20	E01
All engines		x 4, COIL ON PLUG								1.970.420	C10	
E 230												
	Petrol	150	09/07-12/08	ENGINE M 272.922								
Engine		Information			A10	A20	A40	A50	A70	C10 - C30	C20	E01
All engines		x 6, COIL ON PLUG								1.970.487	C10	
E 230 T												
	Petrol	150	05/07-07/09	ENGINE M 272.922								
Engine		Information			A10	A20	A40	A50	A70	C10 - C30	C20	E01
All engines		x 6, COIL ON PLUG								1.970.487	C10	
E 240												
	Petrol	130	03/02-12/08	ENGINE M 112.913								
Engine		Information			A10	A20	A40	A50	A70	C10 - C30	C20	E01
All engines		x 6, COIL ON PLUG								1.970.417	C10	
All engines												1.501.649
E 240 4-matic												
	Petrol	130	03/03-12/08	ENGINE M 112.917								
Engine		Information			A10	A20	A40	A50	A70	C10 - C30	C20	E01
All engines		x 6, COIL ON PLUG								1.970.417	C10	
All engines												1.501.649
E 240 T												
	Petrol	130	03/03-07/09	ENGINE M 112.913								
Engine		Information			A10	A20	A40	A50	A70	C10 - C30	C20	E01
All engines		x 6, COIL ON PLUG								1.970.417	C10	
All engines												1.501.649
E 240 T 4-matic												
	Petrol	130	07/03-07/09	ENGINE M 112.917								
Engine		Information			A10	A20	A40	A50	A70	C10 - C30	C20	E01
All engines		x 6, COIL ON PLUG								1.970.417	C10	
All engines												1.501.649
E 250												
	Petrol	150	09/07-12/08	ENGINE M 272.922								
Engine		Information			A10	A20	A40	A50	A70	C10 - C30	C20	E01
All engines		Qty: 6								1.970.487	C10	

A10 CONDENSER	A20 CONTACT SET	A40 DISTRIBUTOR CAP	A50 ROTOR	A70 PICK-UP
C10 COIL	C20 IGNITION MODULE	C30 ELECTRONIC IGNITION KIT	E01 IGNITION CABLE SET	

Vehicle	alim.	kW	Date	Engine	FUNCTIONS ON THE VEHICLE									
					A10	A20	A40	A50	A70	C10 - C30	C20	E01		
E 280					ENGINE									
	Petrol	170	03/05-12/08	M 272.943										
Engine					A10	A20	A40	A50	A70	C10 - C30	C20	E01		
Information										1.970.487	C10			
All engines														
Eng. 9930.61										1.970.487	C10			
Eng. M 272944										1.970.487	C10			
E 280 4-matic					ENGINE									
	Petrol	170	03/05-12/08	9930.61, M 272944										
Engine					A10	A20	A40	A50	A70	C10 - C30	C20	E01		
Information										1.970.487	C10			
Qty: 6														
Eng. M 272944										1.970.487	C10			
E 280 T					ENGINE									
	Petrol	170	03/05-07/09	M 272.943										
Engine					A10	A20	A40	A50	A70	C10 - C30	C20	E01		
Information										1.970.487	C10			
All engines														
Eng. 9930.61										1.970.487	C10			
Eng. M 272944										1.970.487	C10			
E 280 T 4-matic					ENGINE									
	Petrol	170	03/05-07/09	9930.61, M 272944										
Engine					A10	A20	A40	A50	A70	C10 - C30	C20	E01		
Information										1.970.487	C10			
Qty: 6														
Eng. M 272944										1.970.487	C10			
E 300					ENGINE									
	Petrol	170	03/05-12/08	M 272.943										
Engine					A10	A20	A40	A50	A70	C10 - C30	C20	E01		
Information										1.970.487	C10			
All engines														
Eng. 9930.61										1.970.487	C10			
Eng. M 272944										1.970.487	C10			
E 300 T 4-matic					ENGINE									
	Petrol	170	03/05-07/09	9930.61										
Engine					A10	A20	A40	A50	A70	C10 - C30	C20	E01		
Information										1.970.487	C10			
Qty: 6														
All engines														
E 320					ENGINE									
	Petrol	165	03/02-12/08	M 112.949										
Engine					A10	A20	A40	A50	A70	C10 - C30	C20	E01		
Information										1.970.417	C10			
All engines													1.501.649	
All engines														1.501.649
E 320 4-matic					ENGINE									
	Petrol	165	03/03-12/08	M 112.954										
Engine					A10	A20	A40	A50	A70	C10 - C30	C20	E01		
Information										1.970.417	C10			
All engines													1.501.649	
All engines														1.501.649
E 320 T					ENGINE									
	Petrol	165	03/03-07/09	M 112.949										
Engine					A10	A20	A40	A50	A70	C10 - C30	C20	E01		
Information										1.970.417	C10			
All engines													1.501.649	
All engines														1.501.649
E 320 T 4-matic					ENGINE									
	Petrol	165	07/03-07/09	M 112.954										
Engine					A10	A20	A40	A50	A70	C10 - C30	C20	E01		
Information										1.970.417	C10			
All engines													1.501.649	
All engines														1.501.649
E 350					ENGINE									
	Petrol	200	03/05-12/08	M 272.964										
Engine					A10	A20	A40	A50	A70	C10 - C30	C20	E01		
Information										1.970.487	C10			
All engines														
E 350 4-matic					ENGINE									
	Petrol	200	03/05-12/08	M 272.972										
Engine					A10	A20	A40	A50	A70	C10 - C30	C20	E01		
Information										1.970.487	C10			
All engines														
E 350 4-matic					ENGINE									
	Petrol	205	08/04-08/06	M 272.972										
Engine					A10	A20	A40	A50	A70	C10 - C30	C20	E01		
Information										1.970.487	C10			
All engines														

A10	CONDENSER	A20	CONTACT SET	A40	DISTRIBUTOR CAP	A50	ROTOR	A70	PICK-UP
C10	COIL	C20	IGNITION MODULE	C30	ELECTRONIC IGNITION KIT	E01	IGNITION CABLE SET		









The present application list is a brief version. For the detailed information about the possibility of installation on a specific vehicle, please refer to our web-catalogue <http://catalogo.facet.eu/>

Vehicle	alim.	kW	Date	Engine	FUNCTIONS ON THE VEHICLE												
					A10	A20	A40	A50	A70	C10 - C30	C20	E01					
ENGINE																	
E 350 CGI	Petrol	215	09/07-12/08	M 272.985													
Engine	Information				A10	A20	A40	A50	A70	C10 - C30	C20	E01					
All engines	->year 01/09/06, ->eng. 30417696, x6, COIL ON PLUG									1.970.487	C10						
ENGINE																	
E 350 T	Petrol	200	03/05-07/09	M 272.964													
Engine	Information				A10	A20	A40	A50	A70	C10 - C30	C20	E01					
All engines	x 6, COIL ON PLUG									1.970.487	C10						
ENGINE																	
E 350 T 4-matic	Petrol	200	03/05-07/09	M 272.972													
Engine	Information				A10	A20	A40	A50	A70	C10 - C30	C20	E01					
All engines	x 6, COIL ON PLUG									1.970.487	C10						
ENGINE																	
E 500	Petrol	225	03/02-12/08	M 113.967													
Engine	Information				A10	A20	A40	A50	A70	C10 - C30	C20	E01					
All engines	x 8, COIL ON PLUG									1.970.417	C10						
ENGINE																	
E 500	Petrol	285	04/06-12/08	M 273.960													
Engine	Information				A10	A20	A40	A50	A70	C10 - C30	C20	E01					
All engines	x 8, COIL ON PLUG									1.970.487	C10						
ENGINE																	
E 500 4-matic	Petrol	225	10/03-12/08	M 113.969													
Engine	Information				A10	A20	A40	A50	A70	C10 - C30	C20	E01					
All engines	x 8, COIL ON PLUG									1.970.417	C10						
ENGINE																	
E 500 4-matic	Petrol	285	04/06-12/08	M 273.962													
Engine	Information				A10	A20	A40	A50	A70	C10 - C30	C20	E01					
All engines	x 8, COIL ON PLUG									1.970.487	C10						
ENGINE																	
E 500 T	Petrol	225	10/03-07/09	M 113.967													
Engine	Information				A10	A20	A40	A50	A70	C10 - C30	C20	E01					
All engines	x 8, COIL ON PLUG									1.970.417	C10						
ENGINE																	
E 500 T	Petrol	285	04/06-07/09	M 273.960													
Engine	Information				A10	A20	A40	A50	A70	C10 - C30	C20	E01					
All engines	x 8, COIL ON PLUG									1.970.487	C10						
ENGINE																	
E 500 T 4-matic	Petrol	225	10/03-07/09	M 113.969													
Engine	Information				A10	A20	A40	A50	A70	C10 - C30	C20	E01					
All engines	x 8, COIL ON PLUG									1.970.417	C10						
ENGINE																	
E 500 T 4-matic	Petrol	285	04/06-07/09	M 273.962													
Engine	Information				A10	A20	A40	A50	A70	C10 - C30	C20	E01					
All engines	x 8, COIL ON PLUG									1.970.487	C10						
ENGINE																	
E 55 AMG Kompressor	Petrol	350	10/02-12/08	M 113.990													
Engine	Information				A10	A20	A40	A50	A70	C10 - C30	C20	E01					
All engines	x 8, COIL ON PLUG									1.970.417	C10						
ENGINE																	
E 55 T AMG Kompressor	Petrol	350	07/03-07/09	M 113.990													
Engine	Information				A10	A20	A40	A50	A70	C10 - C30	C20	E01					
All engines	x 8, COIL ON PLUG									1.970.417	C10						
ENGINE																	
E 550 4-matic	Petrol	285	04/06-12/08	M 273.962													
Engine	Information				A10	A20	A40	A50	A70	C10 - C30	C20	E01					
All engines	Qty: 8									1.970.487	C10						
ENGINE																	
E 550 T 4-matic	Petrol	285	04/06-07/09	M 273.962													
Engine	Information				A10	A20	A40	A50	A70	C10 - C30	C20	E01					
All engines	Qty: 8									1.970.487	C10						
ENGINE																	
A10	CONDENSER			A20	CONTACT SET			A40	DISTRIBUTOR CAP			A50	ROTOR		A70	PICK-UP	
C10	COIL			C20	IGNITION MODULE			C30	ELECTRONIC IGNITION KIT			E01	IGNITION CABLE SET				

Vehicle	alim.	kW	Date	Engine	FUNCTIONS ON THE VEHICLE							
					A10	A20	A40	A50	A70	C10 - C30	C20	E01
CLASSE E IV												
E 180	Petrol	115	12/12->	M 274.910								
Engine	Information			A10	A20	A40	A50	A70	C10 - C30	C20	E01	
All engines	MADE BY: (TJ), x 4, DELPHI, x 4, without protection hose, COIL ON PLUG, FOR: (TJ)								1.970.626	C10		
All engines	Qty: 4								1.970.626	C10		
E 200	Petrol	135	11/12-12/16	M 274.920								
Engine	Information			A10	A20	A40	A50	A70	C10 - C30	C20	E01	
All engines	MADE BY: (TJ), MADE BY: (USA), x 4, DELPHI, x 4, without protection hose, COIL ON PLUG, FOR: (TJ)								1.970.626	C10		
E 200 CGI	Petrol	135	08/09-12/16	M 271.820, M 271.860								
Engine	Information			A10	A20	A40	A50	A70	C10 - C30	C20	E01	
All engines	x 4, COIL ON PLUG								1.970.420	C10		
E 200 NGT	Petrol/ Com- pressed Natural Gas (CNG)	115	07/13-12/15	M 274.920, M 274920NGT								
Engine	Information			A10	A20	A40	A50	A70	C10 - C30	C20	E01	
Eng. M 274.920	Qty: 4								1.970.626	C10		
Eng. M 274920NGT	MADE BY: (TJ), x 4, DELPHI, x 4, without protection hose, COIL ON PLUG, FOR: (TJ)								1.970.626	C10		
E 200 NGT	Petrol/ Com- pressed Natural Gas (CNG)	120	03/11-12/15	M 271.958, M 271958NGT								
Engine	Information			A10	A20	A40	A50	A70	C10 - C30	C20	E01	
Eng. M 271.958	Qty: 4								1.970.420	C10		
Eng. M 271958NGT	x 4, COIL ON PLUG								1.970.420	C10		
E 250	Petrol	150	01/10->	M 272.923								
Engine	Information			A10	A20	A40	A50	A70	C10 - C30	C20	E01	
All engines	Qty: 6								1.970.487	C10		
E 250	Petrol	155	11/12-12/16	M 274.920								
Engine	Information			A10	A20	A40	A50	A70	C10 - C30	C20	E01	
All engines	MADE BY: (TJ), x 4, DELPHI, x 4, without protection hose, COIL ON PLUG, FOR: (TJ)								1.970.626	C10		
E 250 CGI	Petrol	150	01/09-12/16	M 271.860								
Engine	Information			A10	A20	A40	A50	A70	C10 - C30	C20	E01	
All engines	x 4, COIL ON PLUG								1.970.420	C10		
E 300	Petrol	170	01/09-12/13	M 272.952								
Engine	Information			A10	A20	A40	A50	A70	C10 - C30	C20	E01	
All engines	x 6, COIL ON PLUG								1.970.487	C10		
E 300	Petrol	200	01/10->	M 272.980								
Engine	Information			A10	A20	A40	A50	A70	C10 - C30	C20	E01	
All engines	Qty: 6								1.970.487	C10		
E 350	Petrol	200	01/09->	M 272.961, M 272.980, M 272.988								
Engine	Information			A10	A20	A40	A50	A70	C10 - C30	C20	E01	
All engines	x 6, COIL ON PLUG								1.970.487	C10		
Eng. M 272.961	Qty: 6								1.970.487	C10		
E 350 4-matic	Petrol	200	01/09-12/11	M 272.977								
Engine	Information			A10	A20	A40	A50	A70	C10 - C30	C20	E01	
All engines	x 6, COIL ON PLUG								1.970.487	C10		









A10 CONDENSER	A20 CONTACT SET	A40 DISTRIBUTOR CAP	A50 ROTOR	A70 PICK-UP
C10 COIL	C20 IGNITION MODULE	C30 ELECTRONIC IGNITION KIT	E01 IGNITION CABLE SET	

The present application list is a brief version. For the detailed information about the possibility of installation on a specific vehicle, please refer to our web-catalogue <http://catalogo.facet.eu/>

				FUNCTIONS ON THE VEHICLE								
Vehicle	alim.	kW	Date	Engine	 A10	 A20	 A40	 A50	 A70	 C10 - C30	 C20	 E01
				ENGINE								
E 500	Petrol	285	01/09-12/16	M 273.966, M 273.971								
				ENGINE								
				ENGINE								
E 500 4-matic	Petrol	285	01/09-12/11	M 273.970								
				ENGINE								
				ENGINE								
E 550 [USA]	Petrol	295	01/09->	M 273.966								
				ENGINE								
				ENGINE								
E 550 [USA] [CAN] [JPN]	Petrol	295	01/09->	M 273.971								
				ENGINE								
				ENGINE								
E 550 4-matic [USA] [CAN]	Petrol	295	01/09->	M 273.970								
				ENGINE								
				ENGINE								
CLASSE E V												
				ENGINE								
E 180	Petrol	115	01/17->	M 274.910								
				ENGINE								
				ENGINE								
E 200	Petrol	135	01/16->	M 274.920								
				ENGINE								
				ENGINE								
E 200 4-matic	Petrol	135	07/16->	M 274.920								
				ENGINE								
				ENGINE								
E 250	Petrol	155	07/16->	M 274.920								
				ENGINE								
				ENGINE								
E 300	Petrol	180	07/16->	M 274.920								
				ENGINE								
				ENGINE								
E 300 e	Petrol/ Electric	155	11/18->	M 274.920								
				ENGINE								
				ENGINE								
E 300 e	Petrol/ Electric	235	11/18->	M 274.920								
				ENGINE								
				ENGINE								
E 300 e 4-matic	Petrol/ Electric	155	07/20->	M 274.920								
				ENGINE								
				ENGINE								

A10 CONDENSER	A20 CONTACT SET	A40 DISTRIBUTOR CAP	A50 ROTOR	A70 PICK-UP
C10 COIL	C20 IGNITION MODULE	C30 ELECTRONIC IGNITION KIT	E01 IGNITION CABLE SET	

Vehicle	alim.	kW	Date	Engine	FUNCTIONS ON THE VEHICLE									
					A10	A20	A40	A50	A70	C10 - C30	C20	E01		
ENGINE														
E 300 e 4-matic	Petrol/ Electric	235	07/20->	M 274.920										
Engine	Information			A10	A20	A40	A50	A70	C10 - C30	C20	E01			
All engines	x 4, DELPHI, without protection hose, COIL ON PLUG, without protection hose, COIL ON PLUG, FOR: (TJ)								1.970.626	C10				
ENGINE														
E 350 e	Petrol/ Electric	155	07/16->	M 274.920										
Engine	Information			A10	A20	A40	A50	A70	C10 - C30	C20	E01			
All engines	x 4, DELPHI, without protection hose, COIL ON PLUG, without protection hose, COIL ON PLUG, FOR: (TJ)								1.970.626	C10				
ENGINE														
E 350 e	Petrol/ Electric	210	07/16->	M 274.920										
Engine	Information			A10	A20	A40	A50	A70	C10 - C30	C20	E01			
All engines	x 4, DELPHI, without protection hose, COIL ON PLUG, without protection hose, COIL ON PLUG, FOR: (TJ)								1.970.626	C10				
ENGINE														
E 350 e	Petrol/ Electric	235	11/19->	M 274.920										
Engine	Information			A10	A20	A40	A50	A70	C10 - C30	C20	E01			
All engines	x 4, DELPHI, without protection hose, COIL ON PLUG, without protection hose, COIL ON PLUG, FOR: (TJ)								1.970.626	C10				
CLASSE G I														
ENGINE														
200 GE	Petrol	80	02/80-08/92	M 102.964										
Engine	Information			A10	A20	A40	A50	A70	C10 - C30	C20	E01			
All engines	version Bosch					1.306.108	1.406.055R							
All engines									1.970.180	C10	1.501.654			
ENGINE														
230 G	Petrol	66	03/79-07/93	M 115.973										
Engine	Information			A10	A20	A40	A50	A70	C10 - C30	C20	E01			
All engines	version Bosch				1.206.034HVS	1.306.108								
ENGINE														
230 G	Petrol	75	02/80-07/87	M 115.973										
Engine	Information			A10	A20	A40	A50	A70	C10 - C30	C20	E01			
All engines	version Bosch				1.206.034HVS	1.306.108								
ENGINE														
230 GE	Petrol	90	05/87-08/92	M 102.987										
Engine	Information			A10	A20	A40	A50	A70	C10 - C30	C20	E01			
All engines	version Bosch					1.306.108	1.406.055R							
All engines									1.970.180	C10	1.501.654			
ENGINE														
230 GE	Petrol	92	04/82-08/92	M 102.981, M 102.987										
Engine	Information			A10	A20	A40	A50	A70	C10 - C30	C20	E01			
All engines	version Bosch					1.306.108	1.406.055R							
All engines									1.970.180	C10	1.501.654			
ENGINE														
280 GE	Petrol	110	08/84-08/89	M 110.994										
Engine	Information			A10	A20	A40	A50	A70	C10 - C30	C20	E01			
All engines	version Bosch				1.206.034HVS									
All engines	->eng. 004203, 001498, version Bosch					1.306.092								
All engines	eng. type 004204, 001499 ->, version Bosch					1.306.123	1.406.060R							
All engines	eng. type 002294, 000115 ->, ->eng. 004203, 001498, version Bosch						1.406.024R							
All engines	->eng. 002293, 000114, version Bosch						1.406.034R							
All engines	ch. 034825, 901172 ->								1.970.180	C10				
ENGINE														
280 GE	Petrol	115	11/79-08/89	M 110.994										
Engine	Information			A10	A20	A40	A50	A70	C10 - C30	C20	E01			
All engines	version Bosch				1.206.034HVS									
All engines	->eng. 004203, 001498, version Bosch					1.306.092								
All engines	eng. type 004204, 001499 ->, version Bosch					1.306.123	1.406.060R							
All engines	eng. type 002294, 000115 ->, ->eng. 004203, 001498, version Bosch						1.406.024R							
All engines	->eng. 002293, 000114, version Bosch						1.406.034R							
ENGINE														
A10	CONDENSER		A20	CONTACT SET		A40	DISTRIBUTOR CAP		A50	ROTOR		A70	PICK-UP	
C10	COIL		C20	IGNITION MODULE		C30	ELECTRONIC IGNITION KIT		E01	IGNITION CABLE SET				

					FUNCTIONS ON THE VEHICLE							
Vehicle	alim.	kW	Date	Engine								
ENGINE												
280 GE	Petrol	115	11/79-08/89	M 110.994								
Engine	Information				A10	A20	A40	A50	A70	C10 - C30	C20	E01
All engines	ch. 034825, 901172 ->									1.970.180	C10	
CLASSE G II												
ENGINE												
200 GE	Petrol	80	01/90-07/93	M 102.965								
Engine	Information				A10	A20	A40	A50	A70	C10 - C30	C20	E01
All engines	version Bosch						1.306.234	1.406.121R				
All engines										1.970.178	C10	
ENGINE												
200 GE	Petrol	85	01/90-07/93	M 102.965								
Engine	Information				A10	A20	A40	A50	A70	C10 - C30	C20	E01
All engines	version Bosch						1.306.234	1.406.121R				
All engines										1.970.178	C10	
ENGINE												
230 G	Petrol	74	04/92->	M 102.958								
Engine	Information				A10	A20	A40	A50	A70	C10 - C30	C20	E01
All engines	version Bosch						1.306.234	1.406.055R				
ENGINE												
230 GE	Petrol	90	09/89-07/96	M 102.979								
Engine	Information				A10	A20	A40	A50	A70	C10 - C30	C20	E01
All engines	version Bosch						1.306.234	1.406.121R				
All engines										1.970.178	C10	
ENGINE												
230 GE	Petrol	92	04/92->	M 102.981, M 102.996, M 102.997								
Engine	Information				A10	A20	A40	A50	A70	C10 - C30	C20	E01
Eng. M 102.981	version Bosch						1.306.108					
Eng. M 102.996, M 102.997	version Bosch						1.306.234					
All engines	version Bosch							1.406.055R				
Eng. M 102.996, M 102.997										1.970.178	C10	
Eng. M 102.981												1.501.654
ENGINE												
230 GE	Petrol	93	06/90-06/93	M 102.989								
Engine	Information				A10	A20	A40	A50	A70	C10 - C30	C20	E01
All engines	version Bosch						1.306.234	1.406.121R				
All engines										1.970.178	C10	
ENGINE												
280 GE	Petrol	110	04/92->	M 110.994								
Engine	Information				A10	A20	A40	A50	A70	C10 - C30	C20	E01
All engines	->eng. 004203, 001498, version Bosch						1.306.092					
All engines	eng. type 004204, 001499 ->, version Bosch						1.306.123	1.406.060R				
All engines	eng. type 002294, 000115 ->, ->eng. 004203, 001498, version Bosch							1.406.024R				
All engines	->eng. 002293, 000114, version Bosch							1.406.034R				
ENGINE												
300 GE	Petrol	125	09/89-09/97	M 103.987								
Engine	Information				A10	A20	A40	A50	A70	C10 - C30	C20	E01
All engines	version Bosch						1.306.237	1.406.125R				
All engines										1.970.178	C10	1.501.657
ENGINE												
300 GE	Petrol	128	06/90-08/97	M 103.987								
Engine	Information				A10	A20	A40	A50	A70	C10 - C30	C20	E01
All engines	version Bosch						1.306.237	1.406.125R				
All engines										1.970.178	C10	1.501.657
ENGINE												
320 GE	Petrol	155	09/94-11/97	M 104.996								
Engine	Information				A10	A20	A40	A50	A70	C10 - C30	C20	E01
All engines	Qty: 3, without spark plug connector									1.970.316	C10	
All engines	incl. spark plug connector, Qty: 3									1.970.316K	C10	

A10 CONDENSER	A20 CONTACT SET	A40 DISTRIBUTOR CAP	A50 ROTOR	A70 PICK-UP
C10 COIL	C20 IGNITION MODULE	C30 ELECTRONIC IGNITION KIT	E01 IGNITION CABLE SET	

Vehicle	alim.	kW	Date	Engine	FUNCTIONS ON THE VEHICLE									
					A10	A20	A40	A50	A70	C10 - C30	C20	E01		
ENGINE														
500 GE	Petrol	177	09/93-12/94	M 117.965										
Engine	Information				A10	A20	A40	A50	A70	C10 - C30	C20	E01		
All engines	version Bosch						1.306.239	1.406.126R						
All engines										1.970.179	C10			
ENGINE														
G 320	Petrol	154	06/97-11/97	M 112.945										
Engine	Information				A10	A20	A40	A50	A70	C10 - C30	C20	E01		
All engines	Qty: 6									1.970.417	C10			
All engines													1.501.649	
ENGINE														
G 320	Petrol	155	09/94-12/97	M 104.996										
Engine	Information				A10	A20	A40	A50	A70	C10 - C30	C20	E01		
All engines	Qty: 3, without spark plug connector									1.970.316	C10			
All engines	incl. spark plug connector, Qty: 3									1.970.316K	C10			
ENGINE														
G 320	Petrol	158	07/97-08/04	M 112.945										
Engine	Information				A10	A20	A40	A50	A70	C10 - C30	C20	E01		
All engines	Qty: 6									1.970.417	C10			
All engines													1.501.649	
ENGINE														
G 36 AMG	Petrol	200	01/95-07/98	M 104.996 (AMG 3.6)										
Engine	Information				A10	A20	A40	A50	A70	C10 - C30	C20	E01		
All engines	Qty: 3, without spark plug connector									1.970.316	C10			
All engines	incl. spark plug connector, Qty: 3									1.970.316K	C10			
ENGINE														
G 500	Petrol	218	04/98->	M 113.962										
Engine	Information				A10	A20	A40	A50	A70	C10 - C30	C20	E01		
All engines	Qty: 8									1.970.417	C10			
ENGINE														
G 500	Petrol	285	01/07->	M 273.963, M 273.969										
Engine	Information				A10	A20	A40	A50	A70	C10 - C30	C20	E01		
All engines	Qty: 8									1.970.487	C10			
ENGINE														
G 500 GUARD	Petrol	0	06/10->	M 273.963										
Engine	Information				A10	A20	A40	A50	A70	C10 - C30	C20	E01		
All engines	Qty: 8									1.970.487	C10			
ENGINE														
G 55 AMG	Petrol	218	04/98->	M 113.962										
Engine	Information				A10	A20	A40	A50	A70	C10 - C30	C20	E01		
All engines	Qty: 8									1.970.417	C10			
ENGINE														
G 55 AMG	Petrol	260	04/99->	M 113.982										
Engine	Information				A10	A20	A40	A50	A70	C10 - C30	C20	E01		
All engines	Qty: 8									1.970.417	C10			
ENGINE														
G 55 AMG	Petrol	350	06/04->	M 113.993										
Engine	Information				A10	A20	A40	A50	A70	C10 - C30	C20	E01		
All engines	Qty: 8									1.970.417	C10			
ENGINE														
G 55 AMG	Petrol	368	08/06-12/12	M 113.993										
Engine	Information				A10	A20	A40	A50	A70	C10 - C30	C20	E01		
All engines	Qty: 8									1.970.417	C10			
ENGINE														
G 55 AMG	Petrol	373	08/08->	M 113.993										
Engine	Information				A10	A20	A40	A50	A70	C10 - C30	C20	E01		
All engines	Qty: 8									1.970.417	C10			
ENGINE														
G 550	Petrol	0	06/10->	M 273.963, M 273.969										
Engine	Information				A10	A20	A40	A50	A70	C10 - C30	C20	E01		
All engines	Qty: 8									1.970.487	C10			

A10	CONDENSER	A20	CONTACT SET	A40	DISTRIBUTOR CAP	A50	ROTOR	A70	PICK-UP
C10	COIL	C20	IGNITION MODULE	C30	ELECTRONIC IGNITION KIT	E01	IGNITION CABLE SET		

The present application list is a brief version. For the detailed information about the possibility of installation on a specific vehicle, please refer to our web-catalogue <http://catalogo.facet.eu/>

Vehicle	alim.	kW	Date	Engine	FUNCTIONS ON THE VEHICLE							
					A10	A20	A40	A50	A70	C10 - C30	C20	E01

CLASSE GL I

				ENGINE
GL 450 4-matic	Petrol	250	09/06-08/12	M 273.923

Engine	Information	A10	A20	A40	A50	A70	C10 - C30	C20	E01
All engines	x 8, COIL ON PLUG						1.970.487	C10	

				ENGINE
GL 500 4-matic	Petrol	285	09/06-12/12	M 273.963

Engine	Information	A10	A20	A40	A50	A70	C10 - C30	C20	E01
All engines	x 8, COIL ON PLUG						1.970.487	C10	

				ENGINE
GL 550 4-matic	Petrol	285	09/06->	M 273.963

Engine	Information	A10	A20	A40	A50	A70	C10 - C30	C20	E01
All engines	Qty: 8						1.970.487	C10	

CLASSE GLA

				ENGINE
AMG GLA 45 4-matic	Petrol	280	07/15->	M 133.980

Engine	Information	A10	A20	A40	A50	A70	C10 - C30	C20	E01
All engines	x 4, DELPHI, without protection hose, COIL ON PLUG						1.970.626	C10	

				ENGINE
GLA 180	Petrol	90	02/15->	M 270.910

Engine	Information	A10	A20	A40	A50	A70	C10 - C30	C20	E01
All engines	SA A701, MADE BY: (TJ), x 4, without protection hose, COIL ON PLUG, FOR: (TJ)						1.970.626	C10	

				ENGINE
GLA 200	Petrol	110	07/18->	M 270.910

Engine	Information	A10	A20	A40	A50	A70	C10 - C30	C20	E01
All engines	x 4, without protection hose, COIL ON PLUG, FOR: (TJ)						1.970.626	C10	

				ENGINE
GLA 200	Petrol	115	12/13->	M 270.910

Engine	Information	A10	A20	A40	A50	A70	C10 - C30	C20	E01
All engines	MADE BY: (TJ), x 4, without protection hose, COIL ON PLUG, FOR: (TJ)						1.970.626	C10	

				ENGINE
GLA 220 4-matic	Petrol	135	01/17->	M 270.920

Engine	Information	A10	A20	A40	A50	A70	C10 - C30	C20	E01
All engines	x 4, DELPHI, without protection hose, COIL ON PLUG, without protection hose, COIL ON PLUG, FOR: (TJ)						1.970.626	C10	

				ENGINE
GLA 250	Petrol	155	12/13->	M 270.920

Engine	Information	A10	A20	A40	A50	A70	C10 - C30	C20	E01
All engines	MADE BY: (TJ), x 4, DELPHI, x 4, without protection hose, COIL ON PLUG, FOR: (TJ)						1.970.626	C10	

				ENGINE
GLA 250 4-matic	Petrol	155	12/13->	M 270.920

Engine	Information	A10	A20	A40	A50	A70	C10 - C30	C20	E01
All engines	MADE BY: (TJ), x 4, DELPHI, x 4, without protection hose, COIL ON PLUG, FOR: (TJ)						1.970.626	C10	

				ENGINE
GLA 250 Flex	Petrol/ Ethanol	155	01/15->	M 270.920

Engine	Information	A10	A20	A40	A50	A70	C10 - C30	C20	E01
All engines	x 4, DELPHI, without protection hose, COIL ON PLUG						1.970.626	C10	

				ENGINE
GLA 45 AMG 4-matic	Petrol	265	05/14->	M 133.980

Engine	Information	A10	A20	A40	A50	A70	C10 - C30	C20	E01
All engines	x 4, DELPHI, without protection hose, COIL ON PLUG						1.970.626	C10	

CLASSE GLC

				ENGINE
250 4-matic	Petrol	155	06/15-04/19	M 274.920

Engine	Information	A10	A20	A40	A50	A70	C10 - C30	C20	E01
All engines	SA A701/784K, x 4, DELPHI, without protection hose, x 4, COIL ON PLUG, without protection hose, COIL ON PLUG, FOR: (TJ), FOR: (TJ)						1.970.626	C10	

A10 CONDENSER	A20 CONTACT SET	A40 DISTRIBUTOR CAP	A50 ROTOR	A70 PICK-UP
C10 COIL	C20 IGNITION MODULE	C30 ELECTRONIC IGNITION KIT	E01 IGNITION CABLE SET	

Vehicle	alim.	kW	Date	Engine	FUNCTIONS ON THE VEHICLE								
					A10	A20	A40	A50	A70	C10 - C30	C20	E01	
ENGINE													
300 4-matic	Petrol	180	07/15-04/19	M 274.920									
Engine	Information				A10	A20	A40	A50	A70	C10 - C30	C20	E01	
All engines	MADE BY: (TJ), SA A701, x 4, DELPHI, MADE BY: (TJ), x 4, without protection hose, x 4, COIL ON PLUG, without protection hose, COIL ON PLUG, FOR: (TJ), FOR: (TJ)									1.970.626	C10		
ENGINE													
300 e 4-matic	Petrol/ Electric	155	11/19->	M 274.920									
Engine	Information				A10	A20	A40	A50	A70	C10 - C30	C20	E01	
All engines	x 4, DELPHI, without protection hose, COIL ON PLUG, without protection hose, COIL ON PLUG, FOR: (TJ)									1.970.626	C10		
ENGINE													
300 e 4-matic	Petrol/ Electric	235	11/19->	M 274.920									
Engine	Information				A10	A20	A40	A50	A70	C10 - C30	C20	E01	
All engines	x 4, DELPHI, without protection hose, COIL ON PLUG, without protection hose, COIL ON PLUG, FOR: (TJ)									1.970.626	C10		
ENGINE													
350 e 4-matic	Petrol/ Electric	155	01/16-04/19	M 274.920									
Engine	Information				A10	A20	A40	A50	A70	C10 - C30	C20	E01	
All engines	SA A701, SA A701/784K, x 4, DELPHI, MADE BY: (TJ), x 4, DELPHI, without protection hose, x 4, COIL ON PLUG, without protection hose, COIL ON PLUG, FOR: (TJ), FOR: (TJ) ----- x 4, without protection hose, COIL ON PLUG, FOR: (TJ)									1.970.626	C10		
ENGINE													
350 e 4-matic	Petrol/ Electric	235	01/16-04/19	M 274.920									
Engine	Information				A10	A20	A40	A50	A70	C10 - C30	C20	E01	
All engines	SA A701, SA A701/784K, x 4, DELPHI, MADE BY: (TJ), x 4, DELPHI, without protection hose, x 4, COIL ON PLUG, without protection hose, COIL ON PLUG, FOR: (TJ), FOR: (TJ) ----- x 4, without protection hose, COIL ON PLUG, FOR: (TJ)									1.970.626	C10		
CLASSE GLK													
ENGINE													
200	Petrol	135	08/13-06/15	M 274.920									
Engine	Information				A10	A20	A40	A50	A70	C10 - C30	C20	E01	
All engines	MADE BY: (TJ), x 4, DELPHI, x 4, without protection hose, COIL ON PLUG, FOR: (TJ)									1.970.626	C10		
ENGINE													
250	Petrol	155	08/13-06/15	M 274.920									
Engine	Information				A10	A20	A40	A50	A70	C10 - C30	C20	E01	
All engines	MADE BY: (TJ), x 4, DELPHI, x 4, without protection hose, COIL ON PLUG, FOR: (TJ)									1.970.626	C10		
ENGINE													
250 4-matic	Petrol	155	08/13-06/15	M 274.920									
Engine	Information				A10	A20	A40	A50	A70	C10 - C30	C20	E01	
All engines	MADE BY: (USA), x 4, DELPHI, x 4, without protection hose, COIL ON PLUG, FOR: (TJ)									1.970.626	C10		
ENGINE													
280 4-matic	Petrol	170	06/08-06/09	M 272.948									
Engine	Information				A10	A20	A40	A50	A70	C10 - C30	C20	E01	
All engines	x 6, COIL ON PLUG									1.970.487	C10		
ENGINE													
300 4-matic	Petrol	170	07/09-12/15	M 272.948									
Engine	Information				A10	A20	A40	A50	A70	C10 - C30	C20	E01	
All engines	x 6, COIL ON PLUG									1.970.487	C10		
ENGINE													
350	Petrol	200	04/09-06/15	M 272.991									
Engine	Information				A10	A20	A40	A50	A70	C10 - C30	C20	E01	
All engines	x 6, COIL ON PLUG									1.970.487	C10		
ENGINE													
350 4-matic	Petrol	200	06/08-04/11	M 272.971									
Engine	Information				A10	A20	A40	A50	A70	C10 - C30	C20	E01	
All engines	x 6, COIL ON PLUG									1.970.487	C10		

A10 CONDENSER	A20 CONTACT SET	A40 DISTRIBUTOR CAP	A50 ROTOR	A70 PICK-UP
C10 COIL	C20 IGNITION MODULE	C30 ELECTRONIC IGNITION KIT	E01 IGNITION CABLE SET	

The present application list is a brief version. For the detailed information about the possibility of installation on a specific vehicle, please refer to our web-catalogue <http://catalogo.facet.eu/>

Vehicle	alim.	kW	Date	Engine	FUNCTIONS ON THE VEHICLE							
					A10	A20	A40	A50	A70	C10 - C30	C20	E01

CLASSE M I

ML 230	Petrol	110	02/98-06/05	M 111.977
---------------	--------	------------	-------------	------------------

Engine	Information	A10	A20	A40	A50	A70	C10 - C30	C20	E01
All engines	x 2, SEMI-DIRECT, Dia: 4 mm, connector type, saw teeth						1.970.316	C10	

ML 320	Petrol	160	02/98-08/02	M 112.942
---------------	--------	------------	-------------	------------------

Engine	Information	A10	A20	A40	A50	A70	C10 - C30	C20	E01
All engines	x 6, COIL ON PLUG						1.970.417	C10	
All engines									1.501.649

ML 350	Petrol	173	02/03-06/05	M 112.970
---------------	--------	------------	-------------	------------------

Engine	Information	A10	A20	A40	A50	A70	C10 - C30	C20	E01
All engines	x 6, COIL ON PLUG						1.970.417	C10	
All engines									1.501.649

ML 350	Petrol	180	08/02-06/05	M 112.970
---------------	--------	------------	-------------	------------------

Engine	Information	A10	A20	A40	A50	A70	C10 - C30	C20	E01
All engines	x 6, COIL ON PLUG						1.970.417	C10	
All engines									1.501.649

ML 430	Petrol	200	02/98-06/05	M 113.942
---------------	--------	------------	-------------	------------------

Engine	Information	A10	A20	A40	A50	A70	C10 - C30	C20	E01
All engines	x 8, COIL ON PLUG						1.970.417	C10	

ML 500	Petrol	215	09/01-06/05	M 113.965
---------------	--------	------------	-------------	------------------

Engine	Information	A10	A20	A40	A50	A70	C10 - C30	C20	E01
All engines	x 8, COIL ON PLUG						1.970.417	C10	

ML 55 AMG	Petrol	255	02/00-06/05	M 113.981
------------------	--------	------------	-------------	------------------

Engine	Information	A10	A20	A40	A50	A70	C10 - C30	C20	E01
All engines	x 8, COIL ON PLUG						1.970.417	C10	

CLASSE M II

ML 300	Petrol	0	07/09->	M 272.945
---------------	--------	----------	---------	------------------

Engine	Information	A10	A20	A40	A50	A70	C10 - C30	C20	E01
All engines	Qty: 6						1.970.487	C10	

ML 300 4-matic	Petrol	170	03/10-12/11	M 272.945
-----------------------	--------	------------	-------------	------------------

Engine	Information	A10	A20	A40	A50	A70	C10 - C30	C20	E01
All engines	x 6, COIL ON PLUG						1.970.487	C10	

ML 350	Petrol	200	07/05->	M 272.967
---------------	--------	------------	---------	------------------

Engine	Information	A10	A20	A40	A50	A70	C10 - C30	C20	E01
All engines	Qty: 6						1.970.487	C10	

ML 350 4-matic	Petrol	200	02/05-12/11	M 272.967
-----------------------	--------	------------	-------------	------------------

Engine	Information	A10	A20	A40	A50	A70	C10 - C30	C20	E01
All engines	x 6, COIL ON PLUG						1.970.487	C10	

ML 500 4-matic	Petrol	225	07/05-12/11	M 113.964
-----------------------	--------	------------	-------------	------------------

Engine	Information	A10	A20	A40	A50	A70	C10 - C30	C20	E01
All engines	x 8, COIL ON PLUG						1.970.417	C10	

ML 500 4-matic	Petrol	285	12/07-12/11	M 273.963
-----------------------	--------	------------	-------------	------------------

Engine	Information	A10	A20	A40	A50	A70	C10 - C30	C20	E01
All engines	x 8, COIL ON PLUG						1.970.487	C10	

ML 550 4-matic	Petrol	285	12/07->	M 273.963
-----------------------	--------	------------	---------	------------------

Engine	Information	A10	A20	A40	A50	A70	C10 - C30	C20	E01
All engines	Qty: 8						1.970.487	C10	

A10 CONDENSER	A20 CONTACT SET	A40 DISTRIBUTOR CAP	A50 ROTOR	A70 PICK-UP
C10 COIL	C20 IGNITION MODULE	C30 ELECTRONIC IGNITION KIT	E01 IGNITION CABLE SET	

Vehicle	alim.	kW	Date	Engine	FUNCTIONS ON THE VEHICLE							
					A10	A20	A40	A50	A70	C10 - C30	C20	E01

CLASSE R

				ENGINE
R 280	Petrol	170	01/07-12/14	M 272.945

Engine	Information	A10	A20	A40	A50	A70	C10 - C30	C20	E01
All engines	x 6, COIL ON PLUG						1.970.487	C10	

				ENGINE
R 280 4-matic	Petrol	170	05/07-12/11	M 272.945

Engine	Information	A10	A20	A40	A50	A70	C10 - C30	C20	E01
All engines	x 6, COIL ON PLUG						1.970.487	C10	

				ENGINE
R 300	Petrol	170	07/09-12/14	M 272.945

Engine	Information	A10	A20	A40	A50	A70	C10 - C30	C20	E01
All engines	x 6, COIL ON PLUG						1.970.487	C10	

				ENGINE
R 300 4-matic	Petrol	170	07/09->	M 272.945

Engine	Information	A10	A20	A40	A50	A70	C10 - C30	C20	E01
All engines	Qty: 6						1.970.487	C10	
All engines	x 6, COIL ON PLUG						1.970.487	C10	

				ENGINE
R 350	Petrol	200	01/07-12/12	M 272.967

Engine	Information	A10	A20	A40	A50	A70	C10 - C30	C20	E01
All engines	x 6, COIL ON PLUG						1.970.487	C10	

				ENGINE
R 350 4-matic	Petrol	200	08/05-12/12	M 272.967

Engine	Information	A10	A20	A40	A50	A70	C10 - C30	C20	E01
All engines	x 6, COIL ON PLUG						1.970.487	C10	

				ENGINE
R 500 4-matic	Petrol	225	08/05-12/14	M 113.971

Engine	Information	A10	A20	A40	A50	A70	C10 - C30	C20	E01
All engines	x 8, COIL ON PLUG						1.970.417	C10	

				ENGINE
R 500 4-matic	Petrol	285	05/07-12/14	M 273.963

Engine	Information	A10	A20	A40	A50	A70	C10 - C30	C20	E01
All engines	x 8, COIL ON PLUG						1.970.487	C10	

				ENGINE
R 550 4-matic	Petrol	285	01/07->	M 273.963

Engine	Information	A10	A20	A40	A50	A70	C10 - C30	C20	E01
All engines	Qty: 8						1.970.487	C10	

CLASSE S I

				ENGINE
250 S	Petrol	96	01/66-12/69	M 108.920

Engine	Information	A10	A20	A40	A50	A70	C10 - C30	C20	E01
All engines					1.406.018R				

				ENGINE
250 SE	Petrol	110	01/66-12/67	M 129.980

Engine	Information	A10	A20	A40	A50	A70	C10 - C30	C20	E01
All engines			1.206.021		1.406.018R				

				ENGINE
280 S	Petrol	103	10/67-07/72	M 130.920

Engine	Information	A10	A20	A40	A50	A70	C10 - C30	C20	E01
All engines					1.406.018R				

				ENGINE
280 S	Petrol	118	08/72-07/80	M 110.922

Engine	Information	A10	A20	A40	A50	A70	C10 - C30	C20	E01
All engines			1.206.029HV						

				ENGINE
280 SE, SEL	Petrol	118	01/68-08/72	M 130.980

Engine	Information	A10	A20	A40	A50	A70	C10 - C30	C20	E01
All engines					1.406.018R				

A10 CONDENSER	A20 CONTACT SET	A40 DISTRIBUTOR CAP	A50 ROTOR	A70 PICK-UP
C10 COIL	C20 IGNITION MODULE	C30 ELECTRONIC IGNITION KIT	E01 IGNITION CABLE SET	

The present application list is a brief version. For the detailed information about the possibility of installation on a specific vehicle, please refer to our web-catalogue <http://catalogo.facet.eu/>

Vehicle	alim.	kW	Date	Engine	FUNCTIONS ON THE VEHICLE							
					A10	A20	A40	A50	A70	C10 - C30	C20	E01

CLASSE S II

				ENGINE
260 SE	Petrol	118	09/85-06/91	M 103.941

Engine	Information	A10	A20	A40	A50	A70	C10 - C30	C20	E01
All engines	version Bosch			1.306.237	1.406.125R				
All engines							1.970.178	C10	

				ENGINE
260 SE	Petrol	122	09/85-06/91	M 103.941

Engine	Information	A10	A20	A40	A50	A70	C10 - C30	C20	E01
All engines	version Bosch			1.306.237	1.406.125R				
All engines							1.970.178	C10	

				ENGINE
280 S	Petrol	115	12/79-07/85	M 110.924

Engine	Information	A10	A20	A40	A50	A70	C10 - C30	C20	E01
All engines	version Bosch			1.306.092	1.406.034R				

				ENGINE
280 SE, SEL	Petrol	136	10/79-07/85	M 110.989

Engine	Information	A10	A20	A40	A50	A70	C10 - C30	C20	E01
All engines	version Bosch			1.306.123	1.406.060R				
All engines									1.501.323

				ENGINE
300 SE, SEL	Petrol	132	01/86-06/91	M 103.981

Engine	Information	A10	A20	A40	A50	A70	C10 - C30	C20	E01
All engines	version Bosch			1.306.237	1.406.125R				
All engines							1.970.178	C10	

				ENGINE
300 SE, SEL	Petrol	138	09/85-12/89	M 103.981

Engine	Information	A10	A20	A40	A50	A70	C10 - C30	C20	E01
All engines	version Bosch			1.306.237	1.406.125R				
All engines							1.970.178	C10	

				ENGINE
380 SE, SEL	Petrol	150	10/81-08/85	M 116.963

Engine	Information	A10	A20	A40	A50	A70	C10 - C30	C20	E01
All engines	version Bosch			1.306.090	1.406.049R				
All engines							1.970.178	C10	

				ENGINE
380 SE, SEL	Petrol	160	09/80-10/81	M 116.961

Engine	Information	A10	A20	A40	A50	A70	C10 - C30	C20	E01
All engines	version Bosch			1.306.090					
All engines	eng. type 01396 ->, version Bosch				1.406.023R				

				ENGINE
380 SEC	Petrol	150	10/81-07/85	M 116.963

Engine	Information	A10	A20	A40	A50	A70	C10 - C30	C20	E01
All engines	version Bosch			1.306.090	1.406.049R				
All engines							1.970.178	C10	

				ENGINE
420 SE, SEL	Petrol	150	10/85-06/91	M 116.965

Engine	Information	A10	A20	A40	A50	A70	C10 - C30	C20	E01
All engines	version Bosch			1.306.239	1.406.126R				
All engines							1.970.179	C10	

				ENGINE
420 SE, SEL	Petrol	160	10/85-12/87	M 116.965

Engine	Information	A10	A20	A40	A50	A70	C10 - C30	C20	E01
All engines	version Bosch			1.306.239	1.406.126R				
All engines							1.970.179	C10	

				ENGINE
420 SE, SEL	Petrol	165	10/85-06/91	M 116.965

Engine	Information	A10	A20	A40	A50	A70	C10 - C30	C20	E01
All engines	version Bosch			1.306.239	1.406.126R				
All engines							1.970.179	C10	

A10 CONDENSER	A20 CONTACT SET	A40 DISTRIBUTOR CAP	A50 ROTOR	A70 PICK-UP
C10 COIL	C20 IGNITION MODULE	C30 ELECTRONIC IGNITION KIT	E01 IGNITION CABLE SET	

Vehicle	alim.	kW	Date	Engine	FUNCTIONS ON THE VEHICLE								
					A10	A20	A40	A50	A70	C10 - C30	C20	E01	
ENGINE													
420 SE, SEL	Petrol	170	10/85-12/87	M 116.965									
Engine	Information				A10	A20	A40	A50	A70	C10 - C30	C20	E01	
All engines	version Bosch						1.306.239	1.406.126R					
All engines										1.970.179	C10		
ENGINE													
420 SEC	Petrol	150	10/85-06/91	M 116.965									
Engine	Information				A10	A20	A40	A50	A70	C10 - C30	C20	E01	
All engines	version Bosch						1.306.239	1.406.126R					
All engines										1.970.179	C10		
ENGINE													
420 SEC	Petrol	160	10/85-12/87	M 116.965									
Engine	Information				A10	A20	A40	A50	A70	C10 - C30	C20	E01	
All engines	version Bosch						1.306.239	1.406.126R					
All engines										1.970.179	C10		
ENGINE													
420 SEC	Petrol	165	10/85-06/91	M 116.965									
Engine	Information				A10	A20	A40	A50	A70	C10 - C30	C20	E01	
All engines	version Bosch						1.306.239	1.406.126R					
All engines										1.970.179	C10		
ENGINE													
500 SE, SEL	Petrol	164	09/85-06/91	M 117.965									
Engine	Information				A10	A20	A40	A50	A70	C10 - C30	C20	E01	
All engines	version Bosch						1.306.239	1.406.126R					
All engines										1.970.179	C10		
ENGINE													
500 SE, SEL	Petrol	170	12/79-08/85	M 117.961, M 117.963									
Engine	Information				A10	A20	A40	A50	A70	C10 - C30	C20	E01	
All engines	version Bosch						1.306.090						
Eng. M 117.961	version Bosch							1.406.023R					
Eng. M 117.963	version Bosch							1.406.049R					
All engines										1.970.178	C10		
ENGINE													
500 SE, SEL	Petrol	177	12/79-08/85	M 117.961, M 117.963									
Engine	Information				A10	A20	A40	A50	A70	C10 - C30	C20	E01	
All engines	version Bosch						1.306.090						
Eng. M 117.961	version Bosch							1.406.023R					
Eng. M 117.963	version Bosch							1.406.049R					
All engines										1.970.178	C10		
ENGINE													
500 SE, SEL	Petrol	180	09/85-06/91	M 117.965									
Engine	Information				A10	A20	A40	A50	A70	C10 - C30	C20	E01	
All engines	version Bosch						1.306.239	1.406.126R					
All engines										1.970.179	C10		
ENGINE													
500 SE, SEL	Petrol	185	09/87-06/91	M 117.965									
Engine	Information				A10	A20	A40	A50	A70	C10 - C30	C20	E01	
All engines	version Bosch						1.306.239	1.406.126R					
All engines										1.970.179	C10		
ENGINE													
500 SE, SEL	Petrol	195	09/87-06/91	M 117.965									
Engine	Information				A10	A20	A40	A50	A70	C10 - C30	C20	E01	
All engines	version Bosch						1.306.239	1.406.126R					
All engines										1.970.179	C10		
ENGINE													
500 SE, SEL Cat	Petrol	185	06/89-06/91	M 117.965									
Engine	Information				A10	A20	A40	A50	A70	C10 - C30	C20	E01	
All engines	version Bosch						1.306.239	1.406.126R					
All engines										1.970.179	C10		

A10	CONDENSER	A20	CONTACT SET	A40	DISTRIBUTOR CAP	A50	ROTOR	A70	PICK-UP
C10	COIL	C20	IGNITION MODULE	C30	ELECTRONIC IGNITION KIT	E01	IGNITION CABLE SET		

The present application list is a brief version. For the detailed information about the possibility of installation on a specific vehicle, please refer to our web-catalogue <http://catalogo.facet.eu/>









Vehicle	alim.	kW	Date	Engine	FUNCTIONS ON THE VEHICLE									
					A10	A20	A40	A50	A70	C10 - C30	C20	E01		
ENGINE														
500 SEC	Petrol	164	10/85-06/91	M 117.965										
Engine	Information				A10	A20	A40	A50	A70	C10 - C30	C20	E01		
All engines	version Bosch						1.306.239	1.406.126R						
All engines										1.970.179	C10			
ENGINE														
500 SEC	Petrol	170	10/81-08/85	M 117.963										
Engine	Information				A10	A20	A40	A50	A70	C10 - C30	C20	E01		
All engines	version Bosch						1.306.090	1.406.049R						
All engines										1.970.178	C10			
ENGINE														
500 SEC	Petrol	177	08/80-08/85	M 117.963										
Engine	Information				A10	A20	A40	A50	A70	C10 - C30	C20	E01		
All engines	version Bosch						1.306.090	1.406.049R						
All engines										1.970.178	C10			
ENGINE														
500 SEC	Petrol	180	09/85-06/91	M 117.965										
Engine	Information				A10	A20	A40	A50	A70	C10 - C30	C20	E01		
All engines	version Bosch						1.306.239	1.406.126R						
All engines										1.970.179	C10			
ENGINE														
500 SEC	Petrol	185	08/87-06/91	M 117.965										
Engine	Information				A10	A20	A40	A50	A70	C10 - C30	C20	E01		
All engines	version Bosch						1.306.239	1.406.126R						
All engines										1.970.179	C10			
ENGINE														
500 SEC	Petrol	195	09/85-06/91	M 117.965										
Engine	Information				A10	A20	A40	A50	A70	C10 - C30	C20	E01		
All engines	version Bosch						1.306.239	1.406.126R						
All engines										1.970.179	C10			
ENGINE														
500 SEC Cat	Petrol	185	06/89-06/91	M 117.965										
Engine	Information				A10	A20	A40	A50	A70	C10 - C30	C20	E01		
All engines	version Bosch						1.306.239	1.406.126R						
All engines										1.970.179	C10			
ENGINE														
560 SE, SEL	Petrol	178	10/85-06/91	M 117.968										
Engine	Information				A10	A20	A40	A50	A70	C10 - C30	C20	E01		
All engines	version Bosch						1.306.239	1.406.126R						
All engines										1.970.179	C10			
ENGINE														
560 SE, SEL	Petrol	200	10/85-12/87	M 117.968										
Engine	Information				A10	A20	A40	A50	A70	C10 - C30	C20	E01		
All engines	version Bosch						1.306.239	1.406.126R						
All engines										1.970.179	C10			
ENGINE														
560 SE, SEL	Petrol	205	08/87-06/91	M 117.968										
Engine	Information				A10	A20	A40	A50	A70	C10 - C30	C20	E01		
All engines	version Bosch						1.306.239	1.406.126R						
All engines										1.970.179	C10			
ENGINE														
560 SE, SEL	Petrol	220	10/85-06/91	M 117.968										
Engine	Information				A10	A20	A40	A50	A70	C10 - C30	C20	E01		
All engines	version Bosch						1.306.239	1.406.126R						
All engines										1.970.179	C10			
ENGINE														
560 SEC	Petrol	178	10/85-06/91	M 117.968										
Engine	Information				A10	A20	A40	A50	A70	C10 - C30	C20	E01		
All engines	version Bosch						1.306.239	1.406.126R						
All engines										1.970.179	C10			

A10 CONDENSER	A20 CONTACT SET	A40 DISTRIBUTOR CAP	A50 ROTOR	A70 PICK-UP
C10 COIL	C20 IGNITION MODULE	C30 ELECTRONIC IGNITION KIT	E01 IGNITION CABLE SET	

Vehicle	alim.	kW	Date	Engine	FUNCTIONS ON THE VEHICLE									
					A10	A20	A40	A50	A70	C10 - C30	C20	E01		
ENGINE														
560 SEC	Petrol	200	10/85-12/87	M 117.968										
Engine	Information				A10	A20	A40	A50	A70	C10 - C30	C20	E01		
All engines	version Bosch						1.306.239	1.406.126R						
All engines										1.970.179	C10			
ENGINE														
560 SEC	Petrol	205	10/85-06/91	M 117.968										
Engine	Information				A10	A20	A40	A50	A70	C10 - C30	C20	E01		
All engines	version Bosch						1.306.239	1.406.126R						
All engines										1.970.179	C10			
ENGINE														
560 SEC	Petrol	220	10/85-12/89	M 117.968										
Engine	Information				A10	A20	A40	A50	A70	C10 - C30	C20	E01		
All engines	version Bosch						1.306.239	1.406.126R						
All engines										1.970.179	C10			
CLASSE S III														
ENGINE														
300 SE 2.8	Petrol	145	01/93-10/98	M 104.944										
Engine	Information				A10	A20	A40	A50	A70	C10 - C30	C20	E01		
All engines	Qty: 3, without spark plug connector									1.970.316	C10			
All engines	incl. spark plug connector, Qty: 3									1.970.316K	C10			
ENGINE														
300 SE, SEL/S320	Petrol	170	03/91-10/98	M 104.994										
Engine	Information				A10	A20	A40	A50	A70	C10 - C30	C20	E01		
All engines	Qty: 3, without spark plug connector									1.970.316	C10			
All engines	incl. spark plug connector, Qty: 3									1.970.316K	C10			
ENGINE														
400 SE, SEL/S420	Petrol	210	02/91-10/98	M 119.971										
Engine	Information				A10	A20	A40	A50	A70	C10 - C30	C20	E01		
All engines	Qty: 2, version Bosch							1.406.146R						
All engines	->ch. A 006502, Qty: 2, NOT FOR: (USA)									1.970.178	C10			
ENGINE														
500 SE, SEL	Petrol	240	02/91-10/98	M 119.970										
Engine	Information				A10	A20	A40	A50	A70	C10 - C30	C20	E01		
All engines	Qty: 2, version Bosch							1.406.146R						
All engines	->ch. A 006502, Qty: 2, NOT FOR: (USA)									1.970.178	C10			
ENGINE														
500 SEC / CL 500	Petrol	235	10/92-12/99	M 119.970										
Engine	Information				A10	A20	A40	A50	A70	C10 - C30	C20	E01		
All engines	Qty: 2, version Bosch							1.406.146R						
All engines	->ch. A 006502, Qty: 2, NOT FOR: (USA)									1.970.178	C10			
ENGINE														
600 SE, SEL	Petrol	300	04/91-12/92	M 120.980										
Engine	Information				A10	A20	A40	A50	A70	C10 - C30	C20	E01		
All engines	FP: right									1.970.179	C10			
ENGINE														
S 280	Petrol	142	02/93-10/98	M 104.944										
Engine	Information				A10	A20	A40	A50	A70	C10 - C30	C20	E01		
All engines	Qty: 3, without spark plug connector									1.970.316	C10			
All engines	incl. spark plug connector, Qty: 3									1.970.316K	C10			
ENGINE														
S 420	Petrol	205	01/93-10/98	M 119.971										
Engine	Information				A10	A20	A40	A50	A70	C10 - C30	C20	E01		
All engines	Qty: 2, version Bosch							1.406.146R						
All engines	->ch. A 006502, Qty: 2, NOT FOR: (USA)									1.970.178	C10			
ENGINE														
S 500	Petrol	235	01/93-10/98	M 119.970										
Engine	Information				A10	A20	A40	A50	A70	C10 - C30	C20	E01		
All engines	Qty: 2, version Bosch							1.406.146R						
All engines	->ch. A 006502, Qty: 2, NOT FOR: (USA)									1.970.178	C10			

A10	CONDENSER	A20	CONTACT SET	A40	DISTRIBUTOR CAP	A50	ROTOR	A70	PICK-UP
C10	COIL	C20	IGNITION MODULE	C30	ELECTRONIC IGNITION KIT	E01	IGNITION CABLE SET		

The present application list is a brief version. For the detailed information about the possibility of installation on a specific vehicle, please refer to our web-catalogue <http://catalogo.facet.eu/>









				FUNCTIONS ON THE VEHICLE								
Vehicle	alim.	kW	Date	Engine	 A10	 A20	 A40	 A50	 A70	 C10 - C30	 C20	 E01
				ENGINE								
S 600	Petrol	290	01/93-10/98	M 120.980								
				ENGINE								
Engine		Information			A10	A20	A40	A50	A70	C10 - C30	C20	E01
All engines		FP: right								1.970.179	C10	
				ENGINE								
SEC/CL 420	Petrol	205	10/94-02/99	M 119.971								
				ENGINE								
Engine		Information			A10	A20	A40	A50	A70	C10 - C30	C20	E01
All engines		Qty: 2, version Bosch						1.406.146R				
All engines		->ch. A 006502, Qty: 2, NOT FOR: (USA)								1.970.178	C10	
				ENGINE								
SEC/CL 600	Petrol	290	09/92-02/99	M 120.980								
				ENGINE								
Engine		Information			A10	A20	A40	A50	A70	C10 - C30	C20	E01
All engines		FP: right								1.970.179	C10	
CLASSE S IV												
				ENGINE								
S 280	Petrol	150	10/98-08/05	M 112.922								
				ENGINE								
Engine		Information			A10	A20	A40	A50	A70	C10 - C30	C20	E01
All engines		x 6, COIL ON PLUG								1.970.417	C10	
All engines												1.501.649
				ENGINE								
S 320	Petrol	165	10/98-08/05	M 112.944								
				ENGINE								
Engine		Information			A10	A20	A40	A50	A70	C10 - C30	C20	E01
All engines		x 6, COIL ON PLUG								1.970.417	C10	
All engines												1.501.649
				ENGINE								
S 350	Petrol	180	09/02-08/05	M 112.972								
				ENGINE								
Engine		Information			A10	A20	A40	A50	A70	C10 - C30	C20	E01
All engines		x 6, COIL ON PLUG								1.970.417	C10	
All engines												1.501.649
				ENGINE								
S 350 4-matic	Petrol	180	06/03-08/05	M 112.975								
				ENGINE								
Engine		Information			A10	A20	A40	A50	A70	C10 - C30	C20	E01
All engines		x 6, COIL ON PLUG								1.970.417	C10	
All engines												1.501.649
				ENGINE								
S 430	Petrol	205	10/98-08/05	M 113.941								
				ENGINE								
Engine		Information			A10	A20	A40	A50	A70	C10 - C30	C20	E01
All engines		x 8, COIL ON PLUG								1.970.417	C10	
				ENGINE								
S 430 4-matic	Petrol	205	09/02-08/05	M 113.948								
				ENGINE								
Engine		Information			A10	A20	A40	A50	A70	C10 - C30	C20	E01
All engines		x 8, COIL ON PLUG								1.970.417	C10	
				ENGINE								
S 500	Petrol	220	10/98-12/03	M 113.960								
				ENGINE								
Engine		Information			A10	A20	A40	A50	A70	C10 - C30	C20	E01
All engines		x 8, COIL ON PLUG								1.970.417	C10	
				ENGINE								
S 500	Petrol	225	10/98-08/05	M 113.960								
				ENGINE								
Engine		Information			A10	A20	A40	A50	A70	C10 - C30	C20	E01
All engines		x 8, COIL ON PLUG								1.970.417	C10	
				ENGINE								
S 500 4-matic	Petrol	225	09/02-08/05	M 113.966								
				ENGINE								
Engine		Information			A10	A20	A40	A50	A70	C10 - C30	C20	E01
All engines		x 8, COIL ON PLUG								1.970.417	C10	
				ENGINE								
S 55 AMG	Petrol	265	04/99-08/05	M 113.986								
				ENGINE								
Engine		Information			A10	A20	A40	A50	A70	C10 - C30	C20	E01
All engines		x 8, COIL ON PLUG								1.970.417	C10	

A10 CONDENSER	A20 CONTACT SET	A40 DISTRIBUTOR CAP	A50 ROTOR	A70 PICK-UP
C10 COIL	C20 IGNITION MODULE	C30 ELECTRONIC IGNITION KIT	E01 IGNITION CABLE SET	

Vehicle	alim.	kW	Date	Engine	FUNCTIONS ON THE VEHICLE							
					A10	A20	A40	A50	A70	C10 - C30	C20	E01
S 55 AMG Kompressor Petrol 368 06/02-08/05 M 113.991					ENGINE							
Engine Information					A10	A20	A40	A50	A70	C10 - C30	C20	E01
All engines x 8, COIL ON PLUG										1.970.417	C10	
CLASSE S V					ENGINE							
CL 550 [JPN] Petrol 285 06/06-> M 273.961					ENGINE							
Engine Information					A10	A20	A40	A50	A70	C10 - C30	C20	E01
All engines Qty: 8										1.970.487	C10	
CL 550 [USA] Petrol 285 06/06-> M 273.961					ENGINE							
Engine Information					A10	A20	A40	A50	A70	C10 - C30	C20	E01
All engines Qty: 8										1.970.487	C10	
CL 550 4-matic [JPN] Petrol 285 02/08-> M 273.968					ENGINE							
Engine Information					A10	A20	A40	A50	A70	C10 - C30	C20	E01
All engines Qty: 8										1.970.487	C10	
CL 550 4-matic [USA] Petrol 285 02/08-> M 273.968					ENGINE							
Engine Information					A10	A20	A40	A50	A70	C10 - C30	C20	E01
All engines Qty: 8										1.970.487	C10	
S 280 Petrol 170 08/06-12/13 M 272.946					ENGINE							
Engine Information					A10	A20	A40	A50	A70	C10 - C30	C20	E01
All engines x 6, COIL ON PLUG										1.970.487	C10	
S 300 Petrol 170 08/06-12/13 M 272.946					ENGINE							
Engine Information					A10	A20	A40	A50	A70	C10 - C30	C20	E01
All engines x 6, COIL ON PLUG										1.970.487	C10	
S 350 Petrol 200 10/05-12/13 M 272.965					ENGINE							
Engine Information					A10	A20	A40	A50	A70	C10 - C30	C20	E01
All engines x 6, COIL ON PLUG										1.970.487	C10	
S 350 4-matic Petrol 200 02/08-12/13 M 272.975					ENGINE							
Engine Information					A10	A20	A40	A50	A70	C10 - C30	C20	E01
All engines x 6, COIL ON PLUG										1.970.487	C10	
S 400 Hybrid Petrol/ Electric 205 01/09-12/13 M 272.974					ENGINE							
Engine Information					A10	A20	A40	A50	A70	C10 - C30	C20	E01
All engines x 6, COIL ON PLUG										1.970.487	C10	
S 450 Petrol 250 12/05-12/13 M 273.922					ENGINE							
Engine Information					A10	A20	A40	A50	A70	C10 - C30	C20	E01
All engines x 8, COIL ON PLUG										1.970.487	C10	
S 450 4-matic Petrol 250 12/05-12/13 M 273.924					ENGINE							
Engine Information					A10	A20	A40	A50	A70	C10 - C30	C20	E01
All engines x 8, COIL ON PLUG										1.970.487	C10	
S 500 Petrol 285 10/05-12/13 M 273.961					ENGINE							
Engine Information					A10	A20	A40	A50	A70	C10 - C30	C20	E01
All engines x 8, COIL ON PLUG										1.970.487	C10	
S 500 4-matic Petrol 285 10/05-12/13 M 273.968					ENGINE							
Engine Information					A10	A20	A40	A50	A70	C10 - C30	C20	E01
All engines x 8, COIL ON PLUG										1.970.487	C10	

A10 CONDENSER	A20 CONTACT SET	A40 DISTRIBUTOR CAP	A50 ROTOR	A70 PICK-UP
C10 COIL	C20 IGNITION MODULE	C30 ELECTRONIC IGNITION KIT	E01 IGNITION CABLE SET	

The present application list is a brief version. For the detailed information about the possibility of installation on a specific vehicle, please refer to our web-catalogue <http://catalogo.facet.eu/>

				FUNCTIONS ON THE VEHICLE								
Vehicle	alim.	kW	Date	Engine								
				ENGINE								
S 550 [JPN]	Petrol	285	10/05->	M 273.961								
				ENGINE								
Engine		Information			A10	A20	A40	A50	A70	C10 - C30	C20	E01
All engines		Qty: 8								1.970.487	C10	
S 550 [USA]	Petrol	285	10/05->	M 273.961								
				ENGINE								
Engine		Information			A10	A20	A40	A50	A70	C10 - C30	C20	E01
All engines		Qty: 8								1.970.487	C10	
S 550 4-matic [JPN]	Petrol	285	10/05->	M 273.968								
				ENGINE								
Engine		Information			A10	A20	A40	A50	A70	C10 - C30	C20	E01
All engines		Qty: 8								1.970.487	C10	
S 550 4-matic [USA]	Petrol	285	10/05->	M 273.968								
				ENGINE								
Engine		Information			A10	A20	A40	A50	A70	C10 - C30	C20	E01
All engines		Qty: 8								1.970.487	C10	
				ENGINE								
190 SL	Petrol	77	01/55-12/63	M 121.921, M 121.928								
				ENGINE								
Engine		Information			A10	A20	A40	A50	A70	C10 - C30	C20	E01
All engines						1.206.029HV	1.306.062	1.406.018R				
				ENGINE								
280 SL	Petrol	130	06/76-09/81	M 110.986								
				ENGINE								
Engine		Information			A10	A20	A40	A50	A70	C10 - C30	C20	E01
All engines		version Bosch					1.306.092	1.406.034R				
280 SLC	Petrol	130	06/76-09/81	M 110.986								
				ENGINE								
Engine		Information			A10	A20	A40	A50	A70	C10 - C30	C20	E01
All engines		version Bosch					1.306.092	1.406.034R				
300 SL	Petrol	132	09/85-08/89	M 103.982								
				ENGINE								
Engine		Information			A10	A20	A40	A50	A70	C10 - C30	C20	E01
All engines						1.206.021				1.970.178	C10	1.501.657
All engines		version Bosch					1.306.237	1.406.125R				
300 SL	Petrol	138	09/85-08/89	M 103.982								
				ENGINE								
Engine		Information			A10	A20	A40	A50	A70	C10 - C30	C20	E01
All engines						1.206.021				1.970.178	C10	1.501.657
All engines		version Bosch					1.306.237	1.406.125R				
380 SL	Petrol	150	09/80-08/85	M 116.962								
				ENGINE								
Engine		Information			A10	A20	A40	A50	A70	C10 - C30	C20	E01
All engines		version Bosch					1.306.090	1.406.049R				
380 SL	Petrol	160	09/80-08/81	M 116.960								
				ENGINE								
Engine		Information			A10	A20	A40	A50	A70	C10 - C30	C20	E01
All engines		version Bosch					1.306.090					
All engines		eng. type 00016 ->, version Bosch						1.406.023R				
420 SL	Petrol	150	01/86-08/89	M 116.964								
				ENGINE								
Engine		Information			A10	A20	A40	A50	A70	C10 - C30	C20	E01
All engines		version Bosch					1.306.239	1.406.126R				
420 SL	Petrol	160	01/86-08/89	M 116.964								
				ENGINE								
Engine		Information			A10	A20	A40	A50	A70	C10 - C30	C20	E01
All engines		version Bosch					1.306.239	1.406.126R				
500 SL	Petrol	164	01/86-08/89	M 117.964								
				ENGINE								
Engine		Information			A10	A20	A40	A50	A70	C10 - C30	C20	E01
All engines		version Bosch					1.306.239	1.406.126R				

A10 CONDENSER	A20 CONTACT SET	A40 DISTRIBUTOR CAP	A50 ROTOR	A70 PICK-UP
C10 COIL	C20 IGNITION MODULE	C30 ELECTRONIC IGNITION KIT	E01 IGNITION CABLE SET	

Vehicle	alim.	kW	Date	Engine	FUNCTIONS ON THE VEHICLE									
					A10	A20	A40	A50	A70	C10 - C30	C20	E01		
ENGINE														
500 SL	Petrol	180	01/86-08/89	M 117.964										
Engine		Information			A10	A20	A40	A50	A70	C10 - C30	C20	E01		
All engines		version Bosch					1.306.239	1.406.126R						
ENGINE														
560 SL	Petrol	169	09/85-12/89	M 117.967										
Engine		Information			A10	A20	A40	A50	A70	C10 - C30	C20	E01		
All engines		version Bosch					1.306.239	1.406.126R						
CLASSE SL IV														
ENGINE														
280	Petrol	142	08/93-10/01	M 104.943										
Engine		Information			A10	A20	A40	A50	A70	C10 - C30	C20	E01		
All engines		Qty: 3, without spark plug connector								1.970.316	C10			
All engines		incl. spark plug connector, Qty: 3								1.970.316K	C10			
ENGINE														
280	Petrol	150	05/98-10/01	M 112.923										
Engine		Information			A10	A20	A40	A50	A70	C10 - C30	C20	E01		
All engines		Qty: 6								1.970.417	C10			
All engines													1.501.649	
ENGINE														
300 SL	Petrol	140	03/89-08/93	M 103.984										
Engine		Information			A10	A20	A40	A50	A70	C10 - C30	C20	E01		
All engines		version Bosch					1.306.237	1.406.125R						
All engines										1.970.178	C10		1.501.657	
ENGINE														
320	Petrol	165	05/98-10/01	M 112.943										
Engine		Information			A10	A20	A40	A50	A70	C10 - C30	C20	E01		
All engines		Qty: 6								1.970.417	C10			
All engines													1.501.649	
ENGINE														
320	Petrol	170	09/93-10/01	M 104.991										
Engine		Information			A10	A20	A40	A50	A70	C10 - C30	C20	E01		
All engines		Qty: 3, without spark plug connector								1.970.316	C10			
All engines		incl. spark plug connector, Qty: 3								1.970.316K	C10			
ENGINE														
500	Petrol	225	05/98-10/01	M 113.961										
Engine		Information			A10	A20	A40	A50	A70	C10 - C30	C20	E01		
All engines		Qty: 8								1.970.417	C10			
ENGINE														
500	Petrol	235	09/92-10/01	M 119.972										
Engine		Information			A10	A20	A40	A50	A70	C10 - C30	C20	E01		
All engines		Qty: 2, version Bosch						1.406.146R						
All engines										1.970.179	C10			
ENGINE														
500 SL	Petrol	240	09/89-08/92	M 119.960										
Engine		Information			A10	A20	A40	A50	A70	C10 - C30	C20	E01		
All engines		Qty: 2, version Bosch						1.406.146R						
All engines		Qty: 2								1.970.178	C10			
ENGINE														
600	Petrol	290	07/92-10/01	M 120.981										
Engine		Information			A10	A20	A40	A50	A70	C10 - C30	C20	E01		
All engines										1.970.179	C10			
ENGINE														
600 SL	Petrol	300	02/92-08/94	M 120.981										
Engine		Information			A10	A20	A40	A50	A70	C10 - C30	C20	E01		
All engines										1.970.179	C10			
CLASSE SL V														
ENGINE														
280	Petrol	170	03/08-01/12	M 272.949										
Engine		Information			A10	A20	A40	A50	A70	C10 - C30	C20	E01		
All engines		x 6, COIL ON PLUG								1.970.487	C10			

A10	CONDENSER	A20	CONTACT SET	A40	DISTRIBUTOR CAP	A50	ROTOR	A70	PICK-UP
C10	COIL	C20	IGNITION MODULE	C30	ELECTRONIC IGNITION KIT	E01	IGNITION CABLE SET		

The present application list is a brief version. For the detailed information about the possibility of installation on a specific vehicle, please refer to our web-catalogue <http://catalogo.facet.eu/>

Vehicle	alim.	kW	Date	Engine	FUNCTIONS ON THE VEHICLE							
					A10	A20	A40	A50	A70	C10 - C30	C20	E01

300	Petrol	170	04/09-01/12	ENGINE M 272.949
------------	--------	------------	-------------	-----------------------------------

Engine	Information	A10	A20	A40	A50	A70	C10 - C30	C20	E01
All engines	x 6, COIL ON PLUG						1.970.487	C10	

350	Petrol	180	03/03-01/12	ENGINE M 112.973
------------	--------	------------	-------------	-----------------------------------

Engine	Information	A10	A20	A40	A50	A70	C10 - C30	C20	E01
All engines	x 6, COIL ON PLUG						1.970.417	C10	
All engines									1.501.649

350	Petrol	200	03/06-01/12	ENGINE M 272.966
------------	--------	------------	-------------	-----------------------------------

Engine	Information	A10	A20	A40	A50	A70	C10 - C30	C20	E01
All engines	x 6, COIL ON PLUG						1.970.487	C10	

350	Petrol	232	04/08-01/12	ENGINE M 272.968
------------	--------	------------	-------------	-----------------------------------

Engine	Information	A10	A20	A40	A50	A70	C10 - C30	C20	E01
All engines	x 6, COIL ON PLUG						1.970.487	C10	

500	Petrol	225	10/01-01/12	ENGINE M 113.963
------------	--------	------------	-------------	-----------------------------------

Engine	Information	A10	A20	A40	A50	A70	C10 - C30	C20	E01
All engines	x 8, COIL ON PLUG						1.970.417	C10	

500	Petrol	285	03/06-01/12	ENGINE M 273.965
------------	--------	------------	-------------	-----------------------------------

Engine	Information	A10	A20	A40	A50	A70	C10 - C30	C20	E01
All engines	x 8, COIL ON PLUG						1.970.487	C10	

55 AMG	Petrol	350	10/01-06/02	ENGINE M 113.992
---------------	--------	------------	-------------	-----------------------------------

Engine	Information	A10	A20	A40	A50	A70	C10 - C30	C20	E01
All engines	x 8, COIL ON PLUG						1.970.417	C10	

55 AMG	Petrol	380	03/06-01/12	ENGINE M 113.995
---------------	--------	------------	-------------	-----------------------------------

Engine	Information	A10	A20	A40	A50	A70	C10 - C30	C20	E01
All engines	x 8, COIL ON PLUG						1.970.417	C10	

55 AMG Kompressor	Petrol	368	06/02-01/12	ENGINE M 113.992
--------------------------	--------	------------	-------------	-----------------------------------

Engine	Information	A10	A20	A40	A50	A70	C10 - C30	C20	E01
All engines	x 8, COIL ON PLUG						1.970.417	C10	

550	Petrol	285	03/06-01/12	ENGINE M 273.965
------------	--------	------------	-------------	-----------------------------------

Engine	Information	A10	A20	A40	A50	A70	C10 - C30	C20	E01
All engines	Qty: 8						1.970.487	C10	

CLASSE SLC

180	Petrol	115	01/16->	ENGINE M 274.910
------------	--------	------------	---------	-----------------------------------

Engine	Information	A10	A20	A40	A50	A70	C10 - C30	C20	E01
All engines	SA A701, x 4, DELPHI, MADE BY: (TJ), without protection hose, x 4, COIL ON PLUG, without protection hose, COIL ON PLUG, FOR: (TJ)						1.970.626	C10	

200	Petrol	135	01/16->	ENGINE M 274.920
------------	--------	------------	---------	-----------------------------------

Engine	Information	A10	A20	A40	A50	A70	C10 - C30	C20	E01
All engines	SA A701/784K, x 4, DELPHI, MADE BY: (TJ), without protection hose, x 4, COIL ON PLUG, without protection hose, COIL ON PLUG, FOR: (TJ)						1.970.626	C10	

300	Petrol	180	01/16->	ENGINE M 274.920
------------	--------	------------	---------	-----------------------------------

Engine	Information	A10	A20	A40	A50	A70	C10 - C30	C20	E01
All engines	SA A701/784K, x 4, DELPHI, MADE BY: (TJ), without protection hose, x 4, COIL ON PLUG, without protection hose, COIL ON PLUG, FOR: (TJ)						1.970.626	C10	

A10 CONDENSER	A20 CONTACT SET	A40 DISTRIBUTOR CAP	A50 ROTOR	A70 PICK-UP
C10 COIL	C20 IGNITION MODULE	C30 ELECTRONIC IGNITION KIT	E01 IGNITION CABLE SET	

Vehicle	alim.	kW	Date	Engine	FUNCTIONS ON THE VEHICLE							
					A10	A20	A40	A50	A70	C10 - C30	C20	E01

CLASSE SLK I

				ENGINE
200	Petrol	100	09/96-03/00	M 111.946

Engine	Information	A10	A20	A40	A50	A70	C10 - C30	C20	E01
All engines	x 2, SEMI-DIRECT, Dia: 4 mm, connector type, saw teeth						1.970.316	C10	

				ENGINE
200 Kompressor	Petrol	141	10/96-03/00	M 111.943

Engine	Information	A10	A20	A40	A50	A70	C10 - C30	C20	E01
All engines	x 2, SEMI-DIRECT, Dia: 4 mm, connector type, saw teeth						1.970.316	C10	

				ENGINE
230 Kompressor	Petrol	142	09/96-03/00	M 111.973

Engine	Information	A10	A20	A40	A50	A70	C10 - C30	C20	E01
All engines	x 2, SEMI-DIRECT, Dia: 4 mm, connector type, saw teeth						1.970.316	C10	

				ENGINE
32 AMG Kompressor	Petrol	260	03/01-04/04	M 112.960

Engine	Information	A10	A20	A40	A50	A70	C10 - C30	C20	E01
All engines	x 6, COIL ON PLUG						1.970.417	C10	
All engines									1.501.649

				ENGINE
320	Petrol	160	03/00-04/04	M 112.947

Engine	Information	A10	A20	A40	A50	A70	C10 - C30	C20	E01
All engines	x 6, COIL ON PLUG						1.970.417	C10	
All engines									1.501.649

CLASSE SLK II

				ENGINE
200 Kompressor	Petrol	120	03/04-02/11	M 271.944

Engine	Information	A10	A20	A40	A50	A70	C10 - C30	C20	E01
All engines	->eng. 30853899, eng. type 30853900 ->, x 4, COIL ON PLUG						1.970.420	C10	

				ENGINE
200 Kompressor	Petrol	135	01/08-02/11	M 271.954

Engine	Information	A10	A20	A40	A50	A70	C10 - C30	C20	E01
All engines	x 4, COIL ON PLUG						1.970.420	C10	

				ENGINE
280	Petrol	170	01/05-02/11	M 272.942

Engine	Information	A10	A20	A40	A50	A70	C10 - C30	C20	E01
All engines	x 6, COIL ON PLUG						1.970.487	C10	

				ENGINE
300	Petrol	170	04/09-02/11	M 272.942

Engine	Information	A10	A20	A40	A50	A70	C10 - C30	C20	E01
All engines	x 6, COIL ON PLUG						1.970.487	C10	

				ENGINE
350	Petrol	200	06/04-02/11	M 272.963

Engine	Information	A10	A20	A40	A50	A70	C10 - C30	C20	E01
All engines	x 6, COIL ON PLUG						1.970.487	C10	

				ENGINE
350	Petrol	224	01/08-02/11	M 272.969

Engine	Information	A10	A20	A40	A50	A70	C10 - C30	C20	E01
All engines	x 6, COIL ON PLUG						1.970.487	C10	

				ENGINE
55 AMG	Petrol	265	06/04-12/11	M 113.989

Engine	Information	A10	A20	A40	A50	A70	C10 - C30	C20	E01
All engines	x 8, COIL ON PLUG						1.970.417	C10	

				ENGINE
55 AMG	Petrol	294	06/06-02/11	M 113.989

Engine	Information	A10	A20	A40	A50	A70	C10 - C30	C20	E01
All engines	x 8, COIL ON PLUG						1.970.417	C10	

CLASSE SLK III

				ENGINE
200	Petrol	135	02/11->	M 271.861, M 274.920

Engine	Information	A10	A20	A40	A50	A70	C10 - C30	C20	E01
Eng. M 271.861	x 4, COIL ON PLUG						1.970.420	C10	

A10	CONDENSER	A20	CONTACT SET	A40	DISTRIBUTOR CAP	A50	ROTOR	A70	PICK-UP
C10	COIL	C20	IGNITION MODULE	C30	ELECTRONIC IGNITION KIT	E01	IGNITION CABLE SET		

					FUNCTIONS ON THE VEHICLE												
Vehicle	alim.	kW	Date	Engine	A10	A20	A40	A50	A70	C10 - C30	C20	E01					
CLASSE SLK III																	
200	Petrol	135	02/11->	ENGINE M 271.861, M 274.920													
Engine	Information				A10	A20	A40	A50	A70	C10 - C30	C20	E01					
Eng. M 274.920	SA A701/784K, x 4, DELPHI, MADE BY: (TJ), without protection hose, x 4, COIL ON PLUG, without protection hose, COIL ON PLUG, FOR: (TJ)									1.970.626	C10						
250	Petrol	150	02/11->	ENGINE M 271.861													
Engine	Information				A10	A20	A40	A50	A70	C10 - C30	C20	E01					
All engines	x 4, COIL ON PLUG									1.970.420	C10						
300	Petrol	180	07/15->	ENGINE M 274.920													
Engine	Information				A10	A20	A40	A50	A70	C10 - C30	C20	E01					
All engines	x 4, DELPHI, without protection hose, COIL ON PLUG, without protection hose, COIL ON PLUG, FOR: (TJ)									1.970.626	C10						
CLASSE V																	
V 200	Petrol	95	02/97-07/03	ENGINE M 111.948, M 111.950													
Engine	Information				A10	A20	A40	A50	A70	C10 - C30	C20	E01					
All engines	x 2, SEMI-DIRECT, Dia: 4 mm, connector type, saw teeth									1.970.316	C10						
V 230	Petrol	105	10/96-07/03	ENGINE M 111.978, M 111.980													
Engine	Information				A10	A20	A40	A50	A70	C10 - C30	C20	E01					
All engines	x 2, SEMI-DIRECT, Dia: 4 mm, connector type, saw teeth									1.970.316	C10						
COUPE																	
220 SEB	Petrol	88	01/61-12/65	ENGINE M 127.984													
Engine	Information				A10	A20	A40	A50	A70	C10 - C30	C20	E01					
All engines								1.406.018R									
250 SE	Petrol	110	01/65-12/67	ENGINE M 129.980, M 129.981													
Engine	Information				A10	A20	A40	A50	A70	C10 - C30	C20	E01					
All engines						1.206.021		1.406.018R									
280 SE	Petrol	118	01/67-12/71	ENGINE M 130.980, M 130.984													
Engine	Information				A10	A20	A40	A50	A70	C10 - C30	C20	E01					
All engines						1.206.021		1.406.021R									
GLE																	
GLE 350 e 4-matic	Petrol/ Electric	155	06/20->	ENGINE M 274.920													
Engine	Information				A10	A20	A40	A50	A70	C10 - C30	C20	E01					
All engines	SA A701/784K, x 4, DELPHI, x 4, without protection hose, COIL ON PLUG, FOR: (TJ)									1.970.626	C10						
GLE 350 e 4-matic	Petrol/ Electric	245	06/20->	ENGINE M 274.920													
Engine	Information				A10	A20	A40	A50	A70	C10 - C30	C20	E01					
All engines	SA A701/784K, x 4, DELPHI, x 4, without protection hose, COIL ON PLUG, FOR: (TJ)									1.970.626	C10						
HECKFLOSSE																	
190 C	Petrol	59	04/61-08/65	ENGINE M 121.924													
Engine	Information				A10	A20	A40	A50	A70	C10 - C30	C20	E01					
All engines						1.206.029HV		1.406.018R									
200	Petrol	61	07/65-02/68	ENGINE M 121.940													
Engine	Information				A10	A20	A40	A50	A70	C10 - C30	C20	E01					
All engines						1.206.021, 1.206.029HV		1.406.018R									
200	Petrol	70	07/65-02/68	ENGINE M 115.926													
Engine	Information				A10	A20	A40	A50	A70	C10 - C30	C20	E01					
All engines								1.406.018R									
A10	CONDENSER			A20	CONTACT SET			A40	DISTRIBUTOR CAP			A50	ROTOR		A70	PICK-UP	
C10	COIL			C20	IGNITION MODULE			C30	ELECTRONIC IGNITION KIT			E01	IGNITION CABLE SET				

Vehicle	alim.	kW	Date	Engine	FUNCTIONS ON THE VEHICLE									
					A10	A20	A40	A50	A70	C10 - C30	C20	E01		
ENGINE														
220 B	Petrol	70	08/59-08/65	M 180.940										
Engine	Information				A10	A20	A40	A50	A70	C10 - C30	C20	E01		
All engines								1.406.018R						
ENGINE														
220 SB	Petrol	81	08/59-08/65	M 180.941										
Engine	Information				A10	A20	A40	A50	A70	C10 - C30	C20	E01		
All engines								1.406.018R						
ENGINE														
220 SEB	Petrol	88	08/59-08/65	M 127.982										
Engine	Information				A10	A20	A40	A50	A70	C10 - C30	C20	E01		
All engines								1.406.018R						
ENGINE														
230	Petrol	77	07/65-02/68	M 180.945, M 180.949										
Engine	Information				A10	A20	A40	A50	A70	C10 - C30	C20	E01		
All engines								1.406.018R						
ENGINE														
230	Petrol	88	06/66-12/67	M 180.950										
Engine	Information				A10	A20	A40	A50	A70	C10 - C30	C20	E01		
All engines								1.406.018R						
ENGINE														
230 S	Petrol	88	07/65-01/68	M 180.947, M 180.950										
Engine	Information				A10	A20	A40	A50	A70	C10 - C30	C20	E01		
All engines								1.406.018R						
KOMBI I														
ENGINE														
200 T	Petrol	74	11/80-11/85	M 102.939										
Engine	Information				A10	A20	A40	A50	A70	C10 - C30	C20	E01		
All engines	version Bosch						1.306.108	1.406.055R						
All engines										1.970.180	C10			
ENGINE														
200 T	Petrol	80	11/80-11/85	M 102.920										
Engine	Information				A10	A20	A40	A50	A70	C10 - C30	C20	E01		
All engines	version Bosch						1.306.108	1.406.055R						
All engines										1.970.180	C10			
KOMBI II														
ENGINE														
200 T	Petrol	77	01/86-05/90	M 102.922										
Engine	Information				A10	A20	A40	A50	A70	C10 - C30	C20	E01		
All engines	-catalytic converter, version Bosch						1.306.108	1.406.055R						
All engines	+catalytic converter, version Bosch						1.306.234	1.406.121R						
All engines	+catalytic converter									1.970.178	C10			
All engines	-catalytic converter									1.970.180	C10			
All engines													1.501.654	
ENGINE														
200 T	Petrol	80	09/85-08/89	M 102.922										
Engine	Information				A10	A20	A40	A50	A70	C10 - C30	C20	E01		
All engines	-catalytic converter, version Bosch						1.306.108	1.406.055R						
All engines	+catalytic converter, version Bosch						1.306.234	1.406.121R						
All engines	+catalytic converter									1.970.178	C10			
All engines	-catalytic converter									1.970.180	C10			
All engines													1.501.654	
ENGINE														
200 TE	Petrol	100	05/86-06/93	M 111.940										
Engine	Information				A10	A20	A40	A50	A70	C10 - C30	C20	E01		
All engines	Qty: 2									1.970.317	C10			
ENGINE														
200 TE	Petrol	87	09/88-08/92	M 102.963										
Engine	Information				A10	A20	A40	A50	A70	C10 - C30	C20	E01		
All engines	-catalytic converter, version Bosch						1.306.108	1.406.055R						
All engines	+catalytic converter, version Bosch						1.306.234	1.406.121R						
All engines	+catalytic converter									1.970.178	C10			
All engines										1.970.180	C10			

A10	CONDENSER	A20	CONTACT SET	A40	DISTRIBUTOR CAP	A50	ROTOR	A70	PICK-UP
C10	COIL	C20	IGNITION MODULE	C30	ELECTRONIC IGNITION KIT	E01	IGNITION CABLE SET		

The present application list is a brief version. For the detailed information about the possibility of installation on a specific vehicle, please refer to our web-catalogue <http://catalogo.facet.eu/>

Vehicle	alim.	kW	Date	Engine	FUNCTIONS ON THE VEHICLE							
					A10	A20	A40	A50	A70	C10 - C30	C20	E01

ENGINE				
200 TE	Petrol	87	09/88-08/92	M 102.963

Engine	Information	A10	A20	A40	A50	A70	C10 - C30	C20	E01
All engines	-catalytic converter						1.970.180	C10	
All engines									1.501.654

ENGINE				
200 TE	Petrol	90	09/88-12/89	M 102.962

Engine	Information	A10	A20	A40	A50	A70	C10 - C30	C20	E01
All engines	-catalytic converter, version Bosch			1.306.108	1.406.055R				
All engines	+catalytic converter, version Bosch			1.306.234	1.406.121R				
All engines	+catalytic converter						1.970.178	C10	
All engines	-catalytic converter						1.970.180	C10	
All engines	01/01/90 ->								1.501.300

ENGINE				
220 TE	Petrol	110	10/92-05/93	M 111.960

Engine	Information	A10	A20	A40	A50	A70	C10 - C30	C20	E01
All engines	Qty: 2						1.970.317	C10	

ENGINE				
230 E Chassis	Petrol	97	09/86-06/93	M 102.982

Engine	Information	A10	A20	A40	A50	A70	C10 - C30	C20	E01
All engines	-catalytic converter, version Bosch			1.306.108	1.406.055R				
All engines	+catalytic converter, version Bosch			1.306.234	1.406.121R				
All engines	+catalytic converter						1.970.178	C10	
All engines	-catalytic converter						1.970.180	C10	
All engines									1.501.654

ENGINE				
230 TE	Petrol	100	09/85-08/92	M 102.982

Engine	Information	A10	A20	A40	A50	A70	C10 - C30	C20	E01
All engines	-catalytic converter, version Bosch			1.306.108	1.406.055R				
All engines	+catalytic converter, version Bosch			1.306.234	1.406.121R				
All engines	+catalytic converter						1.970.178	C10	
All engines	-catalytic converter						1.970.180	C10	
All engines									1.501.654

ENGINE				
230 TE	Petrol	97	09/85-08/92	M 102.982

Engine	Information	A10	A20	A40	A50	A70	C10 - C30	C20	E01
All engines	-catalytic converter, version Bosch			1.306.108	1.406.055R				
All engines	+catalytic converter, version Bosch			1.306.234	1.406.121R				
All engines	+catalytic converter						1.970.178	C10	
All engines	-catalytic converter						1.970.180	C10	
All engines									1.501.654

ENGINE				
230 TE Cat	Petrol	97	06/89-08/92	M 102.982

Engine	Information	A10	A20	A40	A50	A70	C10 - C30	C20	E01
All engines	-catalytic converter, version Bosch			1.306.108	1.406.055R				
All engines	+catalytic converter, version Bosch			1.306.234	1.406.121R				
All engines	+catalytic converter						1.970.178	C10	
All engines	-catalytic converter						1.970.180	C10	
All engines									1.501.654

ENGINE				
260 TE FGST.	Petrol	118	09/89-08/92	M 103.940

Engine	Information	A10	A20	A40	A50	A70	C10 - C30	C20	E01
All engines	version Bosch			1.306.237	1.406.125R				
All engines							1.970.178	C10	

ENGINE				
280 TE	Petrol	145	10/92-06/93	M 104.942









Engine	Information	A10	A20	A40	A50	A70	C10 - C30	C20	E01
All engines	Qty: 3, without spark plug connector						1.970.316	C10	
All engines	incl. spark plug connector, Qty: 3						1.970.316K	C10	

A10 CONDENSER	A20 CONTACT SET	A40 DISTRIBUTOR CAP	A50 ROTOR	A70 PICK-UP
C10 COIL	C20 IGNITION MODULE	C30 ELECTRONIC IGNITION KIT	E01 IGNITION CABLE SET	

Vehicle	alim.	kW	Date	Engine	FUNCTIONS ON THE VEHICLE									
					A10	A20	A40	A50	A70	C10 - C30	C20	E01		
ENGINE														
300 TE	Petrol	132	01/86-08/92	M 103.983										
Engine	Information				A10	A20	A40	A50	A70	C10 - C30	C20	E01		
All engines	version Bosch						1.306.237	1.406.125R						
All engines										1.970.178	C10		1.501.657	
ENGINE														
300 TE 4-matic	Petrol	132	09/86-06/93	M 103.985										
Engine	Information				A10	A20	A40	A50	A70	C10 - C30	C20	E01		
All engines	version Bosch						1.306.237	1.406.125R						
All engines										1.970.178	C10		1.501.657	
ENGINE														
300 TE-24	Petrol	162	09/89-08/92	M 104.980										
Engine	Information				A10	A20	A40	A50	A70	C10 - C30	C20	E01		
All engines										1.970.179	C10			
ENGINE														
300 TE-24	Petrol	170	09/89-08/92	M 104.980										
Engine	Information				A10	A20	A40	A50	A70	C10 - C30	C20	E01		
All engines										1.970.179	C10			
ENGINE														
320 TE	Petrol	162	10/92-06/93	M 104.992										
Engine	Information				A10	A20	A40	A50	A70	C10 - C30	C20	E01		
All engines	Qty: 3, without spark plug connector									1.970.316	C10			
All engines	incl. spark plug connector, Qty: 3									1.970.316K	C10			
O 309														
ENGINE														
O 309		63	01/68-02/89	M 115.921										
Engine	Information				A10	A20	A40	A50	A70	C10 - C30	C20	E01		
All engines	->year 197212									1.970.101D	C10			
ENGINE														
O 309		66	01/68-02/89	M 115.952										
Engine	Information				A10	A20	A40	A50	A70	C10 - C30	C20	E01		
All engines	->year 198208						1.306.079	1.406.025R		1.970.101D	C10			
ENGINE														
O 309		70	01/68-02/89	M 102.943										
Engine	Information				A10	A20	A40	A50	A70	C10 - C30	C20	E01		
All engines							1.306.108	1.406.055R		1.970.180	C10			
PAGODE														
ENGINE														
230 SL	Petrol	110	01/63-01/67	M 127.981										
Engine	Information				A10	A20	A40	A50	A70	C10 - C30	C20	E01		
All engines								1.406.018R						
ENGINE														
250 SL	Petrol	110	01/66-01/68	M 129.982										
Engine	Information				A10	A20	A40	A50	A70	C10 - C30	C20	E01		
All engines						1.206.021		1.406.018R						
ENGINE														
280 SL	Petrol	125	01/68-03/71	M 130.983										
Engine	Information				A10	A20	A40	A50	A70	C10 - C30	C20	E01		
All engines								1.406.018R						
PONTON														
ENGINE														
190 b	Petrol	59	06/59-12/61	M 121.920										
Engine	Information				A10	A20	A40	A50	A70	C10 - C30	C20	E01		
All engines						1.206.029HV								
ENGINE														
220	Petrol	63	01/54-12/56	M 180.921										
Engine	Information				A10	A20	A40	A50	A70	C10 - C30	C20	E01		
All engines								1.406.018R						

A10	CONDENSER	A20	CONTACT SET	A40	DISTRIBUTOR CAP	A50	ROTOR	A70	PICK-UP
C10	COIL	C20	IGNITION MODULE	C30	ELECTRONIC IGNITION KIT	E01	IGNITION CABLE SET		

The present application list is a brief version. For the detailed information about the possibility of installation on a specific vehicle, please refer to our web-catalogue <http://catalogo.facet.eu/>







					FUNCTIONS ON THE VEHICLE							
Vehicle	alim.	kW	Date	Engine								
220 S												
Petrol 78 01/56-12/59 M 180.924												
ENGINE												
All engines					A10	A20	A40	A50	A70	C10 - C30	C20	E01
								1.406.018R				
SLR MCLAREN												
5.4												
Petrol 460 04/04-> M 155.980												
ENGINE												
All engines					A10	A20	A40	A50	A70	C10 - C30	C20	E01
										1.970.417	C10	
5.4												
Petrol 478 10/06-> M 155.980												
ENGINE												
All engines					A10	A20	A40	A50	A70	C10 - C30	C20	E01
										1.970.417	C10	
5.4 722 Edition												
Petrol 478 10/06-> M 155.980												
ENGINE												
All engines					A10	A20	A40	A50	A70	C10 - C30	C20	E01
										1.970.417	C10	
5.5												
Petrol 460 09/04-> M 155.980												
ENGINE												
All engines					A10	A20	A40	A50	A70	C10 - C30	C20	E01
										1.970.417	C10	
5.5 SLR McLaren												
Petrol 460 04/07-12/09 M 155.980												
ENGINE												
All engines					A10	A20	A40	A50	A70	C10 - C30	C20	E01
										1.970.417	C10	
SPRINTER I												
214												
Petrol 105 02/95-05/06 M 111.979, M 111.984												
ENGINE												
All engines					A10	A20	A40	A50	A70	C10 - C30	C20	E01
										1.970.316	C10	
214 NGT												
Petrol/Compressed Natural Gas (CNG) 95 02/95-05/06 M 111.984, M 111979NGT, M 111984NGT												
ENGINE												
Eng. M 111.984					A10	A20	A40	A50	A70	C10 - C30	C20	E01
										1.970.316	C10	
Eng. M 111979NGT, M 111984NGT					A10	A20	A40	A50	A70	C10 - C30	C20	E01
										1.970.316	C10	
Eng. M 111.984					A10	A20	A40	A50	A70	C10 - C30	C20	E01
										1.970.316K	C10	
314												
Petrol 105 02/95-05/06 M 111.979, M 111.984												
ENGINE												
All engines					A10	A20	A40	A50	A70	C10 - C30	C20	E01
										1.970.316	C10	
314 4x4												
Petrol 105 08/02-05/06 M 111.984												
ENGINE												
All engines					A10	A20	A40	A50	A70	C10 - C30	C20	E01
										1.970.316	C10	
314 NGT												
Petrol/Compressed Natural Gas (CNG) 95 02/95-05/06 M 111.984, M 111979NGT, M 111984NGT												
ENGINE												
Eng. M 111.984					A10	A20	A40	A50	A70	C10 - C30	C20	E01
										1.970.316	C10	
Eng. M 111979NGT, M 111984NGT					A10	A20	A40	A50	A70	C10 - C30	C20	E01
										1.970.316	C10	
Eng. M 111.984					A10	A20	A40	A50	A70	C10 - C30	C20	E01
										1.970.316K	C10	
414												
Petrol 105 02/95-05/06 M 111.979, M 111.984												
ENGINE												
All engines					A10	A20	A40	A50	A70	C10 - C30	C20	E01
										1.970.316	C10	

A10 CONDENSER	A20 CONTACT SET	A40 DISTRIBUTOR CAP	A50 ROTOR	A70 PICK-UP
C10 COIL	C20 IGNITION MODULE	C30 ELECTRONIC IGNITION KIT	E01 IGNITION CABLE SET	

Vehicle	alim.	kW	Date	Engine	FUNCTIONS ON THE VEHICLE									
					A10	A20	A40	A50	A70	C10 - C30	C20	E01		
ENGINE														
414	Petrol	105	02/95-05/06	M 111.979, M 111.984										
Engine	Information				A10	A20	A40	A50	A70	C10 - C30	C20	E01		
Eng. M 111.979	Qty: 2, without spark plug connector									1.970.316	C10			
Eng. M 111.979	incl. spark plug connector, Qty: 2									1.970.316K	C10			
ENGINE														
414 4x4	Petrol	105	05/97-05/06	M 111.979, M 111.984										
Engine	Information				A10	A20	A40	A50	A70	C10 - C30	C20	E01		
Eng. M 111.979	Qty: 2, without spark plug connector									1.970.316	C10			
Eng. M 111.984	x 2, SEMI-DIRECT, Dia: 4 mm, connector type, saw teeth									1.970.316	C10			
Eng. M 111.979	incl. spark plug connector, Qty: 2									1.970.316K	C10			
ENGINE														
414 NGT	Petrol/ Com- pressed Natural Gas (CNG)	95	02/95-05/06	M 111.979, M 111.984, M 111.979NGT, M 111.984NGT										
Engine	Information				A10	A20	A40	A50	A70	C10 - C30	C20	E01		
All engines	x 2, SEMI-DIRECT, Dia: 4 mm, connector type, saw teeth									1.970.316	C10			
SPRINTER II														
ENGINE														
216	Petrol	115	09/08->	M 271.951										
Engine	Information				A10	A20	A40	A50	A70	C10 - C30	C20	E01		
All engines	x 4, COIL ON PLUG									1.970.420	C10			
ENGINE														
224	Petrol	190	06/06->	M 272.979										
Engine	Information				A10	A20	A40	A50	A70	C10 - C30	C20	E01		
All engines	x 6, COIL ON PLUG									1.970.487	C10			
ENGINE														
316	Petrol	115	09/08->	M 271.951										
Engine	Information				A10	A20	A40	A50	A70	C10 - C30	C20	E01		
All engines	x 4, COIL ON PLUG									1.970.420	C10			
ENGINE														
316 LGT	Petrol/ Liquified Petro- leum Gas (LPG)	115	09/08->	271951										
Engine	Information				A10	A20	A40	A50	A70	C10 - C30	C20	E01		
All engines	x 4, COIL ON PLUG									1.970.420	C10			
ENGINE														
316 NGT	Petrol/ Com- pressed Natural Gas (CNG)	115	09/08->	M 271.951, M 271951NGT										
Engine	Information				A10	A20	A40	A50	A70	C10 - C30	C20	E01		
Eng. M 271.951	Qty: 4									1.970.420	C10			
Eng. M 271951NGT	x 4, COIL ON PLUG									1.970.420	C10			
ENGINE														
324	Petrol	190	06/06-12/13	M 272.979										
Engine	Information				A10	A20	A40	A50	A70	C10 - C30	C20	E01		
All engines	x 6, COIL ON PLUG									1.970.487	C10			
ENGINE														
424	Petrol	190	06/06-12/13	M 272.979										
Engine	Information				A10	A20	A40	A50	A70	C10 - C30	C20	E01		
All engines	x 6, COIL ON PLUG									1.970.487	C10			
ENGINE														
516	Petrol	115	09/08->	M 271.951										
Engine	Information				A10	A20	A40	A50	A70	C10 - C30	C20	E01		
All engines	x 4, COIL ON PLUG									1.970.420	C10			

A10	CONDENSER	A20	CONTACT SET	A40	DISTRIBUTOR CAP	A50	ROTOR	A70	PICK-UP
C10	COIL	C20	IGNITION MODULE	C30	ELECTRONIC IGNITION KIT	E01	IGNITION CABLE SET		

The present application list is a brief version. For the detailed information about the possibility of installation on a specific vehicle, please refer to our web-catalogue <http://catalogo.facet.eu/>

					FUNCTIONS ON THE VEHICLE							
Vehicle	alim.	kW	Date	Engine								
ENGINE												
516 NGT	Petrol/ Compressed Natural Gas (CNG)	115	09/08->	M 271.951, M 271951NGT								
Engine	Information				A10	A20	A40	A50	A70	C10 - C30	C20	E01
Eng. M 271.951	Qty: 4									1.970.420	C10	
Eng. M 271951NGT	x 4, COIL ON PLUG									1.970.420	C10	
ENGINE												
524	Petrol	190	06/06-12/13	M 272.979								
Engine	Information				A10	A20	A40	A50	A70	C10 - C30	C20	E01
All engines	x 6, COIL ON PLUG									1.970.487	C10	
ENGINE												
T1												
210 2.3	Petrol	70	04/77-02/96	M 102.942								
Engine	Information				A10	A20	A40	A50	A70	C10 - C30	C20	E01
All engines	version Bosch						1.306.108	1.406.055R				
All engines	ch. 240088 ->									1.970.180	C10	
All engines												1.501.654
ENGINE												
210 2.3	Petrol	77	05/89-02/96	M 102.945								
Engine	Information				A10	A20	A40	A50	A70	C10 - C30	C20	E01
All engines	version Bosch						1.306.108	1.406.055R				
All engines	ch. 240088 ->									1.970.180	C10	
All engines												1.501.654
ENGINE												
310 2.3	Petrol	70	08/82-02/96	M 102.942								
Engine	Information				A10	A20	A40	A50	A70	C10 - C30	C20	E01
All engines	version Bosch						1.306.108	1.406.055R				
All engines	ch. 240088 ->									1.970.180	C10	
All engines												1.501.654
ENGINE												
310 2.3	Petrol	77	10/87-12/95	M 102.945								
Engine	Information				A10	A20	A40	A50	A70	C10 - C30	C20	E01
All engines	version Bosch						1.306.108	1.406.055R				
All engines	ch. 240088 ->									1.970.180	C10	
All engines												1.501.654
ENGINE												
410 2.3	Petrol	70	08/82-06/95	M 102.942								
Engine	Information				A10	A20	A40	A50	A70	C10 - C30	C20	E01
All engines	version Bosch						1.306.108	1.406.055R				
All engines										1.970.180	C10	1.501.654
ENGINE												
410 2.3	Petrol	77	10/87-06/95	M 102.945								
Engine	Information				A10	A20	A40	A50	A70	C10 - C30	C20	E01
All engines	version Bosch						1.306.108	1.406.055R				
All engines										1.970.180	C10	1.501.654
ENGINE												
T2/LN1												
510	Petrol	70	04/86-12/94	M 102.946								
Engine	Information				A10	A20	A40	A50	A70	C10 - C30	C20	E01
All engines	version Bosch						1.306.108	1.406.055R				
All engines										1.970.180	C10	1.501.654
ENGINE												
510	Petrol	77	04/86-12/94	M 102.946								
Engine	Information				A10	A20	A40	A50	A70	C10 - C30	C20	E01
All engines	version Bosch						1.306.108	1.406.055R				
All engines										1.970.180	C10	1.501.654

A10 CONDENSER	A20 CONTACT SET	A40 DISTRIBUTOR CAP	A50 ROTOR	A70 PICK-UP
C10 COIL	C20 IGNITION MODULE	C30 ELECTRONIC IGNITION KIT	E01 IGNITION CABLE SET	

Vehicle	alim.	kW	Date	Engine	FUNCTIONS ON THE VEHICLE							
					A10	A20	A40	A50	A70	C10 - C30	C20	E01

TRE VOLUMI I

				ENGINE
280 E	Petrol	136	02/76-11/85	M 110.984, M 110.988

Engine	Information	A10	A20	A40	A50	A70	C10 - C30	C20	E01
Eng. M 110.984	version Bosch			1.306.092					
Eng. M 110.988	version Bosch			1.306.123	1.406.060R				
Eng. M 110.984	eng. type 026112, 084886 ->, version Bosch				1.406.024R				
Eng. M 110.984	->eng. 026111, 084885, version Bosch				1.406.034R				
All engines	ext. thread M6 - M5 mm						1.970.180	C10	
Eng. M 110.988									1.501.323

TRE VOLUMI II

				ENGINE
200	Petrol	75	01/86-05/90	M 102.922

Engine	Information	A10	A20	A40	A50	A70	C10 - C30	C20	E01
All engines	-catalytic converter, version Bosch			1.306.108	1.406.055R				
All engines	+catalytic converter, version Bosch			1.306.234	1.406.121R				
All engines	+catalytic converter						1.970.178	C10	
All engines	-catalytic converter						1.970.180	C10	
All engines									1.501.654

				ENGINE
200	Petrol	77	01/86-10/92	M 102.922

Engine	Information	A10	A20	A40	A50	A70	C10 - C30	C20	E01
All engines	-catalytic converter, version Bosch			1.306.108	1.406.055R				
All engines	+catalytic converter, version Bosch			1.306.234	1.406.121R				
All engines	+catalytic converter						1.970.178	C10	
All engines	-catalytic converter						1.970.180	C10	
All engines									1.501.654

				ENGINE
200	Petrol	80	12/85-05/90	M 102.922

Engine	Information	A10	A20	A40	A50	A70	C10 - C30	C20	E01
All engines	-catalytic converter, version Bosch			1.306.108	1.406.055R				
All engines	+catalytic converter, version Bosch			1.306.234	1.406.121R				
All engines	+catalytic converter						1.970.178	C10	
All engines	-catalytic converter						1.970.180	C10	
All engines									1.501.654

				ENGINE
200 E	Petrol	100	10/92-06/93	M 111.940

Engine	Information	A10	A20	A40	A50	A70	C10 - C30	C20	E01
All engines	Qty: 2						1.970.317	C10	

				ENGINE
200 E	Petrol	87	09/88-08/93	M 102.963

Engine	Information	A10	A20	A40	A50	A70	C10 - C30	C20	E01
All engines	-catalytic converter, version Bosch			1.306.108	1.406.055R				
All engines	+catalytic converter, version Bosch			1.306.234	1.406.121R				
All engines	+catalytic converter						1.970.178	C10	
All engines	-catalytic converter						1.970.180	C10	
All engines									1.501.654

				ENGINE
200 E	Petrol	90	09/88-12/89	M 102.963

Engine	Information	A10	A20	A40	A50	A70	C10 - C30	C20	E01
All engines	-catalytic converter, version Bosch			1.306.108	1.406.055R				
All engines	+catalytic converter, version Bosch			1.306.234	1.406.121R				
All engines	+catalytic converter						1.970.178	C10	
All engines	-catalytic converter						1.970.180	C10	
All engines									1.501.654

				ENGINE
220 E	Petrol	110	10/92-06/93	M 111.960

Engine	Information	A10	A20	A40	A50	A70	C10 - C30	C20	E01
All engines	Qty: 2						1.970.317	C10	

				ENGINE
230 E	Petrol	100	01/85-06/93	M 102.982

Engine	Information	A10	A20	A40	A50	A70	C10 - C30	C20	E01
All engines	-catalytic converter, version Bosch			1.306.108	1.406.055R				

A10	CONDENSER	A20	CONTACT SET	A40	DISTRIBUTOR CAP	A50	ROTOR	A70	PICK-UP
C10	COIL	C20	IGNITION MODULE	C30	ELECTRONIC IGNITION KIT	E01	IGNITION CABLE SET		

					FUNCTIONS ON THE VEHICLE							
Vehicle	alim.	kW	Date	Engine								
ENGINE												
230 E	Petrol	100	01/85-06/93	M 102.982								
Engine	Information			A10	A20	A40	A50	A70	C10 - C30	C20	E01	
All engines	+catalytic converter, version Bosch					1.306.234	1.406.121R					
All engines	+catalytic converter								1.970.178	C10		
All engines	-catalytic converter								1.970.180	C10		
All engines												1.501.654
ENGINE												
230 E	Petrol	97	12/84-03/92	M 102.982								
Engine	Information			A10	A20	A40	A50	A70	C10 - C30	C20	E01	
All engines	-catalytic converter, version Bosch					1.306.108	1.406.055R					
All engines	+catalytic converter, version Bosch					1.306.234	1.406.121R					
All engines	+catalytic converter								1.970.178	C10		
All engines	-catalytic converter								1.970.180	C10		
All engines												1.501.654
ENGINE												
230 E Cat	Petrol	97	06/89-06/93	M 102.982								
Engine	Information			A10	A20	A40	A50	A70	C10 - C30	C20	E01	
All engines	-catalytic converter, version Bosch					1.306.108	1.406.055R					
All engines	+catalytic converter, version Bosch					1.306.234	1.406.121R					
All engines	+catalytic converter								1.970.178	C10		
All engines	-catalytic converter								1.970.180	C10		
All engines												1.501.654
ENGINE												
260 E	Petrol	118	09/85-08/92	M 103.940								
Engine	Information			A10	A20	A40	A50	A70	C10 - C30	C20	E01	
All engines	version Bosch					1.306.237	1.406.125R					
All engines									1.970.178	C10		1.501.657
ENGINE												
260 E	Petrol	122	09/85-12/89	M 103.940								
Engine	Information			A10	A20	A40	A50	A70	C10 - C30	C20	E01	
All engines	version Bosch					1.306.237	1.406.125R					
All engines									1.970.178	C10		1.501.657
ENGINE												
260 E 4-matic	Petrol	118	09/86-08/92	M 103.943								
Engine	Information			A10	A20	A40	A50	A70	C10 - C30	C20	E01	
All engines	version Bosch					1.306.237	1.406.125R					
All engines									1.970.178	C10		1.501.657
ENGINE												
280 E	Petrol	145	10/92-06/93	M 104.942								
Engine	Information			A10	A20	A40	A50	A70	C10 - C30	C20	E01	
All engines	Qty: 3, without spark plug connector								1.970.316	C10		
All engines	incl. spark plug connector, Qty: 3								1.970.316K	C10		
ENGINE												
300 E	Petrol	132	08/85-08/92	M 103.983								
Engine	Information			A10	A20	A40	A50	A70	C10 - C30	C20	E01	
All engines	version Bosch					1.306.237	1.406.125R					
All engines									1.970.178	C10		1.501.657
ENGINE												
300 E	Petrol	138	06/85-08/92	M 103.983								
Engine	Information			A10	A20	A40	A50	A70	C10 - C30	C20	E01	
All engines	version Bosch					1.306.237	1.406.125R					
All engines									1.970.178	C10		
ENGINE												
300 E 4-matic	Petrol	118	01/86-12/93	M 103.943								
Engine	Information			A10	A20	A40	A50	A70	C10 - C30	C20	E01	
All engines	version Bosch					1.306.237	1.406.125R					
All engines									1.970.178	C10		
ENGINE												
300 E 4-matic	Petrol	132	09/86-06/93	M 103.985								
Engine	Information			A10	A20	A40	A50	A70	C10 - C30	C20	E01	
All engines	version Bosch					1.306.237	1.406.125R					
All engines									1.970.178	C10		

A10 CONDENSER	A20 CONTACT SET	A40 DISTRIBUTOR CAP	A50 ROTOR	A70 PICK-UP
C10 COIL	C20 IGNITION MODULE	C30 ELECTRONIC IGNITION KIT	E01 IGNITION CABLE SET	

Vehicle	alim.	kW	Date	Engine	FUNCTIONS ON THE VEHICLE								
					A10	A20	A40	A50	A70	C10 - C30	C20	E01	
ENGINE													
300 E 4-matic	Petrol	132	09/86-06/93	M 103.985									
Engine	Information				A10	A20	A40	A50	A70	C10 - C30	C20	E01	
All engines										1.970.178	C10		1.501.657
ENGINE													
300 E 4-matic	Petrol	138	09/86-02/92	M 103.983									
Engine	Information				A10	A20	A40	A50	A70	C10 - C30	C20	E01	
All engines	version Bosch						1.306.237	1.406.125R					
All engines										1.970.178	C10		1.501.657
ENGINE													
300 E-24	Petrol	162	09/88-08/92	M 104.980									
Engine	Information				A10	A20	A40	A50	A70	C10 - C30	C20	E01	
All engines										1.970.179	C10		
ENGINE													
300 E-24	Petrol	170	09/88-08/92	M 104.980									
Engine	Information				A10	A20	A40	A50	A70	C10 - C30	C20	E01	
All engines										1.970.179	C10		
ENGINE													
320 E	Petrol	162	10/92-06/93	M 104.992									
Engine	Information				A10	A20	A40	A50	A70	C10 - C30	C20	E01	
All engines	Qty: 3, without spark plug connector									1.970.316	C10		
All engines	incl. spark plug connector, Qty: 3									1.970.316K	C10		
ENGINE													
400 E 4.2	Petrol	205	10/92-06/93	M 119.975									
Engine	Information				A10	A20	A40	A50	A70	C10 - C30	C20	E01	
All engines	Qty: 2, version Bosch							1.406.146R					
All engines	->ch. B 568955, Qty: 2									1.970.178	C10		
All engines	ch. B 568956 ->									1.970.179	C10		
ENGINE													
500 E	Petrol	240	01/91-06/93	M 119.974									
Engine	Information				A10	A20	A40	A50	A70	C10 - C30	C20	E01	
All engines	Qty: 2, version Bosch							1.406.146R					
All engines	->ch. B 568955, Qty: 2									1.970.178	C10		
All engines	ch. B 568956 ->									1.970.179	C10		
ENGINE													
500 E AMG 6.0	Petrol	275	01/92-06/93	M 119.974 (AMG 6.0)									
Engine	Information				A10	A20	A40	A50	A70	C10 - C30	C20	E01	
All engines	Qty: 2, version Bosch							1.406.146R					
All engines	->ch. B 568955, Qty: 2									1.970.178	C10		
All engines	ch. B 568956 ->									1.970.179	C10		
VIANO													
ENGINE													
3.2	Petrol	140	09/03->	M 112.951									
Engine	Information				A10	A20	A40	A50	A70	C10 - C30	C20	E01	
All engines	x 6, COIL ON PLUG									1.970.417	C10		
All engines													1.501.649
ENGINE													
3.2	Petrol	160	09/03->	M 112.951									
Engine	Information				A10	A20	A40	A50	A70	C10 - C30	C20	E01	
All engines	x 6, COIL ON PLUG									1.970.417	C10		
All engines													1.501.649
ENGINE													
3.5	Petrol	190	09/07->	M 272.978									
Engine	Information				A10	A20	A40	A50	A70	C10 - C30	C20	E01	
All engines	x 6, COIL ON PLUG									1.970.487	C10		
ENGINE													
3.7	Petrol	165	06/04-07/07	M 112.976									
Engine	Information				A10	A20	A40	A50	A70	C10 - C30	C20	E01	
All engines	x 6, COIL ON PLUG									1.970.487	C10		

A10	CONDENSER	A20	CONTACT SET	A40	DISTRIBUTOR CAP	A50	ROTOR	A70	PICK-UP
C10	COIL	C20	IGNITION MODULE	C30	ELECTRONIC IGNITION KIT	E01	IGNITION CABLE SET		

The present application list is a brief version. For the detailed information about the possibility of installation on a specific vehicle, please refer to our web-catalogue <http://catalogo.facet.eu/>

FUNCTIONS ON THE VEHICLE

Vehicle	alim.	kW	Date	Engine								
---------	-------	----	------	--------	---	---	---	--	---	---	---	---

ENGINE				
3.7	Petrol	170	06/04->	M 112.976

Engine	Information	A10	A20	A40	A50	A70	C10 - C30	C20	E01
All engines	x 6, COIL ON PLUG						1.970.417	C10	
All engines									1.501.649

VITO I

ENGINE				
113 2.0	Petrol	95	02/96-07/03	M 111.948, M 111.950

Engine	Information	A10	A20	A40	A50	A70	C10 - C30	C20	E01
All engines	x 2, SEMI-DIRECT, Dia: 4 mm, connector type, saw teeth						1.970.316	C10	

ENGINE				
114 2.3	Petrol	105	12/96-07/03	M 111.978

Engine	Information	A10	A20	A40	A50	A70	C10 - C30	C20	E01
All engines	x 2, SEMI-DIRECT, Dia: 4 mm, connector type, saw teeth						1.970.316	C10	

VITO II

ENGINE				
119	Petrol	140	09/03->	M 112.951

Engine	Information	A10	A20	A40	A50	A70	C10 - C30	C20	E01
All engines	x 6, COIL ON PLUG						1.970.417	C10	
All engines									1.501.649

ENGINE				
122	Petrol	160	09/03->	M 112.951

Engine	Information	A10	A20	A40	A50	A70	C10 - C30	C20	E01
All engines	x 6, COIL ON PLUG						1.970.417	C10	
All engines									1.501.649

ENGINE				
123	Petrol	165	06/04-07/08	M 112.976

Engine	Information	A10	A20	A40	A50	A70	C10 - C30	C20	E01
All engines	x 6, COIL ON PLUG						1.970.487	C10	
All engines									1.501.649

ENGINE				
123	Petrol	170	06/04-07/08	M 112.976

Engine	Information	A10	A20	A40	A50	A70	C10 - C30	C20	E01
All engines	x 6, COIL ON PLUG						1.970.417, 1.970.487	C10	
All engines									1.501.649

ENGINE				
126	Petrol	190	09/07->	M 272.978









Engine	Information	A10	A20	A40	A50	A70	C10 - C30	C20	E01
All engines	x 6, COIL ON PLUG						1.970.487	C10	

A10 CONDENSER	A20 CONTACT SET	A40 DISTRIBUTOR CAP	A50 ROTOR	A70 PICK-UP
C10 COIL	C20 IGNITION MODULE	C30 ELECTRONIC IGNITION KIT	E01 IGNITION CABLE SET	

Vehicle	alim.	kW	Date	Engine	FUNCTIONS ON THE VEHICLE							
					A10	A20	A40	A50	A70	C10 - C30	C20	E01
1300 MK.II												
1300	Petrol	52	09/67-09/70	ENGINE --								
Engine		Information			A10	A20	A40	A50	A70	C10 - C30	C20	E01
All engines							1.328.075	1.428.006				
EXPRESS												
1.4	Petrol	76	03/03-05/05	ENGINE 14 K4F								
Engine		Information			A10	A20	A40	A50	A70	C10 - C30	C20	E01
All engines		x 1, DISTRIBUTOR								1.970.374	C10	
MAGNETTE												
1.5	Petrol	45	01/53-05/56	ENGINE --								
Engine		Information			A10	A20	A40	A50	A70	C10 - C30	C20	E01
All engines								1.428.006				
1.5	Petrol	48	05/56-04/58	ENGINE --								
Engine		Information			A10	A20	A40	A50	A70	C10 - C30	C20	E01
All engines								1.428.006				
1.6	Petrol	51	03/61-09/68	ENGINE --								
Engine		Information			A10	A20	A40	A50	A70	C10 - C30	C20	E01
All engines						1.228.083MHV	1.328.075	1.428.006				
MG TF												
115	Petrol	85	03/02-12/09	ENGINE 16 K4F								
Engine		Information			A10	A20	A40	A50	A70	C10 - C30	C20	E01
All engines		->ch. YD522572, version Lucas					1.328.093	1.428.029R				
All engines		x 1, DISTRIBUTOR								1.970.374	C10	
All engines		->ch. YD522572										1.501.888
All engines		ch. YD522573 ->										1.501.889
120	Petrol	88	03/02-12/09	ENGINE 18 K4F								
Engine		Information			A10	A20	A40	A50	A70	C10 - C30	C20	E01
All engines		->ch. YD522572, version Lucas					1.328.093	1.428.029R				
All engines		->ch. YD522572										1.501.888
All engines		ch. YD522573 ->										1.501.889
135	Petrol	100	03/02-12/09	ENGINE 18 K4F								
Engine		Information			A10	A20	A40	A50	A70	C10 - C30	C20	E01
All engines		->ch. YD522572, version Lucas					1.328.093	1.428.029R				
All engines		x 1, DISTRIBUTOR								1.970.374	C10	
All engines		->ch. YD522572										1.501.888
All engines		ch. YD522573 ->										1.501.889
160	Petrol	118	03/02-12/09	ENGINE 18 K4K								
Engine		Information			A10	A20	A40	A50	A70	C10 - C30	C20	E01
All engines		x 1, DISTRIBUTOR								1.970.374	C10	
MG ZR												
105	Petrol	76	06/01-04/05	ENGINE 14 K4F								
Engine		Information			A10	A20	A40	A50	A70	C10 - C30	C20	E01
All engines		->ch. YD471564, version Lucas					1.328.093	1.428.029R				
All engines		x 1, DISTRIBUTOR								1.970.374	C10	
All engines		->ch. YD471564										1.501.888
All engines		ch. YD471565 ->										1.501.889
120	Petrol	86	06/01-04/05	ENGINE 18 K4F								
Engine		Information			A10	A20	A40	A50	A70	C10 - C30	C20	E01
All engines		->ch. YD471564, version Lucas					1.328.093	1.428.029R				
All engines		x 1, DISTRIBUTOR								1.970.374	C10	
All engines		->ch. YD471564										1.501.888

A10 CONDENSER	A20 CONTACT SET	A40 DISTRIBUTOR CAP	A50 ROTOR	A70 PICK-UP
C10 COIL	C20 IGNITION MODULE	C30 ELECTRONIC IGNITION KIT	E01 IGNITION CABLE SET	

The present application list is a brief version. For the detailed information about the possibility of installation on a specific vehicle, please refer to our web-catalogue <http://catalogo.facet.eu/>

				FUNCTIONS ON THE VEHICLE								
Vehicle	alim.	kW	Date	Engine								
				ENGINE								
120	Petrol	86	06/01-04/05	18 K4F								
Engine Information				A10	A20	A40	A50	A70	C10 - C30	C20	E01	
All engines				ch.YD471565 ->								1.501.889
				ENGINE								
MG ZS												
120	Petrol	86	07/01-10/05	18 K4F								
Engine Information				A10	A20	A40	A50	A70	C10 - C30	C20	E01	
All engines												1.501.889
				ENGINE								
180	Petrol	130	07/01-10/05	25 K4F								
Engine Information				A10	A20	A40	A50	A70	C10 - C30	C20	E01	
All engines				x 1, LONG, SHORT, BREMI, D.I.S.					1.970.413	C10		
				ENGINE								
MGA												
1.5	Petrol	51	05/55-04/60	--								
Engine Information				A10	A20	A40	A50	A70	C10 - C30	C20	E01	
All engines							1.428.006					
				ENGINE								
1.6	Petrol	58	01/58-04/60	--								
Engine Information				A10	A20	A40	A50	A70	C10 - C30	C20	E01	
All engines							1.428.006					
				ENGINE								
1.6	Petrol	70	05/60-07/62	--								
Engine Information				A10	A20	A40	A50	A70	C10 - C30	C20	E01	
All engines							1.428.006					
				ENGINE								
1.6	Petrol	81	01/58-05/60	--								
Engine Information				A10	A20	A40	A50	A70	C10 - C30	C20	E01	
All engines							1.428.006					
				ENGINE								
MGB												
1.8	Petrol	68	05/62-12/80	--								
Engine Information				A10	A20	A40	A50	A70	C10 - C30	C20	E01	
All engines					1.228.083MHV	1.328.075	1.428.006					
				ENGINE								
1.8	Petrol	70	05/62-12/80	--								
Engine Information				A10	A20	A40	A50	A70	C10 - C30	C20	E01	
All engines					1.228.083MHV	1.328.075	1.428.006					
				ENGINE								
MGB GT												
1.8	Petrol	68	07/65-11/80	--, 18G								
Engine Information				A10	A20	A40	A50	A70	C10 - C30	C20	E01	
All engines					1.228.083MHV	1.328.075	1.428.006					
				ENGINE								
1.8	Petrol	70	07/65-11/80	--, 18G								
Engine Information				A10	A20	A40	A50	A70	C10 - C30	C20	E01	
All engines					1.228.083MHV	1.328.075	1.428.006					
				ENGINE								
MGC												
3.0	Petrol	108	01/67-09/69	--								
Engine Information				A10	A20	A40	A50	A70	C10 - C30	C20	E01	
All engines							1.428.007					
				ENGINE								
MGC GT												
3.0	Petrol	108	01/67-09/69	--								
Engine Information				A10	A20	A40	A50	A70	C10 - C30	C20	E01	
All engines							1.428.007					

A10 CONDENSER	A20 CONTACT SET	A40 DISTRIBUTOR CAP	A50 ROTOR	A70 PICK-UP
C10 COIL	C20 IGNITION MODULE	C30 ELECTRONIC IGNITION KIT	E01 IGNITION CABLE SET	

Vehicle	alim.	kW	Date	Engine	FUNCTIONS ON THE VEHICLE							
					A10	A20	A40	A50	A70	C10 - C30	C20	E01

MGF

1.8 i 16V	Petrol	88	03/95-03/02	ENGINE
				18 K4F

Engine	Information	A10	A20	A40	A50	A70	C10 - C30	C20	E01
All engines	->ch. YD522572, version Lucas			1.328.093	1.428.029R				
All engines	->ch. YD522572								1.501.888
All engines	ch. YD522573 ->								1.501.889

MGY

1.3	Petrol	34	01/50-12/51	ENGINE
				--

Engine	Information	A10	A20	A40	A50	A70	C10 - C30	C20	E01
All engines					1.428.006				

1.3	Petrol	40	01/50-12/51	ENGINE
				--

Engine	Information	A10	A20	A40	A50	A70	C10 - C30	C20	E01
All engines					1.428.006				

MIDGET

1.1	Petrol	41	01/64-12/66	ENGINE
				--

Engine	Information	A10	A20	A40	A50	A70	C10 - C30	C20	E01
All engines					1.428.006				

1.3	Petrol	48	01/67-09/74	ENGINE
				--

Engine	Information	A10	A20	A40	A50	A70	C10 - C30	C20	E01
All engines					1.428.006				

A10	CONDENSER	A20	CONTACT SET	A40	DISTRIBUTOR CAP	A50	ROTOR	A70	PICK-UP
C10	COIL	C20	IGNITION MODULE	C30	ELECTRONIC IGNITION KIT	E01	IGNITION CABLE SET		

The present application list is a brief version. For the detailed information about the possibility of installation on a specific vehicle, please refer to our web-catalogue <http://catalogo.facet.eu/>

				FUNCTIONS ON THE VEHICLE								
Vehicle	alim.	kW	Date	Engine	 A10	 A20	 A40	 A50	 A70	 C10 - C30	 C20	 E01
MINI I												
Cooper	Petrol	85	06/01-07/08	ENGINE W10 B16 A								
Engine	Information				A10	A20	A40	A50	A70	C10 - C30	C20	E01
All engines												1.501.719
Cooper S	Petrol	120	03/02-11/07	ENGINE W11 B16 A								
Engine	Information				A10	A20	A40	A50	A70	C10 - C30	C20	E01
All engines												1.501.719
Cooper S	Petrol	125	07/04-11/07	ENGINE W11 B16 A								
Engine	Information				A10	A20	A40	A50	A70	C10 - C30	C20	E01
All engines												1.501.719
John Cooper Works	Petrol	155	07/04-11/07	ENGINE W11 B16 A								
Engine	Information				A10	A20	A40	A50	A70	C10 - C30	C20	E01
All engines												1.501.719
One	Petrol	55	04/03-09/06	ENGINE W10 B14 A								
Engine	Information				A10	A20	A40	A50	A70	C10 - C30	C20	E01
All engines												1.501.719
One	Petrol	66	06/01-11/07	ENGINE W10 B16 A								
Engine	Information				A10	A20	A40	A50	A70	C10 - C30	C20	E01
All engines												1.501.719
Works	Petrol	155	11/03-09/06	ENGINE W11 B16 A								
Engine	Information				A10	A20	A40	A50	A70	C10 - C30	C20	E01
All engines												1.501.719
MINI II												
Cooper	Diesel	88	03/09-06/15	ENGINE N12 B16 BA								
Engine	Information				A10	A20	A40	A50	A70	C10 - C30	C20	E01
All engines	Qty: 4									1.970.475 C10		
Cooper	Petrol	85	09/06-10/16	ENGINE N12 B16 A, N16 B16 A								
Engine	Information				A10	A20	A40	A50	A70	C10 - C30	C20	E01
All engines	x 4, DELPHI, x 4, COIL ON PLUG, DELPHI, ELDOR, COIL ON PLUG									1.970.475 C10		
Cooper	Petrol	88	10/06-10/16	ENGINE N12 B16 A, N16 B16 A								
Engine	Information				A10	A20	A40	A50	A70	C10 - C30	C20	E01
All engines	x 4, DELPHI, ELDOR, COIL ON PLUG									1.970.475 C10		
Cooper	Petrol	90	09/09-10/16	ENGINE N12 B16 A, N16 B16 A								
Engine	Information				A10	A20	A40	A50	A70	C10 - C30	C20	E01
Eng. N12 B16 A	Qty: 4									1.970.475 C10		
Eng. N16 B16 A	x 4, DELPHI, COIL ON PLUG									1.970.475 C10		
Cooper ALL4	Petrol	85	07/13-09/16	ENGINE N16 B16 A								
Engine	Information				A10	A20	A40	A50	A70	C10 - C30	C20	E01
All engines	x 4, DELPHI, COIL ON PLUG									1.970.475 C10		
Cooper ALL4	Petrol	90	11/12-10/16	ENGINE N16 B16 A, N18 B16 A								
Engine	Information				A10	A20	A40	A50	A70	C10 - C30	C20	E01
All engines	x 4, DELPHI, COIL ON PLUG									1.970.475 C10		
Cooper S	Petrol	120	10/07-10/16	ENGINE N14 B16 A, N14 B16 AB, N18 B16 A								
Engine	Information				A10	A20	A40	A50	A70	C10 - C30	C20	E01
All engines	x 4, DELPHI, COIL ON PLUG									1.970.475 C10		

A10 CONDENSER	A20 CONTACT SET	A40 DISTRIBUTOR CAP	A50 ROTOR	A70 PICK-UP
C10 COIL	C20 IGNITION MODULE	C30 ELECTRONIC IGNITION KIT	E01 IGNITION CABLE SET	

Vehicle	alim.	kW	Date	Engine	FUNCTIONS ON THE VEHICLE									
					A10	A20	A40	A50	A70	C10 - C30	C20	E01		
ENGINE														
Cooper S	Petrol	128	10/06-07/10	N14 B16 A, N14 B16 AB										
Engine	Information				A10	A20	A40	A50	A70	C10 - C30	C20	E01		
All engines	x 4, DELPHI, COIL ON PLUG									1.970.475	C10			
Eng. N14 B16 A	Qty: 4									1.970.475	C10			
ENGINE														
Cooper S	Petrol	135	02/10-10/16	N18 B16 A										
Engine	Information				A10	A20	A40	A50	A70	C10 - C30	C20	E01		
All engines	x 4, DELPHI, COIL ON PLUG									1.970.475	C10			
ENGINE														
Cooper S	Petrol	140	07/14-10/16	N18 B16 A										
Engine	Information				A10	A20	A40	A50	A70	C10 - C30	C20	E01		
All engines	x 4, DELPHI, COIL ON PLUG									1.970.475	C10			
ENGINE														
Cooper S	Petrol	141	04/08-07/10	N14 B16 AB										
Engine	Information				A10	A20	A40	A50	A70	C10 - C30	C20	E01		
All engines	x 4, DELPHI, COIL ON PLUG									1.970.475	C10			
ENGINE														
Cooper S	Petrol	147	02/10-10/16	N18 B16 A										
Engine	Information				A10	A20	A40	A50	A70	C10 - C30	C20	E01		
All engines	x 4, DELPHI, COIL ON PLUG									1.970.475	C10			
ENGINE														
Cooper S ALL4	Petrol	120	08/10-10/16	N18 B16 A										
Engine	Information				A10	A20	A40	A50	A70	C10 - C30	C20	E01		
All engines	x 4, DELPHI, COIL ON PLUG									1.970.475	C10			
ENGINE														
Cooper S ALL4	Petrol	135	08/10-10/16	N18 B16 A										
Engine	Information				A10	A20	A40	A50	A70	C10 - C30	C20	E01		
All engines	x 4, DELPHI, COIL ON PLUG									1.970.475	C10			
ENGINE														
Cooper S ALL4	Petrol	140	03/12-10/16	N18 B16 A										
Engine	Information				A10	A20	A40	A50	A70	C10 - C30	C20	E01		
All engines	x 4, DELPHI, COIL ON PLUG									1.970.475	C10			
ENGINE														
Cooper S JCW	Petrol	147	12/10-04/15	N18 B16 A										
Engine	Information				A10	A20	A40	A50	A70	C10 - C30	C20	E01		
All engines	x 4, DELPHI, COIL ON PLUG									1.970.475	C10			
ENGINE														
Cooper S John Cooper Works	Petrol	141	11/06-02/10	N14 B16 AB, N14 B16 C										
Engine	Information				A10	A20	A40	A50	A70	C10 - C30	C20	E01		
Eng. N14 B16 AB	x 4, DELPHI, COIL ON PLUG									1.970.475	C10			
Eng. N14 B16 C	Qty: 4									1.970.475	C10			
ENGINE														
Cooper S John Cooper Works	Petrol	147	01/12-11/13	N18 B16 A										
Engine	Information				A10	A20	A40	A50	A70	C10 - C30	C20	E01		
All engines	x 4, DELPHI, COIL ON PLUG									1.970.475	C10			
ENGINE														
John Cooper Works	Petrol	155	11/07-05/15	N14 B16 C, N18 B16 C										
Engine	Information				A10	A20	A40	A50	A70	C10 - C30	C20	E01		
All engines	x 4, DELPHI, COIL ON PLUG									1.970.475	C10			
ENGINE														
John Cooper Works ALL4	Petrol	160	11/12-10/16	N18 B16 C										
Engine	Information				A10	A20	A40	A50	A70	C10 - C30	C20	E01		
All engines	x 4, DELPHI, COIL ON PLUG									1.970.475	C10			
ENGINE														
John Cooper Works GP	Petrol	160	09/12-11/13	N14 B16 C, N18 B16 C										
Engine	Information				A10	A20	A40	A50	A70	C10 - C30	C20	E01		
All engines	x 4, DELPHI, COIL ON PLUG									1.970.475	C10			
ENGINE														
A10	CONDENSER		A20	CONTACT SET		A40	DISTRIBUTOR CAP		A50	ROTOR		A70	PICK-UP	
C10	COIL		C20	IGNITION MODULE		C30	ELECTRONIC IGNITION KIT		E01	IGNITION CABLE SET				

					FUNCTIONS ON THE VEHICLE							
Vehicle	alim.	kW	Date	Engine	A10	A20	A40	A50	A70	C10 - C30	C20	E01
ENGINE												
John Cooper Works ALL4	Petrol	160	11/12->	N18 B16 C								
Engine	Information				A10	A20	A40	A50	A70	C10 - C30	C20	E01
All engines	Qty: 4									1,970.475	C10	
ENGINE												
One	Petrol	55	03/09-11/13	N12 B14 A, N16 B16 A								
Engine	Information				A10	A20	A40	A50	A70	C10 - C30	C20	E01
All engines	x 4, DELPHI, ELDOR, COIL ON PLUG									1,970.475	C10	
ENGINE												
One	Petrol	70	11/06-03/10	N12 B14 A								
Engine	Information				A10	A20	A40	A50	A70	C10 - C30	C20	E01
All engines	x 4, DELPHI, ELDOR, COIL ON PLUG									1,970.475	C10	
ENGINE												
One	Petrol	72	09/09-10/16	N16 B16 A								
Engine	Information				A10	A20	A40	A50	A70	C10 - C30	C20	E01
All engines	x 4, DELPHI, COIL ON PLUG									1,970.475	C10	
ENGINE												
One LPG	Petrol/ Liquified Petroleum Gas (LPG)	55	03/09-03/10	N12 B14 A								
Engine	Information				A10	A20	A40	A50	A70	C10 - C30	C20	E01
All engines	x 4, DELPHI, ELDOR, COIL ON PLUG									1,970.475	C10	
MINI III												
ENGINE												
Cooper	Petrol	100	09/13->	B36 A15 A, B38 A15 A, B38 A15 F								
Engine	Information				A10	A20	A40	A50	A70	C10 - C30	C20	E01
All engines	x 3, COIL ON PLUG									1,970.632	C10	
Eng. B36 A15 A	Qty: 3									1,970.632	C10	
ENGINE												
Cooper ALL4	Petrol	100	10/16->	B38 A15 A, B38 A15 F								
Engine	Information				A10	A20	A40	A50	A70	C10 - C30	C20	E01
All engines	x 3, COIL ON PLUG									1,970.632	C10	
ENGINE												
Cooper S	Petrol	120	09/13->	B46 A20 A, B48 A20 A, B48 A20 F								
Engine	Information				A10	A20	A40	A50	A70	C10 - C30	C20	E01
All engines	x 4, COIL ON PLUG									1,970.632	C10	
ENGINE												
Cooper S	Petrol	131	07/20->	B46 A20 A, B48 A20 A, B48 A20 F								
Engine	Information				A10	A20	A40	A50	A70	C10 - C30	C20	E01
All engines	x 4, COIL ON PLUG, x 4, COIL ON PLUG									1,970.632	C10	
ENGINE												
Cooper S	Petrol	141	09/13->	B46 A20 A, B48 A20 A, B48 A20 F								
Engine	Information				A10	A20	A40	A50	A70	C10 - C30	C20	E01
All engines	x 4, COIL ON PLUG									1,970.632	C10	
ENGINE												
Cooper S ALL4	Petrol	120	04/15->	B46 A20 A, B48 A20 A								
Engine	Information				A10	A20	A40	A50	A70	C10 - C30	C20	E01
All engines	x 4, COIL ON PLUG									1,970.632	C10	
ENGINE												
Cooper S ALL4	Petrol	131	07/20->	B46 A20 A, B48 A20 A, B48 A20 F								
Engine	Information				A10	A20	A40	A50	A70	C10 - C30	C20	E01
All engines	x 4, COIL ON PLUG									1,970.632	C10	
ENGINE												
Cooper S ALL4	Petrol	141	04/15->	B46 A20 A, B48 A20 A								
Engine	Information				A10	A20	A40	A50	A70	C10 - C30	C20	E01
All engines	x 4, COIL ON PLUG									1,970.632	C10	

A10 CONDENSER	A20 CONTACT SET	A40 DISTRIBUTOR CAP	A50 ROTOR	A70 PICK-UP
C10 COIL	C20 IGNITION MODULE	C30 ELECTRONIC IGNITION KIT	E01 IGNITION CABLE SET	

Vehicle	alim.	kW	Date	Engine	FUNCTIONS ON THE VEHICLE									
					A10	A20	A40	A50	A70	C10 - C30	C20	E01		
ENGINE														
Cooper SJCW	Petrol	155	09/13->	B46 A20 A, B48 A20 A, B48 A20 F										
Engine	Information				A10	A20	A40	A50	A70	C10 - C30	C20	E01		
All engines	x 4, COIL ON PLUG									1.970.632	C10			
ENGINE														
Cooper SJCW ALL4	Petrol	155	11/14->	B48 A20 A										
Engine	Information				A10	A20	A40	A50	A70	C10 - C30	C20	E01		
All engines	x 4, COIL ON PLUG									1.970.632	C10			
ENGINE														
Cooper SE ALL4	Petrol/ Electric	100	01/17->	B38 A15 A										
Engine	Information				A10	A20	A40	A50	A70	C10 - C30	C20	E01		
All engines	x 3, COIL ON PLUG									1.970.632	C10			
ENGINE														
Cooper SE ALL4	Petrol/ Electric	162	07/20->	B38 A15 A										
Engine	Information				A10	A20	A40	A50	A70	C10 - C30	C20	E01		
All engines	x 3, COIL ON PLUG									1.970.632	C10			
ENGINE														
Cooper SE ALL4	Petrol/ Electric	165	01/17->	B38 A15 A										
Engine	Information				A10	A20	A40	A50	A70	C10 - C30	C20	E01		
All engines	x 3, COIL ON PLUG									1.970.632	C10			
ENGINE														
Cooper SE ALL4	Petrol/ Electric	92	07/20->	B38 A15 A										
Engine	Information				A10	A20	A40	A50	A70	C10 - C30	C20	E01		
All engines	x 3, COIL ON PLUG									1.970.632	C10			
ENGINE														
John Cooper Works	Petrol	170	03/15->	B46 A20 B, B48 A20 B										
Engine	Information				A10	A20	A40	A50	A70	C10 - C30	C20	E01		
All engines	x 4, COIL ON PLUG									1.970.632	C10			
ENGINE														
John Cooper Works	Petrol	225	07/19->	B48 A20 E										
Engine	Information				A10	A20	A40	A50	A70	C10 - C30	C20	E01		
All engines	x 4, COIL ON PLUG									1.970.632	C10			
ENGINE														
John Cooper Works ALL4	Petrol	170	03/17-06/19	B48 A20 B										
Engine	Information				A10	A20	A40	A50	A70	C10 - C30	C20	E01		
All engines	x 4, COIL ON PLUG									1.970.632	C10			
ENGINE														
John Cooper Works ALL4	Petrol	225	07/19->	B48 A20 E										
Engine	Information				A10	A20	A40	A50	A70	C10 - C30	C20	E01		
All engines	x 4, COIL ON PLUG									1.970.632	C10			
ENGINE														
John Cooper Works GP	Petrol	225	03/20->	B48 A20 E										
Engine	Information				A10	A20	A40	A50	A70	C10 - C30	C20	E01		
All engines	x 4, COIL ON PLUG									1.970.632	C10			
ENGINE														
One	Petrol	75	04/14->	B38 A12 A, B38 A15 A										
Engine	Information				A10	A20	A40	A50	A70	C10 - C30	C20	E01		
All engines	x 3, COIL ON PLUG									1.970.632	C10			
ENGINE														
One First	Petrol	55	06/14->	B38 A12 A, B38 A15 A										
Engine	Information				A10	A20	A40	A50	A70	C10 - C30	C20	E01		
All engines	x 3, COIL ON PLUG									1.970.632	C10			

A10 CONDENSER	A20 CONTACT SET	A40 DISTRIBUTOR CAP	A50 ROTOR	A70 PICK-UP
C10 COIL	C20 IGNITION MODULE	C30 ELECTRONIC IGNITION KIT	E01 IGNITION CABLE SET	

The present application list is a brief version. For the detailed information about the possibility of installation on a specific vehicle, please refer to our web-catalogue <http://catalogo.facet.eu/>

Vehicle	alim.	kW	Date	Engine	FUNCTIONS ON THE VEHICLE							
					A10	A20	A40	A50	A70	C10 - C30	C20	E01

ASX

				ENGINE
1.6 LPG	Petrol/ Liquified Petroleum Gas (LPG)	86	06/10->	4A92

Engine	Information	A10	A20	A40	A50	A70	C10 - C30	C20	E01
All engines	x 4, COIL ON PLUG						1.970.505	C10	

				ENGINE
1.6 MIVEC	Petrol	85	05/10->	4A92

Engine	Information	A10	A20	A40	A50	A70	C10 - C30	C20	E01
All engines	x 4, COIL ON PLUG						1.970.505	C10	

				ENGINE
1.6 MIVEC	Petrol	86	06/10->	4A92

Engine	Information	A10	A20	A40	A50	A70	C10 - C30	C20	E01
All engines	x 4, COIL ON PLUG						1.970.505	C10	

				ENGINE
1.8	Petrol	102	02/10->	4B10

Engine	Information	A10	A20	A40	A50	A70	C10 - C30	C20	E01
All engines	x 4, COIL ON PLUG						1.970.497	C10	

				ENGINE
1.8 4WD	Petrol	102	02/10->	6B4204T30

Engine	Information	A10	A20	A40	A50	A70	C10 - C30	C20	E01
All engines	Qty: 4						1.970.497	C10	

				ENGINE
2.0 i	Petrol	118	06/10->	4B11

Engine	Information	A10	A20	A40	A50	A70	C10 - C30	C20	E01
All engines	Qty: 4						1.970.497	C10	

				ENGINE
2.0 i 4WD	Petrol	112	01/10->	4B11

Engine	Information	A10	A20	A40	A50	A70	C10 - C30	C20	E01
All engines	Qty: 4						1.970.497	C10	

				ENGINE
2.0 i 4WD	Petrol	114	01/10->	4B11

Engine	Information	A10	A20	A40	A50	A70	C10 - C30	C20	E01
All engines	Qty: 4						1.970.497	C10	

				ENGINE
2.0 i 4WD	Petrol	118	06/10->	4B11

Engine	Information	A10	A20	A40	A50	A70	C10 - C30	C20	E01
All engines	Qty: 4						1.970.497	C10	

				ENGINE
2.0 MIVEC	Petrol	110	06/10->	4B11, 4J11

Engine	Information	A10	A20	A40	A50	A70	C10 - C30	C20	E01
All engines	x 4, COIL ON PLUG						1.970.497	C10	

				ENGINE
2.0 MIVEC 4WD	Petrol	110	06/10->	4B11, 4J11

Engine	Information	A10	A20	A40	A50	A70	C10 - C30	C20	E01
All engines	x 4, COIL ON PLUG						1.970.497	C10	

CARISMA

				ENGINE
1.3 16V	Petrol	60	09/00-10/04	4G13 (16V)

Engine	Information	A10	A20	A40	A50	A70	C10 - C30	C20	E01
All engines									1.501.883

				ENGINE
1.6	Petrol	66	07/95-06/06	4G92 (SOHC 16V)

Engine	Information	A10	A20	A40	A50	A70	C10 - C30	C20	E01
All engines	->year 30/04/96, version Mitsubishi			1.331.169	1.431.136				
All engines	01/05/96 ->								1.501.764

A10 CONDENSER	A20 CONTACT SET	A40 DISTRIBUTOR CAP	A50 ROTOR	A70 PICK-UP
C10 COIL	C20 IGNITION MODULE	C30 ELECTRONIC IGNITION KIT	E01 IGNITION CABLE SET	

Vehicle	alim.	kW	Date	Engine	FUNCTIONS ON THE VEHICLE									
					A10	A20	A40	A50	A70	C10 - C30	C20	E01		
ENGINE														
1.6	Petrol	70	12/98-06/06	4G92 (SOHC 16V)										
Engine Information					A10	A20	A40	A50	A70	C10 - C30	C20	E01		
All engines													1.501.764	
ENGINE														
1.6	Petrol	73	05/97-06/06	4G92 (SOHC 16V)										
Engine Information					A10	A20	A40	A50	A70	C10 - C30	C20	E01		
All engines					01/05/96 ->								1.501.764	
ENGINE														
1.6	Petrol	76	09/00-06/06	4G92 (SOHC 16V)										
Engine Information					A10	A20	A40	A50	A70	C10 - C30	C20	E01		
All engines													1.501.764	
ENGINE														
1.8	Petrol	85	07/95-09/97	4G93 (SOHC 16V)										
Engine Information					A10	A20	A40	A50	A70	C10 - C30	C20	E01		
All engines					->year 30/04/96, version Mitsubishi		1.331.169	1.431.136						
All engines					01/05/96 ->								1.501.764	
COLT I														
ENGINE														
1.2 GL	Petrol	40	12/78-01/84	4G11										
Engine Information					A10	A20	A40	A50	A70	C10 - C30	C20	E01		
All engines					version Mitsubishi		1.231.085	1.331.003/00	1.431.023					
COLT II														
ENGINE														
1.3 EL, GL	Petrol	49	06/86-04/88	G13B										
Engine Information					A10	A20	A40	A50	A70	C10 - C30	C20	E01		
All engines					version Mitsubishi		1.331.003/00	1.431.023						
COLT III														
ENGINE														
1.3 12V	Petrol	55	04/88-05/92	4G13 (12V)										
Engine Information					A10	A20	A40	A50	A70	C10 - C30	C20	E01		
All engines					version Mitsubishi		1.331.158	1.431.119						
ENGINE														
1.3 GL	Petrol	44	04/88-12/90	4G13 (8V)										
Engine Information					A10	A20	A40	A50	A70	C10 - C30	C20	E01		
All engines					->year 31/05/90, version Mitsubishi		1.331.003/00	1.431.023						
All engines					01/06/90 ->, version Mitsubishi		1.331.158	1.431.119						
ENGINE														
1.5 Cat	Petrol	66	07/90-05/92	4G15 (12V)										
Engine Information					A10	A20	A40	A50	A70	C10 - C30	C20	E01		
All engines					version Mitsubishi		1.331.134							
ENGINE														
1.5 GLXi	Petrol	62	04/88-05/92	4G15 (8V)										
Engine Information					A10	A20	A40	A50	A70	C10 - C30	C20	E01		
All engines					version Mitsubishi		1.331.003/00	1.431.107						
ENGINE														
1.6 GTi 16V	Petrol	91	04/88-05/90	4G61										
Engine Information					A10	A20	A40	A50	A70	C10 - C30	C20	E01		
All engines													1.501.401	
ENGINE														
1.8 GTi 16V Cat	Petrol	100	06/90-05/92	4G67										
Engine Information					A10	A20	A40	A50	A70	C10 - C30	C20	E01		
All engines													1.501.401	
COLT IV														
ENGINE														
1.3 GLi 12V	Petrol	55	04/92-04/96	4G13 (12V)										
Engine Information					A10	A20	A40	A50	A70	C10 - C30	C20	E01		
All engines					version Mitsubishi		1.331.134							

A10 CONDENSER	A20 CONTACT SET	A40 DISTRIBUTOR CAP	A50 ROTOR	A70 PICK-UP
C10 COIL	C20 IGNITION MODULE	C30 ELECTRONIC IGNITION KIT	E01 IGNITION CABLE SET	

The present application list is a brief version. For the detailed information about the possibility of installation on a specific vehicle, please refer to our web-catalogue <http://catalogo.facet.eu/>

				FUNCTIONS ON THE VEHICLE															
Vehicle	alim.	kW	Date	Engine															
				ENGINE															
1.5	Petrol	60	04/92-04/96	4G15															
Engine		Information			A10	A20	A40	A50	A70	C10 - C30	C20	E01							
All engines		version Mitsubishi, no specific info conc. application available					1.331.134, 1.331.158	1.431.119											
				ENGINE															
1.6 4WD	Petrol	84	08/93-08/95	4G92 (SOHC 16V)															
Engine		Information			A10	A20	A40	A50	A70	C10 - C30	C20	E01							
All engines		version Mitsubishi					1.331.138												
All engines		version Mitsubishi, no specific info conc. application available						1.431.136, 1.431.137											
All engines												1.501.278							
				ENGINE															
1.6 GLXi 16V	Petrol	83	04/92-04/96	4G92 (SOHC 16V)															
Engine		Information			A10	A20	A40	A50	A70	C10 - C30	C20	E01							
All engines		version Mitsubishi					1.331.138												
All engines		version Mitsubishi, no specific info conc. application available						1.431.136, 1.431.137											
All engines												1.501.278							
COLT V																			
				ENGINE															
1.3	Petrol	66	08/02-09/03	4G19															
Engine		Information			A10	A20	A40	A50	A70	C10 - C30	C20	E01							
All engines												1.501.883							
				ENGINE															
1.5	Petrol	81	09/95-09/03	301353C															
Engine		Information			A10	A20	A40	A50	A70	C10 - C30	C20	E01							
All engines		version Mitsubishi					1.331.158	1.431.119											
All engines												1.501.753							
				ENGINE															
1.5 16V	Petrol	69	10/99-09/03	301353C															
Engine		Information			A10	A20	A40	A50	A70	C10 - C30	C20	E01							
All engines		version Mitsubishi					1.331.158	1.431.119											
All engines												1.501.753							
				ENGINE															
1300	Petrol	60	06/00-09/03	4G13 (16V)															
Engine		Information			A10	A20	A40	A50	A70	C10 - C30	C20	E01							
All engines												1.501.883							
				ENGINE															
1300 GL, GLX	Petrol	55	05/96-06/00	4G13 (12V)															
Engine		Information			A10	A20	A40	A50	A70	C10 - C30	C20	E01							
All engines		->year 31/05/00, version Mitsubishi					1.331.168	1.431.136											
All engines		->year 31/05/00										1.501.753							
All engines		01/06/00 ->										1.501.883							
				ENGINE															
1600	Petrol	76	09/00-09/03	4G92 (SOHC 16V)															
Engine		Information			A10	A20	A40	A50	A70	C10 - C30	C20	E01							
All engines												1.501.764							
				ENGINE															
1600 GLX	Petrol	66	05/96-09/00	4G92 (SOHC 16V)															
Engine		Information			A10	A20	A40	A50	A70	C10 - C30	C20	E01							
All engines												1.501.764							
COLT VI																			
				ENGINE															
1.1	Petrol	55	10/04-06/12	3A91															
Engine		Information			A10	A20	A40	A50	A70	C10 - C30	C20	E01							
All engines		01/07/10 ->, x 3, COIL ON PLUG								1.970.505	C10								
				ENGINE															
1.1 LPG	Petrol/ Liquified Petro- leum Gas (LPG)	55	10/04-06/12	3A91															
Engine		Information			A10	A20	A40	A50	A70	C10 - C30	C20	E01							
All engines		01/07/10 ->, x 3, COIL ON PLUG								1.970.505	C10								
A10		CONDENSER		A20		CONTACT SET		A40		DISTRIBUTOR CAP		A50		ROTOR		A70		PICK-UP	
C10		COIL		C20		IGNITION MODULE		C30		ELECTRONIC IGNITION KIT		E01		IGNITION CABLE SET					

Vehicle	alim.	kW	Date	Engine	FUNCTIONS ON THE VEHICLE								
					A10	A20	A40	A50	A70	C10 - C30	C20	E01	
ENGINE													
1.3	Petrol	68	08/04->	4A90									
Engine					A10	A20	A40	A50	A70	C10 - C30	C20	E01	
Information										1.970.505	C10		
All engines													
ENGINE													
1.3	Petrol	70	06/04-06/12	4A90									
Engine					A10	A20	A40	A50	A70	C10 - C30	C20	E01	
Information										1.970.505	C10		
All engines													
ENGINE													
1.3 4WD	Petrol	67	08/04->	4A90									
Engine					A10	A20	A40	A50	A70	C10 - C30	C20	E01	
Information										1.970.505	C10		
All engines													
ENGINE													
1.3 LPG	Petrol/ Liquified Petroleum Gas (LPG)	70	06/04-06/12	4A90									
Engine					A10	A20	A40	A50	A70	C10 - C30	C20	E01	
Information										1.970.505	C10		
All engines													
ENGINE													
CORDIA													
ENGINE													
1.8 [USA]	Petrol	0	01/82-12/88	G62B									
Engine					A10	A20	A40	A50	A70	C10 - C30	C20	E01	
Information						1.231.085	1.331.003/00	1.431.023					
All engines													
ENGINE													
1.8 Turbo [USA]	Petrol	0	01/82-12/88	G62B									
Engine					A10	A20	A40	A50	A70	C10 - C30	C20	E01	
Information						1.231.085	1.331.003/00	1.431.023					
All engines													
ENGINE													
DELICA D5													
ENGINE													
2.4 4WD	Petrol	125	06/07->	4B12									
Engine					A10	A20	A40	A50	A70	C10 - C30	C20	E01	
Information										1.970.497	C10		
All engines													
ENGINE													
ECLIPSE I													
ENGINE													
1.8	Petrol	68	12/89-03/94	4G37									
Engine					A10	A20	A40	A50	A70	C10 - C30	C20	E01	
Information							1.331.135						
All engines													
ENGINE													
2.0 i 16V	Petrol	110	04/91-11/95	4G63 (DOHC 16V)									
Engine					A10	A20	A40	A50	A70	C10 - C30	C20	E01	
Information												1.501.401	
All engines													
ENGINE													
2.0 i 16V 4WD	Petrol	110	04/91-11/95	4G63 (DOHC 16V)									
Engine					A10	A20	A40	A50	A70	C10 - C30	C20	E01	
Information												1.501.401	
All engines													
ENGINE													
2.0 Turbo	Petrol	147	12/89-03/94	4G63-T (DOHC 16V)									
Engine					A10	A20	A40	A50	A70	C10 - C30	C20	E01	
Information												1.501.401	
All engines													
ENGINE													
2.0 Turbo 4WD	Petrol	157	12/89-03/94	4G63-T (DOHC 16V)									
Engine					A10	A20	A40	A50	A70	C10 - C30	C20	E01	
Information												1.501.401	
All engines													
ENGINE													
GALANT IV													
ENGINE													
1.6 GLX	Petrol	55	09/80-05/84	4G32									
Engine					A10	A20	A40	A50	A70	C10 - C30	C20	E01	
Information								1.431.107					
All engines													

A10	CONDENSER	A20	CONTACT SET	A40	DISTRIBUTOR CAP	A50	ROTOR	A70	PICK-UP
C10	COIL	C20	IGNITION MODULE	C30	ELECTRONIC IGNITION KIT	E01	IGNITION CABLE SET		

The present application list is a brief version. For the detailed information about the possibility of installation on a specific vehicle, please refer to our web-catalogue <http://catalogo.facet.eu/>

					FUNCTIONS ON THE VEHICLE							
Vehicle	alim.	kW	Date	Engine								

GALANT VI

1.6	Petrol	55	01/88-10/92	4G32
------------	--------	-----------	-------------	-------------

Engine	Information	A10	A20	A40	A50	A70	C10 - C30	C20	E01
All engines	version Mitsubishi			1.331.003/00	1.431.023				

1.8	Petrol	63	11/87-10/92	4G37
------------	--------	-----------	-------------	-------------

Engine	Information	A10	A20	A40	A50	A70	C10 - C30	C20	E01
All engines	fuel formation: carburettor, version Mitsubishi			1.331.003/00	1.431.023				
All engines	11/05/90 ->, Multi Point Injection (MPI), version Mitsubishi			1.331.135					

1.8	Petrol	66	11/87-10/92	4G37
------------	--------	-----------	-------------	-------------

Engine	Information	A10	A20	A40	A50	A70	C10 - C30	C20	E01
All engines	fuel formation: carburettor, version Mitsubishi			1.331.003/00	1.431.023				
All engines	11/05/90 ->, Multi Point Injection (MPI), version Mitsubishi			1.331.135					

2.0	Petrol	77	05/89-12/92	4G63 (SOHC 8V)
------------	--------	-----------	-------------	-----------------------

Engine	Information	A10	A20	A40	A50	A70	C10 - C30	C20	E01
All engines	->year 31/05/90, version Mitsubishi			1.331.003/00	1.431.107				
All engines	01/06/90 ->, version Mitsubishi			1.331.131	1.431.131				

2.0	Petrol	80	11/87-10/92	4G63 (SOHC 8V)
------------	--------	-----------	-------------	-----------------------

Engine	Information	A10	A20	A40	A50	A70	C10 - C30	C20	E01
All engines	->year 31/05/90, version Mitsubishi			1.331.003/00	1.431.107				
All engines	01/06/90 ->, version Mitsubishi			1.331.131	1.431.131				

2.0 4WD	Petrol	80	12/88-10/92	4G63 (SOHC 8V)
----------------	--------	-----------	-------------	-----------------------

Engine	Information	A10	A20	A40	A50	A70	C10 - C30	C20	E01
All engines	->year 31/05/90, version Mitsubishi			1.331.003/00	1.431.107				
All engines	01/06/90 ->, version Mitsubishi			1.331.131	1.431.131				

2.0 GTi 16V	Petrol	106	11/87-10/92	4G63 (DOHC 16V)
--------------------	--------	------------	-------------	------------------------

Engine	Information	A10	A20	A40	A50	A70	C10 - C30	C20	E01
All engines									1.501.401

2.0 GTI 16V	Petrol	107	11/88-10/92	4G63 (DOHC 16V)
--------------------	--------	------------	-------------	------------------------

Engine	Information	A10	A20	A40	A50	A70	C10 - C30	C20	E01
All engines									1.501.401

2.0 GTi 16V 4WD	Petrol	106	06/88-10/92	4G63 (DOHC 16V)
------------------------	--------	------------	-------------	------------------------

Engine	Information	A10	A20	A40	A50	A70	C10 - C30	C20	E01
All engines	->year 31/05/91								1.501.401

2.0 GTI 16V 4x4	Petrol	106	07/89-12/92	4G63 (DOHC 16V)
------------------------	--------	------------	-------------	------------------------

Engine	Information	A10	A20	A40	A50	A70	C10 - C30	C20	E01
All engines	->year 31/05/91								1.501.401

2.0 GTI 16V Cat 4WD	Petrol	110	09/91-10/92	4G63 (DOHC 16V)
----------------------------	--------	------------	-------------	------------------------

Engine	Information	A10	A20	A40	A50	A70	C10 - C30	C20	E01
All engines	->year 31/05/91								1.501.401

GALANT VII

1.8	Petrol	85	02/94-08/96	4G93 (SOHC 16V)
------------	--------	-----------	-------------	------------------------

Engine	Information	A10	A20	A40	A50	A70	C10 - C30	C20	E01
All engines									1.501.278

1.8 GLSi	Petrol	93	11/92-08/96	4G93 (SOHC 16V)
-----------------	--------	-----------	-------------	------------------------







Engine	Information	A10	A20	A40	A50	A70	C10 - C30	C20	E01
All engines	version Mitsubishi			1.331.147	1.431.137				
All engines									1.501.278

A10 CONDENSER	A20 CONTACT SET	A40 DISTRIBUTOR CAP	A50 ROTOR	A70 PICK-UP
C10 COIL	C20 IGNITION MODULE	C30 ELECTRONIC IGNITION KIT	E01 IGNITION CABLE SET	

Vehicle	alim.	kW	Date	Engine	FUNCTIONS ON THE VEHICLE							
					A10	A20	A40	A50	A70	C10 - C30	C20	E01
2.0 GLSI												
Petrol 101 11/92-08/96 ENGINE 4G63 (SOHC 16V)												
Engine	Information				A10	A20	A40	A50	A70	C10 - C30	C20	E01
All engines	version Mitsubishi						1.331.147	1.431.137				
All engines												1.501.278
2.0 GLSI 4WD												
Petrol 101 11/92-08/96 ENGINE 4G63 (SOHC 16V)												
Engine	Information				A10	A20	A40	A50	A70	C10 - C30	C20	E01
All engines	version Mitsubishi						1.331.147	1.431.137				
All engines												1.501.278
GALANT VIII												
2.0												
Petrol 100 09/96-09/00 ENGINE 4G63 (SOHC 16V)												
Engine	Information				A10	A20	A40	A50	A70	C10 - C30	C20	E01
All engines												1.501.764
2.0												
Petrol 98 09/00-10/04 ENGINE 4G63 (SOHC 16V)												
Engine	Information				A10	A20	A40	A50	A70	C10 - C30	C20	E01
All engines												1.501.764
2.5 V6 24V												
Petrol 118 09/00-10/04 ENGINE 6A13												
Engine	Information				A10	A20	A40	A50	A70	C10 - C30	C20	E01
All engines	version Mitsubishi							1.431.134				
2.5 V6 24V												
Petrol 120 09/96-09/00 ENGINE 6A13												
Engine	Information				A10	A20	A40	A50	A70	C10 - C30	C20	E01
All engines	version Mitsubishi							1.431.134				
GRANDIS												
2.0												
Petrol 77 04/04-> ENGINE 4G63 (SOHC 8V)												
Engine	Information				A10	A20	A40	A50	A70	C10 - C30	C20	E01
All engines												1.501.764
I												
0.7												
Petrol 38 02/07-> ENGINE 3B20												
Engine	Information				A10	A20	A40	A50	A70	C10 - C30	C20	E01
All engines	x 3, COIL ON PLUG									1.970.503	C10	
L200 II												
1.6												
Petrol 60 04/87-10/96 ENGINE 4G32												
Engine	Information				A10	A20	A40	A50	A70	C10 - C30	C20	E01
All engines	version Mitsubishi						1.331.003/00	1.431.023				
2.4												
Petrol 82 06/90-10/96 ENGINE 4G64 (12V)												
Engine	Information				A10	A20	A40	A50	A70	C10 - C30	C20	E01
All engines	version Mitsubishi						1.331.003/00	1.431.107				
2.4 4WD												
Petrol 82 06/94-10/96 ENGINE 4G64 (12V)												
Engine	Information				A10	A20	A40	A50	A70	C10 - C30	C20	E01
All engines	version Mitsubishi							1.431.107				
2.6 4WD												
Petrol 76 11/89-05/95 ENGINE G54B												
Engine	Information				A10	A20	A40	A50	A70	C10 - C30	C20	E01
All engines	version Mitsubishi						1.331.003/00	1.431.023				
L200 III												
2.0												
Petrol 90 06/96-12/07 ENGINE 4G63 (SOHC 16V)												
Engine	Information				A10	A20	A40	A50	A70	C10 - C30	C20	E01
All engines	version Mitsubishi							1.431.131				

A10 CONDENSER	A20 CONTACT SET	A40 DISTRIBUTOR CAP	A50 ROTOR	A70 PICK-UP
C10 COIL	C20 IGNITION MODULE	C30 ELECTRONIC IGNITION KIT	E01 IGNITION CABLE SET	



The present application list is a brief version. For the detailed information about the possibility of installation on a specific vehicle, please refer to our web-catalogue <http://catalogo.facet.eu/>

					FUNCTIONS ON THE VEHICLE											
Vehicle	alim.	kW	Date	Engine	 A10	 A20	 A40	 A50	 A70	 C10 - C30	 C20	 E01				
2.4 4WD																
Petrol 97 06/96-12/07 ENGINE 4G64 (16V)																
Engine Information					A10	A20	A40	A50	A70	C10 - C30	C20	E01				
All engines -->year 30/06/01, version Mitsubishi								1.431.131								
L200 IV																
2.4 i																
Petrol 94 11/05-12/15 ENGINE 4G64 (16V)																
Engine Information					A10	A20	A40	A50	A70	C10 - C30	C20	E01				
All engines -->year 30/06/01, version Mitsubishi								1.431.131								
L400																
2.0																
Petrol 83 12/94-10/02 ENGINE 4G63 (SOHC 16V)																
Engine Information					A10	A20	A40	A50	A70	C10 - C30	C20	E01				
All engines version Mitsubishi								1.431.119								
All engines version Mitsubishi, Multi Point Injection (MPI)								1.431.131								
2.0																
Petrol 85 06/96-03/01 ENGINE 4G63 (SOHC 16V)																
Engine Information					A10	A20	A40	A50	A70	C10 - C30	C20	E01				
All engines version Mitsubishi								1.431.119								
All engines version Mitsubishi, Multi Point Injection (MPI)								1.431.131								
2.4																
Petrol 97 05/95-02/06 ENGINE 4G64 (16V)																
Engine Information					A10	A20	A40	A50	A70	C10 - C30	C20	E01				
All engines version Mitsubishi								1.431.131								
2.4 i 4WD																
Petrol 97 05/95-05/00 ENGINE 4G64 (16V)																
Engine Information					A10	A20	A40	A50	A70	C10 - C30	C20	E01				
All engines version Mitsubishi								1.431.131								
LANCER																
1.8 i																
Petrol 0 10/07-> ENGINE --																
Engine Information					A10	A20	A40	A50	A70	C10 - C30	C20	E01				
All engines pole nr. 4										1.970.497	C10					
LANCER III/IV																
1.2																
Petrol 44 08/86-04/88 ENGINE 4G16																
Engine Information					A10	A20	A40	A50	A70	C10 - C30	C20	E01				
All engines version Mitsubishi							1.331.003/00	1.431.023								
LANCER IX																
1.5																
Petrol 80 06/08-> ENGINE 4A91																
Engine Information					A10	A20	A40	A50	A70	C10 - C30	C20	E01				
All engines x 4, COIL ON PLUG										1.970.505	C10					
1.5 Bifuel																
Petrol/ Liquified Petro- leum Gas (LPG) 80 02/10-> ENGINE 4A91																
Engine Information					A10	A20	A40	A50	A70	C10 - C30	C20	E01				
All engines x 4, COIL ON PLUG										1.970.505	C10					
1.6 MIVEC																
Petrol 86 05/10-> ENGINE 4A92																
Engine Information					A10	A20	A40	A50	A70	C10 - C30	C20	E01				
All engines x 4, COIL ON PLUG										1.970.505	C10					
1.8																
Petrol 103 05/10-> ENGINE 4B10, 4J10																
Engine Information					A10	A20	A40	A50	A70	C10 - C30	C20	E01				
All engines x 4, COIL ON PLUG										1.970.497	C10					
1.8																
Petrol 105 02/08-> ENGINE 4B10																
Engine Information					A10	A20	A40	A50	A70	C10 - C30	C20	E01				
All engines x 4, COIL ON PLUG										1.970.497	C10					
A10 CONDENSER					A20 CONTACT SET					A40 DISTRIBUTOR CAP			A50 ROTOR		A70 PICK-UP	
C10 COIL					C20 IGNITION MODULE					C30 ELECTRONIC IGNITION KIT			E01 IGNITION CABLE SET			

Vehicle	alim.	kW	Date	Engine	FUNCTIONS ON THE VEHICLE									
					A10	A20	A40	A50	A70	C10 - C30	C20	E01		
ENGINE														
1.8 Bifuel	Petrol/ Liquified Petro- leum Gas (LPG)	105	01/10->	4B10										
Engine	Information				A10	A20	A40	A50	A70	C10 - C30	C20	E01		
All engines	x 4, COIL ON PLUG									1.970.497	C10			
ENGINE														
1.8 Flex	Petrol/ Ethanol	103	03/09->	4B10										
Engine	Information				A10	A20	A40	A50	A70	C10 - C30	C20	E01		
All engines	x 4, COIL ON PLUG									1.970.497	C10			
ENGINE														
1.8 Flexfuel	Petrol/ Ethanol	103	03/09->	6B4204T30										
Engine	Information				A10	A20	A40	A50	A70	C10 - C30	C20	E01		
All engines	Qty: 4									1.970.497	C10			
ENGINE														
1.8 Flexfuel	Petrol/ Ethanol	105	01/10->	4B10										
Engine	Information				A10	A20	A40	A50	A70	C10 - C30	C20	E01		
All engines	x 4, COIL ON PLUG									1.970.497	C10			
ENGINE														
1.8 MIVEC	Petrol	103	03/09->	4B10, 4J10										
Engine	Information				A10	A20	A40	A50	A70	C10 - C30	C20	E01		
All engines	x 4, COIL ON PLUG									1.970.497	C10			
ENGINE														
1.8 Mivec	Petrol	110	11/09->	4B10										
Engine	Information				A10	A20	A40	A50	A70	C10 - C30	C20	E01		
All engines	x 4, COIL ON PLUG									1.970.497	C10			
ENGINE														
2.0	Petrol	108	01/09->	4B11										
Engine	Information				A10	A20	A40	A50	A70	C10 - C30	C20	E01		
All engines	x 4, COIL ON PLUG									1.970.497	C10			
ENGINE														
2.0	Petrol	110	01/13->	4B11										
Engine	Information				A10	A20	A40	A50	A70	C10 - C30	C20	E01		
All engines	no specific info conc. application available, pole nr. 4									1.970.497	C10			
ENGINE														
2.0	Petrol	115	04/08->	4B11										
Engine	Information				A10	A20	A40	A50	A70	C10 - C30	C20	E01		
All engines	no specific info conc. application available, pole nr. 4									1.970.497	C10			
ENGINE														
2.0 i	Petrol	113	04/07->	4B11										
Engine	Information				A10	A20	A40	A50	A70	C10 - C30	C20	E01		
All engines	no specific info conc. application available, Qty: 4									1.970.497	C10			
All engines	x 4, COIL ON PLUG									1.970.497	C10			
ENGINE														
2.0 i	Petrol	118	10/09->	4B11										
Engine	Information				A10	A20	A40	A50	A70	C10 - C30	C20	E01		
All engines	no specific info conc. application available, Qty: 4									1.970.497	C10			
ENGINE														
2.0 i 4WD	Petrol	113	03/07->	4B11										
Engine	Information				A10	A20	A40	A50	A70	C10 - C30	C20	E01		
All engines	x 4, COIL ON PLUG									1.970.497	C10			
LANCER V														
ENGINE														
1.2 GL	Petrol	44	05/88-08/92	4G16										
Engine	Information				A10	A20	A40	A50	A70	C10 - C30	C20	E01		
All engines	version Mitsubishi						1.331.003/00	1.431.023						

A10	CONDENSER	A20	CONTACT SET	A40	DISTRIBUTOR CAP	A50	ROTOR	A70	PICK-UP
C10	COIL	C20	IGNITION MODULE	C30	ELECTRONIC IGNITION KIT	E01	IGNITION CABLE SET		

The present application list is a brief version. For the detailed information about the possibility of installation on a specific vehicle, please refer to our web-catalogue <http://catalogo.facet.eu/>



				FUNCTIONS ON THE VEHICLE								
Vehicle	alim.	kW	Date	Engine	 A10	 A20	 A40	 A50	 A70	 C10 - C30	 C20	 E01
1.3	Petrol	44	04/88-05/92	ENGINE 4G13 (8V)								
Engine	Information											
All engines	->year 31/05/90, version Mitsubishi					1.331.003/00	1.431.023					
All engines	01/06/90 ->, version Mitsubishi					1.331.158	1.431.119					
1.3	Petrol	51	08/88-05/92	ENGINE 4G13 (8V), G13B								
Engine	Information											
All engines	->year 31/05/90, version Mitsubishi					1.331.003/00	1.431.023					
All engines	01/06/90 ->, version Mitsubishi					1.331.158	1.431.119					
1.3 12V	Petrol	44	07/90-07/93	ENGINE 4G13 (12V)								
Engine	Information											
All engines	version Mitsubishi					1.331.158	1.431.119					
1.3 12V	Petrol	55	07/90-05/94	ENGINE 4G13 (12V)								
Engine	Information											
All engines	version Mitsubishi					1.331.134						
1.3 GL	Petrol	50	05/88-06/90	ENGINE G13B								
Engine	Information											
All engines	version Mitsubishi					1.331.003/00	1.431.023					
1.3 GL	Petrol	55	07/90-08/92	ENGINE 4G13 (12V)								
Engine	Information											
All engines	version Mitsubishi					1.331.134						
1.5	Petrol	56	09/88-08/90	ENGINE 4G15 (12V)								
Engine	Information											
All engines	->year 31/05/90, version Mitsubishi					1.331.003/00	1.431.107					
All engines	01/06/90 ->, version Mitsubishi					1.331.134						
1.5	Petrol	61	04/89-08/90	ENGINE 4G15 (12V)								
Engine	Information											
All engines	->year 31/05/90, version Mitsubishi					1.331.003/00	1.431.107					
All engines	01/06/90 ->, version Mitsubishi					1.331.134						
1.5	Petrol	62	04/88-05/92	ENGINE 4G15 (12V), 4G15 (8V)								
Engine	Information											
All engines	->year 31/05/90, version Mitsubishi					1.331.003/00	1.431.023					
All engines	01/06/90 ->, version Mitsubishi					1.331.158	1.431.119					
1.5	Petrol	65	09/90-09/92	ENGINE 4G15 (12V)								
Engine	Information											
All engines	version Mitsubishi					1.331.134						
1.5 12V	Petrol	66	05/89-05/92	ENGINE 4G15 (12V)								
Engine	Information											
All engines	->year 31/05/90, version Mitsubishi					1.331.003/00	1.431.107					
All engines	01/06/90 ->, version Mitsubishi					1.331.134						
1.5 GLS	Petrol	63	08/89-08/92	ENGINE 4G15 (12V)								
Engine	Information											
All engines	->year 31/05/90, version Mitsubishi					1.331.003/00	1.431.107					
All engines	01/06/90 ->, version Mitsubishi					1.331.134						
1.6 16V	Petrol	83	06/92-05/94	ENGINE 4G92 (SOHC 16V)								
Engine	Information											
All engines	version Mitsubishi					1.331.138	1.431.137					
All engines												1.501.278

A10 CONDENSER	A20 CONTACT SET	A40 DISTRIBUTOR CAP	A50 ROTOR	A70 PICK-UP
C10 COIL	C20 IGNITION MODULE	C30 ELECTRONIC IGNITION KIT	E01 IGNITION CABLE SET	

Vehicle	alim.	kW	Date	Engine	FUNCTIONS ON THE VEHICLE									
					A10	A20	A40	A50	A70	C10 - C30	C20	E01		
ENGINE														
1.6 4WD	Petrol	84	06/92-11/93	4G92 (SOHC 16V)										
Engine	Information				A10	A20	A40	A50	A70	C10 - C30	C20	E01		
All engines	version Mitsubishi						1.331.138	1.431.137						
All engines													1.501.278	
ENGINE														
1.6 GTi	Petrol	91	05/88-05/90	4G61										
Engine	Information				A10	A20	A40	A50	A70	C10 - C30	C20	E01		
All engines													1.501.401	
ENGINE														
1.8 4WD	Petrol	63	03/89-12/90	4G37										
Engine	Information				A10	A20	A40	A50	A70	C10 - C30	C20	E01		
All engines	->year 31/05/90, version Mitsubishi						1.331.003/00	1.431.023						
All engines	01/06/90 ->, version Mitsubishi						1.331.131	1.431.131						
ENGINE														
1.8 4WD	Petrol	69	08/90-06/92	4G37										
Engine	Information				A10	A20	A40	A50	A70	C10 - C30	C20	E01		
All engines	version Mitsubishi						1.331.131	1.431.131						
ENGINE														
1.8 4WD	Petrol	71	09/89-06/92	4G37										
Engine	Information				A10	A20	A40	A50	A70	C10 - C30	C20	E01		
All engines	->year 31/05/90, version Mitsubishi						1.331.003/00	1.431.107						
All engines	01/06/90 ->, version Mitsubishi						1.331.131	1.431.131						
ENGINE														
1.8 GTi	Petrol	70	06/92-07/93	4G37										
Engine	Information				A10	A20	A40	A50	A70	C10 - C30	C20	E01		
All engines	version Mitsubishi						1.331.131	1.431.131						
ENGINE														
1.8 GTi 16V	Petrol	100	11/89-05/92	4G67										
Engine	Information				A10	A20	A40	A50	A70	C10 - C30	C20	E01		
All engines													1.501.401	
LANCER VI														
ENGINE														
1.5	Petrol	65	09/92-07/96	4G15 (12V)										
Engine	Information				A10	A20	A40	A50	A70	C10 - C30	C20	E01		
All engines	version Mitsubishi						1.331.158	1.431.119						
ENGINE														
1.6	Petrol	66	02/94-12/96	4G92 (SOHC 16V)										
Engine	Information				A10	A20	A40	A50	A70	C10 - C30	C20	E01		
All engines													1.501.278	
ENGINE														
1.6 16V	Petrol	83	06/92-10/03	4G92 (SOHC 16V)										
Engine	Information				A10	A20	A40	A50	A70	C10 - C30	C20	E01		
All engines	version Mitsubishi, no specific info conc. application available						1.331.138, 1.331.168	1.431.136, 1.431.137						
All engines													1.501.278	
ENGINE														
1.6 16V 4WD	Petrol	83	06/92-10/03	4G92 (SOHC 16V)										
Engine	Information				A10	A20	A40	A50	A70	C10 - C30	C20	E01		
All engines	version Mitsubishi, no specific info conc. application available						1.331.138, 1.331.168	1.431.136, 1.431.137						
All engines													1.501.278	
ENGINE														
1.6 i	Petrol	71	09/92-07/96	4G92 (SOHC 16V)										
Engine	Information				A10	A20	A40	A50	A70	C10 - C30	C20	E01		
All engines													1.501.278	
ENGINE														
1.8 GTi	Petrol	70	06/92-07/93	4G37										
Engine	Information				A10	A20	A40	A50	A70	C10 - C30	C20	E01		
All engines	version Mitsubishi						1.331.131	1.431.131						

A10	CONDENSER	A20	CONTACT SET	A40	DISTRIBUTOR CAP	A50	ROTOR	A70	PICK-UP
C10	COIL	C20	IGNITION MODULE	C30	ELECTRONIC IGNITION KIT	E01	IGNITION CABLE SET		

The present application list is a brief version. For the detailed information about the possibility of installation on a specific vehicle, please refer to our web-catalogue <http://catalogo.facet.eu/>





					FUNCTIONS ON THE VEHICLE							
Vehicle	alim.	kW	Date	Engine								
LANCER VII												
1.3 12V	Petrol	55	12/95-08/03	ENGINE 4G13 (12V)								
Engine	Information				A10	A20	A40	A50	A70	C10 - C30	C20	E01
All engines	version Mitsubishi						1.331.168	1.431.136				
All engines												1.501.753
1.5	Petrol	74	06/00-08/03	ENGINE 301353C								
Engine	Information				A10	A20	A40	A50	A70	C10 - C30	C20	E01
All engines	version Mitsubishi						1.331.158	1.431.119				
All engines												1.501.753
1.5 16V	Petrol	69	10/99-08/03	ENGINE 301353C								
Engine	Information				A10	A20	A40	A50	A70	C10 - C30	C20	E01
All engines	version Mitsubishi						1.331.158	1.431.119				
All engines												1.501.753
1.6 16V	Petrol	66	12/95-08/03	ENGINE 4G92 (SOHC 16V)								
Engine	Information				A10	A20	A40	A50	A70	C10 - C30	C20	E01
All engines												1.501.764
2.0 16V EVO IV	Petrol	199	08/96-06/97	ENGINE 4G63 Turbo								
Engine	Information				A10	A20	A40	A50	A70	C10 - C30	C20	E01
All engines												1.499.251
EVO V	Petrol	206	01/98-12/98	ENGINE 4G63 Turbo								
Engine	Information				A10	A20	A40	A50	A70	C10 - C30	C20	E01
All engines												1.499.251
EVO VI	Petrol	207	01/99-02/01	ENGINE 4G63 Turbo								
Engine	Information				A10	A20	A40	A50	A70	C10 - C30	C20	E01
All engines												1.499.251
LANCER VIII												
1.3	Petrol	60	09/03-12/13	ENGINE 4G13 (16V)								
Engine	Information				A10	A20	A40	A50	A70	C10 - C30	C20	E01
All engines												1.501.883
1.6	Petrol	72	09/03-12/13	ENGINE 4G18								
Engine	Information				A10	A20	A40	A50	A70	C10 - C30	C20	E01
All engines												1.501.883
1.8 SEi Limited	Petrol	91	09/03-03/07	ENGINE 4G93 (GDI)								
Engine	Information				A10	A20	A40	A50	A70	C10 - C30	C20	E01
All engines	Qty: 4									1.970.497	C10	
2.0	Petrol	85	09/03->	ENGINE 4G63 (DOHC 16V)								
Engine	Information				A10	A20	A40	A50	A70	C10 - C30	C20	E01
All engines												1.499.251
2.0	Petrol	99	09/03-12/13	ENGINE 4G63 (DOHC 16V), 4G63-7								
Engine	Information				A10	A20	A40	A50	A70	C10 - C30	C20	E01
All engines												1.499.251
MIRAGE III												
1.5	Petrol	62	05/88-06/90	ENGINE 4G15 (12V)								
Engine	Information				A10	A20	A40	A50	A70	C10 - C30	C20	E01
All engines	version Mitsubishi						1.331.134					

A10 CONDENSER	A20 CONTACT SET	A40 DISTRIBUTOR CAP	A50 ROTOR	A70 PICK-UP
C10 COIL	C20 IGNITION MODULE	C30 ELECTRONIC IGNITION KIT	E01 IGNITION CABLE SET	

Vehicle	alim.	kW	Date	Engine	FUNCTIONS ON THE VEHICLE									
					A10	A20	A40	A50	A70	C10 - C30	C20	E01		
ENGINE														
1.5 12V	Petrol	60	05/88-06/90	4G15 (12V)										
Engine		Information			A10	A20	A40	A50	A70	C10 - C30	C20	E01		
All engines		version Mitsubishi					1.331.134							
ENGINE														
1.5 12V	Petrol	62	05/88-06/90	4G15 (12V)										
Engine		Information			A10	A20	A40	A50	A70	C10 - C30	C20	E01		
All engines		version Mitsubishi					1.331.134							
MONTERO														
ENGINE														
2.4 16V	Petrol	100	04/91->	4G64 (12V)										
Engine		Information			A10	A20	A40	A50	A70	C10 - C30	C20	E01		
All engines		version Mitsubishi					1.331.003/00	1.431.107						
ENGINE														
2.6i [USA]	Petrol	76	01/83-12/90	4G54										
Engine		Information			A10	A20	A40	A50	A70	C10 - C30	C20	E01		
All engines		version Mitsubishi					1.331.003/00	1.431.023						
MONTERO IO														
ENGINE														
1.8 GDI	Petrol	88	08/99->	4G93 (SOHC 16V)										
Engine		Information			A10	A20	A40	A50	A70	C10 - C30	C20	E01		
All engines												1.501.764		
MONTERO SPORT														
ENGINE														
3.0 V6	Petrol	130	11/98->	6G72										
Engine		Information			A10	A20	A40	A50	A70	C10 - C30	C20	E01		
All engines												1.501.344		
OUTLANDER I														
ENGINE														
2.0	Petrol	100	05/03-10/06	4G63 (DOHC 16V)										
Engine		Information			A10	A20	A40	A50	A70	C10 - C30	C20	E01		
All engines												1.499.251		
ENGINE														
2.0 4WD	Petrol	100	05/03-10/06	4G63 (DOHC 16V)										
Engine		Information			A10	A20	A40	A50	A70	C10 - C30	C20	E01		
All engines												1.499.251		
ENGINE														
2.0 4WD	Petrol	93	05/03-10/06	4G63 (DOHC 16V)										
Engine		Information			A10	A20	A40	A50	A70	C10 - C30	C20	E01		
All engines												1.499.251		
ENGINE														
2.0 Turbo 4WD	Petrol	148	04/04-10/06	4G63-T (DOHC 16V)										
Engine		Information			A10	A20	A40	A50	A70	C10 - C30	C20	E01		
All engines												1.499.251		
ENGINE														
2.0 Turbo-R 4WD	Petrol	177	01/02-10/06	4G63 Turbo										
Engine		Information			A10	A20	A40	A50	A70	C10 - C30	C20	E01		
All engines												1.499.251		
ENGINE														
2.4 4WD	Petrol	102	05/03-10/06	4G64 (16V)										
Engine		Information			A10	A20	A40	A50	A70	C10 - C30	C20	E01		
All engines		Qty: 4, no specific info conc. application available								1.970.497	C10			
ENGINE														
2.4 HDD Mivec	Petrol	118	03/01-12/06	4G69										
Engine		Information			A10	A20	A40	A50	A70	C10 - C30	C20	E01		
All engines		Qty: 4, no specific info conc. application available								1.970.497	C10			
OUTLANDER II														
ENGINE														
2.0	Petrol	108	11/06-11/12	4B11										
Engine		Information			A10	A20	A40	A50	A70	C10 - C30	C20	E01		
All engines		x 4, COIL ON PLUG								1.970.497	C10			

A10	CONDENSER	A20	CONTACT SET	A40	DISTRIBUTOR CAP	A50	ROTOR	A70	PICK-UP
C10	COIL	C20	IGNITION MODULE	C30	ELECTRONIC IGNITION KIT	E01	IGNITION CABLE SET		

The present application list is a brief version. For the detailed information about the possibility of installation on a specific vehicle, please refer to our web-catalogue <http://catalogo.facet.eu/>

					FUNCTIONS ON THE VEHICLE							
Vehicle	alim.	kW	Date	Engine								
ENGINE												
2.0	Petrol	118	06/09-11/12	4B11								
Engine		Information			A10	A20	A40	A50	A70	C10 - C30	C20	E01
All engines		Qty: 4								1.970.497	C10	
ENGINE												
2.0 4WD	Petrol	108	11/06-11/12	4B11								
Engine		Information			A10	A20	A40	A50	A70	C10 - C30	C20	E01
All engines		x 4, COIL ON PLUG								1.970.497	C10	
ENGINE												
2.4	Petrol	125	11/06-11/12	4B12								
Engine		Information			A10	A20	A40	A50	A70	C10 - C30	C20	E01
All engines		x 4, COIL ON PLUG								1.970.497	C10	
ENGINE												
2.4 4WD	Petrol	125	09/07-11/12	4B12								
Engine		Information			A10	A20	A40	A50	A70	C10 - C30	C20	E01
All engines		x 4, COIL ON PLUG								1.970.497	C10	
ENGINE												
2.4 Flex 4WD	Petrol/ Ethanol	125	09/07-11/12	4B12								
Engine		Information			A10	A20	A40	A50	A70	C10 - C30	C20	E01
All engines		x 4, COIL ON PLUG								1.970.497	C10	
ENGINE												
3.0 4WD	Petrol	162	11/06-11/12	6B31								
Engine		Information			A10	A20	A40	A50	A70	C10 - C30	C20	E01
All engines		x 6, COIL ON PLUG								1.970.497	C10	
ENGINE												
3.0 4WD	Petrol	169	09/10-12/12	6B31								
Engine		Information			A10	A20	A40	A50	A70	C10 - C30	C20	E01
All engines		x 6, COIL ON PLUG								1.970.497	C10	
ENGINE												
3.0 4WD	Petrol	177	10/09-11/12	6B31								
Engine		Information			A10	A20	A40	A50	A70	C10 - C30	C20	E01
All engines		Qty: 6								1.970.497	C10	
ENGINE												
3.0 AWD	Petrol	164	11/06-12/10	6B31								
Engine		Information			A10	A20	A40	A50	A70	C10 - C30	C20	E01
All engines		x 6, COIL ON PLUG								1.970.497	C10	
ENGINE												
3.0 FWD	Petrol	162	11/06-11/12	6B31								
Engine		Information			A10	A20	A40	A50	A70	C10 - C30	C20	E01
All engines		Qty: 6								1.970.497	C10	
ENGINE												
OUTLANDER III												
3.0	Petrol	0	08/12->	6B31								
Engine		Information			A10	A20	A40	A50	A70	C10 - C30	C20	E01
All engines		Qty: 6								1.970.497	C10	
ENGINE												
3.0 4WD	Petrol	165	03/14->	6B31								
Engine		Information			A10	A20	A40	A50	A70	C10 - C30	C20	E01
All engines		x 6, COIL ON PLUG								1.970.497	C10	
ENGINE												
3.0 4WD	Petrol	169	03/14->	6B31								
Engine		Information			A10	A20	A40	A50	A70	C10 - C30	C20	E01
All engines		x 6, COIL ON PLUG								1.970.497	C10	
ENGINE												
3.0 GT 4WD	Petrol	167	08/12->	6B31								
Engine		Information			A10	A20	A40	A50	A70	C10 - C30	C20	E01
All engines		x 6, COIL ON PLUG								1.970.497	C10	

A10 CONDENSER	A20 CONTACT SET	A40 DISTRIBUTOR CAP	A50 ROTOR	A70 PICK-UP
C10 COIL	C20 IGNITION MODULE	C30 ELECTRONIC IGNITION KIT	E01 IGNITION CABLE SET	

Vehicle	alim.	kW	Date	Engine	FUNCTIONS ON THE VEHICLE							
					A10	A20	A40	A50	A70	C10 - C30	C20	E01

PAJERO I

2.6	Petrol	76	01/83-11/90	ENGINE 4G54
-----	--------	----	-------------	----------------

Engine	Information	A10	A20	A40	A50	A70	C10 - C30	C20	E01
All engines	->year 31/08/84, version Mitsubishi		1.231.085						
All engines	version Mitsubishi			1.331.003/00	1.431.023				

2.6 4WD	Petrol	76	01/83-09/87	ENGINE 4G54
---------	--------	----	-------------	----------------

Engine	Information	A10	A20	A40	A50	A70	C10 - C30	C20	E01
All engines	->year 31/08/84, version Mitsubishi		1.231.085						
All engines	version Mitsubishi			1.331.003/00	1.431.023				

2.6 4WD	Petrol	79	10/86-05/91	ENGINE 4G54
---------	--------	----	-------------	----------------

Engine	Information	A10	A20	A40	A50	A70	C10 - C30	C20	E01
All engines	version Mitsubishi		1.231.085	1.331.003/00	1.431.023				

3.0 i 4WD	Petrol	105	05/88-05/91	ENGINE 6G72 (SOHC 12V)
-----------	--------	-----	-------------	---------------------------

Engine	Information	A10	A20	A40	A50	A70	C10 - C30	C20	E01
All engines	version Mitsubishi			1.331.116	1.431.109				

3.0 V6	Petrol	104	11/88-11/90	ENGINE 6G72 (SOHC 12V)
--------	--------	-----	-------------	---------------------------

Engine	Information	A10	A20	A40	A50	A70	C10 - C30	C20	E01
All engines	version Mitsubishi			1.331.116	1.431.109				

PAJERO II

2.4	Petrol	82	04/91-04/00	ENGINE 4G64 (12V)
-----	--------	----	-------------	----------------------

Engine	Information	A10	A20	A40	A50	A70	C10 - C30	C20	E01
All engines	version Mitsubishi			1.331.003/00	1.431.107				

2.6 4WD	Petrol	76	03/91-10/97	ENGINE 4G54
---------	--------	----	-------------	----------------

Engine	Information	A10	A20	A40	A50	A70	C10 - C30	C20	E01
All engines	version Mitsubishi			1.331.003/00	1.431.023				

3.0 V6	Petrol	110	12/90-12/95	ENGINE 6G72 (SOHC 12V)
--------	--------	-----	-------------	---------------------------

Engine	Information	A10	A20	A40	A50	A70	C10 - C30	C20	E01
All engines	version Mitsubishi			1.331.116	1.431.109				

3.0 V6 24V	Petrol	130	06/97-10/99	ENGINE 6G72 (SOHC 24V)
------------	--------	-----	-------------	---------------------------

Engine	Information	A10	A20	A40	A50	A70	C10 - C30	C20	E01
All engines									1.501.344

3.0 V6 24V	Petrol	133	06/94-04/00	ENGINE 6G72 (SOHC 24V)
------------	--------	-----	-------------	---------------------------

Engine	Information	A10	A20	A40	A50	A70	C10 - C30	C20	E01
All engines	01/06/97 ->								1.501.344

3.0 V6 4WD	Petrol	110	12/90-12/95	ENGINE 6G72 (SOHC 12V)
------------	--------	-----	-------------	---------------------------

Engine	Information	A10	A20	A40	A50	A70	C10 - C30	C20	E01
All engines	version Mitsubishi			1.331.116	1.431.109				

3.5 V6 24V	Petrol	143	07/97-10/99	ENGINE 6G74 (DOHC 24V), 6G74 (SOHC 24V)
------------	--------	-----	-------------	--

Engine	Information	A10	A20	A40	A50	A70	C10 - C30	C20	E01
All engines	01/06/97 ->								1.501.344

3.5 V6 24V	Petrol	153	06/94-10/99	ENGINE 6G74 (DOHC 24V), 6G74 (SOHC 24V)
------------	--------	-----	-------------	--

Engine	Information	A10	A20	A40	A50	A70	C10 - C30	C20	E01
All engines	01/06/97 ->								1.501.344

A10 CONDENSER	A20 CONTACT SET	A40 DISTRIBUTOR CAP	A50 ROTOR	A70 PICK-UP
C10 COIL	C20 IGNITION MODULE	C30 ELECTRONIC IGNITION KIT	E01 IGNITION CABLE SET	

The present application list is a brief version. For the detailed information about the possibility of installation on a specific vehicle, please refer to our web-catalogue <http://catalogo.facet.eu/>

					FUNCTIONS ON THE VEHICLE							
Vehicle	alim.	kW	Date	Engine	 A10	 A20	 A40	 A50	 A70	 C10 - C30	 C20	 E01
PAJERO III												
2.4	Petrol	82	10/01-08/06	ENGINE 4G64 (12V)								
Engine Information					A10	A20	A40	A50	A70	C10 - C30	C20	E01
All engines version Mitsubishi							1.331.003/00	1.431.107				
2.4 4x4	Petrol	82	10/01-12/06	ENGINE 4G64 (12V)								
Engine Information					A10	A20	A40	A50	A70	C10 - C30	C20	E01
All engines version Mitsubishi							1.331.003/00	1.431.107				
3.0	Petrol	125	10/01-12/06	ENGINE 6G72 (SOHC 24V)								
Engine Information					A10	A20	A40	A50	A70	C10 - C30	C20	E01
All engines												1.501.344
3.0 ZR	Petrol	132	08/03->	ENGINE 6G72 (DOHC 24V)								
Engine Information					A10	A20	A40	A50	A70	C10 - C30	C20	E01
All engines												1.501.344
3.5	Petrol	149	04/00-01/07	ENGINE 6G74 (DOHC 24V)								
Engine Information					A10	A20	A40	A50	A70	C10 - C30	C20	E01
All engines 01/06/97 ->												1.501.344
3.5 i	Petrol	160	09/03-10/06	ENGINE 6G74 (DOHC 24V), 6G74 (SOHC 24V)								
Engine Information					A10	A20	A40	A50	A70	C10 - C30	C20	E01
All engines 01/06/97 ->												1.501.344
3.5 V6 GDI	Petrol	149	04/00-12/06	ENGINE 6G74 (GDI)								
Engine Information					A10	A20	A40	A50	A70	C10 - C30	C20	E01
All engines 01/06/97 ->												1.501.344
PAJERO PININ												
1.8	Petrol	84	11/01-06/07	ENGINE 4G93 (SOHC 16V)								
Engine Information					A10	A20	A40	A50	A70	C10 - C30	C20	E01
All engines												1.501.764
1.8 GDI	Petrol	88	10/99-10/01	ENGINE 4G93 (GDI)								
Engine Information					A10	A20	A40	A50	A70	C10 - C30	C20	E01
All engines												1.501.764
PAJERO SPORT I												
3.0 4WD	Petrol	129	09/96-12/01	ENGINE 6G72 (SOHC 24V)								
Engine Information					A10	A20	A40	A50	A70	C10 - C30	C20	E01
All engines												1.501.344
3.0 V6	Petrol	125	06/00->	ENGINE 6G72 (SOHC 24V)								
Engine Information					A10	A20	A40	A50	A70	C10 - C30	C20	E01
All engines												1.501.344
3.0 V6	Petrol	130	11/98-10/00	ENGINE 6G72 (SOHC 24V)								
Engine Information					A10	A20	A40	A50	A70	C10 - C30	C20	E01
All engines												1.501.344
3.0 V6 4WD	Petrol	123	03/03->	ENGINE 6G72 (DOHC 24V)								
Engine Information					A10	A20	A40	A50	A70	C10 - C30	C20	E01
All engines												1.501.344
PAJERO SPORT II												
2.4	Petrol	94	07/08->	ENGINE 4G64 (16V)								
Engine Information					A10	A20	A40	A50	A70	C10 - C30	C20	E01
All engines version Mitsubishi							1.331.003/00	1.431.107				

A10 CONDENSER	A20 CONTACT SET	A40 DISTRIBUTOR CAP	A50 ROTOR	A70 PICK-UP
C10 COIL	C20 IGNITION MODULE	C30 ELECTRONIC IGNITION KIT	E01 IGNITION CABLE SET	

Vehicle	alim.	kW	Date	Engine	FUNCTIONS ON THE VEHICLE									
					A10	A20	A40	A50	A70	C10 - C30	C20	E01		
ENGINE														
3.0	Petrol	162	09/08->	6B31										
Engine					A10	A20	A40	A50	A70	C10 - C30	C20	E01		
All engines										1.970.497	C10			
ENGINE														
3.0 4WD	Petrol	162	09/08->	6B31										
Engine					A10	A20	A40	A50	A70	C10 - C30	C20	E01		
All engines										1.970.497	C10			
PRECIS														
ENGINE														
1.5 i [USA]	Petrol	0	01/89-12/94	G4DJ										
Engine					A10	A20	A40	A50	A70	C10 - C30	C20	E01		
All engines							1.331.003/00	1.431.107						
SHOGUN														
ENGINE														
1.2.6 4x4	Petrol	76	01/84-02/91	4G54										
Engine					A10	A20	A40	A50	A70	C10 - C30	C20	E01		
All engines						1.231.085								
All engines							1.331.003/00							
All engines								1.431.023						
SIGMA														
ENGINE														
3.0	Petrol	125	06/92-10/96	6G72 (SOHC 12V)										
Engine					A10	A20	A40	A50	A70	C10 - C30	C20	E01		
All engines							1.331.143							
ENGINE														
3.0 V6	Petrol	130	12/90-07/96	6G72 (SOHC 12V)										
Engine					A10	A20	A40	A50	A70	C10 - C30	C20	E01		
All engines							1.331.143							
SPACE GEAR														
ENGINE														
2.0 16V	Petrol	83	08/96-05/00	4G63 (DOHC 16V)										
Engine					A10	A20	A40	A50	A70	C10 - C30	C20	E01		
All engines								1.431.119						
All engines								1.431.131						
ENGINE														
2.4 i	Petrol	97	05/95-05/00	4G64 (16V)										
Engine					A10	A20	A40	A50	A70	C10 - C30	C20	E01		
All engines								1.431.131						
SPACE RUNNER														
ENGINE														
1.8	Petrol	85	06/96-08/99	4G93 (SOHC 16V)										
Engine					A10	A20	A40	A50	A70	C10 - C30	C20	E01		
All engines							1.331.138	1.431.137						
All engines								1.431.136						
All engines													1.501.278	
ENGINE														
1.8	Petrol	90	10/91-08/99	4G93 (SOHC 16V)										
Engine					A10	A20	A40	A50	A70	C10 - C30	C20	E01		
All engines							1.331.138	1.431.137						
All engines								1.431.136						
All engines													1.501.278	
ENGINE														
1.8 4WD	Petrol	85	06/96-08/99	4G93 (SOHC 16V)										
Engine					A10	A20	A40	A50	A70	C10 - C30	C20	E01		
All engines							1.331.138							
All engines								1.431.136						
All engines								1.431.137						
All engines													1.501.278	

A10	CONDENSER	A20	CONTACT SET	A40	DISTRIBUTOR CAP	A50	ROTOR	A70	PICK-UP
C10	COIL	C20	IGNITION MODULE	C30	ELECTRONIC IGNITION KIT	E01	IGNITION CABLE SET		

The present application list is a brief version. For the detailed information about the possibility of installation on a specific vehicle, please refer to our web-catalogue <http://catalogo.facet.eu/>

				FUNCTIONS ON THE VEHICLE								
Vehicle	alim.	kW	Date	Engine	 A10	 A20	 A40	 A50	 A70	 C10 - C30	 C20	 E01
				ENGINE								
1.8 4WD	Petrol	90	10/91-08/99	4G93 (SOHC 16V)								
Engine	Information			A10	A20	A40	A50	A70	C10 - C30	C20	E01	
All engines	version Mitsubishi					1.331.138	1.431.136					
All engines	01/06/96 ->, version Mitsubishi						1.431.136					
All engines	->year 31/05/96, version Mitsubishi						1.431.137					
All engines												1.501.278
				ENGINE								
2.0	Petrol	100	08/99-08/02	4G63 (SOHC 16V)								
Engine	Information			A10	A20	A40	A50	A70	C10 - C30	C20	E01	
All engines												1.501.764
				ENGINE								
2.0	Petrol	98	05/00-08/02	4G63 (SOHC 16V)								
Engine	Information			A10	A20	A40	A50	A70	C10 - C30	C20	E01	
All engines												1.501.764
				SPACE STAR								
				ENGINE								
1.3 16V	Petrol	60	09/00-12/04	4G13 (16V)								
Engine	Information			A10	A20	A40	A50	A70	C10 - C30	C20	E01	
All engines	->year 31/05/00, version Mitsubishi					1.331.168	1.431.136					
All engines	->year 31/05/00											1.501.882
All engines	01/06/00 ->											1.501.883
				ENGINE								
1.3 16V	Petrol	61	12/98-12/04	4G13 (16V)								
Engine	Information			A10	A20	A40	A50	A70	C10 - C30	C20	E01	
All engines	->year 31/05/00, version Mitsubishi					1.331.168	1.431.136					
All engines	->year 31/05/00											1.501.882
All engines	01/06/00 ->											1.501.883
				ENGINE								
1.3 16V	Petrol	63	06/98-12/04	4G13 (16V)								
Engine	Information			A10	A20	A40	A50	A70	C10 - C30	C20	E01	
All engines	->year 31/05/00, version Mitsubishi					1.331.168	1.431.136					
All engines	->year 31/05/00											1.501.882
All engines	01/06/00 ->											1.501.883
				ENGINE								
1.6 16V	Petrol	72	01/01-12/04	4G18								
Engine	Information			A10	A20	A40	A50	A70	C10 - C30	C20	E01	
All engines												1.501.883
				ENGINE								
1.8 GDI	Petrol	87	06/98-12/04	4G93 (GDI)								
Engine	Information			A10	A20	A40	A50	A70	C10 - C30	C20	E01	
All engines												1.501.764
				ENGINE								
1.8 GDI	Petrol	90	06/98-12/04	4G93 (GDI)								
Engine	Information			A10	A20	A40	A50	A70	C10 - C30	C20	E01	
All engines												1.501.764
				ENGINE								
1.8 MPI	Petrol	82	10/02-12/04	4G93 (DOHC 16V)								
Engine	Information			A10	A20	A40	A50	A70	C10 - C30	C20	E01	
All engines												1.501.764
				SPACE WAGON								
				ENGINE								
1.8	Petrol	90	10/91-10/98	4G93 (SOHC 16V)								
Engine	Information			A10	A20	A40	A50	A70	C10 - C30	C20	E01	
All engines	version Mitsubishi					1.331.138	1.431.137					
All engines												1.501.278
				ENGINE								
1.8 4WD	Petrol	90	10/91-10/98	4G93 (SOHC 16V)								
Engine	Information			A10	A20	A40	A50	A70	C10 - C30	C20	E01	
All engines	version Mitsubishi					1.331.138	1.431.137					
All engines												1.501.278

A10 CONDENSER	A20 CONTACT SET	A40 DISTRIBUTOR CAP	A50 ROTOR	A70 PICK-UP
C10 COIL	C20 IGNITION MODULE	C30 ELECTRONIC IGNITION KIT	E01 IGNITION CABLE SET	

Vehicle	alim.	kW	Date	Engine	FUNCTIONS ON THE VEHICLE									
					A10	A20	A40	A50	A70	C10 - C30	C20	E01		
ENGINE														
2.0	Petrol	98	10/92-10/98	4G63 (SOHC 16V)										
Engine		Information			A10	A20	A40	A50	A70	C10 - C30	C20	E01		
All engines		version Mitsubishi					1.331.138	1.431.137						
All engines													1.501.278	
ENGINE														
2.0 16V	Petrol	98	06/00->	4G63 (DOHC 16V)										
Engine		Information			A10	A20	A40	A50	A70	C10 - C30	C20	E01		
All engines													1.501.764	
ENGINE														
2.0 4WD	Petrol	98	10/92-10/98	4G63 (SOHC 16V)										
Engine		Information			A10	A20	A40	A50	A70	C10 - C30	C20	E01		
All engines		version Mitsubishi					1.331.138	1.431.137						
All engines													1.501.278	
ENGINE														
2.4 GDI	Petrol	110	07/98->	4G64 (GDI)										
Engine		Information			A10	A20	A40	A50	A70	C10 - C30	C20	E01		
All engines													1.501.764	
ENGINE														
2.4 GDi GLX	Petrol	108	08/00-05/03	4G64 (GDI)										
Engine		Information			A10	A20	A40	A50	A70	C10 - C30	C20	E01		
All engines													1.501.764	
ENGINE														
2.4 GDi GLX	Petrol	110	11/97-07/00	4G64 (GDI)										
Engine		Information			A10	A20	A40	A50	A70	C10 - C30	C20	E01		
All engines													1.501.764	
STARION														
ENGINE														
2.0 Turbo Eci	Petrol	125	06/82-12/85	4G63-T (ECI)										
Engine		Information			A10	A20	A40	A50	A70	C10 - C30	C20	E01		
All engines		01/06/84 ->, version Mitsubishi					1.331.003/00	1.431.023						
ENGINE														
2.0 Turbo Eci	Petrol	132	05/85-08/87	4G63-T/C										
Engine		Information			A10	A20	A40	A50	A70	C10 - C30	C20	E01		
All engines		01/06/84 ->, version Mitsubishi					1.331.003/00	1.431.023						
VALLEY														
ENGINE														
2.0	Petrol	75	09/92-10/94	4G63-T										
Engine		Information			A10	A20	A40	A50	A70	C10 - C30	C20	E01		
All engines		version Denso					1.313.117	1.413.030						

A10	CONDENSER	A20	CONTACT SET	A40	DISTRIBUTOR CAP	A50	ROTOR	A70	PICK-UP
C10	COIL	C20	IGNITION MODULE	C30	ELECTRONIC IGNITION KIT	E01	IGNITION CABLE SET		

The present application list is a brief version. For the detailed information about the possibility of installation on a specific vehicle, please refer to our web-catalogue <http://catalogo.facet.eu/>

Vehicle	alim.	kW	Date	Engine	FUNCTIONS ON THE VEHICLE							
					A10	A20	A40	A50	A70	C10 - C30	C20	E01

MARINA

1.8	Petrol	59	04/71-12/79	--	ENGINE							
------------	--------	-----------	-------------	----	---------------	--	--	--	--	--	--	--

Engine	Information	A10	A20	A40	A50	A70	C10 - C30	C20	E01
All engines			1.228.083MHV	1.328.075	1.428.006				

1.8 TC	Petrol	68	04/71-09/75	--	ENGINE							
---------------	--------	-----------	-------------	----	---------------	--	--	--	--	--	--	--

Engine	Information	A10	A20	A40	A50	A70	C10 - C30	C20	E01
All engines			1.228.083MHV	1.328.075	1.428.006				

1300	Petrol	42	04/71-06/80	--	ENGINE							
-------------	--------	-----------	-------------	----	---------------	--	--	--	--	--	--	--

Engine	Information	A10	A20	A40	A50	A70	C10 - C30	C20	E01
All engines			1.228.083MHV	1.328.075	1.428.006				

1300	Petrol	44	04/71-06/75	--	ENGINE							
-------------	--------	-----------	-------------	----	---------------	--	--	--	--	--	--	--

Engine	Information	A10	A20	A40	A50	A70	C10 - C30	C20	E01
All engines			1.228.083MHV	1.328.075	1.428.006				

1800	Petrol	53	04/71-12/75	--	ENGINE							
-------------	--------	-----------	-------------	----	---------------	--	--	--	--	--	--	--

Engine	Information	A10	A20	A40	A50	A70	C10 - C30	C20	E01
All engines			1.228.083MHV	1.328.075	1.428.006				

1800	Petrol	57	04/71-10/75	--	ENGINE							
-------------	--------	-----------	-------------	----	---------------	--	--	--	--	--	--	--

Engine	Information	A10	A20	A40	A50	A70	C10 - C30	C20	E01
All engines			1.228.083MHV	1.328.075	1.428.006				

1800 TC	Petrol	70	04/71-12/75	--	ENGINE							
----------------	--------	-----------	-------------	----	---------------	--	--	--	--	--	--	--

Engine	Information	A10	A20	A40	A50	A70	C10 - C30	C20	E01
All engines			1.228.083MHV	1.328.075	1.428.006				

MINOR

0.9	Petrol	28	11/55-12/62	--	ENGINE							
------------	--------	-----------	-------------	----	---------------	--	--	--	--	--	--	--

Engine	Information	A10	A20	A40	A50	A70	C10 - C30	C20	E01
All engines					1.428.006				

1.1	Petrol	37	01/62-10/71	--	ENGINE							
------------	--------	-----------	-------------	----	---------------	--	--	--	--	--	--	--

Engine	Information	A10	A20	A40	A50	A70	C10 - C30	C20	E01
All engines				1.328.075	1.428.006				

OXFORD

1.5	Petrol	44	11/59-09/62	--	ENGINE							
------------	--------	-----------	-------------	----	---------------	--	--	--	--	--	--	--

Engine	Information	A10	A20	A40	A50	A70	C10 - C30	C20	E01
All engines					1.428.006				

1.7	Petrol	63	05/62-04/70	--	ENGINE							
------------	--------	-----------	-------------	----	---------------	--	--	--	--	--	--	--

Engine	Information	A10	A20	A40	A50	A70	C10 - C30	C20	E01
All engines				1.328.075	1.428.006				

A10 CONDENSER	A20 CONTACT SET	A40 DISTRIBUTOR CAP	A50 ROTOR	A70 PICK-UP
C10 COIL	C20 IGNITION MODULE	C30 ELECTRONIC IGNITION KIT	E01 IGNITION CABLE SET	

Vehicle	alim.	kW	Date	Engine	FUNCTIONS ON THE VEHICLE							
					A10	A20	A40	A50	A70	C10 - C30	C20	E01

100NX

				ENGINE
1.6	Petrol	66	03/90-10/94	GA16DS

Engine	Information	A10	A20	A40	A50	A70	C10 - C30	C20	E01
All engines	FOR: (D), FOR: (NL), FOR: (CH), FOR: (A), FOR: (S), FOR: (SF), FOR: (N), FOR: (DK), version Hitachi			1.322.046	1.422.070				
All engines	FOR: (F), FOR: (B), FOR: (I), FOR: (E), FOR: (P), FOR: (GR), version Lucas			1.328.101					
All engines	FOR: (F), FOR: (B), FOR: (I), FOR: (E), FOR: (P), FOR: (GR), version Hitachi				1.422.086				

				ENGINE
1.6 SR	Petrol	75	09/93-10/94	GA16DE

Engine	Information	A10	A20	A40	A50	A70	C10 - C30	C20	E01
All engines									1.501.399

				ENGINE
2.0	Petrol	110	10/90-10/94	SR20DE

Engine	Information	A10	A20	A40	A50	A70	C10 - C30	C20	E01
All engines	version Hitachi			1.322.073	1.422.085				

				ENGINE
2.0 GTI	Petrol	105	03/91-10/94	SR20DE

Engine	Information	A10	A20	A40	A50	A70	C10 - C30	C20	E01
All engines	version Hitachi			1.322.073	1.422.085				

200 SX

				ENGINE
1.8i Turbo	Petrol	0	01/87->	CA18ET

Engine	Information	A10	A20	A40	A50	A70	C10 - C30	C20	E01
All engines	version Hitachi			1.322.040	1.422.066				

240SX

				ENGINE
2.4	Petrol	112	05/94-08/97	KA24DE

Engine	Information	A10	A20	A40	A50	A70	C10 - C30	C20	E01
All engines	01/01/95 ->, version Mitsubishi			1.331.152	1.431.136				

				ENGINE
2.4	Petrol	115	04/93-09/94	KA24DE

Engine	Information	A10	A20	A40	A50	A70	C10 - C30	C20	E01
All engines	->year 31/12/94, version Mitsubishi				1.431.118				

ALMERA

				ENGINE
1.6	Petrol	75	11/12->	K4M

Engine	Information	A10	A20	A40	A50	A70	C10 - C30	C20	E01
All engines	Qty: 4						1.970.432	C10	

ALMERA I

				ENGINE
1.4	Petrol	64	09/95-07/00	GA14DE

Engine	Information	A10	A20	A40	A50	A70	C10 - C30	C20	E01
All engines	->year 31/01/98, version Hitachi			1.322.089					
All engines	version Hitachi				1.422.102				
All engines									1.501.399

				ENGINE
1.4 GX, LX	Petrol	55	09/95-07/00	GA14DE

Engine	Information	A10	A20	A40	A50	A70	C10 - C30	C20	E01
All engines	->year 31/01/98, version Hitachi			1.322.089					
All engines	version Hitachi				1.422.102				
All engines									1.501.399

				ENGINE
1.4 S, GX, LX	Petrol	55	09/95-03/00	GA14DE

Engine	Information	A10	A20	A40	A50	A70	C10 - C30	C20	E01
All engines	->year 31/01/98, version Hitachi			1.322.089					
All engines	version Hitachi				1.422.102				
All engines									1.501.399

				ENGINE
1.6	Petrol	73	09/95-07/00	GA16DE

Engine	Information	A10	A20	A40	A50	A70	C10 - C30	C20	E01
All engines	->year 31/01/98, version Hitachi			1.322.089					

A10	CONDENSER	A20	CONTACT SET	A40	DISTRIBUTOR CAP	A50	ROTOR	A70	PICK-UP
C10	COIL	C20	IGNITION MODULE	C30	ELECTRONIC IGNITION KIT	E01	IGNITION CABLE SET		

Vehicle	alim.	kW	Date	Engine	FUNCTIONS ON THE VEHICLE								
					A10	A20	A40	A50	A70	C10 - C30	C20	E01	
ENGINE													
1.6	Petrol	73	09/95-07/00	GA16DE									
ENGINE													
Engine	Information			A10	A20	A40	A50	A70	C10 - C30	C20	E01		
All engines	version Hitachi						1.422.102						
All engines													1.501.399
ENGINE													
1.6	Petrol	75	07/95-03/00	GA16DE									
ENGINE													
Engine	Information			A10	A20	A40	A50	A70	C10 - C30	C20	E01		
All engines	->year 31/01/98, version Hitachi					1.322.089							
All engines	version Hitachi						1.422.102						
All engines													1.501.399
ENGINE													
1.6	Petrol	86	09/95-07/00	GA16DE									
ENGINE													
Engine	Information			A10	A20	A40	A50	A70	C10 - C30	C20	E01		
All engines	->year 31/01/98, version Hitachi					1.322.089							
All engines	version Hitachi						1.422.102						
All engines													1.501.399
ENGINE													
1.6 SLX	Petrol	66	09/95-07/00	GA16DE									
ENGINE													
Engine	Information			A10	A20	A40	A50	A70	C10 - C30	C20	E01		
All engines	->year 31/01/98, version Hitachi					1.322.089							
All engines	version Hitachi						1.422.102						
All engines													1.501.399
ENGINE													
1.6 SR, SLX	Petrol	66	09/95-03/00	GA16DE									
ENGINE													
Engine	Information			A10	A20	A40	A50	A70	C10 - C30	C20	E01		
All engines	->year 31/01/98, version Hitachi					1.322.089							
All engines	version Hitachi						1.422.102						
All engines													1.501.399
ENGINE													
1.8	Petrol	84	07/95-05/00	QG18DE									
ENGINE													
Engine	Information			A10	A20	A40	A50	A70	C10 - C30	C20	E01		
All engines	01/03/01 ->, Qty: 4								1.970.557	C10			
ENGINE													
2.0 GTi	Petrol	105	07/96-03/00	SR20DE									
ENGINE													
Engine	Information			A10	A20	A40	A50	A70	C10 - C30	C20	E01		
All engines	version Mitsubishi						1.431.136						
All engines	->year 30/11/99												1.501.411
ALMERA II													
ENGINE													
1.5	Petrol	66	03/00-11/06	QG15DE									
ENGINE													
Engine	Information			A10	A20	A40	A50	A70	C10 - C30	C20	E01		
All engines	Almera, 01/04/01 ->, N16E, x4, COIL ON PLUG								1.970.557	C10			
ENGINE													
1.5	Petrol	72	10/02-09/06	QG15DE									
ENGINE													
Engine	Information			A10	A20	A40	A50	A70	C10 - C30	C20	E01		
All engines	Almera, x4, COIL ON PLUG								1.970.557	C10			
ENGINE													
1.5	Petrol	77	03/01->	QG15DE									
ENGINE													
Engine	Information			A10	A20	A40	A50	A70	C10 - C30	C20	E01		
All engines	01/03/01 ->, Qty: 4								1.970.557	C10			
ENGINE													
1.5 XL	Petrol	77	03/01->	QG15DE									
ENGINE													
Engine	Information			A10	A20	A40	A50	A70	C10 - C30	C20	E01		
All engines	01/03/01 ->, Qty: 4								1.970.557	C10			
ENGINE													
1.8	Petrol	84	01/00-11/02	QG18DE									
ENGINE													
Engine	Information			A10	A20	A40	A50	A70	C10 - C30	C20	E01		
All engines	Almera, 01/04/01 ->, x4, COIL ON PLUG								1.970.557	C10			

A10 CONDENSER	A20 CONTACT SET	A40 DISTRIBUTOR CAP	A50 ROTOR	A70 PICK-UP
C10 COIL	C20 IGNITION MODULE	C30 ELECTRONIC IGNITION KIT	E01 IGNITION CABLE SET	

Vehicle	alim.	kW	Date	Engine	FUNCTIONS ON THE VEHICLE									
					A10	A20	A40	A50	A70	C10 - C30	C20	E01		
ENGINE														
1.8	Petrol	85	10/02-09/06	QG18DE										
Engine					A10	A20	A40	A50	A70	C10 - C30	C20	E01		
Information										1.970.557	C10			
All engines														
Almera, x 4, COIL ON PLUG														
ENGINE														
1.8	Petrol	94	01/02->	QG18DE										
Engine					A10	A20	A40	A50	A70	C10 - C30	C20	E01		
Information										1.970.557	C10			
All engines														
01/03/01 ->, Qty: 4														
ALMERA III														
ENGINE														
1.2 i	Petrol	58	09/11->	HR12DE										
Engine					A10	A20	A40	A50	A70	C10 - C30	C20	E01		
Information										1.970.552	C10			
All engines														
Qty: 3														
ENGINE														
1.5	Petrol	0	01/06->	QG15DE										
Engine					A10	A20	A40	A50	A70	C10 - C30	C20	E01		
Information										1.970.557	C10			
All engines														
Qty: 4														
ENGINE														
1.6	Petrol	79	01/06->	QG16										
Engine					A10	A20	A40	A50	A70	C10 - C30	C20	E01		
Information										1.970.557	C10			
All engines														
Qty: 4														
ENGINE														
1.6 16V	Petrol	79	03/06->	QG16, QG16DE										
Engine					A10	A20	A40	A50	A70	C10 - C30	C20	E01		
Information										1.970.557	C10			
Eng. QG16														
x 4, COIL ON PLUG														
Information										1.970.557	C10			
Eng. QG16DE														
Qty: 4														
ALMERA TINO														
ENGINE														
1.8	Petrol	84	08/00-02/06	QG18DE										
Engine					A10	A20	A40	A50	A70	C10 - C30	C20	E01		
Information										1.970.557	C10			
All engines														
01/12/00 ->, x 4, COIL ON PLUG														
ENGINE														
1.8	Petrol	85	12/02-02/06	QG18DE										
Engine					A10	A20	A40	A50	A70	C10 - C30	C20	E01		
Information										1.970.557	C10			
All engines														
x 4, COIL ON PLUG														
ENGINE														
1.8	Petrol	88	12/98-02/03	QG18DE										
Engine					A10	A20	A40	A50	A70	C10 - C30	C20	E01		
Information										1.970.557	C10			
All engines														
01/03/01 ->, Qty: 4														
ENGINE														
2.0	Petrol	100	08/00-01/03	SR20DE										
Engine					A10	A20	A40	A50	A70	C10 - C30	C20	E01		
Information								1.431.136						
All engines														
->year 30/11/00, version Mitsubishi													1.501.411	
ALTIMA														
ENGINE														
2.4	Petrol	112	06/93-09/01	KA24DE										
Engine					A10	A20	A40	A50	A70	C10 - C30	C20	E01		
Information										1.970.296	C10			
All engines														
BLUEBIRD														
ENGINE														
1.6	Petrol	61	03/86-06/90	CA16S										
Engine					A10	A20	A40	A50	A70	C10 - C30	C20	E01		
Information							1.322.063							
All engines														
version Hitachi														
ENGINE														
1.6	Petrol	66	12/85-02/90	CA16S										
Engine					A10	A20	A40	A50	A70	C10 - C30	C20	E01		
Information							1.322.063							
All engines														
version Hitachi														

A10	CONDENSER	A20	CONTACT SET	A40	DISTRIBUTOR CAP	A50	ROTOR	A70	PICK-UP
C10	COIL	C20	IGNITION MODULE	C30	ELECTRONIC IGNITION KIT	E01	IGNITION CABLE SET		

The present application list is a brief version. For the detailed information about the possibility of installation on a specific vehicle, please refer to our web-catalogue <http://catalogo.facet.eu/>

Vehicle	alim.	kW	Date	Engine	FUNCTIONS ON THE VEHICLE									
					A10	A20	A40	A50	A70	C10 - C30	C20	E01		
ENGINE														
1.6 DX	Petrol	61	11/83-02/88	CA16S										
Engine	Information				A10	A20	A40	A50	A70	C10 - C30	C20	E01		
All engines	version Hitachi						1.322.063							
ENGINE														
1.8 Turbo	Petrol	99	04/84-11/92	CA18T										
Engine	Information				A10	A20	A40	A50	A70	C10 - C30	C20	E01		
All engines	version Hitachi						1.322.046	1.422.070						
ENGINE														
2.0	Petrol	75	12/85-09/90	CA20S										
Engine	Information				A10	A20	A40	A50	A70	C10 - C30	C20	E01		
All engines	version Hitachi						1.322.063							
ENGINE														
2.0 i	Petrol	77	04/84-12/90	CA20E										
Engine	Information				A10	A20	A40	A50	A70	C10 - C30	C20	E01		
All engines	-catalytic converter, version Hitachi						1.322.046	1.422.070						
All engines	+catalytic converter, version Hitachi							1.422.066						
ENGINE														
2.0 i	Petrol	85	09/88-09/90	CA20E										
Engine	Information				A10	A20	A40	A50	A70	C10 - C30	C20	E01		
All engines	-catalytic converter, version Hitachi						1.322.046	1.422.070						
All engines	+catalytic converter, version Hitachi							1.422.066						
CABSTAR II														
2.0	Petrol	66	07/92-05/94	--, Z20S										
Engine	Information				A10	A20	A40	A50	A70	C10 - C30	C20	E01		
All engines	version Mitsubishi						1.331.136							
CUBE														
1.6 16V	Petrol	81	08/09->	HR16DE										
Engine	Information				A10	A20	A40	A50	A70	C10 - C30	C20	E01		
All engines	x 4, COIL ON PLUG									1.970.552	C10			
FRONTIER														
2.5 i	Petrol	0	11/14->	QR25DE										
Engine	Information				A10	A20	A40	A50	A70	C10 - C30	C20	E01		
All engines	pole nr. 4									1.970.552	C10			
JUKE I														
1.2 DIG-T	Petrol	85	05/14->	HR12DDT, HRA2DDT										
Engine	Information				A10	A20	A40	A50	A70	C10 - C30	C20	E01		
Eng. HR12DDT	Qty: 4									1.970.613	C10			
Eng. HRA2DDT	x 4, COIL ON PLUG									1.970.613	C10			
ENGINE														
1.5	Petrol	84	10/13->	HR15DE										
Engine	Information				A10	A20	A40	A50	A70	C10 - C30	C20	E01		
All engines	Qty: 4									1.970.552	C10			
ENGINE														
1.6	Petrol	140	03/13->	MR16DDT										
Engine	Information				A10	A20	A40	A50	A70	C10 - C30	C20	E01		
All engines	x 4, COIL ON PLUG									1.970.551	C10			
ENGINE														
1.6	Petrol	69	01/13->	HR16DE										
Engine	Information				A10	A20	A40	A50	A70	C10 - C30	C20	E01		
All engines	x 4, COIL ON PLUG									1.970.552	C10			
ENGINE														
1.6	Petrol	83	07/18->	HR16DE										
Engine	Information				A10	A20	A40	A50	A70	C10 - C30	C20	E01		
All engines	x 4, COIL ON PLUG									1.970.552	C10			

A10 CONDENSER	A20 CONTACT SET	A40 DISTRIBUTOR CAP	A50 ROTOR	A70 PICK-UP
C10 COIL	C20 IGNITION MODULE	C30 ELECTRONIC IGNITION KIT	E01 IGNITION CABLE SET	

Vehicle	alim.	kW	Date	Engine	FUNCTIONS ON THE VEHICLE								
					A10	A20	A40	A50	A70	C10 - C30	C20	E01	
ENGINE													
1.6	Petrol	86	06/10->	HR16DE									
ENGINE													
Engine		Information			A10	A20	A40	A50	A70	C10 - C30	C20	E01	
All engines		x 4, COIL ON PLUG								1.970.552	C10		
1.6 CVTC	Petrol	72	08/14->	HR16DE									
ENGINE													
Engine		Information			A10	A20	A40	A50	A70	C10 - C30	C20	E01	
All engines		x 4, COIL ON PLUG								1.970.552	C10		
1.6 DIG-T	Petrol	140	06/10->	MR16DDT									
ENGINE													
Engine		Information			A10	A20	A40	A50	A70	C10 - C30	C20	E01	
All engines		x 4, COIL ON PLUG								1.970.551	C10		
1.6 DIG-T 4x4	Petrol	140	06/10->	MR16DDT									
ENGINE													
Engine		Information			A10	A20	A40	A50	A70	C10 - C30	C20	E01	
All engines		x 4, COIL ON PLUG								1.970.551	C10		
1.6 DIG-T NISMO	Petrol	147	03/13-07/14	MR16DDT									
ENGINE													
Engine		Information			A10	A20	A40	A50	A70	C10 - C30	C20	E01	
All engines		x 4, COIL ON PLUG								1.970.551	C10		
1.6 DIG-T NISMO 4x4	Petrol	147	02/13-07/14	MR16DDT									
ENGINE													
Engine		Information			A10	A20	A40	A50	A70	C10 - C30	C20	E01	
All engines		x 4, COIL ON PLUG								1.970.551	C10		
1.6 DIG-T NISMO RS	Petrol	160	08/14->	MR16DDT									
ENGINE													
Engine		Information			A10	A20	A40	A50	A70	C10 - C30	C20	E01	
All engines		x 4, COIL ON PLUG								1.970.551	C10		
1.6 DIG-T NISMO RS 4x4	Petrol	157	08/14->	MR16DDT									
ENGINE													
Engine		Information			A10	A20	A40	A50	A70	C10 - C30	C20	E01	
All engines		x 4, COIL ON PLUG								1.970.551	C10		
1.6 LPG	Petrol/ Liquified Petroleum Gas (LPG)	80	09/18->	HR16DE									
ENGINE													
Engine		Information			A10	A20	A40	A50	A70	C10 - C30	C20	E01	
All engines		x 4, COIL ON PLUG								1.970.552	C10		
1.6 LPG	Petrol/ Liquified Petroleum Gas (LPG)	85	01/12->	HR16DE									
ENGINE													
Engine		Information			A10	A20	A40	A50	A70	C10 - C30	C20	E01	
All engines		x 4, COIL ON PLUG								1.970.552	C10		
CVTC	Petrol	86	03/13->	HR16DE									
ENGINE													
Engine		Information			A10	A20	A40	A50	A70	C10 - C30	C20	E01	
All engines		x 4, COIL ON PLUG								1.970.552	C10		
KUBISTAR													
1.2	Petrol	44	08/03->	D7F 726, D7F 744, D7F 764, D7F726									
ENGINE													
Engine		Information			A10	A20	A40	A50	A70	C10 - C30	C20	E01	
Eng. D7F 726, D7F 744, D7F 764										1.970.596	C10		1.499.230
Eng. D7F726		x 1, VALEO, D.I.S.								1.970.596	C10		
1.2 16V	Petrol	55	04/06->	D4F 712, D4F 730									
ENGINE													
Engine		Information			A10	A20	A40	A50	A70	C10 - C30	C20	E01	
Eng. D4F 712		x 4, COIL ON PLUG								1.970.419	C10		
A10	CONDENSER	A20	CONTACT SET	A40	DISTRIBUTOR CAP	A50	ROTOR	A70	PICK-UP				
C10	COIL	C20	IGNITION MODULE	C30	ELECTRONIC IGNITION KIT	E01	IGNITION CABLE SET						









				FUNCTIONS ON THE VEHICLE								
Vehicle	alim.	kW	Date	Engine								
				ENGINE								
1.2 16V	Petrol	55	04/06->	D4F 712, D4F 730								
Engine	Information			A10	A20	A40	A50	A70	C10 - C30		C20	E01
Eng. D4F 730	x 4, COIL ON PLUG								1.970.518	C10		
Eng. D4F 712												1.499.246
				ENGINE								
1.2 LPG	LPG	44	10/03-08/05	D7F 764								
Engine	Information			A10	A20	A40	A50	A70	C10 - C30		C20	E01
All engines	x 1, VALEO, D.I.S.								1.970.596	C10		
				ENGINE								
1.4	Petrol	55	08/03-10/09	K7J 700, K7J701								
Engine	Information			A10	A20	A40	A50	A70	C10 - C30		C20	E01
All engines	x 1, VALEO, D.I.S.								1.970.596	C10		
Eng. K7J 700												1.499.244
				ENGINE								
1.6 16V	Petrol	70	08/03->	K4M 750, K4M 752, K4M 753, K4M753								
Engine	Information			A10	A20	A40	A50	A70	C10 - C30		C20	E01
Eng. K4M 750, K4M 753	Qty: 4								1.970.432	C10		
Eng. K4M 752, K4M753	x 4, BERU, ELDOR, COIL ON PLUG								1.970.432	C10		
Eng. K4M 752, K4M753	x 1, VALEO, D.I.S.								1.970.596	C10		
				ENGINE								
2.0 GL	Petrol	75	11/84-12/85	CA20S								
Engine	Information			A10	A20	A40	A50	A70	C10 - C30		C20	E01
All engines	version Hitachi					1.322.057						
				ENGINE								
1.4 16V	Petrol	65	08/05->	CR14DE								
Engine	Information			A10	A20	A40	A50	A70	C10 - C30		C20	E01
All engines	x 4, COIL ON PLUG								1.970.602	C10		
				ENGINE								
1.6 160 SR	Petrol	81	08/05->	HR16DE								
Engine	Information			A10	A20	A40	A50	A70	C10 - C30		C20	E01
All engines	x 4, COIL ON PLUG								1.970.489	C10		
				ENGINE								
1.0 i 16V	Petrol	40	08/92-07/00	CG10DE								
Engine	Information			A10	A20	A40	A50	A70	C10 - C30		C20	E01
All engines	->year 28/02/00, version Lucas					1.328.104	1.428.030					
All engines	->year 31/07/00, 01/03/00 ->, version Hitachi						1.422.102					
All engines												1.500.608
				ENGINE								
1.3 i 16V	Petrol	55	08/92-09/00	CG13DE								
Engine	Information			A10	A20	A40	A50	A70	C10 - C30		C20	E01
All engines	->year 28/02/00, version Lucas					1.328.104, 1.328.105	1.428.030					
All engines	01/03/00 ->, version Hitachi						1.422.102					
All engines												1.500.608
				ENGINE								
1.0 16V	Petrol	48	01/03-06/10	CG10DE								
Engine	Information			A10	A20	A40	A50	A70	C10 - C30		C20	E01
All engines	x 4, COIL ON PLUG								1.970.602	C10		
				ENGINE								
1.2	Petrol	66	01/07-06/10	CR12DE								
Engine	Information			A10	A20	A40	A50	A70	C10 - C30		C20	E01
All engines	Qty: 4								1.970.602	C10		
				ENGINE								
1.2	Petrol	80	10/03-07/05	CR12DE								
Engine	Information			A10	A20	A40	A50	A70	C10 - C30		C20	E01
All engines	Qty: 4								1.970.602	C10		

A10 CONDENSER	A20 CONTACT SET	A40 DISTRIBUTOR CAP	A50 ROTOR	A70 PICK-UP
C10 COIL	C20 IGNITION MODULE	C30 ELECTRONIC IGNITION KIT	E01 IGNITION CABLE SET	

Vehicle	alim.	kW	Date	Engine	FUNCTIONS ON THE VEHICLE									
					A10	A20	A40	A50	A70	C10 - C30	C20	E01		
ENGINE														
1.2	Petrol	81	08/05-06/10	CR12DE										
ENGINE														
All engines					Information	A10	A20	A40	A50	A70	C10 - C30	C20	E01	
All engines					Qty: 4						1.970.602	C10		
ENGINE														
1.2 16V	Petrol	48	01/03-06/10	CG12DE, CR12DE										
ENGINE														
All engines					Information	A10	A20	A40	A50	A70	C10 - C30	C20	E01	
All engines					x 4, COIL ON PLUG						1.970.602	C10		
ENGINE														
1.2 16V	Petrol	59	01/03-06/10	CG12DE, CR12DE										
ENGINE														
All engines					Information	A10	A20	A40	A50	A70	C10 - C30	C20	E01	
All engines					x 4, COIL ON PLUG						1.970.602	C10		
ENGINE														
1.2 LPG	Petrol/ Liquified Petroleum Gas (LPG)	59	10/02-06/10	CG12DELPG, CR12DE										
ENGINE														
All engines					Information	A10	A20	A40	A50	A70	C10 - C30	C20	E01	
All engines					x 4, COIL ON PLUG						1.970.602	C10		
ENGINE														
1.3	Petrol	60	08/04->	CGA3DE										
ENGINE														
All engines					Information	A10	A20	A40	A50	A70	C10 - C30	C20	E01	
All engines					Qty: 4						1.970.602	C10		
ENGINE														
1.4 16V	Petrol	65	01/03-06/10	CR14DE										
ENGINE														
All engines					Information	A10	A20	A40	A50	A70	C10 - C30	C20	E01	
All engines					x 4, COIL ON PLUG						1.970.602	C10		
ENGINE														
160 SR	Petrol	81	05/05-06/10	HR16DE										
ENGINE														
All engines					Information	A10	A20	A40	A50	A70	C10 - C30	C20	E01	
All engines					x 4, COIL ON PLUG						1.970.489	C10		
MICRA IV														
ENGINE														
1.2	Petrol	56	05/10->	HR12DE										
ENGINE														
All engines					Information	A10	A20	A40	A50	A70	C10 - C30	C20	E01	
All engines					no specific info conc. application available, Qty: 3, no specific info conc. application available						1.970.552	C10		
All engines					x 3, COIL ON PLUG						1.970.552	C10		
ENGINE														
1.2	Petrol	58	05/10->	HR12DE										
ENGINE														
All engines					Information	A10	A20	A40	A50	A70	C10 - C30	C20	E01	
All engines					no specific info conc. application available, Qty: 3, no specific info conc. application available						1.970.552	C10		
ENGINE														
1.2	Petrol	59	05/10->	HR12DE										
ENGINE														
All engines					Information	A10	A20	A40	A50	A70	C10 - C30	C20	E01	
All engines					->year 01/11/13, 01/12/13 ->, K13K, x 3, EUR/C, COIL ON PLUG ----- K13KK, x 3, EUR/C, COIL ON PLUG						1.970.552	C10		
ENGINE														
1.2 4WD	Petrol	59	05/10->	HR12DE										
ENGINE														
All engines					Information	A10	A20	A40	A50	A70	C10 - C30	C20	E01	
All engines					no specific info conc. application available, Qty: 3, no specific info conc. application available						1.970.552	C10		
ENGINE														
1.2 LPG	Petrol/ Liquified Petroleum Gas (LPG)	59	05/10-09/15	HR12DE										
ENGINE														
All engines					Information	A10	A20	A40	A50	A70	C10 - C30	C20	E01	
All engines					x 3, GROUP C, COIL ON PLUG						1.970.552	C10		

A10 CONDENSER	A20 CONTACT SET	A40 DISTRIBUTOR CAP	A50 ROTOR	A70 PICK-UP
C10 COIL	C20 IGNITION MODULE	C30 ELECTRONIC IGNITION KIT	E01 IGNITION CABLE SET	

The present application list is a brief version. For the detailed information about the possibility of installation on a specific vehicle, please refer to our web-catalogue <http://catalogo.facet.eu/>

					FUNCTIONS ON THE VEHICLE							
Vehicle	alim.	kW	Date	Engine								
MICRA V												
0.9 IG-T	Petrol	66	12/16->	ENGINE HR09DET								
Engine		Information			A10	A20	A40	A50	A70	C10 - C30	C20	E01
All engines		x 3, COIL ON PLUG								1.970.613	C10	
0.9 LPG												
	Petrol/ Liquified Petro- leum Gas (LPG)	64	03/19->	ENGINE HR09DET								
Engine		Information			A10	A20	A40	A50	A70	C10 - C30	C20	E01
All engines		x 3, COIL ON PLUG								1.970.613	C10	
MURANO												
3.5 CVTc4x4	Petrol	188	03/13-09/14	ENGINE VQ35DE								
Engine		Information			A10	A20	A40	A50	A70	C10 - C30	C20	E01
All engines		x 6, COIL ON PLUG								1.970.533	C10	
MURANO II												
3.5	Petrol	191	01/11-09/14	ENGINE VQ35DE								
Engine		Information			A10	A20	A40	A50	A70	C10 - C30	C20	E01
All engines		Qty: 6								1.970.533	C10	
3.5	Petrol	195	11/07-09/14	ENGINE VQ35DE								
Engine		Information			A10	A20	A40	A50	A70	C10 - C30	C20	E01
All engines		Qty: 6								1.970.533	C10	
All engines		x 6, COIL ON PLUG								1.970.533	C10	
3.5 4x4	Petrol	183	12/10-09/14	ENGINE VQ35DE								
Engine		Information			A10	A20	A40	A50	A70	C10 - C30	C20	E01
All engines		x 6, COIL ON PLUG								1.970.533	C10	
3.5 4x4	Petrol	188	10/08-09/14	ENGINE VQ35DE								
Engine		Information			A10	A20	A40	A50	A70	C10 - C30	C20	E01
All engines		x 6, COIL ON PLUG								1.970.533	C10	
3.5 4x4	Petrol	191	12/09-09/14	ENGINE VQ35DE								
Engine		Information			A10	A20	A40	A50	A70	C10 - C30	C20	E01
All engines		x 6, COIL ON PLUG								1.970.533	C10	
3.5 4x4	Petrol	195	11/07-09/14	ENGINE VQ35DE								
Engine		Information			A10	A20	A40	A50	A70	C10 - C30	C20	E01
All engines		Qty: 6								1.970.533	C10	
All engines		x 6, COIL ON PLUG								1.970.533	C10	
3.5 4x4	Petrol	198	09/08-12/10	ENGINE VQ35DE								
Engine		Information			A10	A20	A40	A50	A70	C10 - C30	C20	E01
All engines		Qty: 6								1.970.533	C10	
MURANO III												
2.5 HEV ALL MODE 4x4-i	Petrol/ Electric	172	01/16->	ENGINE QR25DER								
Engine		Information			A10	A20	A40	A50	A70	C10 - C30	C20	E01
All engines		x 4, COIL ON PLUG								1.970.552	C10	
3.5 V6	Petrol	183	01/16->	ENGINE VQ35DE								
Engine		Information			A10	A20	A40	A50	A70	C10 - C30	C20	E01
All engines		x 6, COIL ON PLUG								1.970.533	C10	

A10 CONDENSER	A20 CONTACT SET	A40 DISTRIBUTOR CAP	A50 ROTOR	A70 PICK-UP
C10 COIL	C20 IGNITION MODULE	C30 ELECTRONIC IGNITION KIT	E01 IGNITION CABLE SET	

Vehicle	alim.	kW	Date	Engine	FUNCTIONS ON THE VEHICLE								
					A10	A20	A40	A50	A70	C10 - C30	C20	E01	
ENGINE													
3.5 V6 ALL MODE 4x4-i	Petrol	183	01/16->	VQ35DE									
Engine	Information				A10	A20	A40	A50	A70	C10 - C30	C20	E01	
All engines	x 6, COIL ON PLUG									1.970.533	C10		
ENGINE													
3.5 V6 ALL MODE 4x4-i	Petrol	188	10/14->	VQ35DE									
Engine	Information				A10	A20	A40	A50	A70	C10 - C30	C20	E01	
All engines	Qty: 6									1.970.533	C10		
ENGINE													
3.5 V6 ALL MODE 4x4-i	Petrol	191	01/16->	VQ35DE									
Engine	Information				A10	A20	A40	A50	A70	C10 - C30	C20	E01	
All engines	Qty: 6									1.970.533	C10		
NAVARA I													
2.4	Petrol	91	06/92-02/97	Z24i									
Engine	Information				A10	A20	A40	A50	A70	C10 - C30	C20	E01	
All engines	version Mitsubishi						1.331.114	1.431.030					
NAVARA III													
2.5	Petrol	122	01/15->	QR25DE									
Engine	Information				A10	A20	A40	A50	A70	C10 - C30	C20	E01	
All engines	Qty: 4									1.970.552	C10		
ENGINE													
2.5	Petrol	124	07/14->	QR25DE									
Engine	Information				A10	A20	A40	A50	A70	C10 - C30	C20	E01	
All engines	Qty: 4									1.970.552	C10		
ENGINE													
2.5 DDTi	Diesel	120	01/15->	YD25DDTi									
Engine	Information				A10	A20	A40	A50	A70	C10 - C30	C20	E01	
All engines	Qty: 4									1.970.552	C10		
NOTE I													
1.4	Petrol	65	03/06-06/12	CR14DE									
Engine	Information				A10	A20	A40	A50	A70	C10 - C30	C20	E01	
All engines	x 4, COIL ON PLUG									1.970.602	C10		
ENGINE													
1.4 LPG	Petrol/ Liquified Petro- leum Gas (LPG)	65	01/06-08/13	CR14DE									
Engine	Information				A10	A20	A40	A50	A70	C10 - C30	C20	E01	
All engines	x 4, COIL ON PLUG									1.970.602	C10		
ENGINE													
1.6	Petrol	81	03/06-06/12	HR16DE									
Engine	Information				A10	A20	A40	A50	A70	C10 - C30	C20	E01	
All engines	x 4, COIL ON PLUG									1.970.489	C10		
NOTE II													
1.2	Petrol	58	06/13->	HR12DE									
Engine	Information				A10	A20	A40	A50	A70	C10 - C30	C20	E01	
All engines	Qty: 3									1.970.552	C10		
ENGINE													
1.2	Petrol	59	06/13->	HR12DE									
Engine	Information				A10	A20	A40	A50	A70	C10 - C30	C20	E01	
All engines	x 3, COIL ON PLUG									1.970.552	C10		
ENGINE													
1.2 4WD	Petrol	59	06/13->	HR12DE									
Engine	Information				A10	A20	A40	A50	A70	C10 - C30	C20	E01	
All engines	Qty: 3									1.970.552	C10		

A10 CONDENSER	A20 CONTACT SET	A40 DISTRIBUTOR CAP	A50 ROTOR	A70 PICK-UP
C10 COIL	C20 IGNITION MODULE	C30 ELECTRONIC IGNITION KIT	E01 IGNITION CABLE SET	

The present application list is a brief version. For the detailed information about the possibility of installation on a specific vehicle, please refer to our web-catalogue <http://catalogo.facet.eu/>

					FUNCTIONS ON THE VEHICLE							
Vehicle	alim.	kW	Date	Engine								
ENGINE												
1.2 LPG	LPG	56	03/15->	HR12DE								
Engine		Information			A10	A20	A40	A50	A70	C10 - C30	C20	E01
All engines		x 3, COIL ON PLUG								1.970.552	C10	
NP300												
2.5i	Petrol	0	06/14->	QR25DE								
Engine		Information			A10	A20	A40	A50	A70	C10 - C30	C20	E01
All engines		Qty: 4								1.970.552	C10	
NV200 / EVALIA												
2.0	Petrol	101	07/10->	MR20DE								
Engine		Information			A10	A20	A40	A50	A70	C10 - C30	C20	E01
All engines		->year 15/12/13, Qty: 4								1.970.552	C10	
NX1600												
1.6 [USA]	Petrol	0	01/87-12/90	E16								
Engine		Information			A10	A20	A40	A50	A70	C10 - C30	C20	E01
All engines		version Mitsubishi					1.331.114	1.431.110				
1.6i [USA]	Petrol	0	01/88-12/92	GA16, GA16DE								
Engine		Information			A10	A20	A40	A50	A70	C10 - C30	C20	E01
All engines		version Hitachi					1.322.046	1.422.070				
PATHFINDER IV												
2.5 Hybrid	Petrol/ Electric	188	10/13->	QR25DER								
Engine		Information			A10	A20	A40	A50	A70	C10 - C30	C20	E01
All engines		Qty: 4								1.970.552	C10	
2.5 Hybrid 4WD	Petrol/ Electric	172	11/14->	QR25DER								
Engine		Information			A10	A20	A40	A50	A70	C10 - C30	C20	E01
All engines		x 4, COIL ON PLUG								1.970.552	C10	
2.5 Hybrid 4WD	Petrol/ Electric	188	10/13->	QR25DER								
Engine		Information			A10	A20	A40	A50	A70	C10 - C30	C20	E01
All engines		Qty: 4								1.970.552	C10	
All engines		x 4, COIL ON PLUG								1.970.552	C10	
3.5 4WD	Petrol	183	08/14->	VQ35DE								
Engine		Information			A10	A20	A40	A50	A70	C10 - C30	C20	E01
All engines		x 6, COIL ON PLUG								1.970.533	C10	
3.5 4WD	Petrol	194	09/12->	VQ35DE								
Engine		Information			A10	A20	A40	A50	A70	C10 - C30	C20	E01
All engines		Qty: 6								1.970.533	C10	
PATROL GR I												
4.2 Cat	Petrol	121	11/88-02/98	TB42E								
Engine		Information			A10	A20	A40	A50	A70	C10 - C30	C20	E01
All engines		version Mitsubishi					1.331.126					
PATROL III												
2.8	Petrol	88	07/80-08/88	L28								
Engine		Information			A10	A20	A40	A50	A70	C10 - C30	C20	E01
All engines		version Hitachi				1.222.056HV						
2.8	Petrol	89	07/80-08/88	L28								
Engine		Information			A10	A20	A40	A50	A70	C10 - C30	C20	E01
All engines		version Hitachi				1.222.056HV						

A10 CONDENSER	A20 CONTACT SET	A40 DISTRIBUTOR CAP	A50 ROTOR	A70 PICK-UP
C10 COIL	C20 IGNITION MODULE	C30 ELECTRONIC IGNITION KIT	E01 IGNITION CABLE SET	

Vehicle	alim.	kW	Date	Engine	FUNCTIONS ON THE VEHICLE							
					A10	A20	A40	A50	A70	C10 - C30	C20	E01

PICK UP I

2.4 [USA]	Petrol	0	01/85-12/89	ENGINE Z24i
-----------	--------	---	-------------	----------------

Engine	Information	A10	A20	A40	A50	A70	C10 - C30	C20	E01
All engines	version Hitachi			1.322.040	1.422.066				

2.4 i [USA]	Petrol	0	01/89->	ENGINE KA24E
-------------	--------	---	---------	-----------------

Engine	Information	A10	A20	A40	A50	A70	C10 - C30	C20	E01
All engines	version Hitachi			1.322.046	1.422.070				
All engines	version Mitsubishi			1.331.114	1.431.110				

2.4 i 12V	Petrol	91	04/92-02/98	ENGINE KA24E
-----------	--------	----	-------------	-----------------

Engine	Information	A10	A20	A40	A50	A70	C10 - C30	C20	E01
All engines	version HITACHI, ->year 01/10/95			1.322.046	1.422.070				
All engines	version HITACHI, 01/10/95 ->			1.322.089					
All engines	version MITSUBISHI, ->year 01/10/95			1.331.114	1.431.110				

2.4 i 12V 4WD	Petrol	93	04/92-02/98	ENGINE KA24E
---------------	--------	----	-------------	-----------------

Engine	Information	A10	A20	A40	A50	A70	C10 - C30	C20	E01
All engines	version HITACHI, ->year 01/10/95			1.322.046	1.422.070				
All engines	version HITACHI, 01/10/95 ->			1.322.089					
All engines	version MITSUBISHI, ->year 01/10/95			1.331.114	1.431.110				

PICK UP II

2.4 i	Petrol	88	02/98-04/05	ENGINE KA24E
-------	--------	----	-------------	-----------------

Engine	Information	A10	A20	A40	A50	A70	C10 - C30	C20	E01
All engines	version Hitachi			1.322.089					
All engines									1.501.789

2.4 i 4WD	Petrol	88	02/98-04/05	ENGINE KA24E
-----------	--------	----	-------------	-----------------

Engine	Information	A10	A20	A40	A50	A70	C10 - C30	C20	E01
All engines	version Hitachi			1.322.089					
All engines									1.501.789

PRAIRIE PRO

2.4 i	Petrol	98	01/90-07/94	ENGINE KA24E
-------	--------	----	-------------	-----------------

Engine	Information	A10	A20	A40	A50	A70	C10 - C30	C20	E01
All engines	version Hitachi				1.422.085				

2.4 i 4x4	Petrol	98	04/92-07/94	ENGINE KA24E
-----------	--------	----	-------------	-----------------

Engine	Information	A10	A20	A40	A50	A70	C10 - C30	C20	E01
All engines	version Hitachi				1.422.085				

PRIMASTAR

2.0	Petrol	86	04/06->	ENGINE F4R 820
-----	--------	----	---------	-------------------

Engine	Information	A10	A20	A40	A50	A70	C10 - C30	C20	E01
All engines	x 4, BERU, COIL ON PLUG						1.970.432	C10	

2.0	Petrol	88	03/01->	ENGINE F4R 720, F4R 722, F4R726
-----	--------	----	---------	---------------------------------------

Engine	Information	A10	A20	A40	A50	A70	C10 - C30	C20	E01
All engines	x 4, BERU, COIL ON PLUG						1.970.432	C10	

PRIMERA

1.6 LPG	LPG	73	09/96-07/02	ENGINE QG16DE
---------	-----	----	-------------	------------------

Engine	Information	A10	A20	A40	A50	A70	C10 - C30	C20	E01
All engines	x 4, COIL ON PLUG						1.970.557	C10	

1.8 LPG	LPG	84	08/99-07/02	ENGINE QG18DE
---------	-----	----	-------------	------------------

Engine	Information	A10	A20	A40	A50	A70	C10 - C30	C20	E01
All engines	01/10/00 ->, x 4, COIL ON PLUG						1.970.557	C10	

A10 CONDENSER	A20 CONTACT SET	A40 DISTRIBUTOR CAP	A50 ROTOR	A70 PICK-UP
C10 COIL	C20 IGNITION MODULE	C30 ELECTRONIC IGNITION KIT	E01 IGNITION CABLE SET	

Vehicle	alim.	kW	Date	Engine	FUNCTIONS ON THE VEHICLE							
					A10	A20	A40	A50	A70	C10 - C30	C20	E01

PRIMERA I

				ENGINE
1.6	Petrol	66	06/90-01/96	GA16DS

Engine	Information	A10	A20	A40	A50	A70	C10 - C30	C20	E01
All engines	-catalytic converter, version Lucas			1.328.101					
All engines	+catalytic converter, version Lucas			1.328.103					
All engines	+catalytic converter, version Hitachi				1.422.070				
All engines	-catalytic converter, version Hitachi				1.422.086				
All engines	->year 31/03/91								1.500.609

				ENGINE
1.6	Petrol	71	06/90-01/96	GA16DS

Engine	Information	A10	A20	A40	A50	A70	C10 - C30	C20	E01
All engines	-catalytic converter, version Lucas			1.328.101					
All engines	+catalytic converter, version Lucas			1.328.103					
All engines	+catalytic converter, version Hitachi				1.422.070				
All engines	-catalytic converter, version Hitachi				1.422.086				
All engines	->year 31/03/91								1.500.609

				ENGINE
1.6	Petrol	75	06/93-01/96	GA16DE

Engine	Information	A10	A20	A40	A50	A70	C10 - C30	C20	E01
All engines	version Lucas			1.328.105					
All engines	->year 30/09/94								1.501.658

				ENGINE
1.6 i	Petrol	66	07/90-03/98	GA16DS

Engine	Information	A10	A20	A40	A50	A70	C10 - C30	C20	E01
All engines	version Hitachi			1.322.046	1.422.070				
All engines	FOR: (F), FOR: (B), FOR: (I), FOR: (E), FOR: (P), FOR: (GR), version Lucas			1.328.101					
All engines	FOR: (F), FOR: (B), FOR: (I), FOR: (E), FOR: (P), FOR: (GR), version Hitachi				1.422.086				

				ENGINE
1.6 i	Petrol	75	02/91-03/98	GA16DE

Engine	Information	A10	A20	A40	A50	A70	C10 - C30	C20	E01
All engines	->year 30/04/96, version Hitachi			1.322.079					
All engines	01/05/96 ->, version Hitachi			1.322.089					
All engines									1.501.399

				ENGINE
2.0	Petrol	105	06/90-04/93	SR20DE

Engine	Information	A10	A20	A40	A50	A70	C10 - C30	C20	E01
All engines	version Lucas			1.328.102					
All engines	version Hitachi				1.422.085				

				ENGINE
2.0	Petrol	110	07/94-01/98	SR20DE

Engine	Information	A10	A20	A40	A50	A70	C10 - C30	C20	E01
All engines	->year 30/04/96, version Mitsubishi			1.331.151					
All engines	01/04/96 ->, version Mitsubishi				1.431.136				
All engines	01/04/96 ->								1.501.411

				ENGINE
2.0 16V	Petrol	85	06/90-01/96	SR20DI

Engine	Information	A10	A20	A40	A50	A70	C10 - C30	C20	E01
All engines	version Lucas			1.328.102					
All engines	version Hitachi				1.422.085				

				ENGINE
2.0 16V 4x4	Petrol	85	04/91-06/96	SR20DI

Engine	Information	A10	A20	A40	A50	A70	C10 - C30	C20	E01
All engines	version Lucas			1.328.102					
All engines	version Hitachi				1.422.085				

				ENGINE
2.0 GT	Petrol	110	06/90-01/96	SR20DE

Engine	Information	A10	A20	A40	A50	A70	C10 - C30	C20	E01
All engines	version Lucas			1.328.102					
All engines	version Hitachi				1.422.085				

A10 CONDENSER	A20 CONTACT SET	A40 DISTRIBUTOR CAP	A50 ROTOR	A70 PICK-UP
C10 COIL	C20 IGNITION MODULE	C30 ELECTRONIC IGNITION KIT	E01 IGNITION CABLE SET	

Vehicle	alim.	kW	Date	Engine	FUNCTIONS ON THE VEHICLE							
					A10	A20	A40	A50	A70	C10 - C30	C20	E01

ENGINE				
2.0 GT 4x4	Petrol	105	03/91-04/93	SR20DE

Engine	Information	A10	A20	A40	A50	A70	C10 - C30	C20	E01
All engines	version Lucas			1.328.102					
All engines	version Hitachi				1.422.085				

ENGINE				
2.0 i	Petrol	85	07/90-03/98	SR20DI

Engine	Information	A10	A20	A40	A50	A70	C10 - C30	C20	E01
All engines	version Hitachi			1.322.073	1.422.085				

ENGINE				
2.0 i	Petrol	92	01/95-06/96	SR20DE

Engine	Information	A10	A20	A40	A50	A70	C10 - C30	C20	E01
All engines	version Lucas			1.328.102					
All engines	version Hitachi				1.422.085				

PRIMERA II

ENGINE				
1.6 16V	Petrol	66	09/96-07/02	GA16DE

Engine	Information	A10	A20	A40	A50	A70	C10 - C30	C20	E01
All engines	version Lucas			1.328.105	1.428.030				
All engines									1.501.658

ENGINE				
1.6 16V	Petrol	73	09/96-07/02	GA16DE, QG16DE

Engine	Information	A10	A20	A40	A50	A70	C10 - C30	C20	E01
Eng. GA16DE	version Lucas			1.328.105	1.428.030				
Eng. QG16DE	x 4, COIL ON PLUG						1.970.557	C10	
Eng. GA16DE									1.501.658

ENGINE				
1.6 16V	Petrol	78	06/96-07/02	QG16DE

Engine	Information	A10	A20	A40	A50	A70	C10 - C30	C20	E01
All engines	x 4, COIL ON PLUG						1.970.557	C10	

ENGINE				
1.6 16V	Petrol	81	04/98-01/02	GA16DE

Engine	Information	A10	A20	A40	A50	A70	C10 - C30	C20	E01
All engines	version Lucas			1.328.105	1.428.030				
All engines									1.501.658

ENGINE				
1.6 16V LPG	Petrol/ Liquified Petro- leum Gas (LPG)	78	09/00-07/02	QG16DE

Engine	Information	A10	A20	A40	A50	A70	C10 - C30	C20	E01
All engines	x 4, COIL ON PLUG						1.970.557	C10	

ENGINE				
1.8 16V	Petrol	84	08/99-07/02	QG18DE

Engine	Information	A10	A20	A40	A50	A70	C10 - C30	C20	E01
All engines	01/10/00 ->, x 4, COIL ON PLUG						1.970.557	C10	

ENGINE				
1.8 16V LPG	Petrol/ Liquified Petro- leum Gas (LPG)	84	08/99-12/01	QG18DE

Engine	Information	A10	A20	A40	A50	A70	C10 - C30	C20	E01
All engines	01/10/00 ->, x 4, COIL ON PLUG						1.970.557	C10	

ENGINE				
2.0 16V	Petrol	103	08/99-07/02	SR20DE

Engine	Information	A10	A20	A40	A50	A70	C10 - C30	C20	E01
All engines	version Lucas			1.328.102					
All engines	version Hitachi				1.422.085				
All engines	->year 30/09/00, version Mitsubishi				1.431.136				
All engines									1.501.411

A10 CONDENSER	A20 CONTACT SET	A40 DISTRIBUTOR CAP	A50 ROTOR	A70 PICK-UP
C10 COIL	C20 IGNITION MODULE	C30 ELECTRONIC IGNITION KIT	E01 IGNITION CABLE SET	

The present application list is a brief version. For the detailed information about the possibility of installation on a specific vehicle, please refer to our web-catalogue <http://catalogo.facet.eu/>

Vehicle	alim.	kW	Date	Engine	FUNCTIONS ON THE VEHICLE							
					A10	A20	A40	A50	A70	C10 - C30	C20	E01

ENGINE				
2.0 16V	Petrol	110	09/96-07/02	SR20DE

Engine	Information	A10	A20	A40	A50	A70	C10 - C30	C20	E01
All engines	->year 30/09/00, version Mitsubishi				1.431.136				
All engines									1.501.411

ENGINE				
2.0 16V	Petrol	85	06/96-07/02	SR20De

Engine	Information	A10	A20	A40	A50	A70	C10 - C30	C20	E01
All engines	->year 30/09/00, version Mitsubishi				1.431.136				
All engines									1.501.411

ENGINE				
2.0 16V	Petrol	96	09/96-07/02	SR20DE

Engine	Information	A10	A20	A40	A50	A70	C10 - C30	C20	E01
All engines	->year 30/09/00, version Mitsubishi				1.431.136				
All engines									1.501.411

PRIMERA III

ENGINE				
1.6	Petrol	78	03/02-08/08	QG16DE

Engine	Information	A10	A20	A40	A50	A70	C10 - C30	C20	E01
All engines	x 4, COIL ON PLUG						1.970.557	C10	

ENGINE				
1.6	Petrol	80	01/02-04/06	QG16DE

Engine	Information	A10	A20	A40	A50	A70	C10 - C30	C20	E01
All engines	x 4, COIL ON PLUG						1.970.557	C10	

ENGINE				
1.6 Visia	Petrol	80	01/02-04/06	QG16DE

Engine	Information	A10	A20	A40	A50	A70	C10 - C30	C20	E01
All engines	x 4, COIL ON PLUG						1.970.557	C10	

ENGINE				
1.8	Petrol	85	03/02-10/08	QG18DE

Engine	Information	A10	A20	A40	A50	A70	C10 - C30	C20	E01
All engines	x 4, COIL ON PLUG						1.970.557	C10	

ENGINE				
1.8 LPG	Petrol/ Liquified Petro- leum Gas (LPG)	85	03/02->	QG18DE

Engine	Information	A10	A20	A40	A50	A70	C10 - C30	C20	E01
All engines	x 4, COIL ON PLUG						1.970.557	C10	

PULSAR

ENGINE				
1.2 DIG-T	Petrol	85	10/14->	HRA2DDT

Engine	Information	A10	A20	A40	A50	A70	C10 - C30	C20	E01
All engines	Pulsar, x 4, COIL ON PLUG						1.970.613	C10	

ENGINE				
1.6	Petrol	0	01/84-12/86	E16

Engine	Information	A10	A20	A40	A50	A70	C10 - C30	C20	E01
All engines	version Hitachi			1.322.057	1.422.052				

ENGINE				
1.6 [USA]	Petrol	0	01/82-12/83	E16

Engine	Information	A10	A20	A40	A50	A70	C10 - C30	C20	E01
All engines	version Hitachi			1.322.057	1.422.052				

ENGINE				
1.6 DIG-T	Petrol	140	02/15->	MR16DDT

Engine	Information	A10	A20	A40	A50	A70	C10 - C30	C20	E01
All engines	Pulsar, x 4, COIL ON PLUG						1.970.551	C10	

PULSAR NX

ENGINE				
1.6 [USA]	Petrol	0	01/86->	E16

Engine	Information	A10	A20	A40	A50	A70	C10 - C30	C20	E01
All engines	version Mitsubishi			1.331.114	1.431.110				

A10 CONDENSER	A20 CONTACT SET	A40 DISTRIBUTOR CAP	A50 ROTOR	A70 PICK-UP
C10 COIL	C20 IGNITION MODULE	C30 ELECTRONIC IGNITION KIT	E01 IGNITION CABLE SET	

Vehicle	alim.	kW	Date	Engine	FUNCTIONS ON THE VEHICLE							
					A10	A20	A40	A50	A70	C10 - C30	C20	E01
QASHQAI / QASHQAI +2												
1.6 CVTC	Petrol	86	03/13-04/14	HR16DE								
ENGINE												
Engine	Information				A10	A20	A40	A50	A70	C10 - C30	C20	E01
All engines	x 4, COIL ON PLUG									1.970.489	C10	
2.0	Petrol	104	03/13-04/14	MR20DE								
ENGINE												
Engine	Information				A10	A20	A40	A50	A70	C10 - C30	C20	E01
All engines	x 4, COIL ON PLUG									1.970.552	C10	
2.0 Trazione integrale	Petrol	104	03/13-04/14	MR20DE								
ENGINE												
Engine	Information				A10	A20	A40	A50	A70	C10 - C30	C20	E01
All engines	x 4, COIL ON PLUG									1.970.552	C10	
QASHQAI I												
1.6	Petrol	84	02/07-12/13	HR16DE								
ENGINE												
Engine	Information				A10	A20	A40	A50	A70	C10 - C30	C20	E01
All engines	x 4, COIL ON PLUG									1.970.489	C10	
1.6	Petrol	86	11/10-12/13	HR16DE								
ENGINE												
Engine	Information				A10	A20	A40	A50	A70	C10 - C30	C20	E01
All engines	x 4, COIL ON PLUG									1.970.489	C10	
1.6 LPG	Petrol/ Liquified Petroleum Gas (LPG)	86	11/10-12/13	HR16DE								
ENGINE												
Engine	Information				A10	A20	A40	A50	A70	C10 - C30	C20	E01
All engines	x 4, -start-stop function, COIL ON PLUG									1.970.489	C10	
All engines	x 4, +start-stop function, COIL ON PLUG									1.970.552	C10	
2.0	Petrol	102	02/07-12/13	MR20DE								
ENGINE												
Engine	Information				A10	A20	A40	A50	A70	C10 - C30	C20	E01
All engines	Qty: 4									1.970.552	C10	
2.0	Petrol	103	01/10-04/14	MR20DE								
ENGINE												
Engine	Information				A10	A20	A40	A50	A70	C10 - C30	C20	E01
All engines	x 4, COIL ON PLUG									1.970.552	C10	
2.0	Petrol	104	02/07-12/13	MR20DE								
ENGINE												
Engine	Information				A10	A20	A40	A50	A70	C10 - C30	C20	E01
All engines	->year 01/03/07, x 4, COIL ON PLUG									1.970.489	C10	
All engines	01/04/07 ->, x 4, COIL ON PLUG ----- x 4, COIL ON PLUG									1.970.552	C10	
2.0 Trazione integrale	Petrol	102	02/07-12/13	MR20DE								
ENGINE												
Engine	Information				A10	A20	A40	A50	A70	C10 - C30	C20	E01
All engines	Qty: 4									1.970.552	C10	
2.0 Trazione integrale	Petrol	103	01/10-04/14	MR20DE								
ENGINE												
Engine	Information				A10	A20	A40	A50	A70	C10 - C30	C20	E01
All engines	x 4, COIL ON PLUG									1.970.552	C10	
2.0 Trazione integrale	Petrol	104	02/07-12/13	MR20DE								
ENGINE												
Engine	Information				A10	A20	A40	A50	A70	C10 - C30	C20	E01
All engines	->year 01/03/07, x 4, COIL ON PLUG									1.970.489	C10	
All engines	01/04/07 ->, x 4, COIL ON PLUG ----- x 4, COIL ON PLUG									1.970.552	C10	

A10 CONDENSER	A20 CONTACT SET	A40 DISTRIBUTOR CAP	A50 ROTOR	A70 PICK-UP
C10 COIL	C20 IGNITION MODULE	C30 ELECTRONIC IGNITION KIT	E01 IGNITION CABLE SET	

The present application list is a brief version. For the detailed information about the possibility of installation on a specific vehicle, please refer to our web-catalogue <http://catalogo.facet.eu/>





					FUNCTIONS ON THE VEHICLE							
Vehicle	alim.	kW	Date	Engine	A10	A20	A40	A50	A70	C10 - C30	C20	E01
QASHQAI II												
1.2 DIG-T	Petrol	85	11/13->	ENGINE HR12DDT, HRA2DDT								
Engine	Information				A10	A20	A40	A50	A70	C10 - C30	C20	E01
Eng. HR12DDT	Qty: 4									1.970.613	C10	
Eng. HRA2DDT	x 4, COIL ON PLUG									1.970.613	C10	
1.6 DIG-T	Petrol	120	10/14->	ENGINE MR16DDT								
Engine	Information				A10	A20	A40	A50	A70	C10 - C30	C20	E01
All engines	x 4, COIL ON PLUG									1.970.551	C10	
2.0	Petrol	106	06/14->	ENGINE MR20DD								
Engine	Information				A10	A20	A40	A50	A70	C10 - C30	C20	E01
All engines	x 4, COIL ON PLUG									1.970.551	C10	
2.0 ALL MODE 4x4-i	Petrol	106	10/15->	ENGINE MR20DD								
Engine	Information				A10	A20	A40	A50	A70	C10 - C30	C20	E01
All engines	x 4, COIL ON PLUG									1.970.551	C10	
SENTRA III												
1.6i [USA]	Petrol	0	01/90-12/92	ENGINE GA16DE								
Engine	Information				A10	A20	A40	A50	A70	C10 - C30	C20	E01
All engines	version Hitachi						1.322.046	1.422.070				
2.0i [USA]	Petrol	0	01/90->	ENGINE SR20DE								
Engine	Information				A10	A20	A40	A50	A70	C10 - C30	C20	E01
All engines	version Hitachi						1.322.073	1.422.085				
SENTRA IV												
1.6i	Petrol	79	01/95-12/97	ENGINE GA16DE								
Engine	Information				A10	A20	A40	A50	A70	C10 - C30	C20	E01
All engines	version Hitachi						1.322.089					
SENTRA VII												
1.6 DIG-T	Petrol	0	07/12->	ENGINE MR16DDT								
Engine	Information				A10	A20	A40	A50	A70	C10 - C30	C20	E01
All engines	Qty: 4									1.970.551	C10	
1.8	Petrol	96	08/12->	ENGINE MRA8DE								
Engine	Information				A10	A20	A40	A50	A70	C10 - C30	C20	E01
All engines	Qty: 4									1.970.552	C10	
1.8 [TWN]	Petrol	0	08/13->	ENGINE MRA8DE								
Engine	Information				A10	A20	A40	A50	A70	C10 - C30	C20	E01
All engines	Qty: 4									1.970.552	C10	
1.8 i	Petrol	0	07/12->	ENGINE MRA8DE								
Engine	Information				A10	A20	A40	A50	A70	C10 - C30	C20	E01
All engines	B17T, B17Z, Qty: 4									1.970.552	C10	
SERENA												
1.6	Petrol	71	02/93-09/01	ENGINE GA16DE								
Engine	Information				A10	A20	A40	A50	A70	C10 - C30	C20	E01
All engines	version Mitsubishi							1.431.118				
1.6	Petrol	75	09/94-08/00	ENGINE GA16DE								
Engine	Information				A10	A20	A40	A50	A70	C10 - C30	C20	E01
All engines	version Mitsubishi							1.431.118				

A10 CONDENSER	A20 CONTACT SET	A40 DISTRIBUTOR CAP	A50 ROTOR	A70 PICK-UP
C10 COIL	C20 IGNITION MODULE	C30 ELECTRONIC IGNITION KIT	E01 IGNITION CABLE SET	

Vehicle	alim.	kW	Date	Engine	FUNCTIONS ON THE VEHICLE									
					A10	A20	A40	A50	A70	C10 - C30	C20	E01		
ENGINE														
2.0	Petrol	93	11/92-09/01	SR20DE										
Engine	Information				A10	A20	A40	A50	A70	C10 - C30	C20	E01		
All engines	version Mitsubishi							1.431.118						
STANZA														
ENGINE														
2.4i [USA]	Petrol	0	01/92->	KA24DE										
Engine	Information				A10	A20	A40	A50	A70	C10 - C30	C20	E01		
All engines										1.970.296	C10			
SUNNY II														
ENGINE														
1.0L	Petrol	37	07/86-09/90	E10S										
Engine	Information				A10	A20	A40	A50	A70	C10 - C30	C20	E01		
All engines	01/01/89 ->, version Hitachi						1.322.046							
All engines	->year 31/12/88, version Hitachi						1.322.057							
All engines	01/12/86 ->, version Hitachi							1.422.086						
ENGINE														
1.3	Petrol	44	06/86-10/91	E13S										
Engine	Information				A10	A20	A40	A50	A70	C10 - C30	C20	E01		
All engines	version Hitachi						1.322.057							
All engines	01/12/86 ->, version Hitachi							1.422.086						
ENGINE														
1.4 LX	Petrol	55	10/88-08/91	GA14S										
Engine	Information				A10	A20	A40	A50	A70	C10 - C30	C20	E01		
All engines	version Lucas						1.328.101							
All engines	version Mitsubishi						1.331.136	1.431.030						
All engines	version Hitachi							1.422.086						
ENGINE														
1.5	Petrol	52	06/86-10/88	E15S										
Engine	Information				A10	A20	A40	A50	A70	C10 - C30	C20	E01		
All engines	version Hitachi						1.322.057							
All engines	01/12/86 ->, version Hitachi							1.422.086						
ENGINE														
1.6	Petrol	62	06/86-10/88	E16S										
Engine	Information				A10	A20	A40	A50	A70	C10 - C30	C20	E01		
All engines	version Hitachi						1.322.057							
All engines	01/12/86 ->, version Hitachi							1.422.086						
ENGINE														
1.6i	Petrol	54	06/86-10/90	E16i										
Engine	Information				A10	A20	A40	A50	A70	C10 - C30	C20	E01		
All engines	01/09/88 ->, version Mitsubishi						1.331.114							
All engines	version Mitsubishi							1.431.110						
ENGINE														
1.6i 12V	Petrol	66	06/86-06/91	GA16i										
Engine	Information				A10	A20	A40	A50	A70	C10 - C30	C20	E01		
All engines	version Hitachi						1.322.046	1.422.070						
All engines	version Mitsubishi						1.331.114	1.431.110						
ENGINE														
1.6i 4x4	Petrol	54	06/86-10/90	E16i										
Engine	Information				A10	A20	A40	A50	A70	C10 - C30	C20	E01		
All engines	01/09/88 ->, version Mitsubishi						1.331.114							
All engines	version Mitsubishi							1.431.110						
SUNNY III														
ENGINE														
1.4	Petrol	60	10/90-06/95	GA14DS										
Engine	Information				A10	A20	A40	A50	A70	C10 - C30	C20	E01		
All engines	01/10/92 ->, version Lucas						1.328.101							
All engines	->year 01/10/92, version Mitsubishi						1.331.114	1.431.110						
All engines	01/10/92 ->, version Mitsubishi						1.331.155	1.431.131						
All engines	01/10/92 ->, version Hitachi							1.422.086						

A10	CONDENSER	A20	CONTACT SET	A40	DISTRIBUTOR CAP	A50	ROTOR	A70	PICK-UP
C10	COIL	C20	IGNITION MODULE	C30	ELECTRONIC IGNITION KIT	E01	IGNITION CABLE SET		

The present application list is a brief version. For the detailed information about the possibility of installation on a specific vehicle, please refer to our web-catalogue <http://catalogo.facet.eu/>









					FUNCTIONS ON THE VEHICLE							
Vehicle	alim.	kW	Date	Engine	 A10	 A20	 A40	 A50	 A70	 C10 - C30	 C20	 E01
ENGINE												
1.4 i	Petrol	55	10/90-05/95	GA14DE, GA14DS								
Engine	Information			A10	A20	A40	A50	A70	C10 - C30	C20	E01	
Eng. GA14DE	version Hitachi					1.322.079						
Eng. GA14DS	01/10/92 ->, version Lucas					1.328.101						
Eng. GA14DS	->year 01/10/92, version Mitsubishi					1.331.114	1.431.110					
Eng. GA14DS	01/10/92 ->, version Mitsubishi					1.331.155	1.431.131					
Eng. GA14DS	01/10/92 ->, version Hitachi						1.422.086					
ENGINE												
1.4 i 16V	Petrol	64	10/90-06/95	GA14DE								
Engine	Information			A10	A20	A40	A50	A70	C10 - C30	C20	E01	
All engines	version Hitachi					1.322.079						
ENGINE												
1.6 16V 4x4	Petrol	66	11/90-05/95	GA16DS								
Engine	Information			A10	A20	A40	A50	A70	C10 - C30	C20	E01	
All engines	version Hitachi					1.322.046						
All engines	version Lucas					1.328.101						
All engines	version Hitachi, no specific info conc. application available						1.422.070, 1.422.086					
ENGINE												
1.6 i	Petrol	66	10/90-03/00	GA16DE, GA16DS								
Engine	Information			A10	A20	A40	A50	A70	C10 - C30	C20	E01	
All engines	->year 01/10/92, version Hitachi					1.322.046	1.422.070					
Eng. GA16DE	version Hitachi					1.322.079						
Eng. GA16DE	->year 30/04/98, Traveller, version Hitachi					1.322.089						
All engines	01/10/92 ->, version Lucas					1.328.101						
All engines	01/10/92 ->, version Mitsubishi					1.331.155	1.431.131					
All engines	01/10/92 ->, version Hitachi						1.422.086					
Eng. GA16DE												1.501.399
ENGINE												
1.6 i	Petrol	82	10/90-05/95	GA16DE								
Engine	Information			A10	A20	A40	A50	A70	C10 - C30	C20	E01	
All engines	version Hitachi					1.322.079						
All engines												1.501.399
ENGINE												
1.6 i 16V	Petrol	75	10/92-05/95	GA16DE								
Engine	Information			A10	A20	A40	A50	A70	C10 - C30	C20	E01	
All engines	version Hitachi					1.322.079						
All engines												1.501.399
ENGINE												
1.6 i 16V 4WD	Petrol	66	10/90-05/95	GA16DS								
Engine	Information			A10	A20	A40	A50	A70	C10 - C30	C20	E01	
All engines	version Hitachi					1.322.046						
All engines	version Hitachi, no specific info conc. application available						1.422.070, 1.422.086					
ENGINE												
1.6 i 16V 4WD	Petrol	75	10/92-06/95	GA16DE								
Engine	Information			A10	A20	A40	A50	A70	C10 - C30	C20	E01	
All engines	version Hitachi					1.322.046						
All engines	version Hitachi, no specific info conc. application available						1.422.070, 1.422.086					
ENGINE												
1.6 i 16V 4x4	Petrol	75	10/92-03/00	GA16DE								
Engine	Information			A10	A20	A40	A50	A70	C10 - C30	C20	E01	
All engines	version Hitachi					1.322.046						
All engines	version Hitachi, no specific info conc. application available						1.422.070, 1.422.086					
ENGINE												
2.0 GTI 16V	Petrol	105	10/90-05/95	SR20DE								
Engine	Information			A10	A20	A40	A50	A70	C10 - C30	C20	E01	
All engines	version Hitachi					1.322.073	1.422.085					

A10 CONDENSER	A20 CONTACT SET	A40 DISTRIBUTOR CAP	A50 ROTOR	A70 PICK-UP
C10 COIL	C20 IGNITION MODULE	C30 ELECTRONIC IGNITION KIT	E01 IGNITION CABLE SET	

Vehicle	alim.	kW	Date	Engine	FUNCTIONS ON THE VEHICLE									
					A10	A20	A40	A50	A70	C10 - C30	C20	E01		
ENGINE														
2.0 GTI-R 4x4	Petrol	162	10/90-05/95	SR20DET										
Engine	Information				A10	A20	A40	A50	A70	C10 - C30	C20	E01		
All engines	version Hitachi						1.322.073	1.422.085						
SYLPHY III														
1.6 DIG-T	Petrol	0	07/12->	MR16DDT										
Engine	Information				A10	A20	A40	A50	A70	C10 - C30	C20	E01		
All engines	Qty: 4									1.970.551	C10			
ENGINE														
1.8	Petrol	96	08/12->	MRA8DE										
Engine	Information				A10	A20	A40	A50	A70	C10 - C30	C20	E01		
All engines	Qty: 4									1.970.552	C10			
TEANA II														
2.5	Petrol	134	07/08-09/13	VQ25DE										
Engine	Information				A10	A20	A40	A50	A70	C10 - C30	C20	E01		
All engines	x 6, COIL ON PLUG									1.970.533	C10			
ENGINE														
2.5 FOUR Trazione integrale	Petrol	123	06/08-12/12	QR25DE										
Engine	Information				A10	A20	A40	A50	A70	C10 - C30	C20	E01		
All engines	x 4, COIL ON PLUG									1.970.552	C10			
ENGINE														
3.5	Petrol	183	07/08-09/13	VQ35DE										
Engine	Information				A10	A20	A40	A50	A70	C10 - C30	C20	E01		
All engines	x 6, COIL ON PLUG									1.970.533	C10			
TEANA III														
2.5	Petrol	127	09/13->	QR25DE										
Engine	Information				A10	A20	A40	A50	A70	C10 - C30	C20	E01		
All engines	x 4, COIL ON PLUG									1.970.552	C10			
ENGINE														
3.5	Petrol	0	01/14->	VQ35DE										
Engine	Information				A10	A20	A40	A50	A70	C10 - C30	C20	E01		
All engines	Qty: 6									1.970.533	C10			
ENGINE														
3.5 CVTC	Petrol	183	01/14->	VQ35DE										
Engine	Information				A10	A20	A40	A50	A70	C10 - C30	C20	E01		
All engines	x 6, COIL ON PLUG									1.970.533	C10			
TERRANO I														
2.4 i 4WD	Petrol	76	10/87-02/93	Z24i										
Engine	Information				A10	A20	A40	A50	A70	C10 - C30	C20	E01		
All engines	version Hitachi						1.322.040	1.422.066						
TERRANO II														
2.4 4WD	Petrol	85	05/96-01/02	KA24E										
Engine	Information				A10	A20	A40	A50	A70	C10 - C30	C20	E01		
All engines	->year 01/05/96, version Hitachi						1.322.046							
All engines	01/05/96 ->, version Hitachi						1.322.089							
All engines	no specific info conc. application available, version Hitachi							1.422.070, 1.422.102						
All engines	01/05/96 ->												1.501.789	
ENGINE														
2.4 4WD	Petrol	87	05/96-09/07	KA24E										
Engine	Information				A10	A20	A40	A50	A70	C10 - C30	C20	E01		
All engines	->year 01/05/96, version Hitachi						1.322.046							
All engines	01/05/96 ->, version Hitachi						1.322.089							
All engines	01/10/99 ->, ->year 01/02/02, version Hitachi							1.422.070						
All engines	01/03/02 ->, version Hitachi							1.422.102						
All engines	01/05/96 ->												1.501.789	

A10 CONDENSER	A20 CONTACT SET	A40 DISTRIBUTOR CAP	A50 ROTOR	A70 PICK-UP
C10 COIL	C20 IGNITION MODULE	C30 ELECTRONIC IGNITION KIT	E01 IGNITION CABLE SET	

The present application list is a brief version. For the detailed information about the possibility of installation on a specific vehicle, please refer to our web-catalogue <http://catalogo.facet.eu/>

				FUNCTIONS ON THE VEHICLE								
Vehicle	alim.	kW	Date	Engine								
				ENGINE								
2.4 i 12V 4WD	Petrol	91	02/93-12/97	KA24E								
Engine	Information											
All engines	->year 01/05/96, version Hitachi						1.322.046					
All engines	01/05/96 ->, version Hitachi						1.322.089					
All engines	->year 01/05/96, 01/10/99 ->, ->year 01/02/02, version Hitachi							1.422.070				
All engines	01/03/02 ->, version Hitachi							1.422.102				
All engines	01/05/96 ->											1.501.789
TERRANO III				ENGINE								
1.6	Petrol	75	03/14->	K4M606, K4M690								
Engine	Information											
All engines	x 4, COIL ON PLUG									1.970.432	C10	
1.6	Petrol	77	09/13->	K4M								
Engine	Information											
All engines										1.970.432	C10	
1.6	Petrol	84	12/15->	H4M								
Engine	Information											
All engines	x 4, COIL ON PLUG									1.970.613	C10	
1.6 4x4	Petrol	75	03/14->	K4M606, K4M690								
Engine	Information											
All engines	x 4, COIL ON PLUG									1.970.432	C10	
1.6 4x4	Petrol	84	12/15->	H4M								
Engine	Information											
All engines	x 4, COIL ON PLUG									1.970.613	C10	
2.0	Petrol	0	09/13->	F4R								
Engine	Information											
All engines	Qty: 4									1.970.432	C10	
2.0	Petrol	98	03/14->	F4R								
Engine	Information											
All engines	x 4, BERU, COIL ON PLUG									1.970.432	C10	
2.0 4x4	Petrol	105	12/15->	F4R								
Engine	Information											
All engines	x 4, BERU, COIL ON PLUG									1.970.432	C10	
2.0 4x4	Petrol	98	03/14->	F4R								
Engine	Information											
All engines	x 4, BERU, COIL ON PLUG									1.970.432	C10	
TIIDA I				ENGINE								
1.6	Petrol	81	09/07-12/12	HR16DE								
Engine	Information											
All engines	x 4, COIL ON PLUG									1.970.489	C10	
1.8	Petrol	78	01/07-06/11	MR18DE								
Engine	Information											
All engines	Qty: 4									1.970.489	C10	
All engines	x 4, COIL ON PLUG									1.970.489	C10	
1.8	Petrol	93	05/04-12/12	MR18DE								
Engine	Information											
All engines	Qty: 4									1.970.489	C10	
All engines	x 4, COIL ON PLUG									1.970.489	C10	

A10 CONDENSER	A20 CONTACT SET	A40 DISTRIBUTOR CAP	A50 ROTOR	A70 PICK-UP
C10 COIL	C20 IGNITION MODULE	C30 ELECTRONIC IGNITION KIT	E01 IGNITION CABLE SET	

Vehicle	alim.	kW	Date	Engine	FUNCTIONS ON THE VEHICLE							
					A10	A20	A40	A50	A70	C10 - C30	C20	E01

TIIDA II

1.6	Petrol	140	02/13->	ENGINE MR16DDT
-----	--------	-----	---------	-------------------

Engine	Information	A10	A20	A40	A50	A70	C10 - C30	C20	E01
All engines	Qty: 4						1.970.551	C10	

1.6 [RUS]	Petrol	0	01/15->	ENGINE HR16DE
-----------	--------	---	---------	------------------

Engine	Information	A10	A20	A40	A50	A70	C10 - C30	C20	E01
All engines	Qty: 4						1.970.552	C10	

1.6 CVTC	Petrol	86	08/12->	ENGINE HR16DE
----------	--------	----	---------	------------------

Engine	Information	A10	A20	A40	A50	A70	C10 - C30	C20	E01
All engines	x 4, COIL ON PLUG						1.970.552	C10	

1.6 DIG-T	Petrol	0	08/11->	ENGINE MR16DDT
-----------	--------	---	---------	-------------------

Engine	Information	A10	A20	A40	A50	A70	C10 - C30	C20	E01
All engines	Qty: 4						1.970.551	C10	

1.8	Petrol	96	08/12->	ENGINE MRA8DE
-----	--------	----	---------	------------------

Engine	Information	A10	A20	A40	A50	A70	C10 - C30	C20	E01
All engines	Qty: 4						1.970.552	C10	

URVAN III

2.0	Petrol	64	05/87-05/97	ENGINE Z20
-----	--------	----	-------------	---------------

Engine	Information	A10	A20	A40	A50	A70	C10 - C30	C20	E01
All engines	version Mitsubishi		1.231.085	1.331.003/00	1.431.023				

2.4 i	Petrol	74	05/89-09/93	ENGINE Z24i
-------	--------	----	-------------	----------------

Engine	Information	A10	A20	A40	A50	A70	C10 - C30	C20	E01
All engines	version Hitachi			1.322.040	1.422.066				

VAN

2.4 [USA]	Petrol	0	01/86-12/89	ENGINE Z24i
-----------	--------	---	-------------	----------------

Engine	Information	A10	A20	A40	A50	A70	C10 - C30	C20	E01
All engines	version Hitachi			1.322.040	1.422.066				

VANETTE II

1.5	Petrol	55	04/87-11/94	ENGINE A15
-----	--------	----	-------------	---------------

Engine	Information	A10	A20	A40	A50	A70	C10 - C30	C20	E01
All engines	version Mitsubishi		1.231.085	1.331.120	1.431.023				
All engines	version Hitachi			1.322.003					

2.0	Petrol	66	07/87-08/94	ENGINE Z20S
-----	--------	----	-------------	----------------

Engine	Information	A10	A20	A40	A50	A70	C10 - C30	C20	E01
All engines	version Mitsubishi	1.131.131	1.231.085	1.331.114	1.431.030				
All engines	version Hitachi			1.322.040	1.422.066				

X-TRAIL

2.0	Petrol	106	12/14->	ENGINE MR20DD
-----	--------	-----	---------	------------------

Engine	Information	A10	A20	A40	A50	A70	C10 - C30	C20	E01
All engines	x 4, COIL ON PLUG						1.970.551	C10	

2.0 ALL MODE 4x4-i	Petrol	106	12/14->	ENGINE MR20DD
--------------------	--------	-----	---------	------------------









Engine	Information	A10	A20	A40	A50	A70	C10 - C30	C20	E01
All engines	x 4, COIL ON PLUG						1.970.551	C10	

2.5 ALL MODE 4x4-i	Petrol	126	04/16->	ENGINE QR25DE
--------------------	--------	-----	---------	------------------

Engine	Information	A10	A20	A40	A50	A70	C10 - C30	C20	E01
All engines	x 4, COIL ON PLUG						1.970.552	C10	

A10 CONDENSER	A20 CONTACT SET	A40 DISTRIBUTOR CAP	A50 ROTOR	A70 PICK-UP
C10 COIL	C20 IGNITION MODULE	C30 ELECTRONIC IGNITION KIT	E01 IGNITION CABLE SET	

The present application list is a brief version. For the detailed information about the possibility of installation on a specific vehicle, please refer to our web-catalogue <http://catalogo.facet.eu/>

				FUNCTIONS ON THE VEHICLE								
Vehicle	alim.	kW	Date	Engine								
X-TRAIL II												
2.0	Petrol	102	06/08-02/14	MR20DE								
Engine		Information			A10	A20	A40	A50	A70	C10 - C30	C20	E01
All engines		Qty: 4								1,970.489	C10	
2.0 4x4	Petrol	101	06/07-11/13	MR20DE								
Engine		Information			A10	A20	A40	A50	A70	C10 - C30	C20	E01
All engines		Qty: 4								1,970.489	C10	
2.0 4x4	Petrol	103	06/08-11/13	MR20DE								
Engine		Information			A10	A20	A40	A50	A70	C10 - C30	C20	E01
All engines		x 4, COIL ON PLUG								1,970.489	C10	
2.0 4x4	Petrol	104	06/07-11/13	MR20DE								
Engine		Information			A10	A20	A40	A50	A70	C10 - C30	C20	E01
All engines		x 4, COIL ON PLUG								1,970.489	C10	
2.0 FWD	Petrol	103	06/08-11/13	MR20DE								
Engine		Information			A10	A20	A40	A50	A70	C10 - C30	C20	E01
All engines		x 4, COIL ON PLUG								1,970.489	C10	
2.0 FWD	Petrol	104	03/07-11/13	MR20DE								
Engine		Information			A10	A20	A40	A50	A70	C10 - C30	C20	E01
All engines		x 4, COIL ON PLUG								1,970.489	C10	
2.5	Petrol	124	09/07-11/13	QR25DE								
Engine		Information			A10	A20	A40	A50	A70	C10 - C30	C20	E01
All engines		Qty: 4								1,970.552	C10	
2.5 4x4	Petrol	124	06/07-11/13	QR25DE								
Engine		Information			A10	A20	A40	A50	A70	C10 - C30	C20	E01
All engines		x 4, COIL ON PLUG								1,970.552	C10	
2.5 4x4	Petrol	132	09/07-07/14	QR25DE								
Engine		Information			A10	A20	A40	A50	A70	C10 - C30	C20	E01
All engines		Qty: 4								1,970.552	C10	
X-TRAIL III												
1.6 DIG-T	Petrol	120	06/15->	MR16DDT								
Engine		Information			A10	A20	A40	A50	A70	C10 - C30	C20	E01
All engines		x 4, COIL ON PLUG								1,970.551	C10	
2.0	Petrol	106	09/14->	MR20DD								
Engine		Information			A10	A20	A40	A50	A70	C10 - C30	C20	E01
All engines		x 4, COIL ON PLUG								1,970.551	C10	
2.0 ALL MODE 4x4-i	Petrol	106	09/14->	MR20DD								
Engine		Information			A10	A20	A40	A50	A70	C10 - C30	C20	E01
All engines		x 4, COIL ON PLUG								1,970.551	C10	
2.5	Petrol	126	12/13->	QR25DE								
Engine		Information			A10	A20	A40	A50	A70	C10 - C30	C20	E01
All engines		Qty: 4								1,970.552	C10	
2.5 ALL MODE 4x4-i	Petrol	126	12/13->	QR25DE								
Engine		Information			A10	A20	A40	A50	A70	C10 - C30	C20	E01
All engines		x 4, COIL ON PLUG								1,970.552	C10	

A10 CONDENSER	A20 CONTACT SET	A40 DISTRIBUTOR CAP	A50 ROTOR	A70 PICK-UP
C10 COIL	C20 IGNITION MODULE	C30 ELECTRONIC IGNITION KIT	E01 IGNITION CABLE SET	

Vehicle	alim.	kW	Date	Engine	FUNCTIONS ON THE VEHICLE							
					 A10	 A20	 A40	 A50	 A70	 C10 - C30	 C20	 E01

1000				ENGINE
C	Petrol	29	08/63-12/72	--

Engine	Information	A10	A20	A40	A50	A70	C10 - C30	C20	E01
All engines					1.406.021R				

A10	CONDENSER	A20	CONTACT SET	A40	DISTRIBUTOR CAP	A50	ROTOR	A70	PICK-UP
C10	COIL	C20	IGNITION MODULE	C30	ELECTRONIC IGNITION KIT	E01	IGNITION CABLE SET		

The present application list is a brief version. For the detailed information about the possibility of installation on a specific vehicle, please refer to our web-catalogue <http://catalogo.facet.eu/>

Vehicle	alim.	kW	Date	Engine	FUNCTIONS ON THE VEHICLE							
					A10	A20	A40	A50	A70	C10 - C30	C20	E01

ADAM

				ENGINE
1.0	Petrol	66	07/14-11/18	B 10 XFL, D 10 XFL

Engine	Information	A10	A20	A40	A50	A70	C10 - C30	C20	E01
All engines	x 3, COIL ON PLUG						1.970.631	C10	

				ENGINE
1.0	Petrol	85	07/14-11/18	B 10 XFT, D 10 XFT

Engine	Information	A10	A20	A40	A50	A70	C10 - C30	C20	E01
All engines	x 3, COIL ON PLUG						1.970.631	C10	

				ENGINE
1.2	Petrol	51	10/12-02/19	A 12 XEL, B 12 XEL, D 12 XEL

Engine	Information	A10	A20	A40	A50	A70	C10 - C30	C20	E01
All engines	x 1, COIL ON RAIL						1.970.547	C10	

				ENGINE
1.4	Petrol	64	10/12-02/19	A 14 XEL, B 14 XEL, D 14 XEL

Engine	Information	A10	A20	A40	A50	A70	C10 - C30	C20	E01
All engines	x 1, COIL ON RAIL						1.970.547	C10	

				ENGINE
1.4	Petrol	74	10/12-02/19	A 14 XER, B 14 XER, D 14 XER

Engine	Information	A10	A20	A40	A50	A70	C10 - C30	C20	E01
All engines	x 1, COIL ON RAIL						1.970.547	C10	

				ENGINE
1.4 LPG	Petrol/ Liquified Petroleum Gas (LPG)	64	07/13-11/18	A 14 XEL, B 14 XEL, D 14 XEL

Engine	Information	A10	A20	A40	A50	A70	C10 - C30	C20	E01
All engines	x 1, COIL ON RAIL						1.970.547	C10	

				ENGINE
1.4 S	Petrol	110	11/14-01/19	B 14 NEH, D 14 NEH

Engine	Information	A10	A20	A40	A50	A70	C10 - C30	C20	E01
All engines	x 1, COIL ON RAIL						1.970.547	C10	

ADMIRAL

				ENGINE
2.6 S	Petrol	74	04/64-09/65	26 S

Engine	Information	A10	A20	A40	A50	A70	C10 - C30	C20	E01
All engines			1.206.029HV						

AGILA A

				ENGINE
1.0	Petrol	44	08/03-12/07	Z 10 XEP

Engine	Information	A10	A20	A40	A50	A70	C10 - C30	C20	E01
All engines	x 3, BOSCH, COIL ON PLUG, 12 Volt, Dia: 55 mm, for pre-resistance						1.970.398	C10	

				ENGINE
1.0 12V	Petrol	43	09/00-12/07	Z10XE

Engine	Information	A10	A20	A40	A50	A70	C10 - C30	C20	E01
All engines	x 3, BOSCH, COIL ON PLUG						1.970.398	C10	

				ENGINE
1.2 16V	Petrol	55	09/00-12/07	Z 12 XE

Engine	Information	A10	A20	A40	A50	A70	C10 - C30	C20	E01
All engines	x 4, BOSCH, COIL ON PLUG						1.970.400	C10	

				ENGINE
1.2 16V Twinport	Petrol	59	07/04-12/07	Z 12 XEP

Engine	Information	A10	A20	A40	A50	A70	C10 - C30	C20	E01
All engines	x 1, BOSCH, COIL ON PLUG, incl. spark plug connector						1.970.400	C10	

AMPERA

				ENGINE
EV 150	Petrol/ Electric	111	11/11-03/15	A 14 XFL

Engine	Information	A10	A20	A40	A50	A70	C10 - C30	C20	E01
All engines	x 1, COIL ON RAIL						1.970.547	C10	

A10 CONDENSER	A20 CONTACT SET	A40 DISTRIBUTOR CAP	A50 ROTOR	A70 PICK-UP
C10 COIL	C20 IGNITION MODULE	C30 ELECTRONIC IGNITION KIT	E01 IGNITION CABLE SET	

Vehicle	alim.	kW	Date	Engine	FUNCTIONS ON THE VEHICLE							
					A10	A20	A40	A50	A70	C10 - C30	C20	E01

ASCONA B

				ENGINE
2.0 N	Petrol	66	08/77-08/81	20 N

Engine	Information	A10	A20	A40	A50	A70	C10 - C30	C20	E01
All engines					1.412.093R				

ASCONA C

				ENGINE
1.3 N	Petrol	44	09/81-08/86	13 N

Engine	Information	A10	A20	A40	A50	A70	C10 - C30	C20	E01
All engines	version Bosch		1.206.034HVS	1.306.080	1.406.026R				
All engines	version Delco Remy			1.312.073	1.412.096	1.912.011			
All engines	eng. type 879422 ->						1.970.111	C10	
All engines									1.500.514

				ENGINE
1.3 S	Petrol	55	09/81-08/88	13 S

Engine	Information	A10	A20	A40	A50	A70	C10 - C30	C20	E01
All engines	eng. type 885919 ->						1.970.111	C10	
All engines									1.500.514

				ENGINE
1.6	Petrol	55	09/81-08/88	16 N

Engine	Information	A10	A20	A40	A50	A70	C10 - C30	C20	E01
All engines	version Bosch			1.306.080	1.406.056R				
All engines							1.970.109	C10	

				ENGINE
1.6	Petrol	60	09/86-08/88	16 SV

Engine	Information	A10	A20	A40	A50	A70	C10 - C30	C20	E01
All engines	prod. nr. 4124 ->, version Delco Remy			1.312.073					
All engines	->prod. nr. 4123, version Delco Remy			1.312.074					
All engines	version Delco Remy				1.412.097	1.912.011			
All engines							1.970.111	C10	1.500.514

				ENGINE
1.6 i	Petrol	55	09/87-08/88	E 16 NZ

Engine	Information	A10	A20	A40	A50	A70	C10 - C30	C20	E01
All engines									1.501.942

				ENGINE
1.6 i Cat	Petrol	55	09/86-08/88	C 16 LZ, C 16 NZ

Engine	Information	A10	A20	A40	A50	A70	C10 - C30	C20	E01
All engines	version Delco Remy			1.312.073	1.412.097	1.912.010			
All engines							1.970.111	C10	1.965.025
All engines									1.501.942

				ENGINE
1.6 S	Petrol	66	09/81-08/86	16 SH

Engine	Information	A10	A20	A40	A50	A70	C10 - C30	C20	E01
All engines	version Bosch			1.306.080	1.406.056R				
All engines							1.970.109	C10	

				ENGINE
1.8	Petrol	62	09/87-08/88	E 18 NV

Engine	Information	A10	A20	A40	A50	A70	C10 - C30	C20	E01
All engines	version Bosch			1.306.240	1.406.127R				
All engines							1.970.194	C10	

				ENGINE
1.8	Petrol	85	09/81-08/88	18 SE

Engine	Information	A10	A20	A40	A50	A70	C10 - C30	C20	E01
All engines	version Bosch			1.306.240	1.406.127R				

				ENGINE
1.8 E	Petrol	74	01/85-08/86	C 18 NE, S 18 NV

Engine	Information	A10	A20	A40	A50	A70	C10 - C30	C20	E01
Eng. C 18 NE	version Bosch			1.306.080	1.406.056R				
Eng. S 18 NV	version Bosch			1.306.240	1.406.127R				
Eng. S 18 NV							1.970.194	C10	

A10 CONDENSER	A20 CONTACT SET	A40 DISTRIBUTOR CAP	A50 ROTOR	A70 PICK-UP
C10 COIL	C20 IGNITION MODULE	C30 ELECTRONIC IGNITION KIT	E01 IGNITION CABLE SET	

Vehicle	alim.	kW	Date	Engine	FUNCTIONS ON THE VEHICLE							
					A10	A20	A40	A50	A70	C10 - C30	C20	E01

ENGINE				
1.8 i	Petrol	85	09/82-08/86	18 E

Engine	Information	A10	A20	A40	A50	A70	C10 - C30	C20	E01
All engines	version Bosch			1.306.080	1.406.056R				
All engines							1.970.109	C10	

ENGINE				
2.0 i	Petrol	85	09/86-08/88	20 NE

Engine	Information	A10	A20	A40	A50	A70	C10 - C30	C20	E01
All engines	version Bosch			1.306.240	1.406.127R				
All engines							1.970.194	C10	

ENGINE				
2.0 i Cat	Petrol	85	09/86-08/88	C 20 NE

Engine	Information	A10	A20	A40	A50	A70	C10 - C30	C20	E01
All engines	version Bosch			1.306.240	1.406.127R				
All engines							1.970.194	C10	

ENGINE				
2.0 i GT	Petrol	95	03/87-08/88	20 SEH

Engine	Information	A10	A20	A40	A50	A70	C10 - C30	C20	E01
All engines	version Bosch			1.306.240	1.406.127R				
All engines							1.970.194	C10	

ASTRA F

ENGINE				
1.4	Petrol	55	09/91-09/93	14 NV

Engine	Information	A10	A20	A40	A50	A70	C10 - C30	C20	E01
All engines	version Bosch			1.306.256	1.406.056R				
All engines								1.965.005	
All engines	->eng. 02BF1476, 19241623								1.501.237
All engines	eng. type 02BF1477, 19241624 ->								1.501.529

ENGINE				
1.4	Petrol	60	09/92-09/98	14 SE

Engine	Information	A10	A20	A40	A50	A70	C10 - C30	C20	E01
All engines	version Lucas			1.328.100	1.428.028R				
All engines							1.970.140	C10	1.965.036
All engines	eng. type 02T14053, 02BD1413 ->								1.500.634
All engines	->eng. 02T14052, 19880550								1.501.237
All engines	eng. type 02BD1413, 19280317 ->								1.501.531

ENGINE				
1.4 i	Petrol	44	09/91-01/05	C 14 NZ, X 14 NZ

Engine	Information	A10	A20	A40	A50	A70	C10 - C30	C20	E01
All engines	connector type SAE, version Bosch			1.306.249					
All engines	connector type M4, version Bosch			1.306.256					
All engines	version Bosch				1.406.121R				
All engines	version Lucas				1.428.028R	1.928.202			
All engines							1.970.140	C10	1.965.036
All engines	->eng. 02BF1476, 19241623								1.501.237
All engines	eng. type 02BF1477, 19241624 ->								1.501.529

ENGINE				
1.4 i 16V	Petrol	66	01/96-03/01	X 14 XE

Engine	Information	A10	A20	A40	A50	A70	C10 - C30	C20	E01
All engines									1.501.559

ENGINE				
1.4 Si	Petrol	60	03/92-03/01	C 14 SE

Engine	Information	A10	A20	A40	A50	A70	C10 - C30	C20	E01
All engines	version Lucas			1.328.100	1.428.028R				
All engines							1.970.140	C10	1.965.036
All engines	eng. type 02T14053, 02BD1413 ->								1.500.634
All engines	->eng. 02T14052, 19880550								1.501.237
All engines	eng. type 02BD1413, 19280317 ->								1.501.531

ENGINE				
1.6	Petrol	55	09/95-09/98	16 LZ2, 16 NZR







Engine	Information	A10	A20	A40	A50	A70	C10 - C30	C20	E01
Eng. 16 LZ2	version Ducellier			1.315.084	1.415.103R				

A10 CONDENSER	A20 CONTACT SET	A40 DISTRIBUTOR CAP	A50 ROTOR	A70 PICK-UP
C10 COIL	C20 IGNITION MODULE	C30 ELECTRONIC IGNITION KIT	E01 IGNITION CABLE SET	

Vehicle	alim.	kW	Date	Engine	FUNCTIONS ON THE VEHICLE								
					A10	A20	A40	A50	A70	C10 - C30	C20	E01	
1.6	Petrol	55	09/95-09/98	ENGINE 16 LZ2, 16 NZR									
Engine	Information				A10	A20	A40	A50	A70	C10 - C30	C20	E01	
Eng. 16 LZ2										1.970.140	C10	1.965.036	
Eng. 16 LZ2	FOR: (ZA)									1.970.192	C10		
Eng. 16 NZR	->eng. 02BE6166												1.500.634
Eng. 16 NZR	eng. type 02BE6167 ->												1.501.531
1.6 i	Petrol	52	02/93-08/96	ENGINE X 16 SZ									
Engine	Information				A10	A20	A40	A50	A70	C10 - C30	C20	E01	
All engines	->eng. 02BE6166												1.500.634
All engines	eng. type 02BE6167 ->												1.501.531
1.6 i	Petrol	55	09/91-01/05	ENGINE C 16 NZ, X 16 SZR									
Engine	Information				A10	A20	A40	A50	A70	C10 - C30	C20	E01	
Eng. C 16 NZ	version Delco Remy						1.312.073	1.412.100	1.912.010				
Eng. C 16 NZ										1.970.341	C10	1.965.025	
Eng. C 16 NZ	->eng. 02V65825												1.500.514
Eng. X 16 SZR	->eng. 02BE6166												1.500.634
Eng. X 16 SZR	eng. type 02BE6167 ->												1.501.531
1.6 i 16V	Petrol	74	08/94-01/05	ENGINE X 16 XEL									
Engine	Information				A10	A20	A40	A50	A70	C10 - C30	C20	E01	
All engines	->eng. 20C17332												1.500.688
All engines	eng. type 20C17333 ->												1.501.559
1.6 Si	Petrol	74	03/92-12/94	ENGINE C 16 SE									
Engine	Information				A10	A20	A40	A50	A70	C10 - C30	C20	E01	
All engines	->eng. 02BD0920												1.500.634
All engines	eng. type 02BD0921 ->												1.501.531
1.8	Petrol	81	02/03-07/04	ENGINE Z 18 XEL									
Engine	Information				A10	A20	A40	A50	A70	C10 - C30	C20	E01	
All engines										1.970.272	C10		1.501.562
1.8 i	Petrol	66	09/91-09/98	ENGINE C 18 NZ									
Engine	Information				A10	A20	A40	A50	A70	C10 - C30	C20	E01	
All engines	version Bosch						1.306.257	1.406.127R					
All engines	version Duellier						1.315.084	1.415.103R					
All engines										1.970.140	C10	1.965.036	
All engines	FOR: (ZA)									1.970.192	C10		
All engines	eng. type 14349312 ->												1.500.689
1.8 i	Petrol	85	03/98-08/00	ENGINE X 18 XE1									
Engine	Information				A10	A20	A40	A50	A70	C10 - C30	C20	E01	
All engines										1.970.508	C10		
1.8 i 16V	Petrol	82	09/95-09/96	ENGINE 18 SE									
Engine	Information				A10	A20	A40	A50	A70	C10 - C30	C20	E01	
All engines										1.970.192	C10		
1.8 i 16V	Petrol	85	07/94-03/01	ENGINE C 18 SEL, C 18 XEL, X 18 XE									
Engine	Information				A10	A20	A40	A50	A70	C10 - C30	C20	E01	
All engines										1.970.272	C10		
All engines	ch. W2000000 ->, ch. W5000000 ->, ch. W8000000 ->												1.501.506
All engines	->ch. V29999999, ->ch. V59999999, ->ch. V89999999												1.501.562
1.8 i 16V	Petrol	92	06/93-01/98	ENGINE C 18 XE									
Engine	Information				A10	A20	A40	A50	A70	C10 - C30	C20	E01	
All engines										1.970.272	C10		
All engines	ch. W2000000 ->, ch. W5000000 ->, ch. W8000000 ->												1.501.506

A10	CONDENSER	A20	CONTACT SET	A40	DISTRIBUTOR CAP	A50	ROTOR	A70	PICK-UP
C10	COIL	C20	IGNITION MODULE	C30	ELECTRONIC IGNITION KIT	E01	IGNITION CABLE SET		

The present application list is a brief version. For the detailed information about the possibility of installation on a specific vehicle, please refer to our web-catalogue <http://catalogo.facet.eu/>









					FUNCTIONS ON THE VEHICLE							
Vehicle	alim.	kW	Date	Engine								
1.8i 16V	Petrol	92	06/93-01/98	ENGINE C 18 XE								
Engine	Information				A10	A20	A40	A50	A70	C10 - C30	C20	E01
All engines	->ch. V2999999, ->ch. V5999999, ->ch. V8999999											1.501.562
2.0 GSI 16V	Petrol	110	09/91-01/98	ENGINE C 20 XE								
Engine	Information				A10	A20	A40	A50	A70	C10 - C30	C20	E01
All engines	->eng. 14137012, version Bosch						1.306.257	1.406.121R				
All engines	eng. type 14137013 ->									1.970.273	C10	
All engines	eng. type 14002935 ->											1.500.688
2.0 i	Petrol	85	09/91-09/98	ENGINE C 20 NE								
Engine	Information				A10	A20	A40	A50	A70	C10 - C30	C20	E01
All engines	version Bosch						1.306.257	1.406.127R				
All engines	version Ducellier						1.315.084	1.415.103R				
All engines										1.970.192	C10	
All engines	eng. type 14672354 ->, ->ch. R2999999, ->ch. R3999999, ->ch. R4999999, ->ch. R5999999, ->ch. R6999999, ->ch. R8999999											1.500.689
2.0 i 16V	Petrol	100	02/95-08/00	ENGINE X 20 XEV								
Engine	Information				A10	A20	A40	A50	A70	C10 - C30	C20	E01
All engines										1.970.272	C10	
All engines	ch. W2000000 ->, ch. W5000000 ->, ch. W8000000 ->											1.501.506
All engines	->ch. V2999999, ->ch. V5999999, ->ch. V8999999											1.501.562
2.0 i 16V	Petrol	110	03/93-01/98	ENGINE C 20 XE								
Engine	Information				A10	A20	A40	A50	A70	C10 - C30	C20	E01
All engines	->eng. 14137012, version Bosch						1.306.257	1.406.121R				
All engines	eng. type 14137013 ->									1.970.273	C10	
All engines	eng. type 14002935 ->											1.500.688
2.0 i 16V	Petrol	118	10/99-08/00	ENGINE X 20 XER								
Engine	Information				A10	A20	A40	A50	A70	C10 - C30	C20	E01
All engines										1.970.272	C10	1.501.562
ASTRA G												
1.2	Petrol	48	09/98-08/00	ENGINE X 12 XE								
Engine	Information				A10	A20	A40	A50	A70	C10 - C30	C20	E01
All engines	x 4, BOSCH, COIL ON PLUG									1.970.400	C10	
1.2 16V	Petrol	48	02/98-09/00	ENGINE X 12 XE								
Engine	Information				A10	A20	A40	A50	A70	C10 - C30	C20	E01
All engines	x 4, BOSCH, COIL ON PLUG									1.970.400	C10	
1.2 16V	Petrol	55	09/00-01/05	ENGINE Z 12 XE								
Engine	Information				A10	A20	A40	A50	A70	C10 - C30	C20	E01
All engines	->ch. 38999999, ch. 39000000 ->, x 1, x 4, BOSCH, COIL ON PLUG, incl. spark plug connector									1.970.400	C10	
1.4	Petrol	66	09/98-12/09	ENGINE X 14 XE, Z 14 XE, Z 14 XEP								
Engine	Information				A10	A20	A40	A50	A70	C10 - C30	C20	E01
Eng. X 14 XE, Z 14 XE	x 4, COIL ON PLUG, incl. spark plug connector									1.970.399	C10	
Eng. Z 14 XEP	x 1, BOSCH, COIL ON PLUG, incl. spark plug connector									1.970.400	C10	
1.4 16V	Petrol	66	02/98-01/05	ENGINE X 14 XE, Z 14 XE								
Engine	Information				A10	A20	A40	A50	A70	C10 - C30	C20	E01
All engines	x 4, COIL ON PLUG, incl. spark plug connector									1.970.399	C10	

A10 CONDENSER	A20 CONTACT SET	A40 DISTRIBUTOR CAP	A50 ROTOR	A70 PICK-UP
C10 COIL	C20 IGNITION MODULE	C30 ELECTRONIC IGNITION KIT	E01 IGNITION CABLE SET	

Vehicle	alim.	kW	Date	Engine	FUNCTIONS ON THE VEHICLE									
					A10	A20	A40	A50	A70	C10 - C30	C20	E01		
ENGINE														
1.4 LPG	Petrol/ Liquified Petro- leum Gas (LPG)	66	02/98-01/05	X 14 XE, Z 14 XE										
Engine					A10	A20	A40	A50	A70	C10 - C30	C20	E01		
All engines										1.970.399	C10			
ENGINE														
1.6	Petrol	55	02/98-09/00	X 16 SZR										
Engine					A10	A20	A40	A50	A70	C10 - C30	C20	E01		
All engines													1.501.904	
ENGINE														
1.6	Petrol	62	09/00-04/05	Z 16 SE										
Engine					A10	A20	A40	A50	A70	C10 - C30	C20	E01		
All engines													1.501.904	
ENGINE														
1.6	Petrol	74	09/98-01/04	C 16 SEL, Z 16 XE										
Engine					A10	A20	A40	A50	A70	C10 - C30	C20	E01		
All engines										1.970.399	C10			
ENGINE														
1.6	Petrol	76	11/02-12/09	Z 16 XEP										
Engine					A10	A20	A40	A50	A70	C10 - C30	C20	E01		
All engines										1.970.399	C10			
All engines										1.970.450	C10			
ENGINE														
1.6 16V	Petrol	74	02/98-10/05	X 16 XEL, Z 16 XE										
Engine					A10	A20	A40	A50	A70	C10 - C30	C20	E01		
All engines										1.970.399	C10			
ENGINE														
1.6 16V	Petrol	76	03/00-05/05	Z 16 XEP										
Engine					A10	A20	A40	A50	A70	C10 - C30	C20	E01		
All engines										1.970.450	C10			
ENGINE														
1.6 CNG	Petrol/ Com- pressed Natural Gas (CNG)	71	03/03-07/04	Z 16 YNG										
Engine					A10	A20	A40	A50	A70	C10 - C30	C20	E01		
All engines										1.970.399	C10			
ENGINE														
1.6 LPG	Petrol/ Liquified Petro- leum Gas (LPG)	74	03/98-01/05	X 16 XEL, Z 16 XE										
Engine					A10	A20	A40	A50	A70	C10 - C30	C20	E01		
All engines										1.970.399	C10			
ENGINE														
1.6 LPG	Petrol/ Liquified Petro- leum Gas (LPG)	76	06/02-06/07	Z 16 XEP										
Engine					A10	A20	A40	A50	A70	C10 - C30	C20	E01		
All engines										1.970.450	C10			
ENGINE														
1.8	Petrol	81	02/03-07/04	Z 18 XEL										
Engine					A10	A20	A40	A50	A70	C10 - C30	C20	E01		
All engines										1.970.508	C10			
ENGINE														
1.8 16V	Petrol	85	02/98-10/00	X 18 XE1										
Engine					A10	A20	A40	A50	A70	C10 - C30	C20	E01		
All engines										1.970.508	C10			

A10	CONDENSER	A20	CONTACT SET	A40	DISTRIBUTOR CAP	A50	ROTOR	A70	PICK-UP
C10	COIL	C20	IGNITION MODULE	C30	ELECTRONIC IGNITION KIT	E01	IGNITION CABLE SET		

The present application list is a brief version. For the detailed information about the possibility of installation on a specific vehicle, please refer to our web-catalogue <http://catalogo.facet.eu/>

				FUNCTIONS ON THE VEHICLE								
Vehicle	alim.	kW	Date	Engine								
1.8 16V	Petrol	92	06/00-10/05	ENGINE Z 18 XE								
Engine	Information			A10	A20	A40	A50	A70	C10 - C30	C20	E01	
All engines	x 1, COIL ON PLUG, incl. spark plug connector								1.970.508	C10		
2.0 16V	Petrol	100	02/98-01/05	ENGINE X 20 XEV								
Engine	Information			A10	A20	A40	A50	A70	C10 - C30	C20	E01	
All engines	x 1, D.I.S.								1.970.272	C10		
All engines												1.501.562
2.0 16V OPC	Petrol	118	11/99-09/02	ENGINE X 20 XER								
Engine	Information			A10	A20	A40	A50	A70	C10 - C30	C20	E01	
All engines	x 1, D.I.S.								1.970.272	C10		
All engines												1.501.562
2.0 16V Turbo	Petrol	140	09/00-08/01	ENGINE Z 20 LET								
Engine	Information			A10	A20	A40	A50	A70	C10 - C30	C20	E01	
All engines	x 1, COIL ON PLUG								1.970.507	C10		
2.0 16V Turbo	Petrol	141	08/01-05/05	ENGINE Z 20 LET								
Engine	Information			A10	A20	A40	A50	A70	C10 - C30	C20	E01	
All engines	x 1, COIL ON PLUG								1.970.507	C10		
2.0 16V Turbo	Petrol	147	11/02-10/05	ENGINE Z 20 LET								
Engine	Information			A10	A20	A40	A50	A70	C10 - C30	C20	E01	
All engines	x 1, COIL ON PLUG								1.970.507	C10		
2.0 OPC	Petrol	141	03/02-10/05	ENGINE Z 20 LET								
Engine	Information			A10	A20	A40	A50	A70	C10 - C30	C20	E01	
All engines	x 1, COIL ON PLUG								1.970.507	C10		
2.0 OPC	Petrol	147	11/02-01/05	ENGINE Z 20 LET								
Engine	Information			A10	A20	A40	A50	A70	C10 - C30	C20	E01	
All engines	x 1, COIL ON PLUG								1.970.507	C10		
ASTRA H				ENGINE								
1.2	Petrol	59	08/05-10/10	Z 12 XEP								
Engine	Information			A10	A20	A40	A50	A70	C10 - C30	C20	E01	
All engines	x 1, BOSCH, COIL ON PLUG, incl. spark plug connector								1.970.400	C10		
All engines									1.970.400	C10		
1.4	Petrol	55	04/04-10/10	Z 14 XEL								
Engine	Information			A10	A20	A40	A50	A70	C10 - C30	C20	E01	
All engines	x 1, BOSCH, COIL ON PLUG, incl. spark plug connector								1.970.400	C10		
1.4	Petrol	59	04/04-10/04	Z 14 XEL								
Engine	Information			A10	A20	A40	A50	A70	C10 - C30	C20	E01	
All engines									1.970.400	C10		
1.4	Petrol	66	03/04-10/10	Z 14 XEP								
Engine	Information			A10	A20	A40	A50	A70	C10 - C30	C20	E01	
All engines	x 1, BOSCH, COIL ON PLUG, incl. spark plug connector								1.970.400	C10		
1.4 16V	Petrol	66	05/04-07/09	Z 14 XE								
Engine	Information			A10	A20	A40	A50	A70	C10 - C30	C20	E01	
All engines	x 4, COIL ON PLUG, incl. spark plug connector								1.970.399	C10		
1.4 EcoTec	Petrol	66	12/04-12/12	Z 14 XEP								
Engine	Information			A10	A20	A40	A50	A70	C10 - C30	C20	E01	
All engines	x 1, BOSCH, COIL ON PLUG, incl. spark plug connector								1.970.400	C10		

A10 CONDENSER	A20 CONTACT SET	A40 DISTRIBUTOR CAP	A50 ROTOR	A70 PICK-UP
C10 COIL	C20 IGNITION MODULE	C30 ELECTRONIC IGNITION KIT	E01 IGNITION CABLE SET	



Vehicle	alim.	kW	Date	Engine	FUNCTIONS ON THE VEHICLE									
					A10	A20	A40	A50	A70	C10 - C30	C20	E01		
ENGINE														
1.4 LPG	Petrol/ Liquified Petro- leum Gas (LPG)	66	08/09-10/10	Z 14 XEP										
Engine	Information				A10	A20	A40	A50	A70	C10 - C30	C20	E01		
All engines	x 1, BOSCH, COIL ON PLUG, incl. spark plug connector									1.970.400	C10			
ENGINE														
1.6	Petrol	74	06/04-02/06	Z 16 XE										
Engine	Information				A10	A20	A40	A50	A70	C10 - C30	C20	E01		
All engines	x 4, COIL ON PLUG, incl. spark plug connector									1.970.399	C10			
ENGINE														
1.6	Petrol	76	02/06-07/09	Z 16 XEP										
Engine	Information				A10	A20	A40	A50	A70	C10 - C30	C20	E01		
All engines	x 1, DELPHI, COIL ON PLUG, incl. spark plug connector									1.970.450	C10			
ENGINE														
1.6	Petrol	77	03/04-10/10	Z 16 XE1, Z 16 XEP										
Engine	Information				A10	A20	A40	A50	A70	C10 - C30	C20	E01		
All engines	x 1, DELPHI, COIL ON PLUG, incl. spark plug connector									1.970.450	C10			
ENGINE														
1.6	Petrol	85	12/06-05/14	A 16 XER, Z 16 XER										
Engine	Information				A10	A20	A40	A50	A70	C10 - C30	C20	E01		
All engines	x 1, DELPHI, COIL ON PLUG, incl. spark plug connector									1.970.450	C10			
ENGINE														
1.6 16V	Petrol	74	03/04-01/08	Z 16 XE										
Engine	Information				A10	A20	A40	A50	A70	C10 - C30	C20	E01		
All engines	x 4, COIL ON PLUG, incl. spark plug connector									1.970.399	C10			
ENGINE														
1.6 EcoTec	Petrol	76	02/04-11/04	Z 16 XEP										
Engine	Information				A10	A20	A40	A50	A70	C10 - C30	C20	E01		
All engines	x 1, DELPHI, COIL ON PLUG, incl. spark plug connector									1.970.450	C10			
ENGINE														
1.6 EcoTec	Petrol	85	10/06-12/10	Z 16 XER										
Engine	Information				A10	A20	A40	A50	A70	C10 - C30	C20	E01		
All engines	x 1, DELPHI, COIL ON PLUG, incl. spark plug connector									1.970.450	C10			
ENGINE														
1.6 LPG	Petrol/ Liquified Petro- leum Gas (LPG)	85	08/09-10/10	Z 16 XER										
Engine	Information				A10	A20	A40	A50	A70	C10 - C30	C20	E01		
All engines	x 1, DELPHI, COIL ON PLUG, incl. spark plug connector									1.970.450	C10			
ENGINE														
1.6 Turbo	Petrol	132	02/07-10/10	A 16 LET, Z 16 LET										
Engine	Information				A10	A20	A40	A50	A70	C10 - C30	C20	E01		
All engines	x 1, DELPHI, COIL ON PLUG, incl. spark plug connector									1.970.450	C10			
ENGINE														
1.8	Petrol	103	08/05-05/14	A 18 XER, Z 18 XER										
Engine	Information				A10	A20	A40	A50	A70	C10 - C30	C20	E01		
All engines	x 1, DELPHI, COIL ON PLUG, incl. spark plug connector									1.970.450	C10			
ENGINE														
1.8	Petrol	92	01/04-10/10	Z 18 XE										
Engine	Information				A10	A20	A40	A50	A70	C10 - C30	C20	E01		
All engines	x 1, COIL ON PLUG, incl. spark plug connector									1.970.508	C10			
ENGINE														
2.0 Turbo	Petrol	125	03/04-10/10	Z 20 LEL										
Engine	Information				A10	A20	A40	A50	A70	C10 - C30	C20	E01		
All engines	x 1, COIL ON PLUG									1.970.507	C10			
ENGINE														
2.0 Turbo	Petrol	147	09/04-10/10	Z 20 LER										
Engine	Information				A10	A20	A40	A50	A70	C10 - C30	C20	E01		
All engines	x 1, COIL ON PLUG									1.970.507	C10			
ENGINE														
A10	CONDENSER		A20	CONTACT SET		A40	DISTRIBUTOR CAP		A50	ROTOR		A70	PICK-UP	
C10	COIL		C20	IGNITION MODULE		C30	ELECTRONIC IGNITION KIT		E01	IGNITION CABLE SET				

The present application list is a brief version. For the detailed information about the possibility of installation on a specific vehicle, please refer to our web-catalogue <http://catalogo.facet.eu/>

					FUNCTIONS ON THE VEHICLE							
Vehicle	alim.	kW	Date	Engine	A10	A20	A40	A50	A70	C10 - C30	C20	E01
ENGINE												
2.0 Turbo	Petrol	177	03/05-10/10	Z 20 LEH								
Engine		Information			A10	A20	A40	A50	A70	C10 - C30	C20	E01
All engines		x 1, COIL ON PLUG								1.970.507	C10	
ASTRA J												
ENGINE												
1.4	Petrol	103	10/11->	A 14 NET, B 14 NET								
Engine		Information			A10	A20	A40	A50	A70	C10 - C30	C20	E01
All engines		x 1, COIL ON RAIL								1.970.547	C10	
ENGINE												
1.4	Petrol	64	12/09-10/15	A 14 XEL								
Engine		Information			A10	A20	A40	A50	A70	C10 - C30	C20	E01
All engines		x 1, COIL ON RAIL								1.970.547	C10	
ENGINE												
1.4	Petrol	66	01/09->	Z 14 XEP								
Engine		Information			A10	A20	A40	A50	A70	C10 - C30	C20	E01
All engines		x 1, BOSCH, COIL ON PLUG, incl. spark plug connector								1.970.400	C10	
ENGINE												
1.4	Petrol	74	12/09-10/15	A 14 XER, B 14 XER								
Engine		Information			A10	A20	A40	A50	A70	C10 - C30	C20	E01
All engines		x 1, COIL ON RAIL								1.970.547	C10	
ENGINE												
1.4	Petrol	88	10/11->	A 14 NEL, B 14 NEL								
Engine		Information			A10	A20	A40	A50	A70	C10 - C30	C20	E01
All engines		x 1, COIL ON RAIL								1.970.547	C10	
ENGINE												
1.4 LPG	Petrol/ Liquified Petro- leum Gas (LPG)	103	12/11->	A 14 NET								
Engine		Information			A10	A20	A40	A50	A70	C10 - C30	C20	E01
All engines		x 1, COIL ON RAIL								1.970.547	C10	
ENGINE												
1.4 Turbo	Petrol	103	12/09->	A 14 NET, B 14 NET								
Engine		Information			A10	A20	A40	A50	A70	C10 - C30	C20	E01
All engines		x 1, COIL ON RAIL								1.970.547	C10	
ENGINE												
1.4 Turbo	Petrol	88	10/10-10/15	A 14 NEL, B 14 NEL								
Engine		Information			A10	A20	A40	A50	A70	C10 - C30	C20	E01
All engines		x 1, COIL ON RAIL								1.970.547	C10	
ENGINE												
1.6	Petrol	132	10/11->	A 16 LET								
Engine		Information			A10	A20	A40	A50	A70	C10 - C30	C20	E01
All engines		x 1, COIL ON PLUG								1.970.545	C10	
ENGINE												
1.6	Petrol	85	12/06->	A 16 XER, B 16 XER, Z 16 XER								
Engine		Information			A10	A20	A40	A50	A70	C10 - C30	C20	E01
Eng. Z 16 XER		x 1, DELPHI, COIL ON PLUG, incl. spark plug connector								1.970.450	C10	
Eng. A 16 XER, B 16 XER		x 1, COIL ON PLUG, COIL RAILS								1.970.545	C10	
ENGINE												
1.6 LPG	Petrol/ Liquified Petro- leum Gas (LPG)	84	10/12-10/15	A 16 XER								
Engine		Information			A10	A20	A40	A50	A70	C10 - C30	C20	E01
All engines										1.970.545	C10	
ENGINE												
1.6 Turbo	Petrol	132	12/09->	A 16 LET								
Engine		Information			A10	A20	A40	A50	A70	C10 - C30	C20	E01
All engines		x 1, COIL ON PLUG								1.970.545	C10	

A10 CONDENSER	A20 CONTACT SET	A40 DISTRIBUTOR CAP	A50 ROTOR	A70 PICK-UP
C10 COIL	C20 IGNITION MODULE	C30 ELECTRONIC IGNITION KIT	E01 IGNITION CABLE SET	

Vehicle	alim.	kW	Date	Engine	FUNCTIONS ON THE VEHICLE									
					A10	A20	A40	A50	A70	C10 - C30	C20	E01		
ENGINE														
1.8	Petrol	103	02/07->	A 18 XER, Z 18 XER										
Engine					A10	A20	A40	A50	A70	C10 - C30	C20	E01		
Eng. Z 18 XER										1.970.450	C10			
Eng. A 18 XER										1.970.545	C10			
ASTRA K														
ENGINE														
1.0	Petrol	77	05/18->	D 10 XFL										
Engine					A10	A20	A40	A50	A70	C10 - C30	C20	E01		
All engines										1.970.631	C10			
ENGINE														
1.0 Turbo	Petrol	66	06/18->	D 10 XFL										
Engine					A10	A20	A40	A50	A70	C10 - C30	C20	E01		
All engines										1.970.631	C10			
ENGINE														
1.0 Turbo	Petrol	77	06/15->	B 10 XFL, D 10 XFL										
Engine					A10	A20	A40	A50	A70	C10 - C30	C20	E01		
All engines										1.970.631	C10			
ENGINE														
1.4	Petrol	110	06/18->	D 14 XFT										
Engine					A10	A20	A40	A50	A70	C10 - C30	C20	E01		
All engines										1.970.631	C10			
ENGINE														
1.4 CNG	Petrol/ Com- pressed Natural Gas (CNG)	81	10/17->	B 14 XNT										
Engine					A10	A20	A40	A50	A70	C10 - C30	C20	E01		
All engines										1.970.631	C10			
ENGINE														
1.4 Turbo	Petrol	110	06/15->	B 14 XFT, D 14 XFT										
Engine					A10	A20	A40	A50	A70	C10 - C30	C20	E01		
All engines										1.970.631	C10			
ENGINE														
1.4 Turbo	Petrol	92	06/15->	B 14 XFL, D14XFL										
Engine					A10	A20	A40	A50	A70	C10 - C30	C20	E01		
All engines										1.970.631	C10			
CALIBRA A														
ENGINE														
2.0 i	Petrol	85	08/89-12/96	C 20 NE										
Engine					A10	A20	A40	A50	A70	C10 - C30	C20	E01		
All engines							1.306.257	1.406.127R						
All engines							1.315.084	1.415.103R						
All engines										1.970.191	C10			
All engines										1.970.192	C10			
All engines													1.500.689	
ENGINE														
2.0 i 16V	Petrol	100	02/94-07/97	X 20 XEV										
Engine					A10	A20	A40	A50	A70	C10 - C30	C20	E01		
All engines										1.970.272	C10			
All engines													1.501.506	
All engines													1.501.562	
ENGINE														
2.0 i 16V	Petrol	110	06/90-02/94	C 20 XE										
Engine					A10	A20	A40	A50	A70	C10 - C30	C20	E01		
All engines							1.306.251	1.406.121R						
All engines										1.970.273	C10		1.500.688	
ENGINE														
2.0 i 16V 4x4	Petrol	100	02/94-07/97	X 20 XEV										
Engine					A10	A20	A40	A50	A70	C10 - C30	C20	E01		
All engines										1.970.272	C10			
A10	CONDENSER		A20	CONTACT SET		A40	DISTRIBUTOR CAP		A50	ROTOR		A70	PICK-UP	
C10	COIL		C20	IGNITION MODULE		C30	ELECTRONIC IGNITION KIT		E01	IGNITION CABLE SET				

					FUNCTIONS ON THE VEHICLE							
Vehicle	alim.	kW	Date	Engine	 A10	 A20	 A40	 A50	 A70	 C10 - C30	 C20	 E01
ENGINE												
2.0 i 16V 4x4	Petrol	100	02/94-07/97	X 20 XEV								
Engine	Information				A10	A20	A40	A50	A70	C10 - C30	C20	E01
All engines	ch. 14195307 ->											1.501.506
All engines	->ch. 14195306											1.501.562
ENGINE												
2.0 i 16V 4x4	Petrol	110	06/90-02/94	C 20 XE								
Engine	Information				A10	A20	A40	A50	A70	C10 - C30	C20	E01
All engines	version Bosch						1.306.251	1.406.121R				
All engines	ch. P1000001, P9000001 ->									1.970.273	C10	1.500.688
ENGINE												
2.0 i 4x4	Petrol	85	06/90-07/97	C 20 NE								
Engine	Information				A10	A20	A40	A50	A70	C10 - C30	C20	E01
All engines	version Bosch						1.306.257	1.406.127R				
All engines	version Ducellier						1.315.084	1.415.103R				
All engines	->eng. 14180385, info WY									1.970.191	C10	
All engines	eng. type 14180386 ->, info WE									1.970.192	C10	
All engines	eng. type 14672353 ->, ->ch. R1..., R9..., no specific info conc. application available											1.500.689
ENGINE												
2.0 i Turbo 4x4	Petrol	150	08/91-07/97	C 20 LET								
Engine	Information				A10	A20	A40	A50	A70	C10 - C30	C20	E01
All engines	version Bosch						1.306.257	1.406.121R				
CAMPO												
ENGINE												
2.3	Petrol	72	08/94-09/96	23 P								
Engine	Information				A10	A20	A40	A50	A70	C10 - C30	C20	E01
All engines	version Denso						1.313.254					
All engines	version Hitachi						1.322.060					
All engines	01/07/94 ->, version Hitachi							1.422.069				
CASCADE												
ENGINE												
1.4	Petrol	88	03/13->	A 14 NEL, B 14 NEL								
Engine	Information				A10	A20	A40	A50	A70	C10 - C30	C20	E01
All engines	x 1, COIL ON RAIL									1.970.547	C10	
Eng. B 14 NEL										1.970.547	C10	
ENGINE												
1.4 Turbo	Petrol	103	03/13->	A 14 NET, B 14 NET								
Engine	Information				A10	A20	A40	A50	A70	C10 - C30	C20	E01
All engines	x 1, COIL ON RAIL									1.970.547	C10	
Eng. B 14 NET										1.970.547	C10	
COMBO B												
ENGINE												
1.2	Petrol	33	07/94-10/01	C 12 NZ, X 12 SZ								
Engine	Information				A10	A20	A40	A50	A70	C10 - C30	C20	E01
Eng. C 12 NZ	version Bosch						1.306.256	1.406.121R				
Eng. C 12 NZ	version Lucas						1.328.100	1.428.028R				
Eng. C 12 NZ										1.970.140	C10	1.965.036
All engines	ch. 19019894 ->, ->ch. 19334654											1.499.195
All engines	ch. 19334657 ->											1.499.199
All engines	->ch. 19019893											1.501.237
ENGINE												
1.4	Petrol	44	07/94-10/01	C 14 NZ, X 14 SZ								
Engine	Information				A10	A20	A40	A50	A70	C10 - C30	C20	E01
Eng. C 14 NZ	version Bosch						1.306.256	1.406.121R				
Eng. C 14 NZ	version Lucas						1.328.100	1.428.028R				
Eng. C 14 NZ										1.970.140	C10	1.965.036
Eng. C 14 NZ	->ch. 02BF1475, 19241622											1.499.195
Eng. C 14 NZ	ch. 02BF1476, 19241623 ->, -air conditioning											1.499.199
Eng. C 14 NZ	ch. 02BF1476, 19241623 ->, +air conditioning											1.501.529
Eng. X 14 SZ	ch. 02HY3580 ->											1.501.904

A10 CONDENSER	A20 CONTACT SET	A40 DISTRIBUTOR CAP	A50 ROTOR	A70 PICK-UP
C10 COIL	C20 IGNITION MODULE	C30 ELECTRONIC IGNITION KIT	E01 IGNITION CABLE SET	

Vehicle	alim.	kW	Date	Engine	FUNCTIONS ON THE VEHICLE									
					A10	A20	A40	A50	A70	C10 - C30	C20	E01		
ENGINE														
1.4	Petrol	60	07/94-10/01	C 14 SE										
Engine					A10	A20	A40	A50	A70	C10 - C30	C20	E01		
All engines													1.500.634	
All engines													1.501.904	
ENGINE														
1.4 16V	Petrol	66	08/99-10/01	X 14 XE										
Engine					A10	A20	A40	A50	A70	C10 - C30	C20	E01		
All engines													1.500.688	
All engines													1.501.559	
COMBO C														
ENGINE														
1.4	Petrol	66	10/04-12/11	Z 14 XEP										
Engine					A10	A20	A40	A50	A70	C10 - C30	C20	E01		
All engines										1.970.400	C10			
ENGINE														
1.4 16V	Petrol	66	08/05->	Z 14 XEP										
Engine					A10	A20	A40	A50	A70	C10 - C30	C20	E01		
All engines										1.970.400	C10			
ENGINE														
1.6	Petrol	64	10/01->	Z 16 SE										
Engine					A10	A20	A40	A50	A70	C10 - C30	C20	E01		
All engines													1.501.904	
ENGINE														
1.6 CNG	Petrol/ Com- pressed Natural Gas (CNG)	69	06/06-12/11	Y 16 YNG, Z 16 YNG										
Engine					A10	A20	A40	A50	A70	C10 - C30	C20	E01		
All engines										1.970.399	C10			
ENGINE														
1.6 CNG	Petrol/ Com- pressed Natural Gas (CNG)	71	04/05-01/11	Z 16 YNG										
Engine					A10	A20	A40	A50	A70	C10 - C30	C20	E01		
All engines										1.970.399	C10			
ENGINE														
1.6 CNG 16V	Petrol/ Com- pressed Natural Gas (CNG)	69	06/06->	Y 16 YNG, Z 16 YNG										
Engine					A10	A20	A40	A50	A70	C10 - C30	C20	E01		
All engines										1.970.399	C10			
ENGINE														
1.6 CNG 16V	Petrol/ Com- pressed Natural Gas (CNG)	71	04/05->	Z 16 YNG										
Engine					A10	A20	A40	A50	A70	C10 - C30	C20	E01		
All engines										1.970.399	C10			
COMBO D														
ENGINE														
1.4	Petrol	70	02/12->	A 14 FP										
Engine					A10	A20	A40	A50	A70	C10 - C30	C20	E01		
All engines										1.970.442	C10			
COMBO A														
ENGINE														
1.0	Petrol	33	09/82-03/93	10 S										
Engine					A10	A20	A40	A50	A70	C10 - C30	C20	E01		
All engines					1.106.212	1.206.034HVS	1.306.080	1.406.012R						
A10	CONDENSER	A20	CONTACT SET	A40	DISTRIBUTOR CAP	A50	ROTOR	A70	PICK-UP					
C10	COIL	C20	IGNITION MODULE	C30	ELECTRONIC IGNITION KIT	E01	IGNITION CABLE SET							

					FUNCTIONS ON THE VEHICLE							
Vehicle	alim.	kW	Date	Engine								
					A10	A20	A40	A50	A70	C10 - C30	C20	E01

CORSA A

				ENGINE
1.0	Petrol	33	09/82-03/93	10 S

Engine	Information	A10	A20	A40	A50	A70	C10 - C30	C20	E01
All engines	version Delco Remy		1.212.055HVS	1.312.066	1.412.095R				
All engines					1.412.093R				1.500.509

				ENGINE
1.2	Petrol	33	09/82-08/90	12 N, 12 NC, E 12 GV

Engine	Information	A10	A20	A40	A50	A70	C10 - C30	C20	E01
Eng. 12 N, 12 NC	version Bosch	1.106.212	1.206.034HVS		1.406.012R				
All engines	->eng. 0106700, version Bosch			1.306.080					
Eng. 12 NC, E 12 GV	eng. type 0106701 ->, version Bosch			1.306.256					
Eng. E 12 GV	version Bosch				1.406.061R				
Eng. 12 NC, E 12 GV								1.965.005	
All engines	->ch. J4999999								1.500.509

				ENGINE
1.2	Petrol	40	02/86-04/89	12 ST

Engine	Information	A10	A20	A40	A50	A70	C10 - C30	C20	E01
All engines	version Delco Remy			1.312.073	1.412.096	1.912.011			
All engines	FOR: (S), ch. F4178159 ->, FOR: (CH), version Delco Remy				1.412.100				
All engines							1.970.341	C10	

				ENGINE
1.2	Petrol	44	09/82-08/90	12 S

Engine	Information	A10	A20	A40	A50	A70	C10 - C30	C20	E01
All engines	version Delco Remy			1.312.073	1.412.096	1.912.011			
All engines	FOR: (S), ->year 23/09/84, FOR: (CH), version Delco Remy			1.312.074					
All engines	FOR: (S), ch. F4178159 ->, FOR: (CH), version Delco Remy				1.412.100				
All engines							1.970.341	C10	

				ENGINE
1.2 i	Petrol	33	09/89-03/93	C 12 NZ

Engine	Information	A10	A20	A40	A50	A70	C10 - C30	C20	E01
All engines	version Bosch			1.306.256	1.406.121R				
All engines	version Lucas			1.328.100	1.428.028R	1.928.202			
All engines							1.970.140	C10	1.965.036
									1.501.237

				ENGINE
1.2 N	Petrol	33	01/85-10/87	12 NC, E 12 GV

Engine	Information	A10	A20	A40	A50	A70	C10 - C30	C20	E01
Eng. 12 NC	version Bosch	1.106.212	1.206.034HVS		1.406.012R				
All engines	->eng. 0106700, version Bosch			1.306.080					
All engines	eng. type 0106701 ->, version Bosch			1.306.256					
Eng. E 12 GV	version Bosch				1.406.061R				
All engines								1.965.005	
All engines	->ch. J4999999								1.500.509

				ENGINE
1.2 N	Petrol	38	01/90-03/93	12 NV

Engine	Information	A10	A20	A40	A50	A70	C10 - C30	C20	E01
All engines	version Delco Remy			1.312.073	1.412.096	1.912.011			
All engines	FOR: (S), ch. F4178159 ->, FOR: (CH), version Delco Remy				1.412.100				
All engines							1.970.341	C10	

				ENGINE
1.2 S	Petrol	40	09/82-03/93	12 ST

Engine	Information	A10	A20	A40	A50	A70	C10 - C30	C20	E01
All engines	version Delco Remy			1.312.073	1.412.096	1.912.011			
All engines	FOR: (S), ch. F4178159 ->, FOR: (CH), version Delco Remy				1.412.100				
All engines							1.970.341	C10	

				ENGINE
1.2 S	Petrol	43	09/82-10/87	12 S

Engine	Information	A10	A20	A40	A50	A70	C10 - C30	C20	E01
All engines	version Delco Remy			1.312.073	1.412.096	1.912.011			
All engines	FOR: (S), ->year 23/09/84, FOR: (CH), version Delco Remy			1.312.074					

A10	CONDENSER	A20	CONTACT SET	A40	DISTRIBUTOR CAP	A50	ROTOR	A70	PICK-UP
C10	COIL	C20	IGNITION MODULE	C30	ELECTRONIC IGNITION KIT	E01	IGNITION CABLE SET		

Vehicle	alim.	kW	Date	Engine	FUNCTIONS ON THE VEHICLE									
					A10	A20	A40	A50	A70	C10 - C30	C20	E01		
ENGINE														
1.2 S	Petrol	43	09/82-10/87	12 S										
Engine	Information				A10	A20	A40	A50	A70	C10 - C30	C20	E01		
All engines	FOR: (S), ch. F4178159 ->, FOR: (CH), version Delco Remy							1.412.100						
All engines										1.970.341	C10			
ENGINE														
1.3	Petrol	44	09/85-10/89	13 NB, C13 N										
Engine	Information				A10	A20	A40	A50	A70	C10 - C30	C20	E01		
Eng. 13 NB	24/09/84 ->, version Delco Remy						1.312.073							
Eng. 13 NB	->year 23/09/84, version Delco Remy						1.312.074							
Eng. 13 NB	version Delco Remy							1.412.100	1.912.011					
Eng. C13 N	version Delco Remy								1.912.010					
All engines										1.970.341	C10			
Eng. C13 N												1.965.025		
ENGINE														
1.3	Petrol	51	02/86-04/89	13 SB										
Engine	Information				A10	A20	A40	A50	A70	C10 - C30	C20	E01		
All engines	version Delco Remy						1.312.073	1.412.096	1.912.011					
All engines										1.970.341	C10			
ENGINE														
1.3 GL	Petrol	55	09/82-03/93	13 S										
Engine	Information				A10	A20	A40	A50	A70	C10 - C30	C20	E01		
All engines	version Delco Remy						1.312.073	1.412.096	1.912.011					
All engines										1.970.341	C10			
ENGINE														
1.3 i	Petrol	44	09/86-09/90	C13 N										
Engine	Information				A10	A20	A40	A50	A70	C10 - C30	C20	E01		
All engines	version Delco Remy								1.912.010					
All engines										1.970.341	C10	1.965.025		
ENGINE														
1.3 S	Petrol	51	09/82-10/89	13 SB										
Engine	Information				A10	A20	A40	A50	A70	C10 - C30	C20	E01		
All engines	version Delco Remy						1.312.073	1.412.096	1.912.011					
All engines										1.970.341	C10			
ENGINE														
1.4 i	Petrol	40	01/85-03/93	C14 NZ										
Engine	Information				A10	A20	A40	A50	A70	C10 - C30	C20	E01		
All engines	version Bosch						1.306.249	1.406.121R						
All engines										1.970.140	C10	1.965.036	1.501.237	
ENGINE														
1.4 i	Petrol	44	10/89-03/93	C14 NZ										
Engine	Information				A10	A20	A40	A50	A70	C10 - C30	C20	E01		
All engines	version Bosch						1.306.249	1.406.121R						
All engines										1.970.140	C10	1.965.036	1.501.237	
ENGINE														
1.4 S	Petrol	53	09/89-03/93	14 NV										
Engine	Information				A10	A20	A40	A50	A70	C10 - C30	C20	E01		
All engines	version Bosch						1.306.256	1.406.056R						
All engines												1.965.005	1.501.237	
ENGINE														
1.4 Si	Petrol	60	09/91-03/93	C14 SE										
Engine	Information				A10	A20	A40	A50	A70	C10 - C30	C20	E01		
All engines	->eng. 02T14052, version Lucas						1.328.100	1.428.028R						
All engines	->eng. 02T14052									1.970.140	C10	1.965.036	1.501.237	
All engines	eng. type 02T14053 ->												1.500.634	
ENGINE														
1.6 GSI	Petrol	55	08/88-09/92	C16 NZ										
Engine	Information				A10	A20	A40	A50	A70	C10 - C30	C20	E01		
All engines	version Delco Remy								1.912.010					
All engines										1.970.341	C10		1.500.514	

A10	CONDENSER	A20	CONTACT SET	A40	DISTRIBUTOR CAP	A50	ROTOR	A70	PICK-UP
C10	COIL	C20	IGNITION MODULE	C30	ELECTRONIC IGNITION KIT	E01	IGNITION CABLE SET		

The present application list is a brief version. For the detailed information about the possibility of installation on a specific vehicle, please refer to our web-catalogue <http://catalogo.facet.eu/>

Vehicle	alim.	kW	Date	Engine	FUNCTIONS ON THE VEHICLE							
					A10	A20	A40	A50	A70	C10 - C30	C20	E01

				ENGINE
1.6 GSI	Petrol	74	05/88-03/92	E 16 SE

Engine	Information	A10	A20	A40	A50	A70	C10 - C30	C20	E01
All engines	distr. num. 0 237 506 012, version Bosch			1.306.080	1.406.056R				
All engines	distr. num. 0 237 521 024, version Bosch, connector type SAE			1.306.249					
All engines	distr. num. 0 237 521 024, version Bosch, connector type M4			1.306.256					
All engines	version Lucas			1.328.100	1.428.028R	1.928.202			
All engines	distr. num. 0 237 521 024, version Bosch				1.406.121R				
All engines	ch. L4000001 ->						1.970.140	C10	1.965.036

CORSA B				ENGINE
1.0 i 12V	Petrol	40	11/96-09/00	X 10 XE

Engine	Information	A10	A20	A40	A50	A70	C10 - C30	C20	E01
All engines							1.970.398	C10	

				ENGINE
1.2 i	Petrol	33	03/93-09/00	12 NZ, C 12 NZ, X 12 SZ

Engine	Information	A10	A20	A40	A50	A70	C10 - C30	C20	E01
Eng. 12 NZ, C 12 NZ	version Bosch			1.306.256	1.406.121R				
Eng. 12 NZ, C 12 NZ	version Lucas			1.328.100	1.428.028R				
Eng. 12 NZ, C 12 NZ							1.970.140	C10	1.965.036
All engines	ch. 19019894 ->, ->ch. 19334654								1.499.195
All engines	ch. 19334657 ->								1.499.199
All engines	->ch. 19019893								1.501.237

				ENGINE
1.2 i 16V	Petrol	48	03/98-09/00	X 12 XE

Engine	Information	A10	A20	A40	A50	A70	C10 - C30	C20	E01
All engines							1.970.400	C10	

				ENGINE
1.4	Petrol	54	04/93-08/94	C 14 SE

Engine	Information	A10	A20	A40	A50	A70	C10 - C30	C20	E01
All engines	->ch. 02BD1412, 19262000								1.500.634
All engines	ch. 02HY3580 ->								1.501.904

				ENGINE
1.4 i	Petrol	40	03/93-09/00	C 14 NZ, X 14 SZ

Engine	Information	A10	A20	A40	A50	A70	C10 - C30	C20	E01
Eng. C 14 NZ	version Bosch			1.306.256	1.406.121R				
Eng. C 14 NZ	version Lucas			1.328.100	1.428.028R				
Eng. C 14 NZ							1.970.140	C10	1.965.036
Eng. C 14 NZ	->ch. 02BF1475, 19241622								1.499.195
Eng. C 14 NZ	ch. 02BF1476, 19241623 ->, -air conditioning								1.499.199
Eng. C 14 NZ	ch. 02BF1476, 19241623 ->, +air conditioning								1.501.529
Eng. X 14 SZ	ch. 02HY3580 ->								1.501.904

				ENGINE
1.4 i	Petrol	44	03/93-09/00	C 14 NZ, X 14 SZ

Engine	Information	A10	A20	A40	A50	A70	C10 - C30	C20	E01
Eng. C 14 NZ	version Bosch			1.306.256	1.406.121R				
Eng. C 14 NZ	version Lucas			1.328.100	1.428.028R				
Eng. C 14 NZ							1.970.140	C10	1.965.036
Eng. C 14 NZ	->ch. 02BF1475, 19241622								1.499.195
Eng. C 14 NZ	ch. 02BF1476, 19241623 ->, -air conditioning								1.499.199
Eng. C 14 NZ	ch. 02BF1476, 19241623 ->, +air conditioning								1.501.529
Eng. X 14 SZ	ch. 02HY3580 ->								1.501.904

				ENGINE
1.4 i 16V	Petrol	63	08/97-09/00	C 14 SEL

Engine	Information	A10	A20	A40	A50	A70	C10 - C30	C20	E01
All engines	->ch. 20C17331								1.500.688
All engines	ch. 20C17332 ->								1.501.559

				ENGINE
1.4 i 16V	Petrol	66	09/94-12/02	X 14 XE









Engine	Information	A10	A20	A40	A50	A70	C10 - C30	C20	E01
All engines	->ch. 20C17331								1.500.688
All engines	ch. 20C17332 ->								1.501.559

A10	CONDENSER	A20	CONTACT SET	A40	DISTRIBUTOR CAP	A50	ROTOR	A70	PICK-UP
C10	COIL	C20	IGNITION MODULE	C30	ELECTRONIC IGNITION KIT	E01	IGNITION CABLE SET		

Vehicle	alim.	kW	Date	Engine	FUNCTIONS ON THE VEHICLE									
					A10	A20	A40	A50	A70	C10 - C30	C20	E01		
ENGINE														
1.4 i 16V	Petrol	67	09/94-09/00	X 14 XE										
Engine	Information				A10	A20	A40	A50	A70	C10 - C30	C20	E01		
All engines	->ch. 20C17331												1.500.688	
All engines	ch. 20C17332 ->												1.501.559	
ENGINE														
1.4 Si	Petrol	60	03/93-09/00	C 14 SE										
Engine	Information				A10	A20	A40	A50	A70	C10 - C30	C20	E01		
All engines	->ch. 02BD1412, 19262000												1.500.634	
All engines	ch. 02HY3580 ->												1.501.904	
ENGINE														
1.6 GSI 16V	Petrol	80	03/93-09/00	C 16 XE										
Engine	Information				A10	A20	A40	A50	A70	C10 - C30	C20	E01		
All engines	->ch. 20C17331												1.500.688	
All engines	ch. 20C17332 ->												1.501.559	
ENGINE														
1.6 i 16V	Petrol	74	08/97-09/00	C 16 SEL										
Engine	Information				A10	A20	A40	A50	A70	C10 - C30	C20	E01		
All engines	->ch. 20C17331												1.500.688	
All engines	ch. 20C17332 ->												1.501.559	
ENGINE														
1.6 i 16V	Petrol	78	09/94-09/00	X 16 XE										
Engine	Information				A10	A20	A40	A50	A70	C10 - C30	C20	E01		
All engines	->ch. 20C17331												1.500.688	
All engines	ch. 20C17332 ->												1.501.559	
CORSA C														
ENGINE														
1.0	Petrol	43	09/00-06/03	1K10CT										
Engine	Information				A10	A20	A40	A50	A70	C10 - C30	C20	E01		
All engines	x 3, BOSCH, COIL ON PLUG									1.970.398	C10			
ENGINE														
1.0	Petrol	44	06/03-12/09	Z 10 XEP										
Engine	Information				A10	A20	A40	A50	A70	C10 - C30	C20	E01		
All engines	x 3, BOSCH, COIL ON PLUG, 12 Volt, Dia: 55 mm, for pre-resistance									1.970.398	C10			
ENGINE														
1.2	Petrol	55	09/00-12/09	Z 12 XE										
Engine	Information				A10	A20	A40	A50	A70	C10 - C30	C20	E01		
All engines	->ch. 36999999, ch. 37000000 ->, x 1, x 4, BOSCH, COIL ON PLUG, incl. spark plug connector									1.970.400	C10			
ENGINE														
1.2	Petrol	59	07/05-06/06	Z 12 XEP										
Engine	Information				A10	A20	A40	A50	A70	C10 - C30	C20	E01		
All engines	x 1, BOSCH, COIL ON PLUG, incl. spark plug connector									1.970.400	C10			
ENGINE														
1.2 16V	Petrol	55	09/00-07/03	Z 12 XE										
Engine	Information				A10	A20	A40	A50	A70	C10 - C30	C20	E01		
All engines	->ch. 36999999, ch. 37000000 ->, x 1, x 4, BOSCH, COIL ON PLUG, incl. spark plug connector									1.970.400	C10			
ENGINE														
1.2 Twinport	Petrol	59	07/04-12/09	Z 12 XEP										
Engine	Information				A10	A20	A40	A50	A70	C10 - C30	C20	E01		
All engines	x 1, BOSCH, COIL ON PLUG, incl. spark plug connector									1.970.400	C10			
ENGINE														
1.4	Petrol	66	09/00-06/12	Z 14 XE, Z 14 XEP										
Engine	Information				A10	A20	A40	A50	A70	C10 - C30	C20	E01		
Eng. Z 14 XE	x 4, COIL ON PLUG, incl. spark plug connector									1.970.399	C10			
Eng. Z 14 XEP	x 1, BOSCH, COIL ON PLUG, incl. spark plug connector									1.970.400	C10			
ENGINE														
1.4 Twinport	Petrol	66	06/03-12/09	Z 14 XEP										
Engine	Information				A10	A20	A40	A50	A70	C10 - C30	C20	E01		
All engines	x 1, BOSCH, COIL ON PLUG, incl. spark plug connector									1.970.400	C10			

A10	CONDENSER	A20	CONTACT SET	A40	DISTRIBUTOR CAP	A50	ROTOR	A70	PICK-UP
C10	COIL	C20	IGNITION MODULE	C30	ELECTRONIC IGNITION KIT	E01	IGNITION CABLE SET		

The present application list is a brief version. For the detailed information about the possibility of installation on a specific vehicle, please refer to our web-catalogue <http://catalogo.facet.eu/>









					FUNCTIONS ON THE VEHICLE								
Vehicle	alim.	kW	Date	Engine									
ENGINE													
1.6	Petrol	62	09/00->	Z 16 SE									
ENGINE													
All engines												1.501.904	
ENGINE													
1.6 CNG	CNG	69	05/03-12/09	Y 16 YNG									
ENGINE													
All engines										1.970.399	C10		
ENGINE													
1.6 X	Petrol	71	08/05->	Z 16 YNG									
ENGINE													
All engines										1.970.399	C10		
ENGINE													
1.8	Petrol	92	09/00-12/09	Z 18 XE									
ENGINE													
All engines					x 1, COIL ON PLUG, incl. spark plug connector						1.970.508	C10	
CORSA D													
ENGINE													
1.0	Petrol	44	07/06-08/14	Z 10 XEP									
ENGINE													
All engines					x 3, BOSCH, COIL ON PLUG, 12 Volt, Dia: 55 mm, for pre-resistance						1.970.398	C10	
ENGINE													
1.2	Petrol	51	12/09-08/14	A 12 XEL									
ENGINE													
All engines					x 1, COIL ON RAIL						1.970.547	C10	
ENGINE													
1.2	Petrol	59	07/06-08/14	Z 12 XEP									
ENGINE													
All engines					x 1, BOSCH, COIL ON PLUG, incl. spark plug connector						1.970.400	C10	
ENGINE													
1.2	Petrol	63	12/09-08/14	A 12 XER									
ENGINE													
All engines					x 1, COIL ON RAIL						1.970.547	C10	
ENGINE													
1.2 LPG	Petrol/ Liquified Petro- leum Gas (LPG)	55	09/09-12/11	Z 12 XEP									
ENGINE													
All engines					x 1, BOSCH, COIL ON PLUG, incl. spark plug connector						1.970.400	C10	
ENGINE													
1.2 LPG	Petrol/ Liquified Petro- leum Gas (LPG)	59	08/06-08/14	Z 12 XEP									
ENGINE													
All engines					x 1, BOSCH, COIL ON PLUG, incl. spark plug connector						1.970.400	C10	
ENGINE													
1.2 LPG	Petrol/ Liquified Petro- leum Gas (LPG)	61	06/11-08/14	A 12 XER									
ENGINE													
All engines					x 1, COIL ON RAIL						1.970.547	C10	
ENGINE													
1.2 LPG	Petrol/ Liquified Petro- leum Gas (LPG)	63	06/11-08/14	A 12 XER									
ENGINE													
All engines					x 1, COIL ON RAIL						1.970.547	C10	

A10 CONDENSER	A20 CONTACT SET	A40 DISTRIBUTOR CAP	A50 ROTOR	A70 PICK-UP
C10 COIL	C20 IGNITION MODULE	C30 ELECTRONIC IGNITION KIT	E01 IGNITION CABLE SET	

Vehicle	alim.	kW	Date	Engine	FUNCTIONS ON THE VEHICLE									
					A10	A20	A40	A50	A70	C10 - C30	C20	E01		
ENGINE														
1.4	Petrol	64	09/09-08/14	A 14 XEL										
ENGINE														
All engines					x 1, COIL ON RAIL						1.970.547	C10		
ENGINE														
1.4	Petrol	66	07/06-08/14	Z 14 XEP										
ENGINE														
All engines					x 1, BOSCH, COIL ON PLUG, incl. spark plug connector						1.970.400	C10		
ENGINE														
1.4	Petrol	74	12/09-08/14	A 14 XER										
ENGINE														
All engines					x 1, COIL ON RAIL						1.970.547	C10		
ENGINE														
1.4	Petrol	88	07/12-08/14	A 14 NEL										
ENGINE														
All engines					x 1, COIL ON RAIL						1.970.547	C10		
ENGINE														
1.4 LPG	Petrol/ Liquified Petro- leum Gas (LPG)	64	09/09-08/14	A 14 XEL										
ENGINE														
All engines					x 1, COIL ON RAIL						1.970.547	C10		
ENGINE														
1.4 LPG	Petrol/ Liquified Petro- leum Gas (LPG)	66	08/06-12/11	Z 14 XEP										
ENGINE														
All engines					x 1, BOSCH, COIL ON PLUG, incl. spark plug connector						1.970.400	C10		
ENGINE														
1.6	Petrol	141	07/12-08/14	Z 16 LER										
ENGINE														
All engines					x 1, DELPHI, COIL ON PLUG, incl. spark plug connector						1.970.450	C10		
ENGINE														
1.6 Turbo	Petrol	110	05/07-08/14	A 16 LEL, Z 16 LEL										
ENGINE														
All engines					x 1, DELPHI, COIL ON PLUG, incl. spark plug connector						1.970.450	C10		
ENGINE														
1.6 Turbo	Petrol	141	11/06-08/14	A 16 LER, B 16 LER, Z 16 LER										
ENGINE														
All engines					x 1, DELPHI, COIL ON PLUG, incl. spark plug connector						1.970.450	C10		
ENGINE														
1.6 Turbo	Petrol	155	06/11-08/14	A 16 LES										
ENGINE														
All engines					x 1, DELPHI, COIL ON PLUG, incl. spark plug connector						1.970.450	C10		
CORSA E														
ENGINE														
1.0	Petrol	66	09/14->	B 10 XFL, D 10 XFL, F 10 XFL										
ENGINE														
All engines					x 3, COIL ON PLUG						1.970.631	C10		
ENGINE														
1.0	Petrol	85	09/14->	B 10 XFT										
ENGINE														
All engines					x 3, COIL ON PLUG						1.970.631	C10		
ENGINE														
1.2	Petrol	51	09/14->	B 12 XEL										
ENGINE														
All engines					x 1, COIL ON RAIL						1.970.547	C10		

A10 CONDENSER	A20 CONTACT SET	A40 DISTRIBUTOR CAP	A50 ROTOR	A70 PICK-UP
C10 COIL	C20 IGNITION MODULE	C30 ELECTRONIC IGNITION KIT	E01 IGNITION CABLE SET	

The present application list is a brief version. For the detailed information about the possibility of installation on a specific vehicle, please refer to our web-catalogue <http://catalogo.facet.eu/>

					FUNCTIONS ON THE VEHICLE												
Vehicle	alim.	kW	Date	Engine													
ENGINE																	
1.4	Petrol	55	09/14->	B 14 XEJ													
ENGINE																	
All engines					x 1, COIL ON RAIL					1.970.547	C10						
ENGINE																	
1.4	Petrol	66	09/14->	B 14 XEL, D 14 XEL													
ENGINE																	
All engines					x 1, COIL ON RAIL					1.970.547	C10						
ENGINE																	
1.4 LPG	Petrol/ Liquified Petro- leum Gas (LPG)	64	11/15->	B 14 XEL													
ENGINE																	
All engines					x 1, COIL ON RAIL					1.970.547	C10						
ENGINE																	
1.4 LPG	Petrol/ Liquified Petro- leum Gas (LPG)	66	03/15->	B 14 XEL													
ENGINE																	
All engines					x 1, COIL ON RAIL					1.970.547	C10						
ENGINE																	
1.4 Turbo	Petrol	110	03/15->	B 14 NEH, D 14 NEH													
ENGINE																	
All engines					x 1, COIL ON RAIL					1.970.547	C10						
ENGINE																	
1.4 Turbo	Petrol	74	09/14-06/19	B 14 NEJ, D 14 NEJ													
ENGINE																	
All engines					x 1, COIL ON RAIL					1.970.547	C10						
ENGINE																	
1.6 Turbo	Petrol	152	03/15->	B 16 LER, B 16 LES													
ENGINE																	
All engines					x 1, COIL ON PLUG					1.970.545	C10						
CORSA F																	
ENGINE																	
1.2	Petrol	55	07/19->	F 12 XEL (EB2FAD)													
ENGINE																	
All engines					x 3, COIL ON PLUG					1.970.609	C10						
CROSSLAND X																	
ENGINE																	
1.2	Petrol	61	07/19->	F 12 XE (EB2FA)													
ENGINE																	
All engines					x 3, COIL ON PLUG					1.970.609	C10						
FRONTERA A																	
ENGINE																	
2.0 i	Petrol	85	03/92-10/98	C 20 NE, X 20 SE													
ENGINE																	
Eng. C 20 NE					version Bosch			1.306.257	1.406.127R								
Eng. C 20 NE					version Ducellier			1.315.084	1.415.103R								
Eng. C 20 NE										1.970.192	C10						
Eng. X 20 SE										1.970.273	C10	1.501.947					
Eng. C 20 NE					->eng. 14672353							1.500.527					
Eng. C 20 NE					eng. type 14672354 ->							1.500.689					
ENGINE																	
2.2 i	Petrol	100	03/95-10/98	X 22 XE													
ENGINE																	
All engines										1.970.273	C10						
ENGINE																	
2.4 i	Petrol	92	03/92-10/98	C 24 NE													
ENGINE																	
All engines					version Bosch			1.306.256	1.406.121R								
All engines										1.970.192	C10						
A10	CONDENSER	A20	CONTACT SET	A40	DISTRIBUTOR CAP	A50	ROTOR	A70	PICK-UP	C10	COIL	C20	IGNITION MODULE	C30	ELECTRONIC IGNITION KIT	E01	IGNITION CABLE SET

Vehicle	alim.	kW	Date	Engine	FUNCTIONS ON THE VEHICLE							
					A10	A20	A40	A50	A70	C10 - C30	C20	E01

GRANDLAND / GRANDLAND X

				ENGINE
1.2	Petrol	96	06/17->	B 12 XHT (EB2DTS)

Engine	Information	A10	A20	A40	A50	A70	C10 - C30	C20	E01
All engines	x 3, COIL ON PLUG						1.970.620	C10	

				ENGINE
1.6 Turbo	Petrol	110	12/19->	A 16 XHL (EP6FDTMD)

Engine	Information	A10	A20	A40	A50	A70	C10 - C30	C20	E01
All engines	x 4, COIL ON PLUG						1.970.475	C10	

				ENGINE
1.6 Turbo	Petrol	133	09/18->	D 16 XHT (EP6FADTXD)

Engine	Information	A10	A20	A40	A50	A70	C10 - C30	C20	E01
All engines	x 4, COIL ON PLUG						1.970.475	C10	

				ENGINE
1.6 Turbo Hybrid	Petrol/ Electric	133	12/19->	F 16 XHR (EP6FADTXD)

Engine	Information	A10	A20	A40	A50	A70	C10 - C30	C20	E01
All engines	x 4, COIL ON PLUG						1.970.475	C10	

				ENGINE
1.6 Turbo Hybrid	Petrol/ Electric	165	12/19->	F 16 XHR (EP6FADTXD)

Engine	Information	A10	A20	A40	A50	A70	C10 - C30	C20	E01
All engines	x 4, COIL ON PLUG						1.970.475	C10	

				ENGINE
1.6 Turbo Hybrid4	Petrol/ Electric	147	06/19->	F 16 XHR (EP6FADTXD)

Engine	Information	A10	A20	A40	A50	A70	C10 - C30	C20	E01
All engines	x 4, COIL ON PLUG						1.970.475	C10	

				ENGINE
1.6 Turbo Hybrid4	Petrol/ Electric	221	06/19->	F 16 XHR (EP6FADTXD)

Engine	Information	A10	A20	A40	A50	A70	C10 - C30	C20	E01
All engines	x 4, COIL ON PLUG						1.970.475	C10	

GT

				ENGINE
1.1	Petrol	44	09/68-12/70	11 SR

Engine	Information	A10	A20	A40	A50	A70	C10 - C30	C20	E01
All engines				1.306.062					
All engines	version BOSCH			1.306.076					

				ENGINE
1.9	Petrol	66	09/68-08/73	19 S

Engine	Information	A10	A20	A40	A50	A70	C10 - C30	C20	E01
All engines	version BOSCH			1.306.076					

INSIGNIA A

				ENGINE
1.4	Petrol	103	04/11->	A 14 NET, B 14 NET, B 18 XER

Engine	Information	A10	A20	A40	A50	A70	C10 - C30	C20	E01
Eng. B 18 XER							1.970.545	C10	
Eng. A 14 NET, B 14 NET	x 1, COIL ON RAIL						1.970.547	C10	

				ENGINE
1.4 LPG	Petrol/ Liquified Petroleum Gas (LPG)	103	07/12-03/17	A 14 NET, B 14 NET

Engine	Information	A10	A20	A40	A50	A70	C10 - C30	C20	E01
All engines	x 1, COIL ON RAIL						1.970.547	C10	

				ENGINE
1.6	Petrol	85	07/08-03/17	A 16 XER

Engine	Information	A10	A20	A40	A50	A70	C10 - C30	C20	E01
All engines	x 1, COIL ON PLUG						1.970.545	C10	

A10 CONDENSER	A20 CONTACT SET	A40 DISTRIBUTOR CAP	A50 ROTOR	A70 PICK-UP
C10 COIL	C20 IGNITION MODULE	C30 ELECTRONIC IGNITION KIT	E01 IGNITION CABLE SET	

Vehicle	alim.	kW	Date	Engine	FUNCTIONS ON THE VEHICLE							
					A10	A20	A40	A50	A70	C10 - C30	C20	E01

1.6 Turbo				ENGINE
Petrol	132	07/08-03/17		A 16 LET

Engine	Information	A10	A20	A40	A50	A70	C10 - C30	C20	E01
All engines	x 1, DELPHI, COIL ON PLUG, incl. spark plug connector						1.970.450	C10	

1.8				ENGINE
Petrol	103	07/08-03/17		A 18 XER, B 18 XER

Engine	Information	A10	A20	A40	A50	A70	C10 - C30	C20	E01
All engines	x 1, COIL ON PLUG						1.970.545	C10	

INSIGNIA B				ENGINE
Petrol	103	03/17->		B 15 SFL, D 15 SFL

Engine	Information	A10	A20	A40	A50	A70	C10 - C30	C20	E01
All engines	x 4, COIL ON PLUG						1.970.631	C10	

1.5				ENGINE
Petrol	121	03/17->		B 15 SFT, D 15 SFT

Engine	Information	A10	A20	A40	A50	A70	C10 - C30	C20	E01
All engines	x 4, COIL ON PLUG						1.970.631	C10	

KADETT B				ENGINE
Petrol	37	08/71-08/73		11 N

Engine	Information	A10	A20	A40	A50	A70	C10 - C30	C20	E01
All engines	version Bosch	1.106.212	1.206.034HVS	1.306.080	1.406.012R				
All engines	version Delco Remy		1.212.055HVS	1.312.066	1.412.093				

KADETT C				ENGINE
Petrol	38	05/75-04/77		12 N

Engine	Information	A10	A20	A40	A50	A70	C10 - C30	C20	E01
All engines					1.412.093R				

1.2				ENGINE
Petrol	40	07/76-07/79		12 N

Engine	Information	A10	A20	A40	A50	A70	C10 - C30	C20	E01
All engines					1.412.093R				

1.2 S				ENGINE
Petrol	44	08/73-07/79		12 S

Engine	Information	A10	A20	A40	A50	A70	C10 - C30	C20	E01
All engines					1.412.093R				

1.6 S				ENGINE
Petrol	55	09/76-07/79		16 S

Engine	Information	A10	A20	A40	A50	A70	C10 - C30	C20	E01
All engines					1.412.093R				

KADETT D				ENGINE
Petrol	30	09/79-08/82		10 N

Engine	Information	A10	A20	A40	A50	A70	C10 - C30	C20	E01
All engines	version Bosch	1.106.212	1.206.034HVS	1.306.080	1.406.012R				
All engines	version Delco Remy		1.212.055HVS	1.312.066	1.412.093				

1.2				ENGINE
Petrol	40	08/82-08/84		12 ST

Engine	Information	A10	A20	A40	A50	A70	C10 - C30	C20	E01
All engines	version Delco Remy			1.312.073	1.412.096	1.912.011			
All engines							1.970.341	C10	1.500.514

1.3 S				ENGINE
Petrol	55	08/79-08/84		13 S

Engine	Information	A10	A20	A40	A50	A70	C10 - C30	C20	E01
All engines	version Bosch		1.206.049HVS	1.306.099	1.406.026R				

KADETT E				ENGINE
Petrol	40	09/84-08/88		12 SC, 12 ST

Engine	Information	A10	A20	A40	A50	A70	C10 - C30	C20	E01
Eng. 12 SC	version Bosch	1.106.212	1.206.034HVS	1.306.080	1.406.012R				
Eng. 12 SC	version Delco Remy		1.212.055HVS	1.312.066	1.412.095R				
Eng. 12 SC					1.412.093R				1.500.509

A10 CONDENSER	A20 CONTACT SET	A40 DISTRIBUTOR CAP	A50 ROTOR	A70 PICK-UP
C10 COIL	C20 IGNITION MODULE	C30 ELECTRONIC IGNITION KIT	E01 IGNITION CABLE SET	

Vehicle	alim.	kW	Date	Engine	FUNCTIONS ON THE VEHICLE							
					A10	A20	A40	A50	A70	C10 - C30	C20	E01

KADETT E

				ENGINE
1.2	Petrol	40	09/84-08/88	12 SC, 12 ST

Engine	Information	A10	A20	A40	A50	A70	C10 - C30	C20	E01
Eng. 12 ST									1.500.514

				ENGINE
1.3 i Cat	Petrol	44	09/85-08/91	C 13 N

Engine	Information	A10	A20	A40	A50	A70	C10 - C30	C20	E01
All engines	version Delco Remy			1.312.073	1.412.100	1.912.010			
All engines							1.970.341	C10	1.965.025
									1.500.514

				ENGINE
1.3 N	Petrol	44	09/84-08/91	13 N, 13 NB

Engine	Information	A10	A20	A40	A50	A70	C10 - C30	C20	E01
All engines	version Delco Remy			1.312.073	1.412.096	1.912.011			
All engines	FOR: (S), FOR: (CH), version Delco Remy			1.312.074	1.412.100				
All engines							1.970.341	C10	1.500.514

				ENGINE
1.3 S	Petrol	55	09/84-02/93	13 S

Engine	Information	A10	A20	A40	A50	A70	C10 - C30	C20	E01
All engines	version Delco Remy			1.312.073	1.412.096	1.912.011			
All engines	FOR: (S), FOR: (CH), version Delco Remy			1.312.074	1.412.100				
All engines							1.970.341	C10	1.500.514

				ENGINE
1.4 i	Petrol	44	01/90-07/94	C 14 NZ

Engine	Information	A10	A20	A40	A50	A70	C10 - C30	C20	E01
All engines	connector type SAE, version Bosch			1.306.249					
All engines	connector type M4, version Bosch			1.306.256					
All engines	version Lucas			1.328.100	1.428.028R				
All engines	version Bosch				1.406.121R				
All engines							1.970.140	C10	1.965.036
									1.501.237

				ENGINE
1.4 S	Petrol	55	07/89-02/93	14 NV

Engine	Information	A10	A20	A40	A50	A70	C10 - C30	C20	E01
All engines	version Bosch			1.306.256	1.406.056R				
All engines								1.965.005	1.501.237

				ENGINE
1.6	Petrol	60	09/86-12/91	16 SV

Engine	Information	A10	A20	A40	A50	A70	C10 - C30	C20	E01
All engines	->ch. K2500000, ->ch. K5000000, ->ch. KE299999, version Bosch			1.306.249					
All engines	ch. L2500001 ->, ch. L5000001 ->, ch. LE100001 ->, version Bosch			1.306.256					
All engines	24/09/84 ->, version Delco Remy			1.312.073					
All engines	->year 23/09/84, version Delco Remy			1.312.074					
All engines	->ch. K2500000, ->ch. K5000000, ->ch. KE299999, version Lucas			1.328.099					
All engines	ch. L2500001 ->, ch. L5000001 ->, ch. LE100001 ->, version Lucas			1.328.100					
All engines	version Bosch				1.406.121R			1.965.036	
All engines	version Delco Remy				1.412.100	1.912.011			
All engines	version Lucas				1.428.028R				
All engines	info XE						1.970.140	C10	
All engines	info XF						1.970.341	C10	
All engines	->eng. 02E85672								1.500.514
All engines	eng. type 02N39786 ->								1.501.237

				ENGINE
1.6 i	Petrol	55	09/86-07/94	C 16 NZ, E 16 NZ

Engine	Information	A10	A20	A40	A50	A70	C10 - C30	C20	E01
All engines	version Delco Remy			1.312.073	1.412.100	1.912.010			
All engines							1.970.341	C10	1.965.025
All engines	ch. J2508724, J5008434 ->, ->eng. 02V65825								1.500.514
All engines	->ch. J2508723, J5008433								1.501.942

A10	CONDENSER	A20	CONTACT SET	A40	DISTRIBUTOR CAP	A50	ROTOR	A70	PICK-UP
C10	COIL	C20	IGNITION MODULE	C30	ELECTRONIC IGNITION KIT	E01	IGNITION CABLE SET		

Vehicle	alim.	kW	Date	Engine	FUNCTIONS ON THE VEHICLE							
					A10	A20	A40	A50	A70	C10 - C30	C20	E01

ENGINE				
1.6 i	Petrol	60	07/89-02/93	16 SV

Engine	Information	A10	A20	A40	A50	A70	C10 - C30	C20	E01
All engines	->ch. K2500000, ->ch. K5000000, ->ch. KE299999, version Bosch			1.306.249					
All engines	ch. L2500001 ->, ch. L5000001 ->, ch. LE100001 ->, version Bosch			1.306.256					
All engines	24/09/84 ->, version Delco Remy			1.312.073					
All engines	->year 23/09/84, version Delco Remy			1.312.074					
All engines	->ch. K2500000, ->ch. K5000000, ->ch. KE299999, version Lucas			1.328.099					
All engines	ch. L2500001 ->, ch. L5000001 ->, ch. LE100001 ->, version Lucas			1.328.100					
All engines	version Bosch				1.406.121R			1.965.036	
All engines	version Delco Remy				1.412.100	1.912.011			
All engines	version Lucas				1.428.028R				
All engines	info XE						1.970.140	C10	
All engines	info XF						1.970.341	C10	
All engines	->eng. 02E85672								1.500.514
All engines	eng. type 02N39786 ->								1.501.237

ENGINE				
1.6 i Cat	Petrol	55	09/86-02/93	C 16 LZ, C 16 NZ

Engine	Information	A10	A20	A40	A50	A70	C10 - C30	C20	E01
All engines	version Delco Remy			1.312.073	1.412.100	1.912.010			
All engines							1.970.341	C10	1.965.025
All engines	ch. J2508724, J5008434 ->, ->eng. 02V65825								1.500.514
All engines	->ch. J2508723, J5008433								1.501.942

ENGINE				
1.6 S	Petrol	60	09/86-08/91	16 SV

Engine	Information	A10	A20	A40	A50	A70	C10 - C30	C20	E01
All engines	->ch. K2500000, ->ch. K5000000, ->ch. KE299999, version Bosch			1.306.249					
All engines	ch. L2500001 ->, ch. L5000001 ->, ch. LE100001 ->, version Bosch			1.306.256					
All engines	24/09/84 ->, version Delco Remy			1.312.073					
All engines	->year 23/09/84, version Delco Remy			1.312.074					
All engines	->ch. K2500000, ->ch. K5000000, ->ch. KE299999, version Lucas			1.328.099					
All engines	ch. L2500001 ->, ch. L5000001 ->, ch. LE100001 ->, version Lucas			1.328.100					
All engines	version Bosch				1.406.121R			1.965.036	
All engines	version Delco Remy				1.412.100	1.912.011			
All engines	version Lucas				1.428.028R				
All engines	info XE						1.970.140	C10	
All engines	info XF						1.970.341	C10	
All engines	->eng. 02E85672								1.500.514
All engines	eng. type 02N39786 ->								1.501.237

ENGINE				
1.6 S	Petrol	66	09/84-08/86	16 S

Engine	Information	A10	A20	A40	A50	A70	C10 - C30	C20	E01
All engines	version Bosch			1.306.080	1.406.056R				
All engines	info XE						1.970.140	C10	
All engines	info XF						1.970.341	C10	
All engines									1.965.004
All engines	FOR: (S), FOR: (CH)								1.965.034

ENGINE				
1.8	Petrol	82	01/86-08/91	18 SE

Engine	Information	A10	A20	A40	A50	A70	C10 - C30	C20	E01
All engines	->eng. 14258179, version Bosch			1.306.240					
All engines	eng. type 14258180 ->, version Bosch			1.306.257					
All engines	version Ducellier			1.315.084	1.415.103R				
All engines	version Bosch				1.406.127R				
All engines	->ch. KE299999, ->ch. L2500000, ->ch. L5000000, ->ch. LB523999, eng. type 14258180 ->						1.970.140	C10	
All engines									1.965.004
All engines	FOR: (S), FOR: (CH)								1.965.034

A10 CONDENSER	A20 CONTACT SET	A40 DISTRIBUTOR CAP	A50 ROTOR	A70 PICK-UP
C10 COIL	C20 IGNITION MODULE	C30 ELECTRONIC IGNITION KIT	E01 IGNITION CABLE SET	

Vehicle	alim.	kW	Date	Engine	FUNCTIONS ON THE VEHICLE									
					A10	A20	A40	A50	A70	C10 - C30	C20	E01		
1.8 E	Petrol	74	10/85-08/86	ENGINE C 18 NE										
Engine	Information				A10	A20	A40	A50	A70	C10 - C30	C20	E01		
All engines	version Bosch						1.306.080	1.406.056R						
1.8 GSI	Petrol	85	09/84-08/86	ENGINE 18 E										
Engine	Information				A10	A20	A40	A50	A70	C10 - C30	C20	E01		
All engines	version Bosch						1.306.080	1.406.056R						
All engines											1.965.004			
All engines	FOR: (S), FOR: (CH)										1.965.034			
1.8 i	Petrol	66	08/84-09/92	ENGINE C 18 NT, C 18 NZ, S 18 NV										
Engine	Information				A10	A20	A40	A50	A70	C10 - C30	C20	E01		
Eng. C 18 NT	version Bosch						1.306.080	1.406.056R						
Eng. S 18 NV	->eng. 14258179, version Bosch						1.306.240							
Eng. C 18 NZ, S 18 NV	eng. type 14258180 ->, version Bosch						1.306.257							
Eng. C 18 NZ, S 18 NV	version Duellier						1.315.084	1.415.103R						
Eng. C 18 NZ, S 18 NV	version Bosch							1.406.127R						
Eng. C 18 NZ										1.970.140	C10			
Eng. S 18 NV	ch. J2791968 ->, ch. J5273428 ->, ch. JE215466 ->, ->eng. 14258179, info WY									1.970.191	C10			
Eng. S 18 NV	eng. type 14258180 ->, info WE									1.970.192	C10			
Eng. S 18 NV	->ch. J2791967, ->ch. J5273427, ->ch. JE215465									1.970.194	C10			
Eng. S 18 NV	eng. type 14275382 ->													1.500.689
1.8 i	Petrol	74	10/85-08/86	ENGINE C 18 NE										
Engine	Information				A10	A20	A40	A50	A70	C10 - C30	C20	E01		
All engines	version Bosch						1.306.080	1.406.056R						
1.8 i	Petrol	85	09/84-08/86	ENGINE 18 E										
Engine	Information				A10	A20	A40	A50	A70	C10 - C30	C20	E01		
All engines	version Bosch						1.306.080	1.406.056R						
All engines										1.970.109	C10	1.965.004		
All engines	FOR: (S), FOR: (CH)										1.965.034			
1.8 S	Petrol	62	09/87-08/91	ENGINE E 18 NV										
Engine	Information				A10	A20	A40	A50	A70	C10 - C30	C20	E01		
All engines	->eng. 14258179, version Bosch						1.306.240							
All engines	eng. type 14258180 ->, version Bosch						1.306.257							
All engines	version Bosch							1.406.127R						
All engines	ch. J2791968 ->, ch. J5273428 ->, ch. JE215466 ->, ->eng. 14258179, ->eng. 14258179, info WY									1.970.191	C10			
All engines	eng. type 14258180 ->, info WE									1.970.192	C10			
All engines	->ch. J2791967, ->ch. J5273427, ->ch. JE215465									1.970.194	C10			
All engines	eng. type 14275382 ->													1.500.689
2.0 GSI	Petrol	85	09/86-08/91	ENGINE 20 NE										
Engine	Information				A10	A20	A40	A50	A70	C10 - C30	C20	E01		
All engines	->eng. 14180385, version Bosch						1.306.240							
All engines	eng. type 14180386 ->, version Bosch						1.306.257							
All engines	version Duellier						1.315.084	1.415.103R						
All engines	version Bosch							1.406.127R						
All engines	ch. J2791968 ->, ch. J5273428 ->, ch. JE215466 ->, ->eng. 14180385, info WY									1.970.191	C10			
All engines	eng. type 14180386 ->, info WE									1.970.192	C10			
All engines	->ch. J2791967, ->ch. J5273427, ->ch. JE215465									1.970.194	C10			
All engines	eng. type 14672353 ->													1.500.689
2.0 GSI	Petrol	95	09/86-08/91	ENGINE 20 SEH										
Engine	Information				A10	A20	A40	A50	A70	C10 - C30	C20	E01		
All engines	->eng. 14180385, version Bosch						1.306.240							
All engines	eng. type 14180386 ->, version Bosch						1.306.257							
All engines	version Duellier						1.315.084	1.415.103R						
All engines	version Bosch							1.406.127R						
All engines	ch. J2791968 ->, ch. J5273428 ->, ch. JE215466 ->, ->eng. 14180385, info WY									1.970.191	C10			
All engines	eng. type 14180386 ->, info WE									1.970.192	C10			
All engines	->ch. J2791967, ->ch. J5273427, ->ch. JE215465									1.970.194	C10			
All engines	eng. type 14672353 ->													1.500.689

A10	CONDENSER	A20	CONTACT SET	A40	DISTRIBUTOR CAP	A50	ROTOR	A70	PICK-UP
C10	COIL	C20	IGNITION MODULE	C30	ELECTRONIC IGNITION KIT	E01	IGNITION CABLE SET		

The present application list is a brief version. For the detailed information about the possibility of installation on a specific vehicle, please refer to our web-catalogue <http://catalogo.facet.eu/>

Vehicle	alim.	kW	Date	Engine	FUNCTIONS ON THE VEHICLE							
					A10	A20	A40	A50	A70	C10 - C30	C20	E01

ENGINE				
2.0 GSI	Petrol	95	09/86-08/91	20 SEH

Engine	Information	A10	A20	A40	A50	A70	C10 - C30	C20	E01
All engines	ch. J2791968 ->, ch. J5273428 ->, ch. JE215466 ->, ->eng. 14180385, info WY						1.970.191	C10	
All engines	eng. type 14180386 ->, info WE						1.970.192	C10	
All engines	->ch. J2791967, ->ch. J5273427, ->ch. JE215465						1.970.194	C10	

ENGINE				
2.0 GSI 16V	Petrol	115	12/87-08/91	20 XE

Engine	Information	A10	A20	A40	A50	A70	C10 - C30	C20	E01
All engines	->eng. 14180385, version Bosch			1.306.251					
All engines	eng. type 14180386 ->, version Bosch			1.306.257					
All engines	version Bosch				1.406.121R				

ENGINE				
2.0 GSI 16V Cat	Petrol	110	03/88-08/91	C 20 XE

Engine	Information	A10	A20	A40	A50	A70	C10 - C30	C20	E01
All engines	->eng. 14180385, version Bosch			1.306.251					
All engines	eng. type 14180386 ->, version Bosch			1.306.257					
All engines	version Bosch				1.406.121R				

ENGINE				
2.0 GSI Cat	Petrol	85	09/86-08/91	C 20 NE

Engine	Information	A10	A20	A40	A50	A70	C10 - C30	C20	E01
All engines	->eng. 14180385, version Bosch			1.306.240					
All engines	eng. type 14180386 ->, version Bosch			1.306.257					
All engines	version Ducellier			1.315.084	1.415.103R				
All engines	version Bosch				1.406.127R				
All engines	ch. J2791968 ->, ch. J5273428 ->, ch. JE215466 ->, ->eng. 14180385, info WY						1.970.191	C10	
All engines	eng. type 14180386 ->, info WE						1.970.192	C10	
All engines	->ch. J2791967, ->ch. J5273427, ->ch. JE215465						1.970.194	C10	
All engines	eng. type 14672353 ->								1.500.689

ENGINE				
2.0 i	Petrol	85	10/86-02/93	20 NE

Engine	Information	A10	A20	A40	A50	A70	C10 - C30	C20	E01
All engines	->eng. 14180385, version Bosch			1.306.240					
All engines	eng. type 14180386 ->, version Bosch			1.306.257					
All engines	version Ducellier			1.315.084	1.415.103R				
All engines	version Bosch				1.406.127R				
All engines	ch. J2791968 ->, ch. J5273428 ->, ch. JE215466 ->, ->eng. 14180385, info WY						1.970.191	C10	
All engines	eng. type 14180386 ->, info WE						1.970.192	C10	
All engines	->ch. J2791967, ->ch. J5273427, ->ch. JE215465						1.970.194	C10	
All engines	eng. type 14672353 ->								1.500.689

ENGINE				
2.0 i Cat	Petrol	85	10/86-02/93	C 20 NE

Engine	Information	A10	A20	A40	A50	A70	C10 - C30	C20	E01
All engines	->eng. 14180385, version Bosch			1.306.240					
All engines	eng. type 14180386 ->, version Bosch			1.306.257					
All engines	version Ducellier			1.315.084	1.415.103R				
All engines	version Bosch				1.406.127R				
All engines	ch. J2791968 ->, ch. J5273428 ->, ch. JE215466 ->, ->eng. 14180385, info WY						1.970.191	C10	
All engines	eng. type 14180386 ->, info WE						1.970.192	C10	
All engines	->ch. J2791967, ->ch. J5273427, ->ch. JE215465						1.970.194	C10	
All engines	eng. type 14672353 ->								1.500.689

MANTA B

ENGINE				
1.2 S	Petrol	44	09/75-02/79	12 S

Engine	Information	A10	A20	A40	A50	A70	C10 - C30	C20	E01
All engines					1.412.093R				

ENGINE				
1.3 N	Petrol	44	03/79-12/80	13 N









Engine	Information	A10	A20	A40	A50	A70	C10 - C30	C20	E01
All engines	version Bosch		1.206.034HVS	1.306.080	1.406.012R				

A10 CONDENSER	A20 CONTACT SET	A40 DISTRIBUTOR CAP	A50 ROTOR	A70 PICK-UP
C10 COIL	C20 IGNITION MODULE	C30 ELECTRONIC IGNITION KIT	E01 IGNITION CABLE SET	

Vehicle	alim.	kW	Date	Engine	FUNCTIONS ON THE VEHICLE									
					A10	A20	A40	A50	A70	C10 - C30	C20	E01		
ENGINE														
1.3 S	Petrol	55	08/81-08/86	13 S										
ENGINE														
Engine		Information			A10	A20	A40	A50	A70	C10 - C30	C20	E01		
All engines		version Bosch					1.306.080	1.406.055R						
All engines		version Delco Remy					1.312.073	1.412.096						
ENGINE														
1.6 S	Petrol	55	09/75-12/81	16 S										
ENGINE														
Engine		Information			A10	A20	A40	A50	A70	C10 - C30	C20	E01		
All engines		version Bosch				1.206.034HVS	1.306.080	1.406.012R						
ENGINE														
1.9 N	Petrol	55	08/76-12/81	19 N										
ENGINE														
Engine		Information			A10	A20	A40	A50	A70	C10 - C30	C20	E01		
All engines		version Bosch				1.206.034HVS	1.306.080	1.406.012R						
All engines								1.412.093R						
ENGINE														
2.0	Petrol	66	08/77-12/80	20 N										
ENGINE														
Engine		Information			A10	A20	A40	A50	A70	C10 - C30	C20	E01		
All engines		version Bosch				1.206.034HVS	1.306.080	1.406.012R						
MERIVA														
ENGINE														
1.4 ECOTEC	Petrol	74	01/13-03/17	A 14 XER										
ENGINE														
Engine		Information			A10	A20	A40	A50	A70	C10 - C30	C20	E01		
All engines		x 1, COIL ON RAIL								1.970.547	C10			
MERIVA A														
ENGINE														
1.4 16V Twinport	Petrol	66	07/04-05/10	Z 14 XEP										
ENGINE														
Engine		Information			A10	A20	A40	A50	A70	C10 - C30	C20	E01		
All engines		x 1, BOSCH, COIL ON PLUG, incl. spark plug connector								1.970.400	C10			
ENGINE														
1.4 16V Twinport LPG	Petrol/ Liquified Petroleum Gas (LPG)	66	07/04-05/10	Z 14 XEP										
ENGINE														
Engine		Information			A10	A20	A40	A50	A70	C10 - C30	C20	E01		
All engines		x 1, BOSCH, COIL ON PLUG, incl. spark plug connector								1.970.400	C10			
ENGINE														
1.6	Petrol	64	05/03-05/10	Z 16 SE										
ENGINE														
Engine		Information			A10	A20	A40	A50	A70	C10 - C30	C20	E01		
All engines												1.501.904		
ENGINE														
1.6	Petrol	77	01/06-05/10	Z 16 XEP										
ENGINE														
Engine		Information			A10	A20	A40	A50	A70	C10 - C30	C20	E01		
All engines		x 1, DELPHI, COIL ON PLUG, incl. spark plug connector								1.970.450	C10			
ENGINE														
1.6 16V	Petrol	74	05/03-01/06	Z 16 XE										
ENGINE														
Engine		Information			A10	A20	A40	A50	A70	C10 - C30	C20	E01		
All engines		x 4, COIL ON PLUG, incl. spark plug connector								1.970.399	C10			
ENGINE														
1.6 Turbo	Petrol	132	09/05-05/10	Z 16 LET										
ENGINE														
Engine		Information			A10	A20	A40	A50	A70	C10 - C30	C20	E01		
All engines		x 1, DELPHI, COIL ON PLUG, incl. spark plug connector								1.970.450	C10			
ENGINE														
1.8	Petrol	92	05/03-05/10	Z 18 XE										
ENGINE														
Engine		Information			A10	A20	A40	A50	A70	C10 - C30	C20	E01		
All engines		x 1, COIL ON PLUG, incl. spark plug connector								1.970.508	C10			
MERIVA B														
ENGINE														
1.4	Petrol	103	06/10-03/17	A 14 NET, B 14 NET										
ENGINE														
Engine		Information			A10	A20	A40	A50	A70	C10 - C30	C20	E01		
All engines		x 1, COIL ON RAIL								1.970.547	C10			

A10 CONDENSER	A20 CONTACT SET	A40 DISTRIBUTOR CAP	A50 ROTOR	A70 PICK-UP
C10 COIL	C20 IGNITION MODULE	C30 ELECTRONIC IGNITION KIT	E01 IGNITION CABLE SET	

The present application list is a brief version. For the detailed information about the possibility of installation on a specific vehicle, please refer to our web-catalogue <http://catalogo.facet.eu/>

					FUNCTIONS ON THE VEHICLE							
Vehicle	alim.	kW	Date	Engine								
ENGINE												
1.4	Petrol	74	06/10-03/17	A 14 XER, B 14 XER								
ENGINE												
Engine		Information			A10	A20	A40	A50	A70	C10 - C30	C20	E01
All engines		x 1, COIL ON RAIL								1.970.547	C10	
ENGINE												
1.4	Petrol	88	06/10-03/17	A 14 NEL, B 14 NEL								
ENGINE												
Engine		Information			A10	A20	A40	A50	A70	C10 - C30	C20	E01
All engines		x 1, COIL ON RAIL								1.970.547	C10	
ENGINE												
1.4 LPG	Petrol/ Liquified Petro- leum Gas (LPG)	88	06/11-03/17	A 14 NEL, B 14 NEL								
ENGINE												
Engine		Information			A10	A20	A40	A50	A70	C10 - C30	C20	E01
All engines		x 1, COIL ON RAIL								1.970.547	C10	
MIDI												
ENGINE												
2.0 i	Petrol	62	09/92-08/94	20PET								
ENGINE												
Engine		Information			A10	A20	A40	A50	A70	C10 - C30	C20	E01
All engines		version Denso					1.313.093	1.413.030				
All engines		for emission-controlled vehicles								1.970.219	C10	
ENGINE												
2.0 i 4x4	Petrol	62	09/92-08/94	20PET								
ENGINE												
Engine		Information			A10	A20	A40	A50	A70	C10 - C30	C20	E01
All engines		version Denso					1.313.093	1.413.030				
All engines		for emission-controlled vehicles								1.970.219	C10	
MOKKA												
ENGINE												
1.4	Petrol	103	04/13->	A 14 NET, B 14 NET, D 14 NET								
ENGINE												
Engine		Information			A10	A20	A40	A50	A70	C10 - C30	C20	E01
All engines		x 1, COIL ON RAIL								1.970.547	C10	
ENGINE												
1.4 4x4	Petrol	103	06/12->	A 14 NET, B 14 NET, D 14 NET								
ENGINE												
Engine		Information			A10	A20	A40	A50	A70	C10 - C30	C20	E01
All engines		x 1, COIL ON RAIL								1.970.547	C10	
ENGINE												
1.4 4x4	Petrol	112	06/16->	B 14 XFT								
ENGINE												
Engine		Information			A10	A20	A40	A50	A70	C10 - C30	C20	E01
All engines		x 4, COIL ON PLUG								1.970.631	C10	
ENGINE												
1.4 LPG	Petrol/ Liquified Petro- leum Gas (LPG)	103	04/13->	A 14 NET, B 14 NET, D 14 NET								
ENGINE												
Engine		Information			A10	A20	A40	A50	A70	C10 - C30	C20	E01
All engines		x 1, COIL ON RAIL								1.970.547	C10	
ENGINE												
1.6	Petrol	85	06/12->	A 16 XER, B 16 XER, D 16 XER								
ENGINE												
Engine		Information			A10	A20	A40	A50	A70	C10 - C30	C20	E01
All engines		x 1, COIL RAILS								1.970.545	C10	
ENGINE												
1.8	Petrol	103	01/13->	A 18 XER								
ENGINE												
Engine		Information			A10	A20	A40	A50	A70	C10 - C30	C20	E01
All engines		x 1, COIL ON PLUG								1.970.545	C10	
ENGINE												
1.8 4x4	Petrol	103	01/13->	A 18 XER								
ENGINE												
Engine		Information			A10	A20	A40	A50	A70	C10 - C30	C20	E01
All engines		x 1, COIL ON PLUG								1.970.545	C10	

A10 CONDENSER	A20 CONTACT SET	A40 DISTRIBUTOR CAP	A50 ROTOR	A70 PICK-UP
C10 COIL	C20 IGNITION MODULE	C30 ELECTRONIC IGNITION KIT	E01 IGNITION CABLE SET	

Vehicle	alim.	kW	Date	Engine	FUNCTIONS ON THE VEHICLE							
					A10	A20	A40	A50	A70	C10 - C30	C20	E01

OMEGA A

1.8	Petrol	60	09/86-03/94	ENGINE S 18 NV
-----	--------	----	-------------	-------------------

Engine	Information	A10	A20	A40	A50	A70	C10 - C30	C20	E01
All engines	->ch. K1999999, version Bosch			1.306.240					
All engines	ch. L1000001 ->, version Bosch			1.306.257					
All engines	version Ducellier			1.315.084	1.415.103R				
All engines	version Bosch				1.406.127R				
All engines	->eng. 14258179, ch. K1000099 ->						1.970.191	C10	
All engines	eng. type 14258180 ->						1.970.192	C10	
All engines	->ch. K1000098						1.970.194	C10	
All engines	eng. type 14258180 ->, ->ch. L1204907								1.500.527
All engines	ch. L1204908 ->								1.500.689

1.8	Petrol	65	09/87-03/94	ENGINE E 18 NVR
-----	--------	----	-------------	--------------------

Engine	Information	A10	A20	A40	A50	A70	C10 - C30	C20	E01
All engines	->ch. K1999999, version Bosch			1.306.240					
All engines	ch. L1000001 ->, version Bosch			1.306.257					
All engines	version Ducellier			1.315.084	1.415.103R				
All engines	version Bosch				1.406.127R				
All engines	->eng. 14258179, ch. K1000099 ->						1.970.191	C10	
All engines	eng. type 14258180 ->						1.970.192	C10	
All engines	->ch. K1000098						1.970.194	C10	
All engines	eng. type 14258180 ->, ->ch. L1204907								1.500.527
All engines	ch. L1204908 ->								1.500.689

1.8	Petrol	85	09/86-03/94	ENGINE 18 SEH
-----	--------	----	-------------	------------------

Engine	Information	A10	A20	A40	A50	A70	C10 - C30	C20	E01
All engines	->ch. K1999999, version Bosch			1.306.240					
All engines	ch. L1000001 ->, version Bosch			1.306.257					
All engines	version Ducellier			1.315.084	1.415.103R				
All engines	version Bosch				1.406.127R				
All engines	eng. type 1019854 ->, ->eng. 14258180						1.970.140	C10	
All engines	eng. type 14258180 ->, ->ch. L1204907								1.500.527
All engines	ch. L1204908 ->								1.500.689

1.8 N	Petrol	60	09/86-08/87	ENGINE 18 NV
-------	--------	----	-------------	-----------------

Engine	Information	A10	A20	A40	A50	A70	C10 - C30	C20	E01
All engines	->ch. K1999999, version Bosch			1.306.240					
All engines	ch. L1000001 ->, version Bosch			1.306.257					
All engines	version Ducellier			1.315.084	1.415.103R				
All engines	version Bosch				1.406.127R				
All engines	->eng. 14258179, ch. K1000099 ->						1.970.191	C10	
All engines	eng. type 14258180 ->						1.970.192	C10	
All engines	->ch. K1000098						1.970.194	C10	
All engines	eng. type 14258180 ->, ->ch. L1204907								1.500.527
All engines	ch. L1204908 ->								1.500.689

1.8 S	Petrol	66	09/86-03/94	ENGINE 18 SV
-------	--------	----	-------------	-----------------

Engine	Information	A10	A20	A40	A50	A70	C10 - C30	C20	E01
All engines	->ch. K1999999, version Bosch			1.306.240					
All engines	ch. L1000001 ->, version Bosch			1.306.257					
All engines	version Ducellier			1.315.084	1.415.103R				
All engines	version Bosch				1.406.127R				
All engines	eng. type 14258180 ->						1.970.140	C10	
All engines	ch. L1019855 ->							1.965.036	
All engines	eng. type 14258180 ->, ->ch. L1204907								1.500.527
All engines	ch. L1204908 ->								1.500.689

2.0	Petrol	85	09/87-04/94	ENGINE C 20 NE
-----	--------	----	-------------	-------------------

Engine	Information	A10	A20	A40	A50	A70	C10 - C30	C20	E01
All engines	->ch. K1999999, version Bosch			1.306.240					
All engines	ch. L1000001 ->, version Bosch			1.306.257					

A10 CONDENSER	A20 CONTACT SET	A40 DISTRIBUTOR CAP	A50 ROTOR	A70 PICK-UP
C10 COIL	C20 IGNITION MODULE	C30 ELECTRONIC IGNITION KIT	E01 IGNITION CABLE SET	

The present application list is a brief version. For the detailed information about the possibility of installation on a specific vehicle, please refer to our web-catalogue <http://catalogo.facet.eu/>

Vehicle	alim.	kW	Date	Engine	FUNCTIONS ON THE VEHICLE							
					A10	A20	A40	A50	A70	C10 - C30	C20	E01

ENGINE				
2.0	Petrol	85	09/87-04/94	C20 NE

Engine	Information	A10	A20	A40	A50	A70	C10 - C30	C20	E01
All engines	version Ducellier			1.315.084	1.415.103R				
All engines	version Bosch				1.406.127R				
All engines	->eng. 14180385, ch. K1000099 ->						1.970.191	C10	
All engines	eng. type 14180386 ->						1.970.192	C10	
All engines	->ch. K1000098						1.970.194	C10	
All engines	->eng. 14672352, eng. type 14180386 ->								1.500.527
All engines	eng. type 14672353 ->								1.500.689

ENGINE				
2.0	Petrol	90	09/86-03/94	20 SE

Engine	Information	A10	A20	A40	A50	A70	C10 - C30	C20	E01
All engines	->ch. K1999999, version Bosch			1.306.240					
All engines	ch. L1000001 ->, version Bosch			1.306.257					
All engines	version Ducellier			1.315.084	1.415.103R				
All engines	version Bosch				1.406.127R				
All engines	->eng. 14180385, ch. K1000099 ->						1.970.191	C10	
All engines	eng. type 14180386 ->						1.970.192	C10	
All engines	->ch. K1000098						1.970.194	C10	
All engines	->eng. 14312950, eng. type 14180386 ->								1.500.527
All engines	eng. type 14312951 ->								1.500.689

ENGINE				
2.0 i	Petrol	85	09/86-04/94	C20 NE

Engine	Information	A10	A20	A40	A50	A70	C10 - C30	C20	E01
All engines	->ch. K1999999, version Bosch			1.306.240					
All engines	ch. L1000001 ->, version Bosch			1.306.257					
All engines	version Ducellier			1.315.084	1.415.103R				
All engines	version Bosch				1.406.127R				
All engines	->eng. 14180385, ch. K1000099 ->						1.970.191	C10	
All engines	eng. type 14180386 ->						1.970.192	C10	
All engines	->ch. K1000098						1.970.194	C10	
All engines	->eng. 14672352, eng. type 14180386 ->								1.500.527
All engines	eng. type 14672353 ->								1.500.689

ENGINE				
2.4 i	Petrol	92	09/88-03/94	C24 NE

Engine	Information	A10	A20	A40	A50	A70	C10 - C30	C20	E01
All engines	oe Bosch 1 235 522 409			1.306.080					
All engines	oe Bosch 1 235 522 437			1.306.256					
All engines	version Bosch				1.406.121R				
All engines	->ch. K1999999						1.970.191	C10	
All engines	ch. L1000001 ->						1.970.192	C10	

ENGINE				
2.6 i	Petrol	110	09/90-03/94	C26 NE

Engine	Information	A10	A20	A40	A50	A70	C10 - C30	C20	E01
All engines	version Bosch			1.306.258	1.406.056R				
All engines							1.970.192	C10	

ENGINE				
3.0	Petrol	115	03/87-03/94	C30 LE

Engine	Information	A10	A20	A40	A50	A70	C10 - C30	C20	E01
All engines	->ch. K1999999, version Bosch			1.306.081					
All engines	ch. L1000001 ->, version Bosch			1.306.258					
All engines	version Bosch				1.406.056R				
All engines	->ch. K1999999, ch. K1000099 ->						1.970.191	C10	
All engines	ch. L1000001 ->						1.970.192	C10	
All engines	->ch. K1000098						1.970.194	C10	

ENGINE				
3.0	Petrol	130	03/87-03/94	30 NE, C30 NE

Engine	Information	A10	A20	A40	A50	A70	C10 - C30	C20	E01
All engines	->ch. K1999999, version Bosch			1.306.081					
All engines	ch. L1000001 ->, version Bosch			1.306.258					
All engines	version Bosch				1.406.056R				
Eng. C30 NE	->ch. K1999999, ch. K1000099 ->						1.970.191	C10	

A10 CONDENSER	A20 CONTACT SET	A40 DISTRIBUTOR CAP	A50 ROTOR	A70 PICK-UP
C10 COIL	C20 IGNITION MODULE	C30 ELECTRONIC IGNITION KIT	E01 IGNITION CABLE SET	

Vehicle	alim.	kW	Date	Engine	FUNCTIONS ON THE VEHICLE							
					A10	A20	A40	A50	A70	C10 - C30	C20	E01
ENGINE												
3.0	Petrol	130	03/87-03/94	30 NE, C30 NE								
Engine	Information			A10	A20	A40	A50	A70	C10 - C30	C20	E01	
Eng. C30 NE	ch. L1000001 ->								1.970.192	C10		
Eng. C30 NE	->ch. K1000098								1.970.194	C10		
Eng. 30 NE										1.965.034		
ENGINE												
3.0 24V	Petrol	150	09/89-03/94	C30 SE								
Engine	Information			A10	A20	A40	A50	A70	C10 - C30	C20	E01	
All engines	version Bosch					1.306.258	1.406.056R					
All engines								1.970.192	C10			
ENGINE												
3.0 24V Omega 3000	Petrol	150	09/88-04/94	C30 SE								
Engine	Information			A10	A20	A40	A50	A70	C10 - C30	C20	E01	
All engines	version Bosch					1.306.258	1.406.056R					
All engines								1.970.192	C10			
ENGINE												
3.0 Cat	Petrol	130	03/87-03/94	C30 NE								
Engine	Information			A10	A20	A40	A50	A70	C10 - C30	C20	E01	
All engines	->ch. K1999999, version Bosch					1.306.081						
All engines	ch. L1000001 ->, version Bosch					1.306.258						
All engines	version Bosch						1.406.056R					
All engines	->ch. K1999999, ch. K1000099 ->								1.970.191	C10		
All engines	ch. L1000001 ->								1.970.192	C10		
All engines	->ch. K1000098								1.970.194	C10		
OMEGA B												
ENGINE												
2.0	Petrol	85	03/94-12/00	20 SE, X20 SE								
Engine	Information			A10	A20	A40	A50	A70	C10 - C30	C20	E01	
Eng. 20 SE	->ch. K1999999, version Bosch					1.306.240						
Eng. 20 SE	ch. L1000001 ->, version Bosch					1.306.257						
Eng. 20 SE	version Ducellier					1.315.084	1.415.103R					
Eng. 20 SE	version Bosch						1.406.127R					
Eng. 20 SE	->eng. 14180385, ch. K1000099 ->								1.970.191	C10		
Eng. 20 SE	eng. type 14180386 ->								1.970.192	C10		
Eng. 20 SE	->ch. K1000098								1.970.194	C10		
Eng. X20 SE									1.970.273	C10		
Eng. 20 SE	->eng. 14312950, eng. type 14180386 ->										1.500.527	
Eng. 20 SE	eng. type 14312951 ->										1.500.689	
ENGINE												
2.0 16V	Petrol	100	03/94-09/99	X20 XEV								
Engine	Information			A10	A20	A40	A50	A70	C10 - C30	C20	E01	
All engines									1.970.272	C10	1.501.562	
REKORD D												
ENGINE												
1.7	Petrol	44	03/75-08/77	17 N								
Engine	Information			A10	A20	A40	A50	A70	C10 - C30	C20	E01	
All engines							1.412.093R					
REKORD E												
ENGINE												
1.7	Petrol	44	09/77-10/82	17 N								
Engine	Information			A10	A20	A40	A50	A70	C10 - C30	C20	E01	
All engines							1.406.067R					
ENGINE												
1.9	Petrol	55	09/77-10/82	19 N								
Engine	Information			A10	A20	A40	A50	A70	C10 - C30	C20	E01	
All engines							1.406.067R					
ENGINE												
2.0	Petrol	66	09/77-10/82	20 N								
Engine	Information			A10	A20	A40	A50	A70	C10 - C30	C20	E01	
All engines							1.406.067R					

A10 CONDENSER	A20 CONTACT SET	A40 DISTRIBUTOR CAP	A50 ROTOR	A70 PICK-UP
C10 COIL	C20 IGNITION MODULE	C30 ELECTRONIC IGNITION KIT	E01 IGNITION CABLE SET	

The present application list is a brief version. For the detailed information about the possibility of installation on a specific vehicle, please refer to our web-catalogue <http://catalogo.facet.eu/>

Vehicle	alim.	kW	Date	Engine	FUNCTIONS ON THE VEHICLE							
					A10	A20	A40	A50	A70	C10 - C30	C20	E01

SENATOR B

				ENGINE
2.5 i	Petrol	103	09/90-09/93	25 NE

Engine	Information	A10	A20	A40	A50	A70	C10 - C30	C20	E01
All engines	->eng. 055888, version Bosch			1.306.081					
All engines	eng. type 055889 ->, version Bosch			1.306.258					
All engines	version Bosch				1.406.056R				

				ENGINE
3.0	Petrol	115	09/87-09/93	C30 LE

Engine	Information	A10	A20	A40	A50	A70	C10 - C30	C20	E01
All engines	->eng. 018097, version Bosch			1.306.081					
All engines	eng. type 018098 ->, version Bosch			1.306.258					
All engines	version Bosch				1.406.056R				
All engines	ch. K1000099 ->, ->ch. L1000000						1.970.191	C10	
All engines	ch. L1000001 ->						1.970.192	C10	
All engines	->ch. K1000098						1.970.194	C10	

				ENGINE
3.0	Petrol	130	01/88-09/90	30 NE

Engine	Information	A10	A20	A40	A50	A70	C10 - C30	C20	E01
All engines	->eng. 115025, version Bosch			1.306.081					
All engines	eng. type 115026 ->, version Bosch			1.306.258					
All engines	version Bosch				1.406.056R				

				ENGINE
3.0 24V	Petrol	150	09/89-09/93	C30 SE

Engine	Information	A10	A20	A40	A50	A70	C10 - C30	C20	E01
All engines	version Bosch			1.306.258	1.406.056R				
All engines							1.970.192	C10	

				ENGINE
3.0 i Cat	Petrol	130	01/88-09/93	C30 NE

Engine	Information	A10	A20	A40	A50	A70	C10 - C30	C20	E01
All engines	->eng. 115025, version Bosch			1.306.081					
All engines	eng. type 115026 ->, version Bosch			1.306.258					
All engines	version Bosch				1.406.056R				
All engines	ch. K1000099 ->, ->ch. L1000000						1.970.191	C10	
All engines	ch. L1000001 ->						1.970.192	C10	
All engines	->ch. K1000098						1.970.194	C10	

SIGNUM

				ENGINE
1.8	Petrol	103	09/05-12/08	Z 18 XER

Engine	Information	A10	A20	A40	A50	A70	C10 - C30	C20	E01
All engines	x 1, DELPHI, COIL ON PLUG, incl. spark plug connector						1.970.450	C10	

				ENGINE
1.8	Petrol	90	05/03-07/05	Z 18 XE

Engine	Information	A10	A20	A40	A50	A70	C10 - C30	C20	E01
All engines	x 1, COIL ON PLUG, incl. spark plug connector						1.970.508	C10	

SINTRA

				ENGINE
2.2 i 16V	Petrol	104	11/96-04/99	X 22 XE

Engine	Information	A10	A20	A40	A50	A70	C10 - C30	C20	E01
All engines	x 1, D.I.S.						1.970.389	C10	
All engines									1.501.562

SPEEDSTER

				ENGINE
2.0	Petrol	162	10/03-08/06	Z 20 LET

Engine	Information	A10	A20	A40	A50	A70	C10 - C30	C20	E01
All engines							1.970.507	C10	

				ENGINE
2.0 Turbo	Petrol	147	08/02-08/06	Z 20 LET

Engine	Information	A10	A20	A40	A50	A70	C10 - C30	C20	E01
All engines	x 1, COIL ON PLUG						1.970.507	C10	

A10 CONDENSER	A20 CONTACT SET	A40 DISTRIBUTOR CAP	A50 ROTOR	A70 PICK-UP
C10 COIL	C20 IGNITION MODULE	C30 ELECTRONIC IGNITION KIT	E01 IGNITION CABLE SET	

Vehicle	alim.	kW	Date	Engine	FUNCTIONS ON THE VEHICLE							
					A10	A20	A40	A50	A70	C10 - C30	C20	E01

TIGRA A

1.4 16V	Petrol	63	08/97-12/00	ENGINE X 14 XE
---------	--------	----	-------------	-------------------

Engine	Information	A10	A20	A40	A50	A70	C10 - C30	C20	E01
All engines	->ch. 20C17331								1.500.688
All engines	ch. 20C17332 ->								1.501.559

1.4 16V	Petrol	66	07/94-12/00	ENGINE X 14 XE
---------	--------	----	-------------	-------------------

Engine	Information	A10	A20	A40	A50	A70	C10 - C30	C20	E01
All engines	->ch. 20C17331								1.500.688
All engines	ch. 20C17332 ->								1.501.559

1.6 16V	Petrol	74	08/97-08/98	ENGINE C 16 SEL
---------	--------	----	-------------	--------------------

Engine	Information	A10	A20	A40	A50	A70	C10 - C30	C20	E01
All engines	->ch. 20C17331								1.500.688
All engines	ch. 20C17332 ->								1.501.559

1.6 16V	Petrol	78	07/94-08/98	ENGINE X 16 XE
---------	--------	----	-------------	-------------------

Engine	Information	A10	A20	A40	A50	A70	C10 - C30	C20	E01
All engines	->ch. 20C17331								1.500.688
All engines	ch. 20C17332 ->								1.501.559

TIGRA B

1.4	Petrol	66	06/04-12/10	ENGINE Z 14 XEP
-----	--------	----	-------------	--------------------

Engine	Information	A10	A20	A40	A50	A70	C10 - C30	C20	E01
All engines	x 1, BOSCH, COIL ON PLUG, incl. spark plug connector						1.970.400	C10	

1.8	Petrol	92	06/04-12/10	ENGINE Z 18 XE
-----	--------	----	-------------	-------------------

Engine	Information	A10	A20	A40	A50	A70	C10 - C30	C20	E01
All engines	x 1, COIL ON PLUG, incl. spark plug connector						1.970.508	C10	

VECTRA

2.0	Petrol	85	10/95-04/02	ENGINE C 20 SEL
-----	--------	----	-------------	--------------------

Engine	Information	A10	A20	A40	A50	A70	C10 - C30	C20	E01
All engines	x 1, D.I.S.						1.970.272	C10	

VECTRA A

1.4 S	Petrol	55	04/88-06/92	ENGINE 14 NV
-------	--------	----	-------------	-----------------

Engine	Information	A10	A20	A40	A50	A70	C10 - C30	C20	E01
All engines	->ch. K1999999, ->ch. K5999999, ->ch. KV999999, version Bosch			1.306.080					
All engines	ch. L1000001 ->, ch. L5000001 ->, ch. LV100001 ->, version Bosch			1.306.256					
All engines	version Bosch			1.406.056R				1.965.005	
All engines	eng. type 02J22350 ->								1.500.956
All engines	eng. type 19585416 ->								1.501.237

1.6	Petrol	51	08/92-07/93	ENGINE C 16 LZ2
-----	--------	----	-------------	--------------------

Engine	Information	A10	A20	A40	A50	A70	C10 - C30	C20	E01
All engines	version Ducellier			1.315.084	1.415.103R				
All engines							1.970.140	C10	1.965.036

1.6	Petrol	60	09/88-05/93	ENGINE 16 SV
-----	--------	----	-------------	-----------------

Engine	Information	A10	A20	A40	A50	A70	C10 - C30	C20	E01
All engines	->ch. K1999999, ->ch. K5999999, ->ch. KV999999, version Bosch			1.306.249					
All engines	ch. L1000001 ->, ch. L5000001 ->, ch. LV100001 ->, version Bosch			1.306.256					
All engines	->ch. K1999999, ->ch. K5999999, ->ch. KV999999, version Lucas			1.328.099					
All engines	ch. L1000001 ->, ch. L5000001 ->, ch. LV100001 ->, version Lucas			1.328.100					
All engines	version Bosch				1.406.121R				
All engines	version Lucas				1.428.028R				
All engines	ch. L1000001 ->, ch. L5000001 ->, ch. LV100001 ->						1.970.140	C10	

A10 CONDENSER	A20 CONTACT SET	A40 DISTRIBUTOR CAP	A50 ROTOR	A70 PICK-UP
C10 COIL	C20 IGNITION MODULE	C30 ELECTRONIC IGNITION KIT	E01 IGNITION CABLE SET	

Vehicle	alim.	kW	Date	Engine	FUNCTIONS ON THE VEHICLE							
					A10	A20	A40	A50	A70	C10 - C30	C20	E01

ENGINE				
1.6	Petrol	60	09/88-05/93	16 SV

Engine	Information	A10	A20	A40	A50	A70	C10 - C30	C20	E01
All engines								1.965.036	
All engines	->eng. 02E85672								1.500.514
All engines	eng. type 02N39786 ->								1.501.237

ENGINE				
1.6i	Petrol	52	09/93-11/95	X 16 SZ

Engine	Information	A10	A20	A40	A50	A70	C10 - C30	C20	E01
All engines	version Delco Remy			1.312.073	1.412.100	1.912.010			
All engines								1.965.025	
All engines	->ch. P1999999, ->ch. P5999999, ->ch. P7999999								1.500.634
All engines	ch. R1000001 ->, ch. R5000001 ->, ch. R7500001 ->								1.501.531

ENGINE				
1.6i	Petrol	55	09/88-11/95	C 16 NZ, C 16 NZ2, E 16 NZ

Engine	Information	A10	A20	A40	A50	A70	C10 - C30	C20	E01
Eng. C 16 NZ, E 16 NZ	version Delco Remy			1.312.073	1.412.100	1.912.010			
Eng. C 16 NZ2	version Ducellier			1.315.084	1.415.103R				
Eng. C 16 NZ2							1.970.140	C10	1.965.036
Eng. C 16 NZ, E 16 NZ							1.970.341	C10	1.965.025
Eng. C 16 NZ, E 16 NZ	->eng. 02V65825								1.500.513
Eng. C 16 NZ, E 16 NZ	ch. R1000001 ->, ch. R5000001 ->, ch. R7500001 ->								1.501.237

ENGINE				
1.6i Cat	Petrol	55	09/88-11/95	C 16 NZ, C 16 NZ2

Engine	Information	A10	A20	A40	A50	A70	C10 - C30	C20	E01
Eng. C 16 NZ	version Delco Remy			1.312.073	1.412.100	1.912.010			
Eng. C 16 NZ2	version Ducellier			1.315.084	1.415.103R				
Eng. C 16 NZ2							1.970.140	C10	1.965.036
Eng. C 16 NZ							1.970.341	C10	1.965.025
Eng. C 16 NZ	->eng. 02V65825								1.500.513
Eng. C 16 NZ	ch. R1000001 ->, ch. R5000001 ->, ch. R7500001 ->								1.501.237

ENGINE				
1.6 S	Petrol	60	09/88-05/93	16 SV

Engine	Information	A10	A20	A40	A50	A70	C10 - C30	C20	E01
All engines	->ch. K1999999, ->ch. K5999999, ->ch. KV999999, version Bosch			1.306.249					
All engines	ch. L1000001 ->, ch. L5000001 ->, ch. LV100001 ->, version Bosch			1.306.256					
All engines	->ch. K1999999, ->ch. K5999999, ->ch. KV999999, version Lucas			1.328.099					
All engines	ch. L1000001 ->, ch. L5000001 ->, ch. LV100001 ->, version Lucas			1.328.100					
All engines	version Bosch				1.406.121R				
All engines	version Lucas				1.428.028R				
All engines	ch. L1000001 ->, ch. L5000001 ->, ch. LV100001 ->					1.970.140	C10		
All engines								1.965.036	
All engines	->eng. 02E85672								1.500.514
All engines	eng. type 02N39786 ->								1.501.237

ENGINE				
1.8i	Petrol	66	09/88-10/90	18 SV

Engine	Information	A10	A20	A40	A50	A70	C10 - C30	C20	E01
All engines	->ch. K1999999, ->ch. K5999999, ->ch. KV999999, version Bosch			1.306.240					
All engines	ch. L1000001 ->, ch. L5000001 ->, ch. LV100001 ->, version Bosch			1.306.257					
All engines	version Ducellier			1.315.084	1.415.103R				
All engines	version Bosch				1.406.127R				
All engines							1.970.140	C10	1.965.036
All engines	->eng. 14279654, eng. type 14275382 ->								1.500.689

ENGINE				
1.8i Cat	Petrol	66	03/90-11/95	C 18 NZ

Engine	Information	A10	A20	A40	A50	A70	C10 - C30	C20	E01
All engines	version Bosch			1.306.257	1.406.127R				
All engines	version Ducellier			1.315.084	1.415.103R				
All engines							1.970.140	C10	1.965.036
All engines	->eng. 14432540, eng. type 14349311 ->								1.500.689

A10 CONDENSER	A20 CONTACT SET	A40 DISTRIBUTOR CAP	A50 ROTOR	A70 PICK-UP
C10 COIL	C20 IGNITION MODULE	C30 ELECTRONIC IGNITION KIT	E01 IGNITION CABLE SET	

Vehicle	alim.	kW	Date	Engine	FUNCTIONS ON THE VEHICLE								
					A10	A20	A40	A50	A70	C10 - C30	C20	E01	
1.8 S	Petrol	65	09/88-07/89	ENGINE E 18 NVR									
Engine	Information	A10	A20	A40	A50	A70	C10 - C30	C20	E01				
All engines	->ch. K1999999, ->ch. K5999999, ->ch. KV999999, version Bosch			1.306.240									
All engines	ch. L1000001 ->, ch. L5000001 ->, ch. LV100001 ->, version Bosch			1.306.257									
All engines	version Ducellier			1.315.084	1.415.103R								
All engines	version Bosch				1.406.127R								
All engines	->eng. 14258179, info WY						1.970.191	C10					
All engines	eng. type 14258180 ->, info WE						1.970.192	C10					
All engines	->eng. 14279654, eng. type 14275382 ->											1.500.689	
1.8 S	Petrol	66	09/89-10/90	ENGINE 18 SV									
Engine	Information	A10	A20	A40	A50	A70	C10 - C30	C20	E01				
All engines	->ch. K1999999, ->ch. K5999999, ->ch. KV999999, version Bosch			1.306.240									
All engines	ch. L1000001 ->, ch. L5000001 ->, ch. LV100001 ->, version Bosch			1.306.257									
All engines	version Ducellier			1.315.084	1.415.103R								
All engines	version Bosch				1.406.127R								
All engines	->eng. 14258179, info WY						1.970.140	C10	1.965.036				
All engines	eng. type 14279654, eng. type 14275382 ->											1.500.689	
1.8 S 4x4	Petrol	65	01/89-07/89	ENGINE E 18 NVR									
Engine	Information	A10	A20	A40	A50	A70	C10 - C30	C20	E01				
All engines	->ch. K1999999, ->ch. K5999999, ->ch. KV999999, version Bosch			1.306.240									
All engines	ch. L1000001 ->, ch. L5000001 ->, ch. LV100001 ->, version Bosch			1.306.257									
All engines	version Ducellier			1.315.084	1.415.103R								
All engines	version Bosch				1.406.127R								
All engines	->eng. 14258179, info WY						1.970.191	C10					
All engines	eng. type 14258180 ->, info WE						1.970.192	C10					
All engines	->eng. 14279654, eng. type 14275382 ->											1.500.689	
2.0 i	Petrol	85	09/88-10/90	ENGINE 20 NE									
Engine	Information	A10	A20	A40	A50	A70	C10 - C30	C20	E01				
All engines	->ch. K1999999, ->ch. K5999999, ->ch. KV999999, version Bosch			1.306.240									
All engines	ch. L1000001 ->, ch. L5000001 ->, ch. LV100001 ->, version Bosch			1.306.257									
All engines	version Ducellier			1.315.084	1.415.103R								
All engines	version Bosch				1.406.127R								
All engines	->eng. 14180385, info WY						1.970.191	C10					
All engines	eng. type 14180386 ->, info WE						1.970.192	C10					
All engines	->eng. 14841581, eng. type 14672353 ->											1.500.689	
2.0 i	Petrol	95	09/88-09/92	ENGINE 20 SEH									
Engine	Information	A10	A20	A40	A50	A70	C10 - C30	C20	E01				
All engines	->ch. K1999999, ->ch. K5999999, ->ch. KV999999, version Bosch			1.306.240									
All engines	ch. L1000001 ->, ch. L5000001 ->, ch. LV100001 ->, version Bosch			1.306.257									
All engines	version Ducellier			1.315.084	1.415.103R								
All engines	version Bosch				1.406.127R								
All engines	->eng. 14180385, info WY						1.970.191	C10					
All engines	eng. type 14180386 ->, info WE						1.970.192	C10					
All engines	eng. type 14672353 ->											1.500.689	
2.0 i 16V	Petrol	100	08/92-08/95	ENGINE X 20 XEV									
Engine	Information	A10	A20	A40	A50	A70	C10 - C30	C20	E01				
All engines	->ch. K1999999, ->ch. K5999999, ->ch. KV999999, version Bosch			1.306.240									
All engines	ch. L1000001 ->, ch. L5000001 ->, ch. LV100001 ->, version Bosch			1.306.257									
All engines	version Ducellier			1.315.084	1.415.103R								
All engines	version Bosch				1.406.127R								
All engines	->eng. 14180385, info WY						1.970.191	C10					
All engines	eng. type 14180386 ->, info WE						1.970.192	C10					
All engines	eng. type 14672353 ->											1.500.689	
2.0 i 16V	Petrol	110	02/89-10/90	ENGINE 20 XEJ									
Engine	Information	A10	A20	A40	A50	A70	C10 - C30	C20	E01				
All engines	->eng. 14180385, version Bosch			1.306.251									
All engines	eng. type 14180386 ->, version Bosch			1.306.257									
All engines	version Bosch				1.406.121R								
A10	CONDENSER	A20	CONTACT SET	A40	DISTRIBUTOR CAP	A50	ROTOR	A70	PICK-UP				
C10	COIL	C20	IGNITION MODULE	C30	ELECTRONIC IGNITION KIT	E01	IGNITION CABLE SET						

Vehicle	alim.	kW	Date	Engine	FUNCTIONS ON THE VEHICLE							
					A10	A20	A40	A50	A70	C10 - C30	C20	E01

ENGINE				
2.0 i 16V	Petrol	110	02/89-10/90	20 XEJ

Engine	Information	A10	A20	A40	A50	A70	C10 - C30	C20	E01
All engines	ch. P1000001 ->, ch. P5000001 ->, ch. P7500001 ->								1.500.688

ENGINE				
2.0 i 16V 4x4	Petrol	100	06/94-11/95	X 20 XEV

Engine	Information	A10	A20	A40	A50	A70	C10 - C30	C20	E01
All engines							1.970.272 C10		1.501.562

ENGINE				
2.0 i 16V 4x4	Petrol	110	08/89-08/95	C 20 XE

Engine	Information	A10	A20	A40	A50	A70	C10 - C30	C20	E01
All engines	->eng. 14180385, version Bosch			1.306.251					
All engines	eng. type 14180386 ->, version Bosch			1.306.257					
All engines	version Bosch				1.406.121R				
All engines	ch. P1000001 ->, ch. P5000001 ->, ch. P7500001 ->								1.500.688

ENGINE				
2.0 i 16V Cat	Petrol	110	02/90-11/95	C 20 XE

Engine	Information	A10	A20	A40	A50	A70	C10 - C30	C20	E01
All engines	->eng. 14180385, version Bosch			1.306.251					
All engines	eng. type 14180386 ->, version Bosch			1.306.257					
All engines	version Bosch				1.406.121R				
All engines	ch. P1000001 ->, ch. P5000001 ->, ch. P7500001 ->								1.500.688

ENGINE				
2.0 i 4x4	Petrol	85	01/89-10/90	20 NE

Engine	Information	A10	A20	A40	A50	A70	C10 - C30	C20	E01
All engines	->ch. K1999999, ->ch. K5999999, ->ch. KV999999, version Bosch			1.306.240					
All engines	ch. L1000001 ->, ch. L5000001 ->, ch. LV100001 ->, version Bosch			1.306.257					
All engines	version Ducellier			1.315.084	1.415.103R				
All engines	version Bosch				1.406.127R				
All engines	->eng. 14180385, info WY						1.970.191 C10		
All engines	eng. type 14180386 ->, info WE						1.970.192 C10		
All engines	->eng. 14841581, eng. type 14672353 ->								1.500.689

ENGINE				
2.0 i 4x4	Petrol	95	08/89-07/92	20 SEH

Engine	Information	A10	A20	A40	A50	A70	C10 - C30	C20	E01
All engines	->ch. K1999999, ->ch. K5999999, ->ch. KV999999, version Bosch			1.306.240					
All engines	ch. L1000001 ->, ch. L5000001 ->, ch. LV100001 ->, version Bosch			1.306.257					
All engines	version Ducellier			1.315.084	1.415.103R				
All engines	version Bosch				1.406.127R				
All engines	->eng. 14180385, info WY						1.970.191 C10		
All engines	eng. type 14180386 ->, info WE						1.970.192 C10		
All engines	eng. type 14672353 ->								1.500.689

ENGINE				
2.0 i Cat	Petrol	85	09/88-11/95	C 20 NE

Engine	Information	A10	A20	A40	A50	A70	C10 - C30	C20	E01
All engines	->ch. K1999999, ->ch. K5999999, ->ch. KV999999, version Bosch			1.306.240					
All engines	ch. L1000001 ->, ch. L5000001 ->, ch. LV100001 ->, version Bosch			1.306.257					
All engines	version Ducellier			1.315.084	1.415.103R				
All engines	version Bosch				1.406.127R				
All engines	->eng. 14180385, info WY						1.970.191 C10		
All engines	eng. type 14180386 ->, info WE						1.970.192 C10		
All engines	->eng. 14841581, eng. type 14672353 ->								1.500.689

ENGINE				
2.0 i Cat 4x4	Petrol	85	01/89-11/95	C 20 NE

Engine	Information	A10	A20	A40	A50	A70	C10 - C30	C20	E01
All engines	->ch. K1999999, ->ch. K5999999, ->ch. KV999999, version Bosch			1.306.240					
All engines	ch. L1000001 ->, ch. L5000001 ->, ch. LV100001 ->, version Bosch			1.306.257					
All engines	version Ducellier			1.315.084	1.415.103R				
All engines	version Bosch				1.406.127R				

A10 CONDENSER	A20 CONTACT SET	A40 DISTRIBUTOR CAP	A50 ROTOR	A70 PICK-UP
C10 COIL	C20 IGNITION MODULE	C30 ELECTRONIC IGNITION KIT	E01 IGNITION CABLE SET	

Vehicle	alim.	kW	Date	Engine	FUNCTIONS ON THE VEHICLE							
					A10	A20	A40	A50	A70	C10 - C30	C20	E01

					ENGINE					
2.0 i Cat 4x4	Petrol	85	01/89-11/95	C 20 NE						

Engine	Information	A10	A20	A40	A50	A70	C10 - C30	C20	E01
All engines	->eng. 14180385, info WY						1.970.191	C10	
All engines	eng. type 14180386 ->, info WE						1.970.192	C10	
All engines	->eng. 14841581, eng. type 14672353 ->								1.500.689

					ENGINE					
2.0 i GT	Petrol	95	09/88-11/95	20 SEH						

Engine	Information	A10	A20	A40	A50	A70	C10 - C30	C20	E01
All engines	->ch. K1999999, ->ch. K5999999, ->ch. KV999999, version Bosch			1.306.240					
All engines	ch. L1000001 ->, ch. L5000001 ->, ch. LV100001 ->, version Bosch			1.306.257					
All engines	version Ducellier			1.315.084	1.415.103R				
All engines	version Bosch				1.406.127R				
All engines	->eng. 14180385, info WY						1.970.191	C10	
All engines	eng. type 14180386 ->, info WE						1.970.192	C10	
All engines	eng. type 14672353 ->								1.500.689

					ENGINE					
2.0 i Turbo 4x4	Petrol	150	06/94-11/95	C 20 LET						

Engine	Information	A10	A20	A40	A50	A70	C10 - C30	C20	E01
All engines	version Bosch			1.306.257	1.406.121R				

					ENGINE					
2000 16V 4x4	Petrol	110	01/89-10/90	20 XEJ						

Engine	Information	A10	A20	A40	A50	A70	C10 - C30	C20	E01
All engines	->eng. 14180385, version Bosch			1.306.251					
All engines	eng. type 14180386 ->, version Bosch			1.306.257					
All engines	version Bosch				1.406.121R				
All engines	ch. P1000001 ->, ch. P5000001 ->, ch. P7500001 ->								1.500.688

					ENGINE					
2000/GT 16V	Petrol	110	01/89-06/94	20 XEJ						

Engine	Information	A10	A20	A40	A50	A70	C10 - C30	C20	E01
All engines	->eng. 14180385, version Bosch			1.306.251					
All engines	eng. type 14180386 ->, version Bosch			1.306.257					
All engines	version Bosch				1.406.121R				
All engines	ch. P1000001 ->, ch. P5000001 ->, ch. P7500001 ->								1.500.688

					ENGINE					
2000/GT 16V Cat	Petrol	110	02/90-11/95	C 20 XE						

Engine	Information	A10	A20	A40	A50	A70	C10 - C30	C20	E01
All engines	->eng. 14180385, version Bosch			1.306.251					
All engines	eng. type 14180386 ->, version Bosch			1.306.257					
All engines	version Bosch				1.406.121R				
All engines	ch. P1000001 ->, ch. P5000001 ->, ch. P7500001 ->								1.500.688

					ENGINE					
2000/GT 16V Cat 4x4	Petrol	110	02/90-11/95	C 20 XE						

Engine	Information	A10	A20	A40	A50	A70	C10 - C30	C20	E01
All engines	->eng. 14180385, version Bosch			1.306.251					
All engines	eng. type 14180386 ->, version Bosch			1.306.257					
All engines	version Bosch				1.406.121R				
All engines	ch. P1000001 ->, ch. P5000001 ->, ch. P7500001 ->								1.500.688

VECTRA B

					ENGINE					
1.6 i	Petrol	55	10/95-07/03	16 LZ2, X 16 SZR						

Engine	Information	A10	A20	A40	A50	A70	C10 - C30	C20	E01
Eng. 16 LZ2	version Ducellier			1.315.084	1.415.103R				
Eng. 16 LZ2	x 1, SAGEM, DISTRIBUTOR, connector type, saw teeth						1.970.140	C10	
Eng. 16 LZ2								1.965.036	
Eng. X 16 SZR	->eng. 02HP7704								1.501.531
Eng. X 16 SZR	eng. type 02HP7705 ->								1.501.904

A10 CONDENSER	A20 CONTACT SET	A40 DISTRIBUTOR CAP	A50 ROTOR	A70 PICK-UP
C10 COIL	C20 IGNITION MODULE	C30 ELECTRONIC IGNITION KIT	E01 IGNITION CABLE SET	

The present application list is a brief version. For the detailed information about the possibility of installation on a specific vehicle, please refer to our web-catalogue <http://catalogo.facet.eu/>

Vehicle	alim.	kW	Date	Engine	FUNCTIONS ON THE VEHICLE							
					A10	A20	A40	A50	A70	C10 - C30	C20	E01

ENGINE				
1.6 i 16V	Petrol	74	10/95-07/02	X 16 XEL, Y 16 XE, Z 16 XE

Engine	Information	A10	A20	A40	A50	A70	C10 - C30	C20	E01
All engines	ch. W1285447 ->, x 4, ch. W5276826 ->, COIL ON PLUG, ch. W7154259 ->, incl. spark plug connector, ch. W1000002 ->, ch. W1000002 ->, ch. W5000002 ->, x 4, COIL ON PLUG, x 4, COIL ON PLUG, incl. spark plug connector, incl. spark plug connector						1.970.399	C10	
Eng. X 16 XEL	->ch. W1285449, ->ch. W5276825, ->ch. W7154258								1.500.688

ENGINE				
1.8 FlexFuel	Petrol/ Liquified Petro- leum Gas (LPG)	85	01/99-09/00	X 18 XE

Engine	Information	A10	A20	A40	A50	A70	C10 - C30	C20	E01
All engines	x 1, D.I.S.						1.970.272	C10	

ENGINE				
1.8 i 16V	Petrol	85	10/95-09/00	X 18 XE, X 18 XE1, Z 18 XEL

Engine	Information	A10	A20	A40	A50	A70	C10 - C30	C20	E01
Eng. X 18 XE	x 1, D.I.S.						1.970.272	C10	
Eng. X 18 XE1, Z 18 XEL	x 1, COIL ON PLUG, incl. spark plug connector						1.970.508	C10	
Eng. X 18 XE	no specific info conc. application available								1.501.506, 1.501.562

ENGINE				
1.8 i 16V	Petrol	92	09/00-07/03	Z 18 XE

Engine	Information	A10	A20	A40	A50	A70	C10 - C30	C20	E01
All engines	x 1, COIL ON PLUG, incl. spark plug connector						1.970.508	C10	

ENGINE				
2.0 i	Petrol	82	10/95-04/02	20 NEJ

Engine	Information	A10	A20	A40	A50	A70	C10 - C30	C20	E01
All engines	x 1, BOSCH, D.I.S., connector type, saw teeth						1.970.273	C10	

ENGINE				
2.0 i 16V	Petrol	100	09/95-06/00	C 20 SEL, X 20 XEV

Engine	Information	A10	A20	A40	A50	A70	C10 - C30	C20	E01
All engines	x 1, D.I.S.						1.970.272	C10	
All engines	no specific info conc. application available								1.501.506, 1.501.562

ENGINE				
2.0 i 16V	Petrol	85	07/00-07/03	C 20 SEL

Engine	Information	A10	A20	A40	A50	A70	C10 - C30	C20	E01
All engines	x 1, D.I.S.						1.970.272	C10	

ENGINE				
2.2 i 16V	Petrol	102	07/00-07/02	C 22 SEL

Engine	Information	A10	A20	A40	A50	A70	C10 - C30	C20	E01
All engines	x 1, D.I.S.						1.970.272	C10	

VECTRA C

ENGINE				
1.6	Petrol	74	08/05-08/08	Z 16 XE

Engine	Information	A10	A20	A40	A50	A70	C10 - C30	C20	E01
All engines	x 1, COIL ON PLUG, incl. spark plug connector						1.970.399	C10	

ENGINE				
1.6	Petrol	77	08/05-08/08	Z 16 XEP

Engine	Information	A10	A20	A40	A50	A70	C10 - C30	C20	E01
All engines	x 1, DELPHI, COIL ON PLUG, incl. spark plug connector						1.970.450	C10	

ENGINE				
1.6 i 16V	Petrol	74	06/04-10/05	Z 16 XE

Engine	Information	A10	A20	A40	A50	A70	C10 - C30	C20	E01
All engines	x 1, COIL ON PLUG, incl. spark plug connector						1.970.399	C10	

ENGINE				
1.8	Petrol	103	08/05-08/08	Z 18 XER

Engine	Information	A10	A20	A40	A50	A70	C10 - C30	C20	E01
All engines	x 1, DELPHI, COIL ON PLUG, incl. spark plug connector						1.970.450	C10	

A10 CONDENSER	A20 CONTACT SET	A40 DISTRIBUTOR CAP	A50 ROTOR	A70 PICK-UP
C10 COIL	C20 IGNITION MODULE	C30 ELECTRONIC IGNITION KIT	E01 IGNITION CABLE SET	

Vehicle	alim.	kW	Date	Engine	FUNCTIONS ON THE VEHICLE									
					A10	A20	A40	A50	A70	C10 - C30	C20	E01		
ENGINE														
1.8	Petrol	81	04/02-07/08	Z 18 XEL										
Engine		Information			A10	A20	A40	A50	A70	C10 - C30	C20	E01		
All engines		x 1, COIL ON PLUG, incl. spark plug connector								1.970.508	C10			
ENGINE														
1.8	Petrol	90	10/03-09/06	Z 18 XE										
Engine		Information			A10	A20	A40	A50	A70	C10 - C30	C20	E01		
All engines		x 1, COIL ON PLUG, incl. spark plug connector								1.970.508	C10			
ENGINE														
1.8 16V	Petrol	81	08/02-12/06	Z 18 XEL										
Engine		Information			A10	A20	A40	A50	A70	C10 - C30	C20	E01		
All engines		x 1, COIL ON PLUG, incl. spark plug connector								1.970.508	C10			
ENGINE														
1.8 16V	Petrol	90	04/02-09/08	Z 18 XE										
Engine		Information			A10	A20	A40	A50	A70	C10 - C30	C20	E01		
All engines		x 1, COIL ON PLUG, incl. spark plug connector								1.970.508	C10			
VIVARO A														
ENGINE														
2.0 16V	Petrol	88	08/01-07/06	F4R 720										
Engine		Information			A10	A20	A40	A50	A70	C10 - C30	C20	E01		
All engines		x 4, COIL ON PLUG								1.970.432	C10			
ENGINE														
2.0 ECOTEC	Petrol	86	08/06-07/14	F4R 820										
Engine		Information			A10	A20	A40	A50	A70	C10 - C30	C20	E01		
All engines		x 4, COIL ON PLUG								1.970.432	C10			
ZAFIRA A														
ENGINE														
1.6	Petrol	76	10/03-06/05	Z 16 XEP										
Engine		Information			A10	A20	A40	A50	A70	C10 - C30	C20	E01		
All engines		x 1, DELPHI, COIL ON PLUG, incl. spark plug connector								1.970.450	C10			
ENGINE														
1.6 16V	Bi-Fuel	70	09/02-06/05	Z 16 YNG										
Engine		Information			A10	A20	A40	A50	A70	C10 - C30	C20	E01		
All engines										1.970.399	C10			
ENGINE														
1.6 16V	Petrol	74	04/99-06/05	X 16 XEL, Z 16 XE										
Engine		Information			A10	A20	A40	A50	A70	C10 - C30	C20	E01		
All engines		x 4, COIL ON PLUG, incl. spark plug connector								1.970.399	C10			
ENGINE														
1.6 16V	Petrol	76	10/03-06/05	Z 16 XEP										
Engine		Information			A10	A20	A40	A50	A70	C10 - C30	C20	E01		
All engines										1.970.450	C10			
ENGINE														
1.6 CNG	Petrol/ Com- pressed Natural Gas (CNG)	71	09/01-06/05	Z 16 YNG										
Engine		Information			A10	A20	A40	A50	A70	C10 - C30	C20	E01		
All engines		x 4, COIL ON PLUG, incl. spark plug connector								1.970.399	C10			
ENGINE														
1.6 LPG	Petrol/ Liquified Petro- leum Gas (LPG)	74	04/99-06/05	X 16 XEL, Z 16 XE										
Engine		Information			A10	A20	A40	A50	A70	C10 - C30	C20	E01		
All engines		x 4, COIL ON PLUG, incl. spark plug connector								1.970.399	C10			

A10	CONDENSER	A20	CONTACT SET	A40	DISTRIBUTOR CAP	A50	ROTOR	A70	PICK-UP
C10	COIL	C20	IGNITION MODULE	C30	ELECTRONIC IGNITION KIT	E01	IGNITION CABLE SET		

The present application list is a brief version. For the detailed information about the possibility of installation on a specific vehicle, please refer to our web-catalogue <http://catalogo.facet.eu/>









VEHICLE					FUNCTIONS ON THE VEHICLE								
Vehicle	alim.	kW	Date	Engine	A10	A20	A40	A50	A70	C10 - C30	C20	E01	
ENGINE													
1.6 LPG	Petrol/ Liquified Petro- leum Gas (LPG)	76	10/03-06/05	Z 16 XE						1.970.399	C10		
Engine	Information												
All engines	x 1, COIL ON PLUG, incl. spark plug connector												
ENGINE													
1.8	Petrol	81	02/03-06/05	Z 18 XEL						1.970.508	C10		
Engine	Information												
All engines													
ENGINE													
1.8 16V	Petrol	85	04/99-09/00	X 18 XE1						1.970.508	C10		
Engine	Information												
All engines	x 1, COIL ON PLUG, incl. spark plug connector												
ENGINE													
1.8 16V	Petrol	92	09/00-06/05	Z 18 XE						1.970.508	C10		
Engine	Information												
All engines	x 1, COIL ON PLUG, incl. spark plug connector												
ENGINE													
2.0 OPC	Petrol	141	09/01-06/05	Z 20 LET						1.970.507	C10		
Engine	Information												
All engines	x 1, COIL ON PLUG												
ENGINE													
2.0 OPC	Petrol	147	11/02-06/05	Z 20 LET						1.970.507	C10		
Engine	Information												
All engines	x 1, COIL ON PLUG												
ZAFIRA B													
ENGINE													
1.6	Petrol	77	07/05-09/12	Z 16 XE1, Z 16 XEP						1.970.450	C10		
Engine	Information												
All engines	x 1, DELPHI, COIL ON PLUG, incl. spark plug connector												
ENGINE													
1.6	Petrol	85	01/08-04/15	A 16 XER, Z 16 XER						1.970.450	C10		
Engine	Information												
All engines	x 1, DELPHI, COIL ON PLUG, incl. spark plug connector												
ENGINE													
1.6 CNG	Petrol/ Com- pressed Natural Gas (CNG)	69	07/05-04/15	Z 16 YNG						1.970.399	C10		
Engine	Information												
All engines	x 4, COIL ON PLUG, incl. spark plug connector												
ENGINE													
1.6 CNG Turbo	Petrol/ Com- pressed Natural Gas (CNG)	110	04/10-04/15	A 16 XNT, Z16XNT						1.970.450	C10		
Engine	Information												
All engines	x 1, DELPHI, COIL ON PLUG, incl. spark plug connector												
ENGINE													
1.6 CNG Turbo VAN	Petrol/ Com- pressed Natural Gas (CNG)	110	02/09-04/15	A 16 XNT, Z16XNT						1.970.450	C10		
Engine	Information												
All engines	x 1, DELPHI, COIL ON PLUG, incl. spark plug connector												

A10 CONDENSER	A20 CONTACT SET	A40 DISTRIBUTOR CAP	A50 ROTOR	A70 PICK-UP
C10 COIL	C20 IGNITION MODULE	C30 ELECTRONIC IGNITION KIT	E01 IGNITION CABLE SET	

Vehicle	alim.	kW	Date	Engine	FUNCTIONS ON THE VEHICLE									
					A10	A20	A40	A50	A70	C10 - C30	C20	E01		
ENGINE														
1.6 CNG VAN	Petrol/ Compressed Natural Gas (CNG)	69	07/05-04/15	Z 16 YNG										
Engine	Information				A10	A20	A40	A50	A70	C10 - C30	C20	E01		
All engines	x 4, COIL ON PLUG, incl. spark plug connector									1.970.399	C10			
ENGINE														
1.6 FlexFuel	Petrol/ Ethanol	85	08/08-12/12	Z 16 XER										
Engine	Information				A10	A20	A40	A50	A70	C10 - C30	C20	E01		
All engines	x 1, DELPHI, COIL ON PLUG, incl. spark plug connector									1.970.450	C10			
ENGINE														
1.8	Petrol	103	07/05-04/15	A 18 XER, Z 18 XER										
Engine	Information				A10	A20	A40	A50	A70	C10 - C30	C20	E01		
All engines	x 1, DELPHI, COIL ON PLUG, incl. spark plug connector									1.970.450	C10			
ENGINE														
1.8	Petrol	88	06/13-04/15	A 18 XEL										
Engine	Information				A10	A20	A40	A50	A70	C10 - C30	C20	E01		
All engines	x 1, COIL ON PLUG									1.970.545	C10			
ENGINE														
1.8 LPG	Petrol/ Liquified Petro- leum Gas (LPG)	103	07/09-04/15	Z 18 XER										
Engine	Information				A10	A20	A40	A50	A70	C10 - C30	C20	E01		
All engines	x 1, DELPHI, COIL ON PLUG, incl. spark plug connector									1.970.450	C10			
ENGINE														
1.8 VAN	Petrol	103	07/05-04/15	A 18 XER, Z 18 XER										
Engine	Information				A10	A20	A40	A50	A70	C10 - C30	C20	E01		
All engines	x 1, DELPHI, COIL ON PLUG, incl. spark plug connector									1.970.450	C10			
ENGINE														
2.0	Petrol	147	07/05-12/10	Z 20 LER										
Engine	Information				A10	A20	A40	A50	A70	C10 - C30	C20	E01		
All engines	x 1, COIL ON PLUG									1.970.507	C10			
ENGINE														
2.0	Petrol	177	01/06-12/10	Z 20 LEH										
Engine	Information				A10	A20	A40	A50	A70	C10 - C30	C20	E01		
All engines	x 1, COIL ON PLUG									1.970.507	C10			
ENGINE														
2.0 VAN	Petrol	147	07/05-12/10	Z 20 LER										
Engine	Information				A10	A20	A40	A50	A70	C10 - C30	C20	E01		
All engines	x 1, COIL ON PLUG									1.970.507	C10			
ZAFIRA TOURER														
ENGINE														
1.4	Petrol	103	10/11->	A 14 NET, B 14 NET										
Engine	Information				A10	A20	A40	A50	A70	C10 - C30	C20	E01		
All engines	x 1, COIL ON RAIL									1.970.547	C10			
ENGINE														
1.4	Petrol	88	10/11->	A 14 NEL, B 14 NEL										
Engine	Information				A10	A20	A40	A50	A70	C10 - C30	C20	E01		
All engines	x 1, COIL ON RAIL									1.970.547	C10			
ENGINE														
1.4 LPG	Petrol/ Liquified Petro- leum Gas (LPG)	103	10/11->	A 14 NET, B 14 NET										
Engine	Information				A10	A20	A40	A50	A70	C10 - C30	C20	E01		
All engines	x 1, COIL ON RAIL									1.970.547	C10			

A10	CONDENSER	A20	CONTACT SET	A40	DISTRIBUTOR CAP	A50	ROTOR	A70	PICK-UP
C10	COIL	C20	IGNITION MODULE	C30	ELECTRONIC IGNITION KIT	E01	IGNITION CABLE SET		

The present application list is a brief version. For the detailed information about the possibility of installation on a specific vehicle, please refer to our web-catalogue <http://catalogo.facet.eu/>







					FUNCTIONS ON THE VEHICLE							
Vehicle	alim.	kW	Date	Engine								
					ENGINE							
1.6 CNG	Petrol/ Compressed Natural Gas (CNG)	110	10/11->	A 16 XNT, B 16 XNT								
Engine					A10	A20	A40	A50	A70	C10 - C30	C20	E01
All engines					x 1, DELPHI, COIL ON PLUG, incl. spark plug connector					1.970.450	C10	
					ENGINE							
1.8	Petrol	103	10/11->	A 18 XER								
Engine					A10	A20	A40	A50	A70	C10 - C30	C20	E01
All engines					x 1, COIL ON PLUG					1.970.545	C10	
					ENGINE							
1.8	Petrol	85	10/11->	A 18 XEL								
Engine					A10	A20	A40	A50	A70	C10 - C30	C20	E01
All engines					x 1, COIL ON PLUG					1.970.545	C10	
					ENGINE							
1.8	Petrol	88	10/11->	A 18 XEL								
Engine					A10	A20	A40	A50	A70	C10 - C30	C20	E01
All engines										1.970.545	C10	
					ENGINE							
1.8 LPG	Petrol/ Liquified Petroleum Gas (LPG)	101	10/11->	A 18 XER								
Engine					A10	A20	A40	A50	A70	C10 - C30	C20	E01
All engines										1.970.545	C10	

A10	CONDENSER	A20	CONTACT SET	A40	DISTRIBUTOR CAP	A50	ROTOR	A70	PICK-UP
C10	COIL	C20	IGNITION MODULE	C30	ELECTRONIC IGNITION KIT	E01	IGNITION CABLE SET		

Vehicle	alim.	kW	Date	Engine	FUNCTIONS ON THE VEHICLE									
					A10	A20	A40	A50	A70	C10 - C30	C20	E01		
1007														
1.4	Petrol	54	04/05->	ENGINE KFV (TU3A), KFV (TU3JP)										
Engine	Information				A10	A20	A40	A50	A70	C10 - C30	C20	E01		
All engines										1.970.405	C10			
1.4 16V														
1.4 16V	Petrol	65	10/05->	ENGINE KFU (ET3J4)										
Engine	Information				A10	A20	A40	A50	A70	C10 - C30	C20	E01		
All engines	x 1, COIL ON PLUG									1.970.483	C10			
1.6 16V														
1.6 16V	Petrol	80	04/05->	ENGINE NFU (TU5JP4)										
Engine	Information				A10	A20	A40	A50	A70	C10 - C30	C20	E01		
All engines	x 1, COIL ON PLUG									1.970.407	C10			
104														
0.9	Petrol	33	09/73-10/83	ENGINE 108 (XV3), 108 (XV5)										
Engine	Information				A10	A20	A40	A50	A70	C10 - C30	C20	E01		
Eng. 108 (XV5)	version Ducllier				1.115.034	1.215.103	1.315.058	1.415.088						
All engines						1.215.076								
0.9														
0.9	Petrol	34	10/72-10/79	ENGINE 108 (XV3)										
Engine	Information				A10	A20	A40	A50	A70	C10 - C30	C20	E01		
All engines						1.215.076								
1.0														
1.0	Petrol	32	09/83-06/88	ENGINE 108C (XV8)										
Engine	Information				A10	A20	A40	A50	A70	C10 - C30	C20	E01		
All engines	version Bosch						1.306.124	1.406.056R						
All engines											1.965.005			
1.1														
1.1	Petrol	42	07/76-06/83	ENGINE 109 (XW3)										
Engine	Information				A10	A20	A40	A50	A70	C10 - C30	C20	E01		
All engines						1.215.076								
106 I														
1.0	Petrol	33	09/91-03/01	ENGINE CDY (TU9M), TU9										
Engine	Information				A10	A20	A40	A50	A70	C10 - C30	C20	E01		
Eng. TU9	version Bosch						1.306.241	1.406.056R						
Eng. TU9	version Ducllier						1.315.074	1.415.102R	1.915.019					
Eng. TU9	version Marelli							1.430.060						
Eng. TU9										1.970.155	C10	1.500.780		
All engines	x 1, D.I.S., connector type, saw teeth									1.970.188	C10			
Eng. CDY (TU9M)										1.970.189	C10	1.501.374		
1.0														
1.0	Petrol	37	09/91-04/96	ENGINE CDZ (TU9M)										
Engine	Information				A10	A20	A40	A50	A70	C10 - C30	C20	E01		
All engines										1.970.189	C10	1.501.374		
1.1														
1.1	Petrol	44	08/91-04/96	ENGINE H1B (TU1), HDZ (TU1M)										
Engine	Information				A10	A20	A40	A50	A70	C10 - C30	C20	E01		
All engines	version Bosch, ->year 01/07/92						1.306.241							
All engines	version Ducllier, ->year 01/07/92						1.315.074	1.415.102R	1.915.019					
Eng. HDZ (TU1M)	version Bosch, ->year 01/07/92							1.406.026R						
Eng. H1B (TU1)	version Bosch							1.406.056R						
Eng. H1B (TU1)	version Marelli							1.430.060						
All engines	->year 01/07/92									1.970.155	C10	1.500.780		
Eng. HDZ (TU1M)	01/07/92 ->									1.970.189	C10	1.501.374		
1.3														
1.3	Petrol	72	10/93-04/96	ENGINE TU2J2										
Engine	Information				A10	A20	A40	A50	A70	C10 - C30	C20	E01		
All engines										1.970.189	C10	1.501.374		

A10 CONDENSER	A20 CONTACT SET	A40 DISTRIBUTOR CAP	A50 ROTOR	A70 PICK-UP
C10 COIL	C20 IGNITION MODULE	C30 ELECTRONIC IGNITION KIT	E01 IGNITION CABLE SET	

The present application list is a brief version. For the detailed information about the possibility of installation on a specific vehicle, please refer to our web-catalogue <http://catalogo.facet.eu/>

				FUNCTIONS ON THE VEHICLE								
Vehicle	alim.	kW	Date	Engine								
				ENGINE								
1.4	Petrol	51	08/91-03/96	K5A (TU3)								
				ENGINE								
Engine	Information			A10	A20	A40	A50	A70	C10 - C30	C20	E01	
All engines	version Bosch					1.306.241	1.406.026R					
All engines	version Ducellier					1.315.074	1.415.102R	1.915.019				
All engines									1.970.155	C10		1.500.780
				ENGINE								
1.4	Petrol	55	09/91-04/96	KDX (TU3MC), KDY (TU3M)								
				ENGINE								
Engine	Information			A10	A20	A40	A50	A70	C10 - C30	C20	E01	
Eng. KDY (TU3M)	version Bosch					1.306.241	1.406.056R					
Eng. KDY (TU3M)	version Ducellier					1.315.074	1.415.102R	1.915.019				
Eng. KDY (TU3M)									1.970.155	C10		1.500.780
Eng. KDX (TU3MC)									1.970.189	C10		1.501.374
				ENGINE								
1.4 i	Petrol	55	01/92-12/96	TU3FMC								
				ENGINE								
Engine	Information			A10	A20	A40	A50	A70	C10 - C30	C20	E01	
All engines									1.970.189	C10		1.501.025
				ENGINE								
1.4 i	Petrol	69	01/91-12/96	TU3FJ								
				ENGINE								
Engine	Information			A10	A20	A40	A50	A70	C10 - C30	C20	E01	
All engines									1.970.189	C10		1.501.025
				ENGINE								
1.4 i XSI	Petrol	72	09/91-03/96	TU3J								
				ENGINE								
Engine	Information			A10	A20	A40	A50	A70	C10 - C30	C20	E01	
All engines									1.970.189	C10		1.501.374
				ENGINE								
1.4 Le Mans	Petrol	69	09/91-11/94	KFZ (TU3J2/Z)								
				ENGINE								
Engine	Information			A10	A20	A40	A50	A70	C10 - C30	C20	E01	
All engines									1.970.189	C10		1.501.374
				ENGINE								
1.6	Petrol	65	06/93-04/96	NFZ (TU5JP)								
				ENGINE								
Engine	Information			A10	A20	A40	A50	A70	C10 - C30	C20	E01	
All engines									1.970.189	C10		1.501.374
				ENGINE								
1.6	Petrol	76	11/94-04/96	NFY (TU5J2)								
				ENGINE								
Engine	Information			A10	A20	A40	A50	A70	C10 - C30	C20	E01	
All engines									1.970.189	C10		1.501.374
				ENGINE								
106 II				ENGINE								
1.0 i	Petrol	33	05/96-10/99	CDY (TU9M)								
				ENGINE								
Engine	Information			A10	A20	A40	A50	A70	C10 - C30	C20	E01	
All engines	x 1, D.I.S., connector type, saw teeth								1.970.188	C10		
All engines												1.501.374
				ENGINE								
1.0 i	Petrol	37	04/96-03/01	CDZ (TU9M)								
				ENGINE								
Engine	Information			A10	A20	A40	A50	A70	C10 - C30	C20	E01	
All engines	x 1, D.I.S., connector type, saw teeth								1.970.188	C10		
All engines												1.501.374
				ENGINE								
1.1	Petrol	40	04/96->	H1B (TU1)								
				ENGINE								
Engine	Information			A10	A20	A40	A50	A70	C10 - C30	C20	E01	
All engines	version Ducellier					1.315.074	1.415.102R	1.915.019				
All engines									1.970.155	C10		1.500.780
				ENGINE								
1.1 BiFuel	Petrol/ Liquified Petro- leum Gas (LPG)	44	04/96-03/01	HDZ (TU1M+)								
				ENGINE								
Engine	Information			A10	A20	A40	A50	A70	C10 - C30	C20	E01	
All engines	x 1, D.I.S., connector type, saw teeth								1.970.188	C10		









A10 CONDENSER	A20 CONTACT SET	A40 DISTRIBUTOR CAP	A50 ROTOR	A70 PICK-UP
C10 COIL	C20 IGNITION MODULE	C30 ELECTRONIC IGNITION KIT	E01 IGNITION CABLE SET	

Vehicle	alim.	kW	Date	Engine	FUNCTIONS ON THE VEHICLE									
					A10	A20	A40	A50	A70	C10 - C30	C20	E01		
ENGINE														
1.1 i	Petrol	40	01/97-03/01	HDY (TU1M), HDY (TU1M+)										
Engine	Information				A10	A20	A40	A50	A70	C10 - C30	C20	E01		
Eng. HDY (TU1M+)	x 1, D.I.S., connector type, saw teeth									1.970.188	C10			
Eng. HDY (TU1M)													1.501.374	
ENGINE														
1.1 i	Petrol	44	05/96-07/04	HDZ (TU1M), HFX (TU1JP)										
Engine	Information				A10	A20	A40	A50	A70	C10 - C30	C20	E01		
Eng. HDZ (TU1M)										1.970.188	C10		1.501.374	
Eng. HFX (TU1JP)										1.970.405	C10			
ENGINE														
1.4 i	Petrol	55	05/96-07/04	KFW (TU3JP), KFX (TU3JP)										
Engine	Information				A10	A20	A40	A50	A70	C10 - C30	C20	E01		
All engines	x 1, D.I.S., connector type, saw teeth									1.970.188	C10			
All engines	euro 2, x 4, Electricfil, COIL ON PLUG									1.970.403	C10			
All engines	euro 3, x 1, COIL ON PLUG									1.970.405	C10			
All engines	->year 04/01/98, man., aut.												1.501.374	
ENGINE														
1.6 i	Petrol	65	05/96-10/99	NFZ (TU5JP)										
Engine	Information				A10	A20	A40	A50	A70	C10 - C30	C20	E01		
All engines	x 1, D.I.S., connector type, saw teeth									1.970.188	C10			
All engines													1.501.374	
ENGINE														
1.6 i	Petrol	74	05/96-01/01	NFW (TU5J2), NFY (TU5J2)										
Engine	Information				A10	A20	A40	A50	A70	C10 - C30	C20	E01		
All engines	x 1, D.I.S.									1.970.189	C10			
All engines													1.501.374	
107														
ENGINE														
1.0	Petrol	50	06/05-05/14	1KR (384 F), CFA (384F), CFB (1KR)										
Engine	Information				A10	A20	A40	A50	A70	C10 - C30	C20	E01		
Eng. 1KR (384 F)	Qty: 3									1.970.461	C10			
Eng. CFA (384F), CFB (1KR)	x 3, COIL ON PLUG									1.970.461	C10			
108														
ENGINE														
1.0 VTi	Petrol	51	05/14->	1KR-FE, CFB (1KR)										
Engine	Information				A10	A20	A40	A50	A70	C10 - C30	C20	E01		
Eng. 1KR-FE	Qty: 3									1.970.459	C10			
Eng. CFB (1KR)	euro5/euro6, x 3, COIL ON PLUG									1.970.459	C10			
ENGINE														
1.0 VTi 72	Petrol	53	05/18->	CFB (1KR)										
Engine	Information				A10	A20	A40	A50	A70	C10 - C30	C20	E01		
All engines	euro5/euro6, x 3, COIL ON PLUG									1.970.459	C10			
ENGINE														
1.2	Petrol	60	05/14->	HMT (EB2D), HMZ (EB2), HMZ (EB2F)										
Engine	Information				A10	A20	A40	A50	A70	C10 - C30	C20	E01		
All engines	x 3, COIL ON PLUG									1.970.609	C10			
ENGINE														
1.2 VTi	Petrol	60	05/14->	HMZ (EB2)										
Engine	Information				A10	A20	A40	A50	A70	C10 - C30	C20	E01		
All engines	Qty: 3									1.970.609	C10			
ENGINE														
108 1.2	Petrol	60	05/14->	HMZ (EB2F)										
Engine	Information				A10	A20	A40	A50	A70	C10 - C30	C20	E01		
All engines	Qty: 3									1.970.609	C10			

A10	CONDENSER	A20	CONTACT SET	A40	DISTRIBUTOR CAP	A50	ROTOR	A70	PICK-UP
C10	COIL	C20	IGNITION MODULE	C30	ELECTRONIC IGNITION KIT	E01	IGNITION CABLE SET		

The present application list is a brief version. For the detailed information about the possibility of installation on a specific vehicle, please refer to our web-catalogue <http://catalogo.facet.eu/>

				FUNCTIONS ON THE VEHICLE										
Vehicle	alim.	kW	Date	Engine	A10	A20	A40	A50	A70	C10 - C30	C20	E01		
2008 I														
1.2 PureTech 82	Petrol	61	01/18-12/19	ENGINE HMR (EB2FA)										
Engine	Information			A10	A20	A40	A50	A70	C10 - C30	C20	E01			
All engines	x 3, COIL ON PLUG								1.970.609	C10				
1.2 THP 130 / PureTech 130	Petrol	96	01/15->	ENGINE HNS (EB2ADTS), HNY (EB2DTS)										
Engine	Information			A10	A20	A40	A50	A70	C10 - C30	C20	E01			
All engines	x 3, COIL ON PLUG								1.970.620	C10				
1.2 VTi	Petrol	60	03/13->	ENGINE HMZ (EB2), HMZ (EB2F)										
Engine	Information			A10	A20	A40	A50	A70	C10 - C30	C20	E01			
All engines	x 3, COIL ON PLUG								1.970.609	C10				
Eng. HMZ (EB2)	Qty: 3								1.970.609	C10				
1.6 VTi	Petrol	85	05/13->	ENGINE 5FS (EP6C)										
Engine	Information			A10	A20	A40	A50	A70	C10 - C30	C20	E01			
All engines	x 4, COIL ON PLUG								1.970.475	C10				
1.6 VTi	Petrol	88	03/13->	ENGINE 5FS (EP6C)										
Engine	Information			A10	A20	A40	A50	A70	C10 - C30	C20	E01			
All engines	x 4, COIL ON PLUG								1.970.475	C10				
PureTech 130	Petrol	96	01/18->	ENGINE HNS (EB2ADTS), HNY (EB2DTS)										
Engine	Information			A10	A20	A40	A50	A70	C10 - C30	C20	E01			
All engines	x 3, COIL ON PLUG								1.970.620	C10				
204														
1.1	Petrol	39	10/65-07/69	ENGINE XK										
Engine	Information			A10	A20	A40	A50	A70	C10 - C30	C20	E01			
All engines					1.215.111U		1.406.014R							
1.1	Petrol	40	05/69-07/77	ENGINE XK4										
Engine	Information			A10	A20	A40	A50	A70	C10 - C30	C20	E01			
All engines					1.215.111U		1.406.014R							
1.1	Petrol	43	09/75-07/77	ENGINE XK5										
Engine	Information			A10	A20	A40	A50	A70	C10 - C30	C20	E01			
All engines					1.215.111U		1.406.014R							
1.1 Grand Luxe	Petrol	40	05/69-10/77	ENGINE XK4										
Engine	Information			A10	A20	A40	A50	A70	C10 - C30	C20	E01			
All engines					1.215.111U		1.406.014R							
205 I														
1.0	Petrol	33	02/83-12/90	ENGINE 108C (XV8)										
Engine	Information			A10	A20	A40	A50	A70	C10 - C30	C20	E01			
All engines	version Bosch					1.306.124	1.406.056R							
All engines	version Ducellier, distr. num. 2525569 A					1.315.058								
All engines	version Ducellier, distr. num. 2525569 B					1.315.067								
All engines	version Ducellier						1.415.094							
All engines										1.965.005				
1.1	Petrol	36	02/83-10/87	ENGINE 109N (XW7)										
Engine	Information			A10	A20	A40	A50	A70	C10 - C30	C20	E01			
All engines	version Ducellier, distr. num. 525 483 A, distr. num. 525 512 A, distr. num. 525 512 B, distr. num. 525 480 A, 2 525 574 A					1.315.058								
All engines	version Ducellier, distr. num. 525 512 C, 2 525 574 B					1.315.067								
All engines	version Ducellier						1.415.094							
All engines										1.965.005	1.500.846			
A10	CONDENSER		A20	CONTACT SET		A40	DISTRIBUTOR CAP		A50	ROTOR		A70	PICK-UP	
C10	COIL		C20	IGNITION MODULE		C30	ELECTRONIC IGNITION KIT		E01	IGNITION CABLE SET				

				FUNCTIONS ON THE VEHICLE								
Vehicle	alim.	kW	Date	Engine								
				ENGINE								
1.1	Petrol	37	02/83-10/87	109F (XW7)								
	Engine	Information		A10	A20	A40	A50	A70	C10 - C30	C20	E01	
	All engines	version Ducellier, distr. num. 525 483 A, distr. num. 525 512 A, distr. num. 525 512 B, distr. num. 525 480 A, 2 525 574 A				1.315.058						
	All engines	version Ducellier, distr. num. 525 512 C, 2 525 574 B				1.315.067						
	All engines	version Ducellier					1.415.094					
	All engines									1.965.005	1.500.846	
1.3	Petrol	47	02/84-10/87	G1A								
	Engine	Information		A10	A20	A40	A50	A70	C10 - C30	C20	E01	
	All engines	version Bosch				1.306.124	1.406.061R					
	All engines	version Ducellier				1.315.058	1.415.094					
	All engines	01/01/89 ->							1.970.106	C10		
	All engines									1.965.005		
1.4	Petrol	44	02/83-10/87	150D (XY7), 150G (XY7)								
	Engine	Information		A10	A20	A40	A50	A70	C10 - C30	C20	E01	
	Eng. 150G (XY7)	version Bosch				1.306.124	1.406.056R					
	All engines	version Ducellier, distr. num. 525 520 A/B, distr. num. 525 490 A, 525 475 A				1.315.058						
	All engines	distr. num. 2 525 20 C, version Ducellier, distr. num. 525 490 B/C				1.315.067						
	All engines	version Ducellier					1.415.094					
	All engines									1.965.005	1.500.846	
1.4	Petrol	53	02/83-10/87	150 (XY6B)								
	Engine	Information		A10	A20	A40	A50	A70	C10 - C30	C20	E01	
	All engines	version Ducellier, distr. num. 525 520 A/B				1.315.058						
	All engines	distr. num. 2 525 20 C, version Ducellier				1.315.067						
	All engines	version Ducellier					1.415.094					
	All engines									1.965.005	1.500.846	
1.4	Petrol	58	10/85-10/87	150H (XY8)								
	Engine	Information		A10	A20	A40	A50	A70	C10 - C30	C20	E01	
	All engines	version Bosch				1.306.124	1.406.056R					
	All engines	version Ducellier				1.315.058	1.415.094					
	All engines									1.965.005	1.500.846	
1.4	Petrol	59	02/83-10/87	150B (XY8)								
	Engine	Information		A10	A20	A40	A50	A70	C10 - C30	C20	E01	
	All engines	version Bosch				1.306.124	1.406.056R					
	All engines	version Ducellier				1.315.058	1.415.094					
	All engines									1.965.005	1.500.846	
1.5	Petrol	63	02/84-10/87	Y2/K								
	Engine	Information		A10	A20	A40	A50	A70	C10 - C30	C20	E01	
	All engines	version Bosch				1.306.124	1.406.025R					
	All engines	version Ducellier				1.315.058	1.415.094					
	All engines	01/01/89 ->							1.970.106	C10		
	All engines									1.965.005		
1.6	Petrol	53	03/87-10/87	B1E (XU51C)								
	Engine	Information		A10	A20	A40	A50	A70	C10 - C30	C20	E01	
	All engines	version Bosch				1.306.124	1.406.056R					
	All engines	version Ducellier, distr. num. 2 525 626 A				1.315.058						
	All engines	version Ducellier, distr. num. 2 525 626 B/C				1.315.067						
	All engines	version Ducellier, distr. num. 2 525 663 A				1.315.074	1.415.102R	1.915.019				
	All engines	version Ducellier, distr. num. 2 525 626 A/B/C					1.415.094					
	All engines	version Ducellier, distr. num. 2 525 640 B/C						1.915.017				
	All engines									1.965.005		
	All engines	ch. 7330001 ->, ->year 01/01/90										1.500.747
	All engines	01/01/90 ->										1.500.748

A10 CONDENSER	A20 CONTACT SET	A40 DISTRIBUTOR CAP	A50 ROTOR	A70 PICK-UP
C10 COIL	C20 IGNITION MODULE	C30 ELECTRONIC IGNITION KIT	E01 IGNITION CABLE SET	

The present application list is a brief version. For the detailed information about the possibility of installation on a specific vehicle, please refer to our web-catalogue <http://catalogo.facet.eu/>

Vehicle	alim.	kW	Date	Engine	FUNCTIONS ON THE VEHICLE							
					A10	A20	A40	A50	A70	C10 - C30	C20	E01

ENGINE				
1.6	Petrol	55	08/86-10/87	B1A (XU51C), BAZ (XU5CP)

Engine	Information	A10	A20	A40	A50	A70	C10 - C30	C20	E01
All engines	version Bosch			1.306.124	1.406.056R				
All engines	version Ducellier, distr. num. 2 525 626 A			1.315.058					
All engines	version Ducellier, distr. num. 2 525 626 B/C, distr. num. 2 525 683 A/B			1.315.067					
Eng. B1A (XU51C)	version Ducellier, distr. num. 2 525 663 A			1.315.074	1.415.102R	1.915.019			
All engines	version Ducellier, distr. num. 2 525 626 A/B/C				1.415.094				
All engines	version Ducellier, distr. num. 2 525 640 B/C, distr. num. 2 525 626 B/C, distr. num. 2 525 683 A/B					1.915.017			
All engines								1.965.005	
All engines	ch. 7330001 ->, ->year 01/01/90								1.500.747
Eng. B1A (XU51C)	01/01/90 ->								1.500.748

ENGINE				
1.6 GTI	Petrol	76	12/84-10/87	180A (XU5J)

Engine	Information	A10	A20	A40	A50	A70	C10 - C30	C20	E01
All engines	version Bosch			1.306.124	1.406.056R				
All engines								1.965.005	
All engines	ch. 7330001 ->								1.500.747

ENGINE				
1.6 GTI	Petrol	85	02/83-07/87	B6D (XU5JA)

Engine	Information	A10	A20	A40	A50	A70	C10 - C30	C20	E01
All engines	version Bosch			1.306.124	1.406.056R				
All engines								1.965.005	
All engines	01/01/90 ->								1.500.491
All engines	ch. 7330001 ->, ->year 01/01/90								1.500.747

ENGINE				
1.9 GTI	Petrol	75	03/87-10/87	DFZ (XU9J1)

Engine	Information	A10	A20	A40	A50	A70	C10 - C30	C20	E01
All engines	version Bosch			1.306.124	1.406.056R				
All engines	version Ducellier			1.315.067	1.415.094	1.915.017			
All engines								1.965.005	
All engines	ch. 7330001 ->								1.500.747

ENGINE				
1.9 GTI	Petrol	94	10/86-10/87	D6B (XU9JA)

Engine	Information	A10	A20	A40	A50	A70	C10 - C30	C20	E01
All engines	version Bosch			1.306.241	1.406.056R				
All engines							1.970.105	C10	1.965.005

205 II

ENGINE				
1.0	Petrol	33	10/87-09/98	TU9

Engine	Information	A10	A20	A40	A50	A70	C10 - C30	C20	E01
All engines	version Bosch			1.306.241	1.406.056R				
All engines	version Ducellier			1.315.074	1.415.102R	1.915.019			
All engines	version Marelli				1.430.060				
All engines	See connection type						1.970.105, 1.970.155	C10	
All engines									1.500.780

ENGINE				
1.0	Petrol	37	08/92-05/97	CDZ (TU9M)

Engine	Information	A10	A20	A40	A50	A70	C10 - C30	C20	E01
All engines							1.970.189	C10	

ENGINE				
1.1	Petrol	36	10/87-10/90	109N (XW7)

Engine	Information	A10	A20	A40	A50	A70	C10 - C30	C20	E01
All engines	version Ducellier, distr. num. 525 483 A, distr. num. 525 512 A, distr. num. 525 512 B, distr. num. 525 480 A, 2 525 574 A			1.315.058					
All engines	version Ducellier, distr. num. 525 512 C, 2 525 574 B			1.315.067					
All engines	version Ducellier				1.415.094				
All engines								1.965.005	

A10 CONDENSER	A20 CONTACT SET	A40 DISTRIBUTOR CAP	A50 ROTOR	A70 PICK-UP
C10 COIL	C20 IGNITION MODULE	C30 ELECTRONIC IGNITION KIT	E01 IGNITION CABLE SET	

Vehicle	alim.	kW	Date	Engine	FUNCTIONS ON THE VEHICLE									
					A10	A20	A40	A50	A70	C10 - C30	C20	E01		
ENGINE														
1.1	Petrol	40	10/87-12/94	H1B (TU1)										
Engine	Information			A10	A20	A40	A50	A70	C10 - C30	C20	E01			
All engines	version Bosch					1.306.241	1.406.056R							
All engines	version Ducellier					1.315.074	1.415.102R	1.915.019						
All engines	See connection type								1.970.105, 1.970.155	C10				
All engines													1.500.780	
ENGINE														
1.1	Petrol	44	07/89-09/98	HDZ (TU1M)										
Engine	Information			A10	A20	A40	A50	A70	C10 - C30	C20	E01			
All engines	version Bosch					1.306.241	1.406.026R							
All engines	version Ducellier					1.315.074	1.415.102R	1.915.019						
All engines	->ch. 2490280								1.970.105	C10				
All engines	ch. 2490281 ->								1.970.189	C10				
All engines	->ch. 24902800												1.500.780	
ENGINE														
1.1 CJ	Petrol	44	10/89-12/94	HDZ (TU1M)										
Engine	Information			A10	A20	A40	A50	A70	C10 - C30	C20	E01			
All engines	version Bosch					1.306.241	1.406.056R							
All engines	version Ducellier					1.315.074	1.415.102R	1.915.019						
All engines									1.970.105	C10			1.500.780	
ENGINE														
1.1 XA	Petrol	40	07/87-10/88	E1										
Engine	Information			A10	A20	A40	A50	A70	C10 - C30	C20	E01			
All engines	version Bosch					1.306.124	1.406.061R							
All engines	version Ducellier					1.315.058	1.415.094							
All engines	01/01/89 ->								1.970.106	C10				
All engines												1.965.005		
ENGINE														
1.2	Petrol	47	01/87-12/90	F1										
Engine	Information			A10	A20	A40	A50	A70	C10 - C30	C20	E01			
All engines	version Bosch					1.306.124	1.406.061R							
All engines	version Ducellier					1.315.058	1.415.094							
All engines	01/01/89 ->								1.970.106	C10				
All engines												1.965.005		
ENGINE														
1.3	Petrol	47	08/90-07/92	G1A										
Engine	Information			A10	A20	A40	A50	A70	C10 - C30	C20	E01			
All engines	version Bosch					1.306.124	1.406.061R							
All engines	version Ducellier					1.315.058	1.415.094							
All engines									1.970.106	C10	1.965.005			
ENGINE														
1.3	Petrol	74	01/91-12/94	TU24										
Engine	Information			A10	A20	A40	A50	A70	C10 - C30	C20	E01			
All engines	version Bosch					1.306.241								
All engines									1.970.105	C10				
ENGINE														
1.3 Rallye	Petrol	74	10/87-10/90	TU24										
Engine	Information			A10	A20	A40	A50	A70	C10 - C30	C20	E01			
All engines	version Bosch					1.306.241								
All engines									1.970.105	C10				
ENGINE														
1.4	Petrol	44	10/87-05/89	150D (XY7), 150G (XY7)										
Engine	Information			A10	A20	A40	A50	A70	C10 - C30	C20	E01			
Eng. 150G (XY7)	version Bosch					1.306.124	1.406.056R							
Eng. 150G (XY7)	version Ducellier, distr. num. 525 490 A, 525 475 A					1.315.058								
All engines	version Ducellier, distr. num. 525 490 B/C					1.315.067								
All engines	version Ducellier						1.415.094							
All engines										1.965.005				
Eng. 150G (XY7)													1.500.846	

A10	CONDENSER	A20	CONTACT SET	A40	DISTRIBUTOR CAP	A50	ROTOR	A70	PICK-UP
C10	COIL	C20	IGNITION MODULE	C30	ELECTRONIC IGNITION KIT	E01	IGNITION CABLE SET		

The present application list is a brief version. For the detailed information about the possibility of installation on a specific vehicle, please refer to our web-catalogue <http://catalogo.facet.eu/>

				FUNCTIONS ON THE VEHICLE								
Vehicle	alim.	kW	Date	Engine								
				ENGINE								
1.4	Petrol	49	10/87-10/90	K1D (TU3A)								
				ENGINE								
Engine	Information			A10	A20	A40	A50	A70	C10 - C30	C20	E01	
All engines	version Bosch					1.306.241	1.406.056R					
All engines	version Ducellier					1.315.074	1.415.102R	1.915.019				
All engines									1.970.105	C10		1.500.780
				ENGINE								
1.4	Petrol	53	01/87-07/88	150 (XY6B)								
				ENGINE								
Engine	Information			A10	A20	A40	A50	A70	C10 - C30	C20	E01	
All engines	version Ducellier					1.315.067	1.415.094					
All engines										1.965.005		
				ENGINE								
1.4	Petrol	55	07/88-09/98	KDX (TU3MC), KDY (TU3M), KDZ (TU3M)								
				ENGINE								
Engine	Information			A10	A20	A40	A50	A70	C10 - C30	C20	E01	
Eng. KDY (TU3M), KDZ (TU3M)	version Bosch					1.306.241						
Eng. KDY (TU3M), KDZ (TU3M)	version Ducellier					1.315.074	1.415.102R	1.915.019				
Eng. KDY (TU3M), KDZ (TU3M)	version Bosch, distr. num. 0 237 009 624						1.406.026R					
Eng. KDY (TU3M), KDZ (TU3M)									1.970.105	C10		1.500.780
Eng. KDX (TU3MC)									1.970.189	C10		
				ENGINE								
1.4	Petrol	58	07/88-05/89	150B (XY8), 150H (XY8)								
				ENGINE								
Engine	Information			A10	A20	A40	A50	A70	C10 - C30	C20	E01	
All engines	version Bosch					1.306.124	1.406.056R					
All engines	version Ducellier, distr. num. 2 525 585 A					1.315.058						
Eng. 150B (XY8)	version Ducellier, distr. num. 2 525 585 B, 2 525 567 A					1.315.067						
All engines	version Ducellier						1.415.094					
All engines										1.965.005		
Eng. 150H (XY8)												1.500.846
				ENGINE								
1.4	Petrol	62	06/87-12/89	K2B (TU3S)								
				ENGINE								
Engine	Information			A10	A20	A40	A50	A70	C10 - C30	C20	E01	
All engines	version Bosch					1.306.241	1.406.056R					
All engines	version Ducellier					1.315.074	1.415.102R	1.915.019				
All engines									1.970.105	C10		1.500.780
				ENGINE								
1.4 Cat	Petrol	44	08/87-09/93	KAY (TU3CP)								
				ENGINE								
Engine	Information			A10	A20	A40	A50	A70	C10 - C30	C20	E01	
All engines	version Bosch					1.306.241	1.406.056R					
All engines									1.970.105	C10		1.500.780
				ENGINE								
1.4 CJ	Petrol	44	03/88-05/89	150D (XY7), 150G (XY7)								
				ENGINE								
Engine	Information			A10	A20	A40	A50	A70	C10 - C30	C20	E01	
Eng. 150G (XY7)	version Bosch					1.306.124	1.406.056R					
All engines	version Ducellier, distr. num. 525 490 A, 525 475 A, distr. num. 525 520 A/B					1.315.058						
All engines	version Ducellier, distr. num. 2 525 20 C, distr. num. 525 490 B/C					1.315.067						
All engines	version Ducellier						1.415.094					
All engines										1.965.005		1.500.846
				ENGINE								
1.4 CJ	Petrol	49	03/89-12/94	K1D (TU3A)								
				ENGINE								
Engine	Information			A10	A20	A40	A50	A70	C10 - C30	C20	E01	
All engines	version Bosch					1.306.241	1.406.056R					
All engines	version Ducellier					1.315.074	1.415.102R	1.915.019				
All engines									1.970.105	C10		1.500.780
				ENGINE								
1.4 CJ	Petrol	55	05/91-12/94	KDY (TU3M), KDZ (TU3M)								
				ENGINE								
Engine	Information			A10	A20	A40	A50	A70	C10 - C30	C20	E01	
All engines	version Bosch					1.306.241						
Eng. KDY (TU3M)	version Ducellier					1.315.074	1.415.102R	1.915.019				
All engines	version Bosch, distr. num. 0 237 009 624						1.406.026R					
All engines									1.970.105	C10		1.500.780

A10 CONDENSER	A20 CONTACT SET	A40 DISTRIBUTOR CAP	A50 ROTOR	A70 PICK-UP
C10 COIL	C20 IGNITION MODULE	C30 ELECTRONIC IGNITION KIT	E01 IGNITION CABLE SET	

Vehicle	alim.	kW	Date	Engine	FUNCTIONS ON THE VEHICLE									
					A10	A20	A40	A50	A70	C10 - C30	C20	E01		
ENGINE														
1.4 CJ Cat	Petrol	44	01/89-09/93	KAY (TU3CP)										
Engine	Information				A10	A20	A40	A50	A70	C10 - C30	C20	E01		
All engines	version Bosch						1.306.241	1.406.056R						
All engines										1.970.105	C10		1.500.780	
ENGINE														
1.4 CT	Petrol	58	04/86-12/88	150B (XY8), 150H (XY8)										
Engine	Information				A10	A20	A40	A50	A70	C10 - C30	C20	E01		
All engines	version Bosch						1.306.124	1.406.056R						
All engines	version Ducellier						1.315.058	1.415.094						
All engines											1.965.005		1.500.846	
ENGINE														
1.6	Petrol	53	10/87-09/98	B1E (XU51C)										
Engine	Information				A10	A20	A40	A50	A70	C10 - C30	C20	E01		
All engines	version Bosch						1.306.124	1.406.056R						
All engines	version Ducellier, distr. num. 2 525 626 A						1.315.058							
All engines	version Ducellier, distr. num. 2 525 626 B/C						1.315.067							
All engines	version Ducellier, distr. num. 2 525 663 A						1.315.074	1.415.102R	1.915.019					
All engines	version Ducellier, distr. num. 2 525 626 A/B/C							1.415.094						
All engines	version Ducellier, distr. num. 2 525 640 B/C								1.915.017					
All engines											1.965.005			
All engines	ch. 7330001 ->, ->year 01/01/90												1.500.747	
All engines	01/01/90 ->												1.500.748	
ENGINE														
1.6	Petrol	55	10/87-09/98	B1A (XU51C), BAZ (XU5CP)										
Engine	Information				A10	A20	A40	A50	A70	C10 - C30	C20	E01		
All engines	version Bosch						1.306.124	1.406.056R						
All engines	version Ducellier, distr. num. 2 525 626 A						1.315.058							
All engines	version Ducellier, distr. num. 2 525 626 B/C, distr. num. 2 525 683 A/B						1.315.067							
Eng. B1A (XU51C)	version Ducellier, distr. num. 2 525 663 A						1.315.074	1.415.102R	1.915.019					
All engines	version Ducellier, distr. num. 2 525 626 A/B/C							1.415.094						
All engines	version Ducellier, distr. num. 2 525 640 B/C, distr. num. 2 525 626 B/C, distr. num. 2 525 683 A/B								1.915.017					
All engines											1.965.005			
All engines	ch. 7330001 ->, ->year 01/01/90												1.500.747	
Eng. B1A (XU51C)	01/01/90 ->												1.500.748	
ENGINE														
1.6 CTI	Petrol	76	03/86-10/90	180A (XU5J), 180Z (XU5J)										
Engine	Information				A10	A20	A40	A50	A70	C10 - C30	C20	E01		
All engines	version Bosch						1.306.124	1.406.056R						
All engines											1.965.005			
All engines	ch. 7330001 ->												1.500.747	
ENGINE														
1.6 GTI	Petrol	76	10/87-12/89	180A (XU5J), 180Z (XU5J)										
Engine	Information				A10	A20	A40	A50	A70	C10 - C30	C20	E01		
All engines	version Bosch						1.306.124	1.406.056R						
All engines											1.965.005			
All engines	ch. 7330001 ->												1.500.747	
ENGINE														
1.6 i	Petrol	0	01/91-12/94	BDZ (XU5M)										
Engine	Information				A10	A20	A40	A50	A70	C10 - C30	C20	E01		
All engines										1.970.188	C10		1.500.674	
ENGINE														
1.9 CTI	Petrol	75	10/87-12/94	DFZ (XU9J1)										
Engine	Information				A10	A20	A40	A50	A70	C10 - C30	C20	E01		
All engines	version Bosch						1.306.124	1.406.056R						
All engines	version Ducellier						1.315.067	1.415.094	1.915.017					
All engines	01/03/91 ->									1.970.105	C10			
All engines											1.965.005			
All engines	->year 01/03/91												1.500.747	

A10	CONDENSER	A20	CONTACT SET	A40	DISTRIBUTOR CAP	A50	ROTOR	A70	PICK-UP
C10	COIL	C20	IGNITION MODULE	C30	ELECTRONIC IGNITION KIT	E01	IGNITION CABLE SET		

The present application list is a brief version. For the detailed information about the possibility of installation on a specific vehicle, please refer to our web-catalogue <http://catalogo.facet.eu/>

FUNCTIONS ON THE VEHICLE

Vehicle	alim.	kW	Date	Engine								
---------	-------	----	------	--------	---	---	---	--	---	---	---	---

				ENGINE
1.9 GTI	Petrol	88	10/87-10/94	DKZ (XU9JAZ)

Engine	Information	A10	A20	A40	A50	A70	C10 - C30	C20	E01
All engines	version Ducellier			1.315.074	1.415.102R				
All engines	01/01/90 ->						1.970.105	C10	1.500.491
All engines								1.965.005	

				ENGINE
1.9 GTI	Petrol	94	10/87-09/98	D6B (XU9JA)

Engine	Information	A10	A20	A40	A50	A70	C10 - C30	C20	E01
All engines	version Bosch			1.306.241	1.406.056R				
All engines							1.970.105	C10	1.500.491
All engines								1.965.005	

				ENGINE
1.9 GTI Cat	Petrol	75	10/87-07/94	DFZ (XU9J1)

Engine	Information	A10	A20	A40	A50	A70	C10 - C30	C20	E01
All engines	version Bosch			1.306.124	1.406.056R				
All engines	version Ducellier			1.315.067	1.415.094	1.915.017			
All engines	01/03/91 ->						1.970.105	C10	
All engines								1.965.005	
All engines	->year 01/03/91								1.500.747

				ENGINE
206				

				ENGINE
1.1	Petrol	40	08/98-07/00	HFY (TU1JP)

Engine	Information	A10	A20	A40	A50	A70	C10 - C30	C20	E01
All engines	euro 2, x 4, Electricfil, COIL ON PLUG						1.970.403	C10	
All engines	euro 3, x 1, COIL ON PLUG						1.970.405	C10	

				ENGINE
1.1	Petrol	44	07/02-02/07	HFX (TU1JP), HFZ (TU1JP)

Engine	Information	A10	A20	A40	A50	A70	C10 - C30	C20	E01
All engines	euro 2, x 4, Electricfil, COIL ON PLUG						1.970.403	C10	
All engines	euro 3, x 1, COIL ON PLUG						1.970.405	C10	

				ENGINE
1.1 i	Petrol	44	09/98-02/07	HFX (TU1JP), HFZ (TU1JP)

Engine	Information	A10	A20	A40	A50	A70	C10 - C30	C20	E01
All engines	euro 2, x 4, Electricfil, COIL ON PLUG						1.970.403	C10	
All engines	euro 3, x 1, COIL ON PLUG						1.970.405	C10	

				ENGINE
1.4	Petrol	55	07/02->	KFV (TU3A), KFW (TU3JP)

Engine	Information	A10	A20	A40	A50	A70	C10 - C30	C20	E01
All engines							1.970.405	C10	
All engines	x 4, COIL ON PLUG						1.970.405	C10	

				ENGINE
1.4 16V	Petrol	65	10/03->	KFU (ET3J4)

Engine	Information	A10	A20	A40	A50	A70	C10 - C30	C20	E01
All engines	x 1, COIL ON PLUG						1.970.483	C10	

				ENGINE
1.4 CNG	Petrol/ Compressed Natural Gas (CNG)	55	05/06-09/07	KFW (TU3A)

Engine	Information	A10	A20	A40	A50	A70	C10 - C30	C20	E01
All engines	x 4, COIL ON PLUG						1.970.405	C10	

				ENGINE
1.4 i	Petrol	55	09/98->	K6C (TU3JP), K6D (TU3A), K6D (TU3JP), KFW (TU3A), KFW (TU3JP), KFX (TU3JP), TU3AF









Engine	Information	A10	A20	A40	A50	A70	C10 - C30	C20	E01
Eng. K6C (TU3JP), KFX (TU3JP)							1.970.403	C10	

A10 CONDENSER	A20 CONTACT SET	A40 DISTRIBUTOR CAP	A50 ROTOR	A70 PICK-UP
C10 COIL	C20 IGNITION MODULE	C30 ELECTRONIC IGNITION KIT	E01 IGNITION CABLE SET	

Vehicle	alim.	kW	Date	Engine	FUNCTIONS ON THE VEHICLE								
					A10	A20	A40	A50	A70	C10 - C30	C20	E01	
1.4 i	Petrol	55	09/98->	ENGINE K6C (TU3JP), K6D (TU3A), K6D (TU3JP), KFW (TU3A), KFW (TU3JP), KFX (TU3JP), TU3AF									
				Eng. K6D (TU3A), K6D (TU3JP), KFW (TU3A), KFW (TU3JP), TU3AF						1.970.405	C10		
1.4 LPG	Petrol/ Liquified Petro- leum Gas (LPG)	55	07/02-09/07	ENGINE KfV (TU3JP), KFW (TU3JP)									
				All engines	x 1, COIL ON PLUG					1.970.405	C10		
1.6	Petrol	81	09/01-12/08	ENGINE NFU (TU5JP4)									
				All engines	x 1, COIL ON PLUG					1.970.407	C10		
1.6 16V	Petrol	79	06/01-04/09	ENGINE NFU (TU5JP4)									
				All engines	x 1, COIL ON PLUG					1.970.407	C10		
1.6 16V	Petrol	80	07/00->	ENGINE N6A (TU5JP4), NFU (TU5JP4)									
				Eng. N6A (TU5JP4)						1.970.407	C10		
				Eng. NFU (TU5JP4)							1.970.407	C10	
1.6 8V	Petrol	66	05/99-10/03	ENGINE NFZ (TU5JP)									
				All engines	x 1, Electricfil, COIL ON PLUG					1.970.403	C10		
1.6 BiFuel	Petrol/ Liquified Petro- leum Gas (LPG)	80	07/00-04/09	ENGINE NFU (TU5JP4)									
				All engines	x 1, COIL ON PLUG					1.970.407	C10		
1.6 i	Petrol	65	09/98-12/00	ENGINE NFZ (TU5JP)									
				All engines	x 4, Electricfil, COIL ON PLUG					1.970.403	C10		
1.6 LPG	Bi-Fuel	80	07/02->	ENGINE NFU (TU5JP4)									
				All engines						1.970.407	C10		
				All engines	x 1, COIL ON PLUG					1.970.407	C10		
2.0 16V	Petrol	100	07/02-02/07	ENGINE RFN (EW10J4)									
				All engines	x 4, COIL ON PLUG					1.970.408	C10		
2.0 RC	Petrol	130	07/03-12/07	ENGINE RFK (EW10J4S)									
				All engines	x 4, COIL ON PLUG					1.970.509	C10		
2.0 S16	Petrol	100	06/99-12/07	ENGINE RFN (EW10J4), RFR (DEW10J4)									
				Eng. RFN (EW10J4)	x 4, COIL ON PLUG					1.970.408	C10		
				Eng. RFR (DEW10J4)						1.970.408	C10		

A10 CONDENSER	A20 CONTACT SET	A40 DISTRIBUTOR CAP	A50 ROTOR	A70 PICK-UP
C10 COIL	C20 IGNITION MODULE	C30 ELECTRONIC IGNITION KIT	E01 IGNITION CABLE SET	

The present application list is a brief version. For the detailed information about the possibility of installation on a specific vehicle, please refer to our web-catalogue <http://catalogo.facet.eu/>









					FUNCTIONS ON THE VEHICLE							
Vehicle	alim.	kW	Date	Engine	 A10	 A20	 A40	 A50	 A70	 C10 - C30	 C20	 E01
2.0S16												
Petrol 99 04/99-10/00					ENGINE RFR (DEW10J4), RFR (EW10J4)							
Engine Information					A10	A20	A40	A50	A70	C10 - C30	C20	E01
Eng. RFR (DEW10J4)										1.970.408	C10	
Eng. RFR (EW10J4)										1.970.408	C10	
206+												
1.1					ENGINE HFX (TU1A)							
Petrol 44 01/09-06/13												
Engine Information					A10	A20	A40	A50	A70	C10 - C30	C20	E01
All engines										1.970.405	C10	
1.1 LPG					ENGINE HFX (TU1A), HFX (TU1JP)							
Petrol/ Liquified Petroleum Gas (LPG)	44	04/09-06/13										
Engine Information					A10	A20	A40	A50	A70	C10 - C30	C20	E01
All engines										1.970.405	C10	
1.4i					ENGINE KFT (TU3AE5)							
Petrol 54 09/10-06/13												
Engine Information					A10	A20	A40	A50	A70	C10 - C30	C20	E01
All engines										1.970.405	C10	
1.4i					ENGINE K6D (TU3A), KFW (TU3A), TU3AE5							
Petrol 55 01/09->												
Engine Information					A10	A20	A40	A50	A70	C10 - C30	C20	E01
Eng. K6D (TU3A), TU3AE5										1.970.405	C10	
Eng. KFW (TU3A)										1.970.405	C10	
1.6 16V					ENGINE NFU (TU5JP4)							
Petrol 80 07/10->												
Engine Information					A10	A20	A40	A50	A70	C10 - C30	C20	E01
All engines										1.970.407	C10	
207												
1.4					ENGINE KFT (TU3A), KFT (TU3AE5), KFU (TU3A)							
Petrol 53 02/06-10/13												
Engine Information					A10	A20	A40	A50	A70	C10 - C30	C20	E01
All engines										1.970.405	C10	
1.4					ENGINE KFT (TU3A), KFT (TU3AE5), KFU (TU3A)							
Petrol 54 04/06-10/13												
Engine Information					A10	A20	A40	A50	A70	C10 - C30	C20	E01
All engines										1.970.405	C10	
1.4					ENGINE KFV (TU3A), KFW (TU3A)							
Petrol 55 08/08-12/15												
Engine Information					A10	A20	A40	A50	A70	C10 - C30	C20	E01
All engines										1.970.405	C10	
1.4 16V					ENGINE KFU (ET3J4)							
Petrol 65 02/06-10/13												
Engine Information					A10	A20	A40	A50	A70	C10 - C30	C20	E01
All engines										1.970.483	C10	
1.4 16V					ENGINE 8FS (EP3), EP3, EP3C							
Petrol 70 06/07-10/13												
Engine Information					A10	A20	A40	A50	A70	C10 - C30	C20	E01
All engines										1.970.475	C10	
1.4 16V					ENGINE 8FR (EP3)							
Petrol 72 10/09-12/12												
Engine Information					A10	A20	A40	A50	A70	C10 - C30	C20	E01
All engines										1.970.475	C10	

A10 CONDENSER	A20 CONTACT SET	A40 DISTRIBUTOR CAP	A50 ROTOR	A70 PICK-UP
C10 COIL	C20 IGNITION MODULE	C30 ELECTRONIC IGNITION KIT	E01 IGNITION CABLE SET	

Vehicle	alim.	kW	Date	Engine	FUNCTIONS ON THE VEHICLE									
					A10	A20	A40	A50	A70	C10 - C30	C20	E01		
ENGINE														
1.4 BiFuel	Petrol/ Liquified Petroleum Gas (LPG)	54	08/07-12/13	KFV (TU3A)										
Engine		Information			A10	A20	A40	A50	A70	C10 - C30	C20	E01		
All engines		x 4, COIL ON PLUG								1.970.405	C10			
ENGINE														
1.4 Flex	Petrol/ Ethanol	60	11/08-12/14	KFW (TU3A)										
Engine		Information			A10	A20	A40	A50	A70	C10 - C30	C20	E01		
All engines										1.970.405	C10			
ENGINE														
1.4 LPG	Petrol/ Liquified Petroleum Gas (LPG)	54	08/07-12/12	KFV (TU3A)										
Engine		Information			A10	A20	A40	A50	A70	C10 - C30	C20	E01		
All engines		x 4, COIL ON PLUG								1.970.405	C10			
ENGINE														
1.6	Petrol	78	01/10->	NFU (TU5JP4)										
Engine		Information			A10	A20	A40	A50	A70	C10 - C30	C20	E01		
All engines										1.970.407	C10			
ENGINE														
1.6	Petrol	81	08/08-12/13	N6A (TU5JP4)										
Engine		Information			A10	A20	A40	A50	A70	C10 - C30	C20	E01		
All engines										1.970.407	C10			
ENGINE														
1.6 16V	Petrol	80	02/06-10/13	NFU (TU5JP4)										
Engine		Information			A10	A20	A40	A50	A70	C10 - C30	C20	E01		
All engines		x 1, COIL ON PLUG								1.970.407	C10			
ENGINE														
1.6 16V	Petrol	88	06/07-10/13	5FS (EP6C), 5FW (EP6), EP6										
Engine		Information			A10	A20	A40	A50	A70	C10 - C30	C20	E01		
All engines		x 4, COIL ON PLUG								1.970.475	C10			
ENGINE														
1.6 16V RC	Petrol	128	02/07-12/12	5FY (EP6DTS)										
Engine		Information			A10	A20	A40	A50	A70	C10 - C30	C20	E01		
All engines		x 4, COIL ON PLUG								1.970.475	C10			
ENGINE														
1.6 16V Turbo	Petrol	110	02/06-10/13	5FX (EP6DT)										
Engine		Information			A10	A20	A40	A50	A70	C10 - C30	C20	E01		
All engines		x 4, COIL ON PLUG								1.970.475	C10			
ENGINE														
1.6 16V Turbo	Petrol	115	10/09-12/12	5FR (EP6DT)										
Engine		Information			A10	A20	A40	A50	A70	C10 - C30	C20	E01		
All engines		x 4, COIL ON PLUG								1.970.475	C10			
ENGINE														
1.6 16V VTi	Petrol	81	09/08-12/12	EP6										
Engine		Information			A10	A20	A40	A50	A70	C10 - C30	C20	E01		
All engines		x 4, COIL ON PLUG								1.970.475	C10			
ENGINE														
1.6 16V VTi	Petrol	88	02/07-12/12	5FS (EP6C), 5FW (EP6), EP6										
Engine		Information			A10	A20	A40	A50	A70	C10 - C30	C20	E01		
All engines		x 4, COIL ON PLUG								1.970.475	C10			
ENGINE														
1.6 Bioflex	Petrol/ Ethanol	83	01/08-12/13	N6A (TU5JP4)										
Engine		Information			A10	A20	A40	A50	A70	C10 - C30	C20	E01		
All engines										1.970.407	C10			

A10 CONDENSER	A20 CONTACT SET	A40 DISTRIBUTOR CAP	A50 ROTOR	A70 PICK-UP
C10 COIL	C20 IGNITION MODULE	C30 ELECTRONIC IGNITION KIT	E01 IGNITION CABLE SET	

The present application list is a brief version. For the detailed information about the possibility of installation on a specific vehicle, please refer to our web-catalogue <http://catalogo.facet.eu/>

					FUNCTIONS ON THE VEHICLE							
Vehicle	alim.	kW	Date	Engine								
ENGINE												
1.6 VTi	Petrol	88	03/07-12/12	5FW (EP6)								
Engine		Information			A10	A20	A40	A50	A70	C10 - C30	C20	E01
All engines		x 4, COIL ON PLUG								1.970.475	C10	
207 CC												
1.6 16V	Petrol	88	02/07-10/13	5FS (EP6C), 5FW (EP6), EP6								
Engine		Information			A10	A20	A40	A50	A70	C10 - C30	C20	E01
All engines		x 4, COIL ON PLUG								1.970.475	C10	
ENGINE												
1.6 16V Turbo	Petrol	110	02/07-12/12	5FX (EP6DT)								
Engine		Information			A10	A20	A40	A50	A70	C10 - C30	C20	E01
All engines		x 4, COIL ON PLUG								1.970.475	C10	
ENGINE												
1.6 16V Turbo	Petrol	115	10/09-12/13	5FR (EP6DT), 5FV (EP6CDT)								
Engine		Information			A10	A20	A40	A50	A70	C10 - C30	C20	E01
All engines		x 4, COIL ON PLUG								1.970.475	C10	
208 I												
1.0	Petrol	50	03/12->	ZMZ (EB0)								
Engine		Information			A10	A20	A40	A50	A70	C10 - C30	C20	E01
All engines		x 3, COIL ON PLUG								1.970.609	C10	
ENGINE												
1.2 GPL	Petrol/ Liquified Petro- leum Gas (LPG)	60	06/15->	HMZ (EB2F)								
Engine		Information			A10	A20	A40	A50	A70	C10 - C30	C20	E01
All engines		x 3, COIL ON PLUG								1.970.609	C10	
ENGINE												
1.2 PureTech 82	Petrol	61	03/18->	HMR (EB2FA), HMZ (EB2F)								
Engine		Information			A10	A20	A40	A50	A70	C10 - C30	C20	E01
All engines		x 3, COIL ON PLUG								1.970.609	C10	
ENGINE												
1.2 VTi	Petrol	60	09/13->	HMZ (EB2)								
Engine		Information			A10	A20	A40	A50	A70	C10 - C30	C20	E01
All engines		Qty: 3								1.970.609	C10	
ENGINE												
1.2 VTi 68 / PureTech 68	Petrol	50	06/15->	HMM (EB2FAD), HMP (EB2FB)								
Engine		Information			A10	A20	A40	A50	A70	C10 - C30	C20	E01
All engines		x 3, COIL ON PLUG								1.970.609	C10	
ENGINE												
1.2 VTi 82	Petrol	60	03/12->	HMZ (EB2), HMZ (EB2F)								
Engine		Information			A10	A20	A40	A50	A70	C10 - C30	C20	E01
All engines		x 3, COIL ON PLUG								1.970.609	C10	
ENGINE												
1.2 VTi 82 / PureTech 82	Petrol	60	06/15->	HMR (EB2FA), HMZ (EB2), HMZ (EB2F)								
Engine		Information			A10	A20	A40	A50	A70	C10 - C30	C20	E01
All engines		x 3, COIL ON PLUG								1.970.609	C10	
ENGINE												
1.4 GPL	Petrol/ Liquified Petro- leum Gas (LPG)	70	10/13->	EP3C								
Engine		Information			A10	A20	A40	A50	A70	C10 - C30	C20	E01
All engines		x 4, COIL ON PLUG								1.970.475	C10	

A10 CONDENSER	A20 CONTACT SET	A40 DISTRIBUTOR CAP	A50 ROTOR	A70 PICK-UP
C10 COIL	C20 IGNITION MODULE	C30 ELECTRONIC IGNITION KIT	E01 IGNITION CABLE SET	

Vehicle	alim.	kW	Date	Engine	FUNCTIONS ON THE VEHICLE									
					A10	A20	A40	A50	A70	C10 - C30	C20	E01		
ENGINE														
1.4 VTi	Petrol	70	03/12->	8FS (EP3), EP3C										
ENGINE														
Engine Information					A10	A20	A40	A50	A70	C10 - C30	C20	E01		
All engines x 4, COIL ON PLUG										1.970.475	C10			
ENGINE														
1.6	Petrol	115	03/12->	5FV (EP6CDT), 5FV (EP6DT)										
ENGINE														
Engine Information					A10	A20	A40	A50	A70	C10 - C30	C20	E01		
Eng. 5FV (EP6CDT) x 4, COIL ON PLUG										1.970.475	C10			
Eng. 5FV (EP6DT) Qty: 4										1.970.475	C10			
ENGINE														
1.6	Petrol	121	02/12->	5GZ (EP6FDT)										
ENGINE														
Engine Information					A10	A20	A40	A50	A70	C10 - C30	C20	E01		
All engines Qty: 4										1.970.475	C10			
ENGINE														
1.6	Petrol	88	03/12->	5FS (EP6C)										
ENGINE														
Engine Information					A10	A20	A40	A50	A70	C10 - C30	C20	E01		
All engines x 4, COIL ON PLUG										1.970.475	C10			
ENGINE														
1.6	Petrol	89	09/16->	5FS (EP6C)										
ENGINE														
Engine Information					A10	A20	A40	A50	A70	C10 - C30	C20	E01		
All engines x 4, COIL ON PLUG										1.970.475	C10			
ENGINE														
1.6 GTi	Petrol	147	08/12->	5FU (EP6CDTX)										
ENGINE														
Engine Information					A10	A20	A40	A50	A70	C10 - C30	C20	E01		
All engines x 4, COIL ON PLUG										1.970.475	C10			
ENGINE														
1.6 GTi	Petrol	153	10/14->	9H92										
ENGINE														
Engine Information					A10	A20	A40	A50	A70	C10 - C30	C20	E01		
All engines x 4, COIL ON PLUG										1.970.475	C10			
ENGINE														
1.6 THP 165	Petrol	121	03/15->	5GZ (EP6FDT)										
ENGINE														
Engine Information					A10	A20	A40	A50	A70	C10 - C30	C20	E01		
All engines x 4, COIL ON PLUG										1.970.475	C10			
ENGINE														
1.6 THP 210	Petrol	155	04/15->	5GM (EP6FDTX)										
ENGINE														
Engine Information					A10	A20	A40	A50	A70	C10 - C30	C20	E01		
All engines Qty: 4										1.970.475	C10			
ENGINE														
208 II														
ENGINE														
1.2 PureTech 75	Petrol	55	06/19->	HMH (EB2FAD)										
ENGINE														
Engine Information					A10	A20	A40	A50	A70	C10 - C30	C20	E01		
All engines x 3, COIL ON PLUG										1.970.609	C10			
ENGINE														
3008 I														
ENGINE														
1.2	Petrol	96	01/15-08/16	HNY (EB2DTS)										
ENGINE														
Engine Information					A10	A20	A40	A50	A70	C10 - C30	C20	E01		
All engines x 3, COIL ON PLUG										1.970.620	C10			
ENGINE														
1.6 THP	Petrol	110	06/09->	5FE (EP6CDTM), 5FE (EP6CDTMD), 5FX (EP6DT), EP6CDT M										
ENGINE														
Engine Information					A10	A20	A40	A50	A70	C10 - C30	C20	E01		
Eng. 5FE (EP6CDTM), 5FE (EP6CDTMD), 5FX (EP6DT) x 4, COIL ON PLUG										1.970.475	C10			
Eng. EP6CDT M Qty: 4										1.970.475	C10			
ENGINE														
1.6 THP	Petrol	115	06/09->	5FV (EP6CDT), 5FV (EP6DT)										
ENGINE														
Engine Information					A10	A20	A40	A50	A70	C10 - C30	C20	E01		
All engines Qty: 4										1.970.475	C10			
Eng. 5FV (EP6CDT) x 4, COIL ON PLUG										1.970.475	C10			

A10 CONDENSER	A20 CONTACT SET	A40 DISTRIBUTOR CAP	A50 ROTOR	A70 PICK-UP
C10 COIL	C20 IGNITION MODULE	C30 ELECTRONIC IGNITION KIT	E01 IGNITION CABLE SET	

The present application list is a brief version. For the detailed information about the possibility of installation on a specific vehicle, please refer to our web-catalogue <http://catalogo.facet.eu/>

Vehicle	alim.	kW	Date	Engine	FUNCTIONS ON THE VEHICLE									
					A10	A20	A40	A50	A70	C10 - C30	C20	E01		
ENGINE														
1.6 THP	Petrol	120	09/10->	5FM (EP6CDTM), EP6CDT MD										
Engine	Information				A10	A20	A40	A50	A70	C10 - C30	C20	E01		
Eng. 5FM (EP6CDTM)	x 4, COIL ON PLUG									1.970.475	C10			
Eng. EP6CDT MD	Qty: 4									1.970.475	C10			
ENGINE														
1.6 VTi	Petrol	88	06/09-08/16	EP6										
Engine	Information				A10	A20	A40	A50	A70	C10 - C30	C20	E01		
All engines	x 4, COIL ON PLUG									1.970.475	C10			
3008 II														
ENGINE														
1.2 THP/PureTech 130	Petrol	96	05/16->	HNS (EB2ADTS), HNY (EB2DTS)										
Engine	Information				A10	A20	A40	A50	A70	C10 - C30	C20	E01		
All engines	x 3, COIL ON PLUG									1.970.620	C10			
ENGINE														
1.6 PureTech 180	Petrol	133	07/18->	5GF (EP6FADTXD)										
Engine	Information				A10	A20	A40	A50	A70	C10 - C30	C20	E01		
All engines	x 4, COIL ON PLUG									1.970.475	C10			
ENGINE														
1.6 THP 150	Petrol	110	11/17->	5GX (EP6FDTMD)										
Engine	Information				A10	A20	A40	A50	A70	C10 - C30	C20	E01		
All engines	x 4, COIL ON PLUG									1.970.475	C10			
ENGINE														
1.6 THP 165	Petrol	121	05/16->	5GY (EP6FDTM), 5GZ (EP6FDT)										
Engine	Information				A10	A20	A40	A50	A70	C10 - C30	C20	E01		
All engines	x 4, COIL ON PLUG									1.970.475	C10			
ENGINE														
Hybrid	Petrol/ Electric	133	10/19->	5GQ (EP6FADTXHPD)										
Engine	Information				A10	A20	A40	A50	A70	C10 - C30	C20	E01		
All engines	x 4, COIL ON PLUG									1.970.475	C10			
ENGINE														
Hybrid4	Petrol/ Electric	147	10/19->	5GB (EP6FADTXHPA)										
Engine	Information				A10	A20	A40	A50	A70	C10 - C30	C20	E01		
All engines	x 4, COIL ON PLUG									1.970.475	C10			
ENGINE														
PureTech 130	Petrol	96	05/16->	HNY (EB2DTS)										
Engine	Information				A10	A20	A40	A50	A70	C10 - C30	C20	E01		
All engines	x 3, COIL ON PLUG									1.970.620	C10			
301														
ENGINE														
1.2	Petrol	60	11/12->	HMZ (EB2F)										
Engine	Information				A10	A20	A40	A50	A70	C10 - C30	C20	E01		
All engines	Qty: 3									1.970.609	C10			
ENGINE														
1.2 PureTech 82	Petrol	61	02/18->	HMR (EB2FA)										
Engine	Information				A10	A20	A40	A50	A70	C10 - C30	C20	E01		
All engines	x 3, COIL ON PLUG									1.970.609	C10			
ENGINE														
1.2 VTi 72	Petrol	53	11/12->	HMY (EB2M)										
Engine	Information				A10	A20	A40	A50	A70	C10 - C30	C20	E01		
All engines	x 3, COIL ON PLUG									1.970.609	C10			
ENGINE														
1.2 VTi 82	Petrol	60	12/14->	HMZ (EB2F)										
Engine	Information				A10	A20	A40	A50	A70	C10 - C30	C20	E01		
All engines	x 3, COIL ON PLUG									1.970.609	C10			

A10 CONDENSER	A20 CONTACT SET	A40 DISTRIBUTOR CAP	A50 ROTOR	A70 PICK-UP
C10 COIL	C20 IGNITION MODULE	C30 ELECTRONIC IGNITION KIT	E01 IGNITION CABLE SET	

Vehicle	alim.	kW	Date	Engine	FUNCTIONS ON THE VEHICLE							
					A10	A20	A40	A50	A70	C10 - C30	C20	E01

304

1.1	Petrol	43	10/76-10/80	ENGINE XK5
-----	--------	----	-------------	---------------

Engine	Information	A10	A20	A40	A50	A70	C10 - C30	C20	E01
All engines					1.406.014R				

1.3	Petrol	48	03/70-10/80	ENGINE XL3, XL5
-----	--------	----	-------------	--------------------

Engine	Information	A10	A20	A40	A50	A70	C10 - C30	C20	E01
All engines					1.406.014R				

1.3	Petrol	55	03/72-07/76	ENGINE XL3S
-----	--------	----	-------------	----------------

Engine	Information	A10	A20	A40	A50	A70	C10 - C30	C20	E01
All engines					1.406.014R				

1.3 GL	Petrol	48	09/72-10/79	ENGINE XL5
--------	--------	----	-------------	---------------

Engine	Information	A10	A20	A40	A50	A70	C10 - C30	C20	E01
All engines					1.406.014R				

1.3 GT	Petrol	48	10/69-09/75	ENGINE XL3
--------	--------	----	-------------	---------------

Engine	Information	A10	A20	A40	A50	A70	C10 - C30	C20	E01
All engines					1.406.014R				

305

1.5	Petrol	65	05/80-09/82	ENGINE 117 (XR5S)
-----	--------	----	-------------	----------------------

Engine	Information	A10	A20	A40	A50	A70	C10 - C30	C20	E01
All engines	01/01/83 ->, version Ducellier	1.115.034							
All engines	->year 01/01/83, version Ducellier		1.215.102						
All engines	->year 01/01/83, version Marelli		1.230.146M						
All engines	version Ducellier			1.315.049	1.415.091				
All engines	version Marelli			1.330.101	1.430.047R				
All engines	->year 01/01/83						1.970.101D	C10	
All engines									1.965.005

306

1.1	Petrol	44	05/93-05/01	ENGINE HDZ (TU1M)
-----	--------	----	-------------	----------------------

Engine	Information	A10	A20	A40	A50	A70	C10 - C30	C20	E01
All engines							1.970.189	C10	1.501.025

1.4	Petrol	55	04/93-04/02	ENGINE KDX (TU3MC), KFW (TU3JP), KFX (TU3JP)
-----	--------	----	-------------	---

Engine	Information	A10	A20	A40	A50	A70	C10 - C30	C20	E01
Eng. KFW (TU3JP), KFX (TU3JP)	->year 31/05/98						1.970.188	C10	1.501.374
Eng. KDX (TU3MC)							1.970.189	C10	1.501.025
Eng. KFW (TU3JP), KFX (TU3JP)	01/06/98 ->, Colour:Black						1.970.403	C10	
Eng. KFW (TU3JP), KFX (TU3JP)	01/06/98 ->, Colour:Grey						1.970.405	C10	

1.4 SL	Petrol	55	06/94-05/01	ENGINE KDX (TU3MC), KFW (TU3JP), KFX (TU3JP)
--------	--------	----	-------------	---

Engine	Information	A10	A20	A40	A50	A70	C10 - C30	C20	E01
Eng. KFW (TU3JP), KFX (TU3JP)	->year 31/05/98						1.970.188	C10	1.501.374
Eng. KDX (TU3MC)							1.970.189	C10	1.501.025
Eng. KFW (TU3JP), KFX (TU3JP)	01/06/98 ->, Colour:Black						1.970.403	C10	
Eng. KFW (TU3JP), KFX (TU3JP)	01/06/98 ->, Colour:Grey						1.970.405	C10	

1.6	Petrol	65	05/93-10/00	ENGINE NFZ (TU5JP)
-----	--------	----	-------------	-----------------------

Engine	Information	A10	A20	A40	A50	A70	C10 - C30	C20	E01
All engines	01/05/97 ->, ->year 31/05/98						1.970.188	C10	
All engines	->year 30/04/97						1.970.189	C10	1.501.025
All engines	01/06/98 ->						1.970.403	C10	
All engines	->year 31/05/98, 01/05/97 ->								1.501.374

A10 CONDENSER	A20 CONTACT SET	A40 DISTRIBUTOR CAP	A50 ROTOR	A70 PICK-UP
C10 COIL	C20 IGNITION MODULE	C30 ELECTRONIC IGNITION KIT	E01 IGNITION CABLE SET	

The present application list is a brief version. For the detailed information about the possibility of installation on a specific vehicle, please refer to our web-catalogue <http://catalogo.facet.eu/>









Vehicle	alim.	kW	Date	Engine	FUNCTIONS ON THE VEHICLE								
					A10	A20	A40	A50	A70	C10 - C30	C20	E01	
ENGINE													
1.6	Petrol	72	10/00-04/02	NFT (TU5JP)									
ENGINE													
All engines											1.970.405	C10	
ENGINE													
1.6 SR	Petrol	65	06/94-10/00	NFZ (TU5JP)									
ENGINE													
All engines											1.970.188	C10	
All engines											1.970.189	C10	1.501.025
All engines											1.970.403	C10	
All engines													1.501.374
ENGINE													
1.8	Petrol	74	05/93-04/02	--, LFZ (XU7JP)									
ENGINE													
All engines											1.970.188	C10	1.500.674
ENGINE													
1.8 ST	Petrol	74	06/94-05/01	LFZ (XU7JP)									
ENGINE													
All engines											1.970.188	C10	1.500.674
ENGINE													
2.0	Petrol	89	03/94-04/02	RFX (XU10J2)									
ENGINE													
All engines											1.970.188	C10	1.500.494
ENGINE													
2.0 ST	Petrol	89	07/94-05/01	RFX (XU10J2)									
ENGINE													
All engines											1.970.188	C10	1.500.494
ENGINE													
2.0 XSi	Petrol	89	05/93-05/01	RFX (XU10J2)									
ENGINE													
All engines											1.970.188	C10	1.500.494
307													
ENGINE													
1.4	Petrol	55	08/00-09/03	KFW (TU3JP)									
ENGINE													
All engines											1.970.405	C10	
ENGINE													
1.4 16V	Petrol	65	11/03-07/07	KFU (ET3J4)									
ENGINE													
All engines											1.970.483	C10	
ENGINE													
1.6	Petrol	81	07/06-04/12	NFU (TU5JP4)									
ENGINE													
All engines											1.970.407	C10	
ENGINE													
1.6 16V	Petrol	80	08/00->	N6A (TU5JP4), NFU (TU5JP4)									
ENGINE													
Eng. N6A (TU5JP4)											1.970.407	C10	
Eng. NFU (TU5JP4)											1.970.407	C10	
ENGINE													
1.6 BioFlex	Flexfuel	81	07/06->	--									
ENGINE													
All engines											1.970.407	C10	
ENGINE													
1.6 BioFlex	Petrol	80	07/06->	N6A (TU5JP4)									
ENGINE													
All engines											1.970.407	C10	
All engines											1.970.407	C10	

A10 CONDENSER	A20 CONTACT SET	A40 DISTRIBUTOR CAP	A50 ROTOR	A70 PICK-UP
C10 COIL	C20 IGNITION MODULE	C30 ELECTRONIC IGNITION KIT	E01 IGNITION CABLE SET	

Vehicle	alim.	kW	Date	Engine	FUNCTIONS ON THE VEHICLE								
					A10	A20	A40	A50	A70	C10 - C30	C20	E01	
ENGINE													
2.0	Petrol	100	03/02-06/05	RFN (EW10J4)									
ENGINE													
Engine Information					A10	A20	A40	A50	A70	C10 - C30	C20	E01	
All engines x 4, COIL ON PLUG										1.970.408	C10		
2.0 16V	Petrol	100	08/00-06/05	RFN (EW10J4)									
ENGINE													
Engine Information					A10	A20	A40	A50	A70	C10 - C30	C20	E01	
All engines x 4, COIL ON PLUG										1.970.408	C10		
2.0 16V	Petrol	103	12/04-04/09	RFJ (EW10A), RFN (EW10J4)									
ENGINE													
Engine Information					A10	A20	A40	A50	A70	C10 - C30	C20	E01	
Eng. RFN (EW10J4)										1.970.408	C10		
Eng. RFJ (EW10A)										1.970.476	C10		
2.0 16V	Petrol	130	10/03-04/09	RFK (EW10J4S)									
ENGINE													
Engine Information					A10	A20	A40	A50	A70	C10 - C30	C20	E01	
All engines ->year 01/08/05, x 1, COIL ON PLUG										1.970.476	C10		
All engines 01/09/05 ->, x 4, COIL ON PLUG, x 1, COIL ON PLUG										1.970.509	C10		
308 I													
1.4 16V	Petrol	70	09/07-10/14	8FS (EP3), EP3									
ENGINE													
Engine Information					A10	A20	A40	A50	A70	C10 - C30	C20	E01	
All engines x 4, COIL ON PLUG										1.970.475	C10		
1.4 16V	Petrol	72	12/09->	8FR (EP3), EP3C									
ENGINE													
Engine Information					A10	A20	A40	A50	A70	C10 - C30	C20	E01	
Eng. 8FR (EP3)										1.970.475	C10		
Eng. EP3C										1.970.475	C10		
Qty: 4													
1.6 16V	Petrol	103	09/07-12/14	5FT (EP6DT)									
ENGINE													
Engine Information					A10	A20	A40	A50	A70	C10 - C30	C20	E01	
All engines x 4, COIL ON PLUG										1.970.475	C10		
1.6 16V	Petrol	110	09/07-12/14	5FX (EP6DT)									
ENGINE													
Engine Information					A10	A20	A40	A50	A70	C10 - C30	C20	E01	
All engines x 4, COIL ON PLUG										1.970.475	C10		
1.6 16V	Petrol	115	06/09-12/14	5FV (EP6CDT)									
ENGINE													
Engine Information					A10	A20	A40	A50	A70	C10 - C30	C20	E01	
All engines x 4, COIL ON PLUG										1.970.475	C10		
1.6 16V	Petrol	128	03/08-10/14	5FY (EP6DTS)									
ENGINE													
Engine Information					A10	A20	A40	A50	A70	C10 - C30	C20	E01	
All engines x 4, COIL ON PLUG										1.970.475	C10		
1.6 16V	Petrol	80	07/08->	N6A (TU5JP4)									
ENGINE													
Engine Information					A10	A20	A40	A50	A70	C10 - C30	C20	E01	
All engines										1.970.407	C10		
1.6 16V	Petrol	88	09/07->	5FS (EP6C), 5FW (EP6), EP6, EP6C									
ENGINE													
Engine Information					A10	A20	A40	A50	A70	C10 - C30	C20	E01	
Eng. 5FS (EP6C), 5FW (EP6), EP6										1.970.475	C10		
Eng. EP6C										1.970.475	C10		
Qty: 4													
1.6 BioFlex	Petrol	80	07/08->	N6A (TU5JP4)									
ENGINE													
Engine Information					A10	A20	A40	A50	A70	C10 - C30	C20	E01	
All engines										1.970.407	C10		
All engines x 1, COIL ON PLUG										1.970.407	C10		

A10	CONDENSER	A20	CONTACT SET	A40	DISTRIBUTOR CAP	A50	ROTOR	A70	PICK-UP
C10	COIL	C20	IGNITION MODULE	C30	ELECTRONIC IGNITION KIT	E01	IGNITION CABLE SET		

The present application list is a brief version. For the detailed information about the possibility of installation on a specific vehicle, please refer to our web-catalogue <http://catalogo.facet.eu/>

					FUNCTIONS ON THE VEHICLE							
Vehicle	alim.	kW	Date	Engine								
ENGINE												
1.6 Bioflex	Petrol/ Ethanol	82	03/09-10/14	NFU (TU5JP4)								
Engine	Information				A10	A20	A40	A50	A70	C10 - C30	C20	E01
All engines	x 1, COIL ON PLUG									1.970.407	C10	
ENGINE												
1.6 GTi	Petrol	147	07/10-10/14	EP6CDTX								
Engine	Information				A10	A20	A40	A50	A70	C10 - C30	C20	E01
All engines	x 4, COIL ON PLUG									1.970.475	C10	
ENGINE												
1.6 THP	Petrol	110	01/11->	EP6CDT M								
Engine	Information				A10	A20	A40	A50	A70	C10 - C30	C20	E01
All engines	Qty: 4									1.970.475	C10	
ENGINE												
1.6 THP	Petrol	120	01/11->	EP6CDT MD								
Engine	Information				A10	A20	A40	A50	A70	C10 - C30	C20	E01
All engines	Qty: 4									1.970.475	C10	
ENGINE												
1.6 THP	Petrol	147	10/10-12/14	EP6CDTX								
Engine	Information				A10	A20	A40	A50	A70	C10 - C30	C20	E01
All engines	x 4, COIL ON PLUG									1.970.475	C10	
ENGINE												
1.6 THP 16V	Petrol	115	10/09-10/14	5FV (EP6CDT)								
Engine	Information				A10	A20	A40	A50	A70	C10 - C30	C20	E01
All engines	x 4, COIL ON PLUG									1.970.475	C10	
ENGINE												
2.0 Bioflex	Petrol/ Ethanol	103	01/08-12/12	RFJ (EW10A)								
Engine	Information				A10	A20	A40	A50	A70	C10 - C30	C20	E01
All engines	x 1, COIL ON PLUG									1.970.476	C10	
ENGINE												
2.0 CVT	Petrol	103	07/09-12/14	RFJ (EW10A)								
Engine	Information				A10	A20	A40	A50	A70	C10 - C30	C20	E01
All engines	x 1, COIL ON PLUG									1.970.476	C10	
308 II												
ENGINE												
1.2 THP 130	Petrol	96	03/14-06/21	HNY (EB2DTS)								
Engine	Information				A10	A20	A40	A50	A70	C10 - C30	C20	E01
All engines	x 3, COIL ON PLUG									1.970.620	C10	
ENGINE												
1.2 VTi 72	Petrol	60	09/13->	HMZ (EB2), HMZ (EB2F)								
Engine	Information				A10	A20	A40	A50	A70	C10 - C30	C20	E01
Eng. HMZ (EB2)	Qty: 3									1.970.609	C10	
Eng. HMZ (EB2F)	x 3, COIL ON PLUG									1.970.609	C10	
ENGINE												
1.6	Petrol	120	01/12->	5GZ (EP6FDT)								
Engine	Information				A10	A20	A40	A50	A70	C10 - C30	C20	E01
All engines	Qty: 4									1.970.475	C10	
ENGINE												
1.6 GT 205	Petrol	151	06/14-06/21	3AC								
Engine	Information				A10	A20	A40	A50	A70	C10 - C30	C20	E01
All engines	x 4, COIL ON PLUG									1.970.475	C10	
ENGINE												
1.6 GTi	Petrol	184	08/15-06/21	6AAS								
Engine	Information				A10	A20	A40	A50	A70	C10 - C30	C20	E01
All engines	x 4, COIL ON PLUG									1.970.475	C10	
ENGINE												
1.6 GTi	Petrol	200	06/15-06/21	5GN (EP6FDTR)								
Engine	Information				A10	A20	A40	A50	A70	C10 - C30	C20	E01
All engines	x 4, COIL ON PLUG									1.970.475	C10	

A10 CONDENSER	A20 CONTACT SET	A40 DISTRIBUTOR CAP	A50 ROTOR	A70 PICK-UP
C10 COIL	C20 IGNITION MODULE	C30 ELECTRONIC IGNITION KIT	E01 IGNITION CABLE SET	

Vehicle	alim.	kW	Date	Engine	FUNCTIONS ON THE VEHICLE									
					A10	A20	A40	A50	A70	C10 - C30	C20	E01		
ENGINE														
1.6 GTi PureTech 263	Petrol	193	07/18-06/21	EGX (EP6FADTR)										
Engine	Information				A10	A20	A40	A50	A70	C10 - C30	C20	E01		
All engines	x 4, COIL ON PLUG									1.970.475	C10			
ENGINE														
1.6 PureTech 225	Petrol	165	01/18-06/21	5GG (EP6FADTX), GGR (EP6FADTX)										
Engine	Information				A10	A20	A40	A50	A70	C10 - C30	C20	E01		
All engines	x 4, COIL ON PLUG									1.970.475	C10			
ENGINE														
1.6 THP	Petrol	112	09/13-06/21	5GX (EP6FDTM)										
Engine	Information				A10	A20	A40	A50	A70	C10 - C30	C20	E01		
All engines	x 4, COIL ON PLUG									1.970.475	C10			
ENGINE														
1.6 THP	Petrol	115	09/13-06/21	5FV (EP6CDT), 5FV (EP6DT)										
Engine	Information				A10	A20	A40	A50	A70	C10 - C30	C20	E01		
Eng. 5FV (EP6CDT)	x 4, COIL ON PLUG									1.970.475	C10			
Eng. 5FV (EP6DT)	Qty: 4									1.970.475	C10			
ENGINE														
1.6 THP 125	Petrol	92	09/13-06/21	5FA (EP6CDT)										
Engine	Information				A10	A20	A40	A50	A70	C10 - C30	C20	E01		
All engines	x 4, COIL ON PLUG									1.970.475	C10			
ENGINE														
1.6 THP 150	Petrol	110	03/14-06/21	5GX (EP6FDTM)										
Engine	Information				A10	A20	A40	A50	A70	C10 - C30	C20	E01		
All engines	x 4, COIL ON PLUG									1.970.475	C10			
ENGINE														
1.6 THP 155	Petrol	115	03/14-06/21	5FV (EP6CDT), 5FV (EP6DT)										
Engine	Information				A10	A20	A40	A50	A70	C10 - C30	C20	E01		
Eng. 5FV (EP6CDT)	x 4, COIL ON PLUG									1.970.475	C10			
Eng. 5FV (EP6DT)	Qty: 4									1.970.475	C10			
ENGINE														
1.6 THP 163	Petrol	120	06/14-06/21	5FM (EP6CDTM)										
Engine	Information				A10	A20	A40	A50	A70	C10 - C30	C20	E01		
All engines	x 4, COIL ON PLUG									1.970.475	C10			
ENGINE														
1.6 THP 210	Petrol	155	04/15->	5GM (EP6FDTX)										
Engine	Information				A10	A20	A40	A50	A70	C10 - C30	C20	E01		
All engines	Qty: 4									1.970.475	C10			
309 I														
ENGINE														
1.1	Petrol	40	10/85-07/89	E1										
Engine	Information				A10	A20	A40	A50	A70	C10 - C30	C20	E01		
All engines	version Bosch						1.306.124	1.406.061R						
All engines	version Duellier						1.315.058	1.415.094						
All engines	01/01/89 ->									1.970.106	C10			
All engines												1.965.005		
ENGINE														
1.3	Petrol	47	10/85-07/89	G1A										
Engine	Information				A10	A20	A40	A50	A70	C10 - C30	C20	E01		
All engines	version Bosch						1.306.124	1.406.061R						
All engines	version Duellier						1.315.058	1.415.094						
All engines	version Bosch, distr. num. 0 237 002 114								1.906.153					
All engines	01/01/89 ->									1.970.106	C10			
All engines												1.965.005		
ENGINE														
1.3 XL	Petrol	52	09/86-08/89	--										
Engine	Information				A10	A20	A40	A50	A70	C10 - C30	C20	E01		
All engines	version Duellier						1.315.058	1.415.094						
All engines	01/01/89 ->									1.970.106	C10			

A10	CONDENSER	A20	CONTACT SET	A40	DISTRIBUTOR CAP	A50	ROTOR	A70	PICK-UP
C10	COIL	C20	IGNITION MODULE	C30	ELECTRONIC IGNITION KIT	E01	IGNITION CABLE SET		

The present application list is a brief version. For the detailed information about the possibility of installation on a specific vehicle, please refer to our web-catalogue <http://catalogo.facet.eu/>

					FUNCTIONS ON THE VEHICLE							
Vehicle	alim.	kW	Date	Engine								
ENGINE												
1.3 XL	Petrol	52	09/86-08/89	--								
ENGINE												
Engine	Information				A10	A20	A40	A50	A70	C10 - C30	C20	E01
All engines											1.965.005	
ENGINE												
1.4	Petrol	49	03/89-07/89	K1D (TU3A)								
ENGINE												
Engine	Information				A10	A20	A40	A50	A70	C10 - C30	C20	E01
All engines	version Bosch						1.306.241	1.406.056R				
All engines	version Ducellier						1.315.074	1.415.102R	1.915.019			
All engines										1.970.105	C10	1.500.780
ENGINE												
1.4	Petrol	55	03/89-07/89	KDY (TU3M), KDZ (TU3M)								
ENGINE												
Engine	Information				A10	A20	A40	A50	A70	C10 - C30	C20	E01
All engines	version Bosch						1.306.241	1.406.026R				
All engines	version Ducellier						1.315.074	1.415.102R	1.915.019			
All engines										1.970.105	C10	1.500.780
ENGINE												
1.4	Petrol	62	08/88-08/89	K2B (TU3S)								
ENGINE												
Engine	Information				A10	A20	A40	A50	A70	C10 - C30	C20	E01
All engines	version Ducellier						1.315.074	1.415.102R	1.915.019			
All engines										1.970.105	C10	1.500.780
ENGINE												
1.5	Petrol	63	06/87-12/89	Y2/K								
ENGINE												
Engine	Information				A10	A20	A40	A50	A70	C10 - C30	C20	E01
All engines	version Bosch						1.306.124	1.406.025R				
All engines	version Ducellier						1.315.058	1.415.094				
All engines	01/01/89 ->									1.970.106	C10	
All engines											1.965.005	
ENGINE												
1.6	Petrol	53	08/87-07/89	B1E (XU51C)								
ENGINE												
Engine	Information				A10	A20	A40	A50	A70	C10 - C30	C20	E01
All engines	version Bosch						1.306.124	1.406.056R				
All engines	version Ducellier, distr. num. 2525640 A						1.315.058					
All engines	version Ducellier, distr. num. 2525640 B/C						1.315.067		1.915.017			
All engines	version Ducellier							1.415.094				
All engines											1.965.005	
ENGINE												
1.6	Petrol	55	10/85-07/89	B1A (XU51C)								
ENGINE												
Engine	Information				A10	A20	A40	A50	A70	C10 - C30	C20	E01
All engines	version Bosch						1.306.124	1.406.056R				
All engines	version Ducellier, distr. num. 2525640 A						1.315.058					
All engines	version Ducellier, distr. num. 2525640 B/C						1.315.067		1.915.017			
All engines	version Ducellier							1.415.094				
All engines											1.965.005	
ENGINE												
1.6	Petrol	59	10/85-07/89	B1A (XU51C), B1D (XU51C)								
ENGINE												
Engine	Information				A10	A20	A40	A50	A70	C10 - C30	C20	E01
All engines	version Bosch						1.306.124	1.406.056R				
All engines	version Ducellier, distr. num. 2525640 A						1.315.058					
All engines	version Ducellier, distr. num. 2525640 B/C						1.315.067		1.915.017			
All engines	version Ducellier							1.415.094				
All engines											1.965.005	
ENGINE												
1.6	Petrol	69	01/86-07/89	--								
ENGINE												
Engine	Information				A10	A20	A40	A50	A70	C10 - C30	C20	E01
All engines	version Bosch						1.306.124	1.406.061R				
All engines	01/01/89 ->									1.970.106	C10	
All engines											1.965.005	

A10 CONDENSER	A20 CONTACT SET	A40 DISTRIBUTOR CAP	A50 ROTOR	A70 PICK-UP
C10 COIL	C20 IGNITION MODULE	C30 ELECTRONIC IGNITION KIT	E01 IGNITION CABLE SET	

Vehicle	alim.	kW	Date	Engine	FUNCTIONS ON THE VEHICLE							
					A10	A20	A40	A50	A70	C10 - C30	C20	E01

ENGINE				
1.6	Petrol	76	11/85-09/88	180Z (XU5J), B6B (XU5J)

Engine	Information	A10	A20	A40	A50	A70	C10 - C30	C20	E01
All engines	version Bosch			1.306.124	1.406.056R				
All engines								1.965.005	
All engines	01/01/88 ->								1.500.747

ENGINE				
1.6	Petrol	83	07/86-06/89	--

Engine	Information	A10	A20	A40	A50	A70	C10 - C30	C20	E01
All engines	version Bosch			1.306.124	1.406.056R				
All engines								1.965.005	
All engines	01/01/88 ->								1.500.747

ENGINE				
1.6 Cat	Petrol	55	09/86-12/89	BAZ (XU5CP)

Engine	Information	A10	A20	A40	A50	A70	C10 - C30	C20	E01
All engines	version Bosch			1.306.124	1.406.056R				
All engines	distr. num. 2525626 A, version Ducellier			1.315.058					
All engines	distr. num. 2525626 B/C, version Ducellier, distr. num. 2525683 A/B			1.315.067		1.915.017			
All engines	version Ducellier				1.415.094				
All engines								1.965.005	1.500.747

ENGINE				
1.9	Petrol	72	03/86-07/89	DFZ (XU9J1)

Engine	Information	A10	A20	A40	A50	A70	C10 - C30	C20	E01
All engines	version Bosch			1.306.124	1.406.056R				
All engines	version Ducellier			1.315.067	1.415.094	1.915.017			
All engines								1.965.005	
All engines	01/01/88 ->, ->ch. 10561562								1.500.747

ENGINE				
1.9	Petrol	75	10/85-07/89	D2B (XU9S)

Engine	Information	A10	A20	A40	A50	A70	C10 - C30	C20	E01
All engines	version Bosch			1.306.124	1.406.056R				
All engines	version Ducellier			1.315.067	1.415.094	1.915.017			
All engines								1.965.005	
All engines	01/01/88 ->								1.500.747

ENGINE				
1.9 GTI	Petrol	94	10/86-07/89	D6B (XU9JA)

Engine	Information	A10	A20	A40	A50	A70	C10 - C30	C20	E01
All engines	version Bosch			1.306.241	1.406.056R				
All engines								1.965.005	

309 II

ENGINE				
1.1	Petrol	40	09/89-10/93	H1B (TU1)

Engine	Information	A10	A20	A40	A50	A70	C10 - C30	C20	E01
All engines	version Bosch			1.306.241	1.406.056R				
All engines	version Ducellier			1.315.074	1.415.102R	1.915.019			
All engines	version Marelli				1.430.060				
All engines							1.970.105	C10	1.500.780

ENGINE				
1.1	Petrol	44	08/90-12/93	HDZ (TU1M)

Engine	Information	A10	A20	A40	A50	A70	C10 - C30	C20	E01
All engines	version Bosch			1.306.241	1.406.026R				
All engines	version Ducellier			1.315.074	1.415.102R	1.915.019			
All engines							1.970.105	C10	1.500.780

ENGINE				
1.4	Petrol	55	07/89-12/93	KDZ (TU3M)

Engine	Information	A10	A20	A40	A50	A70	C10 - C30	C20	E01
All engines	version Bosch			1.306.241	1.406.026R				
All engines	version Ducellier			1.315.074	1.415.102R	1.915.019			
All engines							1.970.105	C10	1.500.780

A10	CONDENSER	A20	CONTACT SET	A40	DISTRIBUTOR CAP	A50	ROTOR	A70	PICK-UP
C10	COIL	C20	IGNITION MODULE	C30	ELECTRONIC IGNITION KIT	E01	IGNITION CABLE SET		

The present application list is a brief version. For the detailed information about the possibility of installation on a specific vehicle, please refer to our web-catalogue <http://catalogo.facet.eu/>









FUNCTIONS ON THE VEHICLE

Vehicle	alim.	kW	Date	Engine													
ENGINE																	
1.6	Petrol	65	07/89-12/93	BDZ (XU5M)													
Engine	Information			A10	A20	A40	A50	A70	C10 - C30	C20	E01						
All engines	version Ducellier					1.315.074	1.415.102R	1.915.019									
All engines	->year 31/12/91								1.970.106	C10		1.500.748					
All engines	01/01/92->								1.970.188	C10		1.500.674					
ENGINE																	
1.6	Petrol	68	07/89-12/93	18EM													
Engine	Information			A10	A20	A40	A50	A70	C10 - C30	C20	E01						
All engines	version Ducellier					1.315.074	1.415.102R	1.915.019									
All engines									1.970.106	C10		1.500.748					
ENGINE																	
1.6	Petrol	69	07/89-12/93	18EM													
Engine	Information			A10	A20	A40	A50	A70	C10 - C30	C20	E01						
All engines	version Bosch					1.306.124	1.406.061R										
All engines	01/01/91->								1.970.106	C10							
All engines											1.965.005						
ENGINE																	
1.6 GTi	Petrol	85	09/89-10/93	--													
Engine	Information			A10	A20	A40	A50	A70	C10 - C30	C20	E01						
All engines	->year 31/12/90, version Bosch					1.306.124	1.406.056R										
All engines	01/01/91->, version Bosch					1.306.241	1.406.026R										
All engines	01/01/91->								1.970.105	C10		1.500.491					
All engines											1.965.005						
All engines	->year 31/12/90, 01/01/88->											1.500.747					
ENGINE																	
1.9	Petrol	80	10/90-12/93	DDZ (XU9M)													
Engine	Information			A10	A20	A40	A50	A70	C10 - C30	C20	E01						
All engines	version Ducellier					1.315.074	1.415.102R	1.915.019									
ENGINE																	
1.9 GTI	Petrol	88	07/89-12/93	DKZ (XU9JAZ)													
Engine	Information			A10	A20	A40	A50	A70	C10 - C30	C20	E01						
All engines	version Ducellier					1.315.074	1.415.102R										
All engines	01/01/91->								1.970.105	C10		1.500.491					
All engines											1.965.005						
ENGINE																	
1.9 GTI 16V	Petrol	116	08/89-07/90	D6C (XU9J4)													
Engine	Information			A10	A20	A40	A50	A70	C10 - C30	C20	E01						
All engines	version Ducellier					1.315.077	1.415.104										
All engines	Kit, version Ducellier					1.315.078											
All engines									1.970.106	C10	1.965.005						
4007																	
ENGINE																	
2.0	Petrol	108	11/10-03/13	4B11													
Engine	Information			A10	A20	A40	A50	A70	C10 - C30	C20	E01						
All engines	x 4, COIL ON PLUG								1.970.497	C10							
ENGINE																	
2.0 4x4	Petrol	108	11/10-03/13	4B11													
Engine	Information			A10	A20	A40	A50	A70	C10 - C30	C20	E01						
All engines	x 4, COIL ON PLUG								1.970.497	C10							
ENGINE																	
2.4 16V	Petrol	125	02/07-03/13	SFY (4B12-MMC), SFZ (4B12-MMC)													
Engine	Information			A10	A20	A40	A50	A70	C10 - C30	C20	E01						
All engines	x 4, COIL ON PLUG								1.970.497	C10							
4008																	
ENGINE																	
1.6	Petrol	84	05/12->	MMC													
Engine	Information			A10	A20	A40	A50	A70	C10 - C30	C20	E01						
All engines	Qty: 4								1.970.505	C10							
A10	CONDENSER	A20	CONTACT SET	A40	DISTRIBUTOR CAP	A50	ROTOR	A70	PICK-UP	C10	COIL	C20	IGNITION MODULE	C30	ELECTRONIC IGNITION KIT	E01	IGNITION CABLE SET

Vehicle	alim.	kW	Date	Engine	FUNCTIONS ON THE VEHICLE									
					A10	A20	A40	A50	A70	C10 - C30	C20	E01		
1.6	Petrol	86	05/12->	ENGINE --, 4A92										
Engine	Information				A10	A20	A40	A50	A70	C10 - C30	C20	E01		
Eng. --	Qty: 4									1.970.505	C10			
Eng. 4A92	x 4, COIL ON PLUG									1.970.505	C10			
2.0	Petrol	110	05/13->	ENGINE 4B11										
Engine	Information				A10	A20	A40	A50	A70	C10 - C30	C20	E01		
All engines	Qty: 4									1.970.497	C10			
All engines	x 4, COIL ON PLUG									1.970.497	C10			
2.0 AWC	Petrol	110	05/12->	ENGINE 4B11										
Engine	Information				A10	A20	A40	A50	A70	C10 - C30	C20	E01		
All engines	x 4, COIL ON PLUG									1.970.497	C10			
404				ENGINE										
1.6	Petrol	48	04/63-12/71	ENGINE XC6										
Engine	Information				A10	A20	A40	A50	A70	C10 - C30	C20	E01		
All engines						1.206.040		1.406.014R						
1.6	Petrol	54	11/67-12/71	ENGINE XC6										
Engine	Information				A10	A20	A40	A50	A70	C10 - C30	C20	E01		
All engines						1.206.040		1.406.014R						
1.6	Petrol	59	04/63-12/68	ENGINE XC6										
Engine	Information				A10	A20	A40	A50	A70	C10 - C30	C20	E01		
All engines								1.406.014R						
1.6 GT	Petrol	50	07/71-12/71	ENGINE XC6										
Engine	Information				A10	A20	A40	A50	A70	C10 - C30	C20	E01		
All engines								1.406.014R						
405 I				ENGINE										
1.4	Petrol	47	01/87-07/92	ENGINE K5A (TU3)										
Engine	Information				A10	A20	A40	A50	A70	C10 - C30	C20	E01		
All engines	version Bosch						1.306.241	1.406.056R						
All engines	version Ducellier						1.315.074	1.415.102R	1.915.019					
All engines										1.970.105	C10		1.500.780	
1.6	Petrol	53	07/87-12/92	ENGINE B1E (XU51C)										
Engine	Information				A10	A20	A40	A50	A70	C10 - C30	C20	E01		
All engines	version Ducellier						1.315.074	1.415.102R	1.915.019					
All engines										1.970.106	C10	1.965.005	1.500.748	
1.6	Petrol	55	07/87-06/88	ENGINE B1E (XU51C)										
Engine	Information				A10	A20	A40	A50	A70	C10 - C30	C20	E01		
All engines	version Ducellier						1.315.074	1.415.102R	1.915.019					
All engines										1.970.106	C10	1.965.005	1.500.748	
1.6	Petrol	65	07/87-12/92	ENGINE BDY (XU5M2Z), BDY (XU5M3Z), BDZ (XU5M)										
Engine	Information				A10	A20	A40	A50	A70	C10 - C30	C20	E01		
Eng. BDZ (XU5M)	version Ducellier						1.315.074	1.415.102R						
Eng. BDZ (XU5M)										1.970.106	C10	1.965.005	1.500.748	
Eng. BDY (XU5M2Z), BDY (XU5M3Z)													1.500.674	
1.6	Petrol	66	10/88-12/92	ENGINE BDZ (XU5M)										
Engine	Information				A10	A20	A40	A50	A70	C10 - C30	C20	E01		
All engines	version Ducellier						1.315.074	1.415.102R						
All engines										1.970.106	C10	1.965.005	1.500.748	

A10	CONDENSER	A20	CONTACT SET	A40	DISTRIBUTOR CAP	A50	ROTOR	A70	PICK-UP
C10	COIL	C20	IGNITION MODULE	C30	ELECTRONIC IGNITION KIT	E01	IGNITION CABLE SET		

The present application list is a brief version. For the detailed information about the possibility of installation on a specific vehicle, please refer to our web-catalogue <http://catalogo.facet.eu/>

					FUNCTIONS ON THE VEHICLE								
Vehicle	alim.	kW	Date	Engine									
1.6	Petrol	69	01/87-12/92	ENGINE --, 18EM									
				Engine	Information	A10	A20	A40	A50	A70	C10 - C30	C20	E01
				All engines	version Bosch			1.306.241	1.406.056R				
				All engines	version Ducellier			1.315.074	1.415.102R	1.915.019			
				All engines							1.970.106	C10	1.500.748
1.6 4x4	Petrol	65	04/88-07/92	ENGINE BDZ (XU5M)									
				Engine	Information	A10	A20	A40	A50	A70	C10 - C30	C20	E01
				All engines	version Ducellier			1.315.074	1.415.102R				
				All engines							1.970.106	C10	1.965.005
				All engines									1.500.748
1.6 Sri 4x4	Petrol	65	04/88-07/92	ENGINE BDZ (XU5M)									
				Engine	Information	A10	A20	A40	A50	A70	C10 - C30	C20	E01
				All engines	version Ducellier			1.315.074	1.415.102R				
				All engines							1.970.106	C10	1.965.005
				All engines									1.500.748
1.9	Petrol	116	06/87-07/92	ENGINE D6C (XU9J4)									
				Engine	Information	A10	A20	A40	A50	A70	C10 - C30	C20	E01
				All engines	version Ducellier			1.315.077	1.415.104				
				All engines	Kit, version Ducellier			1.315.078					
				All engines							1.970.106	C10	1.965.005
1.9	Petrol	70	07/87-12/92	ENGINE D2C (XU92C)									
				Engine	Information	A10	A20	A40	A50	A70	C10 - C30	C20	E01
				All engines	version Bosch			1.306.241	1.406.026R				
				All engines	version Ducellier			1.315.074	1.415.102R	1.915.019			
				All engines							1.970.106	C10	1.500.748
1.9	Petrol	72	05/88-07/92	ENGINE DFZ (XU9J1)									
				Engine	Information	A10	A20	A40	A50	A70	C10 - C30	C20	E01
				All engines	version Bosch			1.306.124	1.406.056R				
				All engines	version Ducellier			1.315.067	1.415.102R	1.915.017			
				All engines								1.965.005	1.500.747
1.9	Petrol	77	10/88-08/92	ENGINE DFZ (XU9J1)									
				Engine	Information	A10	A20	A40	A50	A70	C10 - C30	C20	E01
				All engines	version Bosch			1.306.124	1.406.056R				
				All engines	version Ducellier			1.315.067	1.415.102R	1.915.017			
				All engines								1.965.005	1.500.747
1.9	Petrol	80	06/87-08/92	ENGINE DDZ (XU9M)									
				Engine	Information	A10	A20	A40	A50	A70	C10 - C30	C20	E01
				All engines	version Ducellier			1.315.074	1.415.102R				
1.9	Petrol	88	06/87-08/92	ENGINE DKZ (XU9JAZ)									
				Engine	Information	A10	A20	A40	A50	A70	C10 - C30	C20	E01
				All engines	version Ducellier			1.315.074	1.415.102R				
				All engines	ch. 8819069 ->						1.970.105	C10	
				All engines								1.965.005	
1.9	Petrol	90	01/89-12/92	ENGINE D6A (XU9J2)									
				Engine	Information	A10	A20	A40	A50	A70	C10 - C30	C20	E01
				All engines	version Bosch			1.306.241	1.406.056R				
				All engines							1.970.106	C10	
1.9	Petrol	93	07/87-12/93	ENGINE D6A (XU9J2)									
				Engine	Information	A10	A20	A40	A50	A70	C10 - C30	C20	E01
				All engines	version Bosch			1.306.241	1.406.056R				
				All engines							1.970.106	C10	

A10	CONDENSER	A20	CONTACT SET	A40	DISTRIBUTOR CAP	A50	ROTOR	A70	PICK-UP
C10	COIL	C20	IGNITION MODULE	C30	ELECTRONIC IGNITION KIT	E01	IGNITION CABLE SET		

Vehicle	alim.	kW	Date	Engine	FUNCTIONS ON THE VEHICLE									
					A10	A20	A40	A50	A70	C10 - C30	C20	E01		
ENGINE														
1.9 4x4	Petrol	116	06/87-07/92	D6C (XU9J4)										
Engine	Information				A10	A20	A40	A50	A70	C10 - C30	C20	E01		
All engines	version Ducellier						1.315.077	1.415.104						
All engines	Kit, version Ducellier						1.315.078							
All engines										1.970.106	C10	1.965.005		
ENGINE														
1.9 4x4	Petrol	80	07/88-12/92	DDZ (XU9M)										
Engine	Information				A10	A20	A40	A50	A70	C10 - C30	C20	E01		
All engines	version Ducellier						1.315.074	1.415.102R						
ENGINE														
1.9 4x4	Petrol	88	06/87-07/92	DKZ (XU9JAZ)										
Engine	Information				A10	A20	A40	A50	A70	C10 - C30	C20	E01		
All engines	version Ducellier						1.315.074	1.415.102R						
All engines	ch. 8819069 ->									1.970.105	C10			
All engines											1.965.005			
ENGINE														
1.9 Injection	Petrol	77	07/87-12/92	DFZ (XU9J1)										
Engine	Information				A10	A20	A40	A50	A70	C10 - C30	C20	E01		
All engines	version Bosch						1.306.124	1.406.056R						
All engines	version Ducellier						1.315.067	1.415.102R	1.915.017					
All engines											1.965.005	1.500.747		
ENGINE														
1.9 Sport MI-16	Petrol	108	06/87-07/92	DFW (XU9J4Z)										
Engine	Information				A10	A20	A40	A50	A70	C10 - C30	C20	E01		
All engines	version Ducellier						1.315.077	1.415.104						
All engines	Kit, version Ducellier						1.315.078							
All engines										1.970.106	C10	1.965.005		
ENGINE														
1.9 Sport MI-16	Petrol	116	07/87-11/92	D6C (XU9J4)										
Engine	Information				A10	A20	A40	A50	A70	C10 - C30	C20	E01		
All engines	version Ducellier						1.315.077	1.415.104						
All engines	Kit, version Ducellier						1.315.078							
All engines										1.970.106	C10	1.965.005		
ENGINE														
1.9 Sport MI-16 4x4	Petrol	108	06/87-07/92	DFW (XU9J4Z)										
Engine	Information				A10	A20	A40	A50	A70	C10 - C30	C20	E01		
All engines	version Ducellier						1.315.077	1.415.104						
All engines	Kit, version Ducellier						1.315.078							
All engines										1.970.106	C10	1.965.005		
ENGINE														
1.9 Trazione integrale	Petrol	116	06/87-07/92	D6C (XU9J4)										
Engine	Information				A10	A20	A40	A50	A70	C10 - C30	C20	E01		
All engines	version Ducellier						1.315.077	1.415.104						
All engines	Kit, version Ducellier						1.315.078							
All engines										1.970.106	C10	1.965.005		
ENGINE														
1.9 Trazione integrale	Petrol	77	09/88-07/92	DFZ (XU9J1)										
Engine	Information				A10	A20	A40	A50	A70	C10 - C30	C20	E01		
All engines	version Bosch						1.306.124	1.406.056R						
All engines	version Ducellier						1.315.067	1.415.102R	1.915.017					
All engines											1.965.005	1.500.747		
405 II														
ENGINE														
1.6	Petrol	65	08/92-10/96	BDY (XU5M2Z), BDY (XU5M3Z), BDZ (XU5M), BFZ (XU5JP)										
Engine	Information				A10	A20	A40	A50	A70	C10 - C30	C20	E01		
All engines										1.970.188	C10	1.500.674		

A10	CONDENSER	A20	CONTACT SET	A40	DISTRIBUTOR CAP	A50	ROTOR	A70	PICK-UP
C10	COIL	C20	IGNITION MODULE	C30	ELECTRONIC IGNITION KIT	E01	IGNITION CABLE SET		

The present application list is a brief version. For the detailed information about the possibility of installation on a specific vehicle, please refer to our web-catalogue <http://catalogo.facet.eu/>







					FUNCTIONS ON THE VEHICLE							
Vehicle	alim.	kW	Date	Engine	 A10	 A20	 A40	 A50	 A70	 C10 - C30	 C20	 E01
ENGINE												
1.6	Petrol	66	08/92-05/97	18EM, BFZ (XU5JP)								
Engine	Information											
Eng. 18EM	version Bosch					1.306.241	1.406.056R					
Eng. 18EM	version Ducellier					1.315.074	1.415.102R	1.915.019				
Eng. 18EM										1.970.106	C10	1.500.748
Eng. BFZ (XU5JP)										1.970.188	C10	1.500.674
ENGINE												
1.6	Petrol	68	08/92-08/94	18EM, BDZ (XU5M), BFZ (XU5JP)								
Engine	Information											
Eng. 18EM	version Bosch					1.306.241	1.406.056R					
Eng. 18EM	version Ducellier					1.315.074	1.415.102R	1.915.019				
Eng. 18EM										1.970.106	C10	1.500.748
Eng. BDZ (XU5M), BFZ (XU5JP)										1.970.188	C10	1.500.674
ENGINE												
1.8	Petrol	74	08/92-10/96	LFZ (XU7JP)								
Engine	Information											
All engines										1.970.188	C10	1.500.674
ENGINE												
2.0	Petrol	89	08/92-10/96	RFX (XU10J2)								
Engine	Information											
All engines										1.970.188	C10	1.500.494
ENGINE												
2.0 4x4	Petrol	89	08/92-10/96	RFX (XU10J2)								
Engine	Information											
All engines										1.970.188	C10	1.500.494
ENGINE												
2.0 X4	Petrol	89	08/92-10/95	RFX (XU10J2)								
Engine	Information											
All engines										1.970.188	C10	1.500.494
406												
ENGINE												
1.6	Petrol	65	11/95-05/04	BFZ (XU5JP)								
Engine	Information											
All engines	x 1, D.I.S., connector type, saw teeth									1.970.188	C10	
All engines												1.500.674
ENGINE												
1.8	Petrol	66	05/97-10/04	LFZ (XU7JB)								
Engine	Information											
All engines	x 1, D.I.S., connector type, saw teeth									1.970.188	C10	
All engines												1.500.674
ENGINE												
1.8	Petrol	74	10/96-03/99	L6A (XU7JP), LFZ (XU7JP)								
Engine	Information											
Eng. LFZ (XU7JP)										1.970.188	C10	1.500.674
All engines	x 1, D.I.S., connector type, saw teeth									1.970.188	C10	
ENGINE												
1.8 16V	Petrol	85	10/00-10/04	6FZ (EW7J4)								
Engine	Information											
All engines	x 4, COIL ON PLUG									1.970.408	C10	
ENGINE												
1.8 BiFuel	Petrol/ Liquified Petro- leum Gas (LPG)	85	09/00-05/04	6FZ (EW7J4)								
Engine	Information											
All engines	x 4, COIL ON PLUG									1.970.408	C10	

A10 CONDENSER	A20 CONTACT SET	A40 DISTRIBUTOR CAP	A50 ROTOR	A70 PICK-UP
C10 COIL	C20 IGNITION MODULE	C30 ELECTRONIC IGNITION KIT	E01 IGNITION CABLE SET	

Vehicle	alim.	kW	Date	Engine	FUNCTIONS ON THE VEHICLE									
					A10	A20	A40	A50	A70	C10 - C30	C20	E01		
ENGINE														
2.0 16V	Petrol	100	08/00-12/04	RFN (EW10J4), RFV (XU10J4R)										
Engine	Information				A10	A20	A40	A50	A70	C10 - C30	C20	E01		
All engines	x 4, COIL ON PLUG									1.970.408	C10			
ENGINE														
2.0 16V	Petrol	99	01/99-10/00	RFR (DEW10J4), RFR (EW10J4)										
Engine	Information				A10	A20	A40	A50	A70	C10 - C30	C20	E01		
Eng. RFR (DEW10J4)	incl. spark plug connector									1.970.408	C10			
Eng. RFR (EW10J4)	x 4, COIL ON PLUG									1.970.408	C10			
ENGINE														
2.0 Turbo	Petrol	108	04/96-10/04	RGX (XU10J2TE)										
Engine	Information				A10	A20	A40	A50	A70	C10 - C30	C20	E01		
All engines	x 1, D.I.S., connector type, saw teeth									1.970.188	C10			
All engines													1.500.494	
ENGINE														
2.2	Petrol	116	07/00-12/04	3FZ (EW12J4)										
Engine	Information				A10	A20	A40	A50	A70	C10 - C30	C20	E01		
All engines	x 4, COIL ON PLUG									1.970.509	C10			
407														
ENGINE														
1.8	Petrol	85	03/04-07/05	6FZ (EW7J4)										
Engine	Information				A10	A20	A40	A50	A70	C10 - C30	C20	E01		
All engines	x 4, COIL ON PLUG									1.970.408	C10			
ENGINE														
1.8 16V	Petrol	92	08/05-12/10	6FY (EW7A)										
Engine	Information				A10	A20	A40	A50	A70	C10 - C30	C20	E01		
All engines	x 4, COIL ON PLUG									1.970.408	C10			
ENGINE														
2.0	Petrol	100	03/04-07/05	RFN (EW10J4)										
Engine	Information				A10	A20	A40	A50	A70	C10 - C30	C20	E01		
All engines	x 4, COIL ON PLUG									1.970.408	C10			
ENGINE														
2.0 16V	Petrol	103	08/05-12/10	RFJ (EW10A)										
Engine	Information				A10	A20	A40	A50	A70	C10 - C30	C20	E01		
All engines	x 1, COIL ON PLUG									1.970.476	C10			
ENGINE														
2.0 Bioflex	Petrol/ Ethanol	103	09/07-02/11	RFJ (EW10A)										
Engine	Information				A10	A20	A40	A50	A70	C10 - C30	C20	E01		
All engines	x 1, COIL ON PLUG									1.970.476	C10			
ENGINE														
2.0 Flex	Petrol/ Ethanol	103	10/05-02/11	RFJ (EW10A)										
Engine	Information				A10	A20	A40	A50	A70	C10 - C30	C20	E01		
All engines	x 1, COIL ON PLUG									1.970.476	C10			
ENGINE														
2.2	Petrol	116	03/04-10/06	3FZ (EW12J4)										
Engine	Information				A10	A20	A40	A50	A70	C10 - C30	C20	E01		
All engines	x 4, COIL ON PLUG									1.970.509	C10			
ENGINE														
2.2 16V	Petrol	120	08/05->	3FY (EW12J4)										
Engine	Information				A10	A20	A40	A50	A70	C10 - C30	C20	E01		
All engines	x 4, COIL ON PLUG									1.970.509	C10			
5008 I														
ENGINE														
1.2	Petrol	96	01/15-03/17	HNY (EB2DTS)										
Engine	Information				A10	A20	A40	A50	A70	C10 - C30	C20	E01		
All engines	x 3, COIL ON PLUG									1.970.620	C10			

A10	CONDENSER	A20	CONTACT SET	A40	DISTRIBUTOR CAP	A50	ROTOR	A70	PICK-UP
C10	COIL	C20	IGNITION MODULE	C30	ELECTRONIC IGNITION KIT	E01	IGNITION CABLE SET		









The present application list is a brief version. For the detailed information about the possibility of installation on a specific vehicle, please refer to our web-catalogue <http://catalogo.facet.eu/>

				FUNCTIONS ON THE VEHICLE										
Vehicle	alim.	kW	Date	Engine										
				ENGINE										
1.6 16V	Petrol	115	09/09-03/17	5FV (EP6CDT)										
				ENGINE										
Engine		Information			A10	A20	A40	A50	A70	C10 - C30	C20	E01		
All engines		x 4, COIL ON PLUG								1.970.475	C10			
1.6 16V	Petrol	88	09/09-03/17	5F5 (EP6C), 5FW (EP6), EP6										
				ENGINE										
Engine		Information			A10	A20	A40	A50	A70	C10 - C30	C20	E01		
All engines		x 4, COIL ON PLUG								1.970.475	C10			
1.6 THP 150	Petrol	110	02/12-03/17	5FX (EP6DT)										
				ENGINE										
Engine		Information			A10	A20	A40	A50	A70	C10 - C30	C20	E01		
All engines		x 4, COIL ON PLUG								1.970.475	C10			
1.6 THP 163	Petrol	120	02/12-03/17	5GZ (EP6FDT)										
				ENGINE										
Engine		Information			A10	A20	A40	A50	A70	C10 - C30	C20	E01		
All engines		x 4, COIL ON PLUG								1.970.475	C10			
1.6 THP 165	Petrol	121	02/12-03/17	5GZ (EP6FDT)										
				ENGINE										
Engine		Information			A10	A20	A40	A50	A70	C10 - C30	C20	E01		
All engines		x 4, COIL ON PLUG								1.970.475	C10			
5008 II				ENGINE										
1.6	Petrol	110	07/18->	5GX (EP6FDTMD)										
				ENGINE										
Engine		Information			A10	A20	A40	A50	A70	C10 - C30	C20	E01		
All engines		x 4, COIL ON PLUG								1.970.475	C10			
1.6 PureTech 180	Petrol	133	07/18->	5GF (EP6FADTXD)										
				ENGINE										
Engine		Information			A10	A20	A40	A50	A70	C10 - C30	C20	E01		
All engines		x 4, COIL ON PLUG								1.970.475	C10			
1.6 THP 165	Petrol	121	12/16->	5GY (EP6FDTM), 5GZ (EP6FDT)										
				ENGINE										
Engine		Information			A10	A20	A40	A50	A70	C10 - C30	C20	E01		
All engines		x 4, COIL ON PLUG								1.970.475	C10			
504				ENGINE										
1.8	Petrol	54	04/71-07/86	XM7										
				ENGINE										
Engine		Information			A10	A20	A40	A50	A70	C10 - C30	C20	E01		
All engines						1.206.040, 1.215.111U		1.406.014R						
1.8	Petrol	55	09/79-08/82	XM7										
				ENGINE										
Engine		Information			A10	A20	A40	A50	A70	C10 - C30	C20	E01		
All engines		version Ducellier					1.315.058	1.415.091						
1.8	Petrol	58	01/71-06/83	XM7										
				ENGINE										
Engine		Information			A10	A20	A40	A50	A70	C10 - C30	C20	E01		
All engines						1.206.040, 1.215.111U		1.406.014R						
All engines		version Ducellier					1.315.058	1.415.091						
1.8 Injection	Petrol	71	07/68-02/71	KF5, KF6										
				ENGINE										
Engine		Information			A10	A20	A40	A50	A70	C10 - C30	C20	E01		
All engines		version Ducellier			1.115.023	1.215.055	1.315.054	1.415.091						
2.0	Petrol	68	04/71-07/86	XN1										
				ENGINE										
Engine		Information			A10	A20	A40	A50	A70	C10 - C30	C20	E01		
All engines						1.206.040		1.406.014R						
2.0	Petrol	71	03/71-06/86	106 (XN1)										
				ENGINE										
Engine		Information			A10	A20	A40	A50	A70	C10 - C30	C20	E01		
All engines						1.206.040		1.406.014R						
A10	CONDENSER		A20	CONTACT SET		A40	DISTRIBUTOR CAP		A50	ROTOR		A70	PICK-UP	
C10	COIL		C20	IGNITION MODULE		C30	ELECTRONIC IGNITION KIT		E01	IGNITION CABLE SET				

Vehicle	alim.	kW	Date	Engine	FUNCTIONS ON THE VEHICLE									
					A10	A20	A40	A50	A70	C10 - C30	C20	E01		
ENGINE														
2.0	Petrol	78	08/82-08/84	107 (XN2)										
ENGINE														
Engine	Information				A10	A20	A40	A50	A70	C10 - C30	C20	E01		
All engines						1.206.040								
ENGINE														
2.0 TI	Petrol	78	01/71-06/83	107 (XN2)										
ENGINE														
Engine	Information				A10	A20	A40	A50	A70	C10 - C30	C20	E01		
All engines						1.206.040								
ENGINE														
505														
ENGINE														
1.8	Petrol	55	06/81-10/85	105 (XM7)										
ENGINE														
Engine	Information				A10	A20	A40	A50	A70	C10 - C30	C20	E01		
All engines	version Ducellier				1.115.034	1.215.105	1.315.054	1.415.091						
All engines						1.206.040		1.406.014R		1.970.101D	C10			
ENGINE														
1.8	Petrol	60	01/82-10/85	105 (XM7)										
ENGINE														
Engine	Information				A10	A20	A40	A50	A70	C10 - C30	C20	E01		
All engines	version Ducellier				1.115.034	1.215.105	1.315.054	1.415.091						
All engines						1.206.040				1.970.101D	C10			
ENGINE														
1.8	Petrol	62	09/85-10/86	105C (XM7A)										
ENGINE														
Engine	Information				A10	A20	A40	A50	A70	C10 - C30	C20	E01		
All engines	version Ducellier				1.115.034		1.315.054	1.415.091						
ENGINE														
2.0	Petrol	60	04/82-11/87	--										
ENGINE														
Engine	Information				A10	A20	A40	A50	A70	C10 - C30	C20	E01		
All engines						1.206.040								
ENGINE														
2.0	Petrol	69	08/83-12/85	106 (XN1)										
ENGINE														
Engine	Information				A10	A20	A40	A50	A70	C10 - C30	C20	E01		
All engines						1.206.040		1.406.014R						
ENGINE														
2.0	Petrol	71	11/80-12/85	106 (XN1)										
ENGINE														
Engine	Information				A10	A20	A40	A50	A70	C10 - C30	C20	E01		
All engines						1.206.040		1.406.014R						
ENGINE														
2.0	Petrol	72	09/85-09/95	106E (XN1A)										
ENGINE														
Engine	Information				A10	A20	A40	A50	A70	C10 - C30	C20	E01		
All engines	version Bosch						1.306.079	1.406.055R						
All engines	version Ducellier						1.315.054	1.415.094						
All engines	version Marelli						1.330.098	1.430.047R	1.930.178M					
All engines											1.965.005			
ENGINE														
2.0 TI, STI	Petrol	81	08/79-10/86	829 (ZEJ)										
ENGINE														
Engine	Information				A10	A20	A40	A50	A70	C10 - C30	C20	E01		
All engines	version Bosch						1.306.079	1.406.056R	1.906.153					
All engines	version Ducellier						1.315.059	1.415.091						
All engines	->year 31/12/85										1.965.005			
ENGINE														
2.2	Petrol	84	01/86-12/93	851X (ZDJL)										
ENGINE														
Engine	Information				A10	A20	A40	A50	A70	C10 - C30	C20	E01		
All engines	version Bosch						1.306.079	1.406.055R						
All engines	version Bosch, distr. num. 0 237 035 001								1.906.159					
All engines											1.965.005			
ENGINE														
2.2	Petrol	85	05/81-10/84	851 (ZDJ)										
ENGINE														
Engine	Information				A10	A20	A40	A50	A70	C10 - C30	C20	E01		
All engines	version Bosch						1.306.079	1.406.055R						
All engines	version Bosch, distr. num. 0 237 035 001								1.906.159					
All engines											1.965.005			

A10	CONDENSER	A20	CONTACT SET	A40	DISTRIBUTOR CAP	A50	ROTOR	A70	PICK-UP
C10	COIL	C20	IGNITION MODULE	C30	ELECTRONIC IGNITION KIT	E01	IGNITION CABLE SET		

The present application list is a brief version. For the detailed information about the possibility of installation on a specific vehicle, please refer to our web-catalogue <http://catalogo.facet.eu/>







				FUNCTIONS ON THE VEHICLE								
Vehicle	alim.	kW	Date	Engine	 A10	 A20	 A40	 A50	 A70	 C10 - C30	 C20	 E01
				ENGINE								
2.2 GTI	Petrol	90	08/83-12/93	851B (ZDJL)								
Engine	Information											
All engines	version Bosch						1.306.079	1.406.055R				
All engines	version Bosch, distr. num. 0 237 035 001								1.906.159			
All engines											1.965.005	
				ENGINE								
508 I				ENGINE								
1.6	Petrol	121	02/12-12/18	5GZ (EP6FDT)								
Engine	Information											
All engines	x 4, COIL ON PLUG									1.970.475	C10	
				ENGINE								
1.6 THP	Petrol	110	11/10-12/18	5FE (EP6CDTM), 5FN (EP6CDT)								
Engine	Information											
All engines	x 4, COIL ON PLUG									1.970.475	C10	
				ENGINE								
1.6 THP	Petrol	115	11/10-12/18	5FV (EP6CDT)								
Engine	Information											
All engines	x 4, COIL ON PLUG									1.970.475	C10	
				ENGINE								
1.6 THP	Petrol	120	05/11->	5GZ (EP6FDT), EP6CDT M								
Engine	Information											
Eng. 5GZ (EP6FDT)	x 4, COIL ON PLUG									1.970.475	C10	
Eng. EP6CDT M	Qty: 4									1.970.475	C10	
				ENGINE								
1.6 THP	Petrol	121	09/11-12/18	5GZ (EP6FDT)								
Engine	Information											
All engines	x 4, COIL ON PLUG									1.970.475	C10	
				ENGINE								
1.6 Vti	Petrol	85	11/10-12/18	5FH (EP6C)								
Engine	Information											
All engines	x 4, COIL ON PLUG									1.970.475	C10	
				ENGINE								
1.6 Vti	Petrol	88	11/10-12/18	5FS (EP6C)								
Engine	Information											
All engines	x 4, COIL ON PLUG									1.970.475	C10	
				ENGINE								
				ENGINE								
508 II				ENGINE								
1.6 PureTech 180	Petrol	133	09/18->	5GF (EP6FADTXD), GFR (EP6FADTXD)								
Engine	Information											
All engines	x 4, COIL ON PLUG									1.970.475	C10	
				ENGINE								
1.6 PureTech 225	Petrol	165	09/18->	5GG (EP6FADTX), GCR (EP6FADTX)								
Engine	Information											
All engines	x 4, COIL ON PLUG									1.970.475	C10	
				ENGINE								
1.6 THP 150	Petrol	110	09/18->	5GX (EP6FTMD)								
Engine	Information											
All engines	x 4, COIL ON PLUG									1.970.475	C10	
				ENGINE								
1.6 THP 165	Petrol	121	09/18->	5GY (EP6FTM)								
Engine	Information											
All engines	x 4, COIL ON PLUG									1.970.475	C10	
				ENGINE								
Hybrid 224	Petrol/ Electric	133	08/19->	5GQ (EP6FADTXHPD)								
Engine	Information											
All engines	x 4, COIL ON PLUG									1.970.475	C10	

A10 CONDENSER	A20 CONTACT SET	A40 DISTRIBUTOR CAP	A50 ROTOR	A70 PICK-UP
C10 COIL	C20 IGNITION MODULE	C30 ELECTRONIC IGNITION KIT	E01 IGNITION CABLE SET	

Vehicle	alim.	kW	Date	Engine	FUNCTIONS ON THE VEHICLE								
					A10	A20	A40	A50	A70	C10 - C30	C20	E01	
ENGINE													
Hybrid 224	Petrol/ Electric	165	08/19->	5GQ (EP6FADTXHPD)									
Engine	Information				A10	A20	A40	A50	A70	C10 - C30	C20	E01	
All engines	x 4, COIL ON PLUG									1.970.475	C10		
ENGINE													
Hybrid 225	Petrol/ Electric	133	08/19->	5GQ (EP6FADTXHPD)									
Engine	Information				A10	A20	A40	A50	A70	C10 - C30	C20	E01	
All engines	x 4, COIL ON PLUG									1.970.475	C10		
ENGINE													
Hybrid 225	Petrol/ Electric	165	08/19->	5GQ (EP6FADTXHPD)									
Engine	Information				A10	A20	A40	A50	A70	C10 - C30	C20	E01	
All engines	x 4, COIL ON PLUG									1.970.475	C10		
604													
ENGINE													
2.0 i	Petrol	0	01/85-12/86	XN6									
Engine	Information				A10	A20	A40	A50	A70	C10 - C30	C20	E01	
All engines	version Ducellier						1.315.079	1.415.094					
ENGINE													
2.7 SL	Petrol	100	08/77-05/83	112 (ZM)									
Engine	Information				A10	A20	A40	A50	A70	C10 - C30	C20	E01	
All engines	version Bosch							1.406.049R					
ENGINE													
2.7 TI, STI	Petrol	106	08/77-05/83	140 (ZMJ)									
Engine	Information				A10	A20	A40	A50	A70	C10 - C30	C20	E01	
All engines	version Bosch							1.406.049R					
605													
ENGINE													
2.0	Petrol	79	02/90-09/99	--									
Engine	Information				A10	A20	A40	A50	A70	C10 - C30	C20	E01	
All engines	version Ducellier						1.315.074	1.415.102R					
ENGINE													
2.0	Petrol	84	06/89-09/99	RSA (XU102C)									
Engine	Information				A10	A20	A40	A50	A70	C10 - C30	C20	E01	
All engines	version Ducellier						1.315.074	1.415.102R	1.915.019				
ENGINE													
2.0	Petrol	89	06/89-09/99	RFZ (XU10JZZ)									
Engine	Information				A10	A20	A40	A50	A70	C10 - C30	C20	E01	
All engines										1.970.188	C10	1.500.494	
ENGINE													
2.0 Turbo	Petrol	104	07/92-09/99	RGY (XU10J2TE)									
Engine	Information				A10	A20	A40	A50	A70	C10 - C30	C20	E01	
All engines										1.970.188	C10	1.500.494	
ENGINE													
2.0 Turbo	Petrol	108	07/91-09/99	RGX (XU10J2TE)									
Engine	Information				A10	A20	A40	A50	A70	C10 - C30	C20	E01	
All engines										1.970.188	C10	1.500.494	
ENGINE													
3.0	Petrol	123	08/89-09/99	UFZ (ZPJ)									
Engine	Information				A10	A20	A40	A50	A70	C10 - C30	C20	E01	
All engines	version Bosch						1.306.252	1.406.119R					
All engines											1.965.034		
ENGINE													
3.0	Petrol	147	08/89-06/94	UKZ (ZPJ4/Z)									
Engine	Information				A10	A20	A40	A50	A70	C10 - C30	C20	E01	
All engines	version Bosch						1.306.252	1.406.119R					
All engines											1.965.034		

A10	CONDENSER	A20	CONTACT SET	A40	DISTRIBUTOR CAP	A50	ROTOR	A70	PICK-UP
C10	COIL	C20	IGNITION MODULE	C30	ELECTRONIC IGNITION KIT	E01	IGNITION CABLE SET		

The present application list is a brief version. For the detailed information about the possibility of installation on a specific vehicle, please refer to our web-catalogue <http://catalogo.facet.eu/>









					FUNCTIONS ON THE VEHICLE							
Vehicle	alim.	kW	Date	Engine								
3.0 SV 24												
	Petrol	147	08/89-09/99	ENGINE UKZ (ZPJ4/Z)								
Engine	Information				A10	A20	A40	A50	A70	C10 - C30	C20	E01
All engines	version Bosch						1.306.252	1.406.119R				
All engines											1.965.034	
607												
2.0												
	Petrol	100	02/00-08/05	ENGINE RFN (EW10J4)								
Engine	Information				A10	A20	A40	A50	A70	C10 - C30	C20	E01
All engines	x 4, COIL ON PLUG									1.970.408	C10	
2.2 16V												
	Petrol	116	02/00-08/05	ENGINE 3FZ (EW12J4)								
Engine	Information				A10	A20	A40	A50	A70	C10 - C30	C20	E01
All engines	euro 4 (D4), x 4, COIL ON PLUG									1.970.476	C10	
All engines	euro 3, x 4, COIL ON PLUG									1.970.509	C10	
2.2 16V												
	Petrol	120	09/05-06/10	ENGINE 3FY (EW12J4)								
Engine	Information				A10	A20	A40	A50	A70	C10 - C30	C20	E01
All engines	euro 4 (D4), x 4, COIL ON PLUG									1.970.476	C10	
All engines	euro 3, x 4, COIL ON PLUG									1.970.509	C10	
806												
1.8												
	Petrol	73	07/95-08/02	ENGINE LFW (XU7JP)								
Engine	Information				A10	A20	A40	A50	A70	C10 - C30	C20	E01
All engines	x 1, D.I.S., connector type, saw teeth									1.970.188	C10	
All engines												1.500.674
2.0												
	Petrol	100	05/00-02/03	ENGINE RFN (EW10J4)								
Engine	Information				A10	A20	A40	A50	A70	C10 - C30	C20	E01
All engines	x 4, COIL ON PLUG									1.970.408	C10	
2.0												
	Petrol	108	02/97-05/00	ENGINE RGX (XU10J2TE)								
Engine	Information				A10	A20	A40	A50	A70	C10 - C30	C20	E01
All engines	x 1, D.I.S., connector type, saw teeth									1.970.188	C10	
2.0												
	Petrol	89	06/94-08/02	ENGINE RFU (XU10J2)								
Engine	Information				A10	A20	A40	A50	A70	C10 - C30	C20	E01
All engines	x 1, D.I.S., connector type, saw teeth									1.970.188	C10	
All engines												1.500.494
2.0 16V												
	Petrol	100	09/00-08/02	ENGINE RFN (EW10J4)								
Engine	Information				A10	A20	A40	A50	A70	C10 - C30	C20	E01
All engines	x 4, COIL ON PLUG									1.970.408	C10	
2.0 Turbo												
	Petrol	108	06/94-08/02	ENGINE RGX (XU10J2TE)								
Engine	Information				A10	A20	A40	A50	A70	C10 - C30	C20	E01
All engines	x 1, D.I.S., connector type, saw teeth									1.970.188	C10	
All engines												1.500.494
807												
2.0												
	Petrol	100	06/02->	ENGINE RFN (EW10J4)								
Engine	Information				A10	A20	A40	A50	A70	C10 - C30	C20	E01
All engines	x 4, COIL ON PLUG									1.970.408	C10	
2.0 16V												
	Petrol	103	09/05->	ENGINE RFJ (EW10A)								
Engine	Information				A10	A20	A40	A50	A70	C10 - C30	C20	E01
All engines	x 1, COIL ON PLUG									1.970.476	C10	
2.2												
	Petrol	116	06/02->	ENGINE 3FZ (EW12J4)								
Engine	Information				A10	A20	A40	A50	A70	C10 - C30	C20	E01
All engines	x 4, COIL ON PLUG									1.970.509	C10	

A10 CONDENSER	A20 CONTACT SET	A40 DISTRIBUTOR CAP	A50 ROTOR	A70 PICK-UP
C10 COIL	C20 IGNITION MODULE	C30 ELECTRONIC IGNITION KIT	E01 IGNITION CABLE SET	

Vehicle	alim.	kW	Date	Engine	FUNCTIONS ON THE VEHICLE									
					A10	A20	A40	A50	A70	C10 - C30	C20	E01		
BIPPER														
1.4	Petrol	54	02/08->	ENGINE KFV (TU3A)										
Engine		Information			A10	A20	A40	A50	A70	C10 - C30	C20	E01		
All engines		x 4, COIL ON PLUG								1.970.405	C10			
BIPPER TEPEE														
1.4	Petrol	54	04/08->	ENGINE KFV (TU3A)										
Engine		Information			A10	A20	A40	A50	A70	C10 - C30	C20	E01		
All engines		x 4, COIL ON PLUG								1.970.405	C10			
BOXER I														
2.0	Petrol	81	12/01->	ENGINE RFL (XU10J2U)										
Engine		Information			A10	A20	A40	A50	A70	C10 - C30	C20	E01		
All engines		x 1, D.I.S., connector type, saw teeth								1.970.188	C10			
All engines													1.500.674	
2.0 4x4	Petrol	80	03/96-09/98	ENGINE --										
Engine		Information			A10	A20	A40	A50	A70	C10 - C30	C20	E01		
All engines										1.970.188	C10		1.500.674	
2.0 i	Petrol	80	03/94-04/02	ENGINE RFW (XU10J2)										
Engine		Information			A10	A20	A40	A50	A70	C10 - C30	C20	E01		
All engines										1.970.188	C10		1.500.674	
2.0 i 4x4	Petrol	80	08/96-04/02	ENGINE RFW (XU10J2)										
Engine		Information			A10	A20	A40	A50	A70	C10 - C30	C20	E01		
All engines										1.970.188	C10		1.500.674	
EXPERT I														
1.6	Petrol	58	02/96-09/00	ENGINE 222A2 (1580 SPI)										
Engine		Information			A10	A20	A40	A50	A70	C10 - C30	C20	E01		
All engines		x 1, D.I.S., connector type, saw teeth								1.970.168	C10			
All engines													1.500.655	
1.8	Petrol	74	10/96-09/00	ENGINE LFZ (XU7JP)										
Engine		Information			A10	A20	A40	A50	A70	C10 - C30	C20	E01		
All engines		x 1, D.I.S., connector type, saw teeth								1.970.188	C10			
All engines													1.500.674	
2.0	Petrol	100	07/00-12/06	ENGINE RFN (EW10J4)										
Engine		Information			A10	A20	A40	A50	A70	C10 - C30	C20	E01		
All engines		x 4, COIL ON PLUG								1.970.408	C10			
EXPERT II														
2.0 16V	Petrol	103	01/07->	ENGINE RFH (EW10A), RFJ (EW10A)										
Engine		Information			A10	A20	A40	A50	A70	C10 - C30	C20	E01		
All engines		x 1, COIL ON PLUG								1.970.476	C10			
EXPERT II TEPEE														
2.0 16V	Petrol	103	01/07-03/16	ENGINE RFH (EW10A), RFJ (EW10A)										
Engine		Information			A10	A20	A40	A50	A70	C10 - C30	C20	E01		
All engines		x 1, COIL ON PLUG								1.970.476	C10			
J5														
1.8	Petrol	51	01/83-11/88	ENGINE 169B (XM7T)										
Engine		Information			A10	A20	A40	A50	A70	C10 - C30	C20	E01		
All engines		version Ducellier					1.315.054	1.415.094						
All engines													1.965.005	

A10 CONDENSER	A20 CONTACT SET	A40 DISTRIBUTOR CAP	A50 ROTOR	A70 PICK-UP
C10 COIL	C20 IGNITION MODULE	C30 ELECTRONIC IGNITION KIT	E01 IGNITION CABLE SET	

The present application list is a brief version. For the detailed information about the possibility of installation on a specific vehicle, please refer to our web-catalogue <http://catalogo.facet.eu/>

					FUNCTIONS ON THE VEHICLE							
Vehicle	alim.	kW	Date	Engine	 A10	 A20	 A40	 A50	 A70	 C10 - C30	 C20	 E01
J9												
1.6	Petrol	44	03/80-06/87	ENGINE XC7P								
Engine		Information			A10	A20	A40	A50	A70	C10 - C30	C20	E01
All engines		version Ducellier			1.115.034	1.215.105	1.315.054	1.415.091				
2.0												
Petrol	57	03/80-06/87	ENGINE XN1P									
Engine		Information			A10	A20	A40	A50	A70	C10 - C30	C20	E01
All engines		version Ducellier					1.315.054	1.415.094				
All engines											1.965.005	
PARTNER I												
1.1	Petrol	44	06/96->	ENGINE HDY (TU1M), HDZ (TU1M), HFX (TU1JP)								
Engine		Information			A10	A20	A40	A50	A70	C10 - C30	C20	E01
Eng. HDY (TU1M), HDZ (TU1M)										1.970.188	C10	1.501.374
Eng. HDZ (TU1M), HFX (TU1JP)		x 1, COIL ON PLUG								1.970.405	C10	
1.4												
Petrol	54	11/02-10/06	ENGINE KFW (TU3JP)									
Engine		Information			A10	A20	A40	A50	A70	C10 - C30	C20	E01
All engines		x 1, COIL ON PLUG								1.970.405	C10	
1.4												
Petrol	55	06/96-12/15	ENGINE KFX (TU3JP), TU32									
Engine		Information			A10	A20	A40	A50	A70	C10 - C30	C20	E01
Eng. TU32		x 1, DISTRIBUTOR, connector type SAE								1.970.155	C10	
Eng. KFX (TU3JP)		->year 31/05/98								1.970.188	C10	
All engines		->year 31/05/98										1.501.374
1.4 BiFuel	Petrol/ Com- pressed Natural Gas (CNG)	55	04/03-10/06	ENGINE KFW (TU3JP)								
Engine		Information			A10	A20	A40	A50	A70	C10 - C30	C20	E01
All engines		x 1, COIL ON PLUG								1.970.405	C10	
1.6												
Petrol	80	09/00->	ENGINE N6A (TU5JP4), NFU (TU5JP4)									
Engine		Information			A10	A20	A40	A50	A70	C10 - C30	C20	E01
Eng. N6A (TU5JP4)										1.970.407	C10	
Eng. NFU (TU5JP4)		x 1, COIL ON PLUG								1.970.407	C10	
1.6 16V												
Petrol	80	07/01-03/08	ENGINE NFU (TU5JP4)									
Engine		Information			A10	A20	A40	A50	A70	C10 - C30	C20	E01
All engines		x 1, COIL ON PLUG								1.970.407	C10	
1.6 Bioflex												
Petrol/ Ethanol	80	09/00-10/02	ENGINE NFU (TU5JP4)									
Engine		Information			A10	A20	A40	A50	A70	C10 - C30	C20	E01
All engines		x 1, COIL ON PLUG								1.970.407	C10	
1.6 Flexfuel												
Petrol/ Ethanol	80	09/00-10/02	ENGINE NFU (TU5JP4)									
Engine		Information			A10	A20	A40	A50	A70	C10 - C30	C20	E01
All engines		x 1, COIL ON PLUG								1.970.407	C10	
1.8												
Petrol	66	03/97-12/02	ENGINE LFX (XU7JB)									
Engine		Information			A10	A20	A40	A50	A70	C10 - C30	C20	E01
All engines										1.970.188	C10	1.500.674
All engines		x 1, D.I.S., connector type, saw teeth								1.970.188	C10	

A10 CONDENSER	A20 CONTACT SET	A40 DISTRIBUTOR CAP	A50 ROTOR	A70 PICK-UP
C10 COIL	C20 IGNITION MODULE	C30 ELECTRONIC IGNITION KIT	E01 IGNITION CABLE SET	

Vehicle	alim.	kW	Date	Engine	FUNCTIONS ON THE VEHICLE							
					A10	A20	A40	A50	A70	C10 - C30	C20	E01

PARTNER II

1.2 THP	Petrol	81	02/16->	ENGINE HNZ (EB2DT)
---------	--------	----	---------	-----------------------

Engine	Information	A10	A20	A40	A50	A70	C10 - C30	C20	E01
All engines	x 3, COIL ON PLUG						1.970.620	C10	

1.6	Petrol	66	04/08->	ENGINE NFR (TU5JP4B)
-----	--------	----	---------	-------------------------

Engine	Information	A10	A20	A40	A50	A70	C10 - C30	C20	E01
All engines	x 1, COIL ON PLUG						1.970.407	C10	

1.6	Petrol	72	11/10->	ENGINE 5FK (EP6CB)
-----	--------	----	---------	-----------------------

Engine	Information	A10	A20	A40	A50	A70	C10 - C30	C20	E01
All engines	x 4, COIL ON PLUG						1.970.475	C10	

1.6	Petrol	80	04/08->	ENGINE NFU (TU5JP4)
-----	--------	----	---------	------------------------

Engine	Information	A10	A20	A40	A50	A70	C10 - C30	C20	E01
All engines	x 1, COIL ON PLUG						1.970.407	C10	

1.6	Petrol	88	04/10->	ENGINE 5FS (EP6C)
-----	--------	----	---------	----------------------

Engine	Information	A10	A20	A40	A50	A70	C10 - C30	C20	E01
All engines	x 4, COIL ON PLUG						1.970.475	C10	

PARTNER II TEPEE

1.2 THP	Petrol	81	02/16->	ENGINE HNV (EB2DTM), HNZ (EB2DT)
---------	--------	----	---------	-------------------------------------

Engine	Information	A10	A20	A40	A50	A70	C10 - C30	C20	E01
All engines	x 3, COIL ON PLUG						1.970.620	C10	

1.6 VTi	Petrol	66	04/08->	ENGINE NFR (TU5JP4B)
---------	--------	----	---------	-------------------------

Engine	Information	A10	A20	A40	A50	A70	C10 - C30	C20	E01
All engines	x 1, COIL ON PLUG						1.970.407	C10	

1.6 VTi	Petrol	72	08/10->	ENGINE 5FK (EP6CB)
---------	--------	----	---------	-----------------------

Engine	Information	A10	A20	A40	A50	A70	C10 - C30	C20	E01
All engines	x 4, COIL ON PLUG						1.970.475	C10	

1.6 VTi	Petrol	80	04/08->	ENGINE NFU (TU5JP4)
---------	--------	----	---------	------------------------

Engine	Information	A10	A20	A40	A50	A70	C10 - C30	C20	E01
All engines	x 1, COIL ON PLUG						1.970.407	C10	

1.6 VTi	Petrol	81	09/08->	ENGINE NFU (TU5JP4)
---------	--------	----	---------	------------------------

Engine	Information	A10	A20	A40	A50	A70	C10 - C30	C20	E01
All engines							1.970.407	C10	

1.6 VTi	Petrol	88	09/09-04/16	ENGINE 5FS (EP6C)
---------	--------	----	-------------	----------------------

Engine	Information	A10	A20	A40	A50	A70	C10 - C30	C20	E01
All engines	x 4, COIL ON PLUG						1.970.475	C10	

PARTNER ORIGIN

1.4	Petrol	55	07/08-12/15	ENGINE KFW (TU3JP)
-----	--------	----	-------------	-----------------------

Engine	Information	A10	A20	A40	A50	A70	C10 - C30	C20	E01
All engines	x 1, COIL ON PLUG						1.970.405	C10	

1.6	Petrol	81	09/11-12/15	ENGINE NFU (TU5JP4)
-----	--------	----	-------------	------------------------

Engine	Information	A10	A20	A40	A50	A70	C10 - C30	C20	E01
All engines	x 1, COIL ON PLUG						1.970.407	C10	

1.6 16V	Petrol	81	09/11-12/13	ENGINE NFU (TU5JP4)
---------	--------	----	-------------	------------------------

Engine	Information	A10	A20	A40	A50	A70	C10 - C30	C20	E01
All engines	x 1, COIL ON PLUG						1.970.407	C10	

A10 CONDENSER	A20 CONTACT SET	A40 DISTRIBUTOR CAP	A50 ROTOR	A70 PICK-UP
C10 COIL	C20 IGNITION MODULE	C30 ELECTRONIC IGNITION KIT	E01 IGNITION CABLE SET	

The present application list is a brief version. For the detailed information about the possibility of installation on a specific vehicle, please refer to our web-catalogue <http://catalogo.facet.eu/>

Vehicle	alim.	kW	Date	Engine	FUNCTIONS ON THE VEHICLE							
					A10	A20	A40	A50	A70	C10 - C30	C20	E01

RANCH

1.1	Petrol	44	06/96->	ENGINE HDY (TU1M), HDZ (TU1M), HFX (TU1JP)
-----	--------	----	---------	---

Engine	Information	A10	A20	A40	A50	A70	C10 - C30	C20	E01
Eng. HDY (TU1M), HDZ (TU1M)							1.970.188	C10	1.501.374
Eng. HFX (TU1JP)							1.970.405	C10	

1.4	Petrol	55	06/96->	ENGINE KFW (TU3JP), KFX (TU3JP)
-----	--------	----	---------	------------------------------------

Engine	Information	A10	A20	A40	A50	A70	C10 - C30	C20	E01
Eng. KFX (TU3JP)	->year 31/05/98						1.970.188	C10	1.501.374
Eng. KFX (TU3JP)	01/06/98 ->						1.970.403	C10	
Eng. KFW (TU3JP)							1.970.405	C10	

1.4 BiFuel	Petrol	55	04/03->	ENGINE KFW (TU3JP)
------------	--------	----	---------	-----------------------

Engine	Information	A10	A20	A40	A50	A70	C10 - C30	C20	E01
All engines							1.970.405	C10	

1.6 16V	Petrol	80	07/01->	ENGINE N6A (TU5JP4), NFU (TU5JP4)
---------	--------	----	---------	--------------------------------------

Engine	Information	A10	A20	A40	A50	A70	C10 - C30	C20	E01
All engines							1.970.407	C10	

1.8	Petrol	66	05/97->	ENGINE LFX (XU7JB)
-----	--------	----	---------	-----------------------

Engine	Information	A10	A20	A40	A50	A70	C10 - C30	C20	E01
All engines							1.970.188	C10	1.500.674

RCZ

1.6 16V	Petrol	115	03/10-12/15	ENGINE 5FV (EP6CDT)
---------	--------	-----	-------------	------------------------

Engine	Information	A10	A20	A40	A50	A70	C10 - C30	C20	E01
All engines	x 4, COIL ON PLUG						1.970.475	C10	

1.6 16V	Petrol	121	01/11-12/15	ENGINE 5FM (EP6CDTM)
---------	--------	-----	-------------	-------------------------

Engine	Information	A10	A20	A40	A50	A70	C10 - C30	C20	E01
All engines	Qty: 4						1.970.475	C10	

1.6 16V	Petrol	147	06/10-12/15	ENGINE EP6CDTX
---------	--------	-----	-------------	-------------------

Engine	Information	A10	A20	A40	A50	A70	C10 - C30	C20	E01
All engines	x 4, COIL ON PLUG						1.970.475	C10	

1.6 16V	Petrol	150	06/10-12/15	ENGINE EP6CDTX
---------	--------	-----	-------------	-------------------

Engine	Information	A10	A20	A40	A50	A70	C10 - C30	C20	E01
All engines	Qty: 4						1.970.475	C10	

1.6 THP 150	Petrol	110	03/11-12/15	ENGINE 5FE (EP6CDTMD)
-------------	--------	-----	-------------	--------------------------

Engine	Information	A10	A20	A40	A50	A70	C10 - C30	C20	E01
All engines	x 4, COIL ON PLUG						1.970.475	C10	

1.6 THP 270	Petrol	199	06/13-12/15	ENGINE 5FG (EP6CDTR)
-------------	--------	-----	-------------	-------------------------

Engine	Information	A10	A20	A40	A50	A70	C10 - C30	C20	E01
All engines	x 4, COIL ON PLUG						1.970.475	C10	

A10 CONDENSER	A20 CONTACT SET	A40 DISTRIBUTOR CAP	A50 ROTOR	A70 PICK-UP
C10 COIL	C20 IGNITION MODULE	C30 ELECTRONIC IGNITION KIT	E01 IGNITION CABLE SET	







Vehicle	alim.	kW	Date	Engine	FUNCTIONS ON THE VEHICLE							
					A10	A20	A40	A50	A70	C10 - C30	C20	E01
												

PORTER				ENGINE
1.0	Petrol	33	02/93-06/94	CB41

Engine	Information	A10	A20	A40	A50	A70	C10 - C30	C20	E01
All engines	version Denso				1.413.030				

A10	CONDENSER	A20	CONTACT SET	A40	DISTRIBUTOR CAP	A50	ROTOR	A70	PICK-UP
C10	COIL	C20	IGNITION MODULE	C30	ELECTRONIC IGNITION KIT	E01	IGNITION CABLE SET		

The present application list is a brief version. For the detailed information about the possibility of installation on a specific vehicle, please refer to our web-catalogue <http://catalogo.facet.eu/>

				FUNCTIONS ON THE VEHICLE													
Vehicle	alim.	kW	Date	Engine													
356				ENGINE													
A 1600	Petrol	44	01/55-12/59	--													
Engine	Information				A10	A20	A40	A50	A70	C10 - C30	C20	E01					
All engines						1.206.047		1.406.021R									
A 1600 GS Carrera				ENGINE													
Petrol	85	01/55-12/61	--														
Engine	Information				A10	A20	A40	A50	A70	C10 - C30	C20	E01					
All engines						1.206.047											
A 1600 S				ENGINE													
Petrol	55	01/55-12/59	616.15														
Engine	Information				A10	A20	A40	A50	A70	C10 - C30	C20	E01					
All engines						1.206.047		1.406.021R									
All engines	version BOSCH						1.306.076										
A 1600 Super				ENGINE													
Petrol	55	01/55-12/59	616.15														
Engine	Information				A10	A20	A40	A50	A70	C10 - C30	C20	E01					
All engines						1.206.047		1.406.021R									
All engines	version BOSCH						1.306.076										
B 1600				ENGINE													
Petrol	44	09/59-08/63	--														
Engine	Information				A10	A20	A40	A50	A70	C10 - C30	C20	E01					
All engines						1.206.047		1.406.021R									
B 1600 Super 75				ENGINE													
Petrol	55	01/59-12/63	616.15														
Engine	Information				A10	A20	A40	A50	A70	C10 - C30	C20	E01					
All engines						1.206.047		1.406.021R									
B 1600 Super 90				ENGINE													
Petrol	66	01/59-12/63	--														
Engine	Information				A10	A20	A40	A50	A70	C10 - C30	C20	E01					
All engines						1.206.047		1.406.021R									
C 1600				ENGINE													
Petrol	55	01/63-12/65	616.15														
Engine	Information				A10	A20	A40	A50	A70	C10 - C30	C20	E01					
All engines						1.206.047											
C 1600 SC				ENGINE													
Petrol	70	01/63-12/65	--														
Engine	Information				A10	A20	A40	A50	A70	C10 - C30	C20	E01					
All engines						1.206.047		1.406.018R, 1.406.021R									
911 I				ENGINE													
2.0 L	Petrol	110	08/67-11/68	--													
Engine	Information				A10	A20	A40	A50	A70	C10 - C30	C20	E01					
All engines						1.206.047											
2.0 L				ENGINE													
Petrol	96	01/67-12/68	901.01, 901.05														
Engine	Information				A10	A20	A40	A50	A70	C10 - C30	C20	E01					
All engines	version Bosch						1.306.072										
2.0 S				ENGINE													
Petrol	118	07/66-11/68	901.02, 901.08														
Engine	Information				A10	A20	A40	A50	A70	C10 - C30	C20	E01					
All engines						1.206.047											
2.0 S				ENGINE													
Petrol	125	07/66-02/72	901.10														
Engine	Information				A10	A20	A40	A50	A70	C10 - C30	C20	E01					
All engines						1.206.047											
2.7				ENGINE													
Petrol	110	09/73-08/75	911.41, 911.46, 911.92, 911.97														
Engine	Information				A10	A20	A40	A50	A70	C10 - C30	C20	E01					
All engines						1.206.062											
A10	CONDENSER	A20	CONTACT SET	A40	DISTRIBUTOR CAP	A50	ROTOR	A70	PICK-UP	C10	COIL	C20	IGNITION MODULE	C30	ELECTRONIC IGNITION KIT	E01	IGNITION CABLE SET

				FUNCTIONS ON THE VEHICLE								
Vehicle	alim.	kW	Date	Engine	 A10	 A20	 A40	 A50	 A70	 C10 - C30	 C20	 E01
				ENGINE								
3.6 Carrera	Petrol	210	08/95-09/97	M 64.21, M 64.22, M 64.23, M 64.24								
				ENGINE								
Engine				Information								
All engines				Qty: 2, version Bosch								
					A10	A20	A40	A50	A70	C10 - C30	C20	E01
								1.406.113R				
				ENGINE								
3.6 Carrera 4	Petrol	200	07/94-08/95	M 64.05, M 64.07								
				ENGINE								
Engine				Information								
All engines				Qty: 2, version Bosch								
					A10	A20	A40	A50	A70	C10 - C30	C20	E01
								1.406.113R				
				ENGINE								
3.6 Carrera 4	Petrol	210	08/95-09/97	M 64.21, M 64.23								
				ENGINE								
Engine				Information								
All engines				Qty: 2, version Bosch								
					A10	A20	A40	A50	A70	C10 - C30	C20	E01
								1.406.113R				
				ENGINE								
3.6 Turbo 4	Petrol	300	03/95-09/97	M 64.60								
				ENGINE								
Engine				Information								
All engines				version Bosch								
					A10	A20	A40	A50	A70	C10 - C30	C20	E01
							1.306.123	1.406.113R				
				ENGINE								
3.6 Turbo GT2	Petrol	316	03/95-09/97	M 64.60R								
				ENGINE								
Engine				Information								
All engines				version Bosch								
					A10	A20	A40	A50	A70	C10 - C30	C20	E01
							1.306.123	1.406.113R				
				ENGINE								
3.6 Turbo GT2 4	Petrol	316	08/95-09/97	M 64.60R								
				ENGINE								
Engine				Information								
All engines				version Bosch								
					A10	A20	A40	A50	A70	C10 - C30	C20	E01
							1.306.123	1.406.113R				
				ENGINE								
3.6 Turbo GT2 4	Petrol	331	06/97-09/97	M 64.60RS								
				ENGINE								
Engine				Information								
All engines				version Bosch								
					A10	A20	A40	A50	A70	C10 - C30	C20	E01
							1.306.123	1.406.113R				
				ENGINE								
3.8 Carrera	Petrol	210	06/95-09/97	M 64.05S, M 64.06S								
				ENGINE								
Engine				Information								
All engines				Qty: 2, version Bosch								
					A10	A20	A40	A50	A70	C10 - C30	C20	E01
								1.406.113R				
				ENGINE								
3.8 Carrera	Petrol	221	08/95-09/97	M 64.21S								
				ENGINE								
Engine				Information								
All engines				Qty: 2, version Bosch								
					A10	A20	A40	A50	A70	C10 - C30	C20	E01
								1.406.113R				
				ENGINE								
3.8 Carrera 4	Petrol	210	06/95-09/97	M 64.05S, M 64.06S								
				ENGINE								
Engine				Information								
All engines				Qty: 2, version Bosch								
					A10	A20	A40	A50	A70	C10 - C30	C20	E01
								1.406.113R				
				ENGINE								
3.8 Carrera 4	Petrol	221	08/95-09/97	M 64.21S								
				ENGINE								
Engine				Information								
All engines				Qty: 2, version Bosch								
					A10	A20	A40	A50	A70	C10 - C30	C20	E01
								1.406.113R				
				ENGINE								
3.8 Carrera RS	Petrol	221	06/95-09/97	M 64.20								
				ENGINE								
Engine				Information								
All engines				Qty: 2, version Bosch								
					A10	A20	A40	A50	A70	C10 - C30	C20	E01
								1.406.113R				
				ENGINE								
912												
				ENGINE								
1.6	Petrol	66	01/65-02/70	616.36, 616.39, 616.40								
				ENGINE								
Engine				Information								
All engines												
All engines				version BOSCH								
					A10	A20	A40	A50	A70	C10 - C30	C20	E01
						1.206.047						
							1.306.076					
				ENGINE								
924												
				ENGINE								
2.0 Turbo	Petrol	130	06/80-10/86	M 31.03								
				ENGINE								
Engine				Information								
All engines				version Bosch								
					A10	A20	A40	A50	A70	C10 - C30	C20	E01
							1.306.079	1.406.025R				

A10 CONDENSER	A20 CONTACT SET	A40 DISTRIBUTOR CAP	A50 ROTOR	A70 PICK-UP
C10 COIL	C20 IGNITION MODULE	C30 ELECTRONIC IGNITION KIT	E01 IGNITION CABLE SET	

Vehicle	alim.	kW	Date	Engine	FUNCTIONS ON THE VEHICLE							
					A10	A20	A40	A50	A70	C10 - C30	C20	E01
2.5 S												
ENGINE												
2.5 S					M 44.07							
Engine					Information							
All engines					version Bosch							
					A10	A20	A40	A50	A70	C10 - C30	C20	E01
							1.306.117	1.406.070R				
928												
ENGINE												
4.7 S					M 28.11, M 28.12							
Engine					Information							
All engines					version Bosch							
All engines					FOR: (CH), FOR: (AUS), version Bosch							
					A10	A20	A40	A50	A70	C10 - C30	C20	E01
							1.306.090					
							1.306.117	1.406.070R				
4.7 S												
ENGINE												
4.7 S					M 28.21, M 28.22							
Engine					Information							
All engines					Qty: 2, version Bosch							
					A10	A20	A40	A50	A70	C10 - C30	C20	E01
							1.306.128					
5.4 GTS												
ENGINE												
5.4 GTS					M 28.49, M 28.50							
Engine					Information							
All engines					Qty: 2, version Bosch							
All engines					Qty: 2							
					A10	A20	A40	A50	A70	C10 - C30	C20	E01
							1.306.128				1.965.034	
968												
ENGINE												
3.0					M 44.43, M 44.44							
Engine					Information							
All engines					version Bosch							
					A10	A20	A40	A50	A70	C10 - C30	C20	E01
							1.306.128					
CAYENNE												
ENGINE												
3.0 S Plug-in Hybrid Supercharged					Diesel/Electro 245 01/15-> MCG.EA, MCG.FA							
Engine					Information							
All engines					x 6, COIL ON PLUG							
					A10	A20	A40	A50	A70	C10 - C30	C20	E01
										1.970.427	C10	
CAYENNE I												
ENGINE												
3.2					M02.2Y							
Engine					Information							
All engines					x 6, COIL ON PLUG							
					A10	A20	A40	A50	A70	C10 - C30	C20	E01
										1.970.434	C10	
3.2												
ENGINE												
3.2					M02.2Y							
Engine					Information							
All engines					x 6, COIL ON PLUG							
					A10	A20	A40	A50	A70	C10 - C30	C20	E01
										1.970.434	C10	
3.6												
ENGINE												
3.6					M 55.01							
Engine					Information							
All engines					x 6, COIL ON PLUG							
					A10	A20	A40	A50	A70	C10 - C30	C20	E01
										1.970.434	C10	
CAYENNE II												
ENGINE												
3.0 S E-Hybrid					Petrol/Electric 306 10/14-> M 06.EC, MCG.EA, MCG.FA							
Engine					Information							
Eng. M 06.EC					Qty: 6							
Eng. MCG.EA, MCG.FA					x 6, COIL ON PLUG							
					A10	A20	A40	A50	A70	C10 - C30	C20	E01
										1.970.427	C10	
										1.970.427	C10	
3.6												
ENGINE												
3.6					M 55.02, MCE.YA							
Engine					Information							
All engines					x 6, COIL ON PLUG							
					A10	A20	A40	A50	A70	C10 - C30	C20	E01
										1.970.434	C10	
CAYENNE III												
ENGINE												
2.9 SAWD					Petrol 324 05/17-> DCAB, MDC.AB							
Engine					Information							
All engines					x 6, COIL ON PLUG							
					A10	A20	A40	A50	A70	C10 - C30	C20	E01
										1.970.636	C10	

A10 CONDENSER	A20 CONTACT SET	A40 DISTRIBUTOR CAP	A50 ROTOR	A70 PICK-UP
C10 COIL	C20 IGNITION MODULE	C30 ELECTRONIC IGNITION KIT	E01 IGNITION CABLE SET	

The present application list is a brief version. For the detailed information about the possibility of installation on a specific vehicle, please refer to our web-catalogue <http://catalogo.facet.eu/>

					FUNCTIONS ON THE VEHICLE							
Vehicle	alim.	kW	Date	Engine	A10	A20	A40	A50	A70	C10 - C30	C20	E01
3.0 AWD												
ENGINE												
DCBE, MDC.BE												
Engine		Information			A10	A20	A40	A50	A70	C10 - C30	C20	E01
All engines		x 6, COIL ON PLUG								1.970.636	C10	
3.0 E-Hybrid AWD												
ENGINE												
DCBE, MDC.BE												
Engine		Information			A10	A20	A40	A50	A70	C10 - C30	C20	E01
All engines		x 6, COIL ON PLUG								1.970.636	C10	
3.0 E-Hybrid AWD												
ENGINE												
DCBE, MDC.BE												
Engine		Information			A10	A20	A40	A50	A70	C10 - C30	C20	E01
All engines		x 6, COIL ON PLUG								1.970.636	C10	
3.0 E-Hybrid AWD												
ENGINE												
DCBE, MDC.BE												
Engine		Information			A10	A20	A40	A50	A70	C10 - C30	C20	E01
All engines		x 6, COIL ON PLUG								1.970.636	C10	
4.0 Turbo AWD												
ENGINE												
DCUA, MDC.UA												
Engine		Information			A10	A20	A40	A50	A70	C10 - C30	C20	E01
All engines		x 8, COIL ON PLUG								1.970.636	C10	
4.0 Turbo GT AWD												
ENGINE												
DWNA												
Engine		Information			A10	A20	A40	A50	A70	C10 - C30	C20	E01
All engines		x 8, version 9A7905110, COIL ON PLUG								1.970.636	C10	
4.0 Turbo S E-Hybrid AWD												
ENGINE												
DCUA												
Engine		Information			A10	A20	A40	A50	A70	C10 - C30	C20	E01
All engines		x 8, COIL ON PLUG								1.970.636	C10	
MACAN												
ENGINE												
MCN.CC, MCY.NA												
Engine		Information			A10	A20	A40	A50	A70	C10 - C30	C20	E01
Eng. MCN.CC		x 4, COIL ON PLUG								1.970.636	C10	
Eng. MCY.NA		Qty: 4								1.970.636	C10	
2.0												
ENGINE												
DKNA												
Engine		Information			A10	A20	A40	A50	A70	C10 - C30	C20	E01
All engines		x 4, COIL ON PLUG								1.970.636	C10	
2.0												
ENGINE												
DLHB, MCY.PA												
Engine		Information			A10	A20	A40	A50	A70	C10 - C30	C20	E01
All engines		x 4, COIL ON PLUG								1.970.636	C10	
2.9 Turbo AWD												
ENGINE												
DGRC												
Engine		Information			A10	A20	A40	A50	A70	C10 - C30	C20	E01
All engines		x 6, COIL ON PLUG								1.970.636	C10	
3.0 S												
ENGINE												
DLZB												
Engine		Information			A10	A20	A40	A50	A70	C10 - C30	C20	E01
All engines		x 6, COIL ON PLUG								1.970.636	C10	
PANAMERA												
ENGINE												
MDG.PA												
Engine		Information			A10	A20	A40	A50	A70	C10 - C30	C20	E01
All engines		x 6, COIL ON PLUG								1.970.636	C10	

A10 CONDENSER	A20 CONTACT SET	A40 DISTRIBUTOR CAP	A50 ROTOR	A70 PICK-UP
C10 COIL	C20 IGNITION MODULE	C30 ELECTRONIC IGNITION KIT	E01 IGNITION CABLE SET	

Vehicle	alim.	kW	Date	Engine	FUNCTIONS ON THE VEHICLE												
					A10	A20	A40	A50	A70	C10 - C30	C20	E01					
ENGINE																	
2.9 4 E-Hybrid	Petrol/ Electric	243	05/16->	DGPA, MDG.PA													
ENGINE																	
Engine Information					A10	A20	A40	A50	A70	C10 - C30	C20	E01					
All engines x 6, COIL ON PLUG										1.970.636	C10						
2.9 4 E-Hybrid	Petrol/ Electric	340	05/16->	DGPA, MDG.PA													
ENGINE																	
Engine Information					A10	A20	A40	A50	A70	C10 - C30	C20	E01					
All engines x 6, COIL ON PLUG										1.970.636	C10						
2.9 4S	Petrol	324	05/16->	MCS.ZA													
ENGINE																	
Engine Information					A10	A20	A40	A50	A70	C10 - C30	C20	E01					
All engines x 6, COIL ON PLUG										1.970.636	C10						
2.9 4S E-Hybrid	Petrol/ Electric	324	08/20->	CSZA													
ENGINE																	
Engine Information					A10	A20	A40	A50	A70	C10 - C30	C20	E01					
All engines x 6, COIL ON PLUG										1.970.636	C10						
2.9 4S E-Hybrid	Petrol/ Electric	412	08/20->	DGPA													
ENGINE																	
Engine Information					A10	A20	A40	A50	A70	C10 - C30	C20	E01					
All engines x 6, COIL ON PLUG										1.970.636	C10						
3.0	Petrol	243	05/16->	MCX.TA													
ENGINE																	
Engine Information					A10	A20	A40	A50	A70	C10 - C30	C20	E01					
All engines x 6, COIL ON PLUG										1.970.636	C10						
3.0 4	Petrol	243	05/16->	MCX.TA													
ENGINE																	
Engine Information					A10	A20	A40	A50	A70	C10 - C30	C20	E01					
All engines x 6, COIL ON PLUG										1.970.636	C10						
3.0 S E-Hybrid	Petrol/ Electric	245	03/11-07/13	MCG.EA, MCG.FA													
ENGINE																	
Engine Information					A10	A20	A40	A50	A70	C10 - C30	C20	E01					
All engines x 6, COIL ON PLUG										1.970.427	C10						
3.0 S E-Hybrid	Petrol/ Electric	279	03/11-07/13	MCG.EA, MCG.FA													
ENGINE																	
Engine Information					A10	A20	A40	A50	A70	C10 - C30	C20	E01					
All engines x 6, COIL ON PLUG										1.970.427	C10						
3.0 S E-Hybrid	Petrol/ Electric	306	07/13-10/16	MCG.EA, MCG.FA													
ENGINE																	
Engine Information					A10	A20	A40	A50	A70	C10 - C30	C20	E01					
All engines x 6, COIL ON PLUG										1.970.427	C10						
4.0 GTS	Petrol	338	01/18->	CVDD													
ENGINE																	
Engine Information					A10	A20	A40	A50	A70	C10 - C30	C20	E01					
All engines x 8, COIL ON PLUG										1.970.636	C10						
4.0 Turbo	Petrol	404	05/16->	MCV.DA													
ENGINE																	
Engine Information					A10	A20	A40	A50	A70	C10 - C30	C20	E01					
All engines x 8, COIL ON PLUG										1.970.636	C10						
4.0 Turbo S E-Hybrid	Petrol	515	05/20->	CVDA													
ENGINE																	
Engine Information					A10	A20	A40	A50	A70	C10 - C30	C20	E01					
All engines x 8, COIL ON PLUG										1.970.636	C10						
4.0 Turbo S E-Hybrid	Petrol/ Electric	404	05/17->	MCV.DA													
ENGINE																	
Engine Information					A10	A20	A40	A50	A70	C10 - C30	C20	E01					
All engines x 8, COIL ON PLUG										1.970.636	C10						
A10	CONDENSER			A20	CONTACT SET			A40	DISTRIBUTOR CAP			A50	ROTOR		A70	PICK-UP	
C10	COIL			C20	IGNITION MODULE			C30	ELECTRONIC IGNITION KIT			E01	IGNITION CABLE SET				

Vehicle	alim.	kW	Date	Engine	FUNCTIONS ON THE VEHICLE							
					A10	A20	A40	A50	A70	C10 - C30	C20	E01

ENGINE				
4.0 Turbo S E-Hybrid	Petrol/ Electric	500	05/17->	MCV.DA

Engine	Information	A10	A20	A40	A50	A70	C10 - C30	C20	E01
All engines	x 8, COIL ON PLUG						1.970.636	C10	

ENGINE				
4.0 Turbo S E-Hybrid	Petrol/ Electric	515	05/20->	CVDA

Engine	Information	A10	A20	A40	A50	A70	C10 - C30	C20	E01
All engines	x 8, COIL ON PLUG						1.970.636	C10	

A10	CONDENSER	A20	CONTACT SET	A40	DISTRIBUTOR CAP	A50	ROTOR	A70	PICK-UP
C10	COIL	C20	IGNITION MODULE	C30	ELECTRONIC IGNITION KIT	E01	IGNITION CABLE SET		

Vehicle	alim.	kW	Date	Engine	FUNCTIONS ON THE VEHICLE							
					A10	A20	A40	A50	A70	C10 - C30	C20	E01

G-MODELL

				ENGINE
230 GE	Petrol	92	03/79-07/00	M 102.981, M 102.987, M 102.996

Engine	Information	A10	A20	A40	A50	A70	C10 - C30	C20	E01
Eng. M 102.981, M 102.987	version Bosch			1.306.108					
Eng. M 102.996	version Bosch			1.306.234					
All engines	version Bosch				1.406.055R				
Eng. M 102.996							1.970.178	C10	
Eng. M 102.981, M 102.987							1.970.180	C10	1.501.654

				ENGINE
230 GE	Petrol	93	07/89-08/93	M 102.989

Engine	Information	A10	A20	A40	A50	A70	C10 - C30	C20	E01
All engines	version Bosch			1.306.234	1.406.121R				
All engines							1.970.178	C10	

				ENGINE
280 GE	Petrol	110	01/86-12/91	M 110.994

Engine	Information	A10	A20	A40	A50	A70	C10 - C30	C20	E01
All engines	version Bosch		1.206.034HVS						
All engines	->eng. 004203, 001498, version Bosch			1.306.092					
All engines	eng. type 004205, 001499 ->, version Bosch			1.306.123					
All engines	eng. type 002294, 000115 ->, ->eng. 004203, 001498, version Bosch				1.406.024R				
All engines	->eng. 002293, 000114, version Bosch				1.406.034R				
All engines	eng. type 004204, 001499 ->, version Bosch				1.406.060R				
All engines	ch. 034825, 901172 ->						1.970.180	C10	

				ENGINE
300 GE	Petrol	125	06/89-08/93	M 103.987

Engine	Information	A10	A20	A40	A50	A70	C10 - C30	C20	E01
All engines	version Bosch			1.306.237	1.406.125R				
All engines							1.970.178	C10	1.501.657

				ENGINE
G 320	Petrol	155	02/94-12/97	M 104.996

Engine	Information	A10	A20	A40	A50	A70	C10 - C30	C20	E01
All engines	Qty: 3, without spark plug connector						1.970.316	C10	
All engines	incl. spark plug connector, Qty: 3						1.970.316K	C10	

				ENGINE
G 36 AMG	Petrol	200	01/95-04/98	M 104.952 (AMG 3, 6)

Engine	Information	A10	A20	A40	A50	A70	C10 - C30	C20	E01
All engines	Qty: 3, without spark plug connector						1.970.316	C10	
All engines	incl. spark plug connector, Qty: 3						1.970.316K	C10	

				ENGINE
G 500	Petrol	218	12/97-11/00	M 113.962

Engine	Information	A10	A20	A40	A50	A70	C10 - C30	C20	E01
All engines	Qty: 8						1.970.417	C10	

				ENGINE
G 55 AMG	Petrol	260	04/99-03/01	M 113.982

Engine	Information	A10	A20	A40	A50	A70	C10 - C30	C20	E01
All engines	Qty: 8						1.970.417	C10	

A10 CONDENSER	A20 CONTACT SET	A40 DISTRIBUTOR CAP	A50 ROTOR	A70 PICK-UP
C10 COIL	C20 IGNITION MODULE	C30 ELECTRONIC IGNITION KIT	E01 IGNITION CABLE SET	

Vehicle	alim.	kW	Date	Engine	FUNCTIONS ON THE VEHICLE							
					 A10	 A20	 A40	 A50	 A70	 C10 - C30	 C20	 E01

REBEL

700	Petrol	23	01/68-08/71	ENGINE	--
-----	--------	----	-------------	--------	----

Engine	Information	A10	A20	A40	A50	A70	C10 - C30	C20	E01
All engines				1.328.075	1.428.006				

750	Petrol	24	08/71-12/73	ENGINE	--
-----	--------	----	-------------	--------	----

Engine	Information	A10	A20	A40	A50	A70	C10 - C30	C20	E01
All engines				1.328.075	1.428.006				

ROBIN

850	Petrol	29	11/73-10/02	ENGINE	--
-----	--------	----	-------------	--------	----

Engine	Information	A10	A20	A40	A50	A70	C10 - C30	C20	E01
All engines				1.328.075	1.428.006				

A10	CONDENSER	A20	CONTACT SET	A40	DISTRIBUTOR CAP	A50	ROTOR	A70	PICK-UP
C10	COIL	C20	IGNITION MODULE	C30	ELECTRONIC IGNITION KIT	E01	IGNITION CABLE SET		

Vehicle	alim.	kW	Date	Engine	FUNCTIONS ON THE VEHICLE							
					A10	A20	A40	A50	A70	C10 - C30	C20	E01

11

ENGINE				
1.1	Petrol	35	03/83-06/86	C1E 715, C1E 720

Engine	Information	A10	A20	A40	A50	A70	C10 - C30	C20	E01
All engines	version Ducellier		1.215.126	1.315.054	1.415.091				
All engines	version Marelli			1.330.101	1.430.047R		1.970.101D	C10	

ENGINE				
1.2	Petrol	40	10/84-12/88	C1G 700, C1G 710

Engine	Information	A10	A20	A40	A50	A70	C10 - C30	C20	E01
All engines	version Ducellier		1.215.126	1.315.059	1.415.094				
All engines	version Femsas		1.217.026		1.417.058				
All engines							1.970.101D	C10	1.500.839

ENGINE				
1.4	Petrol	43	07/86-10/87	C2J 720

Engine	Information	A10	A20	A40	A50	A70	C10 - C30	C20	E01
All engines	version Ducellier			1.315.059					
All engines	version Femsas			1.317.023	1.417.058				
All engines	distr. num. 525 352 A/B, version Ducellier				1.415.088				
All engines	distr. num. 525 352 C/D, version Ducellier				1.415.094				
All engines									1.500.839

ENGINE				
1.4	Petrol	49	03/83-12/88	C2J 720, C2J 766, C2J 767, C2J 768

Engine	Information	A10	A20	A40	A50	A70	C10 - C30	C20	E01
All engines	version Ducellier			1.315.059					
All engines	version Femsas			1.317.023	1.417.058				
All engines	distr. num. 525 352 A/B, version Ducellier				1.415.088				
All engines	distr. num. 525 352 C/D, version Ducellier				1.415.094				
All engines									1.500.839

ENGINE				
1.7	Petrol	54	10/86-12/88	F2N 730

Engine	Information	A10	A20	A40	A50	A70	C10 - C30	C20	E01
All engines				1.315.062					

ENGINE				
1.7	Petrol	55	10/84-12/88	F3N 718

Engine	Information	A10	A20	A40	A50	A70	C10 - C30	C20	E01
All engines				1.315.062					

ENGINE				
1.7	Petrol	59	10/83-12/87	F2N 700, F2N 704

Engine	Information	A10	A20	A40	A50	A70	C10 - C30	C20	E01
Eng. F2N 700	version Femsas		1.217.026	1.317.023	1.417.058				
Eng. F2N 700	version Marelli		1.230.148M		1.430.047R				
All engines				1.315.062					
Eng. F2N 700	version Ducellier			1.315.063	1.415.097				
Eng. F2N 700	Kit, version Ducellier			1.315.073					

ENGINE				
1.7	Petrol	64	06/87-12/88	F2N 732, F2N 742

Engine	Information	A10	A20	A40	A50	A70	C10 - C30	C20	E01
All engines				1.315.062					

ENGINE				
1.7	Petrol	65	10/86-12/88	F2N 708, F2N 710, F2N 798

Engine	Information	A10	A20	A40	A50	A70	C10 - C30	C20	E01
All engines				1.315.062					









12

ENGINE				
1.3	Petrol	37	07/75-04/80	810.02

Engine	Information	A10	A20	A40	A50	A70	C10 - C30	C20	E01
All engines			1.206.040		1.406.014R				

A10	CONDENSER	A20	CONTACT SET	A40	DISTRIBUTOR CAP	A50	ROTOR	A70	PICK-UP
C10	COIL	C20	IGNITION MODULE	C30	ELECTRONIC IGNITION KIT	E01	IGNITION CABLE SET		

The present application list is a brief version. For the detailed information about the possibility of installation on a specific vehicle, please refer to our web-catalogue <http://catalogo.facet.eu/>







					FUNCTIONS ON THE VEHICLE							
Vehicle	alim.	kW	Date	Engine								
ENGINE												
1.3	Petrol	40	10/69-08/80	810-02/97								
ENGINE												
Engine	Information				A10	A20	A40	A50	A70	C10 - C30	C20	E01
All engines						1.206.040		1.406.014R				
ENGINE												
1.3	Petrol	44	08/73-08/80	810.05, 810.06								
ENGINE												
Engine	Information				A10	A20	A40	A50	A70	C10 - C30	C20	E01
All engines						1.206.040						
ENGINE												
1.3 TS	Petrol	44	08/72-08/80	810.05, 810.06								
ENGINE												
Engine	Information				A10	A20	A40	A50	A70	C10 - C30	C20	E01
All engines						1.206.040						
ENGINE												
14												
ENGINE												
1.4	Petrol	52	09/79-06/83	150								
ENGINE												
Engine	Information				A10	A20	A40	A50	A70	C10 - C30	C20	E01
All engines	version Ducellier				1.115.034			1.415.088				
All engines	version Marelli						1.330.098	1.430.047R				
ENGINE												
18												
ENGINE												
1.4	Petrol	47	04/78-07/86	847 720, 847 722								
ENGINE												
Engine	Information				A10	A20	A40	A50	A70	C10 - C30	C20	E01
All engines						1.206.040						
All engines	version Ducellier						1.315.059					
All engines	version Femsas						1.317.023	1.417.058				
All engines	distr. num. 525 352 A/B, version Ducellier							1.415.088				
All engines	distr. num. 525 352 C/D, version Ducellier							1.415.094				
All engines	01/01/85 ->								1.970.107	C10		
ENGINE												
1.6 TS	Petrol	71	05/82-07/86	A6M 725, A6M 726								
ENGINE												
Engine	Information				A10	A20	A40	A50	A70	C10 - C30	C20	E01
All engines	version Ducellier						1.315.059					
All engines	distr. num. 525 352 A/B, version Ducellier							1.415.088				
All engines	distr. num. 525 352 C/D, version Ducellier							1.415.094				
All engines	01/01/85 ->								1.970.107	C10		
ENGINE												
2.0	Petrol	77	05/82-07/86	J6R 716								
ENGINE												
Engine	Information				A10	A20	A40	A50	A70	C10 - C30	C20	E01
All engines	-air conditioning, version Ducellier						1.315.059					
All engines	+air conditioning, version Ducellier						1.315.079					
All engines	version Ducellier							1.415.094				
All engines	01/01/85 ->								1.970.107	C10		
ENGINE												
19 I												
ENGINE												
1.2	Petrol	40	01/88-12/92	C1G 730								
ENGINE												
Engine	Information				A10	A20	A40	A50	A70	C10 - C30	C20	E01
All engines	version Ducellier						1.315.059					
All engines	version Femsas						1.317.023	1.417.058				
All engines	distr. num. 525 352 A/B, version Ducellier							1.415.088				
All engines	distr. num. 525 352 C/D, version Ducellier							1.415.094				
All engines									1.970.107	C10		1.500.543
ENGINE												
1.2i	Petrol	0	01/89-12/92	E7F								
ENGINE												
Engine	Information				A10	A20	A40	A50	A70	C10 - C30	C20	E01
All engines	version Ducellier						1.315.081	1.415.101				
All engines	version Marelli						1.330.111	1.430.059				
All engines									1.970.107	C10		1.500.801
ENGINE												
1.4	Petrol	43	07/88-05/93	C2J 772, C3J 710								
ENGINE												
Engine	Information				A10	A20	A40	A50	A70	C10 - C30	C20	E01
All engines	version Ducellier						1.315.059					
All engines	version Femsas						1.317.023	1.417.058				

A10 CONDENSER	A20 CONTACT SET	A40 DISTRIBUTOR CAP	A50 ROTOR	A70 PICK-UP
C10 COIL	C20 IGNITION MODULE	C30 ELECTRONIC IGNITION KIT	E01 IGNITION CABLE SET	

Vehicle	alim.	kW	Date	Engine	FUNCTIONS ON THE VEHICLE								
					A10	A20	A40	A50	A70	C10 - C30	C20	E01	
1.4	Petrol	43	07/88-05/93	ENGINE C2J 772, C3J 710									
Engine	Information			A10	A20	A40	A50	A70	C10 - C30	C20	E01		
All engines	distr. num. 525 352 A/B, version Ducellier						1.415.088						
All engines	distr. num. 525 352 C/D, version Ducellier						1.415.094						
All engines									1.970.107	C10			
1.4	Petrol	50	09/88-09/92	ENGINE C2J 776									
Engine	Information			A10	A20	A40	A50	A70	C10 - C30	C20	E01		
All engines	version Ducellier					1.315.059							
All engines	version Femsas					1.317.023	1.417.058						
All engines	distr. num. 525 352 A/B, version Ducellier						1.415.088						
All engines	distr. num. 525 352 C/D, version Ducellier						1.415.094						
All engines									1.970.107	C10			
1.4	Petrol	55	09/90-04/92	ENGINE E7J 700									
Engine	Information			A10	A20	A40	A50	A70	C10 - C30	C20	E01		
All engines	version Ducellier					1.315.081	1.415.101						
All engines	version Marelli					1.330.111	1.430.059						
All engines									1.970.107	C10		1.500.801	
1.4	Petrol	57	07/88-08/90	ENGINE E6J 700, E6J 701									
Engine	Information			A10	A20	A40	A50	A70	C10 - C30	C20	E01		
All engines	version Ducellier					1.315.081	1.415.101						
All engines	version Marelli					1.330.111	1.430.059						
All engines									1.970.107	C10		1.500.801	
1.4	Petrol	58	06/89-08/90	ENGINE E6J 700									
Engine	Information			A10	A20	A40	A50	A70	C10 - C30	C20	E01		
All engines	version Ducellier					1.315.081	1.415.101						
All engines	version Marelli					1.330.111	1.430.059						
All engines									1.970.107	C10		1.500.801	
1.4	Petrol	59	01/88-12/92	ENGINE E6J 700, E6J 701									
Engine	Information			A10	A20	A40	A50	A70	C10 - C30	C20	E01		
All engines	version Ducellier					1.315.081	1.415.101						
All engines	version Marelli					1.330.111	1.430.059						
All engines									1.970.107	C10		1.500.801	
1.4 Cat	Petrol	43	01/89-04/92	ENGINE C3J 710									
Engine	Information			A10	A20	A40	A50	A70	C10 - C30	C20	E01		
All engines	version Ducellier					1.315.059							
All engines	version Femsas					1.317.023	1.417.058						
All engines	distr. num. 525 352 A/B, version Ducellier						1.415.088						
All engines	distr. num. 525 352 C/D, version Ducellier						1.415.094						
All engines									1.970.107	C10			
1.7	Petrol	54	09/88-04/92	ENGINE F3N 740, F3N 741									
Engine	Information			A10	A20	A40	A50	A70	C10 - C30	C20	E01		
All engines	version Ducellier					1.315.069	1.415.097						
All engines	Kit, version Ducellier					1.315.072							
All engines									1.970.107	C10			
1.7	Petrol	55	09/88-12/92	ENGINE F2N 724									
Engine	Information			A10	A20	A40	A50	A70	C10 - C30	C20	E01		
All engines	version Ducellier					1.315.069	1.415.097						
All engines	Kit, version Ducellier					1.315.072							
All engines									1.970.107	C10			

A10	CONDENSER	A20	CONTACT SET	A40	DISTRIBUTOR CAP	A50	ROTOR	A70	PICK-UP
C10	COIL	C20	IGNITION MODULE	C30	ELECTRONIC IGNITION KIT	E01	IGNITION CABLE SET		

The present application list is a brief version. For the detailed information about the possibility of installation on a specific vehicle, please refer to our web-catalogue <http://catalogo.facet.eu/>

				FUNCTIONS ON THE VEHICLE								
Vehicle	alim.	kW	Date	Engine	 A10	 A20	 A40	 A50	 A70	 C10 - C30	 C20	 E01
				ENGINE								
1.7	Petrol	66	07/88-04/92	F2N 722, F3N 742, F3N 743								
				ENGINE								
1.7	Petrol	68	09/88-12/92	F2N 720, F2N 721								
				ENGINE								
1.7	Petrol	69	09/90-04/92	F2N 721								
				ENGINE								
1.7	Petrol	70	07/91-04/92	F3N 742, F3N 743								
				ENGINE								
1.7	Petrol	79	08/88-12/92	F3N 746								
				ENGINE								
1.8 16V	Petrol	101	06/89-04/92	F7P 700, F7P 704								
				ENGINE								
1.8 16V	Petrol	103	06/89-09/92	F7P 700								
				ENGINE								
1.8 16V	Petrol	99	06/89-04/92	F7P 704								
				ENGINE								
				ENGINE								
1.2	Petrol	44	05/92-09/94	E7F 730								
				ENGINE								
1.4	Petrol	43	04/92-12/95	C3J 710								
				ENGINE								

A10 CONDENSER	A20 CONTACT SET	A40 DISTRIBUTOR CAP	A50 ROTOR	A70 PICK-UP
C10 COIL	C20 IGNITION MODULE	C30 ELECTRONIC IGNITION KIT	E01 IGNITION CABLE SET	

Vehicle	alim.	kW	Date	Engine	FUNCTIONS ON THE VEHICLE									
					A10	A20	A40	A50	A70	C10 - C30	C20	E01		
1.4	Petrol	44	05/92-09/94	ENGINE C3J 710										
				Engine	Information	A10	A20	A40	A50	A70	C10 - C30	C20	E01	
				All engines	version Ducellier			1.315.059						
				All engines	version Femsa			1.317.023	1.417.058					
				All engines	distr. num. 525 352 A/B, version Ducellier				1.415.088					
				All engines	distr. num. 525 352 C/D, version Ducellier				1.415.094					
				All engines							1.970.107	C10		
1.4	Petrol	55	01/92-12/95	ENGINE E7J 707, E7J 742, E7J 745										
				Engine	Information	A10	A20	A40	A50	A70	C10 - C30	C20	E01	
				All engines	version Ducellier			1.315.081	1.415.101					
				All engines	version Marelli			1.330.111	1.430.059					
				Eng. E7J 742, E7J 745							1.970.107	C10		
				All engines									1.500.801	
1.4	Petrol	58	05/92-12/95	ENGINE E6J 706										
				Engine	Information	A10	A20	A40	A50	A70	C10 - C30	C20	E01	
				All engines	version Ducellier			1.315.081	1.415.101					
				All engines	version Marelli			1.330.111	1.430.059					
				All engines							1.970.107	C10	1.500.801	
1.4	Petrol	59	01/92-12/95	ENGINE E7J 706										
				Engine	Information	A10	A20	A40	A50	A70	C10 - C30	C20	E01	
				All engines	version Ducellier			1.315.081	1.415.101					
				All engines	version Marelli			1.330.111	1.430.059					
				All engines							1.970.107	C10	1.500.801	
1.7	Petrol	54	04/92-12/95	ENGINE F3N 740, F3N 741										
				Engine	Information	A10	A20	A40	A50	A70	C10 - C30	C20	E01	
				All engines	version Ducellier			1.315.069	1.415.097					
				All engines	Kit, version Ducellier			1.315.072						
				All engines							1.970.107	C10		
1.7	Petrol	55	05/92-11/95	ENGINE F3N 740, F3N 741										
				Engine	Information	A10	A20	A40	A50	A70	C10 - C30	C20	E01	
				All engines	version Ducellier			1.315.069	1.415.097					
				All engines	Kit, version Ducellier			1.315.072						
				All engines							1.970.107	C10		
1.7	Petrol	66	04/92-12/95	ENGINE F3N 742, F3N 743										
				Engine	Information	A10	A20	A40	A50	A70	C10 - C30	C20	E01	
				All engines	version Ducellier			1.315.069	1.415.097					
				All engines	Kit, version Ducellier			1.315.072						
				All engines							1.970.107	C10		
				Eng. F3N 743									1.500.415	
1.7	Petrol	68	09/90-12/95	ENGINE F2N 720, F2N 721, F2N 726, F2N 727										
				Engine	Information	A10	A20	A40	A50	A70	C10 - C30	C20	E01	
				All engines	version Ducellier			1.315.069	1.415.097					
				All engines	Kit, version Ducellier			1.315.072						
				All engines							1.970.107	C10		
1.7	Petrol	79	05/92-09/94	ENGINE F3N 746										
				Engine	Information	A10	A20	A40	A50	A70	C10 - C30	C20	E01	
				All engines	version Ducellier			1.315.069	1.415.097					
				All engines	Kit, version Ducellier			1.315.072						
				All engines							1.970.107	C10	1.500.415	









A10	CONDENSER	A20	CONTACT SET	A40	DISTRIBUTOR CAP	A50	ROTOR	A70	PICK-UP
C10	COIL	C20	IGNITION MODULE	C30	ELECTRONIC IGNITION KIT	E01	IGNITION CABLE SET		

The present application list is a brief version. For the detailed information about the possibility of installation on a specific vehicle, please refer to our web-catalogue <http://catalogo.facet.eu/>

					FUNCTIONS ON THE VEHICLE							
Vehicle	alim.	kW	Date	Engine								
ENGINE												
1.8	Petrol	65	04/92-06/96	8NA20S, F3P 704, F3P 705, F3P 706, F3P 707, F3P 708			1.315.069	1.415.097		1.970.107	C10	
ENGINE												
1.8	Petrol	66	04/92-06/96	8NA20S, F3P 706			1.315.069	1.415.097		1.970.107	C10	
ENGINE												
1.8	Petrol	67	05/92-09/94	F3P 765			1.315.069	1.415.097				
ENGINE												
1.8	Petrol	79	05/92-06/96	5F 140 FE, F3P 682, F3P 764, F3P 765			1.315.069	1.415.097				
ENGINE												
1.8	Petrol	81	04/92-05/94	5F 140 FE			1.315.069	1.415.097				
ENGINE												
1.8 16V	Petrol	101	05/92-04/94	F7P 704			1.315.081	1.415.101		1.970.107	C10	1.500.802
ENGINE												
1.8 16V	Petrol	99	04/92-06/96	F7P 704			1.315.081	1.415.101		1.970.107	C10	1.500.802
ENGINE												
2.0	Petrol	76	10/80-12/83	829 702, 829 703	1.115.023	1.215.086	1.315.054	1.415.091		1.970.101D	C10	
ENGINE												
2.0	Petrol	80	10/77-10/80	829 700, 829 701, 829.01	1.115.023	1.215.086	1.315.054	1.415.091		1.970.101D	C10	
ENGINE												
21	Petrol	0	06/90-12/91	C2L 717			1.315.059	1.415.088		1.970.107	C10	

A10 CONDENSER	A20 CONTACT SET	A40 DISTRIBUTOR CAP	A50 ROTOR	A70 PICK-UP
C10 COIL	C20 IGNITION MODULE	C30 ELECTRONIC IGNITION KIT	E01 IGNITION CABLE SET	

Vehicle	alim.	kW	Date	Engine	FUNCTIONS ON THE VEHICLE									
					A10	A20	A40	A50	A70	C10 - C30	C20	E01		
1.4	Petrol	51	06/88-12/95	ENGINE C2J 770, C2L 714										
Engine	Information			A10	A20	A40	A50	A70	C10 - C30	C20	E01			
Eng. C2J 770	version Ducellier					1.315.059	1.415.088							
Eng. C2L 714	version Ducellier					1.315.091								
All engines									1.970.107	C10				
1.7	Petrol	54	06/86-12/95	ENGINE F2N 750, F2N 758, F2N 786, F3N 726										
Engine	Information			A10	A20	A40	A50	A70	C10 - C30	C20	E01			
All engines	version Ducellier					1.315.069	1.415.097							
All engines	Kit, version Ducellier					1.315.072								
All engines									1.970.107	C10				
1.7	Petrol	55	03/86-05/93	ENGINE F2N 712, F3N 726										
Engine	Information			A10	A20	A40	A50	A70	C10 - C30	C20	E01			
All engines	version Ducellier					1.315.069	1.415.097							
All engines	Kit, version Ducellier					1.315.072								
All engines									1.970.107	C10				
1.7	Petrol	64	06/87-04/89	ENGINE F2N 752										
Engine	Information			A10	A20	A40	A50	A70	C10 - C30	C20	E01			
All engines	version Ducellier					1.315.069	1.415.097							
All engines	Kit, version Ducellier					1.315.072								
All engines									1.970.107	C10				
1.7	Petrol	65	03/86-04/95	ENGINE F2N 710, F2N 711, F2N 754										
Engine	Information			A10	A20	A40	A50	A70	C10 - C30	C20	E01			
All engines	version Ducellier					1.315.069	1.415.097							
All engines	Kit, version Ducellier					1.315.072								
All engines									1.970.107	C10				
1.7	Petrol	66	09/89-06/94	ENGINE F3N 722, F3N 723										
Engine	Information			A10	A20	A40	A50	A70	C10 - C30	C20	E01			
All engines	version Ducellier					1.315.069	1.415.097							
All engines	Kit, version Ducellier					1.315.072								
All engines									1.970.107	C10				
1.7	Petrol	69	03/86-02/94	ENGINE F2N 722, F3N 722, F3N 723										
Engine	Information			A10	A20	A40	A50	A70	C10 - C30	C20	E01			
All engines	version Ducellier					1.315.069	1.415.097							
All engines	Kit, version Ducellier					1.315.072								
All engines									1.970.107	C10				
1.7	Petrol	70	04/86-06/89	ENGINE F3N 722, F3N 723										
Engine	Information			A10	A20	A40	A50	A70	C10 - C30	C20	E01			
All engines	version Ducellier					1.315.069	1.415.097							
All engines	Kit, version Ducellier					1.315.072								
All engines									1.970.107	C10				
1.7 Cat	Petrol	54	05/88-06/93	ENGINE F3N 726										
Engine	Information			A10	A20	A40	A50	A70	C10 - C30	C20	E01			
All engines	version Ducellier					1.315.069	1.415.097							
All engines	Kit, version Ducellier					1.315.072								
All engines									1.970.107	C10				
2.0	Petrol	66	09/89-12/91	ENGINE F2R 702										
Engine	Information			A10	A20	A40	A50	A70	C10 - C30	C20	E01			
All engines	version Ducellier					1.315.069	1.415.097							
All engines	Kit, version Ducellier					1.315.072								
All engines									1.970.107	C10				
A10	CONDENSER		A20	CONTACT SET		A40	DISTRIBUTOR CAP		A50	ROTOR		A70	PICK-UP	
C10	COIL		C20	IGNITION MODULE		C30	ELECTRONIC IGNITION KIT		E01	IGNITION CABLE SET				



				FUNCTIONS ON THE VEHICLE								
Vehicle	alim.	kW	Date	Engine	 A10	 A20	 A40	 A50	 A70	 C10 - C30	 C20	 E01
				ENGINE								
2.0	Petrol	75	03/86-10/93	8CPD, J6R 758, J6R 759, J6R 793			1.315.065					
ENGINE					A10	A20	A40	A50	A70	C10 - C30	C20	E01
All engines							1.315.065					
Eng. J6R 758, J6R 793							1.315.066					
Eng. J6R 758, J6R 793										1.970.107	C10	1.500.539
				ENGINE								
2.0	Petrol	76	04/88-06/89	8CPD, J6R 793			1.315.065					
ENGINE					A10	A20	A40	A50	A70	C10 - C30	C20	E01
All engines							1.315.065					
Eng. J6R 793							1.315.066					
Eng. J6R 793										1.970.107	C10	1.500.539
				ENGINE								
2.0	Petrol	78	05/91-10/93	J6R 758			1.315.065			1.970.107	C10	1.500.539
ENGINE					A10	A20	A40	A50	A70	C10 - C30	C20	E01
All engines							1.315.065			1.970.107	C10	1.500.539
All engines							1.315.066					
All engines												
				ENGINE								
2.0	Petrol	85	03/86-12/88	J7R 750, J7R 751			1.315.065			1.970.107	C10	1.500.539
ENGINE					A10	A20	A40	A50	A70	C10 - C30	C20	E01
All engines							1.315.065			1.970.107	C10	1.500.539
All engines							1.315.066					
All engines												
				ENGINE								
2.0	Petrol	86	04/86-06/92	J7R 750, J7R 751			1.315.065			1.970.107	C10	1.500.539
ENGINE					A10	A20	A40	A50	A70	C10 - C30	C20	E01
All engines							1.315.065			1.970.107	C10	1.500.539
All engines							1.315.066					
All engines												
				ENGINE								
2.0	Petrol	88	03/86-12/93	14ZR, J7R 747			1.315.065			1.970.107	C10	1.500.539
ENGINE					A10	A20	A40	A50	A70	C10 - C30	C20	E01
All engines							1.315.065			1.970.107	C10	1.500.539
All engines							1.315.066					
All engines												
				ENGINE								
2.0	Petrol	99	02/90-06/94	J7R 740			1.315.082	1.415.101				
ENGINE					A10	A20	A40	A50	A70	C10 - C30	C20	E01
All engines							1.315.082	1.415.101				
All engines							1.315.083					
All engines										1.970.107	C10	
				ENGINE								
2.0 4x4	Petrol	88	03/89-12/93	14ZR, J7R 747			1.315.066			1.970.107	C10	1.500.539
ENGINE					A10	A20	A40	A50	A70	C10 - C30	C20	E01
All engines							1.315.066			1.970.107	C10	1.500.539
All engines												
				ENGINE								
2.0 4x4	Petrol	99	12/89-02/94	J7R 740			1.315.082	1.415.101				
ENGINE					A10	A20	A40	A50	A70	C10 - C30	C20	E01
All engines							1.315.082	1.415.101				
All engines							1.315.083					
All engines										1.970.107	C10	
				ENGINE								
2.0 Turbo	Petrol	119	02/90-10/92	J7R 756			1.315.082	1.415.101				
ENGINE					A10	A20	A40	A50	A70	C10 - C30	C20	E01
All engines							1.315.082	1.415.101				
All engines							1.315.083					
All engines										1.970.107	C10	
All engines										1.970.275	C10	
All engines										1.970.276	C10	
				ENGINE								
2.0 Turbo	Petrol	129	04/87-03/90	J7R 752			1.315.082	1.415.101				
ENGINE					A10	A20	A40	A50	A70	C10 - C30	C20	E01
All engines							1.315.082	1.415.101				

A10 CONDENSER	A20 CONTACT SET	A40 DISTRIBUTOR CAP	A50 ROTOR	A70 PICK-UP
C10 COIL	C20 IGNITION MODULE	C30 ELECTRONIC IGNITION KIT	E01 IGNITION CABLE SET	

Vehicle	alim.	kW	Date	Engine	FUNCTIONS ON THE VEHICLE							
					A10	A20	A40	A50	A70	C10 - C30	C20	E01
ENGINE												
2.0 Turbo	Petrol	129	04/87-03/90	J7R 752								
Engine	Information			A10	A20	A40	A50	A70	C10 - C30	C20	E01	
All engines	Kit, version Ducellier					1.315.083						
All engines									1.970.107	C10		
All engines	->eng. F140627										1.500.539	
ENGINE												
2.0 Turbo 4x4	Petrol	119	02/90-10/92	J7R 756								
Engine	Information			A10	A20	A40	A50	A70	C10 - C30	C20	E01	
All engines	version Ducellier					1.315.082	1.415.101					
All engines	Kit, version Ducellier					1.315.083						
All engines	->year 30/06/91								1.970.107	C10		
All engines	01/07/91 ->, info A-K								1.970.275	C10		
All engines	01/07/91 ->, info B-K								1.970.276	C10		
ENGINE												
2.0 Turbo 4x4	Petrol	129	08/89-10/93	J7R 752								
Engine	Information			A10	A20	A40	A50	A70	C10 - C30	C20	E01	
All engines	version Ducellier					1.315.082	1.415.101					
All engines	Kit, version Ducellier					1.315.083						
All engines									1.970.107	C10		
All engines	->eng. F140627										1.500.539	
ENGINE												
2.0 Txi	Petrol	100	07/89-05/93	1SCRMP10U1, J7R 740								
Engine	Information			A10	A20	A40	A50	A70	C10 - C30	C20	E01	
All engines	version Ducellier					1.315.082	1.415.101					
All engines	Kit, version Ducellier					1.315.083						
All engines									1.970.107	C10		
ENGINE												
2.2	Petrol	79	06/86-12/95	J7T 754, J7T 755, J7T 756								
Engine	Information			A10	A20	A40	A50	A70	C10 - C30	C20	E01	
Eng. J7T 754, J7T 755						1.315.065						
All engines	version Ducellier					1.315.066						
All engines									1.970.107	C10	1.500.539	
ENGINE												
2.2	Petrol	81	04/86-05/93	J7T 755								
Engine	Information			A10	A20	A40	A50	A70	C10 - C30	C20	E01	
All engines						1.315.065			1.970.107	C10	1.500.539	
All engines	version Ducellier					1.315.066						
ENGINE												
2.2	Petrol	85	03/86-12/95	J6T 790, J6T 791								
Engine	Information			A10	A20	A40	A50	A70	C10 - C30	C20	E01	
All engines	version Ducellier					1.315.066						
All engines									1.970.107	C10	1.500.539	
ENGINE												
2.2 4x4	Petrol	79	06/86-06/94	J7T 754, J7T 755								
Engine	Information			A10	A20	A40	A50	A70	C10 - C30	C20	E01	
All engines						1.315.065			1.970.107	C10	1.500.539	
All engines	version Ducellier					1.315.066						
25												
ENGINE												
2.0	Petrol	74	04/84-12/92	08A, J6R 706, J6R 707, J6R 763								
Engine	Information			A10	A20	A40	A50	A70	C10 - C30	C20	E01	
Eng. J6R 706, J6R 707	version Ducellier					1.315.059	1.415.094					
Eng. 08A, J6R 763	version Ducellier					1.315.091						
All engines									1.970.107	C10		
ENGINE												
2.0	Petrol	88	03/87-12/93	J7R 722, J7R 723								
Engine	Information			A10	A20	A40	A50	A70	C10 - C30	C20	E01	
All engines	version Ducellier					1.315.091						
All engines									1.970.107	C10	1.500.539	

A10 CONDENSER	A20 CONTACT SET	A40 DISTRIBUTOR CAP	A50 ROTOR	A70 PICK-UP
C10 COIL	C20 IGNITION MODULE	C30 ELECTRONIC IGNITION KIT	E01 IGNITION CABLE SET	

The present application list is a brief version. For the detailed information about the possibility of installation on a specific vehicle, please refer to our web-catalogue <http://catalogo.facet.eu/>

					FUNCTIONS ON THE VEHICLE							
Vehicle	alim.	kW	Date	Engine	 A10	 A20	 A40	 A50	 A70	 C10 - C30	 C20	 E01
ENGINE												
2.0 12V	Petrol	103	06/88-12/93	7CYQD80D-E3, J7R 721								
Engine	Information											
All engines	01/07/88 ->, version Ducellier					1.315.081	1.415.101					
All engines	01/07/88 ->, Kit, version Ducellier					1.315.083						
All engines	->year 30/06/88, version Ducellier					1.315.091	1.415.094					
All engines									1.970.107	C10		
All engines	->year 30/06/88											1.500.539
ENGINE												
2.0 12V	Petrol	99	06/89-12/92	74AR-FXE								
Engine	Information											
All engines	01/07/88 ->, version Ducellier					1.315.081	1.415.101					
All engines	01/07/88 ->, Kit, version Ducellier					1.315.083						
All engines	->year 30/06/88, version Ducellier					1.315.091	1.415.094					
All engines									1.970.107	C10		
All engines												1.500.539
ENGINE												
2.2	Petrol	76	11/85-03/89	J7T 708, J7T 732								
Engine	Information											
All engines	version Ducellier					1.315.091						
All engines									1.970.107	C10		1.500.539
ENGINE												
2.2	Petrol	79	09/86-12/92	04TNV88-C, J7T 708, J7T 732								
Engine	Information											
All engines	version Ducellier					1.315.091						
All engines									1.970.107	C10		1.500.539
ENGINE												
2.2	Petrol	89	04/84-12/89	74G69-S4M, J7T 706, J7T 707, J7T 715								
Engine	Information											
Eng. J7T 706, J7T 707	version Ducellier					1.315.059	1.415.094					
Eng. 74G69-S4M, J7T 715	version Ducellier					1.315.091						
All engines									1.970.107	C10		1.500.539
ENGINE												
2.2	Petrol	91	04/84-12/89	J7T 730, J7T 731								
Engine	Information											
All engines	version Ducellier					1.315.091						
All engines									1.970.107	C10		1.500.539
ENGINE												
2.4 V6 Turbo	Petrol	133	10/84-05/90	Z7U 702								
Engine	Information											
All engines	version Bosch					1.306.236	1.406.119R					
All engines									1.970.107	C10		
ENGINE												
2.5 V6 Turbo	Petrol	151	01/90-12/92	Z7U 700								
Engine	Information											
All engines	version Bosch					1.306.236	1.406.119R					
All engines									1.970.107	C10		
ENGINE												
2.7 V6 Injection	Petrol	104	04/84-08/89	Z7V 708, Z7V 709, Z7V 711								
Engine	Information											
All engines	version Bosch						1.406.023R					
ENGINE												
2.8 V6	Petrol	115	06/87-02/90	Z7W 700, Z7W 701								
Engine	Information											
All engines	version Bosch					1.306.236	1.406.119R					
All engines									1.970.107	C10		
ENGINE												
2.8 V6 Injection	Petrol	100	06/86-02/88	Z7W 702								
Engine	Information											
All engines	version Bosch						1.406.023R					

A10 CONDENSER	A20 CONTACT SET	A40 DISTRIBUTOR CAP	A50 ROTOR	A70 PICK-UP
C10 COIL	C20 IGNITION MODULE	C30 ELECTRONIC IGNITION KIT	E01 IGNITION CABLE SET	

Vehicle	alim.	kW	Date	Engine	FUNCTIONS ON THE VEHICLE							
					A10	A20	A40	A50	A70	C10 - C30	C20	E01
ENGINE												
2.8 V6 Injection	Petrol	110	06/87-12/92	Z7W 706, Z7W 707, Z7W 709								
Engine	Information			A10	A20	A40	A50	A70	C10 - C30	C20	E01	
All engines	version Bosch					1.306.236	1.406.119R					
All engines								1.970.107	C10			
4												
0.8	Petrol	19	10/62-09/83	800, 800 705								
Engine	Information			A10	A20	A40	A50	A70	C10 - C30	C20	E01	
All engines	version DUCCELLIER					1.315.041						
ENGINE												
0.8	Petrol	21	10/83-10/88	800 705								
Engine	Information			A10	A20	A40	A50	A70	C10 - C30	C20	E01	
All engines	version Ducellier			1.115.023	1.215.055	1.315.054	1.415.091					
All engines	version Sev			1.142.056	1.242.054	1.342.043						
ENGINE												
0.8	Petrol	25	09/71-12/88	800 01								
Engine	Information			A10	A20	A40	A50	A70	C10 - C30	C20	E01	
All engines	version Ducellier			1.115.023	1.215.061							
All engines	version Femsas			1.117.097	1.217.024	1.317.023	1.417.058					
All engines							1.415.081		1.970.101D	C10		
ENGINE												
1.1	Petrol	25	06/78-06/90	688 712, C1E 714, C1E 719								
Engine	Information			A10	A20	A40	A50	A70	C10 - C30	C20	E01	
All engines					1.206.040							
Eng. 688 712	version Femsas				1.217.026	1.317.023	1.417.058					
Eng. 688 712	version Marelli					1.330.101	1.430.047R					
ENGINE												
1.1	Petrol	33	02/78-03/84	688 712								
Engine	Information			A10	A20	A40	A50	A70	C10 - C30	C20	E01	
All engines	version Femsas				1.217.026	1.317.023	1.417.058					
All engines	version Marelli					1.330.101	1.430.047R					
5												
1.0	Petrol	32	01/72-12/85	689 710								
Engine	Information			A10	A20	A40	A50	A70	C10 - C30	C20	E01	
All engines					1.206.040							
ENGINE												
1.3	Petrol	31	09/76-09/79	810 726								
Engine	Information			A10	A20	A40	A50	A70	C10 - C30	C20	E01	
All engines	version Ducellier			1.115.023	1.215.086		1.415.091					
All engines					1.206.040				1.970.101D	C10		
ENGINE												
1.3	Petrol	33	06/79-09/84	810 719								
Engine	Information			A10	A20	A40	A50	A70	C10 - C30	C20	E01	
All engines	version Ducellier			1.115.023	1.215.061							
All engines									1.970.101D	C10		
ENGINE												
1.3	Petrol	47	09/75-09/84	810 725								
Engine	Information			A10	A20	A40	A50	A70	C10 - C30	C20	E01	
All engines					1.206.040							
ENGINE												
1.4	Petrol	46	01/82-12/85	847 725, C2J 713								
Engine	Information			A10	A20	A40	A50	A70	C10 - C30	C20	E01	
All engines					1.206.040							
Eng. 847 725	version Femsas					1.317.023	1.417.058					
ENGINE												
1.4 Alpine A5	Petrol	68	09/77-09/81	840 725								
Engine	Information			A10	A20	A40	A50	A70	C10 - C30	C20	E01	
All engines	version Ducellier			1.115.034		1.315.054	1.415.091					

A10	CONDENSER	A20	CONTACT SET	A40	DISTRIBUTOR CAP	A50	ROTOR	A70	PICK-UP
C10	COIL	C20	IGNITION MODULE	C30	ELECTRONIC IGNITION KIT	E01	IGNITION CABLE SET		

The present application list is a brief version. For the detailed information about the possibility of installation on a specific vehicle, please refer to our web-catalogue <http://catalogo.facet.eu/>

				FUNCTIONS ON THE VEHICLE								
Vehicle	alim.	kW	Date	Engine								
				ENGINE								
1.4 Alpine A5	Petrol	68	09/77-09/81	840 725								
Engine	Information				A10	A20	A40	A50	A70	C10 - C30	C20	E01
All engines										1.970.101D	C10	
				ENGINE								
1.4 Alpine Turbo	Petrol	79	10/81-01/85	840 726								
Engine	Information				A10	A20	A40	A50	A70	C10 - C30	C20	E01
All engines	version Ducellier						1.315.059					
All engines	distr. num. 525352A/B, version Ducellier							1.415.088				
All engines	distr. num. 525352C, version Ducellier						1.415.094					
				ENGINE								
1.4 Automatik	Petrol	43	06/82-09/84	847 712								
Engine	Information				A10	A20	A40	A50	A70	C10 - C30	C20	E01
All engines						1.206.040						
				ENGINE								
9												
				ENGINE								
1.1	Petrol	35	09/81-05/87	C1E 715								
Engine	Information				A10	A20	A40	A50	A70	C10 - C30	C20	E01
All engines	version Ducellier					1.215.126	1.315.054	1.415.091				
All engines	version Marelli						1.330.101	1.430.047R				
				ENGINE								
1.2	Petrol	40	09/85-12/88	C1G 700, C1G 710								
Engine	Information				A10	A20	A40	A50	A70	C10 - C30	C20	E01
All engines	version Ducellier					1.215.126	1.315.059	1.415.094				
All engines	version Femsas					1.217.026		1.417.058				
All engines									1.970.101D	C10		1.500.839
				ENGINE								
1.7	Petrol	54	10/86-12/88	F3N 718								
Engine	Information				A10	A20	A40	A50	A70	C10 - C30	C20	E01
All engines							1.315.062					
				ENGINE								
1.7	Petrol	55	10/86-12/88	F2N 730								
Engine	Information				A10	A20	A40	A50	A70	C10 - C30	C20	E01
All engines							1.315.062					
				ENGINE								
1.7	Petrol	59	09/84-12/89	F2N 700, F2N 704								
Engine	Information				A10	A20	A40	A50	A70	C10 - C30	C20	E01
All engines							1.315.062					
				ENGINE								
1.7	Petrol	65	10/86-12/88	F2N 708, F2N 710, F2N 798								
Engine	Information				A10	A20	A40	A50	A70	C10 - C30	C20	E01
All engines							1.315.062					
				ENGINE								
1.7	Petrol	69	06/87-12/88	F3N 708								
Engine	Information				A10	A20	A40	A50	A70	C10 - C30	C20	E01
All engines							1.315.062					
				ENGINE								
				ENGINE								
2.0 16V Turbo	Petrol	120	11/01-05/03	F4R 760, F4R 761								
Engine	Information				A10	A20	A40	A50	A70	C10 - C30	C20	E01
All engines	x 4, SAGEM, COIL ON PLUG									1.970.432	C10	
				ENGINE								
				ENGINE								
0.9 TCe 90	Petrol	66	06/13->	H4B 400, H4B 408								
Engine	Information				A10	A20	A40	A50	A70	C10 - C30	C20	E01
All engines	x 3, COIL ON PLUG									1.970.613	C10	
Eng. H4B 408	Qty: 3									1.970.613	C10	

A10 CONDENSER	A20 CONTACT SET	A40 DISTRIBUTOR CAP	A50 ROTOR	A70 PICK-UP
C10 COIL	C20 IGNITION MODULE	C30 ELECTRONIC IGNITION KIT	E01 IGNITION CABLE SET	

Vehicle	alim.	kW	Date	Engine	FUNCTIONS ON THE VEHICLE									
					A10	A20	A40	A50	A70	C10 - C30	C20	E01		
ENGINE														
1.0 TCe 90 ECO-G	Petrol/ Liquified Petroleum Gas (LPG)	67	01/21->	H4D470										
Engine					A10	A20	A40	A50	A70	C10 - C30	C20	E01		
All engines										1.970.552	C10			
ENGINE														
1.2 T	Petrol	83	06/13->	HSF 403										
Engine					A10	A20	A40	A50	A70	C10 - C30	C20	E01		
All engines										1.970.613	C10			
ENGINE														
1.2 T	Petrol	85	06/15->	HSF 403										
Engine					A10	A20	A40	A50	A70	C10 - C30	C20	E01		
All engines										1.970.613	C10			
ENGINE														
1.2 TCe	Petrol	97	02/18->	HSF 408										
Engine					A10	A20	A40	A50	A70	C10 - C30	C20	E01		
All engines										1.970.613	C10			
ENGINE														
1.2 TCe 120	Petrol	87	01/16->	HSF 408, HSF 412										
Engine					A10	A20	A40	A50	A70	C10 - C30	C20	E01		
All engines										1.970.613	C10			
ENGINE														
1.2 TCe 120	Petrol	88	06/13->	HSF 403										
Engine					A10	A20	A40	A50	A70	C10 - C30	C20	E01		
All engines										1.970.613	C10			
ENGINE														
LPG	Petrol/ Liquified Petroleum Gas (LPG)	74	01/20->	H4D 460										
Engine					A10	A20	A40	A50	A70	C10 - C30	C20	E01		
All engines										1.970.552	C10			
ENGINE														
TCe 100	Petrol	74	01/20->	H4D 450										
Engine					A10	A20	A40	A50	A70	C10 - C30	C20	E01		
All engines										1.970.552	C10			
ENGINE														
TCe 90	Petrol	67	09/20->	H4D470										
Engine					A10	A20	A40	A50	A70	C10 - C30	C20	E01		
All engines										1.970.552	C10			
CLIO														
1.2	Petrol	47	11/12->	D4F 740										
Engine					A10	A20	A40	A50	A70	C10 - C30	C20	E01		
All engines										1.970.518	C10			
ENGINE														
1.2	Petrol	48	08/98-05/01	D4F 728										
Engine					A10	A20	A40	A50	A70	C10 - C30	C20	E01		
All engines										1.970.518	C10			
ENGINE														
1.2 BiFuel	LPG	44	03/98-10/01	D7F 722										
Engine					A10	A20	A40	A50	A70	C10 - C30	C20	E01		
All engines										1.970.596	C10			
ENGINE														
1.6	Petrol	58	07/00-10/03	K4M 734										
Engine					A10	A20	A40	A50	A70	C10 - C30	C20	E01		
All engines										1.970.432	C10			

A10 CONDENSER	A20 CONTACT SET	A40 DISTRIBUTOR CAP	A50 ROTOR	A70 PICK-UP
C10 COIL	C20 IGNITION MODULE	C30 ELECTRONIC IGNITION KIT	E01 IGNITION CABLE SET	

The present application list is a brief version. For the detailed information about the possibility of installation on a specific vehicle, please refer to our web-catalogue <http://catalogo.facet.eu/>

Vehicle	alim.	kW	Date	Engine	FUNCTIONS ON THE VEHICLE							
					A10	A20	A40	A50	A70	C10 - C30	C20	E01

CLIO I

1.1	Petrol	34	01/91-09/98	ENGINE C1E 700
-----	--------	----	-------------	-------------------

Engine	Information	A10	A20	A40	A50	A70	C10 - C30	C20	E01
All engines	version Ducellier		1.215.126	1.315.054	1.415.091				

1.1	Petrol	36	04/92-08/92	ENGINE C1E 700
-----	--------	----	-------------	-------------------

Engine	Information	A10	A20	A40	A50	A70	C10 - C30	C20	E01
All engines	version Ducellier		1.215.126	1.315.054	1.415.091				

1.2	Petrol	40	06/90-09/98	ENGINE C3G 720, D7F 730, E5F 716, E7F 706
-----	--------	----	-------------	--

Engine	Information	A10	A20	A40	A50	A70	C10 - C30	C20	E01
Eng. C3G 720	version Ducellier			1.315.059					
Eng. E5F 716, E7F 706	version Ducellier			1.315.081	1.415.101				
Eng. E5F 716, E7F 706	version Marelli			1.330.111	1.430.059				
Eng. C3G 720	distr. num. 525352A, version Ducellier				1.415.088				
Eng. C3G 720	distr. num. 525352E, version Ducellier				1.415.094				
Eng. E5F 716, E7F 706							1.970.107	C10	1.500.801
Eng. C3G 720							1.970.228	C10	1.501.497
Eng. D7F 730							1.970.365	C10	1.501.447

1.2	Petrol	43	05/90-09/98	ENGINE D7F 730, E7F 700, E7F 708, E7F 750
-----	--------	----	-------------	--

Engine	Information	A10	A20	A40	A50	A70	C10 - C30	C20	E01
Eng. E7F 700, E7F 708, E7F 750	version Ducellier			1.315.081	1.415.101				
Eng. E7F 700, E7F 708, E7F 750	version Marelli			1.330.111	1.430.059				
Eng. E7F 700, E7F 708, E7F 750							1.970.107	C10	1.500.801
Eng. D7F 730							1.970.365	C10	1.501.447

1.2	Petrol	44	05/90-09/98	ENGINE E5F 710, E7F 750
-----	--------	----	-------------	----------------------------

Engine	Information	A10	A20	A40	A50	A70	C10 - C30	C20	E01
All engines	version Ducellier			1.315.081	1.415.101				
All engines	version Marelli			1.330.111	1.430.059				
All engines							1.970.107	C10	1.500.801

1.4	Petrol	55	06/90-09/98	ENGINE E6J 718, E7J 756, E7J 757
-----	--------	----	-------------	-------------------------------------

Engine	Information	A10	A20	A40	A50	A70	C10 - C30	C20	E01
All engines	version Ducellier			1.315.081	1.415.101				
All engines	version Marelli			1.330.111	1.430.059				
All engines							1.970.107	C10	1.500.801

1.4	Petrol	57	05/90-02/98	ENGINE E6J 712, E6J 713
-----	--------	----	-------------	----------------------------

Engine	Information	A10	A20	A40	A50	A70	C10 - C30	C20	E01
All engines	version Ducellier			1.315.081	1.415.101				
All engines	version Marelli			1.330.111	1.430.059				
All engines							1.970.107	C10	1.500.801

1.4	Petrol	58	01/91-09/98	ENGINE E7J 601, E7J 718, E7J 719, E7J 754
-----	--------	----	-------------	--

Engine	Information	A10	A20	A40	A50	A70	C10 - C30	C20	E01
All engines	version Ducellier			1.315.081	1.415.101				
All engines	version Marelli			1.330.111	1.430.059				
All engines							1.970.107	C10	1.500.801

1.4	Petrol	59	01/91-09/98	ENGINE E7J 710, E7J 711
-----	--------	----	-------------	----------------------------

Engine	Information	A10	A20	A40	A50	A70	C10 - C30	C20	E01
All engines	version Ducellier			1.315.081	1.415.101				
All engines	version Marelli			1.330.111	1.430.059				
All engines							1.970.107	C10	1.500.801

A10 CONDENSER	A20 CONTACT SET	A40 DISTRIBUTOR CAP	A50 ROTOR	A70 PICK-UP
C10 COIL	C20 IGNITION MODULE	C30 ELECTRONIC IGNITION KIT	E01 IGNITION CABLE SET	

Vehicle	alim.	kW	Date	Engine	FUNCTIONS ON THE VEHICLE									
					A10	A20	A40	A50	A70	C10 - C30	C20	E01		
1.7	Petrol	68	01/91-12/93	ENGINE F2N 770										
Engine	Information			A10	A20	A40	A50	A70	C10 - C30	C20	E01			
All engines	version Ducellier					1.315.069	1.415.097							
All engines	Kit, version Ducellier					1.315.072								
All engines									1.970.107	C10			1.500.415	
1.8	Petrol	65	01/91-09/98	ENGINE F3P 710, F3P 714										
Engine	Information			A10	A20	A40	A50	A70	C10 - C30	C20	E01			
All engines	version Ducellier					1.315.069	1.415.097							
All engines	spacer, version Ducellier					1.315.070								
All engines	Kit, version Ducellier					1.315.072								
All engines									1.970.107	C10				
1.8	Petrol	66	08/90-09/98	ENGINE OHR10DE, F3P 754										
Engine	Information			A10	A20	A40	A50	A70	C10 - C30	C20	E01			
Eng. F3P 754	version Ducellier					1.315.069								
Eng. F3P 754	spacer, version Ducellier					1.315.070								
Eng. F3P 754	Kit, version Ducellier					1.315.072								
Eng. OHR10DE	version Ducellier					1.315.085								
Eng. OHR10DE	Kit, version Ducellier					1.315.086								
All engines	version Ducellier						1.415.097							
All engines									1.970.107	C10				
1.8	Petrol	70	01/91-09/98	ENGINE F3P 710										
Engine	Information			A10	A20	A40	A50	A70	C10 - C30	C20	E01			
All engines	version Ducellier					1.315.069	1.415.097							
All engines	spacer, version Ducellier					1.315.070								
All engines	Kit, version Ducellier					1.315.072								
All engines									1.970.107	C10				
1.8 16V	Petrol	100	02/91-10/92	ENGINE F7P 720										
Engine	Information			A10	A20	A40	A50	A70	C10 - C30	C20	E01			
All engines	distr. num. 525646, version Ducellier					1.315.081								
All engines	distr. num. 525645, version Ducellier					1.315.082								
All engines	distr. num. 525645, Kit, version Ducellier					1.315.083								
All engines	version Ducellier						1.415.101							
All engines									1.970.107	C10			1.500.802	
1.8 16V	Petrol	99	01/91-03/96	ENGINE F7P 722										
Engine	Information			A10	A20	A40	A50	A70	C10 - C30	C20	E01			
All engines	distr. num. 525646, version Ducellier					1.315.081								
All engines	distr. num. 525645, version Ducellier					1.315.082								
All engines	distr. num. 525645, Kit, version Ducellier					1.315.083								
All engines	version Ducellier						1.415.101							
All engines									1.970.107	C10			1.500.802	
1.8 Rsi	Petrol	79	08/95-09/98	ENGINE F3P 758										
Engine	Information			A10	A20	A40	A50	A70	C10 - C30	C20	E01			
All engines	version Ducellier					1.315.069	1.415.097							
All engines	Kit, version Ducellier					1.315.072								
All engines									1.970.107	C10				
1.8 Rsi	Petrol	80	01/93-08/95	ENGINE F3P 712										
Engine	Information			A10	A20	A40	A50	A70	C10 - C30	C20	E01			
All engines	version Ducellier					1.315.069	1.415.097							
All engines	Kit, version Ducellier					1.315.072								
All engines									1.970.107	C10				
Williams	Petrol	108	01/94-09/98	ENGINE F7R 700										
Engine	Information			A10	A20	A40	A50	A70	C10 - C30	C20	E01			
All engines	distr. num. 525646, version Ducellier					1.315.081								

A10	CONDENSER	A20	CONTACT SET	A40	DISTRIBUTOR CAP	A50	ROTOR	A70	PICK-UP
C10	COIL	C20	IGNITION MODULE	C30	ELECTRONIC IGNITION KIT	E01	IGNITION CABLE SET		

The present application list is a brief version. For the detailed information about the possibility of installation on a specific vehicle, please refer to our web-catalogue <http://catalogo.facet.eu/>

Vehicle	alim.	kW	Date	Engine	FUNCTIONS ON THE VEHICLE							
					A10	A20	A40	A50	A70	C10 - C30	C20	E01

ENGINE				
Williams	Petrol	108	01/94-09/98	F7R 700

Engine	Information	A10	A20	A40	A50	A70	C10 - C30	C20	E01
All engines	distr. num. 525645, version Ducellier			1.315.082					
All engines	distr. num. 525645, Kit, version Ducellier			1.315.083					
All engines	version Ducellier				1.415.101				
All engines							1.970.107	C10	1.500.802

CLIO II				
ENGINE				
1.0	Petrol	40	02/00-05/01	D7D 760

Engine	Information	A10	A20	A40	A50	A70	C10 - C30	C20	E01
All engines	x 1, D.I.S.						1.970.596	C10	
All engines									1.501.681

ENGINE				
1.0 16V	Petrol	51	01/01->	D4D 700

Engine	Information	A10	A20	A40	A50	A70	C10 - C30	C20	E01
All engines							1.970.419	C10	

ENGINE				
1.2	Petrol	43	03/98->	D7F 710, D7F 720, D7F 722, D7F 726, D7F 744, D7F 746, D7F 764, D7F 766

Engine	Information	A10	A20	A40	A50	A70	C10 - C30	C20	E01
Eng. D7F 710, D7F 722	->year 21/10/98						1.970.365	C10	
Eng. D7F 720, D7F 726	->year 01/10/98, x 1, D.I.S., x 1, D.I.S.						1.970.365	C10	
Eng. D7F 710, D7F 722, D7F 744, D7F 764	21/10/98 ->						1.970.596	C10	
Eng. D7F 720, D7F 726, D7F 746, D7F 764, D7F 766	01/11/98 ->, x 1, D.I.S., x 1, D.I.S. ----- x 1, D.I.S.						1.970.596	C10	
Eng. D7F 710, D7F 720, D7F 722, D7F 726, D7F 766	->year 20/10/99								1.501.447
All engines	20/10/99 ->								1.501.681

ENGINE				
1.2	Petrol	44	03/99-10/03	D7F 726, D7F 746

Engine	Information	A10	A20	A40	A50	A70	C10 - C30	C20	E01
Eng. D7F 726	->year 21/10/98						1.970.365	C10	
Eng. D7F 726	21/10/98 ->						1.970.596	C10	
Eng. D7F 746	x 1, D.I.S.						1.970.596	C10	
Eng. D7F 726	->year 20/10/99								1.501.447
All engines	20/10/99 ->								1.501.681

ENGINE				
1.2 16V	Petrol	55	06/01-08/16	D4F 706, D4F 712, D4F 714, D4F 722, D4F 728

Engine	Information	A10	A20	A40	A50	A70	C10 - C30	C20	E01
Eng. D4F 706, D4F 712, D4F 714	x 1, with cable, D.I.S.						1.970.419	C10	
Eng. D4F 722, D4F 728	x 1, D.I.S.						1.970.518	C10	
Eng. D4F 722, D4F 728									1.499.246

ENGINE				
1.2 LPG	Petrol/ Liquified Petro- leum Gas (LPG)	43	09/98-06/09	D7F 744, D7F 764, D7F 766

Engine	Information	A10	A20	A40	A50	A70	C10 - C30	C20	E01
All engines	x 1, D.I.S.						1.970.596	C10	
Eng. D7F 766	->year 20/10/99								1.501.447
Eng. D7F 764, D7F 766	20/10/99 ->								1.501.681

ENGINE				
1.2 LPG	Petrol/ Liquified Petro- leum Gas (LPG)	44	03/99-05/01	D7F 722









Engine	Information	A10	A20	A40	A50	A70	C10 - C30	C20	E01
All engines	->year 01/10/98, x 1, D.I.S.						1.970.365	C10	
All engines	->year 20/10/99								1.501.447
All engines	20/10/99 ->								1.501.681

A10 CONDENSER	A20 CONTACT SET	A40 DISTRIBUTOR CAP	A50 ROTOR	A70 PICK-UP
C10 COIL	C20 IGNITION MODULE	C30 ELECTRONIC IGNITION KIT	E01 IGNITION CABLE SET	

Vehicle	alim.	kW	Date	Engine	FUNCTIONS ON THE VEHICLE									
					A10	A20	A40	A50	A70	C10 - C30	C20	E01		
1.4	Petrol	55	09/98-05/05	ENGINE E7J 634, E7J 635, E7J 780, K7J 700										
Engine	Information				A10	A20	A40	A50	A70	C10 - C30	C20	E01		
Eng. E7J 780	x 1, Colour:Black, D.I.S., connector type, saw teeth									1.970.376	C10			
Eng. E7J 780	x 1, Colour:Grey, D.I.S., connector type, saw teeth									1.970.378	C10			
Eng. E7J 634, E7J 635, K7J 700	x 1, D.I.S.									1.970.596	C10			
Eng. E7J 634, K7J 700													1.499.244	
Eng. E7J 780													1.501.443	
1.4 16V	Petrol	70	10/99-09/04	ENGINE K4J 712, K4J 713										
Engine	Information				A10	A20	A40	A50	A70	C10 - C30	C20	E01		
All engines	x 4, SAGEM, COIL ON PLUG									1.970.432	C10			
1.4 16V	Petrol	72	02/00->	ENGINE K4J 700, K4J 710, K4J 711, K4J 712, K4J 713, K4J 715										
Engine	Information				A10	A20	A40	A50	A70	C10 - C30	C20	E01		
Eng. K4J 700	Qty: 4									1.970.432	C10			
Eng. K4J 710, K4J 711, K4J 712, K4J 713, K4J 715	x 4, SAGEM, COIL ON PLUG									1.970.432	C10			
1.6	Petrol	66	09/98-05/05	ENGINE K7M 744, K7M 745, K7M 746										
Engine	Information				A10	A20	A40	A50	A70	C10 - C30	C20	E01		
Eng. K7M 744, K7M 745	x 1, Colour:Black, D.I.S., connector type, saw teeth									1.970.376	C10			
Eng. K7M 744, K7M 745	x 1, Colour:Grey, D.I.S., connector type, saw teeth									1.970.378	C10			
Eng. K7M 746	x 1, D.I.S.									1.970.596	C10			
Eng. K7M 744, K7M 745													1.501.443	
1.6	Petrol	79	11/03->	ENGINE K4M 746										
Engine	Information				A10	A20	A40	A50	A70	C10 - C30	C20	E01		
All engines	x 4, SAGEM, COIL ON PLUG									1.970.432	C10			
1.6 16V	Petrol	66	10/99->	ENGINE K4M 734										
Engine	Information				A10	A20	A40	A50	A70	C10 - C30	C20	E01		
All engines	Qty: 4									1.970.432	C10			
1.6 16V	Petrol	79	09/98-04/05	ENGINE K4M 708, K4M 740, K4M 742, K4M 743, K4M 744, K4M 745, K4M 746, K4M 748										
Engine	Information				A10	A20	A40	A50	A70	C10 - C30	C20	E01		
All engines	x 4, SAGEM, COIL ON PLUG									1.970.432	C10			
1.6 16V	Petrol	82	03/99-12/08	ENGINE K4M 708										
Engine	Information				A10	A20	A40	A50	A70	C10 - C30	C20	E01		
All engines	x 4, SAGEM, COIL ON PLUG									1.970.432	C10			
1.6 Hi-Flex	Petrol/ Ethanol	86	01/05-02/10	ENGINE K4M 748										
Engine	Information				A10	A20	A40	A50	A70	C10 - C30	C20	E01		
All engines	x 4, SAGEM, COIL ON PLUG									1.970.432	C10			
1.6i	Petrol	66	11/04->	ENGINE K4M 736										
Engine	Information				A10	A20	A40	A50	A70	C10 - C30	C20	E01		
All engines	Qty: 4									1.970.432	C10			
2.0 16V	Petrol	124	06/01->	ENGINE F4R 732										
Engine	Information				A10	A20	A40	A50	A70	C10 - C30	C20	E01		
All engines	Qty: 4									1.970.432	C10			

A10	CONDENSER	A20	CONTACT SET	A40	DISTRIBUTOR CAP	A50	ROTOR	A70	PICK-UP
C10	COIL	C20	IGNITION MODULE	C30	ELECTRONIC IGNITION KIT	E01	IGNITION CABLE SET		

The present application list is a brief version. For the detailed information about the possibility of installation on a specific vehicle, please refer to our web-catalogue <http://catalogue.facet.eu/>

					FUNCTIONS ON THE VEHICLE							
Vehicle	alim.	kW	Date	Engine	 A10	 A20	 A40	 A50	 A70	 C10 - C30	 C20	 E01
ENGINE												
2.0 16V Sport	Petrol	124	02/00-06/09	F4R 730, F4R 732, F4R 736								
Engine	Information				A10	A20	A40	A50	A70	C10 - C30	C20	E01
All engines	x 1, D.I.S.									1.970.365	C10	
ENGINE												
2.0 16V Sport	Petrol	132	01/04-04/05	F4R 738								
Engine	Information				A10	A20	A40	A50	A70	C10 - C30	C20	E01
All engines	x 1, D.I.S.									1.970.365	C10	
CLIO III												
ENGINE												
1.2	Petrol	55	11/05-12/14	D4F 740								
Engine	Information				A10	A20	A40	A50	A70	C10 - C30	C20	E01
All engines	x 1, D.I.S.									1.970.518	C10	
ENGINE												
1.2	Petrol	57	10/05-12/12	D4F 764								
Engine	Information				A10	A20	A40	A50	A70	C10 - C30	C20	E01
All engines	x 1, D.I.S.									1.970.518	C10	
All engines												1.499.246
ENGINE												
1.2	Petrol	74	11/07-12/11	D4F 784								
Engine	Information				A10	A20	A40	A50	A70	C10 - C30	C20	E01
All engines	x 1, D.I.S.									1.970.596	C10	
ENGINE												
1.2 16V	Petrol	43	06/06-08/10	D4F 764								
Engine	Information				A10	A20	A40	A50	A70	C10 - C30	C20	E01
All engines	x 1, D.I.S.									1.970.518	C10	
All engines												1.499.246
ENGINE												
1.2 16V	Petrol	48	06/05-12/14	D4F 740								
Engine	Information				A10	A20	A40	A50	A70	C10 - C30	C20	E01
All engines	x 1, D.I.S.									1.970.518	C10	
All engines												1.499.246
ENGINE												
1.2 16V	Petrol	55	06/05-12/14	D4F 706, D4F 740, D4F 764								
Engine	Information				A10	A20	A40	A50	A70	C10 - C30	C20	E01
Eng. D4F 706										1.970.419	C10	
Eng. D4F 740	x 1, D.I.S.									1.970.518	C10	
Eng. D4F 764										1.970.518	C10	
Eng. D4F 740, D4F 764												1.499.246
ENGINE												
1.2 16V	Petrol	58	06/05-12/14	D4F 764								
Engine	Information				A10	A20	A40	A50	A70	C10 - C30	C20	E01
All engines	x 1, D.I.S.									1.970.518	C10	
All engines												1.499.246
ENGINE												
1.2 16V	Petrol	74	05/07-12/14	D4F 784								
Engine	Information				A10	A20	A40	A50	A70	C10 - C30	C20	E01
All engines	x 1, D.I.S.									1.970.596	C10	
All engines												1.499.229
ENGINE												
1.2 16V	Petrol	76	03/10-12/14	D4F 786								
Engine	Information				A10	A20	A40	A50	A70	C10 - C30	C20	E01
All engines	x 1, D.I.S.									1.970.596	C10	
All engines												1.499.229
ENGINE												
1.2 16V Hi-Flex	Petrol/ Ethanol	55	07/08-12/14	D4F 740, D4F 744								
Engine	Information				A10	A20	A40	A50	A70	C10 - C30	C20	E01
Eng. D4F 740										1.970.518	C10	1.499.246
Eng. D4F 744	x 1, D.I.S.									1.970.518	C10	

A10 CONDENSER	A20 CONTACT SET	A40 DISTRIBUTOR CAP	A50 ROTOR	A70 PICK-UP
C10 COIL	C20 IGNITION MODULE	C30 ELECTRONIC IGNITION KIT	E01 IGNITION CABLE SET	

Vehicle	alim.	kW	Date	Engine	FUNCTIONS ON THE VEHICLE								
					A10	A20	A40	A50	A70	C10 - C30	C20	E01	
ENGINE													
1.2 16V Hi-Flex	Petrol/ Ethanol	58	11/07-12/12	D4F 742									
Engine	Information												
All engines	x 1, D.I.S.									1,970.518	C10		
ENGINE													
1.2 16V Hi-Flex	Petrol/ Liquified Petro- leum Gas (LPG)	55	07/08-12/14	D4F 740, D4F 742									
Engine	Information												
Eng. D4F 740										1,970.518	C10		
Eng. D4F 742	x 1, D.I.S.									1,970.518	C10		
All engines													1,499.246
ENGINE													
1.2 Ethanol	Petrol/ Ethanol	55	07/08-12/12	D4F 742									
Engine	Information												
All engines	x 1, D.I.S.									1,970.518	C10		
ENGINE													
1.2 Hi-Flex	Petrol/ Ethanol	58	11/07-12/09	D4F 742									
Engine	Information												
All engines	x 1, D.I.S.									1,970.518	C10		
ENGINE													
1.4 16V	Petrol	72	06/05-12/12	K4J 780									
Engine	Information												
All engines	x 4, SAGEM, COIL ON PLUG									1,970.432	C10		
ENGINE													
1.6 16V	Petrol	65	06/05-10/07	K4M 804									
Engine	Information												
All engines	x 4, SAGEM, COIL ON PLUG									1,970.432	C10		
ENGINE													
1.6 16V	Petrol	80	11/07-12/12	K4M 804									
Engine	Information												
All engines	x 4, SAGEM, COIL ON PLUG									1,970.432	C10		
ENGINE													
1.6 16V	Petrol	82	06/05-12/14	K4M 800, K4M 801									
Engine	Information												
All engines	x 4, SAGEM, COIL ON PLUG									1,970.432	C10		
ENGINE													
1.6 16V	Petrol	94	11/07-12/12	K4M 862									
Engine	Information												
All engines	x 4, SAGEM, COIL ON PLUG									1,970.432	C10		
ENGINE													
1.6 16V GT	Petrol	94	06/09-12/14	K4M 862									
Engine	Information												
All engines	x 4, SAGEM, COIL ON PLUG									1,970.432	C10		
ENGINE													
2.0 16V	Petrol	102	09/06-12/14	M4R 700, M4R 701									
Engine	Information												
All engines	x 4, COIL ON PLUG									1,970.489	C10		
ENGINE													
2.0 16V Sport	Petrol	145	02/06-12/12	F4R 830									
Engine	Information												
All engines	x 4, SAGEM, COIL ON PLUG									1,970.432	C10		
ENGINE													
2.0 16V Sport	Petrol	148	09/08->	--, F4R 830, F4R 832									
Engine	Information												
Eng. --, F4R 830	Qty: 4									1,970.432	C10		
Eng. F4R 832	x 4, SAGEM, COIL ON PLUG									1,970.432	C10		

A10	CONDENSER	A20	CONTACT SET	A40	DISTRIBUTOR CAP	A50	ROTOR	A70	PICK-UP
C10	COIL	C20	IGNITION MODULE	C30	ELECTRONIC IGNITION KIT	E01	IGNITION CABLE SET		

The present application list is a brief version. For the detailed information about the possibility of installation on a specific vehicle, please refer to our web-catalogue <http://catalogo.facet.eu/>

Vehicle	alim.	kW	Date	Engine	FUNCTIONS ON THE VEHICLE							
					A10	A20	A40	A50	A70	C10 - C30	C20	E01

CLIO IV

				ENGINE
0.9 TCe 75	Petrol	56	05/18->	H4B 408

Engine	Information	A10	A20	A40	A50	A70	C10 - C30	C20	E01
All engines	x 3, COIL ON PLUG						1.970.613	C10	

				ENGINE
0.9 TCe 90	Petrol	66	11/12->	H4B 400, H4B 408

Engine	Information	A10	A20	A40	A50	A70	C10 - C30	C20	E01
All engines	x 3, COIL ON PLUG						1.970.613	C10	
Eng. H4B 408	Qty: 3						1.970.613	C10	

				ENGINE
0.9 TCe 90 LPG	Petrol/ Liquified Petro- leum Gas (LPG)	66	08/15->	H4B 410

Engine	Information	A10	A20	A40	A50	A70	C10 - C30	C20	E01
All engines	x 3, COIL ON PLUG						1.970.613	C10	

				ENGINE
1.2 16V	Petrol	54	11/12->	D4F 740, D4F 744

Engine	Information	A10	A20	A40	A50	A70	C10 - C30	C20	E01
Eng. D4F 744							1.970.518	C10	1.499.246
Eng. D4F 740	x 1, D.I.S.						1.970.518	C10	

				ENGINE
1.2 16V	Petrol	55	06/15->	D4F 740

Engine	Information	A10	A20	A40	A50	A70	C10 - C30	C20	E01
All engines	x 1, D.I.S.						1.970.518	C10	

				ENGINE
1.2 16V LPG	Petrol/ Liquified Petro- leum Gas (LPG)	53	01/14->	D4F 744

Engine	Information	A10	A20	A40	A50	A70	C10 - C30	C20	E01
All engines	x 1, D.I.S.						1.970.518	C10	

				ENGINE
1.2 LPG	Petrol/ Liquified Petro- leum Gas (LPG)	53	01/14->	D4F 744

Engine	Information	A10	A20	A40	A50	A70	C10 - C30	C20	E01
All engines	x 1, D.I.S.						1.970.518	C10	

				ENGINE
1.2 LPG 16V	Petrol/ Liquified Petro- leum Gas (LPG)	54	11/12-06/15	D4F 744

Engine	Information	A10	A20	A40	A50	A70	C10 - C30	C20	E01
All engines	x 1, D.I.S.						1.970.518	C10	

				ENGINE
1.2 TCe 120	Petrol	87	01/16->	H5F 408, H5F 412

Engine	Information	A10	A20	A40	A50	A70	C10 - C30	C20	E01
All engines	x 4, COIL ON PLUG						1.970.613	C10	

				ENGINE
1.2 TCe 120	Petrol	88	03/13->	H5F 403, H5F 412

Engine	Information	A10	A20	A40	A50	A70	C10 - C30	C20	E01
All engines	x 4, COIL ON PLUG						1.970.613	C10	

				ENGINE
1.6 RS	Petrol	147	03/13->	M5M 400, M5M 401

Engine	Information	A10	A20	A40	A50	A70	C10 - C30	C20	E01
All engines	x 4, COIL ON PLUG						1.970.551	C10	

				ENGINE
1.6 RS Trophy	Petrol	162	03/15->	M5M 401

Engine	Information	A10	A20	A40	A50	A70	C10 - C30	C20	E01
All engines	x 4, COIL ON PLUG						1.970.551	C10	

A10 CONDENSER	A20 CONTACT SET	A40 DISTRIBUTOR CAP	A50 ROTOR	A70 PICK-UP
C10 COIL	C20 IGNITION MODULE	C30 ELECTRONIC IGNITION KIT	E01 IGNITION CABLE SET	

Vehicle	alim.	kW	Date	Engine	FUNCTIONS ON THE VEHICLE							
					A10	A20	A40	A50	A70	C10 - C30	C20	E01

CLIO V

Vehicle	alim.	kW	Date	ENGINE
1.0 LPG	Petrol/ Liquified Petroleum Gas (LPG)	74	06/19->	H4D 450, H4D 452, H4D 460

Engine	Information	A10	A20	A40	A50	A70	C10 - C30	C20	E01
All engines	x 3, COIL ON PLUG						1.970.552	C10	

Vehicle	alim.	kW	Date	ENGINE
1.0 TCe 100	Petrol	74	06/19->	H4D 450, H4D 452, H4D 460

Engine	Information	A10	A20	A40	A50	A70	C10 - C30	C20	E01
All engines	x 3, COIL ON PLUG						1.970.552	C10	

Vehicle	alim.	kW	Date	ENGINE
TCe 90	Petrol	67	08/20->	H4D 450, H4D 470

Engine	Information	A10	A20	A40	A50	A70	C10 - C30	C20	E01
All engines	x 3, COIL ON PLUG						1.970.552	C10	

DOKKER

Vehicle	alim.	kW	Date	ENGINE
1.6	Petrol	59	12/13->	K7M 812

Engine	Information	A10	A20	A40	A50	A70	C10 - C30	C20	E01
All engines	x 1, D.I.S.						1.970.596	C10	

DUSTER

Vehicle	alim.	kW	Date	ENGINE
1.6 16V	Petrol	75	02/12->	K4M 616

Engine	Information	A10	A20	A40	A50	A70	C10 - C30	C20	E01
All engines	x 4, SAGEM, COIL ON PLUG						1.970.432	C10	

Vehicle	alim.	kW	Date	ENGINE
1.6 16V	Petrol	84	06/15->	H4M 438

Engine	Information	A10	A20	A40	A50	A70	C10 - C30	C20	E01
All engines	x 4, COIL ON PLUG						1.970.613	C10	

Vehicle	alim.	kW	Date	ENGINE
1.6 16V 4x4	Petrol	75	06/11-05/15	K4M 490, K4M 606, K4M 646, K4M 690

Engine	Information	A10	A20	A40	A50	A70	C10 - C30	C20	E01
All engines	x 4, SAGEM, COIL ON PLUG						1.970.432	C10	

Vehicle	alim.	kW	Date	ENGINE
1.6 16V 4x4	Petrol	84	06/15->	H4M 430

Engine	Information	A10	A20	A40	A50	A70	C10 - C30	C20	E01
All engines	x 4, COIL ON PLUG						1.970.613	C10	

Vehicle	alim.	kW	Date	ENGINE
2.0	Petrol	98	02/12->	F4R 403, F4R 405

Engine	Information	A10	A20	A40	A50	A70	C10 - C30	C20	E01
All engines	x 4, SAGEM, COIL ON PLUG						1.970.432	C10	

Vehicle	alim.	kW	Date	ENGINE
2.0 4x4	Petrol	105	10/11->	F4R 410, F4R 412

Engine	Information	A10	A20	A40	A50	A70	C10 - C30	C20	E01
All engines	x 4, SAGEM, COIL ON PLUG						1.970.432	C10	

Vehicle	alim.	kW	Date	ENGINE
2.0 4x4	Petrol	99	02/12->	F4R 400, F4R 402, F4R 401

Engine	Information	A10	A20	A40	A50	A70	C10 - C30	C20	E01
All engines	x 4, SAGEM, COIL ON PLUG						1.970.432	C10	

ESPACE I

Vehicle	alim.	kW	Date	ENGINE
2.0	Petrol	74	01/88-12/90	S3AZ-FXE

Engine	Information	A10	A20	A40	A50	A70	C10 - C30	C20	E01
All engines	version Ducellier			1.315.079	1.415.094				
All engines	info S100600201, info S100600243, info S100620001, info S100940201, info S100940220, info S100948002, info S101910201, info S101910220, info S101910243, info S102020001, info S102030002						1.970.107	C10	

A10	CONDENSER	A20	CONTACT SET	A40	DISTRIBUTOR CAP	A50	ROTOR	A70	PICK-UP
C10	COIL	C20	IGNITION MODULE	C30	ELECTRONIC IGNITION KIT	E01	IGNITION CABLE SET		

The present application list is a brief version. For the detailed information about the possibility of installation on a specific vehicle, please refer to our web-catalogue <http://catalogo.facet.eu/>









				FUNCTIONS ON THE VEHICLE								
Vehicle	alim.	kW	Date	Engine								
				ENGINE								
2.0	Petrol	80	07/84-12/90	J6R 234, J6R 236								
ENGINE					A10	A20	A40	A50	A70	C10 - C30	C20	E01
All engines							1.315.079	1.415.094				
All engines										1.970.107	C10	
2.0 i	Petrol	87	01/89-12/90	J7R 760								
ENGINE					A10	A20	A40	A50	A70	C10 - C30	C20	E01
All engines							1.315.088					
All engines										1.970.107	C10	1.500.539
2.0 i Quadra	Petrol	87	03/88-12/92	J7R 760								
ENGINE					A10	A20	A40	A50	A70	C10 - C30	C20	E01
All engines							1.315.088					
All engines										1.970.107	C10	1.500.539
2.2	Petrol	79	07/86-12/90	2QG15DE								
ENGINE					A10	A20	A40	A50	A70	C10 - C30	C20	E01
All engines							1.315.088					
All engines												1.500.539
2.2 Quadra	Petrol	79	01/88-12/90	2QG15DE								
ENGINE					A10	A20	A40	A50	A70	C10 - C30	C20	E01
All engines							1.315.088					
All engines												1.500.539
				ESPACE II								
2.0	Petrol	76	01/91-10/96	J7R 768								
ENGINE					A10	A20	A40	A50	A70	C10 - C30	C20	E01
All engines							1.315.065			1.970.107	C10	1.500.539
All engines							1.315.066	1.415.094				
2.2	Petrol	79	01/91-10/96	J7T 772, J7T 773, J7T 776								
ENGINE					A10	A20	A40	A50	A70	C10 - C30	C20	E01
Eng. J7T 772							1.315.059	1.415.094				
All engines							1.315.065			1.970.107	C10	
Eng. J7T 776							1.315.066					
Eng. J7T 773, J7T 776												1.500.539
2.2 4x4	Petrol	79	03/91-12/96	J7T 772, J7T 773								
ENGINE					A10	A20	A40	A50	A70	C10 - C30	C20	E01
Eng. J7T 772							1.315.059	1.415.094				
All engines										1.970.107	C10	
Eng. J7T 773												1.500.539
2.8 V6	Petrol	110	01/91-10/96	Z7W 712, Z7W 713, Z7W 717								
ENGINE					A10	A20	A40	A50	A70	C10 - C30	C20	E01
All engines							1.306.236	1.406.119R				
All engines										1.970.107	C10	
				ESPACE III								
2.0	Petrol	102	09/01-10/02	F4R 700, F4R 701								
ENGINE					A10	A20	A40	A50	A70	C10 - C30	C20	E01
All engines										1.970.432	C10	
2.0	Petrol	84	11/96-10/00	F3R 728, F3R 729, F3R 742, F3R 768, F3R 769								
ENGINE					A10	A20	A40	A50	A70	C10 - C30	C20	E01
All engines										1.970.196	C10	
Eng. F3R 728, F3R 729, F3R 768, F3R 769										1.970.275	C10	
Information												
01/05/97 ->, x 1, D.I.S., connector type, saw teeth												
->year 01/04/97, x 1, D.I.S.												

A10 CONDENSER	A20 CONTACT SET	A40 DISTRIBUTOR CAP	A50 ROTOR	A70 PICK-UP
C10 COIL	C20 IGNITION MODULE	C30 ELECTRONIC IGNITION KIT	E01 IGNITION CABLE SET	

Vehicle	alim.	kW	Date	Engine	FUNCTIONS ON THE VEHICLE									
					A10	A20	A40	A50	A70	C10 - C30	C20	E01		
ENGINE														
2.0	Petrol	84	11/96-10/00	F3R 728, F3R 729, F3R 742, F3R 768, F3R 769										
Engine	Information				A10	A20	A40	A50	A70	C10 - C30	C20	E01		
All engines	02/04/97 ->												1.501.492	
	Eng. F3R 728, F3R 768, F3R 769 ->year 02/04/97												1.501.501	
ENGINE														
2.0 16V	Petrol	103	10/98-10/02	F4R 700, F4R 701										
Engine	Information				A10	A20	A40	A50	A70	C10 - C30	C20	E01		
All engines	x 4, SAGEM, COIL ON PLUG									1.970.432	C10			
ENGINE														
3.0	Petrol	123	11/96-10/98	Z7X 775										
Engine	Information				A10	A20	A40	A50	A70	C10 - C30	C20	E01		
All engines	Fitting Position:for cylinder 1-2, x 1, D.I.S.									1.970.275	C10			
All engines	Fitting Position:for cylinder 3-4, x 1, D.I.S.									1.970.276	C10			
ESPACE IV														
ENGINE														
2.0	Petrol	100	11/02-01/15	F4R 792										
Engine	Information				A10	A20	A40	A50	A70	C10 - C30	C20	E01		
All engines	x 4, SAGEM, COIL ON PLUG									1.970.432	C10			
ENGINE														
2.0	Petrol	125	04/05->	F4R 794, F4R 795, F4R 796, F4R 797, F4R 896, F4R 897										
Engine	Information				A10	A20	A40	A50	A70	C10 - C30	C20	E01		
All engines	x 4, SAGEM, COIL ON PLUG									1.970.432	C10			
ENGINE														
2.0	Petrol	98	11/02-12/15	F4R 790										
Engine	Information				A10	A20	A40	A50	A70	C10 - C30	C20	E01		
All engines	x 4, SAGEM, COIL ON PLUG									1.970.432	C10			
ENGINE														
2.0 Turbo	Petrol	120	11/02->	F4R 794, F4R 795, F4R 796, F4R 797										
Engine	Information				A10	A20	A40	A50	A70	C10 - C30	C20	E01		
All engines	x 4, SAGEM, COIL ON PLUG									1.970.432	C10			
ESPACE V														
ENGINE														
1.6 TcE 200	Petrol	147	02/15->	M5M 450										
Engine	Information				A10	A20	A40	A50	A70	C10 - C30	C20	E01		
All engines	x 4, COIL ON PLUG									1.970.551	C10			
ENGINE														
1.8 TcE 225	Petrol	165	10/16->	5T2175X15DYA, M5P 403										
Engine	Information				A10	A20	A40	A50	A70	C10 - C30	C20	E01		
All engines	x 4, COIL ON PLUG									1.970.551	C10			
EXPRESS														
ENGINE														
1.2	Petrol	40	07/95-10/99	C3G 710, C3G 712										
Engine	Information				A10	A20	A40	A50	A70	C10 - C30	C20	E01		
All engines	x 1, DISTRIBUTOR									1.970.228	C10			
ENGINE														
1.4i	Petrol	0	01/85-10/90	C3G/C3J										
Engine	Information				A10	A20	A40	A50	A70	C10 - C30	C20	E01		
All engines	version Ducellier						1.315.059							
All engines	distr. num. 525 352 A/B, version Ducellier						1.415.088							
All engines	distr. num. 525 352 C/D, version Ducellier						1.415.094							
All engines										1.970.228	C10		1.500.543	
FLUENCE														
ENGINE														
1.6	Petrol	86	01/13->	H4M 729										
Engine	Information				A10	A20	A40	A50	A70	C10 - C30	C20	E01		
All engines	Qty: 4									1.970.552	C10			

A10	CONDENSER	A20	CONTACT SET	A40	DISTRIBUTOR CAP	A50	ROTOR	A70	PICK-UP
C10	COIL	C20	IGNITION MODULE	C30	ELECTRONIC IGNITION KIT	E01	IGNITION CABLE SET		

The present application list is a brief version. For the detailed information about the possibility of installation on a specific vehicle, please refer to our web-catalogue <http://catalogo.facet.eu/>

					FUNCTIONS ON THE VEHICLE								
Vehicle	alim.	kW	Date	Engine									
ENGINE													
1.6 16V	Petrol	78	02/10->	K4M 838									
ENGINE													
All engines					x 4, SAGEM, COIL ON PLUG						1.970.432	C10	
1.6 16V	Petrol	81	02/10->	K4M 838, K4M 839									
ENGINE													
All engines					x 4, SAGEM, COIL ON PLUG						1.970.432	C10	
1.6 LPG 16V	Petrol/ Liquified Petro- leum Gas (LPG)	81	01/12->	K4M 839									
ENGINE													
All engines					x 4, SAGEM, COIL ON PLUG						1.970.432	C10	
FUEGO													
1.6 [USA] R1368	Petrol	0	01/82-12/84	A7L 752									
ENGINE													
All engines					version Bosch			1.306.094	1.406.012R				
All engines					version Ducellier			1.315.054	1.415.091				
GRAND SCÉNIC II													
1.6	Petrol	77	06/06-11/08	K4M 788									
ENGINE													
All engines					x 4, SAGEM, COIL ON PLUG						1.970.432	C10	
1.6	Petrol	82	06/06-11/08	K4M 812, K4M 813									
ENGINE													
All engines					x 4, SAGEM, COIL ON PLUG						1.970.432	C10	
1.6	Petrol	83	04/04-08/06	K4M 761, K4M 764, K4M 782, K4M 812, K4M 813									
ENGINE													
All engines					x 4, SAGEM, COIL ON PLUG						1.970.432	C10	
1.6 Flex	Petrol/ Ethanol	82	06/06-06/09	K4M 766									
ENGINE													
All engines					x 4, SAGEM, COIL ON PLUG						1.970.432	C10	
2.0	Petrol	120	04/04-06/09	F4R 776									
ENGINE													
All engines					x 4, SAGEM, COIL ON PLUG						1.970.432	C10	
2.0	Petrol	99	04/04-06/09	F4R 770, F4R 771									
ENGINE													
All engines					x 4, SAGEM, COIL ON PLUG						1.970.432	C10	
GRAND SCÉNIC III													
1.2 TCe	Petrol	85	04/12->	H5F 400, H5F 408									
ENGINE													
All engines					x 4, COIL ON PLUG						1.970.613	C10	
1.2 TCe	Petrol	96	07/14->	H5F 408									
ENGINE													
All engines					x 4, COIL ON PLUG						1.970.613	C10	
1.2 TCe	Petrol	97	01/13->	H5F 404, H5F 408									
ENGINE													
All engines					x 4, COIL ON PLUG						1.970.613	C10	

A10 CONDENSER	A20 CONTACT SET	A40 DISTRIBUTOR CAP	A50 ROTOR	A70 PICK-UP
C10 COIL	C20 IGNITION MODULE	C30 ELECTRONIC IGNITION KIT	E01 IGNITION CABLE SET	

Vehicle	alim.	kW	Date	Engine	FUNCTIONS ON THE VEHICLE									
					A10	A20	A40	A50	A70	C10 - C30	C20	E01		
ENGINE														
1.6 16V	Petrol	81	02/09->	K4M 858										
Engine		Information			A10	A20	A40	A50	A70	C10 - C30	C20	E01		
All engines		x 4, SAGEM, COIL ON PLUG								1.970.432	C10			
ENGINE														
1.6 16V Bifuel	Petrol/ Liquified Petroleum Gas (LPG)	79	04/12->	K4M 866										
Engine		Information			A10	A20	A40	A50	A70	C10 - C30	C20	E01		
All engines		x 4, SAGEM, COIL ON PLUG								1.970.432	C10			
ENGINE														
1.6 16V Bifuel	Petrol/ Liquified Petroleum Gas (LPG)	81	02/09->	K4M 866										
Engine		Information			A10	A20	A40	A50	A70	C10 - C30	C20	E01		
All engines		x 4, SAGEM, COIL ON PLUG								1.970.432	C10			
ENGINE														
1.6 E85	Petrol/ Ethanol	81	02/09->	K4M 866										
Engine		Information			A10	A20	A40	A50	A70	C10 - C30	C20	E01		
All engines		x 4, SAGEM, COIL ON PLUG								1.970.432	C10			
GRAND SCÉNIC IV														
ENGINE														
1.2 TCe 115	Petrol	85	09/16->	H5F 408										
Engine		Information			A10	A20	A40	A50	A70	C10 - C30	C20	E01		
All engines		x 4, COIL ON PLUG								1.970.613	C10			
ENGINE														
1.2 TCe 130	Petrol	96	09/16->	H5F 408										
Engine		Information			A10	A20	A40	A50	A70	C10 - C30	C20	E01		
All engines		x 4, COIL ON PLUG								1.970.613	C10			
KADJAR														
ENGINE														
1.2 TCe 130	Petrol	96	06/15->	H5F 408										
Engine		Information			A10	A20	A40	A50	A70	C10 - C30	C20	E01		
All engines		x 4, COIL ON PLUG								1.970.613	C10			
ENGINE														
1.6 TCe 165	Petrol	120	11/16->	M5M460										
Engine		Information			A10	A20	A40	A50	A70	C10 - C30	C20	E01		
All engines		x 4, COIL ON PLUG								1.970.551	C10			
KANGOO														
ENGINE														
1.2	Petrol	43	07/01-10/03	D4F 712, D4F 714										
Engine		Information			A10	A20	A40	A50	A70	C10 - C30	C20	E01		
All engines		x 1, with cable, D.I.S.								1.970.419	C10			
ENGINE														
1.2	Petrol	44	12/01-06/03	D7F 746										
Engine		Information			A10	A20	A40	A50	A70	C10 - C30	C20	E01		
All engines		x 1, D.I.S.								1.970.596	C10			
ENGINE														
1.2 BiFuel	LPG	44	06/97-06/03	D7F 710, D7F 722, D7F 744, D7F 764, D7F 766										
Engine		Information			A10	A20	A40	A50	A70	C10 - C30	C20	E01		
All engines		->year 01/10/98, x 1, D.I.S.								1.970.365	C10			
All engines		01/11/98 ->, x 1, D.I.S.								1.970.596	C10			
ENGINE														
1.6	Petrol	74	03/13->	K4M 836										
Engine		Information			A10	A20	A40	A50	A70	C10 - C30	C20	E01		
All engines		x 4, SAGEM, COIL ON PLUG								1.970.432	C10			

A10	CONDENSER	A20	CONTACT SET	A40	DISTRIBUTOR CAP	A50	ROTOR	A70	PICK-UP
C10	COIL	C20	IGNITION MODULE	C30	ELECTRONIC IGNITION KIT	E01	IGNITION CABLE SET		

The present application list is a brief version. For the detailed information about the possibility of installation on a specific vehicle, please refer to our web-catalogue <http://catalogo.facet.eu/>









					FUNCTIONS ON THE VEHICLE							
Vehicle	alim.	kW	Date	Engine	A10	A20	A40	A50	A70	C10 - C30	C20	E01
ENGINE												
1.6 BiFuel	LPG	60	06/05-06/08	K4M 750								
Engine	Information				A10	A20	A40	A50	A70	C10 - C30	C20	E01
All engines	x 4, SAGEM, COIL ON PLUG									1.970.432	C10	
ENGINE												
1.6 CNG	CNG	78	10/07->	K4M 830								
Engine	Information				A10	A20	A40	A50	A70	C10 - C30	C20	E01
All engines	x 4, SAGEM, COIL ON PLUG									1.970.432	C10	
KANGOO I												
ENGINE												
1.0	Petrol	40	07/03->	D7D 700								
Engine	Information				A10	A20	A40	A50	A70	C10 - C30	C20	E01
All engines										1.970.596	C10	1.501.681
ENGINE												
1.0	Petrol	43	01/02-01/07	D7D 700								
Engine	Information				A10	A20	A40	A50	A70	C10 - C30	C20	E01
All engines	x 1, D.I.S.									1.970.596	C10	
ENGINE												
1.0	Petrol	50	01/02-01/07	D4D 700, D4D 720								
Engine	Information				A10	A20	A40	A50	A70	C10 - C30	C20	E01
All engines	x 1, with cable, D.I.S.									1.970.419	C10	
ENGINE												
1.0 16V	Petrol	51	03/98->	S9CH23N17, D4D 700								
Engine	Information				A10	A20	A40	A50	A70	C10 - C30	C20	E01
All engines										1.970.419	C10	
ENGINE												
1.0 RN	Petrol	43	01/02-01/07	D7D 700, D7D 760								
Engine	Information				A10	A20	A40	A50	A70	C10 - C30	C20	E01
All engines	x 1, D.I.S.									1.970.596	C10	
ENGINE												
1.2	Petrol	43	08/97->	D7F 710, D7F 720, D7F 722, D7F 726, D7F 744, D7F 746								
Engine	Information				A10	A20	A40	A50	A70	C10 - C30	C20	E01
Eng. D7F 710, D7F 722, D7F 744	->year 21/10/98									1.970.365	C10	
Eng. D7F 720, D7F 726, D7F 746	->year 01/10/98, x 1, D.I.S.									1.970.365	C10	
Eng. D7F 710, D7F 722, D7F 744	21/10/98 ->									1.970.596	C10	
Eng. D7F 720, D7F 726, D7F 746	01/11/98 ->, x 1, D.I.S.									1.970.596	C10	
All engines	->year 02/10/99											1.501.447
All engines	02/10/99 ->											1.501.681
ENGINE												
1.2	Petrol	44	07/98-07/01	D7F 710, D7F 722, D7F 744, D7F 764, D7F 766								
Engine	Information				A10	A20	A40	A50	A70	C10 - C30	C20	E01
All engines	->year 01/10/98, x 1, D.I.S.									1.970.365	C10	
All engines	01/11/98 ->, x 1, D.I.S.									1.970.596	C10	
ENGINE												
1.2 16V	Petrol	55	06/01->	D4F 712, D4F 714, D4F 716, D4F 730								
Engine	Information				A10	A20	A40	A50	A70	C10 - C30	C20	E01
Eng. D4F 712, D4F 714, D4F 716	x 1, with cable, x 1, D.I.S., with cable, D.I.S.									1.970.419	C10	
Eng. D4F 730	x 1, D.I.S.									1.970.518	C10	
ENGINE												
1.2 BiFuel	Petrol/ Liquified Petro- leum Gas (LPG)	43	07/98-07/01	D7F 710, D7F 744								
Engine	Information				A10	A20	A40	A50	A70	C10 - C30	C20	E01
All engines	->year 01/10/98, x 1, D.I.S.									1.970.365	C10	
All engines	01/11/98 ->, x 1, D.I.S.									1.970.596	C10	

A10 CONDENSER	A20 CONTACT SET	A40 DISTRIBUTOR CAP	A50 ROTOR	A70 PICK-UP
C10 COIL	C20 IGNITION MODULE	C30 ELECTRONIC IGNITION KIT	E01 IGNITION CABLE SET	

Vehicle	alim.	kW	Date	Engine	FUNCTIONS ON THE VEHICLE									
					A10	A20	A40	A50	A70	C10 - C30	C20	E01		
ENGINE														
1.4	Petrol	55	08/97->	E7J 634, E7J 635, E7J 780, K7J 700, K7J 701										
Engine	Information				A10	A20	A40	A50	A70	C10 - C30	C20	E01		
Eng. E7J 780	Kangoo Rapid, x 1, Colour:Black, x 1, Colour:Black, D.I.S., connector type, saw teeth, D.I.S., connector type, saw teeth									1.970.376	C10			
Eng. E7J 780	Kangoo Rapid, x 1, Colour:Grey, x 1, Colour:Grey, D.I.S., connector type, saw teeth, D.I.S., connector type, saw teeth									1.970.378	C10			
Eng. E7J 634, E7J 635, K7J 700, K7J 701	x 1, D.I.S. ----- x 1, D.I.S., Kangoo Rapid, x 1, D.I.S.									1.970.596	C10			
Eng. E7J 634, E7J 635, K7J 700, K7J 701													1.499.244	
Eng. E7J 780													1.501.443	
ENGINE														
1.6	Petrol	66	09/99-06/01	K7M 746										
Engine	Information				A10	A20	A40	A50	A70	C10 - C30	C20	E01		
All engines	x 1, D.I.S.									1.970.596	C10			
All engines													1.499.244	
ENGINE														
1.6 16V	Petrol	70	06/01->	K4M 708, K4M 730, K4M 732, K4M 750, K4M 752, K4M 753, K4M 754										
Engine	Information				A10	A20	A40	A50	A70	C10 - C30	C20	E01		
All engines	Kangoo Rapid, x 4, SAGEM, x 4, COIL ON PLUG, SAGEM, COIL ON PLUG									1.970.432	C10			
ENGINE														
1.6 16V 4x4	Petrol	70	02/01->	K4M 708, K4M 750, K4M 752, K4M 753, K4M 754										
Engine	Information				A10	A20	A40	A50	A70	C10 - C30	C20	E01		
Eng. K4M 708, K4M 752, K4M 753	Qty: 4									1.970.432	C10			
Eng. K4M 750, K4M 752, K4M 753, K4M 754	Kangoo Rapid, x 4, SAGEM, x 4, COIL ON PLUG, SAGEM, COIL ON PLUG									1.970.432	C10			
ENGINE														
1.6 16V bivalent	Petrol/ Com- pressed Natural Gas (CNG)	60	06/05->	K4M850CNG										
Engine	Information				A10	A20	A40	A50	A70	C10 - C30	C20	E01		
All engines	Kangoo Rapid, x 4, SAGEM, x 4, COIL ON PLUG, SAGEM, COIL ON PLUG									1.970.432	C10			
ENGINE														
1.6 Flex	Petrol/ Ethanol	72	03/07-12/18	K4M 850										
Engine	Information				A10	A20	A40	A50	A70	C10 - C30	C20	E01		
All engines	x 4, SAGEM, COIL ON PLUG									1.970.432	C10			
KANGOO II														
ENGINE														
1.2 Tce 115	Petrol	84	07/13->	H5F 400, H5F 408, H5F 412										
Engine	Information				A10	A20	A40	A50	A70	C10 - C30	C20	E01		
All engines	x 4, COIL ON PLUG									1.970.613	C10			
ENGINE														
1.6	Petrol	64	02/08->	K7M 750										
Engine	Information				A10	A20	A40	A50	A70	C10 - C30	C20	E01		
All engines	x 1, D.I.S.									1.970.596	C10			
All engines													1.499.252	
ENGINE														
1.6	Petrol	78	02/09-12/12	K4M 830, K4M 831										
Engine	Information				A10	A20	A40	A50	A70	C10 - C30	C20	E01		
All engines	x 4, SAGEM, COIL ON PLUG									1.970.432	C10			
ENGINE														
1.6 16V	Petrol	78	02/08->	K4M 830, K4M 831, K4M 834, K4M 835, K4M 836										
Engine	Information				A10	A20	A40	A50	A70	C10 - C30	C20	E01		
All engines	x 4, SAGEM, COIL ON PLUG									1.970.432	C10			

A10	CONDENSER	A20	CONTACT SET	A40	DISTRIBUTOR CAP	A50	ROTOR	A70	PICK-UP
C10	COIL	C20	IGNITION MODULE	C30	ELECTRONIC IGNITION KIT	E01	IGNITION CABLE SET		

The present application list is a brief version. For the detailed information about the possibility of installation on a specific vehicle, please refer to our web-catalogue <http://catalogo.facet.eu/>

					FUNCTIONS ON THE VEHICLE							
Vehicle	alim.	kW	Date	Engine								
ENGINE												
1.6 16V FLEX	Petrol/ Ethanol	78	02/08->	K4M 834								
Engine	Information				A10	A20	A40	A50	A70	C10 - C30	C20	E01
All engines	x 4, SAGEM, COIL ON PLUG									1.970.432	C10	
ENGINE												
1.6 16V LPG	Petrol/ Liquified Petroleum Gas (LPG)	78	02/08->	K4M 834, K4M 835, K4M 836								
Engine	Information				A10	A20	A40	A50	A70	C10 - C30	C20	E01
All engines	x 4, SAGEM, COIL ON PLUG									1.970.432	C10	
KAPTUR												
ENGINE												
1.6	Petrol	84	03/16->	H4M 429, H4M 438								
Engine	Information				A10	A20	A40	A50	A70	C10 - C30	C20	E01
All engines	x 4, COIL ON PLUG									1.970.613	C10	
ENGINE												
2.0 4WD	Petrol	105	03/16->	F4R 410								
Engine	Information				A10	A20	A40	A50	A70	C10 - C30	C20	E01
All engines	x 4, SAGEM, COIL ON PLUG									1.970.432	C10	
KOLEOS												
ENGINE												
2.0 Tce	Petrol	107	08/16->	M5R 402								
Engine	Information				A10	A20	A40	A50	A70	C10 - C30	C20	E01
All engines	x 4, COIL ON PLUG									1.970.551	C10	
ENGINE												
2.5	Petrol	126	09/08->	2TR 700, 2TR 701, 2TR 703, 2TR 705, 2TR702								
Engine	Information				A10	A20	A40	A50	A70	C10 - C30	C20	E01
Eng. 2TR 700, 2TR 703, 2TR 705, 2TR702	x 4, COIL ON PLUG									1.970.552	C10	
Eng. 2TR 701, 2TR 705	Qty: 4									1.970.552	C10	
ENGINE												
2.5 4x4	Petrol	126	09/08->	2TR 700, 2TR 701, 2TR 703, 2TR 705, 2TR702								
Engine	Information				A10	A20	A40	A50	A70	C10 - C30	C20	E01
Eng. 2TR 700, 2TR 703, 2TR 705, 2TR702	x 4, COIL ON PLUG									1.970.552	C10	
Eng. 2TR 701	Qty: 4									1.970.552	C10	
ENGINE												
2.5 Sce 4WD	Petrol	126	08/16->	2TR707								
Engine	Information				A10	A20	A40	A50	A70	C10 - C30	C20	E01
All engines	x 4, COIL ON PLUG									1.970.552	C10	
LAGUNA I												
ENGINE												
1.6 16V	Petrol	79	11/97-03/01	K4M 720, K4M 724								
Engine	Information				A10	A20	A40	A50	A70	C10 - C30	C20	E01
All engines	Qty: 4									1.970.432	C10	
ENGINE												
1.8	Petrol	66	11/93-03/01	F3P 670, F3P 678, F3P 720, F3P 724								
Engine	Information				A10	A20	A40	A50	A70	C10 - C30	C20	E01
Eng. F3P 678, F3P 720, F3P 724	version Duellier						1.315.085	1.415.097				
Eng. F3P 678, F3P 720, F3P 724	Kit, version Duellier						1.315.086					
Eng. F3P 678, F3P 720, F3P 724										1.970.107	C10	
Eng. F3P 670	02/04/97 ->, Qty: 2									1.970.196	C10	
Eng. F3P 670	->year 02/04/97, Qty: 2									1.970.275	C10	
Eng. F3P 678, F3P 720, F3P 724	->year 02/05/95											1.500.920
Eng. F3P 670	02/04/97 ->											1.501.492
Eng. F3P 678, F3P 720, F3P 724	02/05/95 ->											1.501.499
Eng. F3P 670	->year 02/04/97											1.501.501

A10 CONDENSER	A20 CONTACT SET	A40 DISTRIBUTOR CAP	A50 ROTOR	A70 PICK-UP
C10 COIL	C20 IGNITION MODULE	C30 ELECTRONIC IGNITION KIT	E01 IGNITION CABLE SET	

Vehicle	alim.	kW	Date	Engine	FUNCTIONS ON THE VEHICLE							
					A10	A20	A40	A50	A70	C10 - C30	C20	E01

ENGINE				
1.8	Petrol	69	06/95-03/01	F3P 674, F3P 720, F3P 724

Engine	Information	A10	A20	A40	A50	A70	C10 - C30	C20	E01
Eng. F3P 720, F3P 724	version Ducellier			1.315.085	1.415.097				
Eng. F3P 720, F3P 724	Kit, version Ducellier			1.315.086					
Eng. F3P 720, F3P 724							1.970.107	C10	
Eng. F3P 674	02/04/97 ->, Qty: 2						1.970.196	C10	
Eng. F3P 674	->year 02/04/97, Qty: 2						1.970.275	C10	
Eng. F3P 720, F3P 724	->year 02/05/95								1.500.920
Eng. F3P 674	02/04/97 ->								1.501.492
Eng. F3P 720, F3P 724	02/05/95 ->								1.501.499
Eng. F3P 674	->year 02/04/97								1.501.501

ENGINE				
1.8	Petrol	70	06/95-06/98	F3P 676, F3P 678

Engine	Information	A10	A20	A40	A50	A70	C10 - C30	C20	E01
All engines	02/04/97 ->, Qty: 2						1.970.196	C10	
All engines	->year 02/04/97, Qty: 2						1.970.275	C10	
All engines	02/04/97 ->								1.501.492
All engines	->year 02/04/97								1.501.501

ENGINE				
1.8 16V	Petrol	88	04/98-03/01	F4P 760

Engine	Information	A10	A20	A40	A50	A70	C10 - C30	C20	E01
All engines	Qty: 4						1.970.432	C10	

ENGINE				
2.0	Petrol	102	09/99-02/01	F4R 780

Engine	Information	A10	A20	A40	A50	A70	C10 - C30	C20	E01
All engines	Qty: 4						1.970.432	C10	

ENGINE				
2.0	Petrol	103	06/95-02/01	N7Q 700, N7Q 704

Engine	Information	A10	A20	A40	A50	A70	C10 - C30	C20	E01
All engines	Colour:Black						1.970.355	C10	
All engines	Colour:Grey						1.970.356	C10	
All engines									1.499.061

ENGINE				
2.0	Petrol	70	11/93-03/01	--, F3R 769

Engine	Information	A10	A20	A40	A50	A70	C10 - C30	C20	E01
Eng. --	02/04/97 ->, Qty: 2						1.970.196	C10	
Eng. --	->year 02/04/97, Qty: 2						1.970.275	C10	
All engines	02/04/97 ->								1.501.492
All engines	->year 02/04/97								1.501.501

ENGINE				
2.0	Petrol	80	03/99-03/01	F3R 611

Engine	Information	A10	A20	A40	A50	A70	C10 - C30	C20	E01
All engines	02/04/97 ->, Qty: 2						1.970.196	C10	
All engines	->year 02/04/97, Qty: 2						1.970.275	C10	
All engines									1.501.492

ENGINE				
2.0	Petrol	83	11/93-03/01	6Z7U 730, F3R 722, F3R 729

Engine	Information	A10	A20	A40	A50	A70	C10 - C30	C20	E01
Eng. 6Z7U 730, F3R 722	version Ducellier			1.315.085	1.415.097				
Eng. 6Z7U 730, F3R 722	Kit, version Ducellier			1.315.086					
Eng. 6Z7U 730, F3R 722							1.970.107	C10	
Eng. F3R 729	02/04/97 ->, Qty: 2						1.970.196	C10	
Eng. F3R 729	->year 02/04/97, Qty: 2						1.970.275	C10	
Eng. 6Z7U 730, F3R 722	->year 02/05/95								1.500.920
Eng. F3R 729	02/04/97 ->								1.501.492
Eng. 6Z7U 730, F3R 722	02/05/95 ->								1.501.499
Eng. F3R 729	->year 02/04/97								1.501.501

A10 CONDENSER	A20 CONTACT SET	A40 DISTRIBUTOR CAP	A50 ROTOR	A70 PICK-UP
C10 COIL	C20 IGNITION MODULE	C30 ELECTRONIC IGNITION KIT	E01 IGNITION CABLE SET	

The present application list is a brief version. For the detailed information about the possibility of installation on a specific vehicle, please refer to our web-catalogue <http://catalogo.facet.eu/>

Vehicle	alim.	kW	Date	Engine	FUNCTIONS ON THE VEHICLE							
					A10	A20	A40	A50	A70	C10 - C30	C20	E01

ENGINE				
2.0	Petrol	84	06/95-02/01	F3R 722, F3R 728, F3R 768

Engine	Information	A10	A20	A40	A50	A70	C10 - C30	C20	E01
Eng. F3R 722	version Ducellier			1.315.085	1.415.097				
Eng. F3R 722	Kit, version Ducellier			1.315.086					
Eng. F3R 722							1.970.107	C10	
Eng. F3R 728, F3R 768	02/04/97 ->, Qty: 2						1.970.196	C10	
Eng. F3R 728, F3R 768	->year 02/04/97, Qty: 2						1.970.275	C10	
Eng. F3R 722	->year 02/05/95								1.500.920
Eng. F3R 728, F3R 768	02/04/97 ->								1.501.492
Eng. F3R 722	02/05/95 ->								1.501.499
Eng. F3R 728, F3R 768	->year 02/04/97								1.501.501

ENGINE				
2.0 16V	Petrol	102	06/95-03/01	N7Q 700, N7Q 704

Engine	Information	A10	A20	A40	A50	A70	C10 - C30	C20	E01
All engines	Colour:Black						1.970.355	C10	
All engines	Colour:Grey						1.970.356	C10	
All engines									1.499.061

ENGINE				
2.0 16V	Petrol	103	09/99-03/01	F4R 780

Engine	Information	A10	A20	A40	A50	A70	C10 - C30	C20	E01
All engines	Qty: 4						1.970.432	C10	

ENGINE				
3.0	Petrol	123	11/93-03/01	Z7X 760, Z7X 765

Engine	Information	A10	A20	A40	A50	A70	C10 - C30	C20	E01
All engines	info A-K						1.970.275	C10	
All engines	info B-K						1.970.276	C10	

LAGUNA II

ENGINE				
1.6	Petrol	76	03/01-10/05	K4M 710

Engine	Information	A10	A20	A40	A50	A70	C10 - C30	C20	E01
All engines	x 4, SAGEM, COIL ON PLUG						1.970.432	C10	

ENGINE				
1.6 16V	Petrol	79	03/01-12/07	K4M 710, K4M 714

Engine	Information	A10	A20	A40	A50	A70	C10 - C30	C20	E01
Eng. K4M 710	x 4, SAGEM, COIL ON PLUG						1.970.432	C10	
Eng. K4M 714	Qty: 4						1.970.432	C10	

ENGINE				
1.6 16V	Petrol	82	02/05-08/07	K4M 716

Engine	Information	A10	A20	A40	A50	A70	C10 - C30	C20	E01
All engines	x 4, SAGEM, COIL ON PLUG						1.970.432	C10	

ENGINE				
1.6 Bifuel	Petrol/ Liquified Petro- leum Gas (LPG)	79	06/05-12/07	K4M 714

Engine	Information	A10	A20	A40	A50	A70	C10 - C30	C20	E01
All engines	x 4, SAGEM, COIL ON PLUG						1.970.432	C10	

ENGINE				
1.6 LPG	Bi-Fuel	79	03/01-05/05	K4M 714

Engine	Information	A10	A20	A40	A50	A70	C10 - C30	C20	E01
All engines	Qty: 4						1.970.432	C10	
All engines	x 4, SAGEM, COIL ON PLUG						1.970.432	C10	

ENGINE				
1.8 16V	Petrol	85	03/01-12/07	F4P 770, F4P 771, F4P 773, F4P 774, F4P 775

Engine	Information	A10	A20	A40	A50	A70	C10 - C30	C20	E01
Eng. F4P 770	Qty: 4						1.970.432	C10	
Eng. F4P 771, F4P 773, F4P 774, F4P 775	x 4, SAGEM, COIL ON PLUG						1.970.432	C10	

A10	CONDENSER	A20	CONTACT SET	A40	DISTRIBUTOR CAP	A50	ROTOR	A70	PICK-UP
C10	COIL	C20	IGNITION MODULE	C30	ELECTRONIC IGNITION KIT	E01	IGNITION CABLE SET		

Vehicle	alim.	kW	Date	Engine	FUNCTIONS ON THE VEHICLE									
					A10	A20	A40	A50	A70	C10 - C30	C20	E01		
ENGINE														
1.8 16V	Petrol	86	03/01-05/05	F4P 770, F4P 774										
Engine	Information				A10	A20	A40	A50	A70	C10 - C30	C20	E01		
Eng. F4P 770	Qty: 4									1.970.432	C10			
Eng. F4P 774	x 4, SAGEM, COIL ON PLUG									1.970.432	C10			
ENGINE														
1.8 16V	Petrol	88	03/01->	F4P 770, F4P 772										
Engine	Information				A10	A20	A40	A50	A70	C10 - C30	C20	E01		
Eng. F4P 770	x 4, SAGEM, COIL ON PLUG									1.970.432	C10			
Eng. F4P 772	Qty: 4									1.970.432	C10			
ENGINE														
1.8 16V	Petrol	89	03/01-05/05	F4P 770, F4P 772, F4P 774										
Engine	Information				A10	A20	A40	A50	A70	C10 - C30	C20	E01		
Eng. F4P 770, F4P 772	x 4, SAGEM, COIL ON PLUG									1.970.432	C10			
Eng. F4P 774	Qty: 4									1.970.432	C10			
ENGINE														
2.0 16V	LPG	95	09/02-05/05	F4R 713										
Engine	Information				A10	A20	A40	A50	A70	C10 - C30	C20	E01		
All engines	Qty: 4									1.970.432	C10			
ENGINE														
2.0 16V	LPG	97	09/02-05/05	F4R 713										
Engine	Information				A10	A20	A40	A50	A70	C10 - C30	C20	E01		
All engines	Qty: 4									1.970.432	C10			
ENGINE														
2.0 16V	Petrol	125	01/05-09/07	F4R 784, F4R 786, F4R 787										
Engine	Information				A10	A20	A40	A50	A70	C10 - C30	C20	E01		
All engines	x 4, SAGEM, COIL ON PLUG									1.970.432	C10			
ENGINE														
2.0 16V	Petrol	150	01/05-09/07	F4R 886, F4R 887										
Engine	Information				A10	A20	A40	A50	A70	C10 - C30	C20	E01		
All engines	x 4, SAGEM, COIL ON PLUG									1.970.432	C10			
ENGINE														
2.0 16V	Petrol	98	08/02-09/07	F4R 712, F4R 713, F4R 714, F4R 715										
Engine	Information				A10	A20	A40	A50	A70	C10 - C30	C20	E01		
All engines	x 4, SAGEM, COIL ON PLUG									1.970.432	C10			
ENGINE														
2.0 16V	Petrol	99	08/02-12/07	F4R 712, F4R 713, F4R 714, F4R 715										
Engine	Information				A10	A20	A40	A50	A70	C10 - C30	C20	E01		
All engines	x 4, SAGEM, COIL ON PLUG									1.970.432	C10			
ENGINE														
2.0 16V IDE	Petrol	103	04/01-09/07	F5R 700, F5R 701										
Engine	Information				A10	A20	A40	A50	A70	C10 - C30	C20	E01		
All engines	x 1, D.I.S.									1.970.365	C10			
Eng. F5R 700													1.499.049	
ENGINE														
2.0 16V Turbo	Petrol	120	01/03-08/05	F4R 764, F4R 765, F4R 786, F4R 787										
Engine	Information				A10	A20	A40	A50	A70	C10 - C30	C20	E01		
Eng. F4R 764, F4R 765	x 4, SAGEM, COIL ON PLUG									1.970.432	C10			
Eng. F4R 786, F4R 787	Qty: 4									1.970.432	C10			
LAGUNA III														
ENGINE														
1.6 16V	Petrol	81	10/07-12/15	K4M 824										
Engine	Information				A10	A20	A40	A50	A70	C10 - C30	C20	E01		
All engines	x 4, SAGEM, COIL ON PLUG									1.970.432	C10			
ENGINE														
2.0 16V	Petrol	103	10/07-12/15	M4R 704										
Engine	Information				A10	A20	A40	A50	A70	C10 - C30	C20	E01		
All engines	x 4, COIL ON PLUG									1.970.489	C10			
A10	CONDENSER		A20	CONTACT SET		A40	DISTRIBUTOR CAP		A50	ROTOR		A70	PICK-UP	
C10	COIL		C20	IGNITION MODULE		C30	ELECTRONIC IGNITION KIT		E01	IGNITION CABLE SET				

					FUNCTIONS ON THE VEHICLE							
Vehicle	alim.	kW	Date	Engine	A10	A20	A40	A50	A70	C10 - C30	C20	E01
ENGINE												
2.0 16V Hi-Flex	Petrol/ Ethanol	103	10/07-12/15	M4R 704, M4R 726								
Engine	Information			A10	A20	A40	A50	A70	C10 - C30	C20	E01	
Eng. M4R 704	Qty: 4								1.970.489	C10		
Eng. M4R 726	BT05/BT0F/BT0W, x 4, COIL ON PLUG								1.970.489	C10		
ENGINE												
2.0 16V Turbo	Petrol	125	10/07-12/15	F4R 811, F4R 813								
Engine	Information			A10	A20	A40	A50	A70	C10 - C30	C20	E01	
All engines	x 4, SAGEM, COIL ON PLUG								1.970.432	C10		
ENGINE												
2.0 GT	Petrol	150	03/08-12/15	F4R 800, F4R802								
Engine	Information			A10	A20	A40	A50	A70	C10 - C30	C20	E01	
All engines	x 4, SAGEM, COIL ON PLUG								1.970.432	C10		
ENGINE												
3.5 V6	Petrol	175	04/08-12/15	8TZ150XSG15, V4Y713								
Engine	Information			A10	A20	A40	A50	A70	C10 - C30	C20	E01	
All engines	x 6, COIL ON PLUG								1.970.533	C10		
LATITUDE												
ENGINE												
1.6 RS	Petrol	132	04/14->	M5M 400								
Engine	Information			A10	A20	A40	A50	A70	C10 - C30	C20	E01	
All engines	x 4, COIL ON PLUG								1.970.551	C10		
ENGINE												
2.5 V6	Petrol	130	05/11->	2ZV 604								
Engine	Information			A10	A20	A40	A50	A70	C10 - C30	C20	E01	
All engines	x 6, COIL ON PLUG								1.970.533	C10		
ENGINE												
3.5	Petrol	171	05/11->	5ZV 604								
Engine	Information			A10	A20	A40	A50	A70	C10 - C30	C20	E01	
All engines	Qty: 6								1.970.533	C10		
LODGY												
ENGINE												
1.6	Petrol	59	07/13->	K7M 812, K7M828								
Engine	Information			A10	A20	A40	A50	A70	C10 - C30	C20	E01	
All engines	x 1, D.I.S.								1.970.596	C10		
LOGAN												
ENGINE												
1.2 16V	Petrol	54	12/13->	D4F 732, D4F 734								
Engine	Information			A10	A20	A40	A50	A70	C10 - C30	C20	E01	
All engines	x 1, D.I.S.								1.970.518	C10		
ENGINE												
1.2 16V	Petrol	55	02/06->	D4F 732								
Engine	Information			A10	A20	A40	A50	A70	C10 - C30	C20	E01	
All engines									1.970.518	C10		1.499.246
ENGINE												
1.2 16V LPG	Petrol/ Liquified Petro- leum Gas (LPG)	53	12/13->	D4F 732, D4F 734								
Engine	Information			A10	A20	A40	A50	A70	C10 - C30	C20	E01	
All engines	x 1, D.I.S.								1.970.518	C10		
ENGINE												
1.4	Petrol	55	09/04->	K7J 710								
Engine	Information			A10	A20	A40	A50	A70	C10 - C30	C20	E01	
All engines	x 1, D.I.S.								1.970.596	C10		
All engines	->year 18/03/05											1.499.244
All engines												1.499.252
All engines	18/03/05 ->											1.499.252

A10 CONDENSER	A20 CONTACT SET	A40 DISTRIBUTOR CAP	A50 ROTOR	A70 PICK-UP
C10 COIL	C20 IGNITION MODULE	C30 ELECTRONIC IGNITION KIT	E01 IGNITION CABLE SET	

Vehicle	alim.	kW	Date	Engine	FUNCTIONS ON THE VEHICLE									
					A10	A20	A40	A50	A70	C10 - C30	C20	E01		
ENGINE														
1.4 LPG	Petrol/ Liquified Petro- leum Gas (LPG)	53	02/08-10/13	K7J 714										
Engine		Information			A10	A20	A40	A50	A70	C10 - C30	C20	E01		
All engines		x 1, D.I.S.								1.970.596	C10			
ENGINE														
1.6	Petrol	59	12/13->	K7M 812										
Engine		Information			A10	A20	A40	A50	A70	C10 - C30	C20	E01		
All engines		x 1, D.I.S.								1.970.596	C10			
ENGINE														
1.6	Petrol	64	09/04->	K7M 710										
Engine		Information			A10	A20	A40	A50	A70	C10 - C30	C20	E01		
All engines		x 1, D.I.S.								1.970.596	C10			
All engines		->year 18/03/05											1.499.244	
All engines		18/03/05 ->											1.499.252	
All engines		18/03/05 ->											1.499.252	
ENGINE														
1.6	Petrol	65	09/04->	K7M 714										
Engine		Information			A10	A20	A40	A50	A70	C10 - C30	C20	E01		
All engines		x 1, D.I.S.								1.970.596	C10		1.499.252	
ENGINE														
1.6	Petrol	77	04/07->	K4M 690, K4M 694, K4M 696, K4M 697										
Engine		Information			A10	A20	A40	A50	A70	C10 - C30	C20	E01		
All engines		x 4, SAGEM, COIL ON PLUG								1.970.432	C10			
ENGINE														
1.6	Petrol	78	12/13->	K4M 845										
Engine		Information			A10	A20	A40	A50	A70	C10 - C30	C20	E01		
All engines		x 4, SAGEM, COIL ON PLUG								1.970.432	C10			
ENGINE														
1.6 16V	Petrol	77	12/05->	K4M 694, K4M 696										
Engine		Information			A10	A20	A40	A50	A70	C10 - C30	C20	E01		
All engines		Qty: 4								1.970.432	C10			
LOGAN EXPRESS														
ENGINE														
1.6	Petrol	64	04/07->	K7M 710										
Engine		Information			A10	A20	A40	A50	A70	C10 - C30	C20	E01		
All engines		x 1, D.I.S.								1.970.596	C10			
LOGAN/STEPWAY														
ENGINE														
1.2	Petrol	55	11/13->	D4F 732, D4F 734										
Engine		Information			A10	A20	A40	A50	A70	C10 - C30	C20	E01		
All engines		x 1, D.I.S.								1.970.518	C10			
ENGINE														
1.2 16V LPG	Petrol/ Liquified Petro- leum Gas (LPG)	53	11/13->	D4F 732, D4F 734										
Engine		Information			A10	A20	A40	A50	A70	C10 - C30	C20	E01		
All engines		x 1, D.I.S.								1.970.518	C10			
ENGINE														
1.6	Petrol	59	11/13->	K7M 812										
Engine		Information			A10	A20	A40	A50	A70	C10 - C30	C20	E01		
All engines		x 1, D.I.S.								1.970.596	C10			
ENGINE														
1.6	Petrol	60	04/14->	K7M 812										
Engine		Information			A10	A20	A40	A50	A70	C10 - C30	C20	E01		
All engines		x 1, D.I.S. ----- L8JB/L8ME/L8MV, x 1, D.I.S.								1.970.596	C10			









A10	CONDENSER	A20	CONTACT SET	A40	DISTRIBUTOR CAP	A50	ROTOR	A70	PICK-UP
C10	COIL	C20	IGNITION MODULE	C30	ELECTRONIC IGNITION KIT	E01	IGNITION CABLE SET		

The present application list is a brief version. For the detailed information about the possibility of installation on a specific vehicle, please refer to our web-catalogue <http://catalogo.facet.eu/>

Vehicle	alim.	kW	Date	Engine	FUNCTIONS ON THE VEHICLE									
					A10	A20	A40	A50	A70	C10 - C30	C20	E01		
ENGINE														
1.6 BiFuel	Petrol/ Liquified Petro- leum Gas (LPG)	79	04/01-07/03	K4M 712										
Engine	Information				A10	A20	A40	A50	A70	C10 - C30	C20	E01		
All engines	x 4, SAGEM, COIL ON PLUG									1.970.432	C10			
ENGINE														
1.6 BiFuel	Petrol/ Liquified Petro- leum Gas (LPG)	80	04/01-07/03	K4M 704										
Engine	Information				A10	A20	A40	A50	A70	C10 - C30	C20	E01		
All engines	x 4, SAGEM, COIL ON PLUG									1.970.432	C10			
ENGINE														
1.8	Petrol	85	04/01-07/03	F4P 722										
Engine	Information				A10	A20	A40	A50	A70	C10 - C30	C20	E01		
All engines	x 4, SAGEM, COIL ON PLUG									1.970.432	C10			
ENGINE														
2.0	Petrol	55	08/95-02/99	F4R 740, F4R 746										
Engine	Information				A10	A20	A40	A50	A70	C10 - C30	C20	E01		
All engines	x 4, SAGEM, COIL ON PLUG									1.970.432	C10			
MEGANE CC														
ENGINE														
1.2 TcE	Petrol	85	09/12-08/15	H5F 400										
Engine	Information				A10	A20	A40	A50	A70	C10 - C30	C20	E01		
All engines	x 4, COIL ON PLUG									1.970.613	C10			
ENGINE														
1.2 TcE	Petrol	97	01/13->	H5F 404										
Engine	Information				A10	A20	A40	A50	A70	C10 - C30	C20	E01		
All engines	x 4, COIL ON PLUG									1.970.613	C10			
ENGINE														
1.6 16V	Petrol	81	06/10->	K4M 858										
Engine	Information				A10	A20	A40	A50	A70	C10 - C30	C20	E01		
All engines	x 4, SAGEM, COIL ON PLUG									1.970.432	C10			
ENGINE														
1.6 16V Hi-Flex	Petrol/ Ethanol	81	06/10->	K4M 866										
Engine	Information				A10	A20	A40	A50	A70	C10 - C30	C20	E01		
All engines	x 4, SAGEM, COIL ON PLUG									1.970.432	C10			
ENGINE														
2.0 TcE	Petrol	132	06/10->	8XTDM10, F4R 872										
Engine	Information				A10	A20	A40	A50	A70	C10 - C30	C20	E01		
Eng. 8XTDM10	Qty: 4									1.970.432	C10			
Eng. F4R 872	x 4, SAGEM, COIL ON PLUG									1.970.432	C10			
ENGINE														
2.0 Turbo	Petrol	195	10/11->	8AR90212										
Engine	Information				A10	A20	A40	A50	A70	C10 - C30	C20	E01		
All engines	Qty: 4									1.970.432	C10			
MEGANE I														
ENGINE														
1.4	Petrol	55	09/96-08/03	E7J 626, E7J 764										
Engine	Information				A10	A20	A40	A50	A70	C10 - C30	C20	E01		
Eng. E7J 764	version Duellier						1.315.081	1.415.101						
Eng. E7J 764	version Marelli						1.330.111	1.430.059						
Eng. E7J 764	x 1, SIEMENS, DISTRIBUTOR, Dia: 4 mm, connector type SAE									1.970.107	C10			
Eng. E7J 626	x 1, D.I.S.									1.970.596	C10			
Eng. E7J 626													1.499.244	
Eng. E7J 764													1.500.801	

A10	CONDENSER	A20	CONTACT SET	A40	DISTRIBUTOR CAP	A50	ROTOR	A70	PICK-UP
C10	COIL	C20	IGNITION MODULE	C30	ELECTRONIC IGNITION KIT	E01	IGNITION CABLE SET		

The present application list is a brief version. For the detailed information about the possibility of installation on a specific vehicle, please refer to our web-catalogue <http://catalogo.facet.eu/>

					FUNCTIONS ON THE VEHICLE							
Vehicle	alim.	kW	Date	Engine	 A10	 A20	 A40	 A50	 A70	 C10 - C30	 C20	 E01
ENGINE												
1.4 16V	Petrol	70	03/99-08/03	K4J 700, K4J 714, K4J750								
ENGINE												
All engines					A10	A20	A40	A50	A70	C10 - C30	C20	E01
Information					x 4, SAGEM, COIL ON PLUG							
1.4 16V	Petrol	71	05/99-11/02	K4J 710, K4J 711, K4J 712, K4J 713								
ENGINE												
All engines					A10	A20	A40	A50	A70	C10 - C30	C20	E01
Information					Qty: 4							
1.4 16V	Petrol	72	11/00-08/03	K4J 732								
ENGINE												
All engines					A10	A20	A40	A50	A70	C10 - C30	C20	E01
Information					Qty: 4							
1.4 e	Petrol	55	01/96-08/03	E7J 626, E7J 764								
ENGINE												
Eng. E7J 764					A10	A20	A40	A50	A70	C10 - C30	C20	E01
Information					version Ducellier							
Eng. E7J 764							1.315.081	1.415.101				
Information					version Marelli							
Eng. E7J 764							1.330.111	1.430.059				
Information					x 1, ignition mod. IGN. MODULE(-), SIEMENS, DISTRIBUTOR, Dia: 4 mm, connector type SAE							
Eng. E7J 626										1.970.107	C10	
Information					x 1, D.I.S., x 1, ignition mod. IGN. MODULE(-), D.I.S.							
Eng. E7J 626										1.970.596	C10	
Eng. E7J 764												1.499.244
Eng. E7J 764												1.500.801
1.4 Eco	Petrol	52	01/96-03/99	E7J 624								
ENGINE												
All engines					A10	A20	A40	A50	A70	C10 - C30	C20	E01
Information					version Ducellier							
All engines							1.315.081	1.415.101				
Information					version Marelli							
All engines							1.330.111	1.430.059				
Information					x 1, ignition mod. IGN. MODULE(-), SIEMENS, DISTRIBUTOR, Dia: 4 mm, connector type SAE							
All engines										1.970.107	C10	
All engines												1.500.801
1.6	Petrol	64	02/00-09/00	K7M 704								
ENGINE												
All engines					A10	A20	A40	A50	A70	C10 - C30	C20	E01
Information					x 1, D.I.S.							
All engines										1.970.596	C10	1.499.244
All engines										1.970.596	C10	
1.6 16V	Petrol	0	11/97->	K4M 743								
ENGINE												
All engines					A10	A20	A40	A50	A70	C10 - C30	C20	E01
Information					Qty: 4							
All engines										1.970.432	C10	
1.6 16V	Petrol	66	11/97->	K4M 734, K4M 740, K4M 742, K4M 744, K4M 745								
ENGINE												
All engines					A10	A20	A40	A50	A70	C10 - C30	C20	E01
Information					Qty: 4							
All engines										1.970.432	C10	
1.6 16V	Petrol	70	06/01->	K4M 750, K4M 752, K4M 753								
ENGINE												
All engines					A10	A20	A40	A50	A70	C10 - C30	C20	E01
Information					Qty: 4							
All engines										1.970.432	C10	
1.6 16V	Petrol	79	11/97->	K4M 701, K4M 704, K4M 706, K4M 708, K4M 709, K4M 710, K4M 712, K4M 714, K4M 720, K4M 724, K4M 724, K4M 730, K4M 748, K4M700								
ENGINE												
Eng. K4M 701, K4M 706, K4M 708, K4M 709, K4M700					A10	A20	A40	A50	A70	C10 - C30	C20	E01
Information					x 4, SAGEM, COIL ON PLUG							
Eng. K4M 704, K4M 706, K4M 709, K4M 710, K4M 712, K4M 714, K4M 720, K4M 724, K4M 730, K4M 748										1.970.432	C10	
Information					Qty: 4							
All engines										1.970.432	C10	









A10 CONDENSER	A20 CONTACT SET	A40 DISTRIBUTOR CAP	A50 ROTOR	A70 PICK-UP
C10 COIL	C20 IGNITION MODULE	C30 ELECTRONIC IGNITION KIT	E01 IGNITION CABLE SET	

Vehicle	alim.	kW	Date	Engine	FUNCTIONS ON THE VEHICLE									
					A10	A20	A40	A50	A70	C10 - C30	C20	E01		
ENGINE														
1.6 16V	Petrol	83	11/00->	K4M 761, K4M 764										
ENGINE														
All engines					Qty: 4						1.970.432	C10		
ENGINE														
1.6 Bifuel	Petrol/ Liquified Petro- leum Gas (LPG)	80	03/99-09/00	K4M 712										
ENGINE														
All engines					x 4, SAGEM, COIL ON PLUG						1.970.432	C10		
ENGINE														
1.6 e	Petrol	66	01/96-08/03	K7M 702, K7M 703, K7M 790										
ENGINE														
All engines					->year 10/03/97, Colour:Black						1.970.355	C10		
Eng. K7M 702, K7M 703					->year 01/03/97, x 1, Colour:Black, D.I.S.						1.970.355	C10		
All engines					->year 10/03/97, Colour:Grey						1.970.356	C10		
Eng. K7M 702, K7M 703					->year 01/03/97, x 1, Colour:Grey, D.I.S.						1.970.356	C10		
All engines					->year 08/07/98, 10/03/97 ->, Colour:Black						1.970.376	C10		
Eng. K7M 702, K7M 703					01/04/97 ->, ->year 01/06/98, x 1, Colour:Black, D.I.S., connector type, saw teeth						1.970.376	C10		
All engines					->year 08/07/98, 10/03/97 ->, Colour:Grey						1.970.378	C10		
Eng. K7M 702, K7M 703					01/04/97 ->, ->year 01/06/98, x 1, Colour:Grey, D.I.S., connector type, saw teeth						1.970.378	C10		
All engines					08/07/98 ->						1.970.596	C10		
Eng. K7M 702, K7M 703					01/07/98 ->, x 1, D.I.S., x 1, D.I.S.						1.970.596	C10		
Eng. K7M 702, K7M 703					08/07/98 ->									1.499.244
Eng. K7M 702, K7M 703					->year 08/07/98, 10/03/97 ->									1.501.443
All engines					->year 10/03/97									1.501.446
ENGINE														
1.6 i	Petrol	55	01/96-03/99	K7M 720, K7M 790										
ENGINE														
All engines					->year 01/03/97, x 1, Colour:Black, x 1, Colour:Black, D.I.S., D.I.S.						1.970.355	C10		
All engines					->year 01/03/97, x 1, Colour:Grey, x 1, Colour:Grey, D.I.S., D.I.S.						1.970.356	C10		
Eng. K7M 720					01/04/97 ->, ->year 01/06/98, x 1, Colour:Black, D.I.S., connector type, saw teeth						1.970.376	C10		
Eng. K7M 720					01/04/97 ->, ->year 01/06/98, x 1, Colour:Grey, D.I.S., connector type, saw teeth						1.970.378	C10		
Eng. K7M 720					01/07/98 ->, x 1, D.I.S.						1.970.596	C10		
Eng. K7M 720					08/07/98 ->									1.499.244
Eng. K7M 720					->year 08/07/98, 10/03/97 ->									1.501.443
Eng. K7M 720					->year 10/03/97									1.501.446
ENGINE														
1.6 LPG	Petrol/ Liquified Petro- leum Gas (LPG)	66	08/95-03/99	K7M 702										
ENGINE														
All engines					->year 01/03/97, x 1, Colour:Black, D.I.S.						1.970.355	C10		
All engines					->year 01/03/97, x 1, Colour:Grey, D.I.S.						1.970.356	C10		
All engines					01/04/97 ->, ->year 01/06/98, x 1, Colour:Black, D.I.S., connector type, saw teeth						1.970.376	C10		
All engines					01/04/97 ->, ->year 01/06/98, x 1, Colour:Grey, D.I.S., connector type, saw teeth						1.970.378	C10		
All engines					01/07/98 ->, x 1, D.I.S.						1.970.596	C10		
ENGINE														
1.6 LPG	Petrol/ Liquified Petro- leum Gas (LPG)	80	10/00-08/02	K4M 704, K4M 712										
ENGINE														
All engines					x 4, SAGEM, COIL ON PLUG						1.970.432	C10		
A10	CONDENSER		A20	CONTACT SET		A40	DISTRIBUTOR CAP		A50	ROTOR		A70	PICK-UP	
C10	COIL		C20	IGNITION MODULE		C30	ELECTRONIC IGNITION KIT		E01	IGNITION CABLE SET				

					FUNCTIONS ON THE VEHICLE							
Vehicle	alim.	kW	Date	Engine	A10	A20	A40	A50	A70	C10 - C30	C20	E01
ENGINE												
1.8 16V	Petrol	85	01/99-08/03	F4P 720, F4P 722, F4P 772, F4P 774, F4P 775								
Engine	Information				A10	A20	A40	A50	A70	C10 - C30	C20	E01
Eng. F4P 720, F4P 722	x 4, SAGEM, COIL ON PLUG									1.970.432	C10	
Eng. F4P 772, F4P 774, F4P 775	Qty: 4									1.970.432	C10	
ENGINE												
1.8 16V	Petrol	88	07/00-10/02	F4P 760, F4P 770								
Engine	Information				A10	A20	A40	A50	A70	C10 - C30	C20	E01
All engines	Qty: 4									1.970.432	C10	
ENGINE												
1.8 16V	Petrol	89	01/99-11/02	F4P 771								
Engine	Information				A10	A20	A40	A50	A70	C10 - C30	C20	E01
All engines	Qty: 4									1.970.432	C10	
ENGINE												
2.0	Petrol	0	01/97-02/99	F3R 262, F3R 264								
Engine	Information				A10	A20	A40	A50	A70	C10 - C30	C20	E01
All engines	02/04/97 ->, Qty: 2									1.970.196	C10	
All engines	->year 02/04/97, Qty: 2									1.970.275	C10	
All engines												1.501.501
ENGINE												
2.0	Petrol	84	04/97-08/03	F3R 750, F3R 791, F3R 796								
Engine	Information				A10	A20	A40	A50	A70	C10 - C30	C20	E01
Eng. F3R 750	02/04/97 ->, Qty: 2									1.970.196	C10	
Eng. F3R 791	x 1, D.I.S., connector type, saw teeth									1.970.196	C10	
Eng. F3R 750	->year 02/04/97, Qty: 2									1.970.275	C10	
Eng. F3R 796	x 1, D.I.S.									1.970.275	C10	
Eng. F3R 750	02/04/97 ->											1.501.492
Eng. F3R 750	->year 02/04/97											1.501.501
ENGINE												
2.0	Petrol	85	05/98-05/01	F3R 750, F3R 751, F3R 752, F3R 791, F3R 796, F3R 797, F3R 798								
Engine	Information				A10	A20	A40	A50	A70	C10 - C30	C20	E01
Eng. F3R 791	x 1, D.I.S., connector type, saw teeth									1.970.196	C10	
Eng. F3R 750, F3R 751, F3R 752, F3R 796, F3R 797, F3R 798	->year 01/04/97, x 1, D.I.S., x 1, D.I.S.									1.970.275	C10	
All engines	02/04/97 ->											1.501.492
Eng. F3R 750, F3R 751, F3R 752, F3R 791, F3R 797, F3R 798	->year 02/04/97											1.501.501
ENGINE												
2.0 16V	Petrol	0	01/99-11/02	F4R 276, F4R 712, F4R 713, F4R 790, F4R 794, F4R 795								
Engine	Information				A10	A20	A40	A50	A70	C10 - C30	C20	E01
All engines	Qty: 4									1.970.432	C10	
ENGINE												
2.0 16V	Petrol	102	01/02-08/03	F4R 746, F4R 770, F5R 740								
Engine	Information				A10	A20	A40	A50	A70	C10 - C30	C20	E01
Eng. F4R 746	x 1, D.I.S.									1.970.365	C10	
Eng. F4R 746, F4R 770	Qty: 4									1.970.432	C10	
Eng. F5R 740	->year 01/10/00, x 1, D.I.S.									1.970.596	C10	
ENGINE												
2.0 16V	Petrol	103	09/99->	F4R 700, F4R 701, F4R 746, F4R 780								
Engine	Information				A10	A20	A40	A50	A70	C10 - C30	C20	E01
All engines	Qty: 4									1.970.432	C10	
ENGINE												
2.0 16V	Petrol	120	07/99->	F4R 760, F4R 761, F4R 762, F4R 763, F4R 767								
Engine	Information				A10	A20	A40	A50	A70	C10 - C30	C20	E01
All engines	Qty: 4									1.970.432	C10	









A10 CONDENSER	A20 CONTACT SET	A40 DISTRIBUTOR CAP	A50 ROTOR	A70 PICK-UP
C10 COIL	C20 IGNITION MODULE	C30 ELECTRONIC IGNITION KIT	E01 IGNITION CABLE SET	

Vehicle	alim.	kW	Date	Engine	FUNCTIONS ON THE VEHICLE									
					A10	A20	A40	A50	A70	C10 - C30	C20	E01		
2.0 16V	Petrol	124	05/00->	ENGINE F4R 730, F4R 732, F4R 736										
Engine	Information				A10	A20	A40	A50	A70	C10 - C30	C20	E01		
All engines	Qty: 4									1.970.432	C10			
2.0 16V	Petrol	88	05/00->	ENGINE F4R 720										
Engine	Information				A10	A20	A40	A50	A70	C10 - C30	C20	E01		
All engines	Qty: 4									1.970.432	C10			
2.0 16V	Petrol	99	11/00->	ENGINE F4R 771										
Engine	Information				A10	A20	A40	A50	A70	C10 - C30	C20	E01		
All engines	Qty: 4									1.970.432	C10			
2.0 16V IDE	Petrol	103	11/99-08/03	ENGINE F4R 746, F5R 740										
Engine	Information				A10	A20	A40	A50	A70	C10 - C30	C20	E01		
All engines	01/11/00 ->, x 1, D.I.S.									1.970.365	C10			
All engines	->year 01/10/00, x 1, D.I.S.									1.970.596	C10			
Eng. F5R 740													1.499.049	
2.0 i	Petrol	80	03/99-08/03	ENGINE F3R 750, F3R 751, F3R 752, F3R 791, F3R 796, F3R 797, F3R 798										
Engine	Information				A10	A20	A40	A50	A70	C10 - C30	C20	E01		
All engines	->eng. C017557, -eng. F3R752, x 1, D.I.S., x 1, connector type, saw teeth, D.I.S., connector type, saw teeth									1.970.196	C10			
All engines	eng. type I009203 ->, x 1, D.I.S.									1.970.275	C10			
All engines	02/04/97 ->											1.501.492		
Eng. F3R 750, F3R 751, F3R 752, F3R 791, F3R 797, F3R 798	->year 02/04/97												1.501.501	
2.0 i	Petrol	84	01/96-08/03	ENGINE F3R 750, F3R 751, F3R 752, F3R 791, F3R 796, F3R 797, F3R 798										
Engine	Information				A10	A20	A40	A50	A70	C10 - C30	C20	E01		
Eng. F3R 750, F3R 751, F3R 791, F3R 796, F3R 797, F3R 798	01/04/97 ->, 01/05/97 ->, x 1, D.I.S., connector type, saw teeth, x 1, D.I.S., connector type, saw teeth									1.970.196	C10			
Eng. F3R 750, F3R 751, F3R 752, F3R 796, F3R 797, F3R 798	->year 01/03/97, ->year 01/04/97, x 1, D.I.S., x 1, D.I.S.									1.970.275	C10			
All engines	02/04/97 ->											1.501.492		
Eng. F3R 750, F3R 751, F3R 752, F3R 791, F3R 797, F3R 798	->year 02/04/97												1.501.501	
2.0 RT	Petrol	103	03/01-08/03	ENGINE F4R 740, F4R 741, F4R 746, F4R 747										
Engine	Information				A10	A20	A40	A50	A70	C10 - C30	C20	E01		
All engines	x 4, SAGEM, COIL ON PLUG									1.970.432	C10			
Eng. F4R 747	Qty: 4									1.970.432	C10			
2.0 RT	Petrol	112	10/96-02/99	ENGINE F3R 750, F3R 751, F3R 752, F3R 791, F3R 796, F3R 797, F3R 798										
Engine	Information				A10	A20	A40	A50	A70	C10 - C30	C20	E01		
All engines	-eng. F3R752, x 1, D.I.S., connector type, saw teeth									1.970.196	C10			
Eng. F3R 752	x 1, D.I.S.									1.970.275	C10			
MEGANE II														
1.4	Petrol	60	09/03->	ENGINE K4J 732										
Engine	Information				A10	A20	A40	A50	A70	C10 - C30	C20	E01		
All engines	x 4, SAGEM, COIL ON PLUG									1.970.432	C10			
1.4	Petrol	72	08/03->	ENGINE K4J 730, K4J 740										
Engine	Information				A10	A20	A40	A50	A70	C10 - C30	C20	E01		
All engines	x 4, SAGEM, COIL ON PLUG									1.970.432	C10			
A10	CONDENSER			A20	CONTACT SET			A40	DISTRIBUTOR CAP		A50	ROTOR		
C10	COIL			C20	IGNITION MODULE			C30	ELECTRONIC IGNITION KIT		E01	IGNITION CABLE SET		

					FUNCTIONS ON THE VEHICLE							
Vehicle	alim.	kW	Date	Engine								
ENGINE												
1.4 16V	Petrol	60	10/03-02/08	K4J 732								
ENGINE												
Engine		Information			A10	A20	A40	A50	A70	C10 - C30	C20	E01
All engines		x 4, SAGEM, COIL ON PLUG								1.970.432	C10	
1.4 16V	Petrol	72	11/02-02/08	K4J 730, K4J 740								
ENGINE												
Engine		Information			A10	A20	A40	A50	A70	C10 - C30	C20	E01
All engines		x 4, SAGEM, COIL ON PLUG								1.970.432	C10	
1.6	Petrol	75	09/03->	K4M 768								
ENGINE												
Engine		Information			A10	A20	A40	A50	A70	C10 - C30	C20	E01
All engines		Qty: 4								1.970.432	C10	
1.6	Petrol	77	05/05->	K4M 760, K4M 761, K4M 762, K4M 788, K4M 812, K4M 813, K4M680								
ENGINE												
Engine		Information			A10	A20	A40	A50	A70	C10 - C30	C20	E01
Eng. K4M 760, K4M 761, K4M 762, K4M 812, K4M 813, K4M680		x 4, SAGEM, COIL ON PLUG								1.970.432	C10	
Eng. K4M 788		Qty: 4								1.970.432	C10	
1.6	Petrol	81	09/03-11/08	K4M 760, K4M 761								
ENGINE												
Engine		Information			A10	A20	A40	A50	A70	C10 - C30	C20	E01
All engines		Qty: 4								1.970.432	C10	
1.6	Petrol	82	10/03-01/08	K4M 760								
ENGINE												
Engine		Information			A10	A20	A40	A50	A70	C10 - C30	C20	E01
All engines		x 4, SAGEM, COIL ON PLUG								1.970.432	C10	
1.6	Petrol	83	08/03->	K4M 760, K4M 761, K4M 812, K4M 813								
ENGINE												
Engine		Information			A10	A20	A40	A50	A70	C10 - C30	C20	E01
All engines		x 4, SAGEM, COIL ON PLUG								1.970.432	C10	
1.6 16V	Petrol	75	05/05-07/09	K4M 768								
ENGINE												
Engine		Information			A10	A20	A40	A50	A70	C10 - C30	C20	E01
All engines		x 4, SAGEM, COIL ON PLUG								1.970.432	C10	
1.6 16V	Petrol	77	05/05-07/09	K4M 762								
ENGINE												
Engine		Information			A10	A20	A40	A50	A70	C10 - C30	C20	E01
All engines		x 4, SAGEM, COIL ON PLUG								1.970.432	C10	
1.6 16V	Petrol	82	01/06->	K4M 760, K4M 761, K4M 812, K4M 813								
ENGINE												
Engine		Information			A10	A20	A40	A50	A70	C10 - C30	C20	E01
All engines		x 4, SAGEM, COIL ON PLUG								1.970.432	C10	
Eng. K4M 761, K4M 812, K4M 813		Qty: 4								1.970.432	C10	
1.6 16V	Petrol	83	11/02->	K4M 760, K4M 761, K4M 764, K4M 812, K4M 813, K4M 856								
ENGINE												
Engine		Information			A10	A20	A40	A50	A70	C10 - C30	C20	E01
Eng. K4M 760, K4M 761, K4M 764, K4M 812, K4M 813		x 4, SAGEM, COIL ON PLUG								1.970.432	C10	
Eng. K4M 761, K4M 764, K4M 856		Qty: 4								1.970.432	C10	
1.6 16V Hi-Flex	Petrol/ Ethanol	77	02/08-07/09	K4M 856								
ENGINE												
Engine		Information			A10	A20	A40	A50	A70	C10 - C30	C20	E01
All engines		x 4, SAGEM, COIL ON PLUG								1.970.432	C10	









A10 CONDENSER	A20 CONTACT SET	A40 DISTRIBUTOR CAP	A50 ROTOR	A70 PICK-UP
C10 COIL	C20 IGNITION MODULE	C30 ELECTRONIC IGNITION KIT	E01 IGNITION CABLE SET	

Vehicle	alim.	kW	Date	Engine	FUNCTIONS ON THE VEHICLE												
					A10	A20	A40	A50	A70	C10 - C30	C20	E01					
ENGINE																	
1.6 Bifuel	Petrol/ Liquified Petro- leum Gas (LPG)	77	06/05-02/08	K4M 788													
Engine	Information				A10	A20	A40	A50	A70	C10 - C30	C20	E01					
All engines	x 4, SAGEM, COIL ON PLUG									1.970.432	C10						
ENGINE																	
1.6 Flex-Fuel	Petrol/ Ethanol	77	01/07-02/08	K4M 856													
Engine	Information				A10	A20	A40	A50	A70	C10 - C30	C20	E01					
All engines	x 4, SAGEM, COIL ON PLUG									1.970.432	C10						
ENGINE																	
1.6 LPG 16V	Petrol/ Liquified Petro- leum Gas (LPG)	82	01/06-08/09	K4M 760													
Engine	Information				A10	A20	A40	A50	A70	C10 - C30	C20	E01					
All engines	x 4, SAGEM, COIL ON PLUG									1.970.432	C10						
ENGINE																	
2.0	Petrol	101	04/06-11/10	F4R 770, F4R 771													
Engine	Information				A10	A20	A40	A50	A70	C10 - C30	C20	E01					
All engines	x 4, SAGEM, COIL ON PLUG									1.970.432	C10						
ENGINE																	
2.0	Petrol	102	09/03-01/11	F4R 770													
Engine	Information				A10	A20	A40	A50	A70	C10 - C30	C20	E01					
All engines	Qty: 4									1.970.432	C10						
All engines	x 4, SAGEM, COIL ON PLUG									1.970.432	C10						
ENGINE																	
2.0	Petrol	169	08/06-02/08	F4R 774													
Engine	Information				A10	A20	A40	A50	A70	C10 - C30	C20	E01					
All engines	x 4, SAGEM, COIL ON PLUG									1.970.432	C10						
ENGINE																	
2.0	Petrol	99	08/03->	F4R 770, F4R 771													
Engine	Information				A10	A20	A40	A50	A70	C10 - C30	C20	E01					
All engines	x 4, SAGEM, COIL ON PLUG									1.970.432	C10						
ENGINE																	
2.0 16V	Petrol	99	11/02-02/08	F4R 770, F4R 771													
Engine	Information				A10	A20	A40	A50	A70	C10 - C30	C20	E01					
All engines	x 4, SAGEM, COIL ON PLUG									1.970.432	C10						
ENGINE																	
2.0 16V Turbo	Petrol	120	05/04-03/09	F4R 776													
Engine	Information				A10	A20	A40	A50	A70	C10 - C30	C20	E01					
All engines	x 4, SAGEM, COIL ON PLUG									1.970.432	C10						
ENGINE																	
2.0 Renault Sport	Petrol	165	05/04-10/09	F4R 774, F4Rt 774													
Engine	Information				A10	A20	A40	A50	A70	C10 - C30	C20	E01					
Eng. F4R 774	x 4, SAGEM, COIL ON PLUG									1.970.432	C10						
Eng. F4Rt 774	Qty: 4									1.970.432	C10						
MEGANE III																	
ENGINE																	
1.2 Tce	Petrol	85	03/12->	HSF 400, HSF 408													
Engine	Information				A10	A20	A40	A50	A70	C10 - C30	C20	E01					
All engines	x 4, COIL ON PLUG									1.970.613	C10						
ENGINE																	
1.2 Tce	Petrol	97	01/13->	HSF 404, HSF 405, HSF 412													
Engine	Information				A10	A20	A40	A50	A70	C10 - C30	C20	E01					
All engines	x 4, COIL ON PLUG									1.970.613	C10						
ENGINE																	
1.6 16V	Petrol	74	11/08->	K4M 848													
Engine	Information				A10	A20	A40	A50	A70	C10 - C30	C20	E01					
All engines	x 4, SAGEM, COIL ON PLUG									1.970.432	C10						
A10	CONDENSER	A20	CONTACT SET	A40	DISTRIBUTOR CAP	A50	ROTOR	A70	PICK-UP	C10	COIL	C20	IGNITION MODULE	C30	ELECTRONIC IGNITION KIT	E01	IGNITION CABLE SET

					FUNCTIONS ON THE VEHICLE								
Vehicle	alim.	kW	Date	Engine									
ENGINE													
1.6 16V	Petrol	78	01/10-08/15	K4M 848									
ENGINE													
All engines					x 4, SAGEM, COIL ON PLUG						1.970.432	C10	
ENGINE													
1.6 16V	Petrol	81	11/08->	K4M 858, K4M 866									
ENGINE													
All engines					x 4, SAGEM, COIL ON PLUG						1.970.432	C10	
ENGINE													
1.6 16V	Petrol	82	11/08->	K4M 858, K4M 866									
ENGINE													
All engines					x 4, SAGEM, COIL ON PLUG						1.970.432	C10	
ENGINE													
1.6 16V	Petrol	85	01/13->	K4M 858									
ENGINE													
All engines					x 4, SAGEM, COIL ON PLUG						1.970.432	C10	
ENGINE													
1.6 16V Bifuel	Petrol/ Liquified Petroleum Gas (LPG)	81	11/08->	K4M 858, K4M 866									
ENGINE													
All engines					x 4, SAGEM, COIL ON PLUG						1.970.432	C10	
ENGINE													
1.6 16V Hi-Flex	Petrol/ Ethanol	81	11/08-08/15	K4M 866									
ENGINE													
All engines					x 4, SAGEM, COIL ON PLUG						1.970.432	C10	
ENGINE													
1.6 BiFuel	Petrol/ Liquified Petroleum Gas (LPG)	81	11/08->	K4M 866									
ENGINE													
All engines					x 4, SAGEM, COIL ON PLUG						1.970.432	C10	
ENGINE													
2.0 R.S.	Petrol	195	11/08->	F4R874									
ENGINE													
All engines					x 4, SAGEM, COIL ON PLUG						1.970.432	C10	
ENGINE													
2.0 R.S.	Petrol	201	07/14->	F4R874									
ENGINE													
All engines					x 4, SAGEM, COIL ON PLUG						1.970.432	C10	
ENGINE													
2.0 TCe	Petrol	132	11/08->	F4R 872, F4R870									
ENGINE													
All engines					x 4, SAGEM, COIL ON PLUG						1.970.432	C10	
ENGINE													
2.0 TCe	Petrol	140	06/12->	F4R 872									
ENGINE													
All engines					x 4, SAGEM, COIL ON PLUG						1.970.432	C10	
ENGINE													
2.0 TCe	Petrol	162	09/12->	F4R874									
ENGINE													
All engines					x 4, SAGEM, COIL ON PLUG						1.970.432	C10	
ENGINE													
2.0 TCe	Petrol	184	05/09->	F4R874									
ENGINE													
All engines					x 4, SAGEM, COIL ON PLUG						1.970.432	C10	

A10 CONDENSER	A20 CONTACT SET	A40 DISTRIBUTOR CAP	A50 ROTOR	A70 PICK-UP
C10 COIL	C20 IGNITION MODULE	C30 ELECTRONIC IGNITION KIT	E01 IGNITION CABLE SET	

Vehicle	alim.	kW	Date	Engine	FUNCTIONS ON THE VEHICLE										
					A10	A20	A40	A50	A70	C10 - C30	C20	E01			
ENGINE															
2.0 TCe 220	Petrol	162	11/13->	F4R874											
Engine	Information				A10	A20	A40	A50	A70	C10 - C30	C20	E01			
All engines	x 4, SAGEM, COIL ON PLUG									1.970.432	C10				
MEGANE IV															
ENGINE															
1.2 TCe 100	Petrol	74	11/15->	H5F 408											
Engine	Information				A10	A20	A40	A50	A70	C10 - C30	C20	E01			
All engines	x 4, COIL ON PLUG									1.970.613	C10				
ENGINE															
1.2 TCe 130	Petrol	97	11/15->	H5F 408											
Engine	Information				A10	A20	A40	A50	A70	C10 - C30	C20	E01			
All engines	x 4, COIL ON PLUG									1.970.613	C10				
ENGINE															
1.6 16V	Petrol	84	11/15->	H4M 738, H4M 750											
Engine	Information				A10	A20	A40	A50	A70	C10 - C30	C20	E01			
All engines	x 4, COIL ON PLUG, x 4, COIL ON PLUG									1.970.613	C10				
ENGINE															
1.6 SCe	Petrol	84	10/16->	H4M 738, H4M 750											
Engine	Information				A10	A20	A40	A50	A70	C10 - C30	C20	E01			
All engines	x 4, COIL ON PLUG									1.970.613	C10				
ENGINE															
1.6 TCe 165	Petrol	121	07/17->	MSM 450											
Engine	Information				A10	A20	A40	A50	A70	C10 - C30	C20	E01			
All engines	x 4, COIL ON PLUG									1.970.551	C10				
ENGINE															
1.6 TCe 205	Petrol	151	11/15->	MSM 450											
Engine	Information				A10	A20	A40	A50	A70	C10 - C30	C20	E01			
All engines	x 4, COIL ON PLUG									1.970.551	C10				
ENGINE															
1.8 RS 300	Petrol	221	09/18->	M5P 404											
Engine	Information				A10	A20	A40	A50	A70	C10 - C30	C20	E01			
All engines	x 4, COIL ON PLUG									1.970.551	C10				
ENGINE															
1.8 RS TCe 280	Petrol	205	10/17->	M5P 402, M5P 404											
Engine	Information				A10	A20	A40	A50	A70	C10 - C30	C20	E01			
All engines	x 4, COIL ON PLUG									1.970.551	C10				
MEGANE SCÉNIC I															
ENGINE															
1.4 i	Petrol	55	01/97-09/99	E7J 764											
Engine	Information				A10	A20	A40	A50	A70	C10 - C30	C20	E01			
All engines	version Ducellier						1.315.081	1.415.101							
All engines	version Marelli						1.330.111	1.430.059							
All engines	x 1, SIEMENS, DISTRIBUTOR, Dia: 4 mm, connector type SAE									1.970.107	C10				
All engines													1.500.801		
ENGINE															
1.6 16V	Petrol	79	04/98-10/99	K4M 701, K4M 704, K4M 708, K4M700											
Engine	Information				A10	A20	A40	A50	A70	C10 - C30	C20	E01			
Eng. K4M 701, K4M700	x 4, SAGEM, COIL ON PLUG									1.970.432	C10				
Eng. K4M 704, K4M 708	Qty: 4									1.970.432	C10				
ENGINE															
1.6 e	Petrol	66	10/96-10/99	K7M 702, K7M 703											
Engine	Information				A10	A20	A40	A50	A70	C10 - C30	C20	E01			
All engines	->year 01/03/97, x 1, Colour:Black, D.I.S.									1.970.355	C10				
All engines	->year 01/03/97, x 1, Colour:Grey, D.I.S.									1.970.356	C10				
All engines	01/04/97 ->, ->year 01/06/98, x 1, Colour:Black, D.I.S., connector type, saw teeth									1.970.376	C10				
All engines	01/04/97 ->, ->year 01/06/98, x 1, Colour:Grey, D.I.S., connector type, saw teeth									1.970.378	C10				
All engines	01/07/98 ->, x 1, D.I.S.									1.970.596	C10				
All engines	08/07/98 ->												1.499.244		
All engines	->year 08/07/98, 10/03/97 ->												1.501.443		
A10	CONDENSER		A20	CONTACT SET		A40	DISTRIBUTOR CAP		A50	ROTOR		A70	PICK-UP		
C10	COIL		C20	IGNITION MODULE		C30	ELECTRONIC IGNITION KIT		E01	IGNITION CABLE SET					

					FUNCTIONS ON THE VEHICLE							
Vehicle	alim.	kW	Date	Engine								
1.6 e	Petrol	66	10/96-10/99	ENGINE K7M 702, K7M 703								
Engine	Information				A10	A20	A40	A50	A70	C10 - C30	C20	E01
All engines	->year 10/03/97											1.501.446
1.6 i	Petrol	55	01/97-09/99	ENGINE K7M 720								
Engine	Information				A10	A20	A40	A50	A70	C10 - C30	C20	E01
All engines	->year 01/03/97, x 1, Colour:Black, D.I.S.									1.970.355	C10	
All engines	->year 01/03/97, x 1, Colour:Grey, D.I.S.									1.970.356	C10	
All engines	01/04/97 ->, ->year 01/06/98, x 1, Colour:Black, D.I.S., connector type, saw teeth									1.970.376	C10	
All engines	01/04/97 ->, ->year 01/06/98, x 1, Colour:Grey, D.I.S., connector type, saw teeth									1.970.378	C10	
All engines	01/07/98 ->, x 1, D.I.S.									1.970.596	C10	
All engines	08/07/98 ->											1.499.244
All engines	->year 08/07/98, 10/03/97 ->											1.501.443
All engines	->year 10/03/97											1.501.446
2.0 i	Petrol	80	01/99-09/99	ENGINE F3R 750, F3R 751, F3R 791, F3R 796, F3R 797, F3R 798								
Engine	Information				A10	A20	A40	A50	A70	C10 - C30	C20	E01
All engines	x 1, D.I.S., connector type, saw teeth									1.970.196	C10	
Eng. F3R 796												1.501.492
2.0 i	Petrol	84	01/97-09/99	ENGINE F3R 750, F3R 751, F3R 791, F3R 796, F3R 797, F3R 798								
Engine	Information				A10	A20	A40	A50	A70	C10 - C30	C20	E01
All engines	x 1, D.I.S., connector type, saw teeth									1.970.196	C10	
Eng. F3R 750, F3R 751	02/04/97 ->											1.501.492
Eng. F3R 750, F3R 751	->year 02/04/97											1.501.501
2.0 RXE 4x4	Petrol	84	05/97-10/99	ENGINE F3R 750								
Engine	Information				A10	A20	A40	A50	A70	C10 - C30	C20	E01
All engines	02/04/97 ->, Qty: 2									1.970.196	C10	
All engines	->year 02/04/97, Qty: 2									1.970.275	C10	
All engines	02/04/97 ->											1.501.492
All engines	->year 02/04/97											1.501.501
MODUS / GRAND MODUS												
1.2	Petrol	48	05/05->	ENGINE D4F 740								
Engine	Information				A10	A20	A40	A50	A70	C10 - C30	C20	E01
All engines	x 1, D.I.S.									1.970.518	C10	
All engines												1.499.246
1.2	Petrol	55	12/04->	ENGINE D4F 740, D4F 742, D4F 744								
Engine	Information				A10	A20	A40	A50	A70	C10 - C30	C20	E01
Eng. D4F 740, D4F 744	x 1, D.I.S.									1.970.518	C10	
Eng. D4F 742										1.970.518	C10	
Eng. D4F 740, D4F 742												1.499.246
1.2	Petrol	58	12/04->	ENGINE D4F 764								
Engine	Information				A10	A20	A40	A50	A70	C10 - C30	C20	E01
All engines	x 1, D.I.S.									1.970.518	C10	
All engines												1.499.246
1.2	Petrol	76	04/11->	ENGINE D4F 786								
Engine	Information				A10	A20	A40	A50	A70	C10 - C30	C20	E01
All engines	x 1, D.I.S.									1.970.596	C10	
All engines												1.499.229

A10 CONDENSER	A20 CONTACT SET	A40 DISTRIBUTOR CAP	A50 ROTOR	A70 PICK-UP
C10 COIL	C20 IGNITION MODULE	C30 ELECTRONIC IGNITION KIT	E01 IGNITION CABLE SET	

Vehicle	alim.	kW	Date	Engine	FUNCTIONS ON THE VEHICLE									
					A10	A20	A40	A50	A70	C10 - C30	C20	E01		
ENGINE														
1.2 16V	Petrol	74	05/07->	D4F 784										
Engine	Information													
All engines	x 1, D.I.S.									1.970.596	C10			
All engines														1.499.229
ENGINE														
1.2 16V Hi-Flex	Petrol/ Ethanol	55	10/08->	D4F 740, D4F 742										
Engine	Information													
Eng. D4F 742	x 1, D.I.S.									1.970.518	C10			
Eng. D4F 740														1.499.246
ENGINE														
1.2 GPL	Petrol/ Liquified Petroleum Gas (LPG)	55	05/08-12/12	D4F 744										
Engine	Information													
All engines	x 1, D.I.S.									1.970.518	C10			
ENGINE														
1.4	Petrol	72	12/04->	K4J 770, K4J 780										
Engine	Information													
All engines	x 4, SAGEM, COIL ON PLUG									1.970.432	C10			
ENGINE														
1.6	Petrol	65	12/04->	K4M 792, K4M 794										
Engine	Information													
Eng. K4M 792	Qty: 4									1.970.432	C10			
Eng. K4M 794	x 4, SAGEM, COIL ON PLUG									1.970.432	C10			
ENGINE														
1.6	Petrol	82	12/04->	K4M 790, K4M 791, K4M 800, K4M 801										
Engine	Information													
All engines	x 4, SAGEM, COIL ON PLUG									1.970.432	C10			
RAPID														
ENGINE														
1.0	Petrol	27	02/86-05/92	C1C 706										
Engine	Information													
All engines	version Ducellier						1.315.054	1.415.091						
All engines														1.500.839
ENGINE														
1.0	Petrol	31	09/85-08/91	C1C 706										
Engine	Information													
All engines	version Ducellier						1.315.054	1.415.091						
All engines														1.500.839
ENGINE														
1.1	Petrol	33	07/85-04/95	C1E 750, C1E 752, C1E 754, C1E 756, C1E 760, C1E 762, C1E 792										
Engine	Information													
Eng. C1E 750, C1E 752, C1E 754, C1E 756, C1E 760, C1E 762	version Ducellier						1.315.054	1.415.091						
Eng. C1E 750, C1E 760	version Femsa						1.317.023	1.417.058						
Eng. C1E 750, C1E 760	version Marelli						1.330.101	1.430.047R						
All engines														1.500.839
ENGINE														
1.1	Petrol	34	09/85-08/91	C1E 750										
Engine	Information													
All engines	version Ducellier						1.315.054	1.415.091						
All engines	version Femsa						1.317.023	1.417.058						
All engines	version Marelli						1.330.101	1.430.047R						
All engines														1.500.839
ENGINE														
1.1	Petrol	35	09/93-04/95	C1E 762										
Engine	Information													
All engines	version Ducellier						1.315.054	1.415.091						

A10 CONDENSER	A20 CONTACT SET	A40 DISTRIBUTOR CAP	A50 ROTOR	A70 PICK-UP
C10 COIL	C20 IGNITION MODULE	C30 ELECTRONIC IGNITION KIT	E01 IGNITION CABLE SET	

The present application list is a brief version. For the detailed information about the possibility of installation on a specific vehicle, please refer to our web-catalogue <http://catalogue.facet.eu/>

Vehicle	alim.	kW	Date	Engine	FUNCTIONS ON THE VEHICLE							
					A10	A20	A40	A50	A70	C10 - C30	C20	E01

ENGINE				
1.1	Petrol	35	09/93-04/95	C1E 762

Engine	Information	A10	A20	A40	A50	A70	C10 - C30	C20	E01
All engines									1.500.839

ENGINE				
1.1	Petrol	36	09/91-10/97	C1E 764

Engine	Information	A10	A20	A40	A50	A70	C10 - C30	C20	E01
All engines	version Ducellier			1.315.054	1.415.091				
All engines									1.500.839

ENGINE				
1.2	Petrol	40	09/91-03/98	C1G 726, C3G 710, C3G 712

Engine	Information	A10	A20	A40	A50	A70	C10 - C30	C20	E01
All engines	distr. num. 525352A, version Ducellier			1.315.091					
Eng. C1G 726							1.970.107	C10	
Eng. C3G 710, C3G 712							1.970.228	C10	

ENGINE				
1.4	Petrol	43	07/85-09/97	C1J 768, C1J 780, E6J 738

Engine	Information	A10	A20	A40	A50	A70	C10 - C30	C20	E01
Eng. E6J 738	version Ducellier			1.315.081	1.415.101				
Eng. C1J 768, C1J 780	distr. num. 525352A, version Ducellier			1.315.091					
Eng. E6J 738	version Marelli			1.330.111	1.430.059				
All engines							1.970.107	C10	
Eng. E6J 738									1.500.801

ENGINE				
1.4	Petrol	44	03/86-08/91	C2J 784

Engine	Information	A10	A20	A40	A50	A70	C10 - C30	C20	E01
All engines	distr. num. 525352A, version Ducellier			1.315.091					
All engines							1.970.107	C10	

ENGINE				
1.4	Petrol	55	09/91-03/98	E7J 720, E7J 724, E7J 726, E7J 773

Engine	Information	A10	A20	A40	A50	A70	C10 - C30	C20	E01
All engines	version Ducellier			1.315.081	1.415.101				
All engines	version Marelli			1.330.111	1.430.059				
All engines							1.970.107	C10	1.500.801

ENGINE				
1.4	Petrol	58	01/94-03/98	E7J 728

Engine	Information	A10	A20	A40	A50	A70	C10 - C30	C20	E01
All engines	version Ducellier			1.315.081	1.415.101				
All engines	version Marelli			1.330.111	1.430.059				
All engines							1.970.107	C10	1.500.801

ENGINE				
1.4	Petrol	59	05/95-08/97	E7J 726, E7J 773

Engine	Information	A10	A20	A40	A50	A70	C10 - C30	C20	E01
All engines	x 1, ignition mod. IGN. MODULE(-), SIEMENS, DISTRIBUTOR, Dia: 4 mm, connector type SAE						1.970.107	C10	

ENGINE				
1.4 Cat	Petrol	43	08/88-03/98	C3J 700, C3J 702, C3J 760, C3J 762

Engine	Information	A10	A20	A40	A50	A70	C10 - C30	C20	E01
All engines	distr. num. 525352A, version Ducellier			1.315.091					
Eng. C3J 702, C3J 760, C3J 762							1.970.107	C10	

ENGINE				
1.4 RN	Petrol	44	09/91-08/93	E6J 734

Engine	Information	A10	A20	A40	A50	A70	C10 - C30	C20	E01
All engines	version Ducellier			1.315.081	1.415.101				
All engines	version Marelli			1.330.111	1.430.059				
All engines							1.970.107	C10	1.500.801

A10 CONDENSER	A20 CONTACT SET	A40 DISTRIBUTOR CAP	A50 ROTOR	A70 PICK-UP
C10 COIL	C20 IGNITION MODULE	C30 ELECTRONIC IGNITION KIT	E01 IGNITION CABLE SET	

Vehicle	alim.	kW	Date	Engine	FUNCTIONS ON THE VEHICLE							
					A10	A20	A40	A50	A70	C10 - C30	C20	E01

SAFRANE I

				ENGINE
2.0	Petrol	77	11/92-07/96	0LJY, J7R 732

Engine	Information	A10	A20	A40	A50	A70	C10 - C30	C20	E01
All engines	distr. num. 525646, version Ducellier			1.315.081					
All engines	distr. num. 525703, version Ducellier			1.315.082					
All engines	distr. num. 525703, Kit, version Ducellier			1.315.083					
All engines	version Ducellier				1.415.101				
All engines							1.970.107	C10	

				ENGINE
2.0	Petrol	97	08/92-09/96	J7R 738, J7R 739

Engine	Information	A10	A20	A40	A50	A70	C10 - C30	C20	E01
All engines	distr. num. 525646, version Ducellier			1.315.081					
All engines	distr. num. 525703, version Ducellier			1.315.082					
All engines	distr. num. 525703, Kit, version Ducellier			1.315.083					
All engines	version Ducellier				1.415.101				
All engines							1.970.107	C10	

				ENGINE
2.0 12V	Petrol	97	04/92-07/96	J7R 734, J7R 735

Engine	Information	A10	A20	A40	A50	A70	C10 - C30	C20	E01
All engines	distr. num. 525646, version Ducellier			1.315.081					
All engines	distr. num. 525704, version Ducellier			1.315.082					
All engines	distr. num. 525704, Kit, version Ducellier			1.315.083					
All engines	version Ducellier				1.415.101				
All engines							1.970.107	C10	

				ENGINE
2.2	Petrol	101	04/92-07/96	1MR479QB, J7T 761

Engine	Information	A10	A20	A40	A50	A70	C10 - C30	C20	E01
All engines	distr. num. 525646, version Ducellier			1.315.081					
All engines	distr. num. 525703, version Ducellier			1.315.082					
All engines	distr. num. 525703, Kit, version Ducellier			1.315.083					
All engines	version Ducellier				1.415.101				
All engines							1.970.107	C10	

				ENGINE
2.2	Petrol	79	04/92-07/96	J7T 762

Engine	Information	A10	A20	A40	A50	A70	C10 - C30	C20	E01
All engines	distr. num. 525646, version Ducellier			1.315.081					
All engines	distr. num. 525703, version Ducellier			1.315.082					
All engines	distr. num. 525703, Kit, version Ducellier			1.315.083					
All engines	version Ducellier				1.415.101				
All engines							1.970.107	C10	

				ENGINE
3.0	Petrol	125	02/93-06/96	Z7X 723

Engine	Information	A10	A20	A40	A50	A70	C10 - C30	C20	E01
All engines	version Bosch			1.306.236	1.406.119R				
All engines							1.970.107	C10	

				ENGINE
3.0 Biturbo 4x4	Petrol	193	02/93-07/96	Z7X 726

Engine	Information	A10	A20	A40	A50	A70	C10 - C30	C20	E01
All engines	version Bosch			1.306.236	1.406.119R				
All engines							1.970.107	C10	

				ENGINE
3.0 V6	Petrol	123	12/92-07/96	Z7X 721, Z7X 722, Z7X 723, Z7X 753

Engine	Information	A10	A20	A40	A50	A70	C10 - C30	C20	E01
All engines	version Bosch			1.306.236	1.406.119R				
All engines							1.970.107	C10	

				ENGINE
3.0 V6 4x4	Petrol	123	12/92-07/96	Z7X 721, Z7X 722, Z7X 723

Engine	Information	A10	A20	A40	A50	A70	C10 - C30	C20	E01
All engines	version Bosch			1.306.236	1.406.119R				
All engines							1.970.107	C10	

A10	CONDENSER	A20	CONTACT SET	A40	DISTRIBUTOR CAP	A50	ROTOR	A70	PICK-UP
C10	COIL	C20	IGNITION MODULE	C30	ELECTRONIC IGNITION KIT	E01	IGNITION CABLE SET		

Vehicle	alim.	kW	Date	Engine	FUNCTIONS ON THE VEHICLE							
					A10	A20	A40	A50	A70	C10 - C30	C20	E01

SAFRANE II

2.0 16V	Petrol	100	07/96-12/00	ENGINE N7Q 710, N7Q 711
---------	--------	-----	-------------	----------------------------

Engine	Information	A10	A20	A40	A50	A70	C10 - C30	C20	E01
All engines	Fitting Position:for cylinder 1, Fitting Position:for cylinder 4, x 1, Colour:Black, D.I.S.						1.970.355	C10	
All engines	Fitting Position:for cylinder 2, Fitting Position:for cylinder 3, x 1, Colour:Grey, D.I.S.						1.970.356	C10	
All engines									1.499.061

2.5 20V	Petrol	121	07/96-12/00	ENGINE N7U 700, N7U 701
---------	--------	-----	-------------	----------------------------

Engine	Information	A10	A20	A40	A50	A70	C10 - C30	C20	E01
All engines	version Bosch			1.306.260	1.406.147R				
All engines							1.990.423	C30	1.499.064

2.9 24V	Petrol	140	03/99-12/00	ENGINE L7X 713
---------	--------	-----	-------------	-------------------

Engine	Information	A10	A20	A40	A50	A70	C10 - C30	C20	E01
All engines	version Bosch			1.306.236	1.406.119R				

3.0 V6	Petrol	123	07/96-12/00	ENGINE Z7X 755
--------	--------	-----	-------------	-------------------

Engine	Information	A10	A20	A40	A50	A70	C10 - C30	C20	E01
All engines	x 1, ignition mod. IGN. MODULE(-), SIEMENS, DISTRIBUTOR, Dia: 4 mm, connector type SAE						1.970.107	C10	

SANDERO I

1.2 16V	Petrol	55	11/08->	ENGINE D4F 732
---------	--------	----	---------	-------------------

Engine	Information	A10	A20	A40	A50	A70	C10 - C30	C20	E01
All engines							1.970.518	C10	1.499.246

1.4	Petrol	55	02/09->	ENGINE K7J 710
-----	--------	----	---------	-------------------

Engine	Information	A10	A20	A40	A50	A70	C10 - C30	C20	E01
All engines	x 1, D.I.S.						1.970.596	C10	
All engines	->year 18/03/05								1.499.244
All engines	18/03/05 ->								1.499.252

1.4 LPG	Petrol/ Liquified Petroleum Gas (LPG)	53	02/09->	ENGINE K7J 714
---------	--	----	---------	-------------------

Engine	Information	A10	A20	A40	A50	A70	C10 - C30	C20	E01
All engines	x 1, D.I.S.						1.970.596	C10	

1.6	Petrol	62	11/10->	ENGINE K7M 710
-----	--------	----	---------	-------------------

Engine	Information	A10	A20	A40	A50	A70	C10 - C30	C20	E01
All engines	x 1, D.I.S.						1.970.596	C10	

1.6	Petrol	64	02/09->	ENGINE K7M 710
-----	--------	----	---------	-------------------

Engine	Information	A10	A20	A40	A50	A70	C10 - C30	C20	E01
All engines	x 1, D.I.S.						1.970.596	C10	
All engines	->year 18/03/05								1.499.244
All engines	18/03/05 ->								1.499.252

1.6	Petrol	66	05/09->	ENGINE K7M 710
-----	--------	----	---------	-------------------

Engine	Information	A10	A20	A40	A50	A70	C10 - C30	C20	E01
All engines							1.970.596	C10	
All engines	->year 18/03/05								1.499.244
All engines	18/03/05 ->								1.499.252

1.6	Petrol	75	12/07->	ENGINE K7M 710
-----	--------	----	---------	-------------------









Engine	Information	A10	A20	A40	A50	A70	C10 - C30	C20	E01
All engines	x 1, D.I.S.						1.970.596	C10	
All engines									1.499.252

A10 CONDENSER	A20 CONTACT SET	A40 DISTRIBUTOR CAP	A50 ROTOR	A70 PICK-UP
C10 COIL	C20 IGNITION MODULE	C30 ELECTRONIC IGNITION KIT	E01 IGNITION CABLE SET	



Vehicle	alim.	kW	Date	Engine	FUNCTIONS ON THE VEHICLE									
					A10	A20	A40	A50	A70	C10 - C30	C20	E01		
ENGINE														
1.6	Petrol	76	12/07-07/13	K4M 697										
Engine		Information			A10	A20	A40	A50	A70	C10 - C30	C20	E01		
All engines		x 4, SAGEM, COIL ON PLUG								1.970.432	C10			
ENGINE														
1.6	Petrol	77	12/12->	K4M 697										
Engine		Information			A10	A20	A40	A50	A70	C10 - C30	C20	E01		
All engines		x 4, SAGEM, COIL ON PLUG								1.970.432	C10			
SANDERO II														
ENGINE														
1.2 16V	Petrol	54	12/13->	D4F 732, D4F 734										
Engine		Information			A10	A20	A40	A50	A70	C10 - C30	C20	E01		
All engines		x 1, D.I.S.								1.970.518	C10			
ENGINE														
1.2 16V	Petrol	55	04/15->	D4F 732										
Engine		Information			A10	A20	A40	A50	A70	C10 - C30	C20	E01		
All engines		x 1, D.I.S.								1.970.518	C10			
ENGINE														
1.2 16V LPG	Petrol/ Liquified Petroleum Gas (LPG)	53	12/13->	D4F 734										
Engine		Information			A10	A20	A40	A50	A70	C10 - C30	C20	E01		
All engines		x 1, D.I.S.								1.970.518	C10			
ENGINE														
1.6	Petrol	59	11/13->	K7M 812										
Engine		Information			A10	A20	A40	A50	A70	C10 - C30	C20	E01		
All engines		x 1, D.I.S.								1.970.596	C10			
ENGINE														
1.6	Petrol	60	11/13->	K7M 812										
Engine		Information			A10	A20	A40	A50	A70	C10 - C30	C20	E01		
All engines		x 1, D.I.S.								1.970.596	C10			
ENGINE														
1.6	Petrol	61	11/13->	K7M 812										
Engine		Information			A10	A20	A40	A50	A70	C10 - C30	C20	E01		
All engines		x 1, D.I.S.								1.970.596	C10			
ENGINE														
1.6	Petrol	83	09/16->	H4M 429, H4M 438										
Engine		Information			A10	A20	A40	A50	A70	C10 - C30	C20	E01		
All engines		x 4, COIL ON PLUG								1.970.613	C10			
ENGINE														
1.6 16V	Petrol	75	04/14->	K4M 842, K4M 845										
Engine		Information			A10	A20	A40	A50	A70	C10 - C30	C20	E01		
All engines		x 4, SAGEM, COIL ON PLUG								1.970.432	C10			
ENGINE														
TCe 90	Petrol	66	09/15->	H4B 400, H4B 408, H4B 410, H4B411										
Engine		Information			A10	A20	A40	A50	A70	C10 - C30	C20	E01		
All engines		x 3, COIL ON PLUG								1.970.613	C10			
SCÉNIC														
ENGINE														
1.6 VVT	Petrol	81	01/13->	K4M 858										
Engine		Information			A10	A20	A40	A50	A70	C10 - C30	C20	E01		
All engines		x 4, SAGEM, COIL ON PLUG								1.970.432	C10			
SCÉNIC I														
ENGINE														
1.4 16V	Petrol	70	09/99-08/03	K4J 714, K4J750										
Engine		Information			A10	A20	A40	A50	A70	C10 - C30	C20	E01		
All engines		x 4, SAGEM, COIL ON PLUG								1.970.432	C10			

A10	CONDENSER	A20	CONTACT SET	A40	DISTRIBUTOR CAP	A50	ROTOR	A70	PICK-UP
C10	COIL	C20	IGNITION MODULE	C30	ELECTRONIC IGNITION KIT	E01	IGNITION CABLE SET		

The present application list is a brief version. For the detailed information about the possibility of installation on a specific vehicle, please refer to our web-catalogue <http://catalogo.facet.eu/>

					FUNCTIONS ON THE VEHICLE								
Vehicle	alim.	kW	Date	Engine									
1.6	Petrol	75	03/01-08/03	ENGINE K4M 701, K4M 708, K4M 709, K4M700									
				Engine Information	A10	A20	A40	A50	A70	C10 - C30	C20	E01	
All engines x 4, SAGEM, COIL ON PLUG										1.970.432	C10		
1.6	Petrol	79	09/99-09/03	ENGINE K4M 706, K4M 707, K4M 776, K4M700									
				Engine Information	A10	A20	A40	A50	A70	C10 - C30	C20	E01	
All engines x 4, SAGEM, COIL ON PLUG										1.970.432	C10		
1.6	Petrol	81	06/01-09/03	ENGINE K4M 708									
				Engine Information	A10	A20	A40	A50	A70	C10 - C30	C20	E01	
All engines Qty: 4										1.970.432	C10		
1.6 16V	Petrol	107	05/00-08/03	ENGINE K4M 712									
				Engine Information	A10	A20	A40	A50	A70	C10 - C30	C20	E01	
All engines Qty: 4										1.970.432	C10		
1.6 BiFuel	Petrol/ Liquified Petroleum Gas (LPG)	75	03/01-08/03	ENGINE K4M 712									
				Engine Information	A10	A20	A40	A50	A70	C10 - C30	C20	E01	
All engines x 4, SAGEM, COIL ON PLUG										1.970.432	C10		
1.6 BiFuel	Petrol/ Liquified Petroleum Gas (LPG)	79	09/99-04/01	ENGINE K4M 704									
				Engine Information	A10	A20	A40	A50	A70	C10 - C30	C20	E01	
All engines x 4, SAGEM, COIL ON PLUG										1.970.432	C10		
1.8 16V	Petrol	85	01/01-08/03	ENGINE F4P 720, F4P 722									
				Engine Information	A10	A20	A40	A50	A70	C10 - C30	C20	E01	
All engines x 4, SAGEM, COIL ON PLUG										1.970.432	C10		
1.8 4x4	Petrol	85	07/00-04/01	ENGINE F4P 722									
				Engine Information	A10	A20	A40	A50	A70	C10 - C30	C20	E01	
All engines x 4, SAGEM, COIL ON PLUG										1.970.432	C10		
2.0	Petrol	84	09/99-08/03	ENGINE F3R 791, F3R 797, F3R 798									
				Engine Information	A10	A20	A40	A50	A70	C10 - C30	C20	E01	
				All engines	02/04/97 ->, Qty: 2						1.970.196	C10	
				All engines	->year 02/04/97, Qty: 2						1.970.275	C10	
				All engines	02/04/97 ->								1.501.492
All engines ->year 02/04/97												1.501.501	
2.0 16V	Petrol	102	07/00-08/03	ENGINE F4R 740, F4R 741, F4R 744, F4R 746, F4R 747									
				Engine Information	A10	A20	A40	A50	A70	C10 - C30	C20	E01	
Eng. F4R 740, F4R 741, F4R 744, F4R 747 x 4, SAGEM, COIL ON PLUG										1.970.432	C10		
Eng. F4R 746 Qty: 4										1.970.432	C10		
2.0 16V	Petrol	103	09/99-08/03	ENGINE F4R 740, F4R 741, F4R 744, F4R 746, F4R 747									
				Engine Information	A10	A20	A40	A50	A70	C10 - C30	C20	E01	
Eng. F4R 740, F4R 741, F4R 746, F4R 747 x 4, SAGEM, COIL ON PLUG										1.970.432	C10		
Eng. F4R 744 Qty: 4										1.970.432	C10		

A10 CONDENSER	A20 CONTACT SET	A40 DISTRIBUTOR CAP	A50 ROTOR	A70 PICK-UP
C10 COIL	C20 IGNITION MODULE	C30 ELECTRONIC IGNITION KIT	E01 IGNITION CABLE SET	

					FUNCTIONS ON THE VEHICLE							
Vehicle	alim.	kW	Date	Engine								
ENGINE												
1.2 TCe	Petrol	96	07/14->	HSF 408								
Engine	Information				A10	A20	A40	A50	A70	C10 - C30	C20	E01
All engines	x 4, COIL ON PLUG									1.970.613	C10	
ENGINE												
1.2 TCe	Petrol	97	01/13->	HSF 404, HSF 408								
Engine	Information				A10	A20	A40	A50	A70	C10 - C30	C20	E01
All engines	x 4, COIL ON PLUG									1.970.613	C10	
ENGINE												
1.6 16V	Petrol	81	02/09->	K4M 858								
Engine	Information				A10	A20	A40	A50	A70	C10 - C30	C20	E01
All engines	x 4, SAGEM, COIL ON PLUG									1.970.432	C10	
ENGINE												
1.6 16V Bifuel	Petrol/ Liquified Petro- leum Gas (LPG)	79	04/12-12/13	K4M 866								
Engine	Information				A10	A20	A40	A50	A70	C10 - C30	C20	E01
All engines	x 4, SAGEM, COIL ON PLUG									1.970.432	C10	
ENGINE												
1.6 16V Bifuel	Petrol/ Liquified Petro- leum Gas (LPG)	81	02/09->	K4M 866								
Engine	Information				A10	A20	A40	A50	A70	C10 - C30	C20	E01
All engines	x 4, SAGEM, COIL ON PLUG									1.970.432	C10	
ENGINE												
1.6 E85	Petrol/ Ethanol	81	02/09->	K4M 866								
Engine	Information				A10	A20	A40	A50	A70	C10 - C30	C20	E01
All engines	x 4, SAGEM, COIL ON PLUG									1.970.432	C10	
SCÉNIC IV												
ENGINE												
1.2 TCe 115	Petrol	85	09/16->	HSF 408								
Engine	Information				A10	A20	A40	A50	A70	C10 - C30	C20	E01
All engines	x 4, COIL ON PLUG									1.970.613	C10	
ENGINE												
1.2 TCe 130	Petrol	96	09/16->	HSF 408								
Engine	Information				A10	A20	A40	A50	A70	C10 - C30	C20	E01
All engines	x 4, COIL ON PLUG									1.970.613	C10	
SUPER 5												
ENGINE												
1.0	Petrol	30	10/84-10/88	C1C700								
Engine	Information				A10	A20	A40	A50	A70	C10 - C30	C20	E01
All engines	version Femsas						1.317.023	1.417.058				
All engines	version Marelli						1.330.101	1.430.047R				
All engines	-air conditioning											1.500.839
ENGINE												
1.1	Petrol	33	01/86-03/95	C1E 750, C1E 752, C1E 756, C1E 760								
Engine	Information				A10	A20	A40	A50	A70	C10 - C30	C20	E01
Eng. C1E 752, C1E 756, C1E 760	version Ducellier						1.315.054	1.415.091				
All engines	-air conditioning											1.500.839
ENGINE												
1.1	Petrol	34	10/84-12/96	C1E 750, C1E 752, C1E 754								
Engine	Information				A10	A20	A40	A50	A70	C10 - C30	C20	E01
Eng. C1E 752, C1E 754	version Ducellier						1.315.054	1.415.091				
All engines	-air conditioning											1.500.839

A10 CONDENSER	A20 CONTACT SET	A40 DISTRIBUTOR CAP	A50 ROTOR	A70 PICK-UP
C10 COIL	C20 IGNITION MODULE	C30 ELECTRONIC IGNITION KIT	E01 IGNITION CABLE SET	

Vehicle	alim.	kW	Date	Engine	FUNCTIONS ON THE VEHICLE								
					A10	A20	A40	A50	A70	C10 - C30	C20	E01	
1.2	Petrol	40	01/87-08/90	ENGINE C1G 702, C1G 720, C1G 722									
Engine	Information			A10	A20	A40	A50	A70	C10 - C30	C20	E01		
Eng. C1G 702	version Ducellier					1.315.059							
Eng. C1G 720, C1G 722	distr. num. 525352A, version Ducellier					1.315.091							
Eng. C1G 702	distr. num. 525352A, version Ducellier						1.415.088						
Eng. C1G 702	distr. num. 525352E, version Ducellier						1.415.094						
All engines									1.970.107	C10			
1.2	Petrol	44	01/87-12/96	ENGINE C1G 702									
Engine	Information			A10	A20	A40	A50	A70	C10 - C30	C20	E01		
All engines	version Ducellier					1.315.059							
All engines	distr. num. 525352A, version Ducellier						1.415.088						
All engines	distr. num. 525352E, version Ducellier						1.415.094						
All engines									1.970.107	C10			
1.4	Petrol	43	10/84-06/88	ENGINE C1J 768, C1J 780									
Engine	Information			A10	A20	A40	A50	A70	C10 - C30	C20	E01		
All engines	distr. num. 525352A, version Ducellier					1.315.091							
All engines									1.970.107	C10			
1.4	Petrol	44	09/85-08/90	ENGINE C2J 784, C3J 700									
Engine	Information			A10	A20	A40	A50	A70	C10 - C30	C20	E01		
All engines	distr. num. 525352A, version Ducellier					1.315.091							
All engines									1.970.107	C10			
1.4	Petrol	49	06/87-07/89	ENGINE C2J 782									
Engine	Information			A10	A20	A40	A50	A70	C10 - C30	C20	E01		
All engines	distr. num. 525352A, version Ducellier					1.315.091							
All engines									1.970.107	C10			
1.4	Petrol	52	10/84-07/89	ENGINE C2J 700, C2J 780, C2J 781, C2J 788, C2J 789, C2J 798									
Engine	Information			A10	A20	A40	A50	A70	C10 - C30	C20	E01		
Eng. C2J 798	version Ducellier					1.315.059							
Eng. C2J 700, C2J 780, C2J 781, C2J 788, C2J 789	distr. num. 525352A, version Ducellier					1.315.091							
Eng. C2J 798	distr. num. 525352A, version Ducellier						1.415.088						
Eng. C2J 798	distr. num. 525352E, version Ducellier						1.415.094						
All engines									1.970.107	C10			
1.4	Petrol	85	04/85-10/87	ENGINE C1J 788									
Engine	Information			A10	A20	A40	A50	A70	C10 - C30	C20	E01		
All engines	distr. num. 525352A, version Ducellier					1.315.091							
All engines									1.970.107	C10			
1.4 Cat	Petrol	43	10/85-12/96	ENGINE C3J 700, C3J 702, C3J 760									
Engine	Information			A10	A20	A40	A50	A70	C10 - C30	C20	E01		
All engines	distr. num. 525352A, version Ducellier					1.315.091							
All engines									1.970.107	C10			
1.4 Turbo	Petrol	85	08/85-06/89	ENGINE C1J 788									
Engine	Information			A10	A20	A40	A50	A70	C10 - C30	C20	E01		
All engines	distr. num. 525352A, version Ducellier					1.315.091							
All engines									1.970.107	C10			
1.4 Turbo	Petrol	88	04/85-08/90	ENGINE C1J 782, C1J 784, C1J 788									
Engine	Information			A10	A20	A40	A50	A70	C10 - C30	C20	E01		
Eng. C1J 784	version Ducellier					1.315.059							
Eng. C1J 782, C1J 788	distr. num. 525352A, version Ducellier					1.315.091							
A10	CONDENSER	A20	CONTACT SET	A40	DISTRIBUTOR CAP	A50	ROTOR	A70	PICK-UP				
C10	COIL	C20	IGNITION MODULE	C30	ELECTRONIC IGNITION KIT	E01	IGNITION CABLE SET						

FUNCTIONS ON THE VEHICLE

Vehicle	alim.	kW	Date	Engine	 A10	 A20	 A40	 A50	 A70	 C10 - C30	 C20	 E01
---------	-------	----	------	--------	---	---	---	--	---	---	---	---

				ENGINE
1.4 Turbo	Petrol	88	04/85-08/90	C1J 782, C1J 784, C1J 788

Engine	Information	A10	A20	A40	A50	A70	C10 - C30	C20	E01
Eng. C1J 784	distr. num. 525352A, version Ducellier				1.415.088				
Eng. C1J 784	distr. num. 525352E, version Ducellier				1.415.094				
All engines							1.970.107	C10	

				ENGINE
1.7	Petrol	54	10/86-03/95	F3N 716, F3N 717

Engine	Information	A10	A20	A40	A50	A70	C10 - C30	C20	E01
All engines	version Ducellier			1.315.069	1.415.097				
All engines	Kit, version Ducellier			1.315.072					
All engines							1.970.107	C10	

				ENGINE
1.7	Petrol	64	06/87-03/95	F2N 740, F2N 742

Engine	Information	A10	A20	A40	A50	A70	C10 - C30	C20	E01
All engines	version Ducellier			1.315.069	1.415.097				
All engines	Kit, version Ducellier			1.315.072					
All engines							1.970.107	C10	

				ENGINE
1.7	Petrol	66	09/88-09/90	F2N 740

Engine	Information	A10	A20	A40	A50	A70	C10 - C30	C20	E01
All engines	version Ducellier			1.315.069	1.415.097				
All engines	Kit, version Ducellier			1.315.072					
All engines							1.970.107	C10	

				ENGINE
1.7i	Petrol	69	10/86-08/91	F3N 702

Engine	Information	A10	A20	A40	A50	A70	C10 - C30	C20	E01
All engines	version Ducellier			1.315.069	1.415.097				
All engines	Kit, version Ducellier			1.315.072					
All engines							1.970.107	C10	

TALISMAN

				ENGINE
1.6 TCe 150	Petrol	110	11/15->	M5M 450

Engine	Information	A10	A20	A40	A50	A70	C10 - C30	C20	E01
All engines	x 4, COIL ON PLUG						1.970.551	C10	

				ENGINE
1.6 TCe 200	Petrol	147	11/15->	M5M 450

Engine	Information	A10	A20	A40	A50	A70	C10 - C30	C20	E01
All engines	x 4, COIL ON PLUG						1.970.551	C10	

				ENGINE
1.8 TCe 225	Petrol	165	09/18->	M5P 403

Engine	Information	A10	A20	A40	A50	A70	C10 - C30	C20	E01
All engines	x 4, COIL ON PLUG						1.970.551	C10	

THALIA I

				ENGINE
1.2i 16V	Petrol	55	04/04->	D4F 728

Engine	Information	A10	A20	A40	A50	A70	C10 - C30	C20	E01
All engines							1.970.518	C10	1.499.246

				ENGINE
1.4	Petrol	55	08/00->	K7J 700

Engine	Information	A10	A20	A40	A50	A70	C10 - C30	C20	E01
All engines									1.499.252

				ENGINE
1.4	Petrol	72	05/00-02/09	K7J 700, K7J718

Engine	Information	A10	A20	A40	A50	A70	C10 - C30	C20	E01
Eng. K7J718	x 1, D.I.S.						1.970.596	C10	
Eng. K7J 700									1.499.252

				ENGINE
1.4 16V	Petrol	72	08/00->	K4J 713

Engine	Information	A10	A20	A40	A50	A70	C10 - C30	C20	E01
All engines	Qty: 4						1.970.432	C10	

A10 CONDENSER	A20 CONTACT SET	A40 DISTRIBUTOR CAP	A50 ROTOR	A70 PICK-UP
C10 COIL	C20 IGNITION MODULE	C30 ELECTRONIC IGNITION KIT	E01 IGNITION CABLE SET	

Vehicle	alim.	kW	Date	Engine	FUNCTIONS ON THE VEHICLE									
					A10	A20	A40	A50	A70	C10 - C30	C20	E01		
ENGINE														
1.6	Petrol	79	01/01->	K4M 745										
ENGINE														
Engine Information					A10	A20	A40	A50	A70	C10 - C30	C20	E01		
All engines Qty: 4										1.970.432	C10			
THALIA II														
1.2 16V	Petrol	55	09/08-06/14	D4F 728, D4F736										
ENGINE														
Engine Information					A10	A20	A40	A50	A70	C10 - C30	C20	E01		
All engines x 1, D.I.S.										1.970.518	C10			
1.4	Petrol	55	09/08-06/14	K7J 700										
ENGINE														
Engine Information					A10	A20	A40	A50	A70	C10 - C30	C20	E01		
All engines x 1, D.I.S.										1.970.596	C10			
All engines													1.499.252	
1.4	Petrol	72	01/09-12/11	K4J 712, K4J 713										
ENGINE														
Engine Information					A10	A20	A40	A50	A70	C10 - C30	C20	E01		
All engines x 4, SAGEM, COIL ON PLUG										1.970.432	C10			
1.6 16V	Petrol	77	09/08->	K4M 670, K4M 674, K4M 744										
ENGINE														
Engine Information					A10	A20	A40	A50	A70	C10 - C30	C20	E01		
Eng. K4M 670, K4M 674 x 4, SAGEM, COIL ON PLUG										1.970.432	C10			
Eng. K4M 744 Qty: 4										1.970.432	C10			
TRAFIC I														
1.4	Petrol	35	03/80-06/91	C1J 700										
ENGINE														
Engine Information					A10	A20	A40	A50	A70	C10 - C30	C20	E01		
All engines version Ducellier							1.315.054							
All engines ->year 30/09/90, version Ducellier								1.415.091						
All engines 01/10/90 ->, version Ducellier								1.415.094						
1.7	Petrol	50	05/89-08/94	F1N 720, F1N 722, F1N 724										
ENGINE														
Engine Information					A10	A20	A40	A50	A70	C10 - C30	C20	E01		
All engines version Ducellier							1.315.069	1.415.097						
All engines Kit, version Ducellier							1.315.072							
All engines										1.970.107	C10			
2.0	Petrol	59	05/89-08/90	J5R 716, J5R 726										
ENGINE														
Engine Information					A10	A20	A40	A50	A70	C10 - C30	C20	E01		
Eng. J5R 716 version Ducellier							1.315.079	1.415.094						
Eng. J5R 726 version Ducellier							1.315.081	1.415.101						
All engines										1.970.107	C10			
2.0 RWD	Petrol	59	05/89-10/97	J5R 726										
ENGINE														
Engine Information					A10	A20	A40	A50	A70	C10 - C30	C20	E01		
All engines version Ducellier							1.315.081	1.415.101						
All engines										1.970.107	C10			
2.2	Petrol	70	05/89-06/94	J7T 780										
ENGINE														
Engine Information					A10	A20	A40	A50	A70	C10 - C30	C20	E01		
All engines							1.315.065			1.970.107	C10		1.500.539	
All engines version Ducellier							1.315.066	1.415.094						
2.2	Petrol	74	06/94-04/98	J7T 600										
ENGINE														
Engine Information					A10	A20	A40	A50	A70	C10 - C30	C20	E01		
All engines							1.315.065			1.970.107	C10		1.500.539	
All engines version Ducellier							1.315.066	1.415.094						

A10	CONDENSER	A20	CONTACT SET	A40	DISTRIBUTOR CAP	A50	ROTOR	A70	PICK-UP
C10	COIL	C20	IGNITION MODULE	C30	ELECTRONIC IGNITION KIT	E01	IGNITION CABLE SET		

The present application list is a brief version. For the detailed information about the possibility of installation on a specific vehicle, please refer to our web-catalogue <http://catalogo.facet.eu/>

Vehicle	alim.	kW	Date	Engine	FUNCTIONS ON THE VEHICLE							
					A10	A20	A40	A50	A70	C10 - C30	C20	E01

2.2 4x4	Petrol	70	05/89-06/94	ENGINE J7T 780
----------------	--------	-----------	-------------	---------------------------------

Engine	Information	A10	A20	A40	A50	A70	C10 - C30	C20	E01
All engines				1.315.065			1.970.107	C10	1.500.539
All engines	version Ducellier			1.315.066	1.415.094				

2.2 4x4	Petrol	74	06/94-04/98	ENGINE J7T 600
----------------	--------	-----------	-------------	---------------------------------

Engine	Information	A10	A20	A40	A50	A70	C10 - C30	C20	E01
All engines				1.315.065			1.970.107	C10	1.500.539
All engines	version Ducellier			1.315.066	1.415.094				

TRAFIC II

2.0	Petrol	88	03/01->	ENGINE F4R 720, F4R 722
------------	--------	-----------	---------	--

Engine	Information	A10	A20	A40	A50	A70	C10 - C30	C20	E01
Eng. F4R 720	x 4, SAGEM, COIL ON PLUG						1.970.432	C10	
Eng. F4R 722	Qty: 4						1.970.432	C10	

2.0 16V	Petrol	86	08/06->	ENGINE F4R 820
----------------	--------	-----------	---------	---------------------------------

Engine	Information	A10	A20	A40	A50	A70	C10 - C30	C20	E01
All engines	x 4, SAGEM, COIL ON PLUG						1.970.432	C10	

TWINGO I

1.0 16V	Petrol	51	01/01->	ENGINE D4D 712
----------------	--------	-----------	---------	---------------------------------

Engine	Information	A10	A20	A40	A50	A70	C10 - C30	C20	E01
All engines							1.970.419	C10	

1.2	Petrol	40	03/93-03/07	ENGINE C3G 700, C3G 702, D7F 700, D7F 701
------------	--------	-----------	-------------	--

Engine	Information	A10	A20	A40	A50	A70	C10 - C30	C20	E01
Eng. C3G 700, C3G 702	version Ducellier			1.315.059	1.415.088				
Eng. C3G 700, C3G 702							1.970.228	C10	1.501.332
Eng. D7F 700, D7F 701	->year 21/10/98						1.970.365	C10	
Eng. D7F 700, D7F 701	21/10/98 ->						1.970.596	C10	
Eng. D7F 700, D7F 701	->year 08/10/99								1.501.447
Eng. D7F 700, D7F 701	08/10/99 ->								1.501.681

1.2	Petrol	43	05/96-06/07	ENGINE D7F 700, D7F 701, D7F 702, D7F 703, D7F 704, D7F 706
------------	--------	-----------	-------------	--

Engine	Information	A10	A20	A40	A50	A70	C10 - C30	C20	E01
All engines	->year 21/10/98						1.970.365	C10	
All engines	21/10/98 ->						1.970.596	C10	
All engines	->year 08/10/99								1.501.447
All engines	08/10/99 ->								1.501.681

1.2	Petrol	44	09/98-08/00	ENGINE D7F 702, D7F 703, D7F 704
------------	--------	-----------	-------------	---

Engine	Information	A10	A20	A40	A50	A70	C10 - C30	C20	E01
All engines	->year 21/10/98						1.970.365	C10	
All engines	21/10/98 ->						1.970.596	C10	
All engines	->year 08/10/99								1.501.447
All engines	08/10/99 ->								1.501.681

1.2 16V	Petrol	44	08/04-06/07	ENGINE D4F 708
----------------	--------	-----------	-------------	---------------------------------

Engine	Information	A10	A20	A40	A50	A70	C10 - C30	C20	E01
All engines							1.970.518	C10	1.499.246

1.2 16V	Petrol	55	01/01-06/07	ENGINE D4F 702
----------------	--------	-----------	-------------	---------------------------------

Engine	Information	A10	A20	A40	A50	A70	C10 - C30	C20	E01
All engines							1.970.419	C10	

A10 CONDENSER	A20 CONTACT SET	A40 DISTRIBUTOR CAP	A50 ROTOR	A70 PICK-UP
C10 COIL	C20 IGNITION MODULE	C30 ELECTRONIC IGNITION KIT	E01 IGNITION CABLE SET	

Vehicle	alim.	kW	Date	Engine	FUNCTIONS ON THE VEHICLE									
					A10	A20	A40	A50	A70	C10 - C30	C20	E01		
TWINGO II														
1.2	Petrol	43	03/07-09/14	ENGINE D7F 800										
Engine	Information				A10	A20	A40	A50	A70	C10 - C30	C20	E01		
All engines	x 1, D.I.S.									1.970.596	C10			
All engines													1.499.230	
1.2	Petrol	55	09/10-09/14	ENGINE D4F 770										
Engine	Information				A10	A20	A40	A50	A70	C10 - C30	C20	E01		
All engines	x 1, D.I.S.									1.970.518	C10			
All engines													1.499.246	
1.2 16V	Petrol	55	03/07->	ENGINE D4F 764, D4F 770, D4F 772										
Engine	Information				A10	A20	A40	A50	A70	C10 - C30	C20	E01		
Eng. D4F 764										1.970.518	C10			
Eng. D4F 770, D4F 772	x 1, D.I.S.									1.970.518	C10			
All engines													1.499.246	
1.2 16V	Petrol	56	03/07->	ENGINE D4F 772										
Engine	Information				A10	A20	A40	A50	A70	C10 - C30	C20	E01		
All engines	x 1, D.I.S.									1.970.518	C10			
All engines													1.499.246	
1.2 TCe 100	Petrol	75	02/11->	ENGINE D4F 780, D4F 782										
Engine	Information				A10	A20	A40	A50	A70	C10 - C30	C20	E01		
Eng. D4F 780	x 1, D.I.S.									1.970.596	C10			
Eng. D4F 782										1.970.596	C10			
All engines													1.499.229	
1.2 Turbo	Petrol	74	03/07-09/14	ENGINE D4F 780, D4F 782										
Engine	Information				A10	A20	A40	A50	A70	C10 - C30	C20	E01		
All engines	x 1, D.I.S.									1.970.596	C10			
All engines													1.499.229	
1.6 RS	Petrol	98	05/08-09/14	ENGINE K4M 854										
Engine	Information				A10	A20	A40	A50	A70	C10 - C30	C20	E01		
All engines	x 4, SAGEM, COIL ON PLUG									1.970.432	C10			
All engines													1.499.229	
TWINGO III														
0.9 TCe 110	Petrol	80	11/16->	ENGINE H4B 401										
Engine	Information				A10	A20	A40	A50	A70	C10 - C30	C20	E01		
All engines	x 3, COIL ON PLUG									1.970.613	C10			
All engines													1.499.229	
0.9 TCe 90	Petrol	66	09/14->	ENGINE H4B 401										
Engine	Information				A10	A20	A40	A50	A70	C10 - C30	C20	E01		
All engines	x 3, COIL ON PLUG									1.970.613	C10			
All engines													1.499.229	
0.9 TCe 90 LPG	Petrol/ Liquified Petroleum Gas (LPG)	66	08/18->	ENGINE H4B 451										
Engine	Information				A10	A20	A40	A50	A70	C10 - C30	C20	E01		
All engines	x 3, COIL ON PLUG									1.970.613	C10			
All engines													1.499.229	
0.9 TCe 95	Petrol	68	03/19->	ENGINE H4B 453										
Engine	Information				A10	A20	A40	A50	A70	C10 - C30	C20	E01		
All engines	x 3, COIL ON PLUG									1.970.552	C10			
All engines													1.499.229	
1.0 S Ce 70	Petrol	51	09/15->	ENGINE H4D 400										
Engine	Information				A10	A20	A40	A50	A70	C10 - C30	C20	E01		
All engines	x 3, COIL ON PLUG									1.970.613	C10			
All engines													1.499.229	

A10 CONDENSER	A20 CONTACT SET	A40 DISTRIBUTOR CAP	A50 ROTOR	A70 PICK-UP
C10 COIL	C20 IGNITION MODULE	C30 ELECTRONIC IGNITION KIT	E01 IGNITION CABLE SET	

The present application list is a brief version. For the detailed information about the possibility of installation on a specific vehicle, please refer to our web-catalogue <http://catalogo.facet.eu/>

Vehicle	alim.	kW	Date	Engine	FUNCTIONS ON THE VEHICLE							
					A10	A20	A40	A50	A70	C10 - C30	C20	E01

4/72

				ENGINE
1.7	Petrol	51	03/61-10/68	--

Engine	Information	A10	A20	A40	A50	A70	C10 - C30	C20	E01
All engines				1.328.075	1.428.006				

ELF

				ENGINE
1.0	Petrol	28	03/63-10/68	--

Engine	Information	A10	A20	A40	A50	A70	C10 - C30	C20	E01
All engines				1.328.075	1.428.006				

KESTREL

				ENGINE
1100	Petrol	40	03/65-04/67	--, 10 H

Engine	Information	A10	A20	A40	A50	A70	C10 - C30	C20	E01
All engines					1.428.006				

				ENGINE
1300	Petrol	52	03/67-12/69	12 H

Engine	Information	A10	A20	A40	A50	A70	C10 - C30	C20	E01
All engines				1.328.075	1.428.006				

A10	CONDENSER	A20	CONTACT SET	A40	DISTRIBUTOR CAP	A50	ROTOR	A70	PICK-UP
C10	COIL	C20	IGNITION MODULE	C30	ELECTRONIC IGNITION KIT	E01	IGNITION CABLE SET		

The present application list is a brief version. For the detailed information about the possibility of installation on a specific vehicle, please refer to our web-catalogue <http://catalogo.facet.eu/>







Vehicle	alim.	kW	Date	Engine	FUNCTIONS ON THE VEHICLE								
					A10	A20	A40	A50	A70	C10 - C30	C20	E01	
CULLINAN													
V12	Petrol	420	08/18->	ENGINE N74 B68 A									
Engine	Information				A10	A20	A40	A50	A70	C10 - C30	C20	E01	
All engines	x 12, DELPHI, COIL ON PLUG									1.970.475	C10		
DAWN													
V12	Petrol	441	08/19->	ENGINE N74 B68 A									
Engine	Information				A10	A20	A40	A50	A70	C10 - C30	C20	E01	
All engines	x 12, DELPHI, COIL ON PLUG									1.970.475	C10		
GHOST													
V12	Petrol	420	12/09->	ENGINE N74 B66 A, N74 B68 A									
Engine	Information				A10	A20	A40	A50	A70	C10 - C30	C20	E01	
All engines	x 12, DELPHI, COIL ON PLUG									1.970.475	C10		
V12	Petrol	442	07/17->	ENGINE N74 B66 A									
Engine	Information				A10	A20	A40	A50	A70	C10 - C30	C20	E01	
All engines	x 12, DELPHI, COIL ON PLUG									1.970.475	C10		
V-Specification													
V12	Petrol	450	03/16-03/20	ENGINE N74 B66 A									
Engine	Information				A10	A20	A40	A50	A70	C10 - C30	C20	E01	
All engines	x 12, DELPHI, COIL ON PLUG									1.970.475	C10		
PHANTOM													
6.75 V12	Petrol	338	06/07-07/17	ENGINE N73 B68 A									
Engine	Information				A10	A20	A40	A50	A70	C10 - C30	C20	E01	
All engines	x 12, COIL ON PLUG, DELPHI, ELDOR, COIL ON PLUG									1.970.475	C10		
V12	Petrol	338	01/03-07/17	ENGINE N73 B68 A									
Engine	Information				A10	A20	A40	A50	A70	C10 - C30	C20	E01	
All engines	x 12, COIL ON PLUG, DELPHI, ELDOR, COIL ON PLUG									1.970.475	C10		
V12, V12 EWB	Petrol	420	09/17->	ENGINE N74 B68 A									
Engine	Information				A10	A20	A40	A50	A70	C10 - C30	C20	E01	
All engines	x 12, DELPHI, COIL ON PLUG									1.970.475	C10		
WRAITH													
V12	Petrol	441	07/19->	ENGINE N74 B66 A									
Engine	Information				A10	A20	A40	A50	A70	C10 - C30	C20	E01	
All engines	x 12, DELPHI, COIL ON PLUG									1.970.475	C10		
V12	Petrol	465	08/13->	ENGINE N74 B66 A									
Engine	Information				A10	A20	A40	A50	A70	C10 - C30	C20	E01	
All engines	x 12, DELPHI, COIL ON PLUG									1.970.475	C10		

A10 CONDENSER	A20 CONTACT SET	A40 DISTRIBUTOR CAP	A50 ROTOR	A70 PICK-UP
C10 COIL	C20 IGNITION MODULE	C30 ELECTRONIC IGNITION KIT	E01 IGNITION CABLE SET	

Vehicle	alim.	kW	Date	Engine	FUNCTIONS ON THE VEHICLE									
					A10	A20	A40	A50	A70	C10 - C30	C20	E01		
100														
111	Petrol	44	04/94-10/97	ENGINE 11 K2D										
Engine	Information				A10	A20	A40	A50	A70	C10 - C30	C20	E01		
All engines	version Lucas						1.328.093	1.428.029R						
114														
114	Petrol	55	04/94-10/97	ENGINE 14 K2A, 14 K2D										
Engine	Information				A10	A20	A40	A50	A70	C10 - C30	C20	E01		
Eng. 14 K2D	version Lucas						1.328.093	1.428.029R						
Eng. 14 K2A	version Lucas						1.328.094	1.428.025						
100 / METRO														
111 C/L/S	Petrol	44	03/90-12/98	ENGINE 11 K2A, 11 K2D										
Engine	Information				A10	A20	A40	A50	A70	C10 - C30	C20	E01		
Eng. 11 K2D	version Lucas						1.328.093	1.428.029R						
Eng. 11 K2A	version Lucas						1.328.094	1.428.025						
114 GSi														
114 GSi	Petrol	76	10/94-10/95	ENGINE 14 K4F										
Engine	Information				A10	A20	A40	A50	A70	C10 - C30	C20	E01		
All engines	version Lucas						1.328.093	1.428.029R						
114 GTI 16V														
114 GTI 16V	Petrol	69	03/90-08/91	ENGINE 14 K4C, 14 K4D										
Engine	Information				A10	A20	A40	A50	A70	C10 - C30	C20	E01		
All engines	version Lucas						1.328.093	1.428.029R						
114 GTI 16V														
114 GTI 16V	Petrol	76	08/91-12/98	ENGINE 14 K4F										
Engine	Information				A10	A20	A40	A50	A70	C10 - C30	C20	E01		
All engines	version Lucas						1.328.093	1.428.029R						
114 GTI/GT 16V Cat														
114 GTI/GT 16V Cat	Petrol	66	03/90-12/98	ENGINE 14 K4C, 14 K4D										
Engine	Information				A10	A20	A40	A50	A70	C10 - C30	C20	E01		
All engines	version Lucas						1.328.093	1.428.029R						
114 S/L/GTA														
114 S/L/GTA	Petrol	55	03/90-12/98	ENGINE 14 K2A, 14 K2D										
Engine	Information				A10	A20	A40	A50	A70	C10 - C30	C20	E01		
Eng. 14 K2D	version Lucas						1.328.093	1.428.029R						
Eng. 14 K2A	version Lucas						1.328.094	1.428.025						
200 I														
213 S	Petrol	54	09/85-09/89	ENGINE EV 2										
Engine	Information				A10	A20	A40	A50	A70	C10 - C30	C20	E01		
All engines	version Mitsubishi						1.322.022	1.422.056						
200 II														
214	Petrol	55	09/93-12/95	ENGINE 14 K2A, 14 K2D										
Engine	Information				A10	A20	A40	A50	A70	C10 - C30	C20	E01		
All engines	version Lucas						1.328.093							
All engines								1.428.029R						
214 1.4														
214 1.4	Petrol	66	01/92-11/99	ENGINE 14 K4C, 14 K4D										
Engine	Information				A10	A20	A40	A50	A70	C10 - C30	C20	E01		
All engines	version Lucas						1.328.093	1.428.029R						
214 1.4i 16V														
214 1.4i 16V	Petrol	76	01/93-11/99	ENGINE 14 K4F										
Engine	Information				A10	A20	A40	A50	A70	C10 - C30	C20	E01		
All engines	version Lucas						1.328.093	1.428.029R						
214 GSi/Si														
214 GSi/Si	Petrol	70	01/90-10/95	ENGINE 14 K4C										
Engine	Information				A10	A20	A40	A50	A70	C10 - C30	C20	E01		
All engines	version Lucas						1.328.093	1.428.029R						
All engines	01/01/95 ->									1.970.374	C10			

A10 CONDENSER	A20 CONTACT SET	A40 DISTRIBUTOR CAP	A50 ROTOR	A70 PICK-UP
C10 COIL	C20 IGNITION MODULE	C30 ELECTRONIC IGNITION KIT	E01 IGNITION CABLE SET	

The present application list is a brief version. For the detailed information about the possibility of installation on a specific vehicle, please refer to our web-catalogue <http://catalogo.facet.eu/>

				FUNCTIONS ON THE VEHICLE								
Vehicle	alim.	kW	Date	Engine	 A10	 A20	 A40	 A50	 A70	 C10 - C30	 C20	 E01
				ENGINE								
214 GSi/Si	Petrol	76	12/92-10/95	14 K4F								
Engine		Information			A10	A20	A40	A50	A70	C10 - C30	C20	E01
All engines		version Lucas					1.328.093	1.428.029R				
				ENGINE								
214 Si/Gsi	Petrol	66	10/89-10/95	14 K4C, 14 K4D								
Engine		Information			A10	A20	A40	A50	A70	C10 - C30	C20	E01
All engines		version Lucas					1.328.093	1.428.029R				
				ENGINE								
216	Petrol	82	01/96-12/97	16 K4F								
Engine		Information			A10	A20	A40	A50	A70	C10 - C30	C20	E01
All engines		version Lucas					1.328.093					
All engines								1.428.029R				1.501.888
				ENGINE								
216	Petrol	90	10/92-06/99	D 16 A8								
Engine		Information			A10	A20	A40	A50	A70	C10 - C30	C20	E01
All engines										1.970.213	C10	1.965.052
				ENGINE								
216 1.6i	Petrol	90	01/92-11/99	D 16 A8								
Engine		Information			A10	A20	A40	A50	A70	C10 - C30	C20	E01
All engines										1.970.213	C10	1.965.052
				ENGINE								
216 1.6i 16V	Petrol	82	01/96-11/99	16 K4F								
Engine		Information			A10	A20	A40	A50	A70	C10 - C30	C20	E01
All engines		version Lucas					1.328.093					
All engines								1.428.029R				1.501.888
All engines		x 1, DISTRIBUTOR								1.970.374	C10	
				ENGINE								
216 GSi	Petrol	82	01/90-12/95	1GH5E-180								
Engine		Information			A10	A20	A40	A50	A70	C10 - C30	C20	E01
All engines		->eng. E100000, version Hitachi					1.322.069					
All engines		eng. type E100001 ->, version Hitachi						1.422.082				
All engines										1.970.213	C10	1.965.052
				ENGINE								
216 GSi	Petrol	85	10/89-10/95	D 16 A7								
Engine		Information			A10	A20	A40	A50	A70	C10 - C30	C20	E01
All engines		->eng. E100000, version Hitachi					1.322.069					
All engines		eng. type E100001 ->, version Hitachi						1.422.082				
All engines										1.970.213	C10	
				ENGINE								
216 GTi	Petrol	90	01/90-10/95	D 16 A8								
Engine		Information			A10	A20	A40	A50	A70	C10 - C30	C20	E01
All engines		->eng. E100000, version Hitachi					1.322.069	1.422.082				
All engines										1.970.213	C10	1.965.052
				ENGINE								
216 GTi	Petrol	96	09/90-10/95	D 16 A9								
Engine		Information			A10	A20	A40	A50	A70	C10 - C30	C20	E01
All engines		->eng. E100000, version Hitachi					1.322.069	1.422.082				
All engines										1.970.213	C10	
				ENGINE								
220 GSi	Petrol	100	05/94-06/99	1CA4GA15-01								
Engine		Information			A10	A20	A40	A50	A70	C10 - C30	C20	E01
All engines		version Lucas					1.328.093					
All engines								1.428.029R				
				ENGINE								
220 GTi	Petrol	100	01/93-10/95	1CA4GA15-01								
Engine		Information			A10	A20	A40	A50	A70	C10 - C30	C20	E01
All engines		version Lucas					1.328.093					
All engines								1.428.029R				

A10 CONDENSER	A20 CONTACT SET	A40 DISTRIBUTOR CAP	A50 ROTOR	A70 PICK-UP
C10 COIL	C20 IGNITION MODULE	C30 ELECTRONIC IGNITION KIT	E01 IGNITION CABLE SET	

Vehicle	alim.	kW	Date	Engine	FUNCTIONS ON THE VEHICLE									
					A10	A20	A40	A50	A70	C10 - C30	C20	E01		
220 GTi					ENGINE									
Petrol	103	09/91-10/95	20 M4F											
Engine	Information				A10	A20	A40	A50	A70	C10 - C30	C20	E01		
All engines	version Lucas						1.328.093							
All engines	->year 31/01/92, version Lucas							1.428.024R						
All engines	01/02/92 ->, version Lucas							1.428.029R						
220 Turbo					ENGINE									
Petrol	147	10/92-06/99	20 T4G											
Engine	Information				A10	A20	A40	A50	A70	C10 - C30	C20	E01		
All engines	version Lucas						1.328.093							
All engines								1.428.029R						
200 III					ENGINE									
1.4	Petrol	66	01/96-12/97	14 K4D										
Engine	Information				A10	A20	A40	A50	A70	C10 - C30	C20	E01		
All engines	x 1, DISTRIBUTOR									1.970.374	C10			
211					ENGINE									
Petrol	44	01/98-03/00	11 K2D											
Engine	Information				A10	A20	A40	A50	A70	C10 - C30	C20	E01		
All engines	version Lucas						1.328.093	1.428.029R						
All engines	x 1, DISTRIBUTOR									1.970.374	C10			
All engines													1.501.914	
214 i					ENGINE									
Petrol	55	11/95-03/00	14 K2F											
Engine	Information				A10	A20	A40	A50	A70	C10 - C30	C20	E01		
All engines	version Lucas						1.328.093	1.428.029R						
All engines	x 1, DISTRIBUTOR									1.970.374	C10			
All engines													1.501.914	
214 Si					ENGINE									
Petrol	76	11/95-03/00	14 K4F											
Engine	Information				A10	A20	A40	A50	A70	C10 - C30	C20	E01		
All engines	->ch. YD471564, version Lucas						1.328.093	1.428.029R						
All engines	x 1, DISTRIBUTOR									1.970.374	C10			
All engines	->ch. YD471564												1.501.888	
All engines	ch. YD471565 ->												1.501.889	
216 Si					ENGINE									
Petrol	82	11/95-06/99	16 K4F											
Engine	Information				A10	A20	A40	A50	A70	C10 - C30	C20	E01		
All engines	->ch. YD471564, version Lucas						1.328.093	1.428.029R						
All engines	->ch. 471564, x 1, DISTRIBUTOR									1.970.374	C10			
All engines	->ch. YD471564												1.501.888	
All engines	ch. YD471565 ->												1.501.889	
2000-3500					ENGINE									
2000	Petrol	74	10/82-10/86	--										
Engine	Information				A10	A20	A40	A50	A70	C10 - C30	C20	E01		
All engines	version Lucas						1.328.094	1.428.026R						
2200					ENGINE									
Petrol	83	10/73-05/76	--											
Engine	Information				A10	A20	A40	A50	A70	C10 - C30	C20	E01		
All engines							1.228.083MHV	1.328.075						
25					ENGINE									
1.1	Petrol	44	11/99-05/05	11K2F										
Engine	Information				A10	A20	A40	A50	A70	C10 - C30	C20	E01		
All engines	x 1, DISTRIBUTOR									1.970.374	C10			
1.1					ENGINE									
Petrol	55	09/99-06/01	11 K4F											
Engine	Information				A10	A20	A40	A50	A70	C10 - C30	C20	E01		
All engines	x 1, DISTRIBUTOR									1.970.374	C10			









A10 CONDENSER	A20 CONTACT SET	A40 DISTRIBUTOR CAP	A50 ROTOR	A70 PICK-UP
C10 COIL	C20 IGNITION MODULE	C30 ELECTRONIC IGNITION KIT	E01 IGNITION CABLE SET	

The present application list is a brief version. For the detailed information about the possibility of installation on a specific vehicle, please refer to our web-catalogue <http://catalogo.facet.eu/>

				FUNCTIONS ON THE VEHICLE								
Vehicle	alim.	kW	Date	Engine	 A10	 A20	 A40	 A50	 A70	 C10 - C30	 C20	 E01
				ENGINE								
1.1 16V	Petrol	55	01/04-05/05	11 K4F								
				ENGINE								
Engine		Information			A10	A20	A40	A50	A70	C10 - C30	C20	E01
All engines		x 1, DISTRIBUTOR								1.970.374	C10	
1.4	Petrol	62	01/03-12/05	14 K4M								
				ENGINE								
Engine		Information			A10	A20	A40	A50	A70	C10 - C30	C20	E01
All engines		->ch. 471564, x 1, DISTRIBUTOR								1.970.374	C10	
1.4 16V	Petrol	62	10/99-05/05	14 K4M								
				ENGINE								
Engine		Information			A10	A20	A40	A50	A70	C10 - C30	C20	E01
All engines		->ch. YD471564, version Lucas					1.328.093	1.428.029R				
All engines		->ch. 471564, x 1, DISTRIBUTOR								1.970.374	C10	
All engines		->ch. YD471564										1.501.888
All engines		ch. YD471565 ->										1.501.889
1.4 16V	Petrol	76	10/99-05/05	14 K4F								
				ENGINE								
Engine		Information			A10	A20	A40	A50	A70	C10 - C30	C20	E01
All engines		->ch. YD471564, version Lucas					1.328.093	1.428.029R				
All engines		->ch. 471564, x 1, DISTRIBUTOR								1.970.374	C10	
All engines		->ch. YD471564										1.501.888
All engines		ch. YD471565 ->										1.501.889
1.6 16V	Petrol	80	10/99-05/05	16 K4F								
				ENGINE								
Engine		Information			A10	A20	A40	A50	A70	C10 - C30	C20	E01
All engines		->ch. YD471564, version Lucas					1.328.093	1.428.029R				
All engines		->ch. 471564, x 1, DISTRIBUTOR								1.970.374	C10	
All engines		->ch. YD471564										1.501.888
All engines		ch. YD471565 ->										1.501.889
1.8 16V	Petrol	85	10/99-05/05	18 K4F								
				ENGINE								
Engine		Information			A10	A20	A40	A50	A70	C10 - C30	C20	E01
All engines		->ch. YD471564, version Lucas					1.328.093	1.428.029R				
All engines		->ch. 471564, x 1, DISTRIBUTOR								1.970.374	C10	
All engines		->ch. YD471564										1.501.888
All engines		ch. YD471565 ->										1.501.889
400 I												
				ENGINE								
1.6 i	Petrol	82	05/94-11/98	16 K4F								
				ENGINE								
Engine		Information			A10	A20	A40	A50	A70	C10 - C30	C20	E01
All engines		version Lucas					1.328.093					
All engines								1.428.029R		1.970.374	C10	1.501.888
1.6 i	Petrol	90	05/94-11/98	D 16 A8								
				ENGINE								
Engine		Information			A10	A20	A40	A50	A70	C10 - C30	C20	E01
All engines		version Lucas					1.328.093					
All engines								1.428.029R		1.970.374	C10	1.501.888
2.0 i	Petrol	100	05/94-11/98	1CA4GA15-01								
				ENGINE								
Engine		Information			A10	A20	A40	A50	A70	C10 - C30	C20	E01
All engines										1.970.189	C10	
414	Petrol	70	01/93-04/95	14 K4C								
				ENGINE								
Engine		Information			A10	A20	A40	A50	A70	C10 - C30	C20	E01
All engines		version Lucas					1.328.093	1.428.029R				
All engines		01/01/95 ->								1.970.374	C10	
414 GSI/SI	Petrol	66	04/90-04/95	14 K4C, 14 K4D								
				ENGINE								
Engine		Information			A10	A20	A40	A50	A70	C10 - C30	C20	E01
All engines		version Lucas					1.328.093	1.428.029R				

A10 CONDENSER	A20 CONTACT SET	A40 DISTRIBUTOR CAP	A50 ROTOR	A70 PICK-UP
C10 COIL	C20 IGNITION MODULE	C30 ELECTRONIC IGNITION KIT	E01 IGNITION CABLE SET	

Vehicle	alim.	kW	Date	Engine	FUNCTIONS ON THE VEHICLE									
					A10	A20	A40	A50	A70	C10 - C30	C20	E01		
ENGINE														
414 GSI/SI Cat	Petrol	76	10/92-04/95	14 K4F										
Engine	Information				A10	A20	A40	A50	A70	C10 - C30	C20	E01		
All engines	version Lucas						1.328.093	1.428.029R						
ENGINE														
416 GSI	Petrol	82	04/90-04/95	1GH5E-180										
Engine	Information				A10	A20	A40	A50	A70	C10 - C30	C20	E01		
All engines										1.970.213	C10	1.965.052		
ENGINE														
416 GSI/GSE	Petrol	85	04/90-04/95	D 16 A7										
Engine	Information				A10	A20	A40	A50	A70	C10 - C30	C20	E01		
All engines										1.970.213	C10	1.965.052		
ENGINE														
416 GTI	Petrol	90	04/90-04/95	D 16 A8										
Engine	Information				A10	A20	A40	A50	A70	C10 - C30	C20	E01		
All engines										1.970.213	C10	1.965.052		
ENGINE														
416 GTI/GTE	Petrol	96	04/90-04/95	D 16 A9										
Engine	Information				A10	A20	A40	A50	A70	C10 - C30	C20	E01		
All engines	->eng. E100000, version Hitachi						1.322.069	1.422.082						
All engines										1.970.213	C10			
ENGINE														
420 GSI/SLI/GTI/Vite	Petrol	100	01/93-04/95	1CA4GA15-01										
Engine	Information				A10	A20	A40	A50	A70	C10 - C30	C20	E01		
All engines	version Lucas						1.328.093							
All engines								1.428.029R						
ENGINE														
420 GTI/GSI/Vitesse	Petrol	103	02/92-04/95	20 M4F										
Engine	Information				A10	A20	A40	A50	A70	C10 - C30	C20	E01		
All engines	version Lucas						1.328.093							
All engines	->year 31/01/92, version Lucas							1.428.024R						
All engines	01/02/92 ->, version Lucas							1.428.029R						
ENGINE														
420 Turbo	Petrol	147	01/93-04/95	20 T4G										
Engine	Information				A10	A20	A40	A50	A70	C10 - C30	C20	E01		
All engines	version Lucas						1.328.093							
All engines								1.428.029R						
ENGINE														
400 II														
ENGINE														
414	Petrol	55	03/96-12/99	14 K2F										
Engine	Information				A10	A20	A40	A50	A70	C10 - C30	C20	E01		
All engines	x 1, DISTRIBUTOR									1.970.374	C10			
ENGINE														
414 Si	Petrol	76	05/95-03/00	14 K4F										
Engine	Information				A10	A20	A40	A50	A70	C10 - C30	C20	E01		
All engines	version Lucas						1.328.093	1.428.029R						
All engines	x 1, DISTRIBUTOR									1.970.374	C10			
All engines												1.501.888		
ENGINE														
416 Si	Petrol	82	05/95-03/00	16 K4F										
Engine	Information				A10	A20	A40	A50	A70	C10 - C30	C20	E01		
All engines	version Lucas						1.328.093	1.428.029R						
All engines	ch. 74465 ->, x 1, DISTRIBUTOR									1.970.347	C10			
All engines	->ch. 74464, x 1, DISTRIBUTOR									1.970.374	C10			
All engines												1.501.888		
ENGINE														
416 Si	Petrol	83	03/95-03/00	D 16 Y2, D 16 Y3										
Engine	Information				A10	A20	A40	A50	A70	C10 - C30	C20	E01		
Eng. D 16 Y2	+automatic transmission, ->ch. AD074464, version Hitachi						1.322.068	1.422.095						
Eng. D 16 Y2	+automatic transmission, ->ch. AD250028, ch. AD074465 ->, version Hitachi						1.322.082	1.422.098						
Eng. D 16 Y2	+manual transmission, version Lucas						1.328.093							
A10	CONDENSER		A20	CONTACT SET		A40	DISTRIBUTOR CAP		A50	ROTOR		A70	PICK-UP	
C10	COIL		C20	IGNITION MODULE		C30	ELECTRONIC IGNITION KIT		E01	IGNITION CABLE SET				

				FUNCTIONS ON THE VEHICLE									
Vehicle	alim.	kW	Date	Engine									
				ENGINE									
416 Si	Petrol	83	03/95-03/00	D 16 Y2, D 16 Y3									
Engine	Information			A10	A20	A40	A50	A70	C10 - C30	C20	E01		
Eng. D 16 Y2	+automatic transmission, ch. WD250029 ->, version Lucas					1.328.106							
Eng. D 16 Y2	+automatic transmission, ch. WD250029 ->, version Hitachi						1.422.102						
Eng. D 16 Y2	+manual transmission						1.428.029R		1.970.374	C10		1.501.888	
Eng. D 16 Y2	+automatic transmission, ->ch. AD074464								1.970.214	C10			
Eng. D 16 Y3	->ch. 74464, x 1, DISTRIBUTOR								1.970.214	C10			
Eng. D 16 Y2	+automatic transmission, ->ch. AD250028, ch. AD074465 ->								1.970.347	C10			
Eng. D 16 Y3	ch. 74465 ->, x 1, DISTRIBUTOR								1.970.347	C10			
				ENGINE									
416 Si	Petrol	85	05/95-03/00	D16B2									
Engine	Information			A10	A20	A40	A50	A70	C10 - C30	C20	E01		
All engines	->ch. 74464, x 1, DISTRIBUTOR								1.970.214	C10			
All engines	ch. 74465 ->, x 1, DISTRIBUTOR								1.970.347	C10			
				ENGINE									
420 Si Lux	Petrol	100	12/95-03/00	1CA4GA15-01, 20 M4F									
Engine	Information			A10	A20	A40	A50	A70	C10 - C30	C20	E01		
Eng. 1CA4GA15-01									1.970.189	C10			
Eng. 20 M4F	x 1, D.I.S.								1.970.189	C10			
				ENGINE									
45													
				ENGINE									
1.4	Petrol	76	02/00-05/05	14 K4F									
Engine	Information			A10	A20	A40	A50	A70	C10 - C30	C20	E01		
All engines												1.501.889	
				ENGINE									
1.6	Petrol	80	02/00-05/05	16 K4F									
Engine	Information			A10	A20	A40	A50	A70	C10 - C30	C20	E01		
All engines												1.501.889	
				ENGINE									
1.8	Petrol	86	02/00-05/05	18 K4F									
Engine	Information			A10	A20	A40	A50	A70	C10 - C30	C20	E01		
All engines												1.501.889	
				ENGINE									
2.0 V6	Petrol	110	02/00-05/05	20 K4F									
Engine	Information			A10	A20	A40	A50	A70	C10 - C30	C20	E01		
All engines	x 1, LONG, SHORT, BREMI, D.I.S.								1.970.413	C10			
				ENGINE									
600													
				ENGINE									
618 i/Si	Petrol	85	03/96-02/99	F 18 A3									
Engine	Information			A10	A20	A40	A50	A70	C10 - C30	C20	E01		
All engines	->ch. AM246796, version Hitachi					1.322.068	1.422.095						
All engines	ch. BM246797 ->, version Hitachi					1.322.082	1.422.098						
All engines	->ch. AM246796								1.970.214	C10	1.965.052		
All engines	ch. BM246797 ->								1.970.347	C10			
All engines												1.501.711	
				ENGINE									
620 i	Petrol	85	08/93-06/96	F 20 Z2									
Engine	Information			A10	A20	A40	A50	A70	C10 - C30	C20	E01		
All engines	->ch. 246796, version Hitachi					1.322.068	1.422.095						
All engines	ch. 246797 ->, version Hitachi					1.322.082	1.422.098						
All engines	->ch. 246796								1.970.214	C10	1.965.052		
All engines	ch. 246797 ->								1.970.347	C10			
All engines												1.501.711	
				ENGINE									
620 Si	Petrol	96	08/93-02/99	F 20 Z1									
Engine	Information			A10	A20	A40	A50	A70	C10 - C30	C20	E01		
All engines	->ch. 246796, version Hitachi					1.322.068	1.422.095						
All engines	ch. 246797 ->, version Hitachi					1.322.082	1.422.098						
All engines	->ch. 246796								1.970.214	C10	1.965.052		
All engines	ch. 246797 ->								1.970.347	C10			
All engines												1.501.711	

A10 CONDENSER	A20 CONTACT SET	A40 DISTRIBUTOR CAP	A50 ROTOR	A70 PICK-UP
C10 COIL	C20 IGNITION MODULE	C30 ELECTRONIC IGNITION KIT	E01 IGNITION CABLE SET	

Vehicle	alim.	kW	Date	Engine	FUNCTIONS ON THE VEHICLE									
					A10	A20	A40	A50	A70	C10 - C30	C20	E01		
ENGINE														
620 Si	Petrol	96	08/93-02/99	F 20 Z1										
Engine	Information				A10	A20	A40	A50	A70	C10 - C30	C20	E01		
All engines													1.501.711	
ENGINE														
620 Ti Vitesse	Petrol	147	05/94-08/98	20 T4G										
Engine	Information				A10	A20	A40	A50	A70	C10 - C30	C20	E01		
All engines	->ch. AM246796, version Lucas						1.328.093	1.428.029R						
All engines	ch. BM246797 ->									1.970.189	C10			
ENGINE														
623 Si	Petrol	116	08/93-06/99	H 23 A3										
Engine	Information				A10	A20	A40	A50	A70	C10 - C30	C20	E01		
All engines	version Hitachi						1.322.068	1.422.095						
All engines										1.970.214	C10	1.965.052		
75														
ENGINE														
1.8	Petrol	88	02/99-05/05	K 1.8										
Engine	Information				A10	A20	A40	A50	A70	C10 - C30	C20	E01		
All engines													1.501.889	
ENGINE														
1.8 Turbo	Petrol	110	05/03-05/05	--										
Engine	Information				A10	A20	A40	A50	A70	C10 - C30	C20	E01		
All engines													1.501.889	
800														
ENGINE														
820	Petrol	74	10/88-10/91	--										
Engine	Information				A10	A20	A40	A50	A70	C10 - C30	C20	E01		
All engines	version Lucas						1.328.093	1.428.024R						
ENGINE														
820 16V Turbo	Petrol	132	11/91-02/99	T 16										
Engine	Information				A10	A20	A40	A50	A70	C10 - C30	C20	E01		
All engines	version Lucas						1.328.093	1.428.029R						
ENGINE														
820 I/SI	Petrol	100	01/91-02/99	1CA4GA15-01										
Engine	Information				A10	A20	A40	A50	A70	C10 - C30	C20	E01		
All engines	->ch. 230966, version Lucas						1.328.093	1.428.029R						
All engines	ch. 230967 ->									1.970.189	C10			
ENGINE														
820 i/Si	Petrol	103	10/88-12/91	20 HD										
Engine	Information				A10	A20	A40	A50	A70	C10 - C30	C20	E01		
All engines	version Lucas						1.328.093	1.428.024R						
ENGINE														
820 SI	Petrol	98	10/88-12/91	20 HD M 16										
Engine	Information				A10	A20	A40	A50	A70	C10 - C30	C20	E01		
All engines	version Lucas						1.328.093	1.428.024R						
ENGINE														
820 Sport	Petrol	145	04/94-03/96	20 T4G										
Engine	Information				A10	A20	A40	A50	A70	C10 - C30	C20	E01		
All engines	version Lucas						1.328.093	1.428.029R						
ENGINE														
827 24V	Petrol	124	08/92-02/99	C 27 A1										
Engine	Information				A10	A20	A40	A50	A70	C10 - C30	C20	E01		
All engines	+manual transmission									1.970.211	C10			
ENGINE														
827 24V I/SI Cat	Petrol	124	01/92-02/99	C 27 A1										
Engine	Information				A10	A20	A40	A50	A70	C10 - C30	C20	E01		
All engines	+manual transmission									1.970.211	C10			
ENGINE														
827 SI/Sterling	Petrol	130	02/88-12/91	82RZ-FE										
Engine	Information				A10	A20	A40	A50	A70	C10 - C30	C20	E01		
All engines	->eng. 5100000, ->eng. 6300000, ->eng. 6450000, ->eng. 6900000									1.970.211	C10			

A10	CONDENSER	A20	CONTACT SET	A40	DISTRIBUTOR CAP	A50	ROTOR	A70	PICK-UP
C10	COIL	C20	IGNITION MODULE	C30	ELECTRONIC IGNITION KIT	E01	IGNITION CABLE SET		

The present application list is a brief version. For the detailed information about the possibility of installation on a specific vehicle, please refer to our web-catalogue <http://catalogo.facet.eu/>

					FUNCTIONS ON THE VEHICLE									
Vehicle	alim.	kW	Date	Engine										
ENGINE														
827 SI/Sterling Catalytic-Conv	Petrol	124	02/88-02/99	C27 A1										
Engine	Information				A10	A20	A40	A50	A70	C10 - C30	C20	E01		
All engines	+manual transmission									1.970.211	C10			
ENGINE														
827 Vitesse Catalytic-Conv	Petrol	124	10/88-12/91	C27 A1										
Engine	Information				A10	A20	A40	A50	A70	C10 - C30	C20	E01		
All engines	+manual transmission									1.970.211	C10			
ENGINE														
827 Vitesse/SLI	Petrol	130	10/88-12/91	82RZ-FE										
Engine	Information				A10	A20	A40	A50	A70	C10 - C30	C20	E01		
All engines	->eng. 5100000, ->eng. 6300000, ->eng. 6450000, ->eng. 6900000									1.970.211	C10			
A60 CAMBRIDGE														
1.7	Petrol	46	01/62-10/69	--										
Engine	Information				A10	A20	A40	A50	A70	C10 - C30	C20	E01		
All engines						1.228.083MHV	1.328.075	1.428.006						
COUPE														
1.6 16 V	Petrol	82	03/96-11/99	16 K4F										
Engine	Information				A10	A20	A40	A50	A70	C10 - C30	C20	E01		
All engines	version Lucas							1.428.029R						
All engines												1.501.888		
MAESTRO														
1.3	Petrol	49	09/90-01/95	12 HE										
Engine	Information				A10	A20	A40	A50	A70	C10 - C30	C20	E01		
All engines	version Lucas						1.328.094	1.428.025						
ENGINE														
1.3	Petrol	51	09/90-01/95	12 HE										
Engine	Information				A10	A20	A40	A50	A70	C10 - C30	C20	E01		
All engines	version Lucas						1.328.094	1.428.025						
ENGINE														
1.6	Petrol	63	09/90-01/95	16 H										
Engine	Information				A10	A20	A40	A50	A70	C10 - C30	C20	E01		
All engines	version Lucas						1.328.093	1.428.024R						
MINI														
1.3i Cooper	Petrol	0	01/85->	--										
Engine	Information				A10	A20	A40	A50	A70	C10 - C30	C20	E01		
All engines	version Lucas						1.328.094	1.428.025						
ENGINE														
1.3i Turbo	Petrol	0	01/85->	--										
Engine	Information				A10	A20	A40	A50	A70	C10 - C30	C20	E01		
All engines	version Lucas						1.328.094	1.428.025						
ENGINE														
1300	Petrol	37	10/92-11/00	12 A2B										
Engine	Information				A10	A20	A40	A50	A70	C10 - C30	C20	E01		
All engines	version Lucas						1.328.094	1.428.025						
All engines	ch. BD134455 ->									1.970.189	C10			
ENGINE														
1300	Petrol	39	01/92-04/95	12 A2D										
Engine	Information				A10	A20	A40	A50	A70	C10 - C30	C20	E01		
All engines	version Lucas						1.328.094	1.428.025						
All engines	ch. BD134455 ->									1.970.189	C10			
ENGINE														
1300	Petrol	45	01/91-12/91	12 A2A										
Engine	Information				A10	A20	A40	A50	A70	C10 - C30	C20	E01		
All engines	version Lucas						1.328.094	1.428.025						
All engines	ch. BD134455 ->									1.970.189	C10			
ENGINE														
A10	CONDENSER		A20	CONTACT SET		A40	DISTRIBUTOR CAP		A50	ROTOR		A70	PICK-UP	
C10	COIL		C20	IGNITION MODULE		C30	ELECTRONIC IGNITION KIT		E01	IGNITION CABLE SET				

Vehicle	alim.	kW	Date	Engine	FUNCTIONS ON THE VEHICLE									
					A10	A20	A40	A50	A70	C10 - C30	C20	E01		
1300														
	Petrol	46	01/92-11/00	ENGINE 12 A2E, 12 A2L										
Engine	Information				A10	A20	A40	A50	A70	C10 - C30	C20	E01		
All engines	version Lucas						1.328.094	1.428.025						
All engines	ch. BD134455 ->									1.970.189	C10			
MONTEGO														
1.3														
	Petrol	50	10/84-10/88	ENGINE 12 HL										
Engine	Information				A10	A20	A40	A50	A70	C10 - C30	C20	E01		
All engines	version Lucas						1.328.094	1.428.025						
2.0 GTi														
	Petrol	86	02/85-10/91	ENGINE 20 H										
Engine	Information				A10	A20	A40	A50	A70	C10 - C30	C20	E01		
All engines	version Lucas						1.328.093	1.428.024R						
STREETWISE														
1.4														
	Petrol	62	08/03-05/05	ENGINE 14 K4M										
Engine	Information				A10	A20	A40	A50	A70	C10 - C30	C20	E01		
All engines	->ch. 471564, x 1, DISTRIBUTOR									1.970.374	C10			
1.4														
	Petrol	76	08/03-05/05	ENGINE 14 K4F										
Engine	Information				A10	A20	A40	A50	A70	C10 - C30	C20	E01		
All engines	->ch. 471564, x 1, DISTRIBUTOR									1.970.374	C10			
1.6														
	Petrol	80	01/04-05/05	ENGINE 16 K4F										
Engine	Information				A10	A20	A40	A50	A70	C10 - C30	C20	E01		
All engines	->ch. 471564, x 1, DISTRIBUTOR									1.970.374	C10			

A10	CONDENSER	A20	CONTACT SET	A40	DISTRIBUTOR CAP	A50	ROTOR	A70	PICK-UP
C10	COIL	C20	IGNITION MODULE	C30	ELECTRONIC IGNITION KIT	E01	IGNITION CABLE SET		

The present application list is a brief version. For the detailed information about the possibility of installation on a specific vehicle, please refer to our web-catalogue <http://catalogo.facet.eu/>









				FUNCTIONS ON THE VEHICLE								
Vehicle	alim.	kW	Date	Engine								
90												
2.0	Petrol	74	08/84-08/87	B 20 I								
Engine	Information			A10	A20	A40	A50	A70	C10 - C30	C20	E01	
All engines	version Bosch					1.306.079	1.406.026R					
All engines	MODEL FROM: 1986									1.965.004		
All engines												1.501.140
900 I												
2.0-16	Petrol	92	01/86-12/88	B202XI								
Engine	Information			A10	A20	A40	A50	A70	C10 - C30	C20	E01	
All engines	version Bosch					1.306.079	1.406.123R					
All engines	FOR MODEL: 1988									1.965.004		
All engines	FOR MODEL: 1988											1.501.138
2.0-16	Petrol	93	01/89-06/94	5B 6304 GS								
Engine	Information			A10	A20	A40	A50	A70	C10 - C30	C20	E01	
All engines	version Bosch					1.306.079	1.406.123R					
All engines	FOR MODEL: 1989									1.965.007		1.501.138
All engines	MODEL FROM: 1990									1.965.034		
2.0 c	Petrol	74	09/79-12/88	B201XC								
Engine	Information			A10	A20	A40	A50	A70	C10 - C30	C20	E01	
All engines	version Bosch					1.306.079	1.406.026R					
All engines	FOR MODEL: 1988, version Bosch							1.906.193				
All engines										1.965.004		1.501.140
2.0 i	Petrol	81	09/85-08/90	0TLE4G15								
Engine	Information			A10	A20	A40	A50	A70	C10 - C30	C20	E01	
All engines	version Bosch					1.306.079	1.406.026R					
All engines	MODEL FROM: 1988, version Bosch							1.906.193				
All engines	MODEL FROM: 1986, MODEL TO: 1988									1.965.004		
All engines	MODEL FROM: 1989									1.965.007		
All engines												1.501.140
2.0 i	Petrol	85	11/80-08/90	B201XI								
Engine	Information			A10	A20	A40	A50	A70	C10 - C30	C20	E01	
All engines	version Bosch					1.306.079	1.406.026R					
All engines	MODEL FROM: 1988, version Bosch							1.906.193				
All engines	MODEL FROM: 1986, MODEL TO: 1988									1.965.004		
All engines	MODEL FROM: 1989									1.965.007		
All engines												1.501.140
2.0 S Turbo-16	Petrol	104	07/91-06/94	B202S								
Engine	Information			A10	A20	A40	A50	A70	C10 - C30	C20	E01	
All engines	version Bosch					1.306.079						
All engines	distr. num. 88 57 617, version Bosch							1.906.244				
All engines										1.965.007		
2.0 S Turbo-16	Petrol	107	01/92-12/93	B202S								
Engine	Information			A10	A20	A40	A50	A70	C10 - C30	C20	E01	
All engines	version Bosch					1.306.079						
All engines	distr. num. 88 57 617, version Bosch							1.906.244				
All engines										1.965.007		
2.0 Turbo	Petrol	103	10/86-12/91	B201XL								
Engine	Information			A10	A20	A40	A50	A70	C10 - C30	C20	E01	
All engines	version Bosch					1.306.079	1.406.026R					
All engines							1.406.021R					1.501.140
All engines	MODEL FROM: 1988, version Bosch							1.906.193				
All engines	MODEL TO: 1988									1.965.004		
All engines	MODEL FROM: 1989									1.965.007		

A10 CONDENSER	A20 CONTACT SET	A40 DISTRIBUTOR CAP	A50 ROTOR	A70 PICK-UP
C10 COIL	C20 IGNITION MODULE	C30 ELECTRONIC IGNITION KIT	E01 IGNITION CABLE SET	

Vehicle	alim.	kW	Date	Engine	FUNCTIONS ON THE VEHICLE							
					A10	A20	A40	A50	A70	C10 - C30	C20	E01
ENGINE												
2.0 Turbo	Petrol	110	01/86-12/88	B201XL								
Engine	Information			A10	A20	A40	A50	A70	C10 - C30	C20	E01	
All engines	version Bosch					1.306.079	1.406.026R					
All engines							1.406.021R				1.501.140	
All engines	MODEL FROM: 1988, version Bosch							1.906.193				
All engines	MODEL TO: 1988									1.965.004		
All engines	MODEL FROM: 1989									1.965.007		
ENGINE												
2.0 Turbo-16	Petrol	118	11/85-06/94	B202XL								
Engine	Information			A10	A20	A40	A50	A70	C10 - C30	C20	E01	
All engines	version Bosch					1.306.079						
All engines	MODEL TO: 1989, version Bosch						1.406.123R					
All engines	distr. num. 88 57 617, version Bosch							1.906.244				
All engines	MODEL TO: 1988									1.965.004		
All engines	MODEL FROM: 1989									1.965.007		
All engines	FOR MODEL: 1989										1.501.138	
ENGINE												
2.0 Turbo-16	Petrol	132	01/93-06/94	B202L								
Engine	Information			A10	A20	A40	A50	A70	C10 - C30	C20	E01	
All engines	version Bosch					1.306.079						
All engines	distr. num. 88 57 617, version Bosch							1.906.244				
All engines	MODEL TO: 1988									1.965.004		
All engines	MODEL FROM: 1989									1.965.007		
All engines	FOR MODEL: 1989										1.501.138	
ENGINE												
2.0 Turbo-16 S	Petrol	129	01/84-06/94	B202XL								
Engine	Information			A10	A20	A40	A50	A70	C10 - C30	C20	E01	
All engines	version Bosch					1.306.079						
All engines	MODEL TO: 1989, version Bosch						1.406.123R					
All engines	distr. num. 88 57 617, version Bosch							1.906.244				
All engines	MODEL TO: 1988									1.965.004		
All engines	MODEL FROM: 1989									1.965.007		
All engines	FOR MODEL: 1989										1.501.138	
ENGINE												
2.0 Turbo-16 S Cat	Petrol	125	01/89-12/93	B202XL								
Engine	Information			A10	A20	A40	A50	A70	C10 - C30	C20	E01	
All engines	version Bosch					1.306.079						
All engines	FOR MODEL: 1989, version Bosch						1.406.123R					
All engines	distr. num. 88 57 617, version Bosch							1.906.244				
All engines	MODEL TO: 1988									1.965.004		
All engines	MODEL FROM: 1989									1.965.007		
All engines	FOR MODEL: 1989										1.501.138	
ENGINE												
2.0 Turbo-16 S Cat	Petrol	129	01/89-12/93	B202XL								
Engine	Information			A10	A20	A40	A50	A70	C10 - C30	C20	E01	
All engines	version Bosch					1.306.079						
All engines	FOR MODEL: 1989, version Bosch						1.406.123R					
All engines	distr. num. 88 57 617, version Bosch							1.906.244				
All engines	MODEL TO: 1988									1.965.004		
All engines	MODEL FROM: 1989									1.965.007		
ENGINE												
2.1 -16	Petrol	100	08/90-06/94	B212I								
Engine	Information			A10	A20	A40	A50	A70	C10 - C30	C20	E01	
All engines	version Bosch					1.306.079	1.406.123R					
900 II												
ENGINE												
2.0 i	Petrol	96	12/93-02/98	B204I								
Engine	Information			A10	A20	A40	A50	A70	C10 - C30	C20	E01	
All engines	version Bosch					1.306.124	1.406.121R					
All engines									1.970.192	C10		

A10 CONDENSER	A20 CONTACT SET	A40 DISTRIBUTOR CAP	A50 ROTOR	A70 PICK-UP
C10 COIL	C20 IGNITION MODULE	C30 ELECTRONIC IGNITION KIT	E01 IGNITION CABLE SET	

The present application list is a brief version. For the detailed information about the possibility of installation on a specific vehicle, please refer to our web-catalogue <http://catalogo.facet.eu/>

				FUNCTIONS ON THE VEHICLE								
Vehicle	alim.	kW	Date	Engine								
				ENGINE								
2.0 i	Petrol	98	07/93-07/94	B206I								
				ENGINE								
Engine		Information		A10	A20	A40	A50	A70	C10 - C30	C20	E01	
All engines		version Bosch				1.306.124	1.406.121R					
All engines									1.970.192	C10		
				ENGINE								
2.3 -16	Petrol	110	07/93-02/98	B234I								
				ENGINE								
Engine		Information		A10	A20	A40	A50	A70	C10 - C30	C20	E01	
All engines		version Bosch				1.306.124	1.406.121R					
All engines									1.970.192	C10		
				ENGINE								
9000				ENGINE								
2.0 -16	Petrol	92	12/85-12/88	B202XI								
				ENGINE								
Engine		Information		A10	A20	A40	A50	A70	C10 - C30	C20	E01	
All engines		version Bosch				1.306.079	1.406.123R					
All engines		EZK								1.965.034	1.501.138	
				ENGINE								
2.0 -16	Petrol	94	12/85-01/93	5B 6304 GS, B202XI								
				ENGINE								
Engine		Information		A10	A20	A40	A50	A70	C10 - C30	C20	E01	
All engines		EZK, version Bosch				1.306.079	1.406.123R					
All engines		EZK								1.965.034	1.501.138	
				ENGINE								
2.0 -16 CS	Petrol	94	01/89-12/98	5B 6304 GS								
				ENGINE								
Engine		Information		A10	A20	A40	A50	A70	C10 - C30	C20	E01	
All engines		EZK, version Bosch				1.306.079	1.406.123R					
All engines		EZK								1.965.034	1.501.138	
				ENGINE								
2.0 -16 Turbo	Petrol	118	09/84-08/93	B202XL								
				ENGINE								
Engine		Information		A10	A20	A40	A50	A70	C10 - C30	C20	E01	
All engines		version Bosch				1.306.079						
All engines		distr. num. 75 00 507, version Bosch					1.406.055R					
All engines		distr. num. 75 61 806, 75 61 814, version Bosch					1.406.123R					
All engines										1.965.004	1.501.138	
				ENGINE								
2.0 -16 Turbo	Petrol	120	05/88-08/93	B202XL								
				ENGINE								
Engine		Information		A10	A20	A40	A50	A70	C10 - C30	C20	E01	
All engines		version Bosch				1.306.079						
All engines		distr. num. 75 00 507, version Bosch					1.406.055R					
All engines		distr. num. 75 61 806, 75 61 814, version Bosch					1.406.123R					
All engines										1.965.004	1.501.138	
				ENGINE								
2.0 -16 Turbo	Petrol	129	09/84-12/91	B202XL								
				ENGINE								
Engine		Information		A10	A20	A40	A50	A70	C10 - C30	C20	E01	
All engines		version Bosch				1.306.079						
All engines		distr. num. 75 00 507, version Bosch					1.406.055R					
All engines		distr. num. 75 61 806, 75 61 814, version Bosch					1.406.123R					
All engines										1.965.004	1.501.138	
				ENGINE								
2.0 -16 Turbo CD	Petrol	120	09/88-08/93	B202XL								
				ENGINE								
Engine		Information		A10	A20	A40	A50	A70	C10 - C30	C20	E01	
All engines		version Bosch				1.306.079						
All engines		distr. num. 75 00 507, version Bosch					1.406.055R					
All engines		distr. num. 75 61 806, 75 61 814, version Bosch					1.406.123R					
All engines										1.965.004	1.501.138	
				ENGINE								
2.3 -16 CD	Petrol	107	08/89-12/98	B234I								
				ENGINE								
Engine		Information		A10	A20	A40	A50	A70	C10 - C30	C20	E01	
All engines		EZK, version Bosch				1.306.079	1.406.123R					
All engines		EZK								1.965.034	1.501.138	

A10 CONDENSER	A20 CONTACT SET	A40 DISTRIBUTOR CAP	A50 ROTOR	A70 PICK-UP
C10 COIL	C20 IGNITION MODULE	C30 ELECTRONIC IGNITION KIT	E01 IGNITION CABLE SET	

Vehicle	alim.	kW	Date	Engine	FUNCTIONS ON THE VEHICLE									
					A10	A20	A40	A50	A70	C10 - C30	C20	E01		
ENGINE														
2.3-16 CS	Petrol	107	09/89-12/98	B234I										
ENGINE														
All engines							1.306.079	1.406.123R						
All engines											1.965.034	1.501.138		
9-3														
ENGINE														
1.8 i	Petrol	90	01/04-02/15	Z 18 XE										
ENGINE														
All engines										1.970.508	C10			
ENGINE														
2.0 i	Petrol	96	02/98-08/03	B204I										
ENGINE														
All engines							1.306.124	1.406.121R						
All engines										1.970.192	C10			
ENGINE														
2.0 SE Turbo	Petrol	147	02/98-08/03	B204R										
ENGINE														
All engines										1.970.192	C10			
ENGINE														
2.0 Turbo	Petrol	110	03/99-08/03	B204E, B205E										
ENGINE														
All engines										1.970.192	C10			
ENGINE														
2.0 Turbo	Petrol	113	10/98-08/03	B204E										
ENGINE														
All engines										1.970.192	C10			
ENGINE														
2.0 Turbo	Petrol	136	02/98-08/03	B204L, B205L										
ENGINE														
All engines										1.970.192	C10			
ENGINE														
2.0 Turbo	Petrol	151	10/99-08/03	B205R										
ENGINE														
All engines										1.970.192	C10			
ENGINE														
2.3	Petrol	169	09/99-01/02	B235R										
ENGINE														
All engines										1.970.192	C10			
ENGINE														
2.3 i	Petrol	110	02/98-08/03	B234I										
ENGINE														
All engines							1.306.124	1.406.121R						
All engines										1.970.192	C10			
9-5														
ENGINE														
1.6 Turbo	Petrol	132	05/10-01/12	A 16 LET										
ENGINE														
All engines										1.970.450	C10			

A10	CONDENSER	A20	CONTACT SET	A40	DISTRIBUTOR CAP	A50	ROTOR	A70	PICK-UP
C10	COIL	C20	IGNITION MODULE	C30	ELECTRONIC IGNITION KIT	E01	IGNITION CABLE SET		

The present application list is a brief version. For the detailed information about the possibility of installation on a specific vehicle, please refer to our web-catalogue <http://catalogo.facet.eu/>

Vehicle	alim.	kW	Date	Engine	FUNCTIONS ON THE VEHICLE							
					A10	A20	A40	A50	A70	C10 - C30	C20	E01

ALHAMBRA I / II

				ENGINE
1.8 T 20V	Petrol	110	10/97-03/10	AJH, AWC

Engine	Information	A10	A20	A40	A50	A70	C10 - C30	C20	E01
Eng. AJH	x 4, COIL ON PLUG						1.970.354S	C10	
Eng. AWC	x 4, COIL ON PLUG, incl. spark plug connector						1.970.445	C10	
Eng. AJH								1.965.076	

				ENGINE
2.0	Petrol	85	03/96-03/10	ADY, ATM

Engine	Information	A10	A20	A40	A50	A70	C10 - C30	C20	E01
Eng. ADY							1.990.414	C30	
Eng. ATM							1.990.420	C30	

				ENGINE
2.0 i	Petrol	85	04/96-03/10	ADY, ATM

Engine	Information	A10	A20	A40	A50	A70	C10 - C30	C20	E01
Eng. ADY	version Bosch			1.306.266	1.406.121R	1.906.223			
Eng. ADY							1.990.414	C30	1.501.667
Eng. ATM							1.990.420	C30	1.501.585

				ENGINE
2.8 V6	Petrol	150	06/00-03/10	AUE, AYL

Engine	Information	A10	A20	A40	A50	A70	C10 - C30	C20	E01
All engines	x 6, COIL ON PLUG						1.970.435	C10	

				ENGINE
2.8 V6 4motion	Petrol	150	06/00-03/10	AUE, AYL

Engine	Information	A10	A20	A40	A50	A70	C10 - C30	C20	E01
All engines	x 6, COIL ON PLUG						1.970.435	C10	

ALHAMBRA III

				ENGINE
1.4 TSI	Petrol	110	06/10->	CAVA, CTHA, CZDA, DJKA

Engine	Information	A10	A20	A40	A50	A70	C10 - C30	C20	E01
Eng. CAVA, CTHA	x 4, COIL ON PLUG, incl. spark plug connector						1.970.474	C10	
Eng. CZDA, DJKA	x 4, BERU, ELDOR, COIL ON PLUG, incl. spark plug connector, Number of pins:4, incl. spark plug connector						1.970.599	C10	

				ENGINE
1.8 TSI	Petrol	118	11/12->	CDA

Engine	Information	A10	A20	A40	A50	A70	C10 - C30	C20	E01
All engines	x 4, ELDOR, Housing Colour:Black, COIL ON PLUG, incl. spark plug connector						1.970.426	C10	

				ENGINE
2.0 TFSI	Petrol	147	11/10-05/12	CCZA

Engine	Information	A10	A20	A40	A50	A70	C10 - C30	C20	E01
All engines	x 4, ELDOR, Housing Colour:Black, COIL ON PLUG, incl. spark plug connector						1.970.426	C10	

				ENGINE
TSI	Petrol	110	05/15->	CZDA

Engine	Information	A10	A20	A40	A50	A70	C10 - C30	C20	E01
All engines	x 4, BERU, ELDOR, COIL ON PLUG, incl. spark plug connector, Number of pins:4, incl. spark plug connector						1.970.599	C10	

ALTEA

				ENGINE
1.2 TSI	Petrol	77	04/10->	CBZB

Engine	Information	A10	A20	A40	A50	A70	C10 - C30	C20	E01
All engines							1.990.420	C30	1.499.248

				ENGINE
1.4 16V	Petrol	63	05/06->	BXW, CGGB

Engine	Information	A10	A20	A40	A50	A70	C10 - C30	C20	E01
All engines	x 4, COIL ON PLUG, incl. spark plug connector						1.970.474	C10	

				ENGINE
1.4 TFSI	Petrol	92	05/10-04/11	CAXC





Engine	Information	A10	A20	A40	A50	A70	C10 - C30	C20	E01
All engines	x 4, COIL ON PLUG, incl. spark plug connector						1.970.474	C10	

A10 CONDENSER	A20 CONTACT SET	A40 DISTRIBUTOR CAP	A50 ROTOR	A70 PICK-UP
C10 COIL	C20 IGNITION MODULE	C30 ELECTRONIC IGNITION KIT	E01 IGNITION CABLE SET	

Vehicle	alim.	kW	Date	Engine	FUNCTIONS ON THE VEHICLE									
					A10	A20	A40	A50	A70	C10 - C30	C20	E01		
ENGINE														
1.4 TSI	Petrol	92	11/07->	CAXC										
ENGINE														
ENGINE														
All engines											1.970.474	C10		
ENGINE														
1.6	Petrol	75	03/04->	BGU, BSE, BSF, CCSA, CMXA										
ENGINE														
ENGINE														
Eng. BGU, BSE, BSF, CCSA											1.990.420	C30		
All engines														1.501.585
ENGINE														
1.6 LPG	Petrol/ Liquified Petro- leum Gas (LPG)	75	09/09->	CHGA										
ENGINE														
ENGINE														
All engines											1.990.420	C30		1.501.585
ENGINE														
1.6 Multifuel	Petrol/ Metha- nol	75	11/10-05/11	CMXA										
ENGINE														
ENGINE														
All engines											1.990.420	C30		
ENGINE														
1.8 TFSI	Petrol	118	01/07->	BYT, BZB, CDAA										
ENGINE														
ENGINE														
All engines											1.970.426	C10		
ENGINE														
2.0 FSI	Petrol	110	05/04-03/09	BLR, BLY, BVY, BVZ										
ENGINE														
ENGINE														
All engines											1.970.426	C10		
ENGINE														
2.0 TFSI	Petrol	147	04/06-05/09	BWA										
ENGINE														
ENGINE														
All engines											1.970.426	C10		
ALTEA XL														
ENGINE														
1.2 TSI	Petrol	77	04/10->	CBZB										
ENGINE														
ENGINE														
All engines											1.990.420	C30		1.499.248
ENGINE														
1.4 16V	Petrol	63	10/06->	BXW, CGGB										
ENGINE														
ENGINE														
All engines											1.970.474	C10		
ENGINE														
1.4 TSI	Petrol	92	11/07->	CAXC										
ENGINE														
ENGINE														
All engines											1.970.474	C10		
ENGINE														
1.6	Petrol	75	10/06->	BGU, BSE, BSF, CCSA, CMXA										
ENGINE														
ENGINE														
Eng. BGU, BSE, BSF, CCSA											1.990.420	C30		
Eng. BSE, BSF, CCSA, CMXA														1.501.585
ENGINE														
1.6 LPG	Petrol/ Liquified Petro- leum Gas (LPG)	75	09/09->	CHGA										
ENGINE														
ENGINE														
All engines											1.990.420	C30		1.501.585

A10 CONDENSER	A20 CONTACT SET	A40 DISTRIBUTOR CAP	A50 ROTOR	A70 PICK-UP
C10 COIL	C20 IGNITION MODULE	C30 ELECTRONIC IGNITION KIT	E01 IGNITION CABLE SET	

The present application list is a brief version. For the detailed information about the possibility of installation on a specific vehicle, please refer to our web-catalogue <http://catalogo.facet.eu/>

					FUNCTIONS ON THE VEHICLE							
Vehicle	alim.	kW	Date	Engine	 A10	 A20	 A40	 A50	 A70	 C10 - C30	 C20	 E01
ENGINE												
1.6 Multifuel	Petrol/ Ethanol	75	10/06-11/10	BSE, BSF, CCSA, CMXA								
Engine	Information				A10	A20	A40	A50	A70	C10 - C30	C20	E01
All engines										1.990.420	C30	
Eng. CCSA												1.501.585
ENGINE												
1.8 TFSI	Petrol	118	01/07->	BYT, BZB, CDA								
Engine	Information				A10	A20	A40	A50	A70	C10 - C30	C20	E01
All engines	x 4, ELDOR, Housing Colour:Black, COIL ON PLUG, incl. spark plug connector									1.970.426	C10	
ENGINE												
2.0 FSI	Petrol	110	10/06-03/09	BVY, BVZ								
Engine	Information				A10	A20	A40	A50	A70	C10 - C30	C20	E01
All engines	x 4, ELDOR, Housing Colour:Black, COIL ON PLUG, incl. spark plug connector									1.970.426	C10	
ENGINE												
2.0 TFSI	Petrol	147	10/06-05/09	BWA								
Engine	Information				A10	A20	A40	A50	A70	C10 - C30	C20	E01
All engines	x 4, ELDOR, Housing Colour:Black, COIL ON PLUG, incl. spark plug connector									1.970.426	C10	
ENGINE												
2.0 TFSI	Petrol	155	05/09->	CCZB								
Engine	Information				A10	A20	A40	A50	A70	C10 - C30	C20	E01
All engines	x 4, ELDOR, Housing Colour:Black, COIL ON PLUG, incl. spark plug connector									1.970.426	C10	
ENGINE												
2.0 TFSI 4x4	Petrol	147	06/07-05/09	BWA								
Engine	Information				A10	A20	A40	A50	A70	C10 - C30	C20	E01
All engines	x 4, ELDOR, Housing Colour:Black, COIL ON PLUG, incl. spark plug connector									1.970.426	C10	
ENGINE												
2.0 TFSI 4x4	Petrol	155	05/09->	CCZB								
Engine	Information				A10	A20	A40	A50	A70	C10 - C30	C20	E01
All engines	x 4, ELDOR, Housing Colour:Black, COIL ON PLUG, incl. spark plug connector									1.970.426	C10	
ARONA												
ENGINE												
1.0 TGI	Petrol/ Compressed Natural Gas (CNG)	66	11/18->	DBYA								
Engine	Information				A10	A20	A40	A50	A70	C10 - C30	C20	E01
All engines	x 3, BERU, ELDOR, COIL ON PLUG, incl. spark plug connector, Number of pins:4, incl. spark plug connector									1.970.599	C10	
ENGINE												
1.0 TSI	Petrol	70	07/17->	CHZL, DKLA								
Engine	Information				A10	A20	A40	A50	A70	C10 - C30	C20	E01
All engines	x 3, BERU, ELDOR, COIL ON PLUG, incl. spark plug connector, Number of pins:4, incl. spark plug connector									1.970.599	C10	
ENGINE												
1.0 TSI	Petrol	81	06/20->	DLAA								
Engine	Information				A10	A20	A40	A50	A70	C10 - C30	C20	E01
All engines	x 3, ELDOR, HITACHI, COIL ON PLUG, incl. spark plug connector, Number of pins:4, incl. spark plug connector									1.970.599	C10	
ENGINE												
1.0 TSI	Petrol	85	07/17->	CHZJ, DKJA, DKRF								
Engine	Information				A10	A20	A40	A50	A70	C10 - C30	C20	E01
All engines	x 3, BERU, ELDOR, COIL ON PLUG, incl. spark plug connector, Number of pins:4, incl. spark plug connector									1.970.599	C10	
ENGINE												
1.6 SRE	Petrol	81	07/17->	CWVA								
Engine	Information				A10	A20	A40	A50	A70	C10 - C30	C20	E01
All engines	x 4, BERU, ELDOR, COIL ON PLUG, incl. spark plug connector, Number of pins:4, incl. spark plug connector									1.970.599	C10	

A10 CONDENSER	A20 CONTACT SET	A40 DISTRIBUTOR CAP	A50 ROTOR	A70 PICK-UP
C10 COIL	C20 IGNITION MODULE	C30 ELECTRONIC IGNITION KIT	E01 IGNITION CABLE SET	

Vehicle	alim.	kW	Date	Engine	FUNCTIONS ON THE VEHICLE							
					A10	A20	A40	A50	A70	C10 - C30	C20	E01

AROSA				
				ENGINE
1.0	Petrol	37	05/97-06/04	AER, ALD, ALL, ANV, AUC

Engine	Information	A10	A20	A40	A50	A70	C10 - C30	C20	E01
Eng. AER, ALL	version Bosch			1.306.094	1.406.121R	1.906.223			
Eng. AER, ALL	version Marelli			1.330.116	1.430.057R				
Eng. AER, ALL							1.990.414	C30	
Eng. ALD, ANV, AUC							1.990.420	C30	
Eng. ALL									1.501.569
Eng. ALD, ANV									1.501.595
Eng. AUC									1.501.601
Eng. AER									1.501.641

AROSA				
				ENGINE
1.4	Petrol	44	05/97-06/04	4A 20 NFT, AEX, AKK, AKV, ANW, APQ, AUD

Engine	Information	A10	A20	A40	A50	A70	C10 - C30	C20	E01
Eng. AEX, AKV, APQ	version Bosch			1.306.094	1.406.121R	1.906.223			
Eng. AEX, AKV, APQ	version Marelli			1.330.116	1.430.057R				
Eng. AEX, AKV, APQ							1.990.414	C30	1.501.641
Eng. AKK, ANW, AUD							1.990.420	C30	
Eng. 4A 20 NFT									1.501.595
Eng. AUD									1.501.601

AROSA				
				ENGINE
1.4 16V	Petrol	74	01/00-06/04	0P11C-VF, AFK, AQQ, AUB

Engine	Information	A10	A20	A40	A50	A70	C10 - C30	C20	E01
Eng. AFK, AQQ, AUB							1.990.420	C30	
Eng. 0P11C-VF, AQQ, AUB									1.501.575

ATECA				
				ENGINE
1.0 TSI	Petrol	85	05/16->	CHZJ, DKRF

Engine	Information	A10	A20	A40	A50	A70	C10 - C30	C20	E01
All engines	x 3, BERU, ELDOR, COIL ON PLUG, incl. spark plug connector, Number of pins:4, incl. spark plug connector						1.970.599	C10	

ATECA				
				ENGINE
1.4 TSI	Petrol	110	06/16->	CZEA

Engine	Information	A10	A20	A40	A50	A70	C10 - C30	C20	E01
All engines	x 4, BERU, ELDOR, COIL ON PLUG, incl. spark plug connector, Number of pins:4, incl. spark plug connector						1.970.599	C10	

ATECA				
				ENGINE
1.4 TSI 4Drive	Petrol	110	06/16->	CZEA

Engine	Information	A10	A20	A40	A50	A70	C10 - C30	C20	E01
All engines	x 4, BERU, ELDOR, COIL ON PLUG, incl. spark plug connector, Number of pins:4, incl. spark plug connector						1.970.599	C10	

CORDOBA I				
				ENGINE
1.0 16V	Petrol	51	05/00-10/02	AST, AVZ

Engine	Information	A10	A20	A40	A50	A70	C10 - C30	C20	E01
All engines	without cover, version Bosch			1.306.094					
All engines	with cover, version Bosch			1.306.266					
All engines	version Bosch				1.406.121R	1.906.233			
All engines							1.990.414	C30	

CORDOBA I				
				ENGINE
1.0 CL	Petrol	33	02/93-06/96	AAU







Engine	Information	A10	A20	A40	A50	A70	C10 - C30	C20	E01
All engines	version Bosch			1.306.266	1.406.121R				
All engines							1.990.414	C30	

CORDOBA I				
				ENGINE
1.0 i	Petrol	37	09/96-10/02	AER

Engine	Information	A10	A20	A40	A50	A70	C10 - C30	C20	E01
All engines	version Bosch			1.306.094	1.406.121R	1.906.223			
All engines	version Marelli			1.330.116	1.430.057R	1.930.182			
All engines							1.990.414	C30	1.501.640

A10	CONDENSER	A20	CONTACT SET	A40	DISTRIBUTOR CAP	A50	ROTOR	A70	PICK-UP
C10	COIL	C20	IGNITION MODULE	C30	ELECTRONIC IGNITION KIT	E01	IGNITION CABLE SET		

The present application list is a brief version. For the detailed information about the possibility of installation on a specific vehicle, please refer to our web-catalogue <http://catalogo.facet.eu/>

					FUNCTIONS ON THE VEHICLE							
Vehicle	alim.	kW	Date	Engine	 A10	 A20	 A40	 A50	 A70	 C10 - C30	 C20	 E01
ENGINE												
1.3	Petrol	40	02/93-08/94	8C20HD0D, AAV								
Engine	Information				A10	A20	A40	A50	A70	C10 - C30	C20	E01
Eng. AAV	version Bosch						1.306.266	1.406.121R				
Eng. AAV										1.990.414	C30	
Eng. 8C20HD0D										1.990.416	C30	
ENGINE												
1.4	Petrol	40	12/97-04/99	ANX								
Engine	Information				A10	A20	A40	A50	A70	C10 - C30	C20	E01
All engines	version Bosch						1.306.094	1.406.121R	1.906.223			
All engines	version Marelli						1.330.116	1.430.057R	1.930.182			
All engines										1.990.414	C30	1.501.640
ENGINE												
1.4 16V	Petrol	55	06/99-12/02	2CJXE, AUA								
Engine	Information				A10	A20	A40	A50	A70	C10 - C30	C20	E01
All engines										1.990.420	C30	1.501.575
ENGINE												
1.4 i	Petrol	44	06/94-12/02	ABD, AEX, AKV, APQ								
Engine	Information				A10	A20	A40	A50	A70	C10 - C30	C20	E01
All engines	version Bosch						1.306.094	1.406.121R				
Eng. AKV, APQ	version Marelli						1.330.116	1.430.057R	1.930.182			
Eng. AEX, AKV, APQ	version Bosch								1.906.223			
All engines										1.990.414	C30	
Eng. ABD												1.501.364
Eng. AEX, AKV, APQ												1.501.640
ENGINE												
1.4 i 16V	Petrol	74	09/96-10/02	AFH								
Engine	Information				A10	A20	A40	A50	A70	C10 - C30	C20	E01
All engines	version Bosch						1.306.094	1.406.121R	1.906.223			
All engines	version Marelli						1.330.116	1.430.057R	1.930.182			
All engines										1.990.414	C30	
ENGINE												
1.6 i	Petrol	55	02/93-12/02	1F, ABU, AEE, ALM								
Engine	Information				A10	A20	A40	A50	A70	C10 - C30	C20	E01
Eng. ALM	version Bosch						1.306.079					
Eng. 1F, ABU, AEE	version Bosch						1.306.094					
Eng. 1F	version Ducellier						1.315.068	1.415.099R				
Eng. AEE, ALM	version Marelli						1.330.116	1.430.057R	1.930.182			
All engines	version Bosch							1.406.121R				
Eng. 1F, AEE, ALM	version Bosch								1.906.223			
All engines										1.990.414	C30	
Eng. ABU	->ch. 6K-ZR010 000, ->ch. 6K-ZR510 000											1.500.736
Eng. 1F												1.500.965
Eng. ABU	ch. 6K-ZR010 000 ->, ch. 6K-ZR510 000 ->											1.501.364
Eng. AEE, ALM												1.501.640
ENGINE												
1.6 i	Petrol	74	07/96-12/02	AFT, AKL								
Engine	Information				A10	A20	A40	A50	A70	C10 - C30	C20	E01
Eng. AFT	version Bosch						1.306.094	1.406.121R	1.906.223			
Eng. AFT										1.990.414	C30	1.501.932
Eng. AKL										1.990.420	C30	1.501.484
ENGINE												
1.8 i	Petrol	66	02/93-09/02	ABS, ACC, ADZ								
Engine	Information				A10	A20	A40	A50	A70	C10 - C30	C20	E01
All engines	version Bosch						1.306.094	1.406.121R	1.906.223			
All engines	version Ducellier						1.315.068	1.415.099R				
All engines										1.990.414	C30	
All engines	01/07/96 ->											1.500.965
Eng. ACC	->year 30/06/96											1.501.549

A10 CONDENSER	A20 CONTACT SET	A40 DISTRIBUTOR CAP	A50 ROTOR	A70 PICK-UP
C10 COIL	C20 IGNITION MODULE	C30 ELECTRONIC IGNITION KIT	E01 IGNITION CABLE SET	

Vehicle	alim.	kW	Date	Engine	FUNCTIONS ON THE VEHICLE									
					A10	A20	A40	A50	A70	C10 - C30	C20	E01		
ENGINE														
1.8 i 16V	Petrol	95	10/93-08/96	148 D										
Engine	Information				A10	A20	A40	A50	A70	C10 - C30	C20	E01		
All engines	version Bosch						1.306.094	1.406.121R	1.906.223					
All engines										1.990.414	C30			
ENGINE														
1.8 T 20V Cupra	Petrol	115	07/00-10/02	AQX										
Engine	Information				A10	A20	A40	A50	A70	C10 - C30	C20	E01		
All engines	Qty: 4									1.970.445	C10			
ENGINE														
2.0 i	Petrol	85	02/93-06/99	2E, AGG										
Engine	Information				A10	A20	A40	A50	A70	C10 - C30	C20	E01		
Eng. 2E	version Bosch						1.306.094							
Eng. AGG	version Bosch						1.306.266		1.906.223					
All engines	version Bosch							1.406.121R						
All engines	ch. 6K-ZR132 109 ->, ch. 6K-ZR672 417 ->									1.990.414	C30			
All engines													1.500.965	
ENGINE														
2.0 i 16V	Petrol	110	08/96-06/99	ABF										
Engine	Information				A10	A20	A40	A50	A70	C10 - C30	C20	E01		
All engines	version Bosch						1.306.263	1.406.121R						
All engines										1.990.414	C30			
CORDOBA II														
ENGINE														
1.2	Petrol	47	10/02-06/06	AZQ, BME										
Engine	Information				A10	A20	A40	A50	A70	C10 - C30	C20	E01		
All engines	x 3, COIL ON PLUG, incl. spark plug connector									1.970.474	C10			
ENGINE														
1.2 12V	Petrol	51	05/06-11/09	BXV										
Engine	Information				A10	A20	A40	A50	A70	C10 - C30	C20	E01		
All engines	x 3, COIL ON PLUG, incl. spark plug connector									1.970.474	C10			
ENGINE														
1.4 16V	Petrol	55	09/02-12/07	BBY, BKY										
Engine	Information				A10	A20	A40	A50	A70	C10 - C30	C20	E01		
All engines	x 4, COIL ON PLUG, incl. spark plug connector									1.970.474	C10			
ENGINE														
1.4 16V	Petrol	59	05/06->	BUD										
Engine	Information				A10	A20	A40	A50	A70	C10 - C30	C20	E01		
All engines	Qty: 4									1.970.474	C10			
ENGINE														
1.4 16V	Petrol	63	05/06-11/09	BXW										
Engine	Information				A10	A20	A40	A50	A70	C10 - C30	C20	E01		
All engines	x 4, COIL ON PLUG, incl. spark plug connector									1.970.474	C10			
ENGINE														
1.4 16V	Petrol	74	10/02-11/09	BBZ										
Engine	Information				A10	A20	A40	A50	A70	C10 - C30	C20	E01		
All engines	x 4, COIL ON PLUG, incl. spark plug connector									1.970.474	C10			
ENGINE														
1.6	Petrol	74	04/03-11/09	BAH										
Engine	Information				A10	A20	A40	A50	A70	C10 - C30	C20	E01		
All engines										1.990.420	C30		1.501.723	
ENGINE														
1.6 16V	Petrol	77	11/06-11/09	BTS										
Engine	Information				A10	A20	A40	A50	A70	C10 - C30	C20	E01		
All engines	x 4, COIL ON PLUG, incl. spark plug connector									1.970.474	C10			
ENGINE														
2.0	Petrol	85	09/02-11/09	AZL, BBX										
Engine	Information				A10	A20	A40	A50	A70	C10 - C30	C20	E01		
All engines										1.990.420	C30		1.501.585	

A10 CONDENSER	A20 CONTACT SET	A40 DISTRIBUTOR CAP	A50 ROTOR	A70 PICK-UP
C10 COIL	C20 IGNITION MODULE	C30 ELECTRONIC IGNITION KIT	E01 IGNITION CABLE SET	

The present application list is a brief version. For the detailed information about the possibility of installation on a specific vehicle, please refer to our web-catalogue <http://catalogo.facet.eu/>

Vehicle	alim.	kW	Date	Engine	FUNCTIONS ON THE VEHICLE							
					A10	A20	A40	A50	A70	C10 - C30	C20	E01

EXEO

1.6	Petrol	75	03/09-09/10	ENGINE ALZ
-----	--------	----	-------------	---------------

Engine	Information	A10	A20	A40	A50	A70	C10 - C30	C20	E01
All engines	x 4, COIL ON PLUG, incl. spark plug connector						1.970.429	C10	
All engines							1.990.420	C30	1.501.585

1.8 T	Petrol	110	12/08-05/10	ENGINE CFMA
-------	--------	-----	-------------	----------------

Engine	Information	A10	A20	A40	A50	A70	C10 - C30	C20	E01
All engines	x 4, COIL ON PLUG, incl. spark plug connector						1.970.429	C10	
All engines							1.990.420	C30	

1.8 TSI	Petrol	118	05/10-05/13	ENGINE CDHB
---------	--------	-----	-------------	----------------

Engine	Information	A10	A20	A40	A50	A70	C10 - C30	C20	E01
All engines	x 4, ELDOR, Housing Colour:Black, COIL ON PLUG, incl. spark plug connector						1.970.426	C10	

1.8 TSI	Petrol	88	09/10-05/13	ENGINE CDHA
---------	--------	----	-------------	----------------

Engine	Information	A10	A20	A40	A50	A70	C10 - C30	C20	E01
All engines	x 4, ELDOR, Housing Colour:Black, COIL ON PLUG, incl. spark plug connector						1.970.426	C10	

2.0 TFSI	Petrol	147	03/09-05/13	ENGINE BWE
----------	--------	-----	-------------	---------------

Engine	Information	A10	A20	A40	A50	A70	C10 - C30	C20	E01
All engines	x 4, ELDOR, Housing Colour:Black, COIL ON PLUG, incl. spark plug connector						1.970.426	C10	

2.0 TFSI	Petrol	155	05/10-05/13	ENGINE CDND
----------	--------	-----	-------------	----------------

Engine	Information	A10	A20	A40	A50	A70	C10 - C30	C20	E01
All engines	x 4, ELDOR, Housing Colour:Black, COIL ON PLUG, incl. spark plug connector						1.970.426	C10	

FURA

0.9	Petrol	33	01/82-06/86	ENGINE 100 GL 3000
-----	--------	----	-------------	-----------------------

Engine	Information	A10	A20	A40	A50	A70	C10 - C30	C20	E01
All engines	version Ducellier	1.115.039		1.315.058	1.415.083R				
All engines	version Marelli	1.130.117	1.230.142		1.430.042R				
All engines	version Fensa		1.217.020	1.317.016	1.417.052R				
All engines							1.970.101D	C10	

IBIZA

1.0 SRE	Petrol	55	05/15-12/16	ENGINE CHYB
---------	--------	----	-------------	----------------

Engine	Information	A10	A20	A40	A50	A70	C10 - C30	C20	E01
All engines	x 3, BERU, ELDOR, COIL ON PLUG, incl. spark plug connector, Number of pins:4, incl. spark plug connector						1.970.599	C10	

1.2	Petrol	44	07/09-05/15	ENGINE CGPB
-----	--------	----	-------------	----------------

Engine	Information	A10	A20	A40	A50	A70	C10 - C30	C20	E01
All engines	x 3, COIL ON PLUG, incl. spark plug connector						1.970.474	C10	

1.2	Petrol	51	04/08-05/15	ENGINE BZG, CGPA
-----	--------	----	-------------	---------------------

Engine	Information	A10	A20	A40	A50	A70	C10 - C30	C20	E01
All engines	x 3, COIL ON PLUG, incl. spark plug connector						1.970.474	C10	

1.4	Petrol	63	07/08-05/15	ENGINE BXW, CGGB
-----	--------	----	-------------	---------------------

Engine	Information	A10	A20	A40	A50	A70	C10 - C30	C20	E01
All engines	x 4, COIL ON PLUG, incl. spark plug connector						1.970.474	C10	

1.6	Petrol	77	07/08-05/15	ENGINE BTS
-----	--------	----	-------------	---------------

Engine	Information	A10	A20	A40	A50	A70	C10 - C30	C20	E01
All engines	x 4, COIL ON PLUG, incl. spark plug connector						1.970.474	C10	

A10 CONDENSER	A20 CONTACT SET	A40 DISTRIBUTOR CAP	A50 ROTOR	A70 PICK-UP
C10 COIL	C20 IGNITION MODULE	C30 ELECTRONIC IGNITION KIT	E01 IGNITION CABLE SET	

Vehicle	alim.	kW	Date	Engine	FUNCTIONS ON THE VEHICLE							
					A10	A20	A40	A50	A70	C10 - C30	C20	E01

ENGINE				
1.6 SRE	Petrol	81	07/15-12/16	CWVA

Engine	Information	A10	A20	A40	A50	A70	C10 - C30	C20	E01
All engines	x 4, BERU, ELDOR, COIL ON PLUG, incl. spark plug connector, Number of pins:4, incl. spark plug connector						1.970.599	C10	

IBIZA I

ENGINE				
0.9	Petrol	29	08/90-05/93	09 NCA, 146 A 000

Engine	Information	A10	A20	A40	A50	A70	C10 - C30	C20	E01
Eng. 146 A 000	version Ducellier	1.115.039		1.315.058	1.415.091				
Eng. 146 A 000	version Marelli	1.130.128	1.230.146M	1.330.098	1.430.047R				
Eng. 146 A 000	version Femsas		1.230.132	1.317.014	1.417.052R				
Eng. 09 NCA	version MARELLI			1.330.076					
All engines					1.430.037				
Eng. 146 A 000							1.970.101D	C10	

ENGINE				
0.9	Petrol	32	08/86-05/93	146 A 000

Engine	Information	A10	A20	A40	A50	A70	C10 - C30	C20	E01
All engines	version Ducellier	1.115.039		1.315.058	1.415.091				
All engines	version Marelli	1.130.128	1.230.146M	1.330.098	1.430.047R				
All engines	version Femsas		1.230.132	1.317.014	1.417.052R				
All engines							1.970.101D	C10	

ENGINE				
1.2	Petrol	46	11/84-12/93	021 A 1000

Engine	Information	A10	A20	A40	A50	A70	C10 - C30	C20	E01
All engines	version Bosch			1.306.079	1.406.056R	1.906.193			
All engines	version Marelli			1.330.101	1.430.047R				
All engines									1.500.612

ENGINE				
1.2 i	Petrol	52	01/89-05/93	021 C.1000

Engine	Information	A10	A20	A40	A50	A70	C10 - C30	C20	E01
All engines	version Bosch			1.306.079	1.406.121R				
All engines									1.500.612

ENGINE				
1.5 i	Petrol	74	10/86-05/93	021 B.2000

Engine	Information	A10	A20	A40	A50	A70	C10 - C30	C20	E01
All engines	version Bosch			1.306.079	1.406.121R				
All engines									1.500.612

IBIZA II

ENGINE				
1.0	Petrol	33	03/93-09/96	AAU

Engine	Information	A10	A20	A40	A50	A70	C10 - C30	C20	E01
All engines	version Bosch			1.306.094	1.406.121R				
All engines							1.990.414	C30	1.500.725

ENGINE				
1.0 16V	Petrol	51	10/99-02/02	AST, AVZ

Engine	Information	A10	A20	A40	A50	A70	C10 - C30	C20	E01
All engines				1.306.266			1.990.414	C30	
All engines	version Bosch				1.406.121R	1.906.233			

ENGINE				
1.0 i	Petrol	37	09/96-02/02	AER, AUC







Engine	Information	A10	A20	A40	A50	A70	C10 - C30	C20	E01
Eng. AER	version Bosch			1.306.094	1.406.121R	1.906.223			
Eng. AER	version Marelli			1.330.116	1.430.057R				
Eng. AER							1.990.414	C30	1.501.640
Eng. AUC							1.990.420	C30	1.501.601

ENGINE				
1.3 i	Petrol	40	03/93-08/99	8C20HD0D, AAV

Engine	Information	A10	A20	A40	A50	A70	C10 - C30	C20	E01
Eng. AAV	version Bosch			1.306.094	1.406.121R				
Eng. 8C20HD0D	version Bosch			1.306.266	1.406.056R	1.906.234			
Eng. AAV							1.990.414	C30	1.500.725
Eng. 8C20HD0D							1.990.416	C30	

A10 CONDENSER	A20 CONTACT SET	A40 DISTRIBUTOR CAP	A50 ROTOR	A70 PICK-UP
C10 COIL	C20 IGNITION MODULE	C30 ELECTRONIC IGNITION KIT	E01 IGNITION CABLE SET	

FUNCTIONS ON THE VEHICLE

Vehicle	alim.	kW	Date	Engine								
ENGINE												
1.4	Petrol	40	12/97-04/99	ANX								
Engine	Information				A10	A20	A40	A50	A70	C10 - C30	C20	E01
All engines	version Bosch						1.306.094	1.406.121R	1.906.223			
All engines	version Marelli						1.330.116	1.430.057R				
All engines												1.501.640
ENGINE												
1.4 16V	Petrol	55	05/00-02/02	2CJXE, AUA								
Engine	Information				A10	A20	A40	A50	A70	C10 - C30	C20	E01
All engines										1.990.420 C30		1.501.575
ENGINE												
1.4 i	Petrol	44	09/93-02/02	ABD, AEX, AKV, APQ, AUD								
Engine	Information				A10	A20	A40	A50	A70	C10 - C30	C20	E01
Eng. ABD, AEX, AKV, APQ	version Bosch						1.306.094	1.406.121R	1.906.223			
Eng. ABD, AEX, AKV, APQ	version Marelli						1.330.116					
Eng. ABD, AEX, AKV, APQ	version Marelli, version Marelli							1.430.057R				
Eng. ABD, AEX										1.990.414 C30		
Eng. AUD										1.990.420 C30		1.501.601
Eng. ABD												1.501.364
Eng. AEX, AKV, APQ												1.501.640
ENGINE												
1.4 i 16V	Petrol	74	06/97-02/02	AFH, AQQ								
Engine	Information				A10	A20	A40	A50	A70	C10 - C30	C20	E01
Eng. AFH	version Bosch						1.306.094	1.406.121R	1.906.223			
Eng. AFH	version Marelli						1.330.116	1.430.057R				
Eng. AFH										1.990.414 C30		
Eng. AQQ										1.990.420 C30		1.501.575
ENGINE												
1.6 i	Petrol	55	03/93-02/02	1F, ABU, AEE, ALM								
Engine	Information				A10	A20	A40	A50	A70	C10 - C30	C20	E01
All engines	version Bosch						1.306.094	1.406.121R				
Eng. 1F	version Ducellier						1.315.068	1.415.099R				
Eng. AEE, ALM	version Marelli, version Marelli						1.330.116	1.430.057R				
Eng. 1F, AEE, ALM	version Bosch								1.906.223			
All engines										1.990.414 C30		
Eng. 1F												1.500.965
Eng. ABU	ch. 6K-ZR010 000 ->, ch. 6K-ZR510 000 ->											1.501.364
Eng. AEE, ALM												1.501.640
ENGINE												
1.6 i	Petrol	74	04/96-02/02	AFT, AKL								
Engine	Information				A10	A20	A40	A50	A70	C10 - C30	C20	E01
Eng. AFT	version Bosch						1.306.094	1.406.121R	1.906.223			
Eng. AFT										1.990.414 C30		1.501.932
Eng. AKL										1.990.420 C30		1.501.484
ENGINE												
1.8 i	Petrol	66	03/93-08/99	ABS, ACC, ADZ								
Engine	Information				A10	A20	A40	A50	A70	C10 - C30	C20	E01
All engines	version Bosch						1.306.094	1.406.121R				
All engines	version Ducellier						1.315.068	1.415.099R				
Eng. ABS, ADZ	version Bosch								1.906.223			
Eng. ADZ										1.970.159 C10		
All engines										1.990.414 C30		1.500.965
ENGINE												
1.8 i 16V	Petrol	95	11/93-08/96	148 D								
Engine	Information				A10	A20	A40	A50	A70	C10 - C30	C20	E01
All engines	version Bosch						1.306.094	1.406.121R	1.906.223			
All engines										1.990.414 C30		
ENGINE												
1.8 T 20V Cupra	Petrol	115	07/00-02/02	AQX, AYP								
Engine	Information				A10	A20	A40	A50	A70	C10 - C30	C20	E01
Eng. AYP	Qty: 4									1.970.429 C10		
Eng. AQX	Qty: 4									1.970.445 C10		

A10 CONDENSER	A20 CONTACT SET	A40 DISTRIBUTOR CAP	A50 ROTOR	A70 PICK-UP
C10 COIL	C20 IGNITION MODULE	C30 ELECTRONIC IGNITION KIT	E01 IGNITION CABLE SET	

Vehicle	alim.	kW	Date	Engine	FUNCTIONS ON THE VEHICLE									
					A10	A20	A40	A50	A70	C10 - C30	C20	E01		
ENGINE														
2.0 i	Petrol	85	03/93-08/99	2E, AGG										
Engine	Information				A10	A20	A40	A50	A70	C10 - C30	C20	E01		
All engines	version Bosch						1.306.094	1.406.121R						
Eng. AGG	version Bosch								1.906.223					
Eng. 2E	->ch. 6K-ZR132 108, ->ch. 6K-ZR672 416									1.970.159	C10			
All engines	ch. 6K-ZR132 109 ->, ch. 6K-ZR672 417 ->									1.990.414	C30			
All engines													1.500.965	
ENGINE														
2.0 i 16V	Petrol	110	08/96-08/99	ABF										
Engine	Information				A10	A20	A40	A50	A70	C10 - C30	C20	E01		
All engines	version Bosch						1.306.263	1.406.121R						
All engines										1.990.414	C30			
IBIZA III														
ENGINE														
1.2	Petrol	44	06/07-05/08	BBM										
Engine	Information				A10	A20	A40	A50	A70	C10 - C30	C20	E01		
All engines	x 3, COIL ON PLUG, incl. spark plug connector									1.970.431	C10			
ENGINE														
1.2	Petrol	47	02/02-06/06	AZQ, BME										
Engine	Information				A10	A20	A40	A50	A70	C10 - C30	C20	E01		
All engines	x 3, COIL ON PLUG, incl. spark plug connector									1.970.474	C10			
ENGINE														
1.2 12V	Petrol	51	05/06-11/09	BXV										
Engine	Information				A10	A20	A40	A50	A70	C10 - C30	C20	E01		
All engines	x 3, COIL ON PLUG, incl. spark plug connector									1.970.474	C10			
ENGINE														
1.4 16V	Petrol	55	02/02-12/07	BBY, BKY										
Engine	Information				A10	A20	A40	A50	A70	C10 - C30	C20	E01		
All engines	x 4, COIL ON PLUG, incl. spark plug connector									1.970.474	C10			
ENGINE														
1.4 16V	Petrol	63	05/06-11/09	BXW										
Engine	Information				A10	A20	A40	A50	A70	C10 - C30	C20	E01		
All engines	x 4, COIL ON PLUG, incl. spark plug connector									1.970.474	C10			
ENGINE														
1.4 16V	Petrol	74	02/02-11/09	AUB, BBZ										
Engine	Information				A10	A20	A40	A50	A70	C10 - C30	C20	E01		
All engines	ch. 6L2012770 ->, x 4, COIL ON PLUG, incl. spark plug connector									1.970.474	C10			
Eng. AUB										1.990.420	C30		1.501.575	
ENGINE														
1.6	Petrol	74	02/03-11/09	BAH										
Engine	Information				A10	A20	A40	A50	A70	C10 - C30	C20	E01		
All engines										1.990.420	C30		1.501.723	
ENGINE														
1.6 16V	Petrol	77	11/06-11/09	BTS										
Engine	Information				A10	A20	A40	A50	A70	C10 - C30	C20	E01		
All engines	x 4, COIL ON PLUG, incl. spark plug connector									1.970.474	C10			
ENGINE														
1.8 T Cupra R	Petrol	132	01/04-02/08	BBU, BLZ										
Engine	Information				A10	A20	A40	A50	A70	C10 - C30	C20	E01		
All engines	x 4, COIL ON PLUG, incl. spark plug connector									1.970.429	C10			
ENGINE														
1.8 T FR	Petrol	110	12/03-05/08	BJX, BKV										
Engine	Information				A10	A20	A40	A50	A70	C10 - C30	C20	E01		
All engines	x 4, COIL ON PLUG, incl. spark plug connector									1.970.429	C10			
ENGINE														
2.0	Petrol	85	04/02-11/09	AZL, BBX										
Engine	Information				A10	A20	A40	A50	A70	C10 - C30	C20	E01		
All engines										1.990.420	C30		1.501.585	

A10 CONDENSER	A20 CONTACT SET	A40 DISTRIBUTOR CAP	A50 ROTOR	A70 PICK-UP
C10 COIL	C20 IGNITION MODULE	C30 ELECTRONIC IGNITION KIT	E01 IGNITION CABLE SET	

The present application list is a brief version. For the detailed information about the possibility of installation on a specific vehicle, please refer to our web-catalogue <http://catalogo.facet.eu/>

Vehicle	alim.	kW	Date	Engine	FUNCTIONS ON THE VEHICLE							
					A10	A20	A40	A50	A70	C10 - C30	C20	E01

IBIZA IV

Vehicle	alim.	kW	Date	ENGINE	A10	A20	A40	A50	A70	C10 - C30	C20	E01
1.0	Petrol	55	05/15-06/17	CHYB						1.970.599	C10	
ENGINE All engines					Information x 3, BERU, ELDOR, COIL ON PLUG, incl. spark plug connector, Number of pins:4, incl. spark plug connector							
1.0 TSI	Petrol	70	05/15-06/17	CHZB						1.970.599	C10	
ENGINE All engines					Information x 3, BERU, ELDOR, COIL ON PLUG, incl. spark plug connector, Number of pins:4, incl. spark plug connector							
1.0 TSI	Petrol	81	05/15-06/17	CHZC						1.970.599	C10	
ENGINE All engines					Information x 3, BERU, ELDOR, COIL ON PLUG, incl. spark plug connector, Number of pins:4, incl. spark plug connector							
1.2	Petrol	44	07/09-05/15	CGPB						1.970.474	C10	
ENGINE All engines					Information x 3, COIL ON PLUG, incl. spark plug connector							
1.2	Petrol	51	03/08-05/15	BZG, CGPA, CJLB						1.970.474	C10	
ENGINE All engines					Information x 3, COIL ON PLUG, incl. spark plug connector							
1.2 LPG	Petrol/ Liquified Petro- leum Gas (LPG)	51	03/08-05/11	BZG						1.970.474	C10	
ENGINE All engines					Information x 3, COIL ON PLUG, incl. spark plug connector							
1.2 TSI	Petrol	63	08/12-05/15	CBZA						1.990.420	C30	1.499.248
ENGINE All engines					Information x 4, BERU, ELDOR, COIL ON PLUG, incl. spark plug connector, Number of pins:4, incl. spark plug connector							
1.2 TSI	Petrol	66	05/15-06/17	CJZC						1.970.599	C10	
ENGINE All engines					Information x 4, BERU, ELDOR, COIL ON PLUG, incl. spark plug connector, Number of pins:4, incl. spark plug connector							
1.2 TSI	Petrol	77	09/10-05/15	CBZB						1.990.420	C30	1.499.248
ENGINE All engines					Information x 4, BERU, ELDOR, COIL ON PLUG, incl. spark plug connector, Number of pins:4, incl. spark plug connector							
1.2 TSI	Petrol	81	09/15-06/17	CJZD						1.970.599	C10	
ENGINE All engines					Information x 4, BERU, ELDOR, COIL ON PLUG, incl. spark plug connector, Number of pins:4, incl. spark plug connector							
1.4	Petrol	63	03/08-05/15	BXW, CGGB						1.970.474	C10	
ENGINE All engines					Information x 4, COIL ON PLUG, incl. spark plug connector							
1.4 LPG	Petrol/ Liquified Petro- leum Gas (LPG)	63	03/08-05/11	BXW						1.970.474	C10	
ENGINE All engines					Information x 4, COIL ON PLUG, incl. spark plug connector							
1.4 TSI	Petrol	103	10/13-05/15	CPTA						1.970.599	C10	
ENGINE All engines					Information x 4, BERU, ELDOR, COIL ON PLUG, incl. spark plug connector, Number of pins:4, incl. spark plug connector							

A10 CONDENSER	A20 CONTACT SET	A40 DISTRIBUTOR CAP	A50 ROTOR	A70 PICK-UP
C10 COIL	C20 IGNITION MODULE	C30 ELECTRONIC IGNITION KIT	E01 IGNITION CABLE SET	

Vehicle	alim.	kW	Date	Engine	FUNCTIONS ON THE VEHICLE									
					A10	A20	A40	A50	A70	C10 - C30	C20	E01		
1.4 TSI	Petrol	110	01/09-06/17	ENGINE CAVF, CNUB, CTHF, CTJB, CZEA										
Engine	Information				A10	A20	A40	A50	A70	C10 - C30	C20	E01		
Eng. CAVF, CNUB, CTHF, CTJB	x 4, COIL ON PLUG, incl. spark plug connector									1.970.474	C10			
Eng. CZEA	x 4, BERU, ELDOR, COIL ON PLUG, incl. spark plug connector, Number of pins:4, incl. spark plug connector									1.970.599	C10			
1.4 TSI Cupra	Petrol	132	06/09-05/15	ENGINE CAVE, CTHE, CTJC										
Engine	Information				A10	A20	A40	A50	A70	C10 - C30	C20	E01		
All engines	x 4, COIL ON PLUG, incl. spark plug connector									1.970.474	C10			
1.6	Petrol	77	05/08-05/15	ENGINE BTS										
Engine	Information				A10	A20	A40	A50	A70	C10 - C30	C20	E01		
All engines	x 4, COIL ON PLUG, incl. spark plug connector									1.970.474	C10			
1.6	Petrol	81	07/15-06/17	ENGINE CWVA										
Engine	Information				A10	A20	A40	A50	A70	C10 - C30	C20	E01		
All engines	x 4, BERU, ELDOR, COIL ON PLUG, incl. spark plug connector, Number of pins:4, incl. spark plug connector									1.970.599	C10			
1.6 LPG	Petrol/ Liquified Petro- leum Gas (LPG)	60	05/11-05/15	ENGINE CNKA										
Engine	Information				A10	A20	A40	A50	A70	C10 - C30	C20	E01		
All engines	x 4, COIL ON PLUG, incl. spark plug connector									1.970.474	C10			
1.6 SRE	Petrol	66	07/15->	ENGINE CWVB										
Engine	Information				A10	A20	A40	A50	A70	C10 - C30	C20	E01		
All engines	Qty: 4									1.970.599	C10			
1.6 SRE	Petrol	81	07/15->	ENGINE CWVA										
Engine	Information				A10	A20	A40	A50	A70	C10 - C30	C20	E01		
All engines	Qty: 4									1.970.599	C10			
1.8 TSI Cupra	Petrol	141	11/15-12/16	ENGINE DAJA										
Engine	Information				A10	A20	A40	A50	A70	C10 - C30	C20	E01		
All engines	x 4, BERU, ELDOR, COIL ON PLUG, incl. spark plug connector, Number of pins:4, incl. spark plug connector									1.970.599	C10			
2.0	Petrol	85	10/08-05/15	ENGINE CEKA										
Engine	Information				A10	A20	A40	A50	A70	C10 - C30	C20	E01		
All engines										1.990.420	C30		1.501.585	
IBIZA V														
1.0	Petrol	48	07/17->	ENGINE CHYC										
Engine	Information				A10	A20	A40	A50	A70	C10 - C30	C20	E01		
All engines	x 3, BERU, x 3, COIL ON PLUG, ELDOR, COIL ON PLUG, incl. spark plug connector, incl. spark plug connector, Number of pins:4, incl. spark plug connector									1.970.599	C10			
1.0	Petrol	55	01/17->	ENGINE CHYB										
Engine	Information				A10	A20	A40	A50	A70	C10 - C30	C20	E01		
All engines	x 3, BERU, x 3, COIL ON PLUG, ELDOR, COIL ON PLUG, incl. spark plug connector, incl. spark plug connector, Number of pins:4, incl. spark plug connector									1.970.599	C10			
1.0 TGI	Petrol/ Com- pressed Natural Gas (CNG)	66	11/17->	ENGINE DBYA										
Engine	Information				A10	A20	A40	A50	A70	C10 - C30	C20	E01		
All engines	x 3, BERU, x 3, COIL ON PLUG, ELDOR, COIL ON PLUG, incl. spark plug connector, incl. spark plug connector, Number of pins:4, incl. spark plug connector									1.970.599	C10			

A10 CONDENSER	A20 CONTACT SET	A40 DISTRIBUTOR CAP	A50 ROTOR	A70 PICK-UP
C10 COIL	C20 IGNITION MODULE	C30 ELECTRONIC IGNITION KIT	E01 IGNITION CABLE SET	

The present application list is a brief version. For the detailed information about the possibility of installation on a specific vehicle, please refer to our web-catalogue <http://catalogo.facet.eu/>

Vehicle	alim.	kW	Date	Engine	FUNCTIONS ON THE VEHICLE							
					A10	A20	A40	A50	A70	C10 - C30	C20	E01

ENGINE				
1.0 TSI	Petrol	70	01/17->	CHZL, DKLA, DLAC

Engine	Information	A10	A20	A40	A50	A70	C10 - C30	C20	E01
All engines	x 3, BERU, x 3, COIL ON PLUG, ELDOR, COIL ON PLUG, incl. spark plug connector, incl. spark plug connector, Number of pins:4, incl. spark plug connector						1.970.599	C10	

ENGINE				
1.0 TSI	Petrol	81	06/20->	DLAA

Engine	Information	A10	A20	A40	A50	A70	C10 - C30	C20	E01
All engines	x 3, HITACHI, x 3, COIL ON PLUG, ELDOR, COIL ON PLUG, incl. spark plug connector, incl. spark plug connector, Number of pins:4, incl. spark plug connector						1.970.599	C10	

ENGINE				
1.0 TSI	Petrol	85	01/17->	CHZJ, DKJA, DKRF

Engine	Information	A10	A20	A40	A50	A70	C10 - C30	C20	E01
All engines	x 3, BERU, x 3, COIL ON PLUG, ELDOR, COIL ON PLUG, incl. spark plug connector, incl. spark plug connector, Number of pins:4, incl. spark plug connector						1.970.599	C10	

ENGINE				
1.6	Petrol	81	05/17->	CWVA

Engine	Information	A10	A20	A40	A50	A70	C10 - C30	C20	E01
All engines	x 4, BERU, x 4, COIL ON PLUG, ELDOR, COIL ON PLUG, incl. spark plug connector, incl. spark plug connector, Number of pins:4, incl. spark plug connector						1.970.599	C10	

INCA

ENGINE				
1.4 16V	Petrol	55	04/00-06/03	AUA

Engine	Information	A10	A20	A40	A50	A70	C10 - C30	C20	E01
All engines							1.990.420	C30	1.501.575

ENGINE				
1.4 i	Petrol	44	11/95-06/03	AEX, AKV, APQ, AUD

Engine	Information	A10	A20	A40	A50	A70	C10 - C30	C20	E01
Eng. AEX, AKV, APQ	version Bosch, without cover			1.306.094					
Eng. AEX, AKV, APQ	version Bosch, with cover			1.306.266					
Eng. AEX, AKV, APQ	version Ducellier			1.315.068	1.415.099R				
Eng. AEX, AKV, APQ	version Marelli			1.330.116	1.430.057R				
Eng. AEX, AKV, APQ	version Bosch				1.406.121R	1.906.223			
Eng. AEX, AKV, APQ							1.990.414	C30	1.501.660
Eng. AUD							1.990.420	C30	1.501.601

ENGINE				
1.6 i	Petrol	55	11/95-09/00	1F, AEE

Engine	Information	A10	A20	A40	A50	A70	C10 - C30	C20	E01
All engines	version Bosch, without cover			1.306.094					
All engines	version Bosch, with cover			1.306.266					
All engines	version Ducellier			1.315.068	1.415.099R				
All engines	version Marelli			1.330.116	1.430.057R				
All engines	version Bosch				1.406.121R	1.906.223			
All engines							1.990.414	C30	
Eng. 1F									1.500.965
Eng. AEE									1.501.660

LEON I

ENGINE				
1.4 16V	Petrol	55	11/99-06/06	2CJXE, AHW, AXP, BCA

Engine	Information	A10	A20	A40	A50	A70	C10 - C30	C20	E01
Eng. BCA	x 4, COIL ON PLUG, incl. spark plug connector						1.970.474	C10	
Eng. 2CJXE, AHW, AXP							1.990.420	C30	1.501.575

ENGINE				
1.6	Petrol	74	11/99-06/06	AEH, AKL









Engine	Information	A10	A20	A40	A50	A70	C10 - C30	C20	E01
All engines							1.990.420	C30	1.501.484

ENGINE				
1.6	Petrol	75	10/05-06/06	BFQ

Engine	Information	A10	A20	A40	A50	A70	C10 - C30	C20	E01
All engines							1.990.420	C30	1.501.585

A10 CONDENSER	A20 CONTACT SET	A40 DISTRIBUTOR CAP	A50 ROTOR	A70 PICK-UP
C10 COIL	C20 IGNITION MODULE	C30 ELECTRONIC IGNITION KIT	E01 IGNITION CABLE SET	

Vehicle	alim.	kW	Date	Engine	FUNCTIONS ON THE VEHICLE												
					A10	A20	A40	A50	A70	C10 - C30	C20	E01					
ENGINE																	
1.6 16 V	Petrol	77	09/00-06/06	AUS, AZD, BCB													
Engine	Information				A10	A20	A40	A50	A70	C10 - C30	C20	E01					
Eng. AZD, BCB	x 4, COIL ON PLUG, incl. spark plug connector									1.970.474	C10						
Eng. AUS										1.990.420	C30		1.501.575				
ENGINE																	
1.8 20V	Petrol	92	11/99-06/06	AGN, APG													
Engine	Information				A10	A20	A40	A50	A70	C10 - C30	C20	E01					
All engines										1.990.420	C30		1.501.489				
ENGINE																	
1.8 20V T	Petrol	132	11/99-06/06	APP, AUQ													
Engine	Information				A10	A20	A40	A50	A70	C10 - C30	C20	E01					
Eng. AUQ	x 4, COIL ON PLUG, incl. spark plug connector									1.970.429	C10						
Eng. APP	x 4, COIL ON PLUG, incl. spark plug connector									1.970.445	C10						
Eng. APP											1.965.076						
ENGINE																	
1.8 20V T 4	Petrol	132	11/99-06/06	AJQ, ARY													
Engine	Information				A10	A20	A40	A50	A70	C10 - C30	C20	E01					
Eng. ARY	x 4, COIL ON PLUG, incl. spark plug connector									1.970.429	C10						
Eng. AJQ	x 4, COIL ON PLUG, incl. spark plug connector									1.970.445	C10						
ENGINE																	
1.8 T Cupra R	Petrol	154	02/02-06/06	AMK													
Engine	Information				A10	A20	A40	A50	A70	C10 - C30	C20	E01					
All engines	x 4, COIL ON PLUG, incl. spark plug connector									1.970.429	C10						
ENGINE																	
1.8 T Cupra R	Petrol	165	07/03-06/06	BAM													
Engine	Information				A10	A20	A40	A50	A70	C10 - C30	C20	E01					
All engines	x 4, COIL ON PLUG, incl. spark plug connector									1.970.429	C10						
ENGINE																	
1.8 Turbo 4x4	Petrol	154	05/02-05/03	AMK													
Engine	Information				A10	A20	A40	A50	A70	C10 - C30	C20	E01					
All engines	Qty: 4									1.970.429	C10						
ENGINE																	
2.3 V5	Petrol	110	10/98-11/00	AGZ													
Engine	Information				A10	A20	A40	A50	A70	C10 - C30	C20	E01					
All engines											1.965.074						
ENGINE																	
2.3 VR5	Petrol	125	09/00-11/03	AQN													
Engine	Information				A10	A20	A40	A50	A70	C10 - C30	C20	E01					
All engines	Qty: 5									1.970.435	C10						
ENGINE																	
2.8	Petrol	150	05/02-06/04	BDE													
Engine	Information				A10	A20	A40	A50	A70	C10 - C30	C20	E01					
All engines	x 6, COIL ON PLUG, incl. spark plug connector									1.970.434	C10						
ENGINE																	
2.8 Cupra 4	Petrol	150	02/01-06/06	AUE, BDE													
Engine	Information				A10	A20	A40	A50	A70	C10 - C30	C20	E01					
All engines	x 6, COIL ON PLUG, incl. spark plug connector									1.970.434	C10						
LEON II																	
ENGINE																	
1.2 TSI	Petrol	77	02/10-12/12	CBZB													
Engine	Information				A10	A20	A40	A50	A70	C10 - C30	C20	E01					
All engines										1.990.420	C30		1.499.248				
ENGINE																	
1.4 16V	Petrol	63	06/06-12/12	BXW													
Engine	Information				A10	A20	A40	A50	A70	C10 - C30	C20	E01					
All engines	x 4, COIL ON PLUG, incl. spark plug connector									1.970.474	C10						
ENGINE																	
1.4 TSI	Petrol	92	11/07-12/12	CAXC													
Engine	Information				A10	A20	A40	A50	A70	C10 - C30	C20	E01					
All engines	x 4, COIL ON PLUG, incl. spark plug connector									1.970.474	C10						
A10	CONDENSER	A20	CONTACT SET	A40	DISTRIBUTOR CAP	A50	ROTOR	A70	PICK-UP	C10	COIL	C20	IGNITION MODULE	C30	ELECTRONIC IGNITION KIT	E01	IGNITION CABLE SET

					FUNCTIONS ON THE VEHICLE							
Vehicle	alim.	kW	Date	Engine	 A10	 A20	 A40	 A50	 A70	 C10 - C30	 C20	 E01
ENGINE												
1.6	Petrol	75	07/05-12/12	BSE, BSF, CCSA, CMXA								
ENGINE												
Engine					A10	A20	A40	A50	A70	C10 - C30	C20	E01
Eng. BSE, BSF, CCSA										1.990.420	C30	
All engines												1.501.585
ENGINE												
1.6 LPG	Petrol/ Liquified Petro- leum Gas (LPG)	75	12/09-12/12	CHGA								
ENGINE												
Engine					A10	A20	A40	A50	A70	C10 - C30	C20	E01
All engines										1.990.420	C30	1.501.585
ENGINE												
1.6 MultiFuel	Petrol/ Ethanol	75	07/05-08/13	BSE, CCSA, CMXA								
ENGINE												
Engine					A10	A20	A40	A50	A70	C10 - C30	C20	E01
All engines										1.990.420	C30	
Eng. BSE, CMXA												1.501.585
ENGINE												
1.8 TSI	Petrol	118	06/07-12/12	BZB, CDA A								
ENGINE												
Engine					A10	A20	A40	A50	A70	C10 - C30	C20	E01
All engines										1.970.426	C10	
x 4, ELDOR, Housing Colour:Black, COIL ON PLUG, incl. spark plug connector												
ENGINE												
2.0 Cupra R	Petrol	195	09/09-12/12	CDLA								
ENGINE												
Engine					A10	A20	A40	A50	A70	C10 - C30	C20	E01
All engines										1.970.426	C10	
x 4, ELDOR, Housing Colour:Black, COIL ON PLUG, incl. spark plug connector												
ENGINE												
2.0 TFSI	Petrol	110	07/05-05/10	BLR, BLY, BVY, BVZ								
ENGINE												
Engine					A10	A20	A40	A50	A70	C10 - C30	C20	E01
All engines										1.970.426	C10	
x 4, ELDOR, Housing Colour:Black, COIL ON PLUG, incl. spark plug connector												
ENGINE												
2.0 TFSI	Petrol	136	09/05-05/06	BWA								
ENGINE												
Engine					A10	A20	A40	A50	A70	C10 - C30	C20	E01
All engines										1.970.426	C10	
x 4, ELDOR, Housing Colour:Black, COIL ON PLUG, incl. spark plug connector												
ENGINE												
2.0 TFSI	Petrol	147	05/05-03/09	BWA								
ENGINE												
Engine					A10	A20	A40	A50	A70	C10 - C30	C20	E01
All engines										1.970.426	C10	
x 4, ELDOR, Housing Colour:Black, COIL ON PLUG, incl. spark plug connector												
ENGINE												
2.0 TFSI	Petrol	155	06/09-12/12	CCZB								
ENGINE												
Engine					A10	A20	A40	A50	A70	C10 - C30	C20	E01
All engines										1.970.474	C10	
x 4, COIL ON PLUG, incl. spark plug connector												
ENGINE												
2.0 TFSI	Petrol	177	11/06-05/11	BWJ, CDLD								
ENGINE												
Engine					A10	A20	A40	A50	A70	C10 - C30	C20	E01
All engines										1.970.426	C10	
x 4, ELDOR, Housing Colour:Black, COIL ON PLUG, incl. spark plug connector												
LEON III												
ENGINE												
1.0 TSi	Petrol	63	09/18->	DKLB								
ENGINE												
Engine					A10	A20	A40	A50	A70	C10 - C30	C20	E01
All engines										1.970.599	C10	
x 3, BERU, ELDOR, COIL ON PLUG, incl. spark plug connector, Number of pins:4, incl. spark plug connector												
ENGINE												
1.0 TSi	Petrol	85	05/15->	CHZD								
ENGINE												
Engine					A10	A20	A40	A50	A70	C10 - C30	C20	E01
All engines										1.970.599	C10	
x 3, BERU, ELDOR, x 3, BERU, COIL ON PLUG, ELDOR, COIL ON PLUG, incl. spark plug connector, Number of pins:4, incl. spark plug connector, Number of pins:4, incl. spark plug connector												

A10 CONDENSER	A20 CONTACT SET	A40 DISTRIBUTOR CAP	A50 ROTOR	A70 PICK-UP
C10 COIL	C20 IGNITION MODULE	C30 ELECTRONIC IGNITION KIT	E01 IGNITION CABLE SET	

Vehicle	alim.	kW	Date	Engine	FUNCTIONS ON THE VEHICLE							
					A10	A20	A40	A50	A70	C10 - C30	C20	E01
ENGINE												
1.2 TSI	Petrol	63	12/12->	CJZB, CYVA								
Engine	Information			A10	A20	A40	A50	A70	C10 - C30	C20	E01	
All engines	x 4, BERU, ELDOR, COIL ON PLUG, incl. spark plug connector, Number of pins:4, incl. spark plug connector								1.970.599	C10		
ENGINE												
1.2 TSI	Petrol	77	01/13->	CJZA								
Engine	Information			A10	A20	A40	A50	A70	C10 - C30	C20	E01	
All engines	x 4, BERU, ELDOR, COIL ON PLUG, incl. spark plug connector, Number of pins:4, incl. spark plug connector								1.970.599	C10		
ENGINE												
1.2 TSI	Petrol	81	04/14->	CYVB								
Engine	Information			A10	A20	A40	A50	A70	C10 - C30	C20	E01	
All engines	x 4, BERU, ELDOR, COIL ON PLUG, incl. spark plug connector, Number of pins:4, incl. spark plug connector								1.970.599	C10		
ENGINE												
1.4 TGI	Petrol/ Compressed Natural Gas (CNG)	81	02/13->	CPWA								
Engine	Information			A10	A20	A40	A50	A70	C10 - C30	C20	E01	
All engines	x 4, BERU, ELDOR, COIL ON PLUG, incl. spark plug connector, Number of pins:4, incl. spark plug connector								1.970.599	C10		
ENGINE												
1.4 TSI	Petrol	103	09/12->	CHPA								
Engine	Information			A10	A20	A40	A50	A70	C10 - C30	C20	E01	
All engines	x 4, BERU, ELDOR, COIL ON PLUG, incl. spark plug connector, Number of pins:4, incl. spark plug connector								1.970.599	C10		
ENGINE												
1.4 TSI	Petrol	110	05/14->	CZDA, CZEA								
Engine	Information			A10	A20	A40	A50	A70	C10 - C30	C20	E01	
All engines	x 4, BERU, ELDOR, x 4, BERU, COIL ON PLUG, ELDOR, COIL ON PLUG, incl. spark plug connector, Number of pins:4, incl. spark plug connector, Number of pins:4, incl. spark plug connector								1.970.599	C10		
Eng. CZDA	Qty: 4								1.970.599	C10		
ENGINE												
1.4 TSI	Petrol	90	09/12->	CMBA, CXSA								
Engine	Information			A10	A20	A40	A50	A70	C10 - C30	C20	E01	
All engines	x 4, BERU, ELDOR, COIL ON PLUG, incl. spark plug connector, Number of pins:4, incl. spark plug connector								1.970.599	C10		
ENGINE												
1.4 TSI	Petrol	92	05/14->	CZCA								
Engine	Information			A10	A20	A40	A50	A70	C10 - C30	C20	E01	
All engines	x 4, BERU, ELDOR, COIL ON PLUG, incl. spark plug connector, Number of pins:4, incl. spark plug connector								1.970.599	C10		
ENGINE												
1.6 TSI	Petrol	81	05/15->	CWVA								
Engine	Information			A10	A20	A40	A50	A70	C10 - C30	C20	E01	
All engines	Qty: 4								1.970.599	C10		
ENGINE												
1.8 TFSI	Petrol	132	02/13->	CJSA								
Engine	Information			A10	A20	A40	A50	A70	C10 - C30	C20	E01	
All engines	->year 01/09/18, x 4, HITACHI, COIL ON PLUG, incl. spark plug connector								1.970.636	C10		
ENGINE												
1.8 TSI	Petrol	132	02/13->	CJSA								
Engine	Information			A10	A20	A40	A50	A70	C10 - C30	C20	E01	
All engines	->year 01/09/18, x 4, HITACHI, x 4, COIL ON PLUG, HITACHI, COIL ON PLUG, incl. spark plug connector, incl. spark plug connector								1.970.636	C10		
ENGINE												
1.8 TSI 4Drive	Petrol	132	11/14->	CJSA, CJSB								
Engine	Information			A10	A20	A40	A50	A70	C10 - C30	C20	E01	
All engines	->year 01/09/18, x 4, HITACHI, COIL ON PLUG, incl. spark plug connector								1.970.636	C10		

A10	CONDENSER	A20	CONTACT SET	A40	DISTRIBUTOR CAP	A50	ROTOR	A70	PICK-UP
C10	COIL	C20	IGNITION MODULE	C30	ELECTRONIC IGNITION KIT	E01	IGNITION CABLE SET		

The present application list is a brief version. For the detailed information about the possibility of installation on a specific vehicle, please refer to our web-catalogue <http://catalogo.facet.eu/>

Vehicle	alim.	kW	Date	Engine	FUNCTIONS ON THE VEHICLE							
					A10	A20	A40	A50	A70	C10 - C30	C20	E01

ENGINE				
2.0 TSI	Petrol	140	09/18->	DKZA

Engine	Information	A10	A20	A40	A50	A70	C10 - C30	C20	E01
All engines	01/10/18 ->, x 4, HITACHI, COIL ON PLUG, incl. spark plug connector						1.970.636	C10	

ENGINE				
2.0 TSI 4Drive	Petrol	140	09/18->	DKZA

Engine	Information	A10	A20	A40	A50	A70	C10 - C30	C20	E01
All engines	01/10/18 ->, x 4, HITACHI, COIL ON PLUG, incl. spark plug connector						1.970.636	C10	

LEON IV

ENGINE				
1.0 TSI	Petrol	66	03/20->	DLAB

Engine	Information	A10	A20	A40	A50	A70	C10 - C30	C20	E01
All engines	x 3, ELDOR, HITACHI, COIL ON PLUG, incl. spark plug connector, Number of pins:4, incl. spark plug connector						1.970.599	C10	

ENGINE				
1.0 TSI	Petrol	81	03/20->	DLAA

Engine	Information	A10	A20	A40	A50	A70	C10 - C30	C20	E01
All engines	x 3, ELDOR, HITACHI, COIL ON PLUG, incl. spark plug connector, Number of pins:4, incl. spark plug connector						1.970.599	C10	

ENGINE				
1.0 TSI Mild Hybrid	Petrol/ Electric	81	08/20->	DLAA

Engine	Information	A10	A20	A40	A50	A70	C10 - C30	C20	E01
All engines	x 3, ELDOR, HITACHI, x 3, x 4, COIL ON PLUG, ELDOR, COIL ON PLUG, incl. spark plug connector, incl. spark plug connector, Number of pins:4, incl. spark plug connector						1.970.599	C10	

ENGINE				
1.4 TSI e-Hybrid	Petrol/ Electric	110	05/20->	DGEA

Engine	Information	A10	A20	A40	A50	A70	C10 - C30	C20	E01
All engines	x 4, ELDOR, COIL ON PLUG, Number of pins:4, incl. spark plug connector						1.970.599	C10	

ENGINE				
1.4 TSI e-Hybrid	Petrol/ Electric	150	05/20->	DGEA

Engine	Information	A10	A20	A40	A50	A70	C10 - C30	C20	E01
All engines	x 4, ELDOR, COIL ON PLUG, Number of pins:4, incl. spark plug connector						1.970.599	C10	

ENGINE				
2.0 TFSI	Petrol	140	03/21->	DNNA

Engine	Information	A10	A20	A40	A50	A70	C10 - C30	C20	E01
All engines	x 4, HITACHI, COIL ON PLUG, incl. spark plug connector						1.970.636	C10	

MALAGA

ENGINE				
1.2	Petrol	44	05/85-12/93	021 A 1000

Engine	Information	A10	A20	A40	A50	A70	C10 - C30	C20	E01
All engines	version Bosch			1.306.079	1.406.056R	1.906.193			
All engines	version Marelli			1.330.101	1.430.047R				
All engines									1.500.612

ENGINE				
1.5	Petrol	63	05/85-12/93	021 A 2000

Engine	Information	A10	A20	A40	A50	A70	C10 - C30	C20	E01
All engines	version Bosch			1.306.079	1.406.056R	1.906.193			
All engines	version Marelli			1.330.101	1.430.047R				
All engines									1.500.612

ENGINE				
1.5 i	Petrol	74	01/87-12/93	021 B.2000

Engine	Information	A10	A20	A40	A50	A70	C10 - C30	C20	E01
All engines	version Bosch			1.306.079	1.406.121R				

MARBELLA

ENGINE				
0.8	Petrol	25	08/86-12/93	5K9K 718

Engine	Information	A10	A20	A40	A50	A70	C10 - C30	C20	E01
All engines	version Femsa		1.217.020	1.317.016, 1.317.029	1.417.052R				
All engines	version Marelli		1.230.142		1.430.042R				

A10 CONDENSER	A20 CONTACT SET	A40 DISTRIBUTOR CAP	A50 ROTOR	A70 PICK-UP
C10 COIL	C20 IGNITION MODULE	C30 ELECTRONIC IGNITION KIT	E01 IGNITION CABLE SET	

Vehicle	alim.	kW	Date	Engine	FUNCTIONS ON THE VEHICLE									
					A10	A20	A40	A50	A70	C10 - C30	C20	E01		
MARBELLA														
0.8	Petrol	25	08/86-12/93	ENGINE 5K9K 718										
Engine		Information			A10	A20	A40	A50	A70	C10 - C30	C20	E01		
All engines										1.970.101D	C10			
0.9														
0.9	Petrol	29	01/87-12/93	ENGINE 09 NCA, 100 GL 7000										
Engine		Information			A10	A20	A40	A50	A70	C10 - C30	C20	E01		
Eng. 09 NCA		version Marelli			1.130.128	1.230.146M	1.330.098	1.430.047R						
Eng. 09 NCA		version Femsa				1.230.132	1.317.014	1.417.052R						
Eng. 100 GL 7000		version MARELLI					1.330.076							
All engines								1.430.037						
Eng. 09 NCA										1.970.101D	C10			
0.9														
0.9	Petrol	32	07/97-10/98	ENGINE 08 NCB										
Engine		Information			A10	A20	A40	A50	A70	C10 - C30	C20	E01		
All engines		version MARELLI					1.330.076							
0.9 Cat														
0.9 Cat	Petrol	29	01/87-11/96	ENGINE 09 NCB, 100 GL 7000										
Engine		Information			A10	A20	A40	A50	A70	C10 - C30	C20	E01		
All engines		version MARELLI					1.330.076							
0.9 Cat														
0.9 Cat	Petrol	30	11/96-10/98	ENGINE 08 NCB										
Engine		Information			A10	A20	A40	A50	A70	C10 - C30	C20	E01		
All engines		version MARELLI					1.330.076							
All engines		Qty: 2								1.970.196	C10			
MII														
1.0	Petrol	44	10/11-07/19	ENGINE CHYA										
Engine		Information			A10	A20	A40	A50	A70	C10 - C30	C20	E01		
All engines		x 3, x 4, BERU, ELDOR, HITACHI, COIL ON PLUG, incl. spark plug connector, Number of pins:4, incl. spark plug connector								1.970.599	C10			
1.0														
1.0	Petrol	55	10/11-07/19	ENGINE CHYB										
Engine		Information			A10	A20	A40	A50	A70	C10 - C30	C20	E01		
All engines		x 3, x 4, BERU, ELDOR, HITACHI, COIL ON PLUG, incl. spark plug connector, Number of pins:4, incl. spark plug connector								1.970.599	C10			
1.0 EcoFuel														
1.0 EcoFuel	Petrol/ Com- pressed Natural Gas (CNG)	50	10/12-07/19	ENGINE CPGA										
Engine		Information			A10	A20	A40	A50	A70	C10 - C30	C20	E01		
All engines		x 3, x 4, BERU, ELDOR, HITACHI, COIL ON PLUG, incl. spark plug connector, Number of pins:4, incl. spark plug connector								1.970.599	C10			
PANDA														
0.9	Petrol	31	10/80-12/86	ENGINE 100 GL 3000										
Engine		Information			A10	A20	A40	A50	A70	C10 - C30	C20	E01		
All engines		version Femsa				1.230.132	1.317.014	1.417.052R						
All engines										1.970.101D	C10			
RONDA														
1.2	Petrol	47	08/83-05/85	ENGINE 021 A 1000										
Engine		Information			A10	A20	A40	A50	A70	C10 - C30	C20	E01		
All engines		version Femsa						1.417.052						
All engines		version Marelli						1.430.054R						
1.6														
1.6	Petrol	68	08/83-09/85	ENGINE 138 AR6.000										
Engine		Information			A10	A20	A40	A50	A70	C10 - C30	C20	E01		
All engines		version Femsa						1.417.052						

A10	CONDENSER	A20	CONTACT SET	A40	DISTRIBUTOR CAP	A50	ROTOR	A70	PICK-UP
C10	COIL	C20	IGNITION MODULE	C30	ELECTRONIC IGNITION KIT	E01	IGNITION CABLE SET		

The present application list is a brief version. For the detailed information about the possibility of installation on a specific vehicle, please refer to our web-catalogue <http://catalogo.facet.eu/>

Vehicle	alim.	kW	Date	Engine	FUNCTIONS ON THE VEHICLE							
					A10	A20	A40	A50	A70	C10 - C30	C20	E01

TARRACO

				ENGINE
1.4 e-HYBRID	Petrol/ Electric	180	02/21->	DGEA

Engine	Information	A10	A20	A40	A50	A70	C10 - C30	C20	E01
All engines	x 4, ELDOR, COIL ON PLUG, incl. spark plug connector, Number of pins:4, incl. spark plug connector						1.970.599	C10	

				ENGINE
1.4 TSI Plug in Hybrid	Petrol/ Electric	110	02/21->	DGEA

Engine	Information	A10	A20	A40	A50	A70	C10 - C30	C20	E01
All engines	x 4, ELDOR, COIL ON PLUG, incl. spark plug connector, Number of pins:4, incl. spark plug connector						1.970.599	C10	

				ENGINE
2.0 TFSI 4Drive	Petrol	180	01/21->	DNPA

Engine	Information	A10	A20	A40	A50	A70	C10 - C30	C20	E01
All engines	x 4, HITACHI, COIL ON PLUG, incl. spark plug connector						1.970.636	C10	

				ENGINE
2.0 TSI 4Drive	Petrol	140	11/18->	DKZA

Engine	Information	A10	A20	A40	A50	A70	C10 - C30	C20	E01
All engines	x 4, HITACHI, COIL ON PLUG, incl. spark plug connector						1.970.636	C10	

TERRA

				ENGINE
0.9	Petrol	29	02/87-12/96	09 NCA

Engine	Information	A10	A20	A40	A50	A70	C10 - C30	C20	E01
All engines	version Marelli	1.130.128	1.230.146M	1.330.098	1.430.047R				
All engines	version Femsa		1.230.132	1.317.014	1.417.052R				
All engines							1.970.101D	C10	

				ENGINE
0.9 Cat	Petrol	29	02/92-12/94	09 NCB

Engine	Information	A10	A20	A40	A50	A70	C10 - C30	C20	E01
All engines	Qty: 2						1.970.196	C10	

TOLEDO I

				ENGINE
1.6 i	Petrol	52	05/91-12/93	1F

Engine	Information	A10	A20	A40	A50	A70	C10 - C30	C20	E01
All engines	version Bosch, distr. num. 050 905 205 AH			1.306.094	1.406.121R	1.906.223			
All engines	version Bosch, distr. num. 051 905 205			1.306.266	1.406.055R	1.906.159			
All engines	->ch. 1L-ZR001 000						1.970.159	C10	1.965.007
All engines	ch. 1L-ZR001 001 ->						1.990.414	C30	
All engines									1.500.965

				ENGINE
1.6 i	Petrol	54	05/91-03/99	1F, ABN, EZ

Engine	Information	A10	A20	A40	A50	A70	C10 - C30	C20	E01
All engines	version Bosch, distr. num. 050 905 205 AH			1.306.094					
Eng. 1F	version Bosch, distr. num. 051 905 205			1.306.266		1.906.159			
All engines	version Bosch, distr. num. 051 905 205				1.406.055R				
Eng. 1F	version Bosch, distr. num. 050 905 205 AH				1.406.121R	1.906.223			
All engines	->ch. 1L-ZR001 000						1.970.159	C10	
All engines	ch. 1L-ZR001 001 ->						1.990.414	C30	
Eng. 1F	->ch. 1L-ZR001 000								1.965.007
Eng. ABN, EZ	->ch. 1L-ZD304 850								1.500.725
All engines	ch. 1L-ZD304 851 ->								1.500.965

				ENGINE
1.6 i	Petrol	55	01/93-03/99	1F

Engine	Information	A10	A20	A40	A50	A70	C10 - C30	C20	E01
All engines	version Bosch, distr. num. 050 905 205 AH			1.306.094	1.406.121R	1.906.223			
All engines	version Bosch, distr. num. 051 905 205			1.306.266	1.406.055R	1.906.159			
All engines	->ch. 1L-ZR001 000						1.970.159	C10	1.965.007
All engines	ch. 1L-ZR001 001 ->						1.990.414	C30	
All engines									1.500.965

A10 CONDENSER	A20 CONTACT SET	A40 DISTRIBUTOR CAP	A50 ROTOR	A70 PICK-UP
C10 COIL	C20 IGNITION MODULE	C30 ELECTRONIC IGNITION KIT	E01 IGNITION CABLE SET	

Vehicle	alim.	kW	Date	Engine	FUNCTIONS ON THE VEHICLE							
					A10	A20	A40	A50	A70	C10 - C30	C20	E01

				ENGINE
1.6 i	Petrol	74	11/96-03/99	AFT

Engine	Information	A10	A20	A40	A50	A70	C10 - C30	C20	E01
All engines	version Bosch			1.306.266	1.406.121R	1.906.223			
All engines							1.990.414	C30	1.501.937

				ENGINE
1.8 16V	Petrol	92	05/91-03/99	PL

Engine	Information	A10	A20	A40	A50	A70	C10 - C30	C20	E01
All engines	version Bosch			1.306.094	1.406.121R	1.906.233			
All engines							1.970.125	C10	1.965.007

				ENGINE
1.8 16V	Petrol	98	05/91-03/99	KR

Engine	Information	A10	A20	A40	A50	A70	C10 - C30	C20	E01
All engines	version Bosch			1.306.094	1.406.121R	1.906.233			
All engines							1.970.125	C10	

				ENGINE
1.8 GT	Petrol	102	05/91-11/92	KR

Engine	Information	A10	A20	A40	A50	A70	C10 - C30	C20	E01
All engines	version Bosch			1.306.094	1.406.121R	1.906.233			
All engines							1.970.125	C10	

				ENGINE
1.8 i	Petrol	65	05/91-12/96	RP

Engine	Information	A10	A20	A40	A50	A70	C10 - C30	C20	E01
All engines	version Bosch, distr. num. 050 905 205 AH			1.306.094	1.406.121R	1.906.223			
All engines	version Bosch, distr. num. 050 905 205 A			1.306.266	1.406.055R	1.906.159			
All engines							1.970.125	C10	1.965.007
All engines	->ch. 1L-ZD304 850								1.500.725
All engines	ch. 1L-ZD304 851 ->								1.500.965

				ENGINE
1.8 i	Petrol	66	11/93-12/96	ABS, ADZ

Engine	Information	A10	A20	A40	A50	A70	C10 - C30	C20	E01
Eng. ABS	version Bosch			1.306.094		1.906.223			
Eng. ADZ	version Bosch			1.306.266					
Eng. ADZ	version Ducellier			1.315.068	1.415.099R				
All engines	version Bosch				1.406.121R				
Eng. ABS							1.970.159	C10	
All engines	resist. 3700 ohm						1.990.414	C30	
Eng. ADZ	resist. 3300 ohm						1.990.416	C30	
All engines	->ch. 1L-ZD304 850								1.500.725
Eng. ABS	ch. 1L-ZD304 851 ->								1.500.965

				ENGINE
2.0 i	Petrol	85	05/91-03/99	2E, AGG

Engine	Information	A10	A20	A40	A50	A70	C10 - C30	C20	E01
Eng. 2E	version Bosch			1.306.094					
Eng. AGG	version Bosch			1.306.266		1.906.223			
All engines	version Bosch				1.406.121R				
Eng. 2E							1.970.159	C10	
All engines	resist. 3700 ohm						1.990.414	C30	
Eng. AGG	resist. 3300 ohm						1.990.416	C30	
Eng. 2E	->ch. 1L-ZD304 850								1.500.725
All engines	ch. 1L-ZD304 851 ->								1.500.965

				ENGINE
2.0 i 16V	Petrol	110	11/93-03/99	ABF

Engine	Information	A10	A20	A40	A50	A70	C10 - C30	C20	E01
All engines	version Bosch			1.306.263		1.906.223			
All engines							1.970.159, 1.990.414	C10, C30	

TOLEDO II

				ENGINE
1.4 16V	Petrol	55	01/00-05/02	2CJXE, AHW, AXP, BCA

Engine	Information	A10	A20	A40	A50	A70	C10 - C30	C20	E01
Eng. BCA	x 4, COIL ON PLUG, incl. spark plug connector						1.970.474	C10	
Eng. 2CJXE, AHW, AXP							1.990.420	C30	1.501.575

A10 CONDENSER	A20 CONTACT SET	A40 DISTRIBUTOR CAP	A50 ROTOR	A70 PICK-UP
C10 COIL	C20 IGNITION MODULE	C30 ELECTRONIC IGNITION KIT	E01 IGNITION CABLE SET	

Vehicle	alim.	kW	Date	Engine	FUNCTIONS ON THE VEHICLE							
					A10	A20	A40	A50	A70	C10 - C30	C20	E01
ENGINE												
1.0 TSI	Petrol	81	05/17-04/19	CHZC, DKRC								
Engine	Information				A10	A20	A40	A50	A70	C10 - C30	C20	E01
All engines	x 3, BERU, ELDOR, COIL ON PLUG, incl. spark plug connector, Number of pins:4, incl. spark plug connector									1.970.599	C10	
ENGINE												
1.2	Petrol	55	07/12-06/15	CGPC								
Engine	Information				A10	A20	A40	A50	A70	C10 - C30	C20	E01
All engines	x 3, COIL ON PLUG, incl. spark plug connector									1.970.474	C10	
ENGINE												
1.2 TSI	Petrol	63	07/12-06/15	CBZA								
Engine	Information				A10	A20	A40	A50	A70	C10 - C30	C20	E01
All engines										1.990.420	C30	1.499.248
ENGINE												
1.2 TSI	Petrol	66	05/15-05/17	CJZC								
Engine	Information				A10	A20	A40	A50	A70	C10 - C30	C20	E01
All engines	x 4, BERU, ELDOR, COIL ON PLUG, incl. spark plug connector, Number of pins:4, incl. spark plug connector									1.970.599	C10	
ENGINE												
1.2 TSI	Petrol	77	07/12-06/15	CBZB								
Engine	Information				A10	A20	A40	A50	A70	C10 - C30	C20	E01
All engines										1.990.420	C30	1.499.248
ENGINE												
1.2 TSI	Petrol	81	05/15-05/17	CJZD								
Engine	Information				A10	A20	A40	A50	A70	C10 - C30	C20	E01
All engines	x 4, BERU, ELDOR, COIL ON PLUG, incl. spark plug connector, Number of pins:4, incl. spark plug connector									1.970.599	C10	
ENGINE												
1.4 TSI	Petrol	90	07/12-06/15	CAXA								
Engine	Information				A10	A20	A40	A50	A70	C10 - C30	C20	E01
All engines	x 4, COIL ON PLUG, incl. spark plug connector									1.970.474	C10	
ENGINE												
1.4 TSI	Petrol	92	05/15-04/19	CZCA								
Engine	Information				A10	A20	A40	A50	A70	C10 - C30	C20	E01
All engines	x 4, BERU, ELDOR, COIL ON PLUG, incl. spark plug connector, Number of pins:4, incl. spark plug connector									1.970.599	C10	
ENGINE												
1.6	Petrol	77	07/13-06/15	CFNA								
Engine	Information				A10	A20	A40	A50	A70	C10 - C30	C20	E01
All engines	x 4, COIL ON PLUG, incl. spark plug connector									1.970.474	C10	
ENGINE												
1.6	Petrol	81	05/15-04/19	CWVA								
Engine	Information				A10	A20	A40	A50	A70	C10 - C30	C20	E01
All engines	x 4, BERU, ELDOR, COIL ON PLUG, incl. spark plug connector, Number of pins:4, incl. spark plug connector									1.970.599	C10	

A10 CONDENSER	A20 CONTACT SET	A40 DISTRIBUTOR CAP	A50 ROTOR	A70 PICK-UP
C10 COIL	C20 IGNITION MODULE	C30 ELECTRONIC IGNITION KIT	E01 IGNITION CABLE SET	

The present application list is a brief version. For the detailed information about the possibility of installation on a specific vehicle, please refer to our web-catalogue <http://catalogo.facet.eu/>

Vehicle	alim.	kW	Date	Engine	FUNCTIONS ON THE VEHICLE							
					A10	A20	A40	A50	A70	C10 - C30	C20	E01

105,120

1.0 105 S, L	Petrol	32	02/88-12/90	ENGINE	742.10
--------------	--------	----	-------------	--------	--------

Engine	Information	A10	A20	A40	A50	A70	C10 - C30	C20	E01
All engines	01/08/83 ->, version PAL		1.236.045	1.338.242	1.438.262R				

1.0 105 S, L	Petrol	34	08/76-12/90	ENGINE	742.10
--------------	--------	----	-------------	--------	--------

Engine	Information	A10	A20	A40	A50	A70	C10 - C30	C20	E01
All engines	01/08/83 ->, version PAL		1.236.045	1.338.242	1.438.262R				

1.0 105 S, L, GL	Petrol	33	08/76-08/83	ENGINE	742.10
------------------	--------	----	-------------	--------	--------

Engine	Information	A10	A20	A40	A50	A70	C10 - C30	C20	E01
All engines	01/08/83 ->, version PAL		1.236.045	1.338.242	1.438.262R				

1.0 105 S, L, LS	Petrol	33	10/83-12/90	ENGINE	742.10
------------------	--------	----	-------------	--------	--------

Engine	Information	A10	A20	A40	A50	A70	C10 - C30	C20	E01
All engines	01/08/83 ->, version PAL		1.236.045	1.338.242	1.438.262R				

1.2 120 GLS	Petrol	43	02/83-12/90	ENGINE	742.12X
-------------	--------	----	-------------	--------	---------

Engine	Information	A10	A20	A40	A50	A70	C10 - C30	C20	E01
All engines	01/08/83 ->, version PAL		1.236.045	1.338.242	1.438.262R				

1.2 120 L	Petrol	35	08/87-12/90	ENGINE	742.12
-----------	--------	----	-------------	--------	--------

Engine	Information	A10	A20	A40	A50	A70	C10 - C30	C20	E01
All engines	01/08/83 ->, version PAL		1.236.045	1.338.242	1.438.262R				

1.2 120 L	Petrol	38	08/76-12/90	ENGINE	742.12, 742.12X
-----------	--------	----	-------------	--------	-----------------

Engine	Information	A10	A20	A40	A50	A70	C10 - C30	C20	E01
All engines	01/08/83 ->, version PAL		1.236.045	1.338.242	1.438.262R				

1.2 120 LS	Petrol	43	08/76-12/90	ENGINE	742.12X
------------	--------	----	-------------	--------	---------

Engine	Information	A10	A20	A40	A50	A70	C10 - C30	C20	E01
All engines	01/08/83 ->, version PAL		1.236.045	1.338.242	1.438.262R				

CITIGO

1.0	Petrol	44	10/11-08/19	ENGINE	CHYA
-----	--------	----	-------------	--------	------

Engine	Information	A10	A20	A40	A50	A70	C10 - C30	C20	E01
All engines	x 3, BERU, ELDOR, HITACHI, COIL ON PLUG, incl. spark plug connector, Number of pins:4, incl. spark plug connector						1.970.599	C10	

1.0	Petrol	55	10/11-08/19	ENGINE	CHYB
-----	--------	----	-------------	--------	------

Engine	Information	A10	A20	A40	A50	A70	C10 - C30	C20	E01
All engines	x 3, BERU, ELDOR, HITACHI, COIL ON PLUG, incl. spark plug connector, Number of pins:4, incl. spark plug connector						1.970.599	C10	

1.0 CNG	CNG	50	11/12-08/19	ENGINE	CPGA
---------	-----	----	-------------	--------	------

Engine	Information	A10	A20	A40	A50	A70	C10 - C30	C20	E01
All engines	x 3, x 4, BERU, ELDOR, HITACHI, COIL ON PLUG, incl. spark plug connector, Number of pins:4, incl. spark plug connector						1.970.599	C10	

FABIA

1.0 TSI	Petrol	70	06/21->	ENGINE	DLAC
---------	--------	----	---------	--------	------

Engine	Information	A10	A20	A40	A50	A70	C10 - C30	C20	E01
All engines	x 3, version 1, version 2, ELDOR, COIL ON PLUG, incl. spark plug connector						1.970.599	C10	

1.0 TSI	Petrol	81	06/21->	ENGINE	DLAA
---------	--------	----	---------	--------	------

Engine	Information	A10	A20	A40	A50	A70	C10 - C30	C20	E01
All engines	x 3, version 1, version 2, ELDOR, COIL ON PLUG, incl. spark plug connector						1.970.599	C10	

A10 CONDENSER	A20 CONTACT SET	A40 DISTRIBUTOR CAP	A50 ROTOR	A70 PICK-UP
C10 COIL	C20 IGNITION MODULE	C30 ELECTRONIC IGNITION KIT	E01 IGNITION CABLE SET	

Vehicle	alim.	kW	Date	Engine	FUNCTIONS ON THE VEHICLE							
					A10	A20	A40	A50	A70	C10 - C30	C20	E01

FABIA I

1.2	Petrol	40	07/01-12/07	ENGINE AWY, BMD
-----	--------	----	-------------	--------------------

Engine	Information	A10	A20	A40	A50	A70	C10 - C30	C20	E01
All engines	x 3, COIL ON PLUG, incl. spark plug connector						1.970.431	C10	

1.2	Petrol	47	01/03-03/08	ENGINE AZQ, BME
-----	--------	----	-------------	--------------------

Engine	Information	A10	A20	A40	A50	A70	C10 - C30	C20	E01
All engines	x 3, COIL ON PLUG, incl. spark plug connector						1.970.474	C10	

1.4	Petrol	55	05/04-12/07	ENGINE BKY
-----	--------	----	-------------	---------------

Engine	Information	A10	A20	A40	A50	A70	C10 - C30	C20	E01
All engines	x 4, COIL ON PLUG, incl. spark plug connector						1.970.474	C10	

1.4 16V	Petrol	55	10/99-03/08	ENGINE AUA, BBY, BKY
---------	--------	----	-------------	-------------------------

Engine	Information	A10	A20	A40	A50	A70	C10 - C30	C20	E01
Eng. BBY, BKY	ch. 6Y2535495 ->, x 4, COIL ON PLUG, incl. spark plug connector						1.970.474	C10	
Eng. AUA, BBY							1.990.420	C30	
Eng. AUA, BBY	->year 30/04/02								1.501.575

1.4 16V	Petrol	59	04/06-12/07	ENGINE BUD
---------	--------	----	-------------	---------------

Engine	Information	A10	A20	A40	A50	A70	C10 - C30	C20	E01
All engines	x 4, COIL ON PLUG, incl. spark plug connector						1.970.474	C10	

1.4 16V	Petrol	74	12/99-03/08	ENGINE AUB, BBZ
---------	--------	----	-------------	--------------------

Engine	Information	A10	A20	A40	A50	A70	C10 - C30	C20	E01
All engines	01/05/02 -> ch. 6Y2535495 ->, x 4, COIL ON PLUG, x 4, COIL ON PLUG, incl. spark plug connector, incl. spark plug connector						1.970.474	C10	
All engines							1.990.420	C30	
All engines	->year 30/04/02								1.501.575

2.0	Petrol	85	12/99-03/08	ENGINE AZL
-----	--------	----	-------------	---------------

Engine	Information	A10	A20	A40	A50	A70	C10 - C30	C20	E01
All engines							1.990.420	C30	1.501.585

FABIA II

1.2	Petrol	44	12/06-12/14	ENGINE BBM, CHFA
-----	--------	----	-------------	---------------------

Engine	Information	A10	A20	A40	A50	A70	C10 - C30	C20	E01
All engines	x 3, COIL ON PLUG, incl. spark plug connector						1.970.431	C10	

1.2	Petrol	51	01/07-12/14	ENGINE BZG, CEVA, CGPA, CHTA
-----	--------	----	-------------	---------------------------------

Engine	Information	A10	A20	A40	A50	A70	C10 - C30	C20	E01
All engines	x 3, COIL ON PLUG, incl. spark plug connector						1.970.474	C10	

1.2 [IND]	Petrol	55	09/10->	ENGINE CJLA
-----------	--------	----	---------	----------------

Engine	Information	A10	A20	A40	A50	A70	C10 - C30	C20	E01
All engines	Qty: 3						1.970.474	C10	

1.2 12V	Petrol	44	11/11-12/14	ENGINE CGPB
---------	--------	----	-------------	----------------

Engine	Information	A10	A20	A40	A50	A70	C10 - C30	C20	E01
All engines	x 3, COIL ON PLUG, incl. spark plug connector						1.970.474	C10	

1.2 LPG	Petrol/ Liquified Petroleum Gas (LPG)	44	03/09-11/11	ENGINE CHFA
---------	--	----	-------------	----------------







Engine	Information	A10	A20	A40	A50	A70	C10 - C30	C20	E01
All engines	x 3, COIL ON PLUG, incl. spark plug connector						1.970.431	C10	

A10 CONDENSER	A20 CONTACT SET	A40 DISTRIBUTOR CAP	A50 ROTOR	A70 PICK-UP
C10 COIL	C20 IGNITION MODULE	C30 ELECTRONIC IGNITION KIT	E01 IGNITION CABLE SET	

The present application list is a brief version. For the detailed information about the possibility of installation on a specific vehicle, please refer to our web-catalogue <http://catalogo.facet.eu/>

Vehicle					FUNCTIONS ON THE VEHICLE								
Vehicle	alim.	kW	Date	Engine	A10	A20	A40	A50	A70	C10 - C30	C20	E01	
ENGINE													
1.2 LPG	Petrol/ Liquified Petro- leum Gas (LPG)	51	07/07-11/14	CGPA									
Engine	Information				A10	A20	A40	A50	A70	C10 - C30	C20	E01	
All engines	x 3, COIL ON PLUG, incl. spark plug connector									1.970.474	C10		
ENGINE													
1.2 TSI	Petrol	63	03/10-12/14	CBZA									
Engine	Information				A10	A20	A40	A50	A70	C10 - C30	C20	E01	
All engines										1.990.420	C30	1.499.248	
ENGINE													
1.2 TSI	Petrol	77	03/10-12/14	CBZB									
Engine	Information				A10	A20	A40	A50	A70	C10 - C30	C20	E01	
All engines										1.990.420	C30	1.499.248	
ENGINE													
1.4	Petrol	63	01/07-12/14	BXW, CGGB									
Engine	Information				A10	A20	A40	A50	A70	C10 - C30	C20	E01	
All engines	x 4, COIL ON PLUG, incl. spark plug connector									1.970.474	C10		
ENGINE													
1.4 [CHN]	Petrol	63	12/08->	CLPA									
Engine	Information				A10	A20	A40	A50	A70	C10 - C30	C20	E01	
All engines	Qty: 4									1.970.474	C10		
ENGINE													
1.4 LPG	Petrol/ Liquified Petro- leum Gas (LPG)	63	01/07-11/14	BXW, CGGB									
Engine	Information				A10	A20	A40	A50	A70	C10 - C30	C20	E01	
All engines	x 4, COIL ON PLUG, incl. spark plug connector									1.970.474	C10		
ENGINE													
1.4 TSI RS	Petrol	132	05/10-12/14	CAVE, CTHE									
Engine	Information				A10	A20	A40	A50	A70	C10 - C30	C20	E01	
All engines	x 4, COIL ON PLUG, incl. spark plug connector									1.970.474	C10		
ENGINE													
1.6	Petrol	77	04/07-12/14	BTS, CFNA, CLSA									
Engine	Information				A10	A20	A40	A50	A70	C10 - C30	C20	E01	
Eng. BTS, CFNA	x 4, COIL ON PLUG, incl. spark plug connector									1.970.474	C10		
Eng. CLSA	Qty: 4									1.970.474	C10		
FABIA III													
ENGINE													
1.0	Petrol	44	08/14->	CHYA, CHYE									
Engine	Information				A10	A20	A40	A50	A70	C10 - C30	C20	E01	
All engines	x 3, BERU, x 3, COIL ON PLUG, ELDOR, COIL ON PLUG, incl. spark plug connector, incl. spark plug connector, Number of pins:4, incl. spark plug connector									1.970.599	C10		
ENGINE													
1.0	Petrol	55	08/14->	CHYB									
Engine	Information				A10	A20	A40	A50	A70	C10 - C30	C20	E01	
All engines	x 3, BERU, x 3, COIL ON PLUG, ELDOR, COIL ON PLUG, incl. spark plug connector, incl. spark plug connector, Number of pins:4, incl. spark plug connector									1.970.599	C10		
ENGINE													
1.0 TSI	Petrol	70	08/14->	CHZB, DKLD									
Engine	Information				A10	A20	A40	A50	A70	C10 - C30	C20	E01	
All engines	x 3, BERU, x 3, COIL ON PLUG, ELDOR, COIL ON PLUG, incl. spark plug connector, incl. spark plug connector, Number of pins:4, incl. spark plug connector									1.970.599	C10		
ENGINE													
1.0 TSI	Petrol	81	08/14->	CHZC, DKRC									
Engine	Information				A10	A20	A40	A50	A70	C10 - C30	C20	E01	
All engines	x 3, BERU, x 3, COIL ON PLUG, ELDOR, COIL ON PLUG, incl. spark plug connector, incl. spark plug connector, Number of pins:4, incl. spark plug connector									1.970.599	C10		
FUNCTIONS ON THE VEHICLE													
A10	CONDENSER	A20	CONTACT SET	A40	DISTRIBUTOR CAP	A50	ROTOR	A70	PICK-UP				
C10	COIL	C20	IGNITION MODULE	C30	ELECTRONIC IGNITION KIT	E01	IGNITION CABLE SET						

Vehicle	alim.	kW	Date	Engine	FUNCTIONS ON THE VEHICLE							
					A10	A20	A40	A50	A70	C10 - C30	C20	E01
ENGINE												
1.2 TSI	Petrol	66	08/14->	CJZC								
Engine	Information			A10	A20	A40	A50	A70	C10 - C30	C20	E01	
All engines	x 4, BERU, x 4, COIL ON PLUG, ELDOR, COIL ON PLUG, incl. spark plug connector, incl. spark plug connector, Number of pins:4, incl. spark plug connector								1.970.599	C10		
ENGINE												
1.2 TSI	Petrol	81	08/14->	CJZD								
Engine	Information			A10	A20	A40	A50	A70	C10 - C30	C20	E01	
All engines	x 4, BERU, x 4, COIL ON PLUG, ELDOR, COIL ON PLUG, incl. spark plug connector, incl. spark plug connector, Number of pins:4, incl. spark plug connector								1.970.599	C10		
ENGINE												
1.4 TSI R5	Petrol	92	02/18->	CZCA								
Engine	Information			A10	A20	A40	A50	A70	C10 - C30	C20	E01	
All engines	x 4, BERU, x 4, COIL ON PLUG, ELDOR, COIL ON PLUG, incl. spark plug connector, incl. spark plug connector, Number of pins:4, incl. spark plug connector								1.970.599	C10		
ENGINE												
1.6	Petrol	66	01/15->	CWVB								
Engine	Information			A10	A20	A40	A50	A70	C10 - C30	C20	E01	
All engines	Qty: 4, version BERU, version ELDOR, Qty: 4								1.970.599	C10		
ENGINE												
1.6	Petrol	81	01/15->	CWVA								
Engine	Information			A10	A20	A40	A50	A70	C10 - C30	C20	E01	
All engines	x 4, BERU, x 4, COIL ON PLUG, ELDOR, COIL ON PLUG, incl. spark plug connector, incl. spark plug connector, Number of pins:4, incl. spark plug connector								1.970.599	C10		
FAVORIT												
ENGINE												
1.3	Petrol	40	09/91-06/97	135B, 781.135E								
Engine	Information			A10	A20	A40	A50	A70	C10 - C30	C20	E01	
All engines	version PAL					1.338.242	1.438.263R					
All engines									1.990.414	C30		
ENGINE												
1.3	Petrol	42	12/92-06/97	781.135								
Engine	Information			A10	A20	A40	A50	A70	C10 - C30	C20	E01	
All engines	version PAL					1.338.242	1.438.262R, 1.438.263R					
ENGINE												
1.3	Petrol	44	12/91-06/95	781.135								
Engine	Information			A10	A20	A40	A50	A70	C10 - C30	C20	E01	
All engines	version PAL					1.338.242	1.438.262R, 1.438.263R					
ENGINE												
1.3	Petrol	45	08/91-06/95	OHC								
Engine	Information			A10	A20	A40	A50	A70	C10 - C30	C20	E01	
All engines	version PAL					1.338.242	1.438.262R, 1.438.263R					
ENGINE												
1.3	Petrol	50	12/92-06/97	136B								
Engine	Information			A10	A20	A40	A50	A70	C10 - C30	C20	E01	
All engines	version PAL					1.338.242	1.438.263R					
All engines									1.990.414	C30		
ENGINE												
1.3 135	Petrol	42	12/91-09/94	781.135								
Engine	Information			A10	A20	A40	A50	A70	C10 - C30	C20	E01	
All engines	version PAL					1.338.242	1.438.262R, 1.438.263R					
ENGINE												
1.3 135	Petrol	43	12/91-09/94	781.135								
Engine	Information			A10	A20	A40	A50	A70	C10 - C30	C20	E01	
All engines	version PAL					1.338.242	1.438.262R, 1.438.263R					
ENGINE												
1.3 135	Petrol	44	10/90-09/94	781.135								
Engine	Information			A10	A20	A40	A50	A70	C10 - C30	C20	E01	
All engines	version PAL					1.338.242	1.438.262R, 1.438.263R					
FUNCTIONS ON THE VEHICLE												
A10	CONDENSER	A20	CONTACT SET	A40	DISTRIBUTOR CAP	A50	ROTOR	A70	PICK-UP			
C10	COIL	C20	IGNITION MODULE	C30	ELECTRONIC IGNITION KIT	E01	IGNITION CABLE SET					

					FUNCTIONS ON THE VEHICLE												
Vehicle	alim.	kW	Date	Engine	 A10	 A20	 A40	 A50	 A70	 C10 - C30	 C20	 E01					
ENGINE																	
1.3 135 X, LX, GLX	Petrol	40	01/90-09/94	781.135E													
Engine	Information				A10	A20	A40	A50	A70	C10 - C30	C20	E01					
All engines	version PAL						1.338.242	1.438.263R									
All engines										1.990.414	C30						
ENGINE																	
1.3 135L	Petrol	43	05/89-09/94	781.135													
Engine	Information				A10	A20	A40	A50	A70	C10 - C30	C20	E01					
All engines	version PAL						1.338.242	1.438.262R, 1.438.263R									
ENGINE																	
1.3 136	Petrol	45	10/90-09/94	136 L													
Engine	Information				A10	A20	A40	A50	A70	C10 - C30	C20	E01					
All engines	version PAL						1.338.242	1.438.262R, 1.438.263R									
FELICIA																	
ENGINE																	
1.3	Petrol	40	10/94-04/02	135, 135I													
Engine	Information				A10	A20	A40	A50	A70	C10 - C30	C20	E01					
All engines										1.990.414	C30						
ENGINE																	
1.3	Petrol	43	10/94-03/98	135L													
Engine	Information				A10	A20	A40	A50	A70	C10 - C30	C20	E01					
All engines	version Pal						1.338.243	1.438.262R									
All engines												1.501.373					
ENGINE																	
1.3	Petrol	50	10/94-04/02	136 I, 136B													
Engine	Information				A10	A20	A40	A50	A70	C10 - C30	C20	E01					
All engines										1.990.414	C30						
ENGINE																	
1.3 LXI	Petrol	50	08/95-03/98	136 I													
Engine	Information				A10	A20	A40	A50	A70	C10 - C30	C20	E01					
All engines										1.990.414	C30						
ENGINE																	
1.6	Petrol	55	06/97-04/02	6A 16 XHT, AEE													
Engine	Information				A10	A20	A40	A50	A70	C10 - C30	C20	E01					
Eng. 6A 16 XHT	version Bosch						1.306.094	1.406.121R	1.906.223								
Eng. 6A 16 XHT	version Marelli						1.330.116	1.430.057R									
Eng. AEE										1.990.414	C30						
Eng. 6A 16 XHT												1.501.569					
ENGINE																	
1.6 GLX	Petrol	55	08/95-03/98	6A 16 XHT, AEE													
Engine	Information				A10	A20	A40	A50	A70	C10 - C30	C20	E01					
Eng. 6A 16 XHT	version Bosch						1.306.094	1.406.121R	1.906.223								
Eng. 6A 16 XHT	version Marelli						1.330.116	1.430.057R									
Eng. AEE										1.990.414	C30						
Eng. 6A 16 XHT												1.501.569					
ENGINE																	
1.6 LX	Petrol	55	08/95-03/98	6A 16 XHT, AEE													
Engine	Information				A10	A20	A40	A50	A70	C10 - C30	C20	E01					
Eng. 6A 16 XHT	version Bosch						1.306.094	1.406.121R	1.906.223								
Eng. 6A 16 XHT	version Marelli						1.330.116	1.430.057R									
Eng. AEE										1.990.414	C30						
Eng. 6A 16 XHT												1.501.569					
KAMIQ																	
ENGINE																	
1.0 TGI CNG	Petrol/ Com- pressed Natural Gas (CNG)	66	11/19->	DBYA													
Engine	Information				A10	A20	A40	A50	A70	C10 - C30	C20	E01					
All engines	x 3, BERU, ELDOR, COIL ON PLUG, incl. spark plug connector, Number of pins:4, incl. spark plug connector									1.970.599	C10						
A10	CONDENSER	A20	CONTACT SET	A40	DISTRIBUTOR CAP	A50	ROTOR	A70	PICK-UP	C10	COIL	C20	IGNITION MODULE	C30	ELECTRONIC IGNITION KIT	E01	IGNITION CABLE SET

Vehicle	alim.	kW	Date	Engine	FUNCTIONS ON THE VEHICLE									
					A10	A20	A40	A50	A70	C10 - C30	C20	E01		
ENGINE														
1.0 TSI	Petrol	70	07/19->	DKLA										
Engine	Information				A10	A20	A40	A50	A70	C10 - C30	C20	E01		
All engines	x 3, BERU, ELDOR, COIL ON PLUG, incl. spark plug connector, Number of pins:4, incl. spark plug connector									1.970.599	C10			
ENGINE														
1.0 TSI	Petrol	85	07/19->	DKJA, DKRF										
Engine	Information				A10	A20	A40	A50	A70	C10 - C30	C20	E01		
All engines	x 3, BERU, ELDOR, COIL ON PLUG, incl. spark plug connector, Number of pins:4, incl. spark plug connector									1.970.599	C10			
ENGINE														
1.6 SRE	Petrol	81	07/19->	CWVA										
Engine	Information				A10	A20	A40	A50	A70	C10 - C30	C20	E01		
All engines	x 4, BERU, ELDOR, COIL ON PLUG, incl. spark plug connector, Number of pins:4, incl. spark plug connector									1.970.599	C10			
KAROQ														
ENGINE														
1.0 TSI	Petrol	85	07/17->	CHZJ, DKRF										
Engine	Information				A10	A20	A40	A50	A70	C10 - C30	C20	E01		
All engines	x 3, BERU, ELDOR, COIL ON PLUG, incl. spark plug connector, Number of pins:4, incl. spark plug connector									1.970.599	C10			
ENGINE														
1.4 TSI	Petrol	110	07/17->	CZEA, DJKA										
Engine	Information				A10	A20	A40	A50	A70	C10 - C30	C20	E01		
All engines	x 4, BERU, ELDOR, COIL ON PLUG, incl. spark plug connector, Number of pins:4, incl. spark plug connector									1.970.599	C10			
ENGINE														
2.0 TSI 4x4	Petrol	140	04/19->	DKZA, DNNA										
Engine	Information				A10	A20	A40	A50	A70	C10 - C30	C20	E01		
All engines	x 4, ELDOR, HITACHI, COIL ON PLUG, Colour:Black, COIL ON PLUG, incl. spark plug connector, incl. spark plug connector									1.970.636	C10			
KODIAQ														
ENGINE														
1.4 TSI	Petrol	110	10/16->	CZDA, CZEA										
Engine	Information				A10	A20	A40	A50	A70	C10 - C30	C20	E01		
All engines	x 4, BERU, ELDOR, COIL ON PLUG, incl. spark plug connector, Number of pins:4, incl. spark plug connector									1.970.599	C10			
ENGINE														
1.4 TSI	Petrol	92	10/16->	CZCA										
Engine	Information				A10	A20	A40	A50	A70	C10 - C30	C20	E01		
All engines	x 4, BERU, ELDOR, COIL ON PLUG, incl. spark plug connector, Number of pins:4, incl. spark plug connector									1.970.599	C10			
ENGINE														
1.4 TSI 4x4	Petrol	110	10/16->	CZDA, CZEA										
Engine	Information				A10	A20	A40	A50	A70	C10 - C30	C20	E01		
All engines	x 4, BERU, ELDOR, COIL ON PLUG, incl. spark plug connector, Number of pins:4, incl. spark plug connector									1.970.599	C10			
ENGINE														
2.0 TSI 4x4	Petrol	132	10/16->	CZPA										
Engine	Information				A10	A20	A40	A50	A70	C10 - C30	C20	E01		
All engines	x 4, ELDOR, Colour:Black, COIL ON PLUG, incl. spark plug connector									1.970.636	C10			
ENGINE														
2.0 TSI 4x4	Petrol	140	02/19->	DKZA, DNNA										
Engine	Information				A10	A20	A40	A50	A70	C10 - C30	C20	E01		
All engines	x 4, ELDOR, Colour:Black, COIL ON PLUG, incl. spark plug connector									1.970.636	C10			
OCTAVIA I														
ENGINE														
1.4 16V	Petrol	55	08/00-12/10	AXP, BCA										
Engine	Information				A10	A20	A40	A50	A70	C10 - C30	C20	E01		
Eng. BCA	x 4, COIL ON PLUG, incl. spark plug connector									1.970.474	C10			
Eng. AXP										1.990.420	C30			
All engines												1.501.575		
ENGINE														
1.6	Petrol	55	09/96-09/04	6A 16 XHT, AEE										
Engine	Information				A10	A20	A40	A50	A70	C10 - C30	C20	E01		
Eng. 6A 16 XHT	version Bosch						1.306.094	1.406.121R	1.906.223					
A10	CONDENSER		A20	CONTACT SET		A40	DISTRIBUTOR CAP		A50	ROTOR		A70	PICK-UP	
C10	COIL		C20	IGNITION MODULE		C30	ELECTRONIC IGNITION KIT		E01	IGNITION CABLE SET				

				FUNCTIONS ON THE VEHICLE								
Vehicle	alim.	kW	Date	Engine	A10	A20	A40	A50	A70	C10 - C30	C20	E01
				ENGINE								
1.6	Petrol	55	09/96-09/04	6A 16 XHT, AEE								
Engine	Information			A10	A20	A40	A50	A70	C10 - C30	C20	E01	
Eng. 6A 16 XHT	version Marelli					1.330.116	1.430.057R					
Eng. AEE									1.990.414	C30		
Eng. 6A 16 XHT												1.501.609
				ENGINE								
1.6	Petrol	74	02/97-12/07	AEH, AKL								
Engine	Information			A10	A20	A40	A50	A70	C10 - C30	C20	E01	
All engines									1.990.420	C30		
All engines	ch. 1U-V-005 001 ->, ->ch. 1U-W-060 000											1.501.479
All engines	ch. 1U-W-060 001 ->											1.501.484
				ENGINE								
1.6	Petrol	75	09/00-12/10	AVU, BFQ								
Engine	Information			A10	A20	A40	A50	A70	C10 - C30	C20	E01	
All engines									1.990.420	C30		1.501.585
				ENGINE								
1.8	Petrol	92	09/96-07/00	AGN								
Engine	Information			A10	A20	A40	A50	A70	C10 - C30	C20	E01	
All engines									1.990.420	C30		
All engines	ch. 1U-V-026 001 ->											1.501.489
				ENGINE								
1.8 20V	Petrol	92	07/98-07/00	AGN								
Engine	Information			A10	A20	A40	A50	A70	C10 - C30	C20	E01	
All engines									1.990.420	C30		
All engines	ch. 1U-V-026 001 ->											1.501.489
				ENGINE								
1.8 T	Petrol	110	08/97-12/10	AGU, ARX, ARZ, AUM								
Engine	Information			A10	A20	A40	A50	A70	C10 - C30	C20	E01	
Eng. AGU	x 4, COIL ON PLUG								1.970.354S	C10		
Eng. ARZ	x 4, COIL ON PLUG, incl. spark plug connector								1.970.429	C10		
Eng. ARX, AUM	x 4, COIL ON PLUG, incl. spark plug connector								1.970.445	C10		
Eng. AGU, ARX, AUM											1.965.076	
				ENGINE								
1.8 T 4x4	Petrol	110	05/01-05/06	ARX								
Engine	Information			A10	A20	A40	A50	A70	C10 - C30	C20	E01	
All engines	x 4, COIL ON PLUG, incl. spark plug connector								1.970.429	C10		
All engines											1.965.076	
				ENGINE								
2.0	Petrol	85	04/99-05/07	AEG, APK, AQY, AZH, AZJ								
Engine	Information			A10	A20	A40	A50	A70	C10 - C30	C20	E01	
Eng. AEG, APK, AQY									1.990.420	C30		
Eng. AZJ												1.499.223
Eng. AEG, APK, AQY, AZH												1.501.585
				ENGINE								
2.0 4x4	Petrol	85	08/00-09/04	AZH, AZJ								
Engine	Information			A10	A20	A40	A50	A70	C10 - C30	C20	E01	
Eng. AZH									1.990.420	C30		1.501.585
Eng. AZJ												1.499.223
				ENGINE								
RS 1.8 T	Petrol	132	05/01-01/06	AUQ								
Engine	Information			A10	A20	A40	A50	A70	C10 - C30	C20	E01	
All engines	x 4, COIL ON PLUG, incl. spark plug connector								1.970.429	C10		
All engines											1.965.076	
				ENGINE								
				ENGINE								
1.2 TSI	Petrol	77	02/10-06/13	CBZB								
Engine	Information			A10	A20	A40	A50	A70	C10 - C30	C20	E01	
All engines									1.990.420	C30		1.499.248

A10 CONDENSER	A20 CONTACT SET	A40 DISTRIBUTOR CAP	A50 ROTOR	A70 PICK-UP
C10 COIL	C20 IGNITION MODULE	C30 ELECTRONIC IGNITION KIT	E01 IGNITION CABLE SET	

Vehicle	alim.	kW	Date	Engine	FUNCTIONS ON THE VEHICLE									
					A10	A20	A40	A50	A70	C10 - C30	C20	E01		
ENGINE														
1.4	Petrol	55	05/04-05/06	BCA										
ENGINE														
All engines					x 4, COIL ON PLUG, incl. spark plug connector						1.970.474	C10		
1.4	Petrol	59	06/04-06/13	BUD, CGGA										
ENGINE														
All engines					x 4, COIL ON PLUG, incl. spark plug connector						1.970.474	C10		
1.4 [CHN]	Petrol	96	03/10->	CFBA.										
ENGINE														
All engines					Qty: 4						1.970.474	C10		
1.4 TSI	Petrol	90	11/08-06/13	CAXA										
ENGINE														
All engines					x 4, COIL ON PLUG, incl. spark plug connector						1.970.474	C10		
1.6	Petrol	75	06/04-06/13	BGU, BSE, BSF, CCSA, CMXA										
ENGINE														
All engines											1.990.420	C30		1.501.585
1.6 [CHN]	Petrol	77	09/07->	CDFA, CLRA, CPJA										
ENGINE														
All engines					Qty: 4						1.970.474	C10		
1.6 FSI	Petrol	85	02/04-10/08	BLF										
ENGINE														
All engines					x 4, COIL ON PLUG, incl. spark plug connector						1.970.474	C10		
1.6 LPG	Petrol/ Liquified Petro- leum Gas (LPG)	75	08/09-11/12	BSE, CHGA										
ENGINE														
All engines											1.990.420	C30		
Eng. CHGA														1.501.585
1.6 MultiFuel	Petrol/ Ethanol	75	01/08-06/13	CCSA, CMXA										
ENGINE														
Eng. CCSA											1.990.420	C30		
All engines														1.501.585
1.8 TSI	Petrol	112	03/09-06/13	CDAB										
ENGINE														
All engines					x 4, ELDOR, Housing Colour:Black, COIL ON PLUG, incl. spark plug connector						1.970.426	C10		
1.8 TSI	Petrol	118	06/07-04/13	BZB, CDAA										
ENGINE														
All engines					x 4, ELDOR, Housing Colour:Black, COIL ON PLUG, incl. spark plug connector						1.970.426	C10		
1.8 TSI 4x4	Petrol	112	03/09-02/13	CDAB										
ENGINE														
All engines					x 4, ELDOR, Housing Colour:Black, COIL ON PLUG, incl. spark plug connector						1.970.426	C10		
1.8 TSI 4x4	Petrol	118	11/08-02/13	CDAA										
ENGINE														
All engines					x 4, ELDOR, Housing Colour:Black, COIL ON PLUG, incl. spark plug connector						1.970.426	C10		









A10 CONDENSER	A20 CONTACT SET	A40 DISTRIBUTOR CAP	A50 ROTOR	A70 PICK-UP
C10 COIL	C20 IGNITION MODULE	C30 ELECTRONIC IGNITION KIT	E01 IGNITION CABLE SET	

The present application list is a brief version. For the detailed information about the possibility of installation on a specific vehicle, please refer to our web-catalogue <http://catalogo.facet.eu/>

Vehicle	alim.	kW	Date	Engine	FUNCTIONS ON THE VEHICLE									
					A10	A20	A40	A50	A70	C10 - C30	C20	E01		
ENGINE														
2.0 [CHN]	Petrol	85	04/07->	BXX.										
Engine		Information			A10	A20	A40	A50	A70	C10 - C30	C20	E01		
All engines										1.990.420	C30		1.501.585	
ENGINE														
2.0 [CHN]	Petrol	88	06/08->	CGZA.										
Engine		Information			A10	A20	A40	A50	A70	C10 - C30	C20	E01		
All engines										1.990.420	C30		1.501.585	
ENGINE														
2.0 4x4	Petrol	147	11/08->	CCZA										
Engine		Information			A10	A20	A40	A50	A70	C10 - C30	C20	E01		
All engines		Qty: 4								1.970.426	C10			
ENGINE														
2.0 FSI	Petrol	110	11/04-10/08	BLR, BLY, BVY, BVZ										
Engine		Information			A10	A20	A40	A50	A70	C10 - C30	C20	E01		
All engines		x 4, ELDOR, Housing Colour:Black, COIL ON PLUG, incl. spark plug connector								1.970.426	C10			
ENGINE														
2.0 FSI 4x4	Petrol	110	11/04-04/09	BLX, BLY, BVX										
Engine		Information			A10	A20	A40	A50	A70	C10 - C30	C20	E01		
All engines		x 4, ELDOR, Housing Colour:Black, COIL ON PLUG, incl. spark plug connector								1.970.426	C10			
ENGINE														
2.0 TFSI	Petrol	147	10/05-02/13	BWA, CCZA										
Engine		Information			A10	A20	A40	A50	A70	C10 - C30	C20	E01		
All engines		x 4, ELDOR, Housing Colour:Black, COIL ON PLUG, incl. spark plug connector								1.970.426	C10			
OCTAVIA III														
ENGINE														
1.0 TSI	Petrol	85	05/16->	CHZD, DKRA, DKRF										
Engine		Information			A10	A20	A40	A50	A70	C10 - C30	C20	E01		
All engines		x 3, BERU, ELDOR, COIL ON PLUG, incl. spark plug connector, Number of pins:4, incl. spark plug connector								1.970.599	C10			
ENGINE														
1.2 TSI	Petrol	63	11/12->	CJZB, CYVA										
Engine		Information			A10	A20	A40	A50	A70	C10 - C30	C20	E01		
All engines		x 4, BERU, ELDOR, COIL ON PLUG, incl. spark plug connector, Number of pins:4, incl. spark plug connector								1.970.599	C10			
Eng. CYVA		Qty: 4								1.970.599	C10			
ENGINE														
1.2 TSI	Petrol	77	11/12->	CJZA										
Engine		Information			A10	A20	A40	A50	A70	C10 - C30	C20	E01		
All engines		x 4, BERU, ELDOR, COIL ON PLUG, incl. spark plug connector, Number of pins:4, incl. spark plug connector								1.970.599	C10			
ENGINE														
1.2 TSI	Petrol	81	05/15-02/17	CYVB										
Engine		Information			A10	A20	A40	A50	A70	C10 - C30	C20	E01		
All engines		x 4, BERU, ELDOR, COIL ON PLUG, incl. spark plug connector, Number of pins:4, incl. spark plug connector								1.970.599	C10			
ENGINE														
1.4 TSI	Petrol	103	11/12->	CHPA										
Engine		Information			A10	A20	A40	A50	A70	C10 - C30	C20	E01		
All engines		x 4, BERU, ELDOR, COIL ON PLUG, incl. spark plug connector, Number of pins:4, incl. spark plug connector								1.970.599	C10			
ENGINE														
1.4 TSI	Petrol	110	08/14-10/20	CHPB, CZDA										
Engine		Information			A10	A20	A40	A50	A70	C10 - C30	C20	E01		
All engines		x 4, BERU, x 4, COIL ON PLUG, ELDOR, COIL ON PLUG, incl. spark plug connector, Number of pins:4, incl. spark plug connector								1.970.599	C10			

A10 CONDENSER	A20 CONTACT SET	A40 DISTRIBUTOR CAP	A50 ROTOR	A70 PICK-UP
C10 COIL	C20 IGNITION MODULE	C30 ELECTRONIC IGNITION KIT	E01 IGNITION CABLE SET	

Vehicle	alim.	kW	Date	Engine	FUNCTIONS ON THE VEHICLE							
					A10	A20	A40	A50	A70	C10 - C30	C20	E01
ENGINE												
1.4 TSI G-TEC	Petrol/ Compressed Natural Gas (CNG)	81	11/13->	CPWA								
Engine	Information			A10	A20	A40	A50	A70	C10 - C30	C20	E01	
All engines	x 4, BERU, ELDOR, COIL ON PLUG, incl. spark plug connector, Number of pins:4, incl. spark plug connector								1.970.599	C10		
ENGINE												
1.6	Petrol	81	01/14->	CWVA								
Engine	Information			A10	A20	A40	A50	A70	C10 - C30	C20	E01	
All engines	x 4, BERU, ELDOR, COIL ON PLUG, incl. spark plug connector, Number of pins:4, incl. spark plug connector								1.970.599	C10		
ENGINE												
1.8 TSI	Petrol	132	11/12->	CJSA, CJSB								
Engine	Information			A10	A20	A40	A50	A70	C10 - C30	C20	E01	
All engines	x 4, HITACHI, COIL ON PLUG, incl. spark plug connector								1.970.636	C10		
ENGINE												
1.8 TSI 4x4	Petrol	132	11/12->	CJSA, CJSB								
Engine	Information			A10	A20	A40	A50	A70	C10 - C30	C20	E01	
Eng. CJSA	Qty: 4, Qty: 4								1.970.636	C10		
Eng. CJSB	x 4, HITACHI, COIL ON PLUG, incl. spark plug connector								1.970.636	C10		
ENGINE												
2.0 TSI	Petrol	140	02/17->	DKZA								
Engine	Information			A10	A20	A40	A50	A70	C10 - C30	C20	E01	
All engines	x 4, ELDOR, Colour:Black, COIL ON PLUG, incl. spark plug connector								1.970.636	C10		
ENGINE												
2.0 TSI 4x4	Petrol	140	02/19->	DKZA								
Engine	Information			A10	A20	A40	A50	A70	C10 - C30	C20	E01	
All engines	x 4, ELDOR, Colour:Black, COIL ON PLUG, incl. spark plug connector								1.970.636	C10		
OCTAVIA IV												
ENGINE												
1.0 TSI	Petrol	81	06/20->	DLAA								
Engine	Information			A10	A20	A40	A50	A70	C10 - C30	C20	E01	
All engines	x 3, ELDOR, HITACHI, COIL ON PLUG, incl. spark plug connector, Number of pins:4, incl. spark plug connector								1.970.599	C10		
ENGINE												
1.0 TSI e-TEC	Petrol/ Electric	81	06/20->	DLAA								
Engine	Information			A10	A20	A40	A50	A70	C10 - C30	C20	E01	
All engines	x 3, ELDOR, HITACHI, COIL ON PLUG, incl. spark plug connector, Number of pins:4, incl. spark plug connector								1.970.599	C10		
RAPID												
ENGINE												
1.0 TSI	Petrol	70	06/17-12/19	CHZB, DKLD								
Engine	Information			A10	A20	A40	A50	A70	C10 - C30	C20	E01	
All engines	x 3, BERU, ELDOR, COIL ON PLUG, incl. spark plug connector, Number of pins:4, incl. spark plug connector								1.970.599	C10		
ENGINE												
1.0 TSI	Petrol	81	06/17-12/19	CHZC								
Engine	Information			A10	A20	A40	A50	A70	C10 - C30	C20	E01	
All engines	x 3, BERU, ELDOR, COIL ON PLUG, incl. spark plug connector, Number of pins:4, incl. spark plug connector								1.970.599	C10		
ENGINE												
1.2	Petrol	55	07/12-06/15	CGPC								
Engine	Information			A10	A20	A40	A50	A70	C10 - C30	C20	E01	
All engines	x 3, COIL ON PLUG, incl. spark plug connector								1.970.474	C10		
ENGINE												
1.2 LPG	Petrol/ Liquified Petroleum Gas (LPG)	55	07/12-06/15	CGPC								
Engine	Information			A10	A20	A40	A50	A70	C10 - C30	C20	E01	
All engines	x 3, COIL ON PLUG, incl. spark plug connector								1.970.474	C10		
FUNCTIONS ON THE VEHICLE												
A10	CONDENSER	A20	CONTACT SET	A40	DISTRIBUTOR CAP	A50	ROTOR	A70	PICK-UP			
C10	COIL	C20	IGNITION MODULE	C30	ELECTRONIC IGNITION KIT	E01	IGNITION CABLE SET					









					FUNCTIONS ON THE VEHICLE							
Vehicle	alim.	kW	Date	Engine								
ENGINE												
1.2 LPG	Petrol/ Liquified Petroleum Gas (LPG)	63	07/12-05/15	CBZA								
Engine	Information				A10	A20	A40	A50	A70	C10 - C30	C20	E01
All engines										1.990.420	C30	
ENGINE												
1.2 TSI	Petrol	63	07/12-05/15	CBZA								
Engine	Information				A10	A20	A40	A50	A70	C10 - C30	C20	E01
All engines										1.990.420	C30	
ENGINE												
1.2 TSI	Petrol	66	05/15-12/19	CJZC								
Engine	Information				A10	A20	A40	A50	A70	C10 - C30	C20	E01
All engines	x 4, BERU, ELDOR, COIL ON PLUG, incl. spark plug connector, Number of pins:4, incl. spark plug connector									1.970.599	C10	
ENGINE												
1.2 TSI	Petrol	77	07/12-05/15	CBZB								
Engine	Information				A10	A20	A40	A50	A70	C10 - C30	C20	E01
All engines										1.990.420	C30	
ENGINE												
1.2 TSI	Petrol	81	05/15-12/19	CJZD								
Engine	Information				A10	A20	A40	A50	A70	C10 - C30	C20	E01
All engines	x 4, BERU, ELDOR, COIL ON PLUG, incl. spark plug connector, Number of pins:4, incl. spark plug connector									1.970.599	C10	
ENGINE												
1.4 TSI	Petrol	90	07/12-06/15	CAXA								
Engine	Information				A10	A20	A40	A50	A70	C10 - C30	C20	E01
All engines	x 4, COIL ON PLUG, incl. spark plug connector									1.970.474	C10	
ENGINE												
1.4 TSI	Petrol	92	05/15->	CZCA								
Engine	Information				A10	A20	A40	A50	A70	C10 - C30	C20	E01
All engines	x 4, BERU, ELDOR, COIL ON PLUG, incl. spark plug connector, Number of pins:4, incl. spark plug connector									1.970.599	C10	
ENGINE												
1.6	Petrol	77	07/12-06/15	CFNA								
Engine	Information				A10	A20	A40	A50	A70	C10 - C30	C20	E01
All engines	x 4, COIL ON PLUG, incl. spark plug connector									1.970.474	C10	
ENGINE												
1.6	Petrol	81	05/15->	CWVA								
Engine	Information				A10	A20	A40	A50	A70	C10 - C30	C20	E01
All engines	x 4, BERU, ELDOR, COIL ON PLUG, incl. spark plug connector, Number of pins:4, incl. spark plug connector									1.970.599	C10	
ENGINE												
1.6 SRE	Petrol	66	06/15->	CWVB								
Engine	Information				A10	A20	A40	A50	A70	C10 - C30	C20	E01
All engines	x 4, BERU, ELDOR, COIL ON PLUG, incl. spark plug connector, Number of pins:4, incl. spark plug connector									1.970.599	C10	
ENGINE												
1.6 SRE	Petrol	81	05/15-12/19	CWVA								
Engine	Information				A10	A20	A40	A50	A70	C10 - C30	C20	E01
All engines	x 4, BERU, ELDOR, COIL ON PLUG, incl. spark plug connector, Number of pins:4, incl. spark plug connector									1.970.599	C10	
ROOMSTER												
ENGINE												
1.2	Petrol	47	05/06-01/07	BME								
Engine	Information				A10	A20	A40	A50	A70	C10 - C30	C20	E01
All engines	x 3, COIL ON PLUG, incl. spark plug connector									1.970.474	C10	
ENGINE												
1.2	Petrol	51	01/07-05/15	BZG, CGPA								
Engine	Information				A10	A20	A40	A50	A70	C10 - C30	C20	E01
All engines	x 3, COIL ON PLUG, incl. spark plug connector									1.970.474	C10	

A10 CONDENSER	A20 CONTACT SET	A40 DISTRIBUTOR CAP	A50 ROTOR	A70 PICK-UP
C10 COIL	C20 IGNITION MODULE	C30 ELECTRONIC IGNITION KIT	E01 IGNITION CABLE SET	

Vehicle	alim.	kW	Date	Engine	FUNCTIONS ON THE VEHICLE									
					A10	A20	A40	A50	A70	C10 - C30	C20	E01		
ENGINE														
1.2 LPG	Petrol/ Liquified Petroleum Gas (LPG)	51	03/09-05/15	CGPA										
Engine					Information	A10	A20	A40	A50	A70	C10 - C30	C20	E01	
All engines					x 3, COIL ON PLUG, incl. spark plug connector						1.970.474	C10		
ENGINE														
1.2 TSI	Petrol	63	03/10-05/15	CBZA										
Engine					Information	A10	A20	A40	A50	A70	C10 - C30	C20	E01	
All engines											1.990.420	C30		
ENGINE														
1.2 TSI	Petrol	77	03/10-05/15	CBZB										
Engine					Information	A10	A20	A40	A50	A70	C10 - C30	C20	E01	
All engines											1.990.420	C30		
ENGINE														
1.4	Petrol	63	09/06-05/15	BXW, CGGB										
Engine					Information	A10	A20	A40	A50	A70	C10 - C30	C20	E01	
All engines					x 4, COIL ON PLUG, incl. spark plug connector						1.970.474	C10		
ENGINE														
1.4 LPG	Petrol/ Liquified Petroleum Gas (LPG)	63	03/10-05/15	BXW, CGGB										
Engine					Information	A10	A20	A40	A50	A70	C10 - C30	C20	E01	
All engines					x 4, COIL ON PLUG, incl. spark plug connector						1.970.474	C10		
ENGINE														
1.6	Petrol	77	09/06-05/15	BTS, CFNA										
Engine					Information	A10	A20	A40	A50	A70	C10 - C30	C20	E01	
All engines					x 4, COIL ON PLUG, incl. spark plug connector						1.970.474	C10		
ENGINE														
1.6 LPG	Petrol/ Liquified Petroleum Gas (LPG)	77	06/06-07/10	BTS										
Engine					Information	A10	A20	A40	A50	A70	C10 - C30	C20	E01	
All engines					x 4, COIL ON PLUG, incl. spark plug connector						1.970.474	C10		
SCALA														
ENGINE														
1.0 TGI CNG	Petrol/ Com- pressed Natural Gas (CNG)	66	11/19->	DBYA										
Engine					Information	A10	A20	A40	A50	A70	C10 - C30	C20	E01	
All engines					x 3, BERU, ELDOR, COIL ON PLUG, incl. spark plug connector, Number of pins:4, incl. spark plug connector						1.970.599	C10		
ENGINE														
1.0 TSI	Petrol	70	02/19->	DKLA, DLAC										
Engine					Information	A10	A20	A40	A50	A70	C10 - C30	C20	E01	
All engines					x 3, BERU, ELDOR, COIL ON PLUG, incl. spark plug connector, Number of pins:4, incl. spark plug connector						1.970.599	C10		
ENGINE														
1.0 TSI	Petrol	81	08/20->	DLAA										
Engine					Information	A10	A20	A40	A50	A70	C10 - C30	C20	E01	
All engines					x 3, HITACHI, COIL ON PLUG, incl. spark plug connector						1.970.599	C10		
ENGINE														
1.0 TSI	Petrol	85	02/19->	DKJA, DKRF										
Engine					Information	A10	A20	A40	A50	A70	C10 - C30	C20	E01	
All engines					x 3, BERU, ELDOR, COIL ON PLUG, incl. spark plug connector, Number of pins:4, incl. spark plug connector						1.970.599	C10		

A10	CONDENSER	A20	CONTACT SET	A40	DISTRIBUTOR CAP	A50	ROTOR	A70	PICK-UP
C10	COIL	C20	IGNITION MODULE	C30	ELECTRONIC IGNITION KIT	E01	IGNITION CABLE SET		

The present application list is a brief version. For the detailed information about the possibility of installation on a specific vehicle, please refer to our web-catalogue <http://catalogo.facet.eu/>

					FUNCTIONS ON THE VEHICLE							
Vehicle	alim.	kW	Date	Engine	 A10	 A20	 A40	 A50	 A70	 C10 - C30	 C20	 E01
SUPERB I												
1.6 SRE	Petrol	81	02/19->	ENGINE CWVA								
Engine	Information											
All engines	x 4, BERU, x 4, COIL ON PLUG, ELDOR, COIL ON PLUG, incl. spark plug connector, incl. spark plug connector, Number of pins:4, incl. spark plug connector									1.970.599	C10	
SUPERB II												
1.8 T	Petrol	110	12/01-03/08	ENGINE AWT								
Engine	Information											
All engines	x 4, COIL ON PLUG, incl. spark plug connector									1.970.429	C10	
2.0	Petrol	85	12/01-03/08	ENGINE AZM								
Engine	Information											
All engines										1.990.420	C30	1.501.585
SUPERB III												
1.4 [CHN]	Petrol	96	03/10->	ENGINE CFBA.								
Engine	Information											
All engines	Qty: 4									1.970.474	C10	
1.4 TSI	Petrol	92	07/08-05/15	ENGINE CAXC								
Engine	Information											
All engines	x 4, COIL ON PLUG, incl. spark plug connector									1.970.474	C10	
1.8 TSI	Petrol	112	03/09-05/15	ENGINE CDAB								
Engine	Information											
All engines	x 4, ELDOR, Housing Colour:Black, COIL ON PLUG, incl. spark plug connector									1.970.426	C10	
1.8 TSI	Petrol	118	03/08-05/15	ENGINE BZB, CDA								
Engine	Information											
All engines	x 4, ELDOR, Housing Colour:Black, COIL ON PLUG, incl. spark plug connector									1.970.426	C10	
1.8 TSI 4x4	Petrol	112	03/09-05/15	ENGINE CDAB								
Engine	Information											
All engines	x 4, ELDOR, Housing Colour:Black, COIL ON PLUG, incl. spark plug connector									1.970.426	C10	
1.8 TSI 4x4	Petrol	118	11/08-05/15	ENGINE CDA								
Engine	Information											
All engines	x 4, ELDOR, Housing Colour:Black, COIL ON PLUG, incl. spark plug connector									1.970.426	C10	
2.0 TFSI	Petrol	147	05/10-05/15	ENGINE CCZA								
Engine	Information											
All engines	x 4, ELDOR, Housing Colour:Black, COIL ON PLUG, incl. spark plug connector									1.970.426	C10	
SUPERB III												
1.4 TSI	Petrol	110	03/15->	ENGINE CZDA, CZEA								
Engine	Information											
All engines	x 4, BERU, x 4, COIL ON PLUG, ELDOR, COIL ON PLUG, incl. spark plug connector, incl. spark plug connector, Number of pins:4, incl. spark plug connector									1.970.599	C10	
1.4 TSI	Petrol	92	03/15->	ENGINE CZCA								
Engine	Information											
All engines	x 4, BERU, ELDOR, COIL ON PLUG, incl. spark plug connector, Number of pins:4, incl. spark plug connector									1.970.599	C10	
1.4 TSI 4x4	Petrol	110	03/15->	ENGINE CZDA, CZEA								
Engine	Information											
Eng. CZDA	Qty: 4, version BERU, version ELDOR, Qty: 4									1.970.599	C10	
Eng. CZEA	x 4, BERU, x 4, COIL ON PLUG, ELDOR, COIL ON PLUG, incl. spark plug connector, incl. spark plug connector, Number of pins:4, incl. spark plug connector									1.970.599	C10	

A10 CONDENSER	A20 CONTACT SET	A40 DISTRIBUTOR CAP	A50 ROTOR	A70 PICK-UP
C10 COIL	C20 IGNITION MODULE	C30 ELECTRONIC IGNITION KIT	E01 IGNITION CABLE SET	

Vehicle	alim.	kW	Date	Engine	FUNCTIONS ON THE VEHICLE									
					A10	A20	A40	A50	A70	C10 - C30	C20	E01		
ENGINE														
1.4 TSI iV	Petrol/ Electric	115	08/19->	DGEB										
Engine	Information				A10	A20	A40	A50	A70	C10 - C30	C20	E01		
All engines	x 4, BERU, COIL ON PLUG, incl. spark plug connector									1,970.599	C10			
ENGINE														
1.4 TSI iV	Petrol/ Electric	160	08/19->	DGEB										
Engine	Information				A10	A20	A40	A50	A70	C10 - C30	C20	E01		
All engines	x 4, BERU, COIL ON PLUG, incl. spark plug connector									1,970.599	C10			
ENGINE														
1.8 TSI	Petrol	132	03/15->	CJSA, CJSC										
Engine	Information				A10	A20	A40	A50	A70	C10 - C30	C20	E01		
All engines	x 4, HITACHI, COIL ON PLUG, incl. spark plug connector									1,970.636	C10			
YETI														
ENGINE														
1.2 TSI	Petrol	77	09/09-05/15	CBZB										
Engine	Information				A10	A20	A40	A50	A70	C10 - C30	C20	E01		
All engines	x 4, ELDOR, Housing Colour:Black, COIL ON PLUG, incl. spark plug connector									1,970.426	C10			
All engines										1,990.420	C30		1,499.248	
ENGINE														
1.2 TSI	Petrol	81	05/15-12/17	CVVB										
Engine	Information				A10	A20	A40	A50	A70	C10 - C30	C20	E01		
All engines	x 4, BERU, ELDOR, COIL ON PLUG, incl. spark plug connector, Number of pins:4, incl. spark plug connector									1,970.599	C10			
ENGINE														
1.4 TSI	Petrol	90	06/10-05/15	CAXA										
Engine	Information				A10	A20	A40	A50	A70	C10 - C30	C20	E01		
All engines	x 4, COIL ON PLUG, incl. spark plug connector									1,970.474	C10			
ENGINE														
1.4 TSI	Petrol	92	05/15-12/17	CZCA										
Engine	Information				A10	A20	A40	A50	A70	C10 - C30	C20	E01		
All engines	x 4, ELDOR, COIL ON PLUG, Number of pins:4, incl. spark plug connector									1,970.599	C10			
ENGINE														
1.4 TSI 4x4	Petrol	110	05/15-12/17	CZDA										
Engine	Information				A10	A20	A40	A50	A70	C10 - C30	C20	E01		
All engines	x 4, ELDOR, COIL ON PLUG, Number of pins:4, incl. spark plug connector									1,970.599	C10			
ENGINE														
1.6	Petrol	81	04/14-12/17	CWVA										
Engine	Information				A10	A20	A40	A50	A70	C10 - C30	C20	E01		
All engines	x 4, BERU, ELDOR, COIL ON PLUG, incl. spark plug connector, Number of pins:4, incl. spark plug connector									1,970.599	C10			
ENGINE														
1.8	Petrol	112	02/11->	CDAB										
Engine	Information				A10	A20	A40	A50	A70	C10 - C30	C20	E01		
All engines	Qty: 4									1,970.426	C10			
ENGINE														
1.8 TSI 4x4	Petrol	112	11/09-12/17	CDAB										
Engine	Information				A10	A20	A40	A50	A70	C10 - C30	C20	E01		
All engines	x 4, ELDOR, Housing Colour:Black, COIL ON PLUG, incl. spark plug connector									1,970.426	C10			
ENGINE														
1.8 TSI 4x4	Petrol	118	05/09-12/17	CDAA										
Engine	Information				A10	A20	A40	A50	A70	C10 - C30	C20	E01		
All engines	x 4, ELDOR, Housing Colour:Black, COIL ON PLUG, incl. spark plug connector									1,970.426	C10			

A10	CONDENSER	A20	CONTACT SET	A40	DISTRIBUTOR CAP	A50	ROTOR	A70	PICK-UP
C10	COIL	C20	IGNITION MODULE	C30	ELECTRONIC IGNITION KIT	E01	IGNITION CABLE SET		

The present application list is a brief version. For the detailed information about the possibility of installation on a specific vehicle, please refer to our web-catalogue <http://catalogo.facet.eu/>

Vehicle	alim.	kW	Date	Engine	FUNCTIONS ON THE VEHICLE							
					A10	A20	A40	A50	A70	C10 - C30	C20	E01

CABRIO

				ENGINE
0.6	Petrol	40	03/00-01/04	M 160 E6AL B03, M 160.910, M 160.920

Engine	Information	A10	A20	A40	A50	A70	C10 - C30	C20	E01
Eng. M 160 E6AL B03, M 160.920	Qty: 3						1.970.414	C10	
Eng. M 160.910	x 3, D.I.S.						1.970.414	C10	
Eng. M 160 E6AL B03, M 160.920									1.501.643

				ENGINE
0.6	Petrol	45	01/01-01/04	M 160 E6AL B05, M 160.910, M 160.920

Engine	Information	A10	A20	A40	A50	A70	C10 - C30	C20	E01
Eng. M 160 E6AL B05, M 160.920	Qty: 3						1.970.414	C10	
Eng. M 160.910	x 3, D.I.S.						1.970.414	C10	
All engines									1.501.643

				ENGINE
0.6	Petrol	46	01/01-01/03	M 160.910

Engine	Information	A10	A20	A40	A50	A70	C10 - C30	C20	E01
All engines	x 3, D.I.S.						1.970.414	C10	

				ENGINE
0.6	Petrol	52	06/02-01/04	M 160.910, M 160.920

Engine	Information	A10	A20	A40	A50	A70	C10 - C30	C20	E01
Eng. M 160.910	x 3, D.I.S.						1.970.414	C10	
Eng. M 160.920	Qty: 3						1.970.414	C10	
Eng. M 160.920									1.501.643

				ENGINE
0.7	Petrol	45	01/03-01/04	M 160.910, M 160.920

Engine	Information	A10	A20	A40	A50	A70	C10 - C30	C20	E01
Eng. M 160.910	Qty: 3						1.970.414	C10	
Eng. M 160.920	x 3, D.I.S.						1.970.414	C10	
Eng. M 160.910									1.501.643

				ENGINE
0.7	Petrol	55	01/03-01/04	M 160.910, M 160.920

Engine	Information	A10	A20	A40	A50	A70	C10 - C30	C20	E01
Eng. M 160.910	Qty: 3						1.970.414	C10	
Eng. M 160.920	x 3, D.I.S.						1.970.414	C10	
Eng. M 160.910									1.501.643

CITY COUPÉ

				ENGINE
0.6	Petrol	34	12/99-04/03	M 160.910

Engine	Information	A10	A20	A40	A50	A70	C10 - C30	C20	E01
All engines	x 3, D.I.S.						1.970.414	C10	

CITY-COUPÉ

				ENGINE
0.6	Petrol	33	07/98-01/04	M 160 E6AL B04, M 160.910, M 160.920

Engine	Information	A10	A20	A40	A50	A70	C10 - C30	C20	E01
Eng. M 160 E6AL B04, M 160.920	Qty: 3						1.970.414	C10	
Eng. M 160.910	x 3, D.I.S.						1.970.414	C10	
Eng. M 160 E6AL B04, M 160.920									1.501.643

				ENGINE
0.6	Petrol	40	07/98-01/04	M 160 E6AL B03, M 160.910, M 160.920

Engine	Information	A10	A20	A40	A50	A70	C10 - C30	C20	E01
Eng. M 160 E6AL B03, M 160.920	Qty: 3						1.970.414	C10	
Eng. M 160.910	x 3, D.I.S.						1.970.414	C10	
Eng. M 160 E6AL B03, M 160.920									1.501.643

A10 CONDENSER	A20 CONTACT SET	A40 DISTRIBUTOR CAP	A50 ROTOR	A70 PICK-UP
C10 COIL	C20 IGNITION MODULE	C30 ELECTRONIC IGNITION KIT	E01 IGNITION CABLE SET	

Vehicle	alim.	kW	Date	Engine	FUNCTIONS ON THE VEHICLE								
					A10	A20	A40	A50	A70	C10 - C30	C20	E01	
0.6	Petrol	45	01/01-01/04	ENGINE M 160 E6AL B05, M 160.910, M 160.920									
				Engine	Information	A10	A20	A40	A50	A70	C10 - C30	C20	E01
				Eng. M 160 E6AL B05, M 160.920	Qty: 3						1.970.414	C10	
				Eng. M 160.910	x 3, D.I.S.						1.970.414	C10	
				Eng. M 160 E6AL B05, M 160.920									1.501.643
0.6	Petrol	52	06/02-01/04	ENGINE M 160.910, M 160.920									
				Engine	Information	A10	A20	A40	A50	A70	C10 - C30	C20	E01
				Eng. M 160.910	x 3, D.I.S.						1.970.414	C10	
				Eng. M 160.920	Qty: 3						1.970.414	C10	
				Eng. M 160.920									1.501.643
0.7	Petrol	33	07/98-01/04	ENGINE M 160.910									
				Engine	Information	A10	A20	A40	A50	A70	C10 - C30	C20	E01
				All engines	Qty: 3						1.970.414	C10	
				All engines									1.501.643
0.7	Petrol	37	01/03-01/04	ENGINE M 160.910, M 160.920									
				Engine	Information	A10	A20	A40	A50	A70	C10 - C30	C20	E01
				Eng. M 160.910	Qty: 3						1.970.414	C10	
				Eng. M 160.920	x 3, D.I.S.						1.970.414	C10	
				Eng. M 160.910									1.501.643
0.7	Petrol	45	01/03-01/04	ENGINE M 160.910, M 160.920									
				Engine	Information	A10	A20	A40	A50	A70	C10 - C30	C20	E01
				Eng. M 160.910	Qty: 3						1.970.414	C10	
				Eng. M 160.920	x 3, D.I.S.						1.970.414	C10	
				Eng. M 160.910									1.501.643
0.7	Petrol	55	01/03-01/04	ENGINE M 160.910, M 160.920									
				Engine	Information	A10	A20	A40	A50	A70	C10 - C30	C20	E01
				Eng. M 160.910	Qty: 3						1.970.414	C10	
				Eng. M 160.920	x 3, D.I.S.						1.970.414	C10	
				Eng. M 160.910									1.501.643
CROSSBLADE													
0.6	Petrol	52	06/02-12/03	ENGINE M 160.910, M 160.920									
				Engine	Information	A10	A20	A40	A50	A70	C10 - C30	C20	E01
				Eng. M 160.910	x 3, D.I.S.						1.970.414	C10	
				Eng. M 160.920	Qty: 3						1.970.414	C10	
				Eng. M 160.920									1.501.643
FORFOUR III													
0.9	Petrol	66	11/14->	ENGINE M 281.910									
				Engine	Information	A10	A20	A40	A50	A70	C10 - C30	C20	E01
				All engines	x 3, COIL ON PLUG						1.970.613	C10	
0.9 Brabus	Petrol	80	07/16->	ENGINE M 281.910									
				Engine	Information	A10	A20	A40	A50	A70	C10 - C30	C20	E01
				All engines	x 3, COIL ON PLUG						1.970.613	C10	
1.0	Petrol	45	11/14->	ENGINE M 281.920									
				Engine	Information	A10	A20	A40	A50	A70	C10 - C30	C20	E01
				All engines	x 3, COIL ON PLUG						1.970.613	C10	
1.0	Petrol	52	07/14->	ENGINE M 281.920									
				Engine	Information	A10	A20	A40	A50	A70	C10 - C30	C20	E01
				All engines	x 3, COIL ON PLUG						1.970.613	C10	

A10	CONDENSER	A20	CONTACT SET	A40	DISTRIBUTOR CAP	A50	ROTOR	A70	PICK-UP
C10	COIL	C20	IGNITION MODULE	C30	ELECTRONIC IGNITION KIT	E01	IGNITION CABLE SET		

The present application list is a brief version. For the detailed information about the possibility of installation on a specific vehicle, please refer to our web-catalogue <http://catalogo.facet.eu/>

Vehicle	alim.	kW	Date	Engine	FUNCTIONS ON THE VEHICLE							
					A10	A20	A40	A50	A70	C10 - C30	C20	E01

FORTWO I

0.6	Petrol	45	01/04-02/07	ENGINE M 160.910
------------	--------	-----------	-------------	-----------------------------------

Engine	Information	A10	A20	A40	A50	A70	C10 - C30	C20	E01
All engines	x 3, D.I.S.						1.970.414	C10	

0.7	Petrol	37	01/04-01/07	ENGINE M 160.910, M 160.920
------------	--------	-----------	-------------	--

Engine	Information	A10	A20	A40	A50	A70	C10 - C30	C20	E01
Eng. M 160.910	Qty: 3						1.970.414	C10	
Eng. M 160.920	x 3, D.I.S.						1.970.414	C10	
Eng. M 160.910									1.501.643

0.7	Petrol	40	01/04-01/07	ENGINE M 160.920
------------	--------	-----------	-------------	-----------------------------------

Engine	Information	A10	A20	A40	A50	A70	C10 - C30	C20	E01
All engines	x 3, D.I.S.						1.970.414	C10	

0.7	Petrol	45	01/04-01/07	ENGINE M 160.910, M 160.920
------------	--------	-----------	-------------	--

Engine	Information	A10	A20	A40	A50	A70	C10 - C30	C20	E01
Eng. M 160.910	Qty: 3						1.970.414	C10	
Eng. M 160.920	x 3, D.I.S.						1.970.414	C10	
Eng. M 160.910									1.501.643

0.7	Petrol	55	01/04-01/07	ENGINE M 160.910, M 160.920
------------	--------	-----------	-------------	--

Engine	Information	A10	A20	A40	A50	A70	C10 - C30	C20	E01
Eng. M 160.910	Qty: 3						1.970.414	C10	
Eng. M 160.920	x 3, D.I.S.						1.970.414	C10	
Eng. M 160.910									1.501.643

FORTWO II

1.0	Petrol	45	01/07->	ENGINE M 132.910
------------	--------	-----------	---------	-----------------------------------

Engine	Information	A10	A20	A40	A50	A70	C10 - C30	C20	E01
All engines	x 3, COIL ON PLUG						1.970.503	C10	

1.0	Petrol	52	01/07->	ENGINE M 132.910
------------	--------	-----------	---------	-----------------------------------

Engine	Information	A10	A20	A40	A50	A70	C10 - C30	C20	E01
All engines	x 3, COIL ON PLUG						1.970.503	C10	

1.0 Brabus	Petrol	72	01/08->	ENGINE M 132.930
-------------------	--------	-----------	---------	-----------------------------------

Engine	Information	A10	A20	A40	A50	A70	C10 - C30	C20	E01
All engines	x 3, COIL ON PLUG						1.970.503	C10	

1.0 Brabus	Petrol	88	04/12->	ENGINE M 132.930
-------------------	--------	-----------	---------	-----------------------------------

Engine	Information	A10	A20	A40	A50	A70	C10 - C30	C20	E01
All engines	x 3, COIL ON PLUG						1.970.503	C10	

1.0 Turbo	Petrol	62	01/07->	ENGINE M 132.930
------------------	--------	-----------	---------	-----------------------------------

Engine	Information	A10	A20	A40	A50	A70	C10 - C30	C20	E01
All engines	x 3, COIL ON PLUG						1.970.503	C10	

1.0 Turbo Brabus	Petrol	75	07/10->	ENGINE M 132.930
-------------------------	--------	-----------	---------	-----------------------------------

Engine	Information	A10	A20	A40	A50	A70	C10 - C30	C20	E01
All engines	x 3, COIL ON PLUG						1.970.503	C10	

FORTWO III

0.9	Petrol	66	09/14->	ENGINE M 281.910
------------	--------	-----------	---------	-----------------------------------

Engine	Information	A10	A20	A40	A50	A70	C10 - C30	C20	E01
All engines	x 3, COIL ON PLUG						1.970.613	C10	

0.9 Brabus	Petrol	80	07/16->	ENGINE M 281.910
-------------------	--------	-----------	---------	-----------------------------------

Engine	Information	A10	A20	A40	A50	A70	C10 - C30	C20	E01
All engines	x 3, COIL ON PLUG						1.970.613	C10	

A10 CONDENSER	A20 CONTACT SET	A40 DISTRIBUTOR CAP	A50 ROTOR	A70 PICK-UP
C10 COIL	C20 IGNITION MODULE	C30 ELECTRONIC IGNITION KIT	E01 IGNITION CABLE SET	

Vehicle	alim.	kW	Date	Engine	FUNCTIONS ON THE VEHICLE								
					A10	A20	A40	A50	A70	C10 - C30	C20	E01	
ENGINE													
1.0	Petrol	45	11/14->	M 281.920									
Engine	Information				A10	A20	A40	A50	A70	C10 - C30	C20	E01	
All engines	x 3, COIL ON PLUG									1.970.613	C10		
ENGINE													
1.0	Petrol	52	07/14->	M 281.920									
Engine	Information				A10	A20	A40	A50	A70	C10 - C30	C20	E01	
All engines	x 3, COIL ON PLUG									1.970.613	C10		
ROADSTER													
ENGINE													
0.7	Petrol	45	04/03-11/05	M 160.921, M 160.922									
Engine	Information				A10	A20	A40	A50	A70	C10 - C30	C20	E01	
All engines	x 3, D.I.S.									1.970.414	C10		
All engines													1.501.643
ENGINE													
0.7	Petrol	60	04/03-11/05	M 160.921, M 160.922									
Engine	Information				A10	A20	A40	A50	A70	C10 - C30	C20	E01	
All engines	x 3, D.I.S.									1.970.414	C10		
All engines													1.501.643
ENGINE													
0.7 Brabus	Petrol	74	12/03-11/05	M 160.923									
Engine	Information				A10	A20	A40	A50	A70	C10 - C30	C20	E01	
All engines	x 3, D.I.S.									1.970.414	C10		
All engines													1.501.643

A10	CONDENSER	A20	CONTACT SET	A40	DISTRIBUTOR CAP	A50	ROTOR	A70	PICK-UP
C10	COIL	C20	IGNITION MODULE	C30	ELECTRONIC IGNITION KIT	E01	IGNITION CABLE SET		

The present application list is a brief version. For the detailed information about the possibility of installation on a specific vehicle, please refer to our web-catalogue <http://catalogo.facet.eu/>

Vehicle	alim.	kW	Date	Engine	FUNCTIONS ON THE VEHICLE							
					A10	A20	A40	A50	A70	C10 - C30	C20	E01

CHAIRMAN

3.2	Petrol	165	07/11->	ENGINE G32D
-----	--------	-----	---------	----------------

Engine	Information	A10	A20	A40	A50	A70	C10 - C30	C20	E01
All engines	x 3, SEMI-DIRECT						1.970.316	C10	

KORANDO

2.0	Petrol	94	05/97-10/02	ENGINE E20, E20M160, E20M161, M111E20
-----	--------	----	-------------	--

Engine	Information	A10	A20	A40	A50	A70	C10 - C30	C20	E01
Eng. E20, M111E20	Qty: 2						1.970.316	C10	
Eng. E20M160, E20M161	x 2, SEMI-DIRECT, x 2, SEMI-DIRECT						1.970.316	C10	

2.3	Petrol	103	05/97-02/00	ENGINE --, E23, M 111.970, M111E23
-----	--------	-----	-------------	---------------------------------------

Engine	Information	A10	A20	A40	A50	A70	C10 - C30	C20	E01
Eng. --, M 111.970, M111E23	Qty: 2						1.970.316	C10	
Eng. E23	x 2, SEMI-DIRECT						1.970.316	C10	

2.3	Petrol	105	01/99-11/06	ENGINE --, M111E23-143
-----	--------	-----	-------------	---------------------------

Engine	Information	A10	A20	A40	A50	A70	C10 - C30	C20	E01
All engines	Qty: 2						1.970.316	C10	

3.2	Petrol	154	12/96-11/02	ENGINE E32, M 104.995
-----	--------	-----	-------------	--------------------------

Engine	Information	A10	A20	A40	A50	A70	C10 - C30	C20	E01
Eng. E32	x 3, SEMI-DIRECT, x 3, SEMI-DIRECT						1.970.316	C10	
Eng. M 104.995	Qty: 3						1.970.316	C10	

3.2	Petrol	156	01/99-11/02	ENGINE E32, M 104.995
-----	--------	-----	-------------	--------------------------

Engine	Information	A10	A20	A40	A50	A70	C10 - C30	C20	E01
All engines	x 3, SEMI-DIRECT						1.970.316	C10	
Eng. M 104.995	Qty: 3						1.970.316	C10	

3.2	Petrol	162	06/97-11/06	ENGINE M 104.992
-----	--------	-----	-------------	---------------------

Engine	Information	A10	A20	A40	A50	A70	C10 - C30	C20	E01
All engines	Qty: 3						1.970.316	C10	

KYRON

3.2 M320 4x4	Petrol	162	03/08->	ENGINE G32D
--------------	--------	-----	---------	----------------

Engine	Information	A10	A20	A40	A50	A70	C10 - C30	C20	E01
All engines	x 3, SEMI-DIRECT						1.970.316	C10	

MUSSO

2.0	Petrol	93	10/96-05/05	ENGINE E20, M111E20
-----	--------	----	-------------	------------------------

Engine	Information	A10	A20	A40	A50	A70	C10 - C30	C20	E01
All engines	Qty: 2						1.970.316	C10	

3.2	Petrol	162	06/96-09/04	ENGINE M 104.992
-----	--------	-----	-------------	---------------------

Engine	Information	A10	A20	A40	A50	A70	C10 - C30	C20	E01
All engines	Qty: 3						1.970.316	C10	

REXTON I

3.2 RX320 4x4	Petrol	162	04/02->	ENGINE G32D
---------------	--------	-----	---------	----------------

Engine	Information	A10	A20	A40	A50	A70	C10 - C30	C20	E01
All engines	x 3, SEMI-DIRECT						1.970.316	C10	

RODIUS

3.2	Petrol	162	05/05->	ENGINE M162E32
-----	--------	-----	---------	-------------------

Engine	Information	A10	A20	A40	A50	A70	C10 - C30	C20	E01
All engines	x 3, SEMI-DIRECT, x 3, SEMI-DIRECT, x 3, SEMI-DIRECT, x 3, SEMI-DIRECT						1.970.316	C10	

A10 CONDENSER	A20 CONTACT SET	A40 DISTRIBUTOR CAP	A50 ROTOR	A70 PICK-UP
C10 COIL	C20 IGNITION MODULE	C30 ELECTRONIC IGNITION KIT	E01 IGNITION CABLE SET	

Vehicle	alim.	kW	Date	Engine	FUNCTIONS ON THE VEHICLE							
					 A10	 A20	 A40	 A50	 A70	 C10 - C30	 C20	 E01

ENGINE				
3.2 4WD	Petrol	162	07/07->	G32D, M162E32

Engine	Information	A10	A20	A40	A50	A70	C10 - C30	C20	E01
All engines	x 3, SEMI-DIRECT, x 3, SEMI-DIRECT, x 3, SEMI-DIRECT, x 3, SEMI-DIRECT						1.970.316	C10	

A10	CONDENSER	A20	CONTACT SET	A40	DISTRIBUTOR CAP	A50	ROTOR	A70	PICK-UP
C10	COIL	C20	IGNITION MODULE	C30	ELECTRONIC IGNITION KIT	E01	IGNITION CABLE SET		

The present application list is a brief version. For the detailed information about the possibility of installation on a specific vehicle, please refer to our web-catalogue <http://catalogo.facet.eu/>

Vehicle	alim.	kW	Date	Engine	FUNCTIONS ON THE VEHICLE							
					A10	A20	A40	A50	A70	C10 - C30	C20	E01

FORESTER I

2.0	Petrol	90	08/97-09/02	ENGINE EJ20J
-----	--------	----	-------------	-----------------

Engine	Information	A10	A20	A40	A50	A70	C10 - C30	C20	E01
All engines									1.501.835

2.0 AWD	Petrol	90	08/97-09/02	ENGINE EJ202
---------	--------	----	-------------	-----------------

Engine	Information	A10	A20	A40	A50	A70	C10 - C30	C20	E01
All engines	01/05/00 ->, version HUNTER								1.501.813
All engines	version NA SPORT								1.501.817

2.0 AWD	Petrol	92	06/98-09/02	ENGINE EJ202
---------	--------	----	-------------	-----------------

Engine	Information	A10	A20	A40	A50	A70	C10 - C30	C20	E01
All engines	01/05/00 ->, version HUNTER								1.501.813
All engines	version NA SPORT								1.501.817

2.0 S Turbo AWD	Petrol	125	06/98-04/01	ENGINE EJ20
-----------------	--------	-----	-------------	----------------

Engine	Information	A10	A20	A40	A50	A70	C10 - C30	C20	E01
All engines	->year 31/08/00								1.501.887

FORESTER II

2.0 AWD	Petrol	92	06/02-05/05	ENGINE EJ20, EJ201
---------	--------	----	-------------	-----------------------

Engine	Information	A10	A20	A40	A50	A70	C10 - C30	C20	E01
All engines	no specific info conc. application available								1.501.813

2.5	Petrol	123	02/02->	ENGINE EJ253
-----	--------	-----	---------	-----------------

Engine	Information	A10	A20	A40	A50	A70	C10 - C30	C20	E01
All engines									1.499.106

2.5	Petrol	130	02/02->	ENGINE EJ251
-----	--------	-----	---------	-----------------

Engine	Information	A10	A20	A40	A50	A70	C10 - C30	C20	E01
All engines									1.501.813

FORESTER III

2.5	Petrol	126	01/08->	ENGINE EJ253
-----	--------	-----	---------	-----------------

Engine	Information	A10	A20	A40	A50	A70	C10 - C30	C20	E01
All engines									1.499.106

IMPREZA I

1.6	Petrol	66	01/93-12/00	ENGINE EJ16E
-----	--------	----	-------------	-----------------

Engine	Information	A10	A20	A40	A50	A70	C10 - C30	C20	E01
All engines							1.970.265	C10	
All engines	01/12/93 ->								1.501.835

1.6	Petrol	70	09/98-09/00	ENGINE EJ161
-----	--------	----	-------------	-----------------

Engine	Information	A10	A20	A40	A50	A70	C10 - C30	C20	E01
All engines									1.501.819

1.6 i	Petrol	66	08/92-12/00	ENGINE 8F 140 GA
-------	--------	----	-------------	---------------------

Engine	Information	A10	A20	A40	A50	A70	C10 - C30	C20	E01
All engines							1.970.265	C10	
All engines	01/12/93 ->								1.501.835

1.6 i	Petrol	70	06/98-12/00	ENGINE EJ161
-------	--------	----	-------------	-----------------

Engine	Information	A10	A20	A40	A50	A70	C10 - C30	C20	E01
All engines									1.501.819

1.6 i AWD	Petrol	66	08/92-12/00	ENGINE 8F 140 GA
-----------	--------	----	-------------	---------------------









Engine	Information	A10	A20	A40	A50	A70	C10 - C30	C20	E01
All engines							1.970.265	C10	
All engines	01/12/93 ->								1.501.835

A10 CONDENSER	A20 CONTACT SET	A40 DISTRIBUTOR CAP	A50 ROTOR	A70 PICK-UP
C10 COIL	C20 IGNITION MODULE	C30 ELECTRONIC IGNITION KIT	E01 IGNITION CABLE SET	

Vehicle	alim.	kW	Date	Engine	FUNCTIONS ON THE VEHICLE									
					A10	A20	A40	A50	A70	C10 - C30	C20	E01		
1.6 i AWD	Petrol	70	06/98-12/00	ENGINE EJ161										
Engine	Information				A10	A20	A40	A50	A70	C10 - C30	C20	E01		
All engines													1.501.819	
1.8	Petrol	76	01/93-10/95	ENGINE EJ18										
Engine	Information				A10	A20	A40	A50	A70	C10 - C30	C20	E01		
All engines										1.970.265	C10			
All engines	01/12/93 ->												1.501.835	
1.8 i	Petrol	0	08/92-12/00	ENGINE EJ181										
Engine	Information				A10	A20	A40	A50	A70	C10 - C30	C20	E01		
All engines													1.501.813	
1.8 i	Petrol	76	11/95-06/96	ENGINE EJ18E										
Engine	Information				A10	A20	A40	A50	A70	C10 - C30	C20	E01		
All engines										1.970.265	C10		1.501.835	
1.8 i AWD	Petrol	76	08/92-12/00	ENGINE EJ18, EJ18E										
Engine	Information				A10	A20	A40	A50	A70	C10 - C30	C20	E01		
All engines										1.970.265	C10			
All engines	01/12/93 ->												1.501.835	
2.0	Petrol	85	09/96-08/98	ENGINE EJ20E										
Engine	Information				A10	A20	A40	A50	A70	C10 - C30	C20	E01		
All engines										1.970.266	C10			
2.0	Petrol	92	09/98-09/00	ENGINE EJ201										
Engine	Information				A10	A20	A40	A50	A70	C10 - C30	C20	E01		
All engines													1.501.813	
2.0 AWD	Petrol	85	12/95-12/00	ENGINE EJ20E										
Engine	Information				A10	A20	A40	A50	A70	C10 - C30	C20	E01		
All engines										1.970.266	C10			
2.0 i	Petrol	85	11/95-09/00	ENGINE EJ20E										
Engine	Information				A10	A20	A40	A50	A70	C10 - C30	C20	E01		
All engines										1.970.266	C10			
2.0 i	Petrol	92	09/98-09/00	ENGINE EJ201										
Engine	Information				A10	A20	A40	A50	A70	C10 - C30	C20	E01		
All engines													1.501.813	
2.0 i 16V AWD	Petrol	92	06/98-12/00	ENGINE EJ20, EJ20E										
Engine	Information				A10	A20	A40	A50	A70	C10 - C30	C20	E01		
All engines													1.501.813	
2.0 i AWD	Petrol	85	10/95-12/00	ENGINE EJ20, EJ20E										
Engine	Information				A10	A20	A40	A50	A70	C10 - C30	C20	E01		
All engines										1.970.266	C10			
2.0 i AWD	Petrol	92	06/98-12/00	ENGINE EJ201										
Engine	Information				A10	A20	A40	A50	A70	C10 - C30	C20	E01		
All engines													1.501.813	
2.0 i Turbo AWD	Petrol	155	03/94-12/00	ENGINE EJ20 (Turbo)										
Engine	Information				A10	A20	A40	A50	A70	C10 - C30	C20	E01		
All engines	01/04/96 ->									1.970.266	C10			

A10 CONDENSER	A20 CONTACT SET	A40 DISTRIBUTOR CAP	A50 ROTOR	A70 PICK-UP
C10 COIL	C20 IGNITION MODULE	C30 ELECTRONIC IGNITION KIT	E01 IGNITION CABLE SET	

The present application list is a brief version. For the detailed information about the possibility of installation on a specific vehicle, please refer to our web-catalogue <http://catalogo.facet.eu/>

				FUNCTIONS ON THE VEHICLE								
Vehicle	alim.	kW	Date	Engine								
				ENGINE								
2.0 Turbo AWD	Petrol	155	12/96-12/00	EJ20G								
Engine		Information			A10	A20	A40	A50	A70	C10 - C30	C20	E01
All engines										1.970.266	C10	
				ENGINE								
2.0 Turbo GT AWD	Petrol	155	03/94-12/00	EJ20 (Turbo)								
Engine		Information			A10	A20	A40	A50	A70	C10 - C30	C20	E01
All engines		01/04/96->								1.970.266	C10	
				ENGINE								
2.0 Turbo GT AWD	Petrol	160	06/98-12/00	EJ205								
Engine		Information			A10	A20	A40	A50	A70	C10 - C30	C20	E01
All engines												1.501.887
				ENGINE								
2.2 i	Petrol	0	11/93-08/98	EJ22E, EJ22EZ								
Engine		Information			A10	A20	A40	A50	A70	C10 - C30	C20	E01
Eng. EJ22E		->year 30/06/96								1.970.266	C10	
All engines		01/07/98->										1.501.813
				ENGINE								
2.5 i	Petrol	0	11/93-08/98	EJ253								
Engine		Information			A10	A20	A40	A50	A70	C10 - C30	C20	E01
All engines												1.501.813
				ENGINE								
1.6 AWD	Petrol	70	12/00-06/09	8F 140 GA, EJ161								
Engine		Information			A10	A20	A40	A50	A70	C10 - C30	C20	E01
All engines												1.501.819
				ENGINE								
2.0 AWD	Petrol	92	12/00-12/07	EJ20								
Engine		Information			A10	A20	A40	A50	A70	C10 - C30	C20	E01
All engines												1.501.813
				ENGINE								
2.0 i AWD	Petrol	92	12/00-06/09	EJ201								
Engine		Information			A10	A20	A40	A50	A70	C10 - C30	C20	E01
All engines												1.501.813
				ENGINE								
2.5 AWD	Petrol	112	12/02-09/05	EJ25								
Engine		Information			A10	A20	A40	A50	A70	C10 - C30	C20	E01
All engines												1.501.813
				ENGINE								
2.5 AWD	Petrol	130	03/01-09/05	EJ251								
Engine		Information			A10	A20	A40	A50	A70	C10 - C30	C20	E01
All engines												1.501.813
				ENGINE								
2.5 i AWD	Petrol	112	12/02-09/05	EJ251								
Engine		Information			A10	A20	A40	A50	A70	C10 - C30	C20	E01
All engines												1.501.813
				ENGINE								
1.0i EFC-SYS	Petrol	0	01/89->	--								
Engine		Information			A10	A20	A40	A50	A70	C10 - C30	C20	E01
All engines		version Hitachi					1.322.041	1.422.073				
				ENGINE								
1.2i EFC-SYS	Petrol	0	01/89->	--								
Engine		Information			A10	A20	A40	A50	A70	C10 - C30	C20	E01
All engines		version Hitachi					1.322.041	1.422.073				
				ENGINE								
1.2i EMPi [USA]	Petrol	0	01/91->	--								
Engine		Information			A10	A20	A40	A50	A70	C10 - C30	C20	E01
All engines		version Denso					1.313.259	1.413.029				

A10 CONDENSER	A20 CONTACT SET	A40 DISTRIBUTOR CAP	A50 ROTOR	A70 PICK-UP
C10 COIL	C20 IGNITION MODULE	C30 ELECTRONIC IGNITION KIT	E01 IGNITION CABLE SET	

Vehicle	alim.	kW	Date	Engine	FUNCTIONS ON THE VEHICLE									
					A10	A20	A40	A50	A70	C10 - C30	C20	E01		
JUSTY II														
1.3 4x4	Petrol	63	04/01-11/03	G13BB										
Engine	Information				A10	A20	A40	A50	A70	C10 - C30	C20	E01		
All engines	Qty: 2									1.970.570	C10			
1.3i	Petrol	50	05/96-09/00	G13BA										
Engine	Information				A10	A20	A40	A50	A70	C10 - C30	C20	E01		
All engines	version Denso						1.313.123	1.413.028						
JUSTY III														
1.3 AWD	Petrol	69	09/03->	M13A										
Engine	Information				A10	A20	A40	A50	A70	C10 - C30	C20	E01		
All engines	Qty: 2									1.970.570	C10			
1.5 AWD	Petrol	73	09/03->	M15A										
Engine	Information				A10	A20	A40	A50	A70	C10 - C30	C20	E01		
All engines	Qty: 2									1.970.570	C10			
LEGACY I														
1.6	Petrol	70	05/89-12/93	8F 140 GA										
Engine	Information				A10	A20	A40	A50	A70	C10 - C30	C20	E01		
All engines	version Mitsubishi						1.331.145	1.431.119						
1.8i SPI	Petrol	0	01/89->	--										
Engine	Information				A10	A20	A40	A50	A70	C10 - C30	C20	E01		
All engines	version Hitachi						1.322.075	1.422.093						
1800	Petrol	76	01/89-07/94	EJ18 SPI										
Engine	Information				A10	A20	A40	A50	A70	C10 - C30	C20	E01		
All engines	->year 31/12/91, version Hitachi						1.322.075							
All engines	version Hitachi							1.422.093						
1800 4WD	Petrol	76	01/89-07/94	EJ18 SPI										
Engine	Information				A10	A20	A40	A50	A70	C10 - C30	C20	E01		
All engines	->year 31/12/91, version Hitachi						1.322.075							
All engines	version Hitachi							1.422.093						
2.0	Petrol	85	08/91-12/93	EJ20E										
Engine	Information				A10	A20	A40	A50	A70	C10 - C30	C20	E01		
All engines										1.970.265	C10			
2.0i 16V	Petrol	85	08/91-12/93	EJ20E										
Engine	Information				A10	A20	A40	A50	A70	C10 - C30	C20	E01		
All engines										1.970.265	C10			
2.2i	Petrol	0	01/90->	--										
Engine	Information				A10	A20	A40	A50	A70	C10 - C30	C20	E01		
All engines	+automatic transmission, FOR: (USA)									1.970.265	C10			
All engines	FOR: (EU), +manual transmission, FOR: (USA)									1.970.266	C10			
2.2i [USA]	Petrol	0	01/90->	--										
Engine	Information				A10	A20	A40	A50	A70	C10 - C30	C20	E01		
All engines	+automatic transmission, FOR: (USA)									1.970.265	C10			
All engines	FOR: (EU), +manual transmission, FOR: (USA)									1.970.266	C10			
2.2i 16v	Petrol	100	08/89-10/91	EJ22E										
Engine	Information				A10	A20	A40	A50	A70	C10 - C30	C20	E01		
All engines										1.970.265	C10			

A10 CONDENSER	A20 CONTACT SET	A40 DISTRIBUTOR CAP	A50 ROTOR	A70 PICK-UP
C10 COIL	C20 IGNITION MODULE	C30 ELECTRONIC IGNITION KIT	E01 IGNITION CABLE SET	

The present application list is a brief version. For the detailed information about the possibility of installation on a specific vehicle, please refer to our web-catalogue <http://catalogo.facet.eu/>

Vehicle	alim.	kW	Date	Engine	FUNCTIONS ON THE VEHICLE							
					A10	A20	A40	A50	A70	C10 - C30	C20	E01

ENGINE				
2.2i Turbo [USA]	Petrol	0	01/90->	--

Engine	Information	A10	A20	A40	A50	A70	C10 - C30	C20	E01
All engines	+automatic transmission, FOR: (USA)						1.970.265	C10	
All engines	FOR: (EU), +manual transmission, FOR: (USA)						1.970.266	C10	

ENGINE				
2000	Petrol	85	09/91-12/93	EJ20 EMPI

Engine	Information	A10	A20	A40	A50	A70	C10 - C30	C20	E01
All engines							1.970.265	C10	

ENGINE				
2000 4WD	Petrol	85	08/91-07/94	EJ20 EMPI

Engine	Information	A10	A20	A40	A50	A70	C10 - C30	C20	E01
All engines							1.970.265	C10	

ENGINE				
2200 4WD	Petrol	100	01/89-07/94	EJ22 EMPI

Engine	Information	A10	A20	A40	A50	A70	C10 - C30	C20	E01
All engines							1.970.265	C10	

ENGINE				
2200 Super 4WD	Petrol	100	01/89-07/94	EJ22 EMPI

Engine	Information	A10	A20	A40	A50	A70	C10 - C30	C20	E01
All engines							1.970.265	C10	

LEGACY II

ENGINE				
1.8 4WD	Petrol	76	05/96-09/98	EJ18E

Engine	Information	A10	A20	A40	A50	A70	C10 - C30	C20	E01
All engines	->year 31/05/96						1.970.265	C10	
All engines	->year 31/05/96, 01/02/97 ->								1.501.835

ENGINE				
2.0 i	Petrol	85	09/94-03/99	EJ20 EMPI, EJ20E

Engine	Information	A10	A20	A40	A50	A70	C10 - C30	C20	E01
All engines							1.970.266	C10	1.501.835

ENGINE				
2.0 i 4WD	Petrol	85	09/94-03/99	EJ201, EJ20E

Engine	Information	A10	A20	A40	A50	A70	C10 - C30	C20	E01
All engines							1.970.266	C10	1.501.835

ENGINE				
2.2	Petrol	94	07/94-11/98	2LF479Q3

Engine	Information	A10	A20	A40	A50	A70	C10 - C30	C20	E01
All engines							1.970.266	C10	

ENGINE				
2.2 i 4WD	Petrol	94	02/94-03/99	EJ22 EMPI

Engine	Information	A10	A20	A40	A50	A70	C10 - C30	C20	E01
All engines							1.970.266	C10	

ENGINE				
2.2 i 4WD	Petrol	96	06/96-03/99	EJ22 EMPI

Engine	Information	A10	A20	A40	A50	A70	C10 - C30	C20	E01
All engines							1.970.266	C10	

ENGINE				
2.5	Petrol	110	01/96-12/99	EJ25D

Engine	Information	A10	A20	A40	A50	A70	C10 - C30	C20	E01
All engines							1.970.266	C10	

ENGINE				
2.5 i 4WD	Petrol	110	06/96-03/99	EJ25D

Engine	Information	A10	A20	A40	A50	A70	C10 - C30	C20	E01
All engines							1.970.266	C10	

LEGACY III

ENGINE				
2.0	Petrol	102	12/98-08/03	EJ201

Engine	Information	A10	A20	A40	A50	A70	C10 - C30	C20	E01
All engines									1.501.813

A10 CONDENSER	A20 CONTACT SET	A40 DISTRIBUTOR CAP	A50 ROTOR	A70 PICK-UP
C10 COIL	C20 IGNITION MODULE	C30 ELECTRONIC IGNITION KIT	E01 IGNITION CABLE SET	

Vehicle	alim.	kW	Date	Engine	FUNCTIONS ON THE VEHICLE									
					A10	A20	A40	A50	A70	C10 - C30	C20	E01		
ENGINE														
2.0	Petrol	92	12/98-08/03	EJ201										
ENGINE														
Engine Information					A10	A20	A40	A50	A70	C10 - C30	C20	E01		
All engines														1.501.813
2.0 AWD	Petrol	92	12/98-08/03	EJ201										
ENGINE														
Engine Information					A10	A20	A40	A50	A70	C10 - C30	C20	E01		
All engines														1.501.813
2.5	Petrol	115	10/98-08/03	EJ251										
ENGINE														
Engine Information					A10	A20	A40	A50	A70	C10 - C30	C20	E01		
All engines														1.501.813
2.5 AWD	Petrol	115	10/98-08/03	EJ25										
ENGINE														
Engine Information					A10	A20	A40	A50	A70	C10 - C30	C20	E01		
All engines														1.501.813
LEGACY IV														
2.0 AWD	Petrol	101	09/03-10/05	EJ202										
ENGINE														
Engine Information					A10	A20	A40	A50	A70	C10 - C30	C20	E01		
All engines														1.499.100
2.5 AWD	Petrol	121	09/03-04/09	EJ25										
ENGINE														
Engine Information					A10	A20	A40	A50	A70	C10 - C30	C20	E01		
All engines														1.499.106
2.5 i	Petrol	121	05/03->	EJ252, EJ253										
ENGINE														
Engine Information					A10	A20	A40	A50	A70	C10 - C30	C20	E01		
All engines														1.499.106
2.5 i AWD	Petrol	127	09/07-12/09	EJ25										
ENGINE														
Engine Information					A10	A20	A40	A50	A70	C10 - C30	C20	E01		
All engines														1.499.106
LOYALE														
1.8i SPi [USA]	Petrol	0	01/90->	--										
ENGINE														
Engine Information					A10	A20	A40	A50	A70	C10 - C30	C20	E01		
All engines							1.322.046							
1.8i Turbo [USA]	Petrol	0	01/90->	--										
ENGINE														
Engine Information					A10	A20	A40	A50	A70	C10 - C30	C20	E01		
All engines							1.322.046							
L-SERIES														
1.8i	Petrol	0	01/86-12/91	--										
ENGINE														
Engine Information					A10	A20	A40	A50	A70	C10 - C30	C20	E01		
All engines							1.322.046							
All engines								1.413.014						
1.8i TB	Petrol	0	01/86-12/91	--										
ENGINE														
Engine Information					A10	A20	A40	A50	A70	C10 - C30	C20	E01		
All engines							1.322.046							
1.8i TB 4x4	Petrol	0	01/86-12/91	--										
ENGINE														
Engine Information					A10	A20	A40	A50	A70	C10 - C30	C20	E01		
All engines							1.322.046							
1.8i Turbo	Petrol	0	01/86-12/91	--										
ENGINE														
Engine Information					A10	A20	A40	A50	A70	C10 - C30	C20	E01		
All engines							1.322.046							

A10 CONDENSER	A20 CONTACT SET	A40 DISTRIBUTOR CAP	A50 ROTOR	A70 PICK-UP
C10 COIL	C20 IGNITION MODULE	C30 ELECTRONIC IGNITION KIT	E01 IGNITION CABLE SET	

The present application list is a brief version. For the detailed information about the possibility of installation on a specific vehicle, please refer to our web-catalogue <http://catalogo.facet.eu/>

Vehicle	alim.	kW	Date	Engine	FUNCTIONS ON THE VEHICLE							
					A10	A20	A40	A50	A70	C10 - C30	C20	E01

OUTBACK II

2.5 AWD	Petrol	115	10/00-08/03	ENGINE
				EJ25

Engine	Information	A10	A20	A40	A50	A70	C10 - C30	C20	E01
All engines									1.501.813

OUTBACK III

2.0	Petrol	101	09/03-10/05	ENGINE
				EJ202

Engine	Information	A10	A20	A40	A50	A70	C10 - C30	C20	E01
All engines									1.499.100

2.0 AWD	Petrol	101	09/03-10/05	ENGINE
				EJ202

Engine	Information	A10	A20	A40	A50	A70	C10 - C30	C20	E01
All engines									1.499.100

2.5	Petrol	121	09/08-09/09	ENGINE
				EJ252, EJ253

Engine	Information	A10	A20	A40	A50	A70	C10 - C30	C20	E01
All engines									1.499.106

TRENDY

1.0	Petrol	40	08/86-05/95	ENGINE
				EF10

Engine	Information	A10	A20	A40	A50	A70	C10 - C30	C20	E01
All engines	super unlead (95), version Hitachi			1.322.041					
All engines	Super (98), version Hitachi			1.322.048					
All engines	01/04/88 ->, super unlead (95), version Hitachi				1.413.029				
All engines	->year 31/03/88, super unlead (95), version Hitachi				1.422.073				

1.2 12v	Petrol	49	06/86-08/95	ENGINE
				EF12

Engine	Information	A10	A20	A40	A50	A70	C10 - C30	C20	E01
All engines	version Hitachi			1.322.041	1.422.073				

TREZIA

1.3	Petrol	73	03/11->	ENGINE
				1NR-FE

Engine	Information	A10	A20	A40	A50	A70	C10 - C30	C20	E01
All engines	x 4, COIL ON PLUG						1.970.537	C10	

A10 CONDENSER	A20 CONTACT SET	A40 DISTRIBUTOR CAP	A50 ROTOR	A70 PICK-UP
C10 COIL	C20 IGNITION MODULE	C30 ELECTRONIC IGNITION KIT	E01 IGNITION CABLE SET	

Vehicle	alim.	kW	Date	Engine	FUNCTIONS ON THE VEHICLE							
					A10	A20	A40	A50	A70	C10 - C30	C20	E01

ALTO I				ENGINE
0.8	Petrol	29	06/82-08/84	F8A, F8B

Engine	Information	A10	A20	A40	A50	A70	C10 - C30	C20	E01
All engines	version Denso		1.213.011HV	1.313.107	1.413.014				

ALTO IV				ENGINE
1.0	Petrol	39	09/94-06/02	G10BB

Engine	Information	A10	A20	A40	A50	A70	C10 - C30	C20	E01
All engines	version Denso, no specific info conc. application available			1.313.123	1.413.028				
All engines	FOR: (EU), FOR: (AUS), version Denso, no specific info conc. application available			1.313.256	1.413.036				
All engines	petrol injection, no specific info conc. application available								1.499.231
All engines	fuel formation: carburettor, no specific info conc. application available								1.501.413

ALTO V				ENGINE
1.0	Petrol	43	01/00-06/02	G10BB

Engine	Information	A10	A20	A40	A50	A70	C10 - C30	C20	E01
All engines	version Denso, no specific info conc. application available			1.313.123	1.413.028				
All engines	FOR: (EU), FOR: (AUS), version Denso, no specific info conc. application available			1.313.256	1.413.036				
All engines	petrol injection, no specific info conc. application available								1.499.231
All engines	fuel formation: carburettor, no specific info conc. application available								1.501.413

ALTO VI				ENGINE
1.1	Petrol	46	09/04-12/08	6AR02150, F10D, F10DN

Engine	Information	A10	A20	A40	A50	A70	C10 - C30	C20	E01
Eng. F10D	Fitting Position:for cylinder 1, Fitting Position:for cylinder 4, x 2, SEMI-DIRECT						1.970.535	C10	
Eng. F10DN	->ch. MA3FFB21500280000, Qty: 2						1.970.535	C10	
Eng. F10DN	ch. MA3FFB21500280001 ->, Qty:2						1.970.570	C10	
Eng. 6AR02150, F10DN									1.499.005

BALENO				ENGINE
1.0	Petrol	82	02/16->	K10CT

Engine	Information	A10	A20	A40	A50	A70	C10 - C30	C20	E01
All engines	x 3, COIL ON PLUG						1.970.621	C10	

ENGINE				
1.2	Petrol	66	02/16->	K12C

Engine	Information	A10	A20	A40	A50	A70	C10 - C30	C20	E01
All engines	x 4, COIL ON PLUG						1.970.621	C10	

ENGINE				
1.2 Hybrid	Petrol/ Electric	66	02/16->	K12C

Engine	Information	A10	A20	A40	A50	A70	C10 - C30	C20	E01
All engines	x 4, COIL ON PLUG						1.970.621	C10	

ENGINE				
1.3 16V	Petrol	63	03/97-05/02	G13BB

Engine	Information	A10	A20	A40	A50	A70	C10 - C30	C20	E01
All engines	01/02/99 ->								1.499.005
All engines	->year 31/01/99								1.501.434

ENGINE				
1.3 i 16V	Petrol	63	07/95-05/02	G13BB









Engine	Information	A10	A20	A40	A50	A70	C10 - C30	C20	E01
All engines	01/02/99 ->								1.499.005
All engines	->year 31/01/99								1.501.434

ENGINE				
1.6	Petrol	71	07/96-01/99	G16B

Engine	Information	A10	A20	A40	A50	A70	C10 - C30	C20	E01
All engines	ch. 00160001 ->, x 2, SEMI-DIRECT						1.970.535	C10	

A10	CONDENSER	A20	CONTACT SET	A40	DISTRIBUTOR CAP	A50	ROTOR	A70	PICK-UP
C10	COIL	C20	IGNITION MODULE	C30	ELECTRONIC IGNITION KIT	E01	IGNITION CABLE SET		

The present application list is a brief version. For the detailed information about the possibility of installation on a specific vehicle, please refer to our web-catalogue <http://catalogo.facet.eu/>

				FUNCTIONS ON THE VEHICLE								
Vehicle	alim.	kW	Date	Engine								
				ENGINE								
1.6 i 16V	Petrol	72	07/95-05/02	G16B								
Engine	Information			A10	A20	A40	A50	A70	C10 - C30		C20	E01
All engines	ch. 00160001 ->, x 2, SEMI-DIRECT								1.970.535	C10		
All engines	01/02/99 ->											1.499.005
All engines	->year 31/01/99											1.501.434
				ENGINE								
1.6 i 16V	Petrol	73	08/96-05/02	G16B								
Engine	Information			A10	A20	A40	A50	A70	C10 - C30		C20	E01
All engines	ch. 00160001 ->, x 2, SEMI-DIRECT								1.970.535	C10		
All engines	01/02/99 ->											1.499.005
All engines	->year 31/01/99											1.501.434
				ENGINE								
1.6 i 16V 4x4	Petrol	72	07/95-05/02	G16B								
Engine	Information			A10	A20	A40	A50	A70	C10 - C30		C20	E01
All engines	ch. 00160001 ->, x 2, SEMI-DIRECT								1.970.535	C10		
All engines	01/02/99 ->											1.499.005
All engines	->year 31/01/99											1.501.434
				ENGINE								
1.6 i 16V 4x4	Petrol	73	08/96-05/02	G16B								
Engine	Information			A10	A20	A40	A50	A70	C10 - C30		C20	E01
All engines	ch. 00160001 ->, x 2, SEMI-DIRECT								1.970.535	C10		
All engines	01/02/99 ->											1.499.005
All engines	->year 31/01/99											1.501.434
CARRY												
				ENGINE								
1.3	Petrol	56	02/99-09/04	G13BB								
Engine	Information			A10	A20	A40	A50	A70	C10 - C30		C20	E01
All engines	x 2, SEMI-DIRECT								1.970.535	C10		
				ENGINE								
1.3	Petrol	57	03/99-12/06	G13BB								
Engine	Information			A10	A20	A40	A50	A70	C10 - C30		C20	E01
All engines	x 2, SEMI-DIRECT								1.970.535	C10		
				ENGINE								
1.3	Petrol	58	03/99->	G13BB								
Engine	Information			A10	A20	A40	A50	A70	C10 - C30		C20	E01
All engines												1.499.005
				ENGINE								
1.3 16 V	Petrol	58	03/00->	G13BB								
Engine	Information			A10	A20	A40	A50	A70	C10 - C30		C20	E01
All engines	x 2, SEMI-DIRECT								1.970.535	C10		
All engines												1.499.005
ESTEEM												
				ENGINE								
1.6i [USA]	Petrol	70	09/98->	G16B								
Engine	Information			A10	A20	A40	A50	A70	C10 - C30		C20	E01
All engines	Qty: 2								1.970.535	C10		
All engines												1.499.005
GRAND VITARA I												
				ENGINE								
1.6 4x4	Petrol	69	03/98-07/03	G16B								
Engine	Information			A10	A20	A40	A50	A70	C10 - C30		C20	E01
All engines	x 1, D.I.S.								1.970.591	C10		
				ENGINE								
1.6 4x4	Petrol	71	09/03-09/05	G16B								
Engine	Information			A10	A20	A40	A50	A70	C10 - C30		C20	E01
All engines	x 1, D.I.S.								1.970.591	C10		
				ENGINE								
1.6 4x4	Petrol	73	02/00-09/02	G16B								
Engine	Information			A10	A20	A40	A50	A70	C10 - C30		C20	E01
All engines												1.499.005

A10 CONDENSER	A20 CONTACT SET	A40 DISTRIBUTOR CAP	A50 ROTOR	A70 PICK-UP
C10 COIL	C20 IGNITION MODULE	C30 ELECTRONIC IGNITION KIT	E01 IGNITION CABLE SET	

Vehicle	alim.	kW	Date	Engine	FUNCTIONS ON THE VEHICLE							
					A10	A20	A40	A50	A70	C10 - C30	C20	E01
GRAND VITARA II												
1.6	Petrol	78	10/05->	M16A								
ENGINE												
Engine	Information				A10	A20	A40	A50	A70	C10 - C30	C20	E01
All engines	x 2, SEMI-DIRECT									1.970.535	C10	
1.6 4x4	Petrol	73	09/05-02/15	M16A								
ENGINE												
Engine	Information				A10	A20	A40	A50	A70	C10 - C30	C20	E01
All engines	Qty: 2									1.970.535	C10	
All engines												1.499.013
1.6 Trazione integrale	Petrol	73	09/05-02/15	M16A								
ENGINE												
Engine	Information				A10	A20	A40	A50	A70	C10 - C30	C20	E01
All engines	Fitting Position:for cylinder 2, Fitting Position:for cylinder 4, x 2, SEMI-DIRECT									1.970.535	C10	
1.6 Trazione integrale	Petrol	78	04/05-02/15	M16A								
ENGINE												
Engine	Information				A10	A20	A40	A50	A70	C10 - C30	C20	E01
All engines	x 2, SEMI-DIRECT									1.970.535	C10	
All engines												1.499.013
IGNIS I												
1.3	Petrol	61	10/00-09/03	M13A								
ENGINE												
Engine	Information				A10	A20	A40	A50	A70	C10 - C30	C20	E01
All engines	x 2, SEMI-DIRECT									1.970.535	C10	
All engines												1.499.013
1.3 4WD	Petrol	61	10/00-09/03	M13A								
ENGINE												
Engine	Information				A10	A20	A40	A50	A70	C10 - C30	C20	E01
All engines	x 2, SEMI-DIRECT									1.970.535	C10	
All engines												1.499.013
1.5 Sport	Petrol	80	12/03-12/05	M15A								
ENGINE												
Engine	Information				A10	A20	A40	A50	A70	C10 - C30	C20	E01
All engines	Fitting Position:for cylinder 1, Fitting Position:for cylinder 4, x 2, SEMI-DIRECT									1.970.535	C10	
All engines												1.499.013
IGNIS II												
1.3	Petrol	69	09/03->	M13A								
ENGINE												
Engine	Information				A10	A20	A40	A50	A70	C10 - C30	C20	E01
All engines	x 2, SEMI-DIRECT									1.970.570	C10	
All engines												1.499.013
1.3 4x4	Petrol	69	09/03->	M13A								
ENGINE												
Engine	Information				A10	A20	A40	A50	A70	C10 - C30	C20	E01
All engines	x 2, SEMI-DIRECT									1.970.570	C10	
All engines												1.499.013
1.5	Petrol	73	09/03->	M15A								
ENGINE												
Engine	Information				A10	A20	A40	A50	A70	C10 - C30	C20	E01
All engines	Fitting Position:for cylinder 1, Fitting Position:for cylinder 4, x 2, SEMI-DIRECT									1.970.570	C10	
All engines												1.499.013
1.5 4x4	Petrol	73	09/03->	M15A								
ENGINE												
Engine	Information				A10	A20	A40	A50	A70	C10 - C30	C20	E01
All engines	Fitting Position:for cylinder 1, Fitting Position:for cylinder 4, x 2, SEMI-DIRECT									1.970.570	C10	
All engines												1.499.013

A10 CONDENSER	A20 CONTACT SET	A40 DISTRIBUTOR CAP	A50 ROTOR	A70 PICK-UP
C10 COIL	C20 IGNITION MODULE	C30 ELECTRONIC IGNITION KIT	E01 IGNITION CABLE SET	

The present application list is a brief version. For the detailed information about the possibility of installation on a specific vehicle, please refer to our web-catalogue <http://catalogo.facet.eu/>

Vehicle	alim.	kW	Date	Engine	FUNCTIONS ON THE VEHICLE							
					A10	A20	A40	A50	A70	C10 - C30	C20	E01

IGNIS III

				ENGINE
1.2	Petrol	66	10/16->	K12C

Engine	Information	A10	A20	A40	A50	A70	C10 - C30	C20	E01
All engines	x 4, COIL ON PLUG						1.970.621	C10	

				ENGINE
1.2 AllGrip	Petrol	66	10/16->	K12C

Engine	Information	A10	A20	A40	A50	A70	C10 - C30	C20	E01
All engines	x 4, COIL ON PLUG						1.970.621	C10	

				ENGINE
1.2 Hybrid	Petrol/ Electric	66	10/16->	K12C

Engine	Information	A10	A20	A40	A50	A70	C10 - C30	C20	E01
All engines	x 4, COIL ON PLUG						1.970.621	C10	

				ENGINE
1.2 Hybrid AllGrip	Petrol/ Electric	66	10/16->	K12C

Engine	Information	A10	A20	A40	A50	A70	C10 - C30	C20	E01
All engines	x 4, COIL ON PLUG						1.970.621	C10	

JIMNY III

				ENGINE
1.3	Petrol	63	08/04->	M13A

Engine	Information	A10	A20	A40	A50	A70	C10 - C30	C20	E01
All engines	x 1, D.I.S.						1.970.591	C10	

				ENGINE
1.3 16V	Petrol	59	09/98->	G13BB

Engine	Information	A10	A20	A40	A50	A70	C10 - C30	C20	E01
All engines	x 1, D.I.S.						1.970.591	C10	
All engines									1.499.005

				ENGINE
1.3 16V	Petrol	60	02/01->	M13A

Engine	Information	A10	A20	A40	A50	A70	C10 - C30	C20	E01
All engines	x 1, D.I.S.						1.970.591	C10	
All engines									1.499.013

				ENGINE
1.3 16V 4WD	Petrol	59	09/98->	G13BB

Engine	Information	A10	A20	A40	A50	A70	C10 - C30	C20	E01
All engines	x 1, D.I.S.						1.970.591	C10	
All engines									1.499.005

				ENGINE
1.3 16V 4WD	Petrol	60	02/01->	M13A

Engine	Information	A10	A20	A40	A50	A70	C10 - C30	C20	E01
All engines	x 1, D.I.S.						1.970.591	C10	
All engines									1.499.013

				ENGINE
1.3 16V 4x4	Petrol	63	08/05->	M13A

Engine	Information	A10	A20	A40	A50	A70	C10 - C30	C20	E01
All engines	x 1, D.I.S.						1.970.591	C10	
All engines									1.499.013

				ENGINE
1.3 4WD	Petrol	62	05/14->	M13A

Engine	Information	A10	A20	A40	A50	A70	C10 - C30	C20	E01
All engines	x 2, SEMI-DIRECT						1.970.535	C10	
All engines									1.499.013

				ENGINE
1.3 4WD	Petrol	63	03/13->	M13A

Engine	Information	A10	A20	A40	A50	A70	C10 - C30	C20	E01
All engines	x 2, SEMI-DIRECT						1.970.535	C10	

				ENGINE
1.3 4x4	Petrol	63	09/98-08/00	G13BB

Engine	Information	A10	A20	A40	A50	A70	C10 - C30	C20	E01
All engines	Qty: 2						1.970.591	C10	

A10 CONDENSER	A20 CONTACT SET	A40 DISTRIBUTOR CAP	A50 ROTOR	A70 PICK-UP
C10 COIL	C20 IGNITION MODULE	C30 ELECTRONIC IGNITION KIT	E01 IGNITION CABLE SET	

Vehicle	alim.	kW	Date	Engine	FUNCTIONS ON THE VEHICLE									
					A10	A20	A40	A50	A70	C10 - C30	C20	E01		
ENGINE														
1.3 4x4	Petrol	63	09/98-08/00	G13BB										
Engine	Information				A10	A20	A40	A50	A70	C10 - C30	C20	E01		
All engines													1.499.005	
LIANA														
1.3	Petrol	66	07/01->	M13A										
Engine	Information				A10	A20	A40	A50	A70	C10 - C30	C20	E01		
All engines	x 2, SEMI-DIRECT									1.970.535	C10			
All engines													1.499.013	
ENGINE														
1.6	Petrol	76	07/01->	M16A										
Engine	Information				A10	A20	A40	A50	A70	C10 - C30	C20	E01		
All engines	x 2, SEMI-DIRECT									1.970.535	C10			
All engines													1.499.013	
ENGINE														
1.6	Petrol	79	01/05->	M16A										
Engine	Information				A10	A20	A40	A50	A70	C10 - C30	C20	E01		
All engines	x 2, SEMI-DIRECT									1.970.535	C10			
All engines													1.499.013	
ENGINE														
1.6 4WD	Petrol	76	07/01->	M16A										
Engine	Information				A10	A20	A40	A50	A70	C10 - C30	C20	E01		
All engines	x 2, SEMI-DIRECT									1.970.535	C10			
All engines													1.499.013	
ENGINE														
1.6 4WD	Petrol	78	04/02->	M16A										
Engine	Information				A10	A20	A40	A50	A70	C10 - C30	C20	E01		
All engines	x 2, SEMI-DIRECT									1.970.535	C10			
All engines													1.499.013	
ENGINE														
1.6 4WD	Petrol	79	01/05-12/07	M16A										
Engine	Information				A10	A20	A40	A50	A70	C10 - C30	C20	E01		
All engines	x 2, SEMI-DIRECT									1.970.535	C10			
All engines													1.499.013	
ENGINE														
1.6 i	Petrol	78	04/02->	M16A										
Engine	Information				A10	A20	A40	A50	A70	C10 - C30	C20	E01		
All engines	x 2, SEMI-DIRECT									1.970.535	C10			
All engines													1.499.013	
ENGINE														
1.8 i	Petrol	92	10/01->	M18A										
Engine	Information				A10	A20	A40	A50	A70	C10 - C30	C20	E01		
All engines	Qty: 2									1.970.535	C10			
All engines													1.499.013	
SAMURAI														
1.3	Petrol	49	08/89-07/92	G13BA										
Engine	Information				A10	A20	A40	A50	A70	C10 - C30	C20	E01		
All engines	version Denso						1.313.256	1.413.036						
ENGINE														
1.3	Petrol	52	11/88-03/98	G13BA										
Engine	Information				A10	A20	A40	A50	A70	C10 - C30	C20	E01		
All engines	version Denso						1.313.256	1.413.036						
ENGINE														
1.3 Trazione integrale	Petrol	44	11/88-12/04	G13A										
Engine	Information				A10	A20	A40	A50	A70	C10 - C30	C20	E01		
All engines	version Denso						1.313.093	1.413.030						

A10	CONDENSER	A20	CONTACT SET	A40	DISTRIBUTOR CAP	A50	ROTOR	A70	PICK-UP
C10	COIL	C20	IGNITION MODULE	C30	ELECTRONIC IGNITION KIT	E01	IGNITION CABLE SET		

The present application list is a brief version. For the detailed information about the possibility of installation on a specific vehicle, please refer to our web-catalogue <http://catalogo.facet.eu/>

Vehicle	alim.	kW	Date	Engine	FUNCTIONS ON THE VEHICLE							
					A10	A20	A40	A50	A70	C10 - C30	C20	E01

ENGINE				
1.3 Trazione integrale	Petrol	47	11/88-12/04	G13A

Engine	Information	A10	A20	A40	A50	A70	C10 - C30	C20	E01
All engines	version Denso			1.313.256	1.413.036				

ENGINE				
1.3 Trazione integrale	Petrol	51	11/88-12/04	G13BA

Engine	Information	A10	A20	A40	A50	A70	C10 - C30	C20	E01
All engines	version Denso			1.313.256	1.413.036				

ENGINE				
1.3 Trazione integrale	Petrol	59	01/00-12/04	G13BA

Engine	Information	A10	A20	A40	A50	A70	C10 - C30	C20	E01
All engines	version Denso			1.313.256	1.413.036				

SIDEKICK

ENGINE				
1.6 JX 4x4	Petrol	59	04/89-04/96	G16A (8V)

Engine	Information	A10	A20	A40	A50	A70	C10 - C30	C20	E01
All engines	version Denso			1.313.123					
All engines							1.970.201	C10	1.499.004

ENGINE				
1.6i [USA]	Petrol	0	01/89->	--

Engine	Information	A10	A20	A40	A50	A70	C10 - C30	C20	E01
All engines	version Denso			1.313.093	1.413.030				
All engines	version Mitsubishi			1.331.140	1.431.131				
All engines	no specific info conc. application available								1.501.415, 1.501.417

ENGINE				
1.6i 16V J1X 4x4	Petrol	71	04/89-04/96	G16B

Engine	Information	A10	A20	A40	A50	A70	C10 - C30	C20	E01
All engines	version Denso			1.331.144	1.431.131				

ENGINE				
1.6i 16V JX 4x4	Petrol	71	04/89-04/96	G16B

Engine	Information	A10	A20	A40	A50	A70	C10 - C30	C20	E01
All engines	version Denso			1.313.123					
All engines							1.970.201	C10	

SJ410

ENGINE				
1.0	Petrol	33	09/81-07/91	F10A

Engine	Information	A10	A20	A40	A50	A70	C10 - C30	C20	E01
All engines	version Denso		1.213.011HV		1.413.014				
All engines	01/01/84 ->, version Denso			1.313.093					
All engines	RHD								1.499.020
All engines	LHD								1.501.413

SJ413

ENGINE				
1.3	Petrol	47	09/84-08/90	G13A

Engine	Information	A10	A20	A40	A50	A70	C10 - C30	C20	E01
All engines	version Denso			1.313.093	1.413.030				
All engines									1.499.020

SUPER CARRY

ENGINE				
1.0	Petrol	30	09/94-03/99	F10A

Engine	Information	A10	A20	A40	A50	A70	C10 - C30	C20	E01
All engines	version Denso		1.213.011HV	1.313.093	1.413.030				

ENGINE				
1.0	Petrol	31	10/92-03/99	F10A

Engine	Information	A10	A20	A40	A50	A70	C10 - C30	C20	E01
All engines	version Denso		1.213.011HV	1.313.093	1.413.030				

A10	CONDENSER	A20	CONTACT SET	A40	DISTRIBUTOR CAP	A50	ROTOR	A70	PICK-UP
C10	COIL	C20	IGNITION MODULE	C30	ELECTRONIC IGNITION KIT	E01	IGNITION CABLE SET		

Vehicle	alim.	kW	Date	Engine	FUNCTIONS ON THE VEHICLE														
					A10	A20	A40	A50	A70	C10 - C30	C20	E01							
ENGINE																			
1.0	Petrol	33	10/85-03/99	F10A															
Engine		Information			A10	A20	A40	A50	A70	C10 - C30	C20	E01							
All engines		version Denso				1.213.011HV	1.313.093	1.413.030											
SWIFT I / II																			
1.0	Petrol	37	10/83-03/89	G10, G10A															
Engine		Information			A10	A20	A40	A50	A70	C10 - C30	C20	E01							
All engines		version Denso						1.413.030											
ENGINE																			
1.3 GTi/GXi	Petrol	74	08/85-03/89	G13B															
Engine		Information			A10	A20	A40	A50	A70	C10 - C30	C20	E01							
All engines		version Hitachi					1.322.046												
SWIFT I / II / III																			
1.0	Petrol	37	03/89-05/01	G10A															
Engine		Information			A10	A20	A40	A50	A70	C10 - C30	C20	E01							
All engines		version Denso						1.413.030											
ENGINE																			
1.0 i	Petrol	39	03/89-12/05	G10, G10A															
Engine		Information			A10	A20	A40	A50	A70	C10 - C30	C20	E01							
All engines		version Denso					1.313.245	1.413.034											
ENGINE																			
1.0 i	Petrol	40	03/89-12/91	G10A															
Engine		Information			A10	A20	A40	A50	A70	C10 - C30	C20	E01							
All engines		version Denso						1.413.030											
ENGINE																			
1.3	Petrol	50	03/89-05/01	G13A															
Engine		Information			A10	A20	A40	A50	A70	C10 - C30	C20	E01							
All engines		version Denso					1.313.123	1.413.028											
ENGINE																			
1.3	Petrol	51	03/89-10/96	G13BA															
Engine		Information			A10	A20	A40	A50	A70	C10 - C30	C20	E01							
All engines		version Denso					1.313.123	1.413.028											
All engines													1.501.413						
ENGINE																			
1.3	Petrol	52	03/89-12/91	G13A, G13B															
Engine		Information			A10	A20	A40	A50	A70	C10 - C30	C20	E01							
All engines		version Denso					1.313.123	1.413.028											
ENGINE																			
1.3 4WD	Petrol	50	03/89-05/01	G13A															
Engine		Information			A10	A20	A40	A50	A70	C10 - C30	C20	E01							
All engines		version Denso					1.313.123	1.413.028											
ENGINE																			
1.3 4WD	Petrol	52	10/89-12/91	G13A															
Engine		Information			A10	A20	A40	A50	A70	C10 - C30	C20	E01							
All engines		version Denso					1.313.123	1.413.028											
ENGINE																			
1.3 GTi	Petrol	74	03/89-05/01	G13B															
Engine		Information			A10	A20	A40	A50	A70	C10 - C30	C20	E01							
All engines		version Hitachi					1.322.046												
ENGINE																			
1.3 GTi DOHC	Petrol	74	10/89-12/95	G13B															
Engine		Information			A10	A20	A40	A50	A70	C10 - C30	C20	E01							
All engines		version Hitachi					1.322.046												
ENGINE																			
1.3 GTi SOHC	Petrol	50	10/89-12/95	G13B															
Engine		Information			A10	A20	A40	A50	A70	C10 - C30	C20	E01							
All engines		version Denso					1.313.123	1.413.028											
All engines		version Mitsubishi					1.331.132	1.431.108											
All engines		version TYPE 1											1.501.413						
A10	CONDENSER			A20	CONTACT SET			A40	DISTRIBUTOR CAP			A50	ROTOR			A70	PICK-UP		
C10	COIL			C20	IGNITION MODULE			C30	ELECTRONIC IGNITION KIT			E01	IGNITION CABLE SET						

Vehicle	alim.	kW	Date	Engine	FUNCTIONS ON THE VEHICLE								
					A10	A20	A40	A50	A70	C10 - C30	C20	E01	
ENGINE													
1.3 i	Petrol	50	09/91-10/96	G13BA									
Engine	Information				A10	A20	A40	A50	A70	C10 - C30	C20	E01	
All engines	version Denso						1.313.123	1.413.028					
All engines													1.501.413
ENGINE													
1.3i SOHC [USA]	Petrol	0	01/89-12/94	--									
Engine	Information				A10	A20	A40	A50	A70	C10 - C30	C20	E01	
All engines	version Denso						1.313.123	1.413.028					
ENGINE													
1.6	Petrol	70	11/89-12/91	G16B									
Engine	Information				A10	A20	A40	A50	A70	C10 - C30	C20	E01	
All engines	version Mitsubishi						1.331.132	1.431.108					
ENGINE													
1.6 4WD	Petrol	70	11/89-12/91	G16B									
Engine	Information				A10	A20	A40	A50	A70	C10 - C30	C20	E01	
All engines	version Mitsubishi						1.331.132	1.431.108					
ENGINE													
1.6 i 16V	Petrol	72	08/92-10/96	G16BA									
Engine	Information				A10	A20	A40	A50	A70	C10 - C30	C20	E01	
All engines	version Denso						1.313.123	1.413.028					
ENGINE													
1.6 i 16V 4x4	Petrol	72	08/92-10/96	G16BA									
Engine	Information				A10	A20	A40	A50	A70	C10 - C30	C20	E01	
All engines	version Denso						1.313.123	1.413.028					
SWIFT III													
ENGINE													
1.3 [USA]	Petrol	0	06/95-05/01	--									
Engine	Information				A10	A20	A40	A50	A70	C10 - C30	C20	E01	
All engines	->year 01/12/97, version Denso						1.313.123	1.413.028					
All engines	01/01/99 ->, Qty: 2									1.970.591	C10		
All engines	01/01/99 ->												1.499.005
ENGINE													
1.3 i	Petrol	49	06/96-03/01	G13BA									
Engine	Information				A10	A20	A40	A50	A70	C10 - C30	C20	E01	
All engines	version Denso						1.313.123	1.413.028					
All engines													1.501.413
SWIFT IV													
ENGINE													
1.3	Petrol	67	02/05-06/15	M13A									
Engine	Information				A10	A20	A40	A50	A70	C10 - C30	C20	E01	
All engines	Qty: 2									1.970.570	C10		
All engines													1.499.013
ENGINE													
1.3	Petrol	68	02/05->	M13A									
Engine	Information				A10	A20	A40	A50	A70	C10 - C30	C20	E01	
All engines	x 2, SEMI-DIRECT									1.970.535	C10		
All engines	MADE BY: (H), x 2, SEMI-DIRECT									1.970.570	C10		
All engines													1.499.013
ENGINE													
1.3 4x4	Petrol	66	01/06->	M13A									
Engine	Information				A10	A20	A40	A50	A70	C10 - C30	C20	E01	
All engines	x 2, SEMI-DIRECT									1.970.535	C10		
All engines	MADE BY: (H), x 2, SEMI-DIRECT									1.970.570	C10		
All engines													1.499.013
ENGINE													
1.3 4x4	Petrol	68	02/05->	M13A									
Engine	Information				A10	A20	A40	A50	A70	C10 - C30	C20	E01	
All engines	x 2, SEMI-DIRECT									1.970.535	C10		
All engines	MADE BY: (H), x 2, SEMI-DIRECT									1.970.570	C10		
All engines													1.499.013

A10 CONDENSER	A20 CONTACT SET	A40 DISTRIBUTOR CAP	A50 ROTOR	A70 PICK-UP
C10 COIL	C20 IGNITION MODULE	C30 ELECTRONIC IGNITION KIT	E01 IGNITION CABLE SET	

Vehicle	alim.	kW	Date	Engine	FUNCTIONS ON THE VEHICLE									
					A10	A20	A40	A50	A70	C10 - C30	C20	E01		
ENGINE														
1.3 LPG	Petrol/ Liquified Petro- leum Gas (LPG)	68	09/08-12/10	M13A										
ENGINE					A10	A20	A40	A50	A70	C10 - C30	C20	E01		
All engines										1.970.535	C10			
All engines										1.970.570	C10			
ENGINE														
1.5	Petrol	75	02/05->	M15A										
ENGINE					A10	A20	A40	A50	A70	C10 - C30	C20	E01		
All engines										1.970.535	C10			
All engines										1.970.570	C10			
All engines													1.499.013	
ENGINE														
1.5 4x4	Petrol	74	02/05->	M15A										
ENGINE					A10	A20	A40	A50	A70	C10 - C30	C20	E01		
All engines										1.970.535	C10			
All engines													1.499.013	
ENGINE														
1.6	Petrol	92	05/06->	M16A										
ENGINE					A10	A20	A40	A50	A70	C10 - C30	C20	E01		
All engines										1.970.535	C10			
All engines										1.970.570	C10			
All engines													1.499.013	
ENGINE														
1.6 4x4	Petrol	92	02/05->	M16A										
ENGINE					A10	A20	A40	A50	A70	C10 - C30	C20	E01		
All engines										1.970.535	C10			
All engines													1.499.013	
SWIFT V														
ENGINE														
1.2	Petrol	67	08/12->	K12B										
ENGINE					A10	A20	A40	A50	A70	C10 - C30	C20	E01		
All engines										1.970.621	C10			
ENGINE														
1.2 4WD	Petrol	67	08/12->	K12B										
ENGINE					A10	A20	A40	A50	A70	C10 - C30	C20	E01		
All engines										1.970.621	C10			
SWIFT VI														
ENGINE														
1.0	Petrol	82	04/17->	K10C										
ENGINE					A10	A20	A40	A50	A70	C10 - C30	C20	E01		
All engines										1.970.621	C10			
ENGINE														
1.0 SHVS	Petrol/ Electric	82	04/17->	K10C										
ENGINE					A10	A20	A40	A50	A70	C10 - C30	C20	E01		
All engines										1.970.621	C10			
ENGINE														
1.2	Petrol	66	04/17->	K12C										
ENGINE					A10	A20	A40	A50	A70	C10 - C30	C20	E01		
All engines										1.970.621	C10			
ENGINE														
1.2 AllGrip	Petrol	66	04/17->	K12C										
ENGINE					A10	A20	A40	A50	A70	C10 - C30	C20	E01		
All engines										1.970.621	C10			
ENGINE														
1.2 SHVS	Petrol/ Electric	66	04/17->	K12C										
ENGINE					A10	A20	A40	A50	A70	C10 - C30	C20	E01		
All engines										1.970.621	C10			

A10	CONDENSER	A20	CONTACT SET	A40	DISTRIBUTOR CAP	A50	ROTOR	A70	PICK-UP
C10	COIL	C20	IGNITION MODULE	C30	ELECTRONIC IGNITION KIT	E01	IGNITION CABLE SET		

The present application list is a brief version. For the detailed information about the possibility of installation on a specific vehicle, please refer to our web-catalogue <http://catalogo.facet.eu/>

Vehicle	alim.	kW	Date	Engine	FUNCTIONS ON THE VEHICLE							
					A10	A20	A40	A50	A70	C10 - C30	C20	E01

ENGINE				
1.2 SHVS AllGrip	Petrol/ Electric	66	04/17->	K12C

Engine	Information	A10	A20	A40	A50	A70	C10 - C30	C20	E01
All engines	x 4, COIL ON PLUG						1.970.621	C10	

ENGINE				
1.4 Sport	Petrol	103	09/17->	K14C

Engine	Information	A10	A20	A40	A50	A70	C10 - C30	C20	E01
All engines	x 4, COIL ON PLUG						1.970.621	C10	

SX4 I

ENGINE				
1.5	Petrol	73	06/06-07/10	M15A

Engine	Information	A10	A20	A40	A50	A70	C10 - C30	C20	E01
All engines	x 2, SEMI-DIRECT						1.970.535	C10	
All engines	->ch. TSMEYA11S00449999, MADE BY: (H), x 2, SEMI-DIRECT						1.970.570	C10	
All engines	version TYPE 1, 2								1.499.013

ENGINE				
1.5 VVT	Petrol	82	07/10->	M15A

Engine	Information	A10	A20	A40	A50	A70	C10 - C30	C20	E01
All engines	x 2, SEMI-DIRECT						1.970.535	C10	
All engines	->ch. TSMEYA11S00449999, MADE BY: (H), x 2, SEMI-DIRECT						1.970.570	C10	
All engines	version TYPE 1, 2								1.499.013

ENGINE				
1.5 VVT 4x4	Petrol	82	07/10->	M15A

Engine	Information	A10	A20	A40	A50	A70	C10 - C30	C20	E01
All engines	x 2, SEMI-DIRECT						1.970.535	C10	
All engines	->ch. TSMEYA11S00449999, MADE BY: (H), x 2, SEMI-DIRECT						1.970.570	C10	
All engines	version TYPE 1, 2								1.499.013

ENGINE				
1.5 VVTi	Petrol	81	07/07-12/15	M15A

Engine	Information	A10	A20	A40	A50	A70	C10 - C30	C20	E01
All engines	x 2, SEMI-DIRECT						1.970.535	C10	
All engines	->ch. TSMEYA11S00449999, MADE BY: (H), x 2, SEMI-DIRECT						1.970.570	C10	

ENGINE				
1.6	Petrol	74	06/06->	M16A

Engine	Information	A10	A20	A40	A50	A70	C10 - C30	C20	E01
All engines	ch. JSA, Qty: 2						1.970.535	C10	
All engines	Qty: 2, version TYPE 1, 2						1.970.570	C10	
All engines	version TYPE 1, 2								1.499.013

ENGINE				
1.6	Petrol	75	10/07->	M16A

Engine	Information	A10	A20	A40	A50	A70	C10 - C30	C20	E01
All engines	ch. JSA, Qty: 2						1.970.535	C10	
All engines									1.499.013

ENGINE				
1.6	Petrol	79	10/07->	M16A

Engine	Information	A10	A20	A40	A50	A70	C10 - C30	C20	E01
All engines	Fitting Position:for cylinder 2, Fitting Position:for cylinder 4, ->ch. JSAGYB41S00300000, x 2, SEMI-DIRECT						1.970.535	C10	
All engines	Fitting Position:for cylinder 2, Fitting Position:for cylinder 4, ->ch. TSMEYB21S00450000, ->ch. TSMEYB21S00460000, ->ch. TSMEYB21S00470000, ->ch. TSMEYB21S00490000, ->ch. TSMEYB21S00510000, ->ch. TSMEYB21S00530000, ->ch. TSMEYB21S00560000, ->ch. TSMEYB21S00630000, ->ch. TSMEYB21S00680000, MADE BY: (H), x 2, SEMI-DIRECT						1.970.570	C10	
All engines									1.499.013

ENGINE				
1.6	Petrol	88	10/07->	M16A

Engine	Information	A10	A20	A40	A50	A70	C10 - C30	C20	E01
All engines	Fitting Position:for cylinder 2, Fitting Position:for cylinder 4, ->ch. JSAGYB41S00300000, x 2, SEMI-DIRECT						1.970.535	C10	

A10 CONDENSER	A20 CONTACT SET	A40 DISTRIBUTOR CAP	A50 ROTOR	A70 PICK-UP
C10 COIL	C20 IGNITION MODULE	C30 ELECTRONIC IGNITION KIT	E01 IGNITION CABLE SET	

Vehicle	alim.	kW	Date	Engine	FUNCTIONS ON THE VEHICLE							
					A10	A20	A40	A50	A70	C10 - C30	C20	E01
ENGINE												
1.6	Petrol	88	10/07->	M16A								
Engine	Information			A10	A20	A40	A50	A70	C10 - C30	C20	E01	
All engines	Fitting Position:for cylinder 2, Fitting Position:for cylinder 4, ->ch. TSMYB21500450000, ->ch. TSMYB21500460000, ->ch. TSMYB21500470000, ->ch. TSMYB21500490000, ->ch. TSMYB21500510000, ->ch. TSMYB21500530000, ->ch. TSMYB21500560000, ->ch. TSMYB21500630000, ->ch. TSMYB21500680000, MADE BY: (H), x 2, SEMI-DIRECT								1.970.570	C10		
All engines											1.499.013	
ENGINE												
1.6 AWD	Petrol	79	10/07-12/11	M16A								
Engine	Information			A10	A20	A40	A50	A70	C10 - C30	C20	E01	
All engines	Fitting Position:for cylinder 2, Fitting Position:for cylinder 4, ->ch. JSAGYB41500300000, x 2, SEMI-DIRECT								1.970.535	C10		
All engines	Fitting Position:for cylinder 2, Fitting Position:for cylinder 4, ->ch. TSMYB21500450000, ->ch. TSMYB21500460000, ->ch. TSMYB21500470000, ->ch. TSMYB21500490000, ->ch. TSMYB21500510000, ->ch. TSMYB21500530000, ->ch. TSMYB21500560000, ->ch. TSMYB21500630000, ->ch. TSMYB21500680000, MADE BY: (H), x 2, SEMI-DIRECT								1.970.570	C10		
All engines											1.499.013	
ENGINE												
1.6 AWD	Petrol	88	10/07->	M16A								
Engine	Information			A10	A20	A40	A50	A70	C10 - C30	C20	E01	
All engines	ch. JSA, Qty: 2								1.970.535	C10		
All engines											1.499.013	
ENGINE												
1.6 LPG	Petrol/ Liquified Petro- leum Gas (LPG)	79	06/06-12/12	M16A								
Engine	Information			A10	A20	A40	A50	A70	C10 - C30	C20	E01	
All engines	Fitting Position:for cylinder 2, Fitting Position:for cylinder 4, ->ch. JSAGYB21500300000, ->ch. JSAGYC21500300000, x 2, SEMI-DIRECT								1.970.535	C10		
ENGINE												
1.6 VVT	Petrol	79	06/06->	M16A								
Engine	Information			A10	A20	A40	A50	A70	C10 - C30	C20	E01	
All engines	Fitting Position:for cylinder 2, Fitting Position:for cylinder 4, ->ch. JSAGYB41500300000, x 2, SEMI-DIRECT								1.970.535	C10		
All engines	Fitting Position:for cylinder 2, Fitting Position:for cylinder 4, ->ch. TSMYB21500450000, ->ch. TSMYB21500460000, ->ch. TSMYB21500470000, ->ch. TSMYB21500490000, ->ch. TSMYB21500510000, ->ch. TSMYB21500530000, ->ch. TSMYB21500560000, ->ch. TSMYB21500630000, ->ch. TSMYB21500680000, MADE BY: (H), x 2, SEMI-DIRECT								1.970.570	C10		
All engines	version TYPE 1, 2										1.499.013	
ENGINE												
1.6 VVT	Petrol	82	11/10-12/15	M16A								
Engine	Information			A10	A20	A40	A50	A70	C10 - C30	C20	E01	
All engines	Fitting Position:for cylinder 2, Fitting Position:for cylinder 4, ->ch. JSAGYB41500300000, x 2, SEMI-DIRECT								1.970.535	C10		
All engines	Fitting Position:for cylinder 2, Fitting Position:for cylinder 4, ->ch. TSMYB21500450000, ->ch. TSMYB21500460000, ->ch. TSMYB21500470000, ->ch. TSMYB21500490000, ->ch. TSMYB21500510000, ->ch. TSMYB21500530000, ->ch. TSMYB21500560000, ->ch. TSMYB21500630000, ->ch. TSMYB21500680000, MADE BY: (H), x 2, SEMI-DIRECT								1.970.570	C10		
ENGINE												
1.6 VVT	Petrol	88	07/09->	M16A								
Engine	Information			A10	A20	A40	A50	A70	C10 - C30	C20	E01	
All engines	Fitting Position:for cylinder 2, Fitting Position:for cylinder 4, ->ch. JSAGYB41500300000, x 2, SEMI-DIRECT								1.970.535	C10		
All engines	Fitting Position:for cylinder 2, Fitting Position:for cylinder 4, ->ch. TSMYB21500450000, ->ch. TSMYB21500460000, ->ch. TSMYB21500470000, ->ch. TSMYB21500490000, ->ch. TSMYB21500510000, ->ch. TSMYB21500530000, ->ch. TSMYB21500560000, ->ch. TSMYB21500630000, ->ch. TSMYB21500680000, MADE BY: (H), x 2, SEMI-DIRECT								1.970.570	C10		
All engines	version TYPE 1, 2										1.499.013	

A10 CONDENSER	A20 CONTACT SET	A40 DISTRIBUTOR CAP	A50 ROTOR	A70 PICK-UP
C10 COIL	C20 IGNITION MODULE	C30 ELECTRONIC IGNITION KIT	E01 IGNITION CABLE SET	

The present application list is a brief version. For the detailed information about the possibility of installation on a specific vehicle, please refer to our web-catalogue <http://catalogo.facet.eu/>

Vehicle	alim.	kW	Date	Engine	FUNCTIONS ON THE VEHICLE							
					A10	A20	A40	A50	A70	C10 - C30	C20	E01

ENGINE				
1.6 VVT 4x4	Petrol	79	06/06->	M16A

Engine	Information	A10	A20	A40	A50	A70	C10 - C30	C20	E01
All engines	Fitting Position:for cylinder 2, Fitting Position:for cylinder 4, ->ch. JSAGYB41500300000, x 2, SEMI-DIRECT						1.970.535	C10	
All engines	Fitting Position:for cylinder 2, Fitting Position:for cylinder 4, ->ch. TSMYB21500450000, ->ch. TSMYB21500460000, ->ch. TSMYB21500470000, ->ch. TSMYB21500490000, ->ch. TSMYB21500510000, ->ch. TSMYB21500530000, ->ch. TSMYB21500560000, ->ch. TSMYB21500630000, ->ch. TSMYB21500680000, MADE BY: (H), x 2, SEMI-DIRECT						1.970.570	C10	
All engines	version TYPE 1, 2								1.499.013

ENGINE				
1.6 VVT 4x4	Petrol	82	07/09->	M16A

Engine	Information	A10	A20	A40	A50	A70	C10 - C30	C20	E01
All engines	Fitting Position:for cylinder 2, Fitting Position:for cylinder 4, ->ch. JSAGYB41500300000, x 2, SEMI-DIRECT						1.970.535	C10	
All engines	Fitting Position:for cylinder 2, Fitting Position:for cylinder 4, ->ch. TSMYB21500450000, ->ch. TSMYB21500460000, ->ch. TSMYB21500470000, ->ch. TSMYB21500490000, ->ch. TSMYB21500510000, ->ch. TSMYB21500530000, ->ch. TSMYB21500560000, ->ch. TSMYB21500630000, ->ch. TSMYB21500680000, MADE BY: (H), x 2, SEMI-DIRECT						1.970.570	C10	
All engines	version TYPE 1, 2								1.499.013

ENGINE				
1.6 VVT 4x4	Petrol	88	07/09->	M16A

Engine	Information	A10	A20	A40	A50	A70	C10 - C30	C20	E01
All engines	Fitting Position:for cylinder 2, Fitting Position:for cylinder 4, ->ch. JSAGYB41500300000, x 2, SEMI-DIRECT						1.970.535	C10	
All engines	Fitting Position:for cylinder 2, Fitting Position:for cylinder 4, ->ch. TSMYB21500450000, ->ch. TSMYB21500460000, ->ch. TSMYB21500470000, ->ch. TSMYB21500490000, ->ch. TSMYB21500510000, ->ch. TSMYB21500530000, ->ch. TSMYB21500560000, ->ch. TSMYB21500630000, ->ch. TSMYB21500680000, MADE BY: (H), x 2, SEMI-DIRECT						1.970.570	C10	
All engines	version TYPE 1, 2								1.499.013

SX4 II				
--------	--	--	--	--

ENGINE				
1.0	Petrol	82	08/16->	K10C

Engine	Information	A10	A20	A40	A50	A70	C10 - C30	C20	E01
All engines	x 3, COIL ON PLUG						1.970.621	C10	

ENGINE				
1.0 AllGrip	Petrol	82	08/16->	K10C

Engine	Information	A10	A20	A40	A50	A70	C10 - C30	C20	E01
All engines	x 3, COIL ON PLUG						1.970.621	C10	

ENGINE				
1.4 T	Petrol	103	08/16->	K14C

Engine	Information	A10	A20	A40	A50	A70	C10 - C30	C20	E01
All engines	x 4, COIL ON PLUG						1.970.621	C10	

ENGINE				
1.4 T AllGrip	Petrol	103	08/16->	K14C

Engine	Information	A10	A20	A40	A50	A70	C10 - C30	C20	E01
All engines	x 4, COIL ON PLUG						1.970.621	C10	

VITARA I				
----------	--	--	--	--

ENGINE				
1.6	Petrol	55	01/90-12/93	G16A (8V)

Engine	Information	A10	A20	A40	A50	A70	C10 - C30	C20	E01
All engines	version Denso			1.313.123					
All engines							1.970.201	C10	1.499.004









ENGINE				
1.6	Petrol	59	07/88-01/95	G16A (8V)

Engine	Information	A10	A20	A40	A50	A70	C10 - C30	C20	E01
All engines	version Denso			1.313.123					
All engines							1.970.201	C10	1.499.004

ENGINE				
1.6	Petrol	70	02/91-03/98	G16B

Engine	Information	A10	A20	A40	A50	A70	C10 - C30	C20	E01
All engines	version Denso			1.313.123					

A10	CONDENSER	A20	CONTACT SET	A40	DISTRIBUTOR CAP	A50	ROTOR	A70	PICK-UP
C10	COIL	C20	IGNITION MODULE	C30	ELECTRONIC IGNITION KIT	E01	IGNITION CABLE SET		

				FUNCTIONS ON THE VEHICLE								
Vehicle	alim.	kW	Date	Engine	 A10	 A20	 A40	 A50	 A70	 C10 - C30	 C20	 E01
WAGON R II												
1.0	Petrol	48	02/98-05/00	ENGINE K10A								
Engine	Information											
All engines	version Hitachi						1.422.073					
All engines												1.499.028
1.2	Petrol	51	02/98-05/00	ENGINE K12A								
Engine	Information											
All engines	version Hitachi						1.422.073					
All engines												1.499.028
1.2 4WD	Petrol	51	02/98-05/00	ENGINE K12A								
Engine	Information											
All engines	version Hitachi						1.422.073					
All engines												1.499.028
1.3	Petrol	56	04/99-10/00	ENGINE G13BB								
Engine	Information											
All engines	->ch. 157570, x 2, SEMI-DIRECT									1.970.535	C10	
All engines	ch. 157571 ->, x 2, SEMI-DIRECT									1.970.570	C10	
WAGON R III												
1.0	Petrol	44	06/04-08/05	ENGINE Z 10 XEP								
Engine	Information											
All engines	version Denso					1.313.245	1.413.034					
1.3	Petrol	65	09/03-12/10	ENGINE M13A								
Engine	Information											
All engines	x 2, SEMI-DIRECT									1.970.570	C10	
WAGON R+ II												
1.0	Petrol	51	08/00-07/03	ENGINE K10A								
Engine	Information											
All engines	version Denso					1.313.245	1.413.034					
1.0 XT Plus	Petrol	74	08/00-07/01	ENGINE --								
Engine	Information											
All engines	version Denso					1.313.245	1.413.034					
1.3	Petrol	56	05/00-12/04	ENGINE G13BB								
Engine	Information											
All engines	->ch. 157570, x 2, SEMI-DIRECT									1.970.535	C10	
All engines	ch. 157571 ->, x 2, SEMI-DIRECT									1.970.570	C10	
All engines												1.499.005
1.3	Petrol	65	08/01->	ENGINE M13A								
Engine	Information											
All engines	Qty: 2									1.970.535	C10	
All engines												1.499.005
1.3	Petrol	69	09/03->	ENGINE M13A								
Engine	Information											
All engines	x 2, SEMI-DIRECT									1.970.570	C10	
All engines												1.499.013
1.3 4WD	Petrol	56	10/01->	ENGINE G13BB								
Engine	Information											
All engines	x 2, SEMI-DIRECT									1.970.570	C10	
All engines												1.499.005

A10 CONDENSER	A20 CONTACT SET	A40 DISTRIBUTOR CAP	A50 ROTOR	A70 PICK-UP
C10 COIL	C20 IGNITION MODULE	C30 ELECTRONIC IGNITION KIT	E01 IGNITION CABLE SET	

Vehicle	alim.	kW	Date	Engine	FUNCTIONS ON THE VEHICLE							
					A10	A20	A40	A50	A70	C10 - C30	C20	E01
1.3 4WD												
Petrol 69 09/03->												
ENGINE												
M13A												
Engine	Information				A10	A20	A40	A50	A70	C10 - C30	C20	E01
All engines	x 2, SEMI-DIRECT									1.970.570	C10	
All engines												1.499.013
X-90												
1.6 i 16V												
Petrol 71 09/95-12/97												
ENGINE												
G16B												
Engine	Information				A10	A20	A40	A50	A70	C10 - C30	C20	E01
All engines	version Denso							1.431.136				
1.6 i 16V 4x4												
Petrol 71 09/95-12/97												
ENGINE												
G16B												
Engine	Information				A10	A20	A40	A50	A70	C10 - C30	C20	E01
All engines	version Denso							1.431.136				

A10	CONDENSER	A20	CONTACT SET	A40	DISTRIBUTOR CAP	A50	ROTOR	A70	PICK-UP
C10	COIL	C20	IGNITION MODULE	C30	ELECTRONIC IGNITION KIT	E01	IGNITION CABLE SET		

The present application list is a brief version. For the detailed information about the possibility of installation on a specific vehicle, please refer to our web-catalogue <http://catalogo.facet.eu/>

Vehicle	alim.	kW	Date	Engine	FUNCTIONS ON THE VEHICLE							
					A10	A20	A40	A50	A70	C10 - C30	C20	E01

1307-1510

				ENGINE
Simca 1307 1.3	Petrol	44	09/75-01/80	--

Engine	Information	A10	A20	A40	A50	A70	C10 - C30	C20	E01
All engines	version Bosch			1.306.079	1.406.025R				

				ENGINE
Simca 1307 1.3	Petrol	50	07/75-01/80	--

Engine	Information	A10	A20	A40	A50	A70	C10 - C30	C20	E01
All engines	version Bosch			1.306.079	1.406.025R				
All engines	version Ducellier			1.315.054	1.415.091				

AVENGER

				ENGINE
1.3	Petrol	44	02/70-07/81	--

Engine	Information	A10	A20	A40	A50	A70	C10 - C30	C20	E01
All engines				1.328.075	1.412.090, 1.428.006				

				ENGINE
1.6	Petrol	51	02/70-07/81	--

Engine	Information	A10	A20	A40	A50	A70	C10 - C30	C20	E01
All engines				1.328.075	1.412.090, 1.428.006				

				ENGINE
1.6	Petrol	59	02/70-07/81	--

Engine	Information	A10	A20	A40	A50	A70	C10 - C30	C20	E01
All engines				1.328.075	1.412.090, 1.428.006				

MATRA BAGHEERA

				ENGINE
1.3	Petrol	62	01/74-03/78	3G4

Engine	Information	A10	A20	A40	A50	A70	C10 - C30	C20	E01
All engines			1.215.111U						

SAMBA

				ENGINE
1.1	Petrol	37	01/81-06/86	XW7

Engine	Information	A10	A20	A40	A50	A70	C10 - C30	C20	E01
All engines	version Ducellier	1.115.034	1.215.103	1.315.058	1.415.088				

SOLARA

				ENGINE
1.3	Petrol	40	02/80-07/86	2M 102.979

Engine	Information	A10	A20	A40	A50	A70	C10 - C30	C20	E01
All engines	version Bosch			1.306.079	1.406.025R				
All engines	version Ducellier			1.315.054	1.415.094				

TAGORA

				ENGINE
2.1	Petrol	85	06/80-12/83	5N2

Engine	Information	A10	A20	A40	A50	A70	C10 - C30	C20	E01
All engines	version Bosch			1.306.079	1.406.061R	1.906.153			
All engines	version Ducellier			1.315.054	1.415.094				
All engines							1.970.101D	C10	

				ENGINE
2.6	Petrol	122	08/81-10/83	9L6









Engine	Information	A10	A20	A40	A50	A70	C10 - C30	C20	E01
All engines	version Bosch				1.406.049R				

A10 CONDENSER	A20 CONTACT SET	A40 DISTRIBUTOR CAP	A50 ROTOR	A70 PICK-UP
C10 COIL	C20 IGNITION MODULE	C30 ELECTRONIC IGNITION KIT	E01 IGNITION CABLE SET	

Vehicle	alim.	kW	Date	Engine	FUNCTIONS ON THE VEHICLE									
					A10	A20	A40	A50	A70	C10 - C30	C20	E01		
4 RUNNER														
2.4	Petrol	84	08/88-11/95	22RE										
Engine		Information			A10	A20	A40	A50	A70	C10 - C30	C20	E01		
All engines		01/08/92 ->								1.970.203	C10			
2.4 i [USA]														
2.4 i [USA]	Petrol	0	01/88-12/93	22RE										
Engine		Information			A10	A20	A40	A50	A70	C10 - C30	C20	E01		
All engines		->year 01/12/92, version Denso					1.313.099							
All engines		01/12/92 ->, version Denso					1.313.273							
All engines		01/01/92 ->								1.970.203	C10			
2.7 16V														
2.7 16V	Petrol	110	11/95-08/00	3RZ-FE										
Engine		Information			A10	A20	A40	A50	A70	C10 - C30	C20	E01		
All engines		01/08/96 ->										1.501.792		
2.7 4WD														
2.7 4WD	Petrol	112	11/95-08/02	3RZ-FE										
Engine		Information			A10	A20	A40	A50	A70	C10 - C30	C20	E01		
All engines		->year 01/08/96, x 1, DISTRIBUTOR								1.970.198	C10			
2.7 i														
2.7 i	Petrol	112	11/95-03/96	3RZ-FE										
Engine		Information			A10	A20	A40	A50	A70	C10 - C30	C20	E01		
All engines		01/08/96 ->										1.501.792		
3.0														
3.0	Petrol	105	08/88-11/95	3VZ-E										
Engine		Information			A10	A20	A40	A50	A70	C10 - C30	C20	E01		
All engines		01/08/91 ->, version Denso					1.313.272							
All engines		->year 01/08/91								1.970.202	C10			
All engines		01/08/91 ->								1.970.203	C10			
3.0														
3.0	Petrol	112	08/88-10/95	3VZ-E										
Engine		Information			A10	A20	A40	A50	A70	C10 - C30	C20	E01		
All engines		01/08/91 ->, version Denso					1.313.272							
All engines		->year 01/08/91								1.970.202	C10			
All engines		01/08/91 ->								1.970.203	C10			
3.0 [USA]														
3.0 [USA]	Petrol	0	01/88-12/91	3VZ-E										
Engine		Information			A10	A20	A40	A50	A70	C10 - C30	C20	E01		
All engines		->year 01/08/91								1.970.202	C10			
All engines		01/08/91 ->								1.970.203	C10			
AQUA														
1.5 Hybrid	Petrol/ Electric	54	12/11->	1NZ-FXE										
Engine		Information			A10	A20	A40	A50	A70	C10 - C30	C20	E01		
All engines		Qty: 4								1.970.459	C10			
AURION														
3.5	Petrol	200	03/06->	2GR-FE										
Engine		Information			A10	A20	A40	A50	A70	C10 - C30	C20	E01		
All engines		x 6, COIL ON PLUG								1.970.538	C10			
AURIS I														
1.33 Dual-VTi	Petrol	73	01/10-09/12	1NR-FE										
Engine		Information			A10	A20	A40	A50	A70	C10 - C30	C20	E01		
All engines		x 4, COIL ON PLUG								1.970.537	C10			
1.33 Dual-VTi														
1.33 Dual-VTi	Petrol	74	05/09-09/12	1NR-FE										
Engine		Information			A10	A20	A40	A50	A70	C10 - C30	C20	E01		
All engines		x 4, COIL ON PLUG								1.970.537	C10			

A10	CONDENSER	A20	CONTACT SET	A40	DISTRIBUTOR CAP	A50	ROTOR	A70	PICK-UP
C10	COIL	C20	IGNITION MODULE	C30	ELECTRONIC IGNITION KIT	E01	IGNITION CABLE SET		

The present application list is a brief version. For the detailed information about the possibility of installation on a specific vehicle, please refer to our web-catalogue <http://catalogo.facet.eu/>









					FUNCTIONS ON THE VEHICLE							
Vehicle	alim.	kW	Date	Engine								
ENGINE												
1.4	Petrol	71	03/07-09/12	85HFC4GB								
ENGINE												
Engine	Information				A10	A20	A40	A50	A70	C10 - C30	C20	E01
All engines	x 4, COIL ON PLUG									1.970.461	C10	
ENGINE												
1.6	Petrol	91	03/07-09/12	1ZR-FE								
ENGINE												
Engine	Information				A10	A20	A40	A50	A70	C10 - C30	C20	E01
All engines	x 4, COIL ON PLUG									1.970.536	C10	
ENGINE												
1.6	Petrol	97	05/09-09/12	1ZR-FAE, 1ZR-FE								
ENGINE												
Engine	Information				A10	A20	A40	A50	A70	C10 - C30	C20	E01
Eng. 1ZR-FAE	x 4, COIL ON PLUG									1.970.536	C10	
Eng. 1ZR-FE	Qty: 4									1.970.536	C10	
ENGINE												
1.8	Petrol	100	10/06-09/12	2ZR-FAE, 2ZR-FE								
ENGINE												
Engine	Information				A10	A20	A40	A50	A70	C10 - C30	C20	E01
Eng. 2ZR-FAE	Qty: 4									1.970.536	C10	
Eng. 2ZR-FE	x 4, COIL ON PLUG									1.970.536	C10	
ENGINE												
1.8	Petrol	106	02/09-09/12	2ZR-FAE								
ENGINE												
Engine	Information				A10	A20	A40	A50	A70	C10 - C30	C20	E01
All engines	Qty: 4									1.970.536	C10	
ENGINE												
1.8	Petrol	108	02/09-09/12	2ZR-FAE								
ENGINE												
Engine	Information				A10	A20	A40	A50	A70	C10 - C30	C20	E01
All engines	x 4, COIL ON PLUG									1.970.536	C10	
ENGINE												
1.8 4WD	Petrol	100	10/06-10/09	2ZR-FAE								
ENGINE												
Engine	Information				A10	A20	A40	A50	A70	C10 - C30	C20	E01
All engines	Qty: 4									1.970.536	C10	
ENGINE												
1.8 Hybrid	Petrol/ Electric	73	09/10-09/12	2ZR-FXE								
ENGINE												
Engine	Information				A10	A20	A40	A50	A70	C10 - C30	C20	E01
All engines	x 4, COIL ON PLUG									1.970.536	C10	
AURIS II												
ENGINE												
1.2	Petrol	85	03/15-12/18	8NR-FTS								
ENGINE												
Engine	Information				A10	A20	A40	A50	A70	C10 - C30	C20	E01
All engines	x 4, COIL ON PLUG									1.970.645	C10	
ENGINE												
1.3	Petrol	73	10/12-12/18	1NR-FE								
ENGINE												
Engine	Information				A10	A20	A40	A50	A70	C10 - C30	C20	E01
All engines	x 4, COIL ON PLUG									1.970.537	C10	
ENGINE												
1.6	Petrol	97	10/12-12/18	1ZR-FAE								
ENGINE												
Engine	Information				A10	A20	A40	A50	A70	C10 - C30	C20	E01
All engines	x 4, COIL ON PLUG									1.970.536	C10	
ENGINE												
1.8 Hybrid	Petrol/ Electric	73	10/12-12/18	2ZR-FXE								
ENGINE												
Engine	Information				A10	A20	A40	A50	A70	C10 - C30	C20	E01
All engines	x 4, COIL ON PLUG									1.970.536	C10	
AVENSIS I												
ENGINE												
1.6	Petrol	74	09/97-10/00	4A-FE								
ENGINE												
Engine	Information				A10	A20	A40	A50	A70	C10 - C30	C20	E01
All engines	version Bosch						1.306.094	1.406.121R				
All engines	version Denso						1.313.265	1.413.029				
All engines	LHD, Terra, -oil cooler											1.501.209
All engines	LHD											1.501.879

A10 CONDENSER	A20 CONTACT SET	A40 DISTRIBUTOR CAP	A50 ROTOR	A70 PICK-UP
C10 COIL	C20 IGNITION MODULE	C30 ELECTRONIC IGNITION KIT	E01 IGNITION CABLE SET	

Vehicle	alim.	kW	Date	Engine	FUNCTIONS ON THE VEHICLE									
					A10	A20	A40	A50	A70	C10 - C30	C20	E01		
ENGINE														
1.6	Petrol	81	09/97-02/03	3ZZ-FE, 4A-FE										
Engine	Information													
Eng. 4A-FE	version Bosch					1.306.094	1.406.121R							
Eng. 4A-FE	version Denso					1.313.265	1.413.029							
Eng. 3ZZ-FE	x 4, COIL ON PLUG								1.970.461	C10				
Eng. 4A-FE	LHD, Terra, -oil cooler												1.501.209	
Eng. 4A-FE	LHD												1.501.879	
ENGINE														
1.6 VVT-i	Petrol	81	10/00-02/03	3ZZ-FE										
Engine	Information													
All engines	x 4, COIL ON PLUG								1.970.461	C10				
ENGINE														
1.8	Petrol	95	10/00-02/03	1ZZFE										
Engine	Information													
All engines	x 4, COIL ON PLUG								1.970.461	C10				
ENGINE														
1.8 VVT-i	Petrol	95	10/00-02/03	1ZZFE										
Engine	Information													
All engines	x 4, COIL ON PLUG								1.970.461	C10				
ENGINE														
2.0	Petrol	110	10/00-02/03	1AZ-FSE										
Engine	Information													
All engines	x 4, COIL ON PLUG, FOR: (J)								1.970.458	C10				
ENGINE														
2.0	Petrol	94	09/97-10/00	3S-FE										
Engine	Information													
All engines													1.501.856	
ENGINE														
2.0 VVT-i	Petrol	110	10/00-02/03	1AZ-FSE										
Engine	Information													
All engines	x 4, COIL ON PLUG, FOR: (J)								1.970.458	C10				
AVENSIS II														
ENGINE														
1.6 VVT-i	Petrol	81	04/03-11/08	3ZZ-FE										
Engine	Information													
All engines	x 4, COIL ON PLUG								1.970.461	C10				
ENGINE														
1.8	Petrol	95	03/03-11/08	1ZZFE										
Engine	Information													
All engines	x 4, COIL ON PLUG								1.970.461	C10				
ENGINE														
2.0	Petrol	108	03/03-11/08	1AZ-FSE										
Engine	Information													
All engines	x 4, COIL ON PLUG, FOR: (J)								1.970.458	C10				
ENGINE														
2.0	Petrol	110	08/01-11/09	1AZ-FE										
Engine	Information													
All engines	x 4, COIL ON PLUG, FOR: (J)								1.970.466	C10				
ENGINE														
2.0 VVTi	Petrol	114	01/03-11/08	1AZ-FE, 1AZ-FSE										
Engine	Information													
Eng. 1AZ-FE	01/09/05 ->, Qty: 4								1.970.458	C10				
Eng. 1AZ-FSE	x 4, COIL ON PLUG, x 4, COIL ON PLUG, FOR: (J), FOR: (J)								1.970.458	C10				
Eng. 1AZ-FE	->year 01/09/05, Qty: 4								1.970.466	C10				
Eng. 1AZ-FE	x 4, COIL ON PLUG, FOR: (J)								1.970.466	C10				
ENGINE														
2.4	Petrol	115	08/01-08/07	2AZ-FE										
Engine	Information													
All engines	Qty: 4								1.970.466	C10				

A10	CONDENSER	A20	CONTACT SET	A40	DISTRIBUTOR CAP	A50	ROTOR	A70	PICK-UP
C10	COIL	C20	IGNITION MODULE	C30	ELECTRONIC IGNITION KIT	E01	IGNITION CABLE SET		

The present application list is a brief version. For the detailed information about the possibility of installation on a specific vehicle, please refer to our web-catalogue <http://catalogo.facet.eu/>









					FUNCTIONS ON THE VEHICLE							
Vehicle	alim.	kW	Date	Engine								
ENGINE												
2.4	Petrol	120	10/03-10/08	2AZ-FSE								
Engine Information					A10	A20	A40	A50	A70	C10 - C30	C20	E01
All engines x 4, COIL ON PLUG, FOR: (J)										1.970.458	C10	
ENGINE												
2.4	Petrol	125	09/03-11/08	2AZ-FSE								
Engine Information					A10	A20	A40	A50	A70	C10 - C30	C20	E01
All engines x 4, COIL ON PLUG, FOR: (J)										1.970.458	C10	
ENGINE												
2.4 4WD	Petrol	115	11/03-08/06	2AZ-FE								
Engine Information					A10	A20	A40	A50	A70	C10 - C30	C20	E01
All engines Qty: 4										1.970.466	C10	
AVENSIS III												
ENGINE												
1.6	Petrol	97	11/08-10/18	1ZR-FAE								
Engine Information					A10	A20	A40	A50	A70	C10 - C30	C20	E01
All engines x 4, COIL ON PLUG										1.970.536	C10	
ENGINE												
1.8	Petrol	108	11/08-10/18	2ZR-FAE								
Engine Information					A10	A20	A40	A50	A70	C10 - C30	C20	E01
All engines x 4, COIL ON PLUG										1.970.536	C10	
ENGINE												
2.0	Petrol	100	11/08-04/11	1AZ-FE								
Engine Information					A10	A20	A40	A50	A70	C10 - C30	C20	E01
All engines Qty: 4										1.970.466	C10	
ENGINE												
2.0	Petrol	112	11/08-10/18	3ZR-FAE, 3ZR-FE								
Engine Information					A10	A20	A40	A50	A70	C10 - C30	C20	E01
All engines x 4, COIL ON PLUG										1.970.536	C10	
AYGO I												
ENGINE												
1.0	Petrol	50	07/05-05/14	1KR-FE								
Engine Information					A10	A20	A40	A50	A70	C10 - C30	C20	E01
All engines x 3, COIL ON PLUG										1.970.461	C10	
ENGINE												
1.0 GPL	Petrol/ Liquified Petro- leum Gas (LPG)	50	07/05-05/14	1KR-FE								
Engine Information					A10	A20	A40	A50	A70	C10 - C30	C20	E01
All engines x 3, COIL ON PLUG										1.970.461	C10	
ENGINE												
1.0 VVTi	Petrol	50	07/05-05/14	1KR-FE								
Engine Information					A10	A20	A40	A50	A70	C10 - C30	C20	E01
All engines x 3, COIL ON PLUG										1.970.461	C10	
AYGO II												
ENGINE												
1.0	Petrol	51	05/14->	1KR-FE								
Engine Information					A10	A20	A40	A50	A70	C10 - C30	C20	E01
All engines x 3, COIL ON PLUG, FOR: (J)										1.970.459	C10	
ENGINE												
1.0 VVTi	Petrol	53	03/18->	1KR-FE								
Engine Information					A10	A20	A40	A50	A70	C10 - C30	C20	E01
All engines x 3, COIL ON PLUG, FOR: (J)										1.970.459	C10	
ENGINE												
1.2	Petrol	60	05/14->	1PP								
Engine Information					A10	A20	A40	A50	A70	C10 - C30	C20	E01
All engines x 3, COIL ON PLUG										1.970.609	C10	

A10 CONDENSER	A20 CONTACT SET	A40 DISTRIBUTOR CAP	A50 ROTOR	A70 PICK-UP
C10 COIL	C20 IGNITION MODULE	C30 ELECTRONIC IGNITION KIT	E01 IGNITION CABLE SET	

Vehicle	alim.	kW	Date	Engine	FUNCTIONS ON THE VEHICLE									
					A10	A20	A40	A50	A70	C10 - C30	C20	E01		
CAMRY														
1.8	Petrol	66	11/86-08/89	1S										
Engine		Information			A10	A20	A40	A50	A70	C10 - C30	C20	E01		
All engines		01/08/87 ->, version Denso						1.413.027						
2.0	Petrol	108	05/06-09/11	1AZ-FE										
Engine		Information			A10	A20	A40	A50	A70	C10 - C30	C20	E01		
All engines		x 4, version 1, x 4, COIL ON PLUG, version 2, COIL ON PLUG, FOR: (J)								1.970.458	C10			
2.0	Petrol	109	09/11->	1AZ-FE										
Engine		Information			A10	A20	A40	A50	A70	C10 - C30	C20	E01		
All engines		Qty: 4								1.970.458	C10			
All engines		x 4, COIL ON PLUG, FOR: (J)								1.970.458	C10			
2.0	Petrol	110	08/01->	1AZ-FE, 6ARFSE										
Engine		Information			A10	A20	A40	A50	A70	C10 - C30	C20	E01		
Eng. 1AZ-FE		x 4, COIL ON PLUG, FOR: (J)								1.970.466	C10			
Eng. 6ARFSE		x 4, COIL ON PLUG, FOR: (J)								1.970.537	C10			
2.0	Petrol	123	12/14->	6ARFSE										
Engine		Information			A10	A20	A40	A50	A70	C10 - C30	C20	E01		
All engines		Qty: 4								1.970.537	C10			
2.0	Petrol	88	03/83-07/88	3S-FE										
Engine		Information			A10	A20	A40	A50	A70	C10 - C30	C20	E01		
All engines		version Denso						1.413.029						
All engines										1.970.197	C10			
2.0	Petrol	89	11/86-02/93	3S-FE										
Engine		Information			A10	A20	A40	A50	A70	C10 - C30	C20	E01		
All engines		version Denso						1.413.029						
All engines										1.970.197	C10			
2.0	Petrol	93	09/89-06/91	3S-FE										
Engine		Information			A10	A20	A40	A50	A70	C10 - C30	C20	E01		
All engines		version Denso						1.413.029						
All engines										1.970.197	C10			
2.0	Petrol	94	11/86-05/91	3S-FE										
Engine		Information			A10	A20	A40	A50	A70	C10 - C30	C20	E01		
All engines		version Denso						1.413.029						
All engines										1.970.197	C10			
2.0 4WD	Petrol	88	03/83-06/91	3S-FE										
Engine		Information			A10	A20	A40	A50	A70	C10 - C30	C20	E01		
All engines		version Denso						1.413.029						
All engines										1.970.197	C10			
2.0 4WD	Petrol	94	08/88-05/91	3S-FE										
Engine		Information			A10	A20	A40	A50	A70	C10 - C30	C20	E01		
All engines		version Denso						1.413.029						
All engines										1.970.197	C10			
2.2	Petrol	100	06/91-07/96	5S-FE										
Engine		Information			A10	A20	A40	A50	A70	C10 - C30	C20	E01		
All engines		01/08/93 ->, version Denso					1.313.267							
All engines		version Denso						1.413.029						
All engines										1.970.198	C10			
All engines		01/08/93 ->											1.501.793	

A10 CONDENSER	A20 CONTACT SET	A40 DISTRIBUTOR CAP	A50 ROTOR	A70 PICK-UP
C10 COIL	C20 IGNITION MODULE	C30 ELECTRONIC IGNITION KIT	E01 IGNITION CABLE SET	

The present application list is a brief version. For the detailed information about the possibility of installation on a specific vehicle, please refer to our web-catalogue <http://catalogo.facet.eu/>

					FUNCTIONS ON THE VEHICLE							
Vehicle	alim.	kW	Date	Engine								
ENGINE												
2.2	Petrol	93	02/93-09/02	5S-FE								
ENGINE												
Engine	Information				A10	A20	A40	A50	A70	C10 - C30	C20	E01
All engines	01/08/93 ->, version Denso						1.313.267					
All engines	version Denso							1.413.029				
All engines										1.970.198	C10	1.501.856
All engines	01/08/93 ->											1.501.793
ENGINE												
2.2	Petrol	96	08/96-11/01	5S-FE								
ENGINE												
Engine	Information				A10	A20	A40	A50	A70	C10 - C30	C20	E01
All engines												1.501.856
ENGINE												
2.2	Petrol	98	08/99->	5S-FNE								
ENGINE												
Engine	Information				A10	A20	A40	A50	A70	C10 - C30	C20	E01
All engines												1.501.856
ENGINE												
2.4	Petrol	112	11/01-11/06	2AZ-FE								
ENGINE												
Engine	Information				A10	A20	A40	A50	A70	C10 - C30	C20	E01
All engines	x 4, COIL ON PLUG, FOR: (J)									1.970.466	C10	
ENGINE												
2.4	Petrol	116	01/06-09/11	2AZ-FE								
ENGINE												
Engine	Information				A10	A20	A40	A50	A70	C10 - C30	C20	E01
All engines	->year 01/03/09, x 4, COIL ON PLUG, x 4, COIL ON PLUG, FOR: (J)									1.970.458	C10	
All engines	01/04/09 ->, x 4, COIL ON PLUG, FOR: (J)									1.970.466	C10	
ENGINE												
2.4	Petrol	117	09/01-01/06	2AZ-FE								
ENGINE												
Engine	Information				A10	A20	A40	A50	A70	C10 - C30	C20	E01
All engines	01/09/05 ->, Qty: 4									1.970.458	C10	
All engines	->year 01/09/05, Qty: 4									1.970.466	C10	
ENGINE												
2.4	Petrol	120	01/02-11/06	2AZ-FE								
ENGINE												
Engine	Information				A10	A20	A40	A50	A70	C10 - C30	C20	E01
All engines	01/09/05 ->, Qty: 4									1.970.458	C10	
All engines	->year 01/09/05, Qty: 4									1.970.466	C10	
ENGINE												
2.4	Petrol	123	01/06-09/11	2AZ-FE								
ENGINE												
Engine	Information				A10	A20	A40	A50	A70	C10 - C30	C20	E01
All engines	->year 01/03/09, x 4, COIL ON PLUG, x 4, COIL ON PLUG, FOR: (J)									1.970.458	C10	
All engines	01/04/09 ->, x 4, COIL ON PLUG, FOR: (J)									1.970.466	C10	
ENGINE												
2.4	Petrol	127	01/06-09/11	2AZ-FE								
ENGINE												
Engine	Information				A10	A20	A40	A50	A70	C10 - C30	C20	E01
All engines	->year 01/03/09, x 4, COIL ON PLUG, x 4, COIL ON PLUG, FOR: (J)									1.970.458	C10	
All engines	01/04/09 ->, x 4, COIL ON PLUG, FOR: (J)									1.970.466	C10	
ENGINE												
2.4 [CHN]	Petrol/ Electric	0	03/10->	3AZ-FXE								
ENGINE												
Engine	Information				A10	A20	A40	A50	A70	C10 - C30	C20	E01
All engines	Qty: 4									1.970.458	C10	
ENGINE												
2.4 Hybrid	Petrol/ Electric	105	03/06-07/11	2AZ-FXE								
ENGINE												
Engine	Information				A10	A20	A40	A50	A70	C10 - C30	C20	E01
All engines	FOR: (USA), Qty: 4, no specific info conc. application available									1.970.458	C10	
All engines	NOT FOR: (USA), Qty: 4, no specific info conc. application available									1.970.466	C10	
ENGINE												
2.4 Hybrid	Petrol/ Electric	110	01/06-09/11	2AZ-FXE								
ENGINE												
Engine	Information				A10	A20	A40	A50	A70	C10 - C30	C20	E01
All engines	FOR: (USA), Qty: 4, no specific info conc. application available									1.970.458	C10	

A10 CONDENSER	A20 CONTACT SET	A40 DISTRIBUTOR CAP	A50 ROTOR	A70 PICK-UP
C10 COIL	C20 IGNITION MODULE	C30 ELECTRONIC IGNITION KIT	E01 IGNITION CABLE SET	

Vehicle	alim.	kW	Date	Engine	FUNCTIONS ON THE VEHICLE									
					A10	A20	A40	A50	A70	C10 - C30	C20	E01		
ENGINE														
2.4 Hybrid	Petrol/ Electric	110	01/06-09/11	2AZ-FXE										
Engine	Information				A10	A20	A40	A50	A70	C10 - C30	C20	E01		
All engines	NOT FOR: (USA), Qty: 4, no specific info conc. application available									1.970.466	C10			
ENGINE														
2.4 VVTi LE	Petrol	116	01/06-11/06	2AZ-FE										
Engine	Information				A10	A20	A40	A50	A70	C10 - C30	C20	E01		
All engines	Qty: 4									1.970.466	C10			
ENGINE														
2.5	Petrol	118	10/86-06/91	2VZ-FE										
Engine	Information				A10	A20	A40	A50	A70	C10 - C30	C20	E01		
All engines										1.970.202	C10			
ENGINE														
2.5	Petrol	129	01/10-09/11	2AR-FE										
Engine	Information				A10	A20	A40	A50	A70	C10 - C30	C20	E01		
All engines	Qty: 4									1.970.537	C10			
ENGINE														
2.5	Petrol	131	10/11->	2AR-FE										
Engine	Information				A10	A20	A40	A50	A70	C10 - C30	C20	E01		
All engines	x 4, COIL ON PLUG, FOR: (J)									1.970.537	C10			
ENGINE														
2.5	Petrol	133	09/11->	2AR-FE										
Engine	Information				A10	A20	A40	A50	A70	C10 - C30	C20	E01		
All engines	MADE BY: (USA), x 4, COIL ON PLUG, x 4, COIL ON PLUG, FOR: (J), FOR: (J)									1.970.537	C10			
ENGINE														
2.5 [CHN]	Petrol	0	12/11->	5AR-FE										
Engine	Information				A10	A20	A40	A50	A70	C10 - C30	C20	E01		
All engines	Qty: 4									1.970.537	C10			
ENGINE														
2.5 Hybrid	Petrol/ Electric	115	09/11->	2AR-FXE										
Engine	Information				A10	A20	A40	A50	A70	C10 - C30	C20	E01		
All engines	Qty: 4									1.970.537	C10			
All engines	x 4, COIL ON PLUG, FOR: (J)									1.970.537	C10			
ENGINE														
2.5 Hybrid	Petrol/ Electric	118	09/11->	2AR-FXE										
Engine	Information				A10	A20	A40	A50	A70	C10 - C30	C20	E01		
All engines	Qty: 4									1.970.537	C10			
ENGINE														
2.5 Hybrid [CHN]	Petrol/ Electric	118	05/12->	4AR-FXE										
Engine	Information				A10	A20	A40	A50	A70	C10 - C30	C20	E01		
All engines	Qty: 4									1.970.537	C10			
ENGINE														
3.5	Petrol	183	12/12->	2GR-FE										
Engine	Information				A10	A20	A40	A50	A70	C10 - C30	C20	E01		
All engines	FOR: (J), FOR: (USA), FOR: (RUS), x 6, COIL ON PLUG, x 6, COIL ON PLUG									1.970.538	C10			
ENGINE														
3.5	Petrol	197	01/06-11/06	2GR-FE										
Engine	Information				A10	A20	A40	A50	A70	C10 - C30	C20	E01		
All engines	Qty: 6									1.970.538	C10			
ENGINE														
3.5	Petrol	200	01/06-12/11	2GR-FE										
Engine	Information				A10	A20	A40	A50	A70	C10 - C30	C20	E01		
All engines	x 6, COIL ON PLUG									1.970.538	C10			
ENGINE														
3.5	Petrol	204	09/06-12/17	2GR-FE										
Engine	Information				A10	A20	A40	A50	A70	C10 - C30	C20	E01		
All engines	MADE BY: (J), MADE BY: (USA), x 6, COIL ON PLUG, x 6, COIL ON PLUG									1.970.538	C10			
A10	CONDENSER		A20	CONTACT SET		A40	DISTRIBUTOR CAP		A50	ROTOR		A70	PICK-UP	
C10	COIL		C20	IGNITION MODULE		C30	ELECTRONIC IGNITION KIT		E01	IGNITION CABLE SET				

					FUNCTIONS ON THE VEHICLE							
Vehicle	alim.	kW	Date	Engine								
					A10	A20	A40	A50	A70	C10 - C30	C20	E01

CAMRY SOLARA I

				ENGINE
2.2	Petrol	100	06/98-11/02	5S-FE

Engine	Information	A10	A20	A40	A50	A70	C10 - C30	C20	E01
All engines									1.501.856

CAMRY SOLARA II

				ENGINE
2.4	Petrol	117	07/03-11/08	2AZ-FE

Engine	Information	A10	A20	A40	A50	A70	C10 - C30	C20	E01
All engines	01/09/05 ->, Qty: 4						1.970.458	C10	
All engines	->year 01/09/05, Qty: 4						1.970.466	C10	

CARINA E

				ENGINE
1.6	Petrol	73	12/93-09/97	4A-FE

Engine	Information	A10	A20	A40	A50	A70	C10 - C30	C20	E01
All engines	no specific info conc. application available, version Bosch			1.306.094	1.406.121R				
All engines	no specific info conc. application available, version Denso			1.313.265	1.413.029, 1.413.036				
All engines	no specific info conc. application available						1.970.199, 1.970.2855	C10	1.501.209, 1.501.879

				ENGINE
1.6	Petrol	78	10/95-09/97	4A-FE

Engine	Information	A10	A20	A40	A50	A70	C10 - C30	C20	E01
All engines	no specific info conc. application available, version Bosch			1.306.094	1.406.121R				
All engines	no specific info conc. application available, version Denso			1.313.265	1.413.029, 1.413.036				
All engines	no specific info conc. application available						1.970.199, 1.970.2855	C10	1.501.209, 1.501.879

				ENGINE
1.6	Petrol	79	01/93-09/97	4A-FE

Engine	Information	A10	A20	A40	A50	A70	C10 - C30	C20	E01
All engines	no specific info conc. application available, version Bosch			1.306.094	1.406.121R				
All engines	no specific info conc. application available, version Denso			1.313.265	1.413.029, 1.413.036				
All engines	no specific info conc. application available						1.970.199, 1.970.2855	C10	1.501.209, 1.501.879

				ENGINE
1.6	Petrol	85	04/92-09/97	4A-FE

Engine	Information	A10	A20	A40	A50	A70	C10 - C30	C20	E01
All engines	no specific info conc. application available, version Bosch			1.306.094	1.406.121R				
All engines	no specific info conc. application available, version Denso			1.313.265	1.413.029, 1.413.036				
All engines	no specific info conc. application available						1.970.199, 1.970.2855	C10	1.501.209, 1.501.879

				ENGINE
1.6 16V	Petrol	78	10/95-09/97	4A-FE

Engine	Information	A10	A20	A40	A50	A70	C10 - C30	C20	E01
All engines	no specific info conc. application available, version Bosch			1.306.094	1.406.121R				
All engines	no specific info conc. application available, version Denso			1.313.265	1.413.029, 1.413.036				
All engines	no specific info conc. application available						1.970.199, 1.970.2855	C10	1.501.209, 1.501.879

				ENGINE
1.6 16V	Petrol	85	12/94-09/97	4A-FE

Engine	Information	A10	A20	A40	A50	A70	C10 - C30	C20	E01
All engines	no specific info conc. application available, version Bosch			1.306.094	1.406.121R				
All engines	no specific info conc. application available, version Denso			1.313.265	1.413.029, 1.413.036				
All engines	no specific info conc. application available						1.970.199, 1.970.2855	C10	1.501.209, 1.501.879

				ENGINE
1.6 GLI	Petrol	79	04/92-09/97	4A-FE

Engine	Information	A10	A20	A40	A50	A70	C10 - C30	C20	E01
All engines	no specific info conc. application available, version Bosch			1.306.094	1.406.121R				
All engines	no specific info conc. application available, version Denso			1.313.265	1.413.029, 1.413.036				
All engines	no specific info conc. application available						1.970.199, 1.970.2855	C10	1.501.209, 1.501.879

A10 CONDENSER	A20 CONTACT SET	A40 DISTRIBUTOR CAP	A50 ROTOR	A70 PICK-UP
C10 COIL	C20 IGNITION MODULE	C30 ELECTRONIC IGNITION KIT	E01 IGNITION CABLE SET	

Vehicle	alim.	kW	Date	Engine	FUNCTIONS ON THE VEHICLE							
					A10	A20	A40	A50	A70	C10 - C30	C20	E01

ENGINE				
1.6 i	Petrol	73	02/95-09/97	4A-FE

Engine	Information	A10	A20	A40	A50	A70	C10 - C30	C20	E01
All engines	no specific info conc. application available, version Bosch			1.306.094	1.406.121R				
All engines	no specific info conc. application available, version Denso			1.313.265	1.413.029, 1.413.036				
All engines	no specific info conc. application available						1.970.199, 1.970.285S	C10	1.501.209, 1.501.879

ENGINE				
1.8	Petrol	79	01/95-09/97	7A-FE

Engine	Information	A10	A20	A40	A50	A70	C10 - C30	C20	E01
All engines	version Denso				1.413.036				
All engines									1.501.879

ENGINE				
1.8	Petrol	85	04/92-09/97	7A-FE

Engine	Information	A10	A20	A40	A50	A70	C10 - C30	C20	E01
All engines	version Denso				1.413.036				
All engines									1.501.879

ENGINE				
1.8 i	Petrol	79	02/95-09/97	7A-FE

Engine	Information	A10	A20	A40	A50	A70	C10 - C30	C20	E01
All engines	version Denso				1.413.036				
All engines									1.501.879

ENGINE				
1.8 i 16V	Petrol	79	01/95-09/97	7A-FE

Engine	Information	A10	A20	A40	A50	A70	C10 - C30	C20	E01
All engines	version Denso				1.413.036				
All engines									1.501.879

ENGINE				
2.0	Petrol	98	01/93-09/97	3S-FE

Engine	Information	A10	A20	A40	A50	A70	C10 - C30	C20	E01
All engines	version Denso			1.313.267	1.413.029				
All engines							1.970.198	C10	
All engines	01/05/94 ->								1.501.793

ENGINE				
2.0 GLI	Petrol	98	04/92-09/97	3S-FE

Engine	Information	A10	A20	A40	A50	A70	C10 - C30	C20	E01
All engines	version Denso			1.313.267	1.413.029				
All engines							1.970.198	C10	
All engines	01/05/94 ->								1.501.793

ENGINE				
2.0 GTi	Petrol	116	04/92-12/95	3S-GE

Engine	Information	A10	A20	A40	A50	A70	C10 - C30	C20	E01
All engines	version Denso			1.313.267	1.413.029				
All engines							1.970.198	C10	
All engines	01/05/94 ->								1.501.793

ENGINE				
2.0 GTi 16V	Petrol	129	03/94-09/97	3S-GE

Engine	Information	A10	A20	A40	A50	A70	C10 - C30	C20	E01
All engines	version Denso			1.313.267	1.413.029				
All engines							1.970.198	C10	
All engines	01/05/94 ->								1.501.793

ENGINE				
2.0 i	Petrol	93	12/92-09/97	3S-FE









Engine	Information	A10	A20	A40	A50	A70	C10 - C30	C20	E01
All engines	version Denso			1.313.267	1.413.029				
All engines							1.970.198	C10	
All engines	01/05/94 ->								1.501.793

CARINA II

ENGINE				
1.6	Petrol	55	10/83-11/87	4A-LC

Engine	Information	A10	A20	A40	A50	A70	C10 - C30	C20	E01
All engines	version Denso				1.413.027				

A10 CONDENSER	A20 CONTACT SET	A40 DISTRIBUTOR CAP	A50 ROTOR	A70 PICK-UP
C10 COIL	C20 IGNITION MODULE	C30 ELECTRONIC IGNITION KIT	E01 IGNITION CABLE SET	

				FUNCTIONS ON THE VEHICLE								
Vehicle	alim.	kW	Date	Engine	 A10	 A20	 A40	 A50	 A70	 C10 - C30	 C20	 E01
				ENGINE								
1.6	Petrol	66	12/87-08/90	4A-F								
				ENGINE								
Engine		Information			A10	A20	A40	A50	A70	C10 - C30	C20	E01
All engines		version Denso					1.313.278	1.413.029				
All engines										1.970.199	C10	
				ENGINE								
1.6	Petrol	72	12/87-03/92	4A-FE								
				ENGINE								
Engine		Information			A10	A20	A40	A50	A70	C10 - C30	C20	E01
All engines		version Denso						1.413.029				
				ENGINE								
1.6	Petrol	75	12/87-03/92	4A-FE								
				ENGINE								
Engine		Information			A10	A20	A40	A50	A70	C10 - C30	C20	E01
All engines		01/11/92 ->, version Denso					1.313.262					
All engines		version Denso						1.413.029				
				ENGINE								
1.6 4WD	Petrol	77	06/88-03/92	4A-FE								
				ENGINE								
Engine		Information			A10	A20	A40	A50	A70	C10 - C30	C20	E01
All engines		version Denso						1.413.029				
				ENGINE								
2.0	Petrol	89	12/87-04/92	3S-FE								
				ENGINE								
Engine		Information			A10	A20	A40	A50	A70	C10 - C30	C20	E01
All engines		version Denso						1.413.029				
All engines										1.970.197	C10	
				ENGINE								
2.0	Petrol	94	12/87-03/92	3S-FE								
				ENGINE								
Engine		Information			A10	A20	A40	A50	A70	C10 - C30	C20	E01
All engines		version Denso						1.413.029				
All engines										1.970.197	C10	
				ENGINE								
2.0 GLI	Petrol	89	12/87-03/92	3S-FE								
				ENGINE								
Engine		Information			A10	A20	A40	A50	A70	C10 - C30	C20	E01
All engines		version Denso						1.413.029				
All engines										1.970.197	C10	
				ENGINE								
2.0 GLi	Petrol	94	12/87-03/92	3S-FE								
				ENGINE								
Engine		Information			A10	A20	A40	A50	A70	C10 - C30	C20	E01
All engines		version Denso						1.413.029				
All engines										1.970.197	C10	









				ENGINE								
Vehicle	alim.	kW	Date	Engine	A10	A20	A40	A50	A70	C10 - C30	C20	E01
				ENGINE								
1.6	Petrol	63	04/86-08/89	4A-L								
				ENGINE								
Engine		Information			A10	A20	A40	A50	A70	C10 - C30	C20	E01
All engines		version Denso					1.313.122	1.413.029				
All engines										1.970.199	C10	
				ENGINE								
1.6 GT	Petrol	85	08/87-08/89	4A-GELC								
				ENGINE								
Engine		Information			A10	A20	A40	A50	A70	C10 - C30	C20	E01
All engines		version Denso					1.313.119	1.413.027				
				ENGINE								
1.6 GT 16V	Petrol	91	09/85-08/89	4A-GEL								
				ENGINE								
Engine		Information			A10	A20	A40	A50	A70	C10 - C30	C20	E01
All engines		version Denso					1.313.119	1.413.027				
				ENGINE								
1.6 GTI 16V	Petrol	92	01/88-12/89	4A-GEL								
				ENGINE								
Engine		Information			A10	A20	A40	A50	A70	C10 - C30	C20	E01
All engines		version Denso					1.313.119	1.413.027				
				ENGINE								
2.0i [USA]	Petrol	0	01/85-12/87	2SEL, 3S-FE								
				ENGINE								
Engine		Information			A10	A20	A40	A50	A70	C10 - C30	C20	E01
Eng. 2SEL		version Denso						1.413.027				
Eng. 3S-FE		version Denso						1.413.029				

A10 CONDENSER	A20 CONTACT SET	A40 DISTRIBUTOR CAP	A50 ROTOR	A70 PICK-UP
C10 COIL	C20 IGNITION MODULE	C30 ELECTRONIC IGNITION KIT	E01 IGNITION CABLE SET	

Vehicle	alim.	kW	Date	Engine	FUNCTIONS ON THE VEHICLE									
					A10	A20	A40	A50	A70	C10 - C30	C20	E01		
ENGINE														
2.0i [USA]	Petrol	0	01/85-12/87	2SEL, 3S-FE										
Engine	Information				A10	A20	A40	A50	A70	C10 - C30	C20	E01		
All engines										1.970.197	C10			
CELICA V														
ENGINE														
1.6	Petrol	77	09/89-12/93	4A-FE										
Engine	Information				A10	A20	A40	A50	A70	C10 - C30	C20	E01		
All engines	version Denso						1.313.262	1.413.029						
ENGINE														
1.6 16V [USA] [CAN]	Petrol	77	09/89-09/93	4A-FE										
Engine	Information				A10	A20	A40	A50	A70	C10 - C30	C20	E01		
All engines	version Denso							1.413.029						
ENGINE														
2.0	Petrol	115	10/89-01/94	3S-GE										
Engine	Information				A10	A20	A40	A50	A70	C10 - C30	C20	E01		
All engines	->year 01/08/91, version Denso						1.313.251							
All engines	version Denso							1.413.036						
All engines	01/08/91 ->, RHD									1.970.203	C10			
ENGINE														
2.0	Petrol	118	09/89-10/93	3S-GE										
Engine	Information				A10	A20	A40	A50	A70	C10 - C30	C20	E01		
All engines	->year 01/08/91, version Denso						1.313.251							
All engines	version Denso							1.413.036						
All engines	01/08/91 ->, RHD									1.970.203	C10			
ENGINE														
2.0 4WD	Petrol	150	10/89-11/93	3S-GTE										
Engine	Information				A10	A20	A40	A50	A70	C10 - C30	C20	E01		
All engines	->year 01/08/91, version Denso						1.313.251							
All engines	version Denso							1.413.036						
All engines	01/08/91 ->, RHD									1.970.203	C10			
ENGINE														
2.0 4WD	Petrol	153	10/89-01/94	3S-GTE										
Engine	Information				A10	A20	A40	A50	A70	C10 - C30	C20	E01		
All engines	->year 01/08/91, version Denso						1.313.251							
All engines	version Denso							1.413.036						
All engines	01/08/91 ->, RHD									1.970.203	C10			
ENGINE														
2.0 GTi	Petrol	115	10/89-11/93	3S-GE										
Engine	Information				A10	A20	A40	A50	A70	C10 - C30	C20	E01		
All engines	->year 01/08/91, version Denso						1.313.251							
All engines	version Denso							1.413.036						
ENGINE														
2.2	Petrol	100	10/89-12/94	5S-FE										
Engine	Information				A10	A20	A40	A50	A70	C10 - C30	C20	E01		
All engines	version Denso, no specific info conc. application available						1.313.267	1.413.029, 1.413.036						
All engines	no specific info conc. application available									1.970.198, 1.970.2855	C10		1.501.793	
CELICA VI														
ENGINE														
1.8 i 16V	Petrol	85	11/93-11/99	7A-FE										
Engine	Information				A10	A20	A40	A50	A70	C10 - C30	C20	E01		
All engines	version Denso						1.313.265							
All engines										1.970.199	C10		1.501.209	
ENGINE														
1.8 i 16V [USA] [CAN]	Petrol	85	09/93-08/99	7A-FE										
Engine	Information				A10	A20	A40	A50	A70	C10 - C30	C20	E01		
All engines	version Denso						1.313.265							
All engines	01/08/95 ->									1.970.198	C10			
All engines	->year 01/08/95									1.970.199	C10			
All engines													1.501.209	

A10 CONDENSER	A20 CONTACT SET	A40 DISTRIBUTOR CAP	A50 ROTOR	A70 PICK-UP
C10 COIL	C20 IGNITION MODULE	C30 ELECTRONIC IGNITION KIT	E01 IGNITION CABLE SET	

The present application list is a brief version. For the detailed information about the possibility of installation on a specific vehicle, please refer to our web-catalogue <http://catalogo.facet.eu/>







				FUNCTIONS ON THE VEHICLE								
Vehicle	alim.	kW	Date	Engine	 A10	 A20	 A40	 A50	 A70	 C10 - C30	 C20	 E01
				ENGINE								
2.0 GTi	Petrol	129	08/94-08/99	3S-GE								
Engine	Information			A10	A20	A40	A50	A70	C10 - C30	C20	E01	
All engines	version Denso						1.413.036					
All engines									1.970.2855	C10		
				ENGINE								
2.0 i 16V	Petrol	125	11/93-11/99	3S-GE								
Engine	Information			A10	A20	A40	A50	A70	C10 - C30	C20	E01	
All engines	version Denso						1.413.036					
All engines									1.970.2855	C10		
				ENGINE								
2.0 i 16V	Petrol	129	11/93-11/99	3S-GE								
Engine	Information			A10	A20	A40	A50	A70	C10 - C30	C20	E01	
All engines	version Denso						1.413.036					
All engines									1.970.2855	C10		
				ENGINE								
2.0 i Turbo 4WD	Petrol	178	02/94-11/99	3S-GTE								
Engine	Information			A10	A20	A40	A50	A70	C10 - C30	C20	E01	
All engines	version Denso						1.413.036					
All engines									1.970.2855	C10		
				ENGINE								
2.2 GT	Petrol	100	11/93-08/99	5S-FE								
Engine	Information			A10	A20	A40	A50	A70	C10 - C30	C20	E01	
All engines	version Denso, no specific info conc. application available					1.313.267	1.413.029, 1.413.036					
All engines	no specific info conc. application available								1.970.198, 1.970.2855	C10		1.501.793
				CELICA VII								
				ENGINE								
1.8 16V VT-i	Petrol	105	08/99-07/05	1ZZFE								
Engine	Information			A10	A20	A40	A50	A70	C10 - C30	C20	E01	
All engines	x 4, COIL ON PLUG								1.970.461	C10		
				C-HR								
				ENGINE								
1.2	Petrol	85	10/16->	8NR-FTS								
Engine	Information			A10	A20	A40	A50	A70	C10 - C30	C20	E01	
All engines	x 4, COIL ON PLUG								1.970.645	C10		
				ENGINE								
1.2 4WD	Petrol	85	10/16->	8NR-FTS								
Engine	Information			A10	A20	A40	A50	A70	C10 - C30	C20	E01	
All engines	x 4, COIL ON PLUG								1.970.645	C10		
				ENGINE								
1.2 4WD	Petrol	96	10/16->	8NR-FTS								
Engine	Information			A10	A20	A40	A50	A70	C10 - C30	C20	E01	
All engines	x 4, COIL ON PLUG								1.970.645	C10		
				ENGINE								
2.0	Petrol	109	11/16->	3ZR-FAE								
Engine	Information			A10	A20	A40	A50	A70	C10 - C30	C20	E01	
All engines	x 4, COIL ON PLUG								1.970.536	C10		
				COROLLA								
				ENGINE								
1.2	Petrol	85	01/19->	8NR-FTS								
Engine	Information			A10	A20	A40	A50	A70	C10 - C30	C20	E01	
All engines	Corolla, x 4, COIL ON PLUG								1.970.645	C10		
				ENGINE								
1.6	Petrol	81	05/97-09/99	4A-FE								
Engine	Information			A10	A20	A40	A50	A70	C10 - C30	C20	E01	
All engines	x 1, DISTRIBUTOR								1.970.199	C10		
				ENGINE								
1.6 VVTi	Petrol	90	01/19->	1ZR-FAE, 1ZR-FE								
Engine	Information			A10	A20	A40	A50	A70	C10 - C30	C20	E01	
All engines	Corolla, x 4, COIL ON PLUG								1.970.536	C10		

A10 CONDENSER	A20 CONTACT SET	A40 DISTRIBUTOR CAP	A50 ROTOR	A70 PICK-UP
C10 COIL	C20 IGNITION MODULE	C30 ELECTRONIC IGNITION KIT	E01 IGNITION CABLE SET	

Vehicle	alim.	kW	Date	Engine	FUNCTIONS ON THE VEHICLE									
					A10	A20	A40	A50	A70	C10 - C30	C20	E01		
ENGINE														
1.6 VVTi	Petrol	97	01/19->	1ZR-FAE, 1ZR-FE										
Engine	Information				A10	A20	A40	A50	A70	C10 - C30	C20	E01		
All engines	Corolla, x 4, COIL ON PLUG									1.970.536	C10			
COROLLA IV														
ENGINE														
1.8	Petrol	56	09/79-05/82	3T-C										
Engine	Information				A10	A20	A40	A50	A70	C10 - C30	C20	E01		
All engines	version Denso							1.413.027						
ENGINE														
1.8	Petrol	63	08/82-09/83	3T-C										
Engine	Information				A10	A20	A40	A50	A70	C10 - C30	C20	E01		
All engines	version Denso							1.413.027						
COROLLA IX														
ENGINE														
1.4 VVT-i	Petrol	71	10/01-02/07	0ZZ24, 67MR20DE										
Engine	Information				A10	A20	A40	A50	A70	C10 - C30	C20	E01		
All engines	Corolla, x 4, COIL ON PLUG, x 4, COIL ON PLUG									1.970.461	C10			
ENGINE														
1.6	Petrol	91	11/06-07/07	1ZR-FE										
Engine	Information				A10	A20	A40	A50	A70	C10 - C30	C20	E01		
All engines	Qty: 4									1.970.536	C10			
ENGINE														
1.6 VVT-i	Petrol	81	10/01-03/08	3ZZ-FE										
Engine	Information				A10	A20	A40	A50	A70	C10 - C30	C20	E01		
All engines	Corolla, x 4, COIL ON PLUG, x 4, COIL ON PLUG									1.970.461	C10			
ENGINE														
1.8	Petrol	100	12/01-12/07	1ZZFE										
Engine	Information				A10	A20	A40	A50	A70	C10 - C30	C20	E01		
All engines	MADE BY: (J), x 4, COIL ON PLUG									1.970.461	C10			
ENGINE														
1.8	Petrol	92	05/02-05/04	1ZZFE										
Engine	Information				A10	A20	A40	A50	A70	C10 - C30	C20	E01		
All engines	Corolla, x 4, COIL ON PLUG									1.970.461	C10			
COROLLA V														
ENGINE														
1.6	Petrol	53	08/85-08/87	4A-LC										
Engine	Information				A10	A20	A40	A50	A70	C10 - C30	C20	E01		
All engines										1.970.197	C10			
ENGINE														
1.6	Petrol	54	08/85-05/88	4A-LC										
Engine	Information				A10	A20	A40	A50	A70	C10 - C30	C20	E01		
All engines										1.970.197	C10			
ENGINE														
1.6	Petrol	55	08/84-08/87	4A-C										
Engine	Information				A10	A20	A40	A50	A70	C10 - C30	C20	E01		
All engines										1.970.197	C10			
ENGINE														
1.6	Petrol	58	04/85-05/89	4A-LC										
Engine	Information				A10	A20	A40	A50	A70	C10 - C30	C20	E01		
All engines										1.970.197	C10			
ENGINE														
1.6	Petrol	85	05/85-04/87	4A-GELC										
Engine	Information				A10	A20	A40	A50	A70	C10 - C30	C20	E01		
All engines	version Denso						1.313.119	1.413.027						
ENGINE														
1.6 16V	Petrol	85	12/85-04/87	4A-GEC										
Engine	Information				A10	A20	A40	A50	A70	C10 - C30	C20	E01		
All engines	version Denso							1.413.027						

A10	CONDENSER	A20	CONTACT SET	A40	DISTRIBUTOR CAP	A50	ROTOR	A70	PICK-UP
C10	COIL	C20	IGNITION MODULE	C30	ELECTRONIC IGNITION KIT	E01	IGNITION CABLE SET		

The present application list is a brief version. For the detailed information about the possibility of installation on a specific vehicle, please refer to our web-catalogue <http://catalogo.facet.eu/>

					FUNCTIONS ON THE VEHICLE							
Vehicle	alim.	kW	Date	Engine	 A10	 A20	 A40	 A50	 A70	 C10 - C30	 C20	 E01
ENGINE												
1.6 SR	Petrol	58	08/83-04/85	4A-C								
Engine	Information				A10	A20	A40	A50	A70	C10 - C30	C20	E01
All engines										1.970.197	C10	
COROLLA VERSO I												
1.6 VVT-i	Petrol	81	08/01-05/04	3ZZ-FE								
Engine	Information				A10	A20	A40	A50	A70	C10 - C30	C20	E01
All engines	x 4, COIL ON PLUG									1.970.461	C10	
1.8 VVT-i	Petrol	99	12/01-05/04	1ZZFE								
Engine	Information				A10	A20	A40	A50	A70	C10 - C30	C20	E01
All engines	x 4, COIL ON PLUG									1.970.461	C10	
1.8 VVTi 4WD	Petrol	99	07/01-02/04	2CJXG								
Engine	Information				A10	A20	A40	A50	A70	C10 - C30	C20	E01
All engines	Qty: 4									1.970.461	C10	
COROLLA VERSO II												
1.6	Petrol	81	04/04-03/09	3ZZ-FE								
Engine	Information				A10	A20	A40	A50	A70	C10 - C30	C20	E01
All engines	x 4, COIL ON PLUG									1.970.461	C10	
1.8	Petrol	95	04/04-03/09	1ZZFE								
Engine	Information				A10	A20	A40	A50	A70	C10 - C30	C20	E01
All engines	x 4, COIL ON PLUG									1.970.461	C10	
COROLLA VI												
1.3	Petrol	55	08/87-06/92	2E								
Engine	Information				A10	A20	A40	A50	A70	C10 - C30	C20	E01
All engines	for emission-controlled vehicles, version Denso						1.313.122, 1.313.278					
All engines	version Denso							1.413.029				
All engines										1.970.199	C10	1.501.823
1.3	Petrol	60	05/87-04/92	2E								
Engine	Information				A10	A20	A40	A50	A70	C10 - C30	C20	E01
All engines	for emission-controlled vehicles, version Denso						1.313.122, 1.313.278					
All engines	version Denso							1.413.029				
All engines										1.970.199	C10	1.501.823
1.3 i	Petrol	55	08/87-06/92	2E, 2E-E								
Engine	Information				A10	A20	A40	A50	A70	C10 - C30	C20	E01
All engines	for emission-controlled vehicles, version Denso						1.313.122, 1.313.278					
All engines	version Denso							1.413.029				
All engines										1.970.199	C10	1.501.823
1.6	Petrol	66	05/87-11/92	4A-F								
Engine	Information				A10	A20	A40	A50	A70	C10 - C30	C20	E01
All engines	version Denso						1.313.278	1.413.029				
All engines										1.970.199	C10	
1.6	Petrol	70	09/89-04/92	4A-F								
Engine	Information				A10	A20	A40	A50	A70	C10 - C30	C20	E01
All engines	version Denso						1.313.278	1.413.029				
All engines										1.970.199	C10	
1.6	Petrol	71	01/88-12/92	4A-F								
Engine	Information				A10	A20	A40	A50	A70	C10 - C30	C20	E01
All engines	version Denso						1.313.278	1.413.029				
All engines										1.970.199	C10	

A10 CONDENSER	A20 CONTACT SET	A40 DISTRIBUTOR CAP	A50 ROTOR	A70 PICK-UP
C10 COIL	C20 IGNITION MODULE	C30 ELECTRONIC IGNITION KIT	E01 IGNITION CABLE SET	

Vehicle	alim.	kW	Date	Engine	FUNCTIONS ON THE VEHICLE							
					A10	A20	A40	A50	A70	C10 - C30	C20	E01

				ENGINE
1.6	Petrol	77	08/89-04/92	4A-FE

Engine	Information	A10	A20	A40	A50	A70	C10 - C30	C20	E01
All engines	AE92, version Denso			1.313.262					
All engines	version Denso				1.413.029				
All engines	AE95						1.970.197	C10	

				ENGINE
1.6 4WD	Petrol	66	08/87-08/89	4A-F

Engine	Information	A10	A20	A40	A50	A70	C10 - C30	C20	E01
All engines	version Denso			1.313.278	1.413.029				
All engines							1.970.199	C10	

				ENGINE
1.6 GL 4WD	Petrol	70	10/87-08/90	4A-F

Engine	Information	A10	A20	A40	A50	A70	C10 - C30	C20	E01
All engines	version Denso			1.313.278	1.413.029				
All engines							1.970.199	C10	

				ENGINE
1.6 GTi	Petrol	85	08/87-10/94	4A-GE

Engine	Information	A10	A20	A40	A50	A70	C10 - C30	C20	E01
All engines	version Denso			1.313.248	1.413.027				

				ENGINE
1.6 i	Petrol	77	05/87-05/92	4A-FE

Engine	Information	A10	A20	A40	A50	A70	C10 - C30	C20	E01
All engines	AE92, version Denso			1.313.262					
All engines	version Denso				1.413.029				
All engines	AE95						1.970.197	C10	

				ENGINE
1.6 i 4WD	Petrol	77	10/87-08/90	4A-FE

Engine	Information	A10	A20	A40	A50	A70	C10 - C30	C20	E01
All engines	AE92, version Denso			1.313.262	1.413.029				
All engines	AE95						1.970.197	C10	

				ENGINE
1.6 XL	Petrol	70	09/89-04/92	4A-F

Engine	Information	A10	A20	A40	A50	A70	C10 - C30	C20	E01
All engines	version Denso			1.313.278	1.413.029				
All engines							1.970.199	C10	

				ENGINE
1.6 XLI	Petrol	77	11/89-06/92	4A-FE

Engine	Information	A10	A20	A40	A50	A70	C10 - C30	C20	E01
All engines	version Denso			1.313.262	1.413.029				
All engines	AE95						1.970.197	C10	

COROLLA VII

				ENGINE
1.3 12V	Petrol	53	07/92-04/97	2E

Engine	Information	A10	A20	A40	A50	A70	C10 - C30	C20	E01
All engines	version Denso			1.313.275	1.413.029				
All engines							1.970.199	C10	1.501.393

				ENGINE
1.3 XLI	Petrol	55	08/95-04/97	4E-FE

Engine	Information	A10	A20	A40	A50	A70	C10 - C30	C20	E01
All engines	version Denso			1.313.265	1.413.029				
All engines							1.970.199	C10	
All engines	01/05/95 ->								1.501.435

				ENGINE
1.3 XLI	Petrol	65	07/92-04/97	4E-FE

Engine	Information	A10	A20	A40	A50	A70	C10 - C30	C20	E01
All engines	version Denso			1.313.265	1.413.029				
All engines							1.970.199	C10	
All engines	01/05/95 ->								1.501.435

A10	CONDENSER	A20	CONTACT SET	A40	DISTRIBUTOR CAP	A50	ROTOR	A70	PICK-UP
C10	COIL	C20	IGNITION MODULE	C30	ELECTRONIC IGNITION KIT	E01	IGNITION CABLE SET		

The present application list is a brief version. For the detailed information about the possibility of installation on a specific vehicle, please refer to our web-catalogue <http://catalogo.facet.eu/>

					FUNCTIONS ON THE VEHICLE							
Vehicle	alim.	kW	Date	Engine	 A10	 A20	 A40	 A50	 A70	 C10 - C30	 C20	 E01
ENGINE												
1.3 XLI 16V	Petrol	65	07/92-09/95	4E-FE								
Engine	Information				A10	A20	A40	A50	A70	C10 - C30	C20	E01
All engines	version Denso						1.313.265	1.413.029				
All engines										1.970.199	C10	
All engines	01/05/95 ->											1.501.435
ENGINE												
1.6 GLI	Petrol	84	07/92-04/97	4A-FE								
Engine	Information				A10	A20	A40	A50	A70	C10 - C30	C20	E01
All engines	version Denso						1.313.265					
All engines	01/11/95 ->, version Denso							1.413.029				
All engines										1.970.199	C10	1.501.209
ENGINE												
1.6 Si	Petrol	84	07/92-04/97	4A-FE								
Engine	Information				A10	A20	A40	A50	A70	C10 - C30	C20	E01
All engines	version Denso						1.313.265					
All engines	01/11/95 ->, version Denso							1.413.029				
All engines										1.970.199	C10	1.501.209
ENGINE												
1.8 16V 4WD	Petrol	81	09/95-04/97	7A-FE								
Engine	Information				A10	A20	A40	A50	A70	C10 - C30	C20	E01
All engines	version Denso						1.313.265					
All engines										1.970.199	C10	1.501.209
ENGINE												
1.8 GT	Petrol	86	11/92-05/95	7A-FE								
Engine	Information				A10	A20	A40	A50	A70	C10 - C30	C20	E01
All engines	version Denso						1.313.265					
All engines										1.970.199	C10	1.501.209
COROLLA VIII												
ENGINE												
1.3	Petrol	55	05/97-10/01	2E								
Engine	Information				A10	A20	A40	A50	A70	C10 - C30	C20	E01
All engines	version Denso						1.313.275	1.413.029				
All engines	Corolla, x 1, DISTRIBUTOR									1.970.199	C10	
All engines												1.501.393
ENGINE												
1.4	Petrol	63	04/97-02/00	4E-FE								
Engine	Information				A10	A20	A40	A50	A70	C10 - C30	C20	E01
All engines												1.501.880
ENGINE												
1.6	Petrol	81	04/97-01/02	3ZZ-FE, 4A-FE								
Engine	Information				A10	A20	A40	A50	A70	C10 - C30	C20	E01
Eng. 4A-FE	version Denso						1.313.265	1.413.029				
Eng. 4A-FE	Corolla, x 1, DISTRIBUTOR, x 1, DISTRIBUTOR									1.970.199	C10	
Eng. 3ZZ-FE	Corolla, x 4, COIL ON PLUG									1.970.461	C10	
Eng. 4A-FE												1.501.209
ENGINE												
1.6 16V	Petrol	81	10/99-12/01	3ZZ-FE								
Engine	Information				A10	A20	A40	A50	A70	C10 - C30	C20	E01
All engines	Corolla, x 4, COIL ON PLUG, x 4, COIL ON PLUG									1.970.461	C10	
ENGINE												
1.6 Aut.	Petrol	79	04/97-02/00	4A-FE								
Engine	Information				A10	A20	A40	A50	A70	C10 - C30	C20	E01
All engines	version Denso						1.313.265	1.413.029				
All engines	Corolla, x 1, DISTRIBUTOR, x 1, DISTRIBUTOR									1.970.199	C10	
All engines												1.501.209
ENGINE												
1.8	Petrol	81	10/97-10/01	7A-FE								
Engine	Information				A10	A20	A40	A50	A70	C10 - C30	C20	E01
All engines	Corolla, x 1, DISTRIBUTOR									1.970.199	C10	







A10 CONDENSER	A20 CONTACT SET	A40 DISTRIBUTOR CAP	A50 ROTOR	A70 PICK-UP
C10 COIL	C20 IGNITION MODULE	C30 ELECTRONIC IGNITION KIT	E01 IGNITION CABLE SET	

Vehicle	alim.	kW	Date	Engine	FUNCTIONS ON THE VEHICLE									
					A10	A20	A40	A50	A70	C10 - C30	C20	E01		
ENGINE														
1.8 4WD	Petrol	81	04/97-10/01	7A-FE										
Engine	Information				A10	A20	A40	A50	A70	C10 - C30	C20	E01		
All engines	version Denso						1.313.265							
All engines										1.970.198	C10		1.501.209	
COROLLA X														
ENGINE														
1.3 VVT-i	Petrol	63	03/08->	2NZ-FE										
Engine	Information				A10	A20	A40	A50	A70	C10 - C30	C20	E01		
All engines	Qty: 4									1.970.459	C10			
ENGINE														
1.33	Petrol	74	12/08-07/14	1NR-FE										
Engine	Information				A10	A20	A40	A50	A70	C10 - C30	C20	E01		
All engines	Corolla, x 4, COIL ON PLUG									1.970.537	C10			
ENGINE														
1.4 VVT-i	Petrol	71	11/06-11/13	4ZFE										
Engine	Information				A10	A20	A40	A50	A70	C10 - C30	C20	E01		
All engines	Corolla, x 4, COIL ON PLUG									1.970.461	C10			
ENGINE														
1.5	Petrol	81	09/06->	1NZ-FE										
Engine	Information				A10	A20	A40	A50	A70	C10 - C30	C20	E01		
All engines	Qty: 4, -transm. type 4FC									1.970.458	C10			
All engines	Qty: 4, t.tnr. 4FC									1.970.459	C10			
ENGINE														
1.5 4WD	Petrol	77	09/06->	1NZ-FE										
Engine	Information				A10	A20	A40	A50	A70	C10 - C30	C20	E01		
All engines	Qty: 4, -transm. type 4FC									1.970.458	C10			
All engines	Qty: 4, t.tnr. 4FC									1.970.459	C10			
ENGINE														
1.6	Petrol	97	11/06-11/13	1ZR-FAE, 1ZR-FE										
Engine	Information				A10	A20	A40	A50	A70	C10 - C30	C20	E01		
All engines	Corolla, x 4, COIL ON PLUG									1.970.536	C10			
ENGINE														
1.6 Dual VVTi	Petrol	91	01/07-07/14	1ZR-FE										
Engine	Information				A10	A20	A40	A50	A70	C10 - C30	C20	E01		
All engines	Corolla, x 4, COIL ON PLUG									1.970.536	C10			
ENGINE														
1.6 VVTi	Petrol	100	03/07-12/10	1ZR-FE										
Engine	Information				A10	A20	A40	A50	A70	C10 - C30	C20	E01		
All engines	Corolla, x 4, COIL ON PLUG									1.970.536	C10			
ENGINE														
1.6 VVTi	Petrol	80	12/07-06/13	3ZZ-FE										
Engine	Information				A10	A20	A40	A50	A70	C10 - C30	C20	E01		
All engines	Qty: 4									1.970.461	C10			
ENGINE														
1.6 VVTi	Petrol	81	08/07-06/13	3ZZ-FE										
Engine	Information				A10	A20	A40	A50	A70	C10 - C30	C20	E01		
All engines	Qty: 4									1.970.461	C10			
ENGINE														
1.6 VVTi	Petrol	90	07/10-05/14	1ZR-FE										
Engine	Information				A10	A20	A40	A50	A70	C10 - C30	C20	E01		
All engines	Corolla, x 4, COIL ON PLUG									1.970.536	C10			
ENGINE														
1.8	Petrol	106	09/06->	2ZR-FAE										
Engine	Information				A10	A20	A40	A50	A70	C10 - C30	C20	E01		
All engines	Qty: 4									1.970.536	C10			
ENGINE														
1.8	Petrol	108	01/09->	2ZR-FAE										
Engine	Information				A10	A20	A40	A50	A70	C10 - C30	C20	E01		
All engines	Qty: 4									1.970.536	C10			

A10	CONDENSER	A20	CONTACT SET	A40	DISTRIBUTOR CAP	A50	ROTOR	A70	PICK-UP
C10	COIL	C20	IGNITION MODULE	C30	ELECTRONIC IGNITION KIT	E01	IGNITION CABLE SET		

The present application list is a brief version. For the detailed information about the possibility of installation on a specific vehicle, please refer to our web-catalogue <http://catalogo.facet.eu/>

Vehicle	alim.	kW	Date	Engine	FUNCTIONS ON THE VEHICLE									
					A10	A20	A40	A50	A70	C10 - C30	C20	E01		
ENGINE														
1.5 4WD	Petrol	76	05/12->	1NZ-FE										
Engine					A10	A20	A40	A50	A70	C10 - C30	C20	E01		
All engines										1.970.458	C10			
ENGINE														
1.5 Hybrid	Petrol/ Electric	54	10/14->	1NZ-FXE										
Engine					A10	A20	A40	A50	A70	C10 - C30	C20	E01		
All engines										1.970.459	C10			
ENGINE														
1.6	Petrol	90	06/13-12/18	1ZR-FE										
Engine					A10	A20	A40	A50	A70	C10 - C30	C20	E01		
All engines										1.970.536	C10			
ENGINE														
1.6	Petrol	97	06/13-12/18	1ZR-FAE										
Engine					A10	A20	A40	A50	A70	C10 - C30	C20	E01		
All engines										1.970.536	C10			
ENGINE														
1.6 BiFuel	Petrol/ Com- pressed Natural Gas (CNG)	90	06/13->	1ZR-FE										
Engine					A10	A20	A40	A50	A70	C10 - C30	C20	E01		
All engines										1.970.536	C10			
ENGINE														
1.8	Petrol	103	05/12->	2ZR-FAE										
Engine					A10	A20	A40	A50	A70	C10 - C30	C20	E01		
All engines										1.970.536	C10			
ENGINE														
1.8 [USA] [CAN]	Petrol	0	08/13->	2ZR-FAE										
Engine					A10	A20	A40	A50	A70	C10 - C30	C20	E01		
All engines										1.970.536	C10			
ENGINE														
1.8 VVTi	Petrol	103	06/13-08/19	2ZR-FE										
Engine					A10	A20	A40	A50	A70	C10 - C30	C20	E01		
All engines										1.970.536	C10			
ENGINE														
1.8 VVT-i	Petrol	111	12/13->	2ZR-FE										
Engine					A10	A20	A40	A50	A70	C10 - C30	C20	E01		
All engines										1.970.536	C10			
ENGINE														
2.0 VVT-i CNG	Petrol/ Com- pressed Natural Gas (CNG)	105	10/13-12/18	3ZRFECNG										
Engine					A10	A20	A40	A50	A70	C10 - C30	C20	E01		
All engines										1.970.536	C10			
DYNA														
ENGINE														
1.6	Diesel	51	05/85-08/87	1Y										
Engine					A10	A20	A40	A50	A70	C10 - C30	C20	E01		
All engines							1.313.114	1.413.014						
ENGINE														
1.8	Petrol	57	05/95-08/01	2Y										
Engine					A10	A20	A40	A50	A70	C10 - C30	C20	E01		
All engines							1.313.113							
All engines							1.313.114							
All engines								1.413.014						
All engines								1.413.027						
All engines								1.413.030						
A10	CONDENSER		A20	CONTACT SET		A40	DISTRIBUTOR CAP		A50	ROTOR		A70	PICK-UP	
C10	COIL		C20	IGNITION MODULE		C30	ELECTRONIC IGNITION KIT		E01	IGNITION CABLE SET				

				FUNCTIONS ON THE VEHICLE								
Vehicle	alim.	kW	Date	Engine								
				ENGINE								
2.0	Petrol	65	05/95-10/01	3Y								
				ENGINE								
Engine	Information			A10	A20	A40	A50	A70	C10 - C30	C20	E01	
All engines	version Denso, YY211					1.313.113	1.413.027					
				DYNA 100								
				ENGINE								
1.8	Petrol	58	08/85-04/95	2Y								
				ENGINE								
Engine	Information			A10	A20	A40	A50	A70	C10 - C30	C20	E01	
All engines	01/09/91 ->, version Denso					1.313.113						
All engines	->year 01/09/91, version Denso					1.313.114						
All engines	->year 01/09/89, version Denso						1.413.014					
All engines	01/09/89->, version Denso, no specific info conc. application available						1.413.027					
All engines	version Denso, no specific info conc. application available						1.413.030					
				ENGINE								
1.8	Petrol	61	08/87-04/95	2Y								
				ENGINE								
Engine	Information			A10	A20	A40	A50	A70	C10 - C30	C20	E01	
All engines	01/09/91 ->, version Denso					1.313.113						
All engines	->year 01/09/91, version Denso					1.313.114						
All engines	->year 01/09/89, version Denso						1.413.014					
All engines	01/09/89->, version Denso, no specific info conc. application available						1.413.027					
All engines	version Denso, no specific info conc. application available						1.413.030					
				DYNA 150								
				ENGINE								
1.8	Petrol	58	08/85-08/86	2Y								
				ENGINE								
Engine	Information			A10	A20	A40	A50	A70	C10 - C30	C20	E01	
All engines	version Denso						1.413.014					
				ENGINE								
2.0	Petrol	65	08/85-09/87	3Y								
				ENGINE								
Engine	Information			A10	A20	A40	A50	A70	C10 - C30	C20	E01	
All engines	version Denso, YY60					1.313.114	1.413.014					
				ENGINE								
2.0	Petrol	79	08/85-08/88	3Y								
				ENGINE								
Engine	Information			A10	A20	A40	A50	A70	C10 - C30	C20	E01	
All engines	version Denso, YY60					1.313.114	1.413.014					
				DYNA 200								
				ENGINE								
2.7	Petrol	92	06/95-07/01	3RZ-FE								
				ENGINE								
Engine	Information			A10	A20	A40	A50	A70	C10 - C30	C20	E01	
All engines	RHD								1.970.198	C10		
All engines	01/08/99 ->										1.501.792	
				ECHO								
				ENGINE								
1.5 i 16V [USA]	Petrol	81	08/99->	1NZFE								
				ENGINE								
Engine	Information			A10	A20	A40	A50	A70	C10 - C30	C20	E01	
All engines	Qty: 4								1.970.459	C10		
				FJ CRUISER								
				ENGINE								
4.0	Petrol	176	06/05-10/09	1GR-FE								
				ENGINE								
Engine	Information			A10	A20	A40	A50	A70	C10 - C30	C20	E01	
All engines	->year 01/08/09, x 6, COIL ON PLUG, FOR: (J)								1.970.458	C10		
All engines	01/09/09->, x 6, COIL ON PLUG, FOR: (J)								1.970.537	C10		
				ENGINE								
4.0	Petrol	178	01/06-12/11	1GR-FE								
				ENGINE								
Engine	Information			A10	A20	A40	A50	A70	C10 - C30	C20	E01	
All engines	->year 01/07/09, x 6, COIL ON PLUG, FOR: (J)								1.970.458	C10		
All engines	01/08/09->, x 6, COIL ON PLUG, FOR: (J)								1.970.537	C10		
				ENGINE								
4.0	Petrol	191	01/10-06/14	1GR-FE								
				ENGINE								
Engine	Information			A10	A20	A40	A50	A70	C10 - C30	C20	E01	
All engines	x 6, COIL ON PLUG, FOR: (J)								1.970.537	C10		

A10 CONDENSER	A20 CONTACT SET	A40 DISTRIBUTOR CAP	A50 ROTOR	A70 PICK-UP
C10 COIL	C20 IGNITION MODULE	C30 ELECTRONIC IGNITION KIT	E01 IGNITION CABLE SET	

Vehicle	alim.	kW	Date	Engine	FUNCTIONS ON THE VEHICLE									
					A10	A20	A40	A50	A70	C10 - C30	C20	E01		
ENGINE														
4.0 4WD	Petrol	176	06/05-12/09	1GR-FE										
Engine	Information				A10	A20	A40	A50	A70	C10 - C30	C20	E01		
All engines	->year 01/08/09, x6, COIL ON PLUG, FOR: (J)									1.970.458	C10			
All engines	01/09/09 ->, x6, COIL ON PLUG, FOR: (J)									1.970.537	C10			
ENGINE														
4.0 4WD	Petrol	178	01/06-01/18	1GR-FE										
Engine	Information				A10	A20	A40	A50	A70	C10 - C30	C20	E01		
All engines	->year 01/07/09, x6, COIL ON PLUG, FOR: (J)									1.970.458	C10			
All engines	01/08/09 ->, x6, COIL ON PLUG, FOR: (J)									1.970.537	C10			
ENGINE														
4.0 4WD	Petrol	191	01/10-06/14	1GR-FE										
Engine	Information				A10	A20	A40	A50	A70	C10 - C30	C20	E01		
All engines	x6, COIL ON PLUG, FOR: (J)									1.970.537	C10			
ENGINE														
4.0 4WD	Petrol	203	06/05-01/18	1GR-FE										
Engine	Information				A10	A20	A40	A50	A70	C10 - C30	C20	E01		
All engines	->year 01/08/09, x6, COIL ON PLUG, FOR: (J)									1.970.458	C10			
All engines	01/09/09 ->, x6, COIL ON PLUG, FOR: (J)									1.970.537	C10			
FORTUNER														
ENGINE														
2.7 4x4	Petrol	122	05/15->	2TR-FE										
Engine	Information				A10	A20	A40	A50	A70	C10 - C30	C20	E01		
All engines	x4, COIL ON PLUG, FOR: (J)									1.970.458	C10			
FUNCRUISER														
ENGINE														
2.0 i 16V 4WD	Petrol	94	04/94->	3SFE										
Engine	Information				A10	A20	A40	A50	A70	C10 - C30	C20	E01		
All engines	version Denso						1.313.267	1.413.029						
All engines	->year 01/08/96									1.970.198	C10		1.501.793	
All engines	FOR: (AUS)									1.970.285	C10			
All engines	01/08/96 ->, 01/09/97 ->, FOR: (AUS)												1.501.856	
HIACE														
ENGINE														
2.4 LPG	LPG	85	08/95-06/99	2RZE										
Engine	Information				A10	A20	A40	A50	A70	C10 - C30	C20	E01		
All engines	x1, DISTRIBUTOR									1.970.199	C10			
HIACE III														
ENGINE														
1.8	Petrol	58	12/82-07/89	2Y										
Engine	Information				A10	A20	A40	A50	A70	C10 - C30	C20	E01		
All engines	version Denso						1.313.262							
ENGINE														
2.0	Petrol	65	12/82-08/89	3Y										
Engine	Information				A10	A20	A40	A50	A70	C10 - C30	C20	E01		
All engines	version Denso						1.313.114	1.413.014						
ENGINE														
2.0 4WD	Petrol	65	08/87-07/89	3Y										
Engine	Information				A10	A20	A40	A50	A70	C10 - C30	C20	E01		
All engines	version Denso						1.313.114	1.413.014						
ENGINE														
2.2	Petrol	69	09/87-08/89	4Y										
Engine	Information				A10	A20	A40	A50	A70	C10 - C30	C20	E01		
All engines	version Denso						1.313.114	1.413.014						
ENGINE														
2.2 4WD	Petrol	69	08/87-08/89	4Y										
Engine	Information				A10	A20	A40	A50	A70	C10 - C30	C20	E01		
All engines	version Denso						1.313.114	1.413.014						

A10	CONDENSER	A20	CONTACT SET	A40	DISTRIBUTOR CAP	A50	ROTOR	A70	PICK-UP
C10	COIL	C20	IGNITION MODULE	C30	ELECTRONIC IGNITION KIT	E01	IGNITION CABLE SET		

The present application list is a brief version. For the detailed information about the possibility of installation on a specific vehicle, please refer to our web-catalogue <http://catalogo.facet.eu/>

Vehicle	alim.	kW	Date	Engine	FUNCTIONS ON THE VEHICLE							
					A10	A20	A40	A50	A70	C10 - C30	C20	E01

HIACE IV

2.0	Petrol	74	08/89-08/04	ENGINE 1RZ
-----	--------	----	-------------	---------------

Engine	Information	A10	A20	A40	A50	A70	C10 - C30	C20	E01
All engines	->year 01/05/92, version Denso			1.313.278	1.413.029				
All engines							1.970.199	C10	

2.0	Petrol	81	11/96-10/00	ENGINE 1RZ-E
-----	--------	----	-------------	-----------------

Engine	Information	A10	A20	A40	A50	A70	C10 - C30	C20	E01
All engines							1.970.199	C10	

2.4	Petrol	85	08/89-12/04	ENGINE 2RZE, 5YTD050W07
-----	--------	----	-------------	----------------------------

Engine	Information	A10	A20	A40	A50	A70	C10 - C30	C20	E01
Eng. 2RZE	x 1, DISTRIBUTOR						1.970.199	C10	
Eng. 5YTD050W07							1.970.199	C10	

2.4	Petrol	88	08/89-08/04	ENGINE 5YTD050W07
-----	--------	----	-------------	----------------------

Engine	Information	A10	A20	A40	A50	A70	C10 - C30	C20	E01
All engines	->year 01/05/92, version Denso			1.313.278	1.413.029				
All engines							1.970.198, 1.970.199	C10	

2.4 4WD	Petrol	85	08/95-04/98	ENGINE 2RZE
---------	--------	----	-------------	----------------

Engine	Information	A10	A20	A40	A50	A70	C10 - C30	C20	E01
All engines	x 1, DISTRIBUTOR						1.970.199	C10	

2.4 4WD	Petrol	88	08/89-08/95	ENGINE 5YTD050W07
---------	--------	----	-------------	----------------------

Engine	Information	A10	A20	A40	A50	A70	C10 - C30	C20	E01
All engines	->year 01/05/92, version Denso			1.313.278	1.413.029				
All engines							1.970.198	C10	

2.7	Petrol	105	04/98-06/05	ENGINE 3RZ-FE
-----	--------	-----	-------------	------------------

Engine	Information	A10	A20	A40	A50	A70	C10 - C30	C20	E01
All engines	->year 01/08/01								1.501.792

2.7	Petrol	106	07/98-12/06	ENGINE 3RZ-FE
-----	--------	-----	-------------	------------------

Engine	Information	A10	A20	A40	A50	A70	C10 - C30	C20	E01
All engines	->year 01/08/01								1.501.792

2.7	Petrol	111	01/05->	ENGINE 2TR-FE
-----	--------	-----	---------	------------------

Engine	Information	A10	A20	A40	A50	A70	C10 - C30	C20	E01
All engines	MADE BY: (GB), x 4, COIL ON PLUG, FOR: (J) MADE BY: (J), x 4, COIL ON PLUG, FOR: (J)						1.970.458	C10	

2.7	Petrol	118	01/15->	ENGINE 2TR-FE
-----	--------	-----	---------	------------------

Engine	Information	A10	A20	A40	A50	A70	C10 - C30	C20	E01
All engines	x 4, COIL ON PLUG, FOR: (J)						1.970.458	C10	

2.7 4WD	Petrol	105	04/98-08/06	ENGINE 3RZ-FE
---------	--------	-----	-------------	------------------

Engine	Information	A10	A20	A40	A50	A70	C10 - C30	C20	E01
All engines	->year 01/08/01								1.501.792

2.7 4WD	Petrol	106	07/98-06/05	ENGINE 3RZ-FE
---------	--------	-----	-------------	------------------

Engine	Information	A10	A20	A40	A50	A70	C10 - C30	C20	E01
All engines	->year 01/08/01								1.501.792

2.7 VVTi	Petrol	111	01/05->	ENGINE 2TR-FE
----------	--------	-----	---------	------------------

Engine	Information	A10	A20	A40	A50	A70	C10 - C30	C20	E01
All engines	x 4, COIL ON PLUG, FOR: (J)						1.970.458	C10	

A10 CONDENSER	A20 CONTACT SET	A40 DISTRIBUTOR CAP	A50 ROTOR	A70 PICK-UP
C10 COIL	C20 IGNITION MODULE	C30 ELECTRONIC IGNITION KIT	E01 IGNITION CABLE SET	

Vehicle	alim.	kW	Date	Engine	FUNCTIONS ON THE VEHICLE							
					A10	A20	A40	A50	A70	C10 - C30	C20	E01

HIGHLANDER / KLUGER

				ENGINE
2.7	Petrol	138	09/16->	1AR-FE

Engine	Information	A10	A20	A40	A50	A70	C10 - C30	C20	E01
All engines	x 4, COIL ON PLUG, FOR: (J)						1.970.537	C10	

				ENGINE
3.5 AWD	Petrol	183	09/14->	2GR-FE, 2GR-FKS

Engine	Information	A10	A20	A40	A50	A70	C10 - C30	C20	E01
All engines	FOR: (J), x 6, COIL ON PLUG, x 6, COIL ON PLUG						1.970.538	C10	

HILUX IV

				ENGINE
1.8	Petrol	58	08/83-03/89	2Y

Engine	Information	A10	A20	A40	A50	A70	C10 - C30	C20	E01
All engines	version Denso, no specific info conc. application available			1.313.113, 1.313.114					
All engines	->year 01/03/89, version Denso				1.413.014				
All engines	YN5, YN6, 01/08/91 ->, FOR: (ZA), version Denso				1.413.027				
All engines	01/03/89 ->, YN5, YN6, ->year 01/08/91, version Denso				1.413.030				

				ENGINE
2.2	Petrol	69	08/83-12/89	4Y

Engine	Information	A10	A20	A40	A50	A70	C10 - C30	C20	E01
All engines	01/08/91 ->, FOR: (ZA), version Denso			1.313.113	1.413.027				
All engines	version Denso			1.313.114					
All engines	->year 01/03/89, version Denso				1.413.014				
All engines	01/03/89 ->, version Denso				1.413.030				

				ENGINE
2.2 4WD	Petrol	69	11/85-12/89	4Y

Engine	Information	A10	A20	A40	A50	A70	C10 - C30	C20	E01
All engines	01/01/90 ->, version Denso			1.313.113	1.413.027				
All engines	->year 01/01/90, version Denso			1.313.114					
All engines	->year 01/03/89, version Denso				1.413.014				
All engines	01/03/89 ->, ->year 01/01/90, version Denso				1.413.030				

				ENGINE
2.4 4WD	Petrol	75	10/88-12/97	22R

Engine	Information	A10	A20	A40	A50	A70	C10 - C30	C20	E01
All engines	->year 01/08/92, version Denso			1.313.099					
All engines	01/08/92 ->, version Denso			1.313.273					
All engines	01/08/92 ->						1.970.203	C10	

HILUX V

				ENGINE
1.8	Petrol	61	09/88-06/98	2Y

Engine	Information	A10	A20	A40	A50	A70	C10 - C30	C20	E01
All engines	version Denso, no specific info conc. application available			1.313.113, 1.313.114					
All engines	->year 01/03/89, version Denso				1.413.014				
All engines	YN5, YN6, 01/08/91 ->, FOR: (ZA), version Denso				1.413.027				
All engines	01/03/89 ->, YN5, YN6, ->year 01/08/91, version Denso				1.413.030				

				ENGINE
2.4 4WD	Petrol	75	10/88-08/97	22R

Engine	Information	A10	A20	A40	A50	A70	C10 - C30	C20	E01
All engines	->year 01/08/92, version Denso			1.313.099					
All engines	01/08/92 ->, version Denso			1.313.273					
All engines	01/08/92 ->						1.970.203	C10	









				ENGINE
2.4 i 4WD	Petrol	84	01/89-07/97	22RE

Engine	Information	A10	A20	A40	A50	A70	C10 - C30	C20	E01
All engines	->year 01/08/92, version Denso			1.313.099					
All engines	01/08/92 ->, version Denso			1.313.273					
All engines	01/08/92 ->						1.970.203	C10	

				ENGINE
3.0 4WD	Petrol	112	08/89-11/95	3VZ-E

Engine	Information	A10	A20	A40	A50	A70	C10 - C30	C20	E01
All engines	->year 01/08/91						1.970.202	C10	

A10	CONDENSER	A20	CONTACT SET	A40	DISTRIBUTOR CAP	A50	ROTOR	A70	PICK-UP
C10	COIL	C20	IGNITION MODULE	C30	ELECTRONIC IGNITION KIT	E01	IGNITION CABLE SET		









					FUNCTIONS ON THE VEHICLE							
Vehicle	alim.	kW	Date	Engine								
3.0 4WD												
	Petrol	112	08/89-11/95	ENGINE 3VZ-E								
Engine	Information				A10	A20	A40	A50	A70	C10 - C30	C20	E01
All engines	01/08/91 ->									1.970.203	C10	
HILUX VI												
2.4 i 4WD												
	Petrol	103	08/97-10/05	ENGINE 2RZ-FE								
Engine	Information				A10	A20	A40	A50	A70	C10 - C30	C20	E01
All engines												1.501.792
HILUX VII												
2.0												
	Petrol	100	06/05-05/15	ENGINE 1TR-FE								
Engine	Information				A10	A20	A40	A50	A70	C10 - C30	C20	E01
All engines	Qty: 4									1.970.458	C10	
2.7												
	Petrol	118	02/05->	ENGINE 2TR-FE								
Engine	Information				A10	A20	A40	A50	A70	C10 - C30	C20	E01
All engines	Qty: 4									1.970.458	C10	
2.7 4WD												
	Petrol	118	08/05-05/15	ENGINE 2TR-FE								
Engine	Information				A10	A20	A40	A50	A70	C10 - C30	C20	E01
All engines	Qty: 4									1.970.458	C10	
4.0												
	Petrol	175	02/05->	ENGINE 1GR-FE								
Engine	Information				A10	A20	A40	A50	A70	C10 - C30	C20	E01
All engines	Qty: 6									1.970.458	C10	
4.0 4WD												
	Petrol	175	02/05->	ENGINE 1GR-FE								
Engine	Information				A10	A20	A40	A50	A70	C10 - C30	C20	E01
All engines	Qty: 6									1.970.458	C10	
IQ												
1.0												
	Petrol	50	01/09-12/15	ENGINE 1KR-FE								
Engine	Information				A10	A20	A40	A50	A70	C10 - C30	C20	E01
All engines	x 3, COIL ON PLUG									1.970.459	C10	
1.33												
	Petrol	69	01/09->	ENGINE 1NR-FE								
Engine	Information				A10	A20	A40	A50	A70	C10 - C30	C20	E01
All engines	Qty: 4									1.970.537	C10	
1.33												
	Petrol	72	01/09-12/15	ENGINE 1NR-FE								
Engine	Information				A10	A20	A40	A50	A70	C10 - C30	C20	E01
All engines	x 4, COIL ON PLUG									1.970.537	C10	
LAND CRUISER												
2.7												
	Petrol	112	09/02-08/04	ENGINE 3RZ-FE								
Engine	Information				A10	A20	A40	A50	A70	C10 - C30	C20	E01
All engines	no specific info conc. application available											1.501.792
2.7												
	Petrol	120	08/04->	ENGINE 2TR-FE								
Engine	Information				A10	A20	A40	A50	A70	C10 - C30	C20	E01
All engines	Qty: 4									1.970.458	C10	
4.0												
	Petrol	179	01/03-08/09	ENGINE 1GR-FE								
Engine	Information				A10	A20	A40	A50	A70	C10 - C30	C20	E01
All engines	Qty: 6									1.970.458	C10	
4.0 V6 VVTi												
	Petrol	203	08/09->	ENGINE 1GR-FE								
Engine	Information				A10	A20	A40	A50	A70	C10 - C30	C20	E01
All engines	Qty: 6									1.970.537	C10	

A10 CONDENSER	A20 CONTACT SET	A40 DISTRIBUTOR CAP	A50 ROTOR	A70 PICK-UP
C10 COIL	C20 IGNITION MODULE	C30 ELECTRONIC IGNITION KIT	E01 IGNITION CABLE SET	

Vehicle	alim.	kW	Date	Engine	FUNCTIONS ON THE VEHICLE							
					A10	A20	A40	A50	A70	C10 - C30	C20	E01
LAND CRUISER 120												
2.7	Petrol	120	11/03-02/10	2TR-FE								
Engine	Information				A10	A20	A40	A50	A70	C10 - C30	C20	E01
All engines	x 4, COIL ON PLUG, FOR: (J)									1.970.458	C10	
4.0	Petrol	179	09/02-08/10	1GR-FE								
Engine	Information				A10	A20	A40	A50	A70	C10 - C30	C20	E01
All engines	x 6, COIL ON PLUG, FOR: (J)									1.970.458	C10	
4.0	Petrol	183	12/02-12/10	1GR-FE								
Engine	Information				A10	A20	A40	A50	A70	C10 - C30	C20	E01
All engines	x 6, COIL ON PLUG, FOR: (J)									1.970.458	C10	
4.0 V6 VVT-i	Petrol	207	01/03-07/09	1GR-FE								
Engine	Information				A10	A20	A40	A50	A70	C10 - C30	C20	E01
All engines	x 6, COIL ON PLUG, FOR: (J)									1.970.458	C10	
LAND CRUISER 150												
4.0 V6 Dual VVTi	Petrol	205	08/09->	1GR-FE								
Engine	Information				A10	A20	A40	A50	A70	C10 - C30	C20	E01
All engines	x 6, COIL ON PLUG, FOR: (J)									1.970.537	C10	
4.0 V6 VVTi	Petrol	183	11/12->	1GR-FE								
Engine	Information				A10	A20	A40	A50	A70	C10 - C30	C20	E01
All engines	x 6, COIL ON PLUG, FOR: (J)									1.970.537	C10	
4.0 V6 VVTi	Petrol	202	08/09->	1GR-FE								
Engine	Information				A10	A20	A40	A50	A70	C10 - C30	C20	E01
All engines	x 6, COIL ON PLUG, FOR: (J)									1.970.537	C10	
4.0 V6 VVTi	Petrol	203	01/10->	1GR-FE								
Engine	Information				A10	A20	A40	A50	A70	C10 - C30	C20	E01
All engines	Qty: 6									1.970.537	C10	
4.0 V6 VVT-i	Petrol	207	08/09->	1GR-FE								
Engine	Information				A10	A20	A40	A50	A70	C10 - C30	C20	E01
All engines	x 6, COIL ON PLUG, FOR: (J)									1.970.537	C10	
LAND CRUISER 200												
4.0	Petrol	176	01/10->	1GR-FE								
Engine	Information				A10	A20	A40	A50	A70	C10 - C30	C20	E01
All engines	->year 31/01/12, Qty: 6									1.970.458	C10	
All engines	01/02/12->, Qty: 6									1.970.537	C10	
4.6 V8	Petrol	227	09/10->	1UR-FE								
Engine	Information				A10	A20	A40	A50	A70	C10 - C30	C20	E01
All engines	x 8, COIL ON PLUG, FOR: (J)									1.970.537	C10	
4.6 V8	Petrol	234	01/12->	1UR-FE								
Engine	Information				A10	A20	A40	A50	A70	C10 - C30	C20	E01
All engines	x 8, COIL ON PLUG, FOR: (J)									1.970.537	C10	
5.7 V8	Petrol	270	09/11-07/15	3UR-FE								
Engine	Information				A10	A20	A40	A50	A70	C10 - C30	C20	E01
All engines	Qty: 8									1.970.537	C10	
5.7 V8	Petrol	284	08/07->	3UR-FE								
Engine	Information				A10	A20	A40	A50	A70	C10 - C30	C20	E01
All engines	Qty: 8									1.970.537	C10	

A10	CONDENSER	A20	CONTACT SET	A40	DISTRIBUTOR CAP	A50	ROTOR	A70	PICK-UP
C10	COIL	C20	IGNITION MODULE	C30	ELECTRONIC IGNITION KIT	E01	IGNITION CABLE SET		

The present application list is a brief version. For the detailed information about the possibility of installation on a specific vehicle, please refer to our web-catalogue <http://catalogo.facet.eu/>

					FUNCTIONS ON THE VEHICLE							
Vehicle	alim.	kW	Date	Engine								
LAND CRUISER 70												
2.4	Petrol	77	11/84-05/93	ENGINE 22R								
Engine Information					A10	A20	A40	A50	A70	C10 - C30	C20	E01
All engines							1.313.099	1.413.027				
ENGINE												
2.4	Petrol	81	11/84-05/93	ENGINE 22R								
Engine Information					A10	A20	A40	A50	A70	C10 - C30	C20	E01
All engines							1.313.099	1.413.027				
ENGINE												
2.4	Petrol	84	12/88-12/96	ENGINE 22RE								
Engine Information					A10	A20	A40	A50	A70	C10 - C30	C20	E01
All engines							1.313.099					
LAND CRUISER 80												
4.0	Petrol	115	01/90-10/92	ENGINE 3F-E								
Engine Information					A10	A20	A40	A50	A70	C10 - C30	C20	E01
All engines										1.970.202	C10	
ENGINE												
4.5	Petrol	215	08/92-01/98	ENGINE 1FZ-FE								
Engine Information					A10	A20	A40	A50	A70	C10 - C30	C20	E01
All engines							1.313.272					
All engines										1.970.2855	C10	
ENGINE												
4.5 24V	Petrol	151	08/92-12/97	ENGINE 1FZ-FE								
Engine Information					A10	A20	A40	A50	A70	C10 - C30	C20	E01
All engines							1.313.272					
All engines										1.970.2855	C10	
LAND CRUISER 90												
2.7	Petrol	110	06/95-08/02	ENGINE 3RZ-FE								
Engine Information					A10	A20	A40	A50	A70	C10 - C30	C20	E01
All engines										1.970.198	C10	
LITEACE												
1.5	Petrol	51	10/85-09/91	ENGINE 5K								
Engine Information					A10	A20	A40	A50	A70	C10 - C30	C20	E01
All engines							1.313.114	1.413.014				
ENGINE												
1.5	Petrol	52	07/89-01/95	ENGINE 5K								
Engine Information					A10	A20	A40	A50	A70	C10 - C30	C20	E01
All engines							1.313.114	1.413.014				
All engines										1.970.203	C10	
ENGINE												
2.2	Petrol	72	01/92-01/95	ENGINE 4Y-EC								
Engine Information					A10	A20	A40	A50	A70	C10 - C30	C20	E01
All engines							1.313.113	1.413.027				
All engines										1.970.197	C10	
MATRIX												
1.8	Petrol	97	01/08-05/14	ENGINE 2ZR-FE								
Engine Information					A10	A20	A40	A50	A70	C10 - C30	C20	E01
All engines										1.970.536	C10	
ENGINE												
2.4	Petrol	117	01/08-05/14	ENGINE 2AZ-FE								
Engine Information					A10	A20	A40	A50	A70	C10 - C30	C20	E01
All engines										1.970.458	C10	
All engines										1.970.466	C10	









A10 CONDENSER	A20 CONTACT SET	A40 DISTRIBUTOR CAP	A50 ROTOR	A70 PICK-UP
C10 COIL	C20 IGNITION MODULE	C30 ELECTRONIC IGNITION KIT	E01 IGNITION CABLE SET	

Vehicle	alim.	kW	Date	Engine	FUNCTIONS ON THE VEHICLE									
					A10	A20	A40	A50	A70	C10 - C30	C20	E01		
ENGINE														
2.4 4WD	Petrol	117	01/09-12/10	2AZ-FE										
Engine	Information				A10	A20	A40	A50	A70	C10 - C30	C20	E01		
All engines	x 4, COIL ON PLUG, FOR: (J)									1.970.466	C10			
MODEL F														
2.0	Petrol	66	08/88-01/90	3Y										
Engine	Information				A10	A20	A40	A50	A70	C10 - C30	C20	E01		
All engines	version Denso						1.313.113	1.413.027						
ENGINE														
2.2	Petrol	72	08/85-01/90	4Y-EC										
Engine	Information				A10	A20	A40	A50	A70	C10 - C30	C20	E01		
All engines	version Denso						1.313.113	1.413.027						
All engines										1.970.197	C10			
MR 2 I														
1.6 16V	Petrol	85	11/84-06/90	4A-GELC										
Engine	Information				A10	A20	A40	A50	A70	C10 - C30	C20	E01		
All engines	version Denso						1.313.119	1.413.029						
ENGINE														
1.6 Supercharged	Petrol	107	08/86-12/89	4A-GZE										
Engine	Information				A10	A20	A40	A50	A70	C10 - C30	C20	E01		
All engines	version Denso						1.313.119	1.413.029						
MR 2 II														
2.0	Petrol	88	12/89-08/92	3S-FE										
Engine	Information				A10	A20	A40	A50	A70	C10 - C30	C20	E01		
All engines	version Denso							1.413.036						
All engines										1.970.203	C10			
ENGINE														
2.0 16V	Petrol	115	12/89-09/99	3S-GE										
Engine	Information				A10	A20	A40	A50	A70	C10 - C30	C20	E01		
All engines	->year 01/12/91, version Denso						1.313.251							
All engines	version Denso							1.413.036						
All engines	->year 01/12/91									1.970.202	C10			
All engines	01/12/91 ->									1.970.203	C10			
ENGINE														
2.0 16V	Petrol	125	12/89-05/00	3S-GE										
Engine	Information				A10	A20	A40	A50	A70	C10 - C30	C20	E01		
All engines	->year 01/12/91, version Denso						1.313.251							
All engines	version Denso							1.413.036						
All engines	->year 01/12/91									1.970.202	C10			
All engines	01/12/91 ->									1.970.203	C10			
ENGINE														
2.0 16V	Petrol	129	12/89-07/99	3S-GE										
Engine	Information				A10	A20	A40	A50	A70	C10 - C30	C20	E01		
All engines	->year 01/12/91, version Denso						1.313.251							
All engines	version Denso							1.413.036						
All engines	->year 01/12/91									1.970.202	C10			
All engines	01/12/91 ->									1.970.203	C10			
ENGINE														
2.0 Turbo	Petrol	167	12/89-07/99	3S-GTE										
Engine	Information				A10	A20	A40	A50	A70	C10 - C30	C20	E01		
All engines	->year 01/01/92, version Denso						1.313.251							
All engines	version Denso							1.413.036						
All engines	->year 01/01/92									1.970.202	C10			
All engines	01/01/92 ->									1.970.203	C10			
ENGINE														
2.2 16V	Petrol	97	01/90-06/95	5S-FE										
Engine	Information				A10	A20	A40	A50	A70	C10 - C30	C20	E01		
All engines	01/01/92 ->, version Denso						1.313.267							
All engines	version Denso							1.413.029						





A10 CONDENSER	A20 CONTACT SET	A40 DISTRIBUTOR CAP	A50 ROTOR	A70 PICK-UP
C10 COIL	C20 IGNITION MODULE	C30 ELECTRONIC IGNITION KIT	E01 IGNITION CABLE SET	

The present application list is a brief version. For the detailed information about the possibility of installation on a specific vehicle, please refer to our web-catalogue <http://catalogo.facet.eu/>

FUNCTIONS ON THE VEHICLE

Vehicle	alim.	kW	Date	Engine								
ENGINE												
2.2 16V	Petrol	97	01/90-06/95	5S-FE								
Engine	Information			A10	A20	A40	A50	A70	C10 - C30		C20	E01
All engines	01/01/92 ->								1.970.198	C10		
All engines	->year 01/01/92								1.970.203	C10		
All engines	01/09/93 ->											1.501.793
MR 2 III												
1.8 16V VT-i	Petrol	103	10/99-06/07	1ZZFE								
Engine	Information			A10	A20	A40	A50	A70	C10 - C30		C20	E01
All engines	x 4, COIL ON PLUG								1.970.461	C10		
PASEO												
1.5	Petrol	66	08/95-06/99	5E-FE								
Engine	Information			A10	A20	A40	A50	A70	C10 - C30		C20	E01
All engines	version Denso					1.313.265						
All engines	FOR: (EU)								1.970.199	C10		
All engines	FOR: (EU), x 1, DISTRIBUTOR								1.970.199	C10		
All engines	01/09/94 ->, FOR: (EU)											1.501.435
1.5	Petrol	74	06/90-08/95	5E-FE								
Engine	Information			A10	A20	A40	A50	A70	C10 - C30		C20	E01
All engines	version Denso					1.313.265	1.413.029					
All engines	->year 01/08/95								1.970.198	C10		
All engines	01/09/94 ->											1.501.435
1.5 Efi	Petrol	66	01/97-12/99	5E-FE								
Engine	Information			A10	A20	A40	A50	A70	C10 - C30		C20	E01
All engines	x 1, DISTRIBUTOR								1.970.199	C10		
PICNIC I												
2.0	Petrol	90	06/00-12/01	3S-FE								
Engine	Information			A10	A20	A40	A50	A70	C10 - C30		C20	E01
All engines												1.501.856
2.0 16V	Petrol	94	08/96-09/00	3S-FE								
Engine	Information			A10	A20	A40	A50	A70	C10 - C30		C20	E01
All engines												1.501.856
PICNIC II												
2.0 VVTi	Petrol	110	05/01-08/06	1AZ-FE								
Engine	Information			A10	A20	A40	A50	A70	C10 - C30		C20	E01
All engines	Qty: 4								1.970.466	C10		
2.4 VVTi	Petrol	115	11/03-08/06	2AZ-FE								
Engine	Information			A10	A20	A40	A50	A70	C10 - C30		C20	E01
All engines	Qty: 4								1.970.466	C10		
PREVIA I												
2.4	Petrol	97	05/90-08/00	2TZ-FE								
Engine	Information			A10	A20	A40	A50	A70	C10 - C30		C20	E01
All engines	version Denso					1.313.252	1.413.036					
All engines									1.970.322	C10		
2.4 4WD	Petrol	110	05/90-12/99	2TZ-FZE								
Engine	Information			A10	A20	A40	A50	A70	C10 - C30		C20	E01
All engines	version Denso					1.313.252	1.413.036					
All engines									1.970.322	C10		
2.4 4WD	Petrol	97	01/90-08/00	2TZ-FE								
Engine	Information			A10	A20	A40	A50	A70	C10 - C30		C20	E01
All engines	version Denso					1.313.252	1.413.036					

A10 CONDENSER	A20 CONTACT SET	A40 DISTRIBUTOR CAP	A50 ROTOR	A70 PICK-UP
C10 COIL	C20 IGNITION MODULE	C30 ELECTRONIC IGNITION KIT	E01 IGNITION CABLE SET	

					FUNCTIONS ON THE VEHICLE							
Vehicle	alim.	kW	Date	Engine								
1.8 Hybrid					ENGINE							
Petrol/ Electric	100	06/08->	2ZR-FXE									
Engine	Information				A10	A20	A40	A50	A70	C10 - C30	C20	E01
All engines	x 4, COIL ON PLUG									1.970.536	C10	
1.8 Hybrid					ENGINE							
Petrol/ Electric	73	06/08->	2ZR-FXE									
Engine	Information				A10	A20	A40	A50	A70	C10 - C30	C20	E01
All engines	x 4, COIL ON PLUG									1.970.536	C10	
PRIUS PLUS					ENGINE							
1.8 Hybrid	Petrol/ Electric	73	11/14->	2ZR-FXE								
Engine	Information				A10	A20	A40	A50	A70	C10 - C30	C20	E01
All engines	x 4, COIL ON PLUG									1.970.536	C10	
RAV 4					ENGINE							
2.0 VVTi 4WD	Petrol	111	12/12-11/18	3ZR-FAE								
Engine	Information				A10	A20	A40	A50	A70	C10 - C30	C20	E01
All engines	x 4, COIL ON PLUG									1.970.536	C10	
2.0 VVTi 4WD					ENGINE							
Petrol	112	12/12-11/18	3ZR-FAE									
Engine	Information				A10	A20	A40	A50	A70	C10 - C30	C20	E01
All engines	x 4, COIL ON PLUG									1.970.536	C10	
RAV 4 I					ENGINE							
2.0	Petrol	99	06/97-09/99	3S-FE								
Engine	Information				A10	A20	A40	A50	A70	C10 - C30	C20	E01
All engines	version Denso						1.313.267	1.413.029				
All engines	FOR: (EU), Country Version : General countries; ->year 01/08/96, Hardtop									1.970.198	C10	
All engines	FOR: (AUS)									1.970.2855	C10	
All engines	FOR: (EU), Country Version : General countries; ->year 01/08/96											1.501.793
All engines	FOR: (EU), Country Version : General countries; 01/08/96 ->											1.501.856
2.0 4WD					ENGINE							
Petrol	94	12/97-06/00	3S-FE									
Engine	Information				A10	A20	A40	A50	A70	C10 - C30	C20	E01
All engines	version Denso						1.313.267	1.413.029				
All engines	FOR: (EU), Country Version : General countries; ->year 01/08/96, Hardtop									1.970.198	C10	
All engines	FOR: (AUS)									1.970.2855	C10	
All engines	FOR: (EU), Country Version : General countries; ->year 01/08/96											1.501.793
All engines	01/08/96 ->											1.501.856
2.0 4WD					ENGINE							
Petrol	95	06/94-06/00	3S-FE									
Engine	Information				A10	A20	A40	A50	A70	C10 - C30	C20	E01
All engines	version Denso						1.313.267	1.413.029				
All engines	FOR: (EU), Country Version : General countries; ->year 01/08/96, Hardtop									1.970.198	C10	
All engines	FOR: (AUS)									1.970.2855	C10	
All engines	FOR: (EU), Country Version : General countries; ->year 01/08/96											1.501.793
All engines	FOR: (EU), Country Version : General countries; 01/08/96 ->											1.501.856
2.0 4WD					ENGINE							
Petrol	99	01/94-09/99	3S-FE									
Engine	Information				A10	A20	A40	A50	A70	C10 - C30	C20	E01
All engines	version Denso						1.313.267	1.413.029				
All engines	FOR: (EU), Country Version : General countries; ->year 01/08/96, Hardtop									1.970.198	C10	
All engines	FOR: (AUS)									1.970.2855	C10	
All engines	FOR: (EU), Country Version : General countries; ->year 01/08/96											1.501.793
All engines	FOR: (EU), Country Version : General countries; 01/08/96 ->											1.501.856

A10 CONDENSER	A20 CONTACT SET	A40 DISTRIBUTOR CAP	A50 ROTOR	A70 PICK-UP
C10 COIL	C20 IGNITION MODULE	C30 ELECTRONIC IGNITION KIT	E01 IGNITION CABLE SET	

Vehicle	alim.	kW	Date	Engine	FUNCTIONS ON THE VEHICLE							
					A10	A20	A40	A50	A70	C10 - C30	C20	E01
RAV 4 II												
1.8	Petrol	92	08/00-11/05	1ZZFE								
ENGINE												
Engine	Information				A10	A20	A40	A50	A70	C10 - C30	C20	E01
All engines	x 4, COIL ON PLUG									1,970.461	C10	
2.0	Petrol	110	09/00-12/03	1AZ-FE								
ENGINE												
Engine	Information				A10	A20	A40	A50	A70	C10 - C30	C20	E01
All engines	x 4, COIL ON PLUG, FOR: (J)									1,970.466	C10	
2.0 4WD	Petrol	110	05/00-11/05	1AZ-FE								
ENGINE												
Engine	Information				A10	A20	A40	A50	A70	C10 - C30	C20	E01
All engines	x 4, COIL ON PLUG, FOR: (J)									1,970.466	C10	
2.4 4WD	Petrol	112	08/03-11/05	2AZ-FE								
ENGINE												
Engine	Information				A10	A20	A40	A50	A70	C10 - C30	C20	E01
All engines	Qty: 4									1,970.466	C10	
All engines	x 4, COIL ON PLUG, FOR: (J)									1,970.466	C10	
RAV 4 III												
2.0	Petrol	109	03/09-06/13	3ZR-FAE								
ENGINE												
Engine	Information				A10	A20	A40	A50	A70	C10 - C30	C20	E01
All engines	x 4, COIL ON PLUG									1,970.536	C10	
2.0	Petrol	116	12/08-06/13	3ZR-FAE								
ENGINE												
Engine	Information				A10	A20	A40	A50	A70	C10 - C30	C20	E01
All engines	x 4, COIL ON PLUG									1,970.536	C10	
2.0 4WD	Petrol	109	03/09-06/13	3ZR-FAE								
ENGINE												
Engine	Information				A10	A20	A40	A50	A70	C10 - C30	C20	E01
All engines	x 4, COIL ON PLUG									1,970.536	C10	
2.0 4WD	Petrol	112	02/06-06/13	1AZ-FE								
ENGINE												
Engine	Information				A10	A20	A40	A50	A70	C10 - C30	C20	E01
All engines	x 4, COIL ON PLUG, FOR: (J)									1,970.466	C10	
2.0 4WD	Petrol	116	12/08-06/13	3ZR-FAE								
ENGINE												
Engine	Information				A10	A20	A40	A50	A70	C10 - C30	C20	E01
All engines	x 4, COIL ON PLUG									1,970.536	C10	
2.0 VVT-i [CHN]	Petrol	112	03/09->	1AZ-FE								
ENGINE												
Engine	Information				A10	A20	A40	A50	A70	C10 - C30	C20	E01
All engines	Qty: 4									1,970.458	C10	
2.4	Petrol	125	11/05-12/13	2AZ-FE								
ENGINE												
Engine	Information				A10	A20	A40	A50	A70	C10 - C30	C20	E01
All engines	x 4, COIL ON PLUG, FOR: (J)									1,970.466	C10	
2.4 4WD	Petrol	125	11/05-06/13	2AZ-FE								
ENGINE												
Engine	Information				A10	A20	A40	A50	A70	C10 - C30	C20	E01
All engines	x 4, COIL ON PLUG, FOR: (J)									1,970.466	C10	
2.4 VVTi [CHN]	Petrol	125	03/09->	2AR-FE								
ENGINE												
Engine	Information				A10	A20	A40	A50	A70	C10 - C30	C20	E01
All engines	Qty: 4									1,970.458	C10	
2.5	Petrol	133	12/08->	2AR-FE								
ENGINE												
Engine	Information				A10	A20	A40	A50	A70	C10 - C30	C20	E01
All engines	Qty: 4									1,970.537	C10	

A10 CONDENSER	A20 CONTACT SET	A40 DISTRIBUTOR CAP	A50 ROTOR	A70 PICK-UP
C10 COIL	C20 IGNITION MODULE	C30 ELECTRONIC IGNITION KIT	E01 IGNITION CABLE SET	

The present application list is a brief version. For the detailed information about the possibility of installation on a specific vehicle, please refer to our web-catalogue <http://catalogo.facet.eu/>



					FUNCTIONS ON THE VEHICLE							
Vehicle	alim.	kW	Date	Engine								
3.5 4WD												
	Petrol	201	11/05-12/12	ENGINE 2GR-FE								
Engine	Information				A10	A20	A40	A50	A70	C10 - C30	C20	E01
All engines	x 6, COIL ON PLUG									1.970.538	C10	
3.5 4WD												
	Petrol	206	08/07->	ENGINE 2GR-FE								
Engine	Information				A10	A20	A40	A50	A70	C10 - C30	C20	E01
All engines	Qty: 6									1.970.538	C10	
RAV 4 IV												
2.0												
	Petrol	105	12/12->	ENGINE 3ZR-FE								
Engine	Information				A10	A20	A40	A50	A70	C10 - C30	C20	E01
All engines	x 4, COIL ON PLUG									1.970.536	C10	
2.0												
	Petrol	107	12/12->	ENGINE 3ZR-FE								
Engine	Information				A10	A20	A40	A50	A70	C10 - C30	C20	E01
All engines	x 4, COIL ON PLUG									1.970.536	C10	
2.0 4WD												
	Petrol	107	12/12->	ENGINE 3ZR-FE								
Engine	Information				A10	A20	A40	A50	A70	C10 - C30	C20	E01
All engines	x 4, COIL ON PLUG									1.970.536	C10	
2.0 4WD												
	Petrol	111	12/12->	ENGINE 3ZR-FAE								
Engine	Information				A10	A20	A40	A50	A70	C10 - C30	C20	E01
All engines	x 4, COIL ON PLUG									1.970.536	C10	
2.0 4WD												
	Petrol	112	04/15->	ENGINE 3ZR-FAE								
Engine	Information				A10	A20	A40	A50	A70	C10 - C30	C20	E01
All engines	x 4, COIL ON PLUG									1.970.536	C10	
2.5												
	Petrol	132	12/12-11/18	ENGINE 2AR-FE								
Engine	Information				A10	A20	A40	A50	A70	C10 - C30	C20	E01
All engines	x 4, COIL ON PLUG, FOR: (J)									1.970.537	C10	
2.5 4WD												
	Petrol	131	12/12-12/18	ENGINE 2AR-FE								
Engine	Information				A10	A20	A40	A50	A70	C10 - C30	C20	E01
All engines	Qty: 4									1.970.537	C10	
2.5 4WD												
	Petrol	132	12/12->	ENGINE 2AR-FE								
Engine	Information				A10	A20	A40	A50	A70	C10 - C30	C20	E01
All engines	x 4, COIL ON PLUG, FOR: (J)									1.970.537	C10	
2.5 Hybrid												
	Petrol/ Electric	114	10/15-11/18	ENGINE 2AR-FXE								
Engine	Information				A10	A20	A40	A50	A70	C10 - C30	C20	E01
All engines	x 4, COIL ON PLUG, FOR: (J)									1.970.537	C10	
2.5 Hybrid												
	Petrol/ Electric	145	11/15-11/18	ENGINE 2AR-FXE								
Engine	Information				A10	A20	A40	A50	A70	C10 - C30	C20	E01
All engines	x 4, COIL ON PLUG, FOR: (J)									1.970.537	C10	
2.5 Hybrid 4WD												
	Petrol/ Electric	114	10/15-12/18	ENGINE 2AR-FXE								
Engine	Information				A10	A20	A40	A50	A70	C10 - C30	C20	E01
All engines	x 4, COIL ON PLUG, FOR: (J)									1.970.537	C10	
SIENNA												
2.7												
	Petrol	140	09/10-07/13	ENGINE 1AR-FE								
Engine	Information				A10	A20	A40	A50	A70	C10 - C30	C20	E01
All engines	x 4, COIL ON PLUG, FOR: (J)									1.970.537	C10	

A10 CONDENSER	A20 CONTACT SET	A40 DISTRIBUTOR CAP	A50 ROTOR	A70 PICK-UP
C10 COIL	C20 IGNITION MODULE	C30 ELECTRONIC IGNITION KIT	E01 IGNITION CABLE SET	

Vehicle	alim.	kW	Date	Engine	FUNCTIONS ON THE VEHICLE									
					A10	A20	A40	A50	A70	C10 - C30	C20	E01		
ENGINE														
3.5	Petrol	196	02/10->	2GR-FE										
Engine					A10	A20	A40	A50	A70	C10 - C30	C20	E01		
All engines										1.970.538	C10			
ENGINE														
3.5	Petrol	198	01/10->	2GR-FE										
Engine					A10	A20	A40	A50	A70	C10 - C30	C20	E01		
All engines										1.970.538	C10			
ENGINE														
3.5 4WD	Petrol	196	01/10->	2GR-FE										
Engine					A10	A20	A40	A50	A70	C10 - C30	C20	E01		
All engines										1.970.538	C10			
ENGINE														
3.5 4WD	Petrol	198	01/10->	2GR-FE										
Engine					A10	A20	A40	A50	A70	C10 - C30	C20	E01		
All engines										1.970.538	C10			
STARLET														
ENGINE														
1.0	Petrol	33	02/78-09/84	6A25BFXS										
Engine					A10	A20	A40	A50	A70	C10 - C30	C20	E01		
All engines								1.406.014R						
ENGINE														
1.0	Petrol	40	12/89-12/92	1E										
Engine					A10	A20	A40	A50	A70	C10 - C30	C20	E01		
All engines							1.313.240	1.413.014						
All engines							1.313.275							
All engines										1.970.199	C10		1.501.393	
ENGINE														
1.2 S	Petrol	39	10/78-08/82	3K-H										
Engine					A10	A20	A40	A50	A70	C10 - C30	C20	E01		
All engines								1.406.014R						
ENGINE														
1.3	Petrol	55	01/96-07/99	2E, 4E-FE										
Engine					A10	A20	A40	A50	A70	C10 - C30	C20	E01		
Eng. 4E-FE							1.313.265	1.413.029						
All engines										1.970.199	C10			
Eng. 4E-FE													1.501.435	
ENGINE														
1.3	Petrol	63	01/96-07/99	4E-FE										
Engine					A10	A20	A40	A50	A70	C10 - C30	C20	E01		
All engines							1.313.265	1.413.029						
All engines										1.970.199	C10		1.501.435	
ENGINE														
1.3 12V	Petrol	55	12/89-12/92	2E, 2E-E										
Engine					A10	A20	A40	A50	A70	C10 - C30	C20	E01		
All engines							1.313.122							
All engines							1.313.275							
All engines								1.413.029						
All engines										1.970.199	C10		1.501.823	
ENGINE														
1.3 12V Cat	Petrol	55	12/89-03/96	2E-E										
Engine					A10	A20	A40	A50	A70	C10 - C30	C20	E01		
All engines							1.313.122							
All engines							1.313.275							
All engines								1.413.029						
All engines										1.970.199	C10		1.501.823	
ENGINE														
1.3 XL	Petrol	52	12/89-12/91	2E										
Engine					A10	A20	A40	A50	A70	C10 - C30	C20	E01		
All engines							1.313.122	1.413.029						
All engines										1.970.199	C10		1.501.823	

A10	CONDENSER	A20	CONTACT SET	A40	DISTRIBUTOR CAP	A50	ROTOR	A70	PICK-UP
C10	COIL	C20	IGNITION MODULE	C30	ELECTRONIC IGNITION KIT	E01	IGNITION CABLE SET		

The present application list is a brief version. For the detailed information about the possibility of installation on a specific vehicle, please refer to our web-catalogue <http://catalogo.facet.eu/>

					FUNCTIONS ON THE VEHICLE												
Vehicle	alim.	kW	Date	Engine	 A10	 A20	 A40	 A50	 A70	 C10 - C30	 C20	 E01					
STOUT																	
2.2	Petrol	69	04/88-02/00	ENGINE 4Y													
Engine	Information				A10	A20	A40	A50	A70	C10 - C30	C20	E01					
All engines	version Denso						1.313.114										
All engines	->year 01/03/89							1.413.014									
All engines	01/03/89 ->							1.413.030									
SUPRA																	
2.0	Petrol	145	06/19->	ENGINE B48L													
Engine	Information				A10	A20	A40	A50	A70	C10 - C30	C20	E01					
All engines	x 4, COIL ON PLUG									1.970.632	C10						
2.0	Petrol	190	06/19->	ENGINE B48H													
Engine	Information				A10	A20	A40	A50	A70	C10 - C30	C20	E01					
All engines	x 4, COIL ON PLUG									1.970.632	C10						
3.0 GR	Petrol	250	03/19->	ENGINE B58													
Engine	Information				A10	A20	A40	A50	A70	C10 - C30	C20	E01					
All engines	x 6, COIL ON PLUG									1.970.632	C10						
3.0 i	Petrol	168	05/93-07/02	ENGINE 2JZ-GE													
Engine	Information				A10	A20	A40	A50	A70	C10 - C30	C20	E01					
All engines										1.970.203	C10						
T100																	
3.0 i [USA]	Petrol	105	08/92-08/94	ENGINE 3VZE													
Engine	Information				A10	A20	A40	A50	A70	C10 - C30	C20	E01					
All engines										1.970.203	C10						
TARAGO MPV / SPACE																	
2.4 VVTi	Petrol	115	02/00-12/05	ENGINE 2AZ-FE													
Engine	Information				A10	A20	A40	A50	A70	C10 - C30	C20	E01					
All engines	CVT, Qty: 4									1.970.458	C10						
All engines	Qty: 4									1.970.466	C10						
TERCEL																	
1.5	Petrol	52	08/83-05/85	ENGINE 3A-C													
Engine	Information				A10	A20	A40	A50	A70	C10 - C30	C20	E01					
All engines										1.970.197	C10						
1.5 4WD	Petrol	50	09/82-01/88	ENGINE 3A-C													
Engine	Information				A10	A20	A40	A50	A70	C10 - C30	C20	E01					
All engines										1.970.197	C10						
1.5 i [USA]	Petrol	0	01/89->	ENGINE 3EE													
Engine	Information				A10	A20	A40	A50	A70	C10 - C30	C20	E01					
All engines	version Denso						1.313.275	1.413.029									
All engines	->year 01/12/90									1.970.197	C10						
All engines	01/12/90 ->									1.970.198	C10						
All engines												1.501.393					
TRUCK																	
2.4	Petrol	84	08/88-11/95	ENGINE 22RE													
Engine	Information				A10	A20	A40	A50	A70	C10 - C30	C20	E01					
All engines	01/08/92 ->									1.970.203	C10						
2.4 i [USA]	Petrol	0	01/88->	ENGINE 22R, 22RE													
Engine	Information				A10	A20	A40	A50	A70	C10 - C30	C20	E01					
All engines	->year 01/08/92, version Denso						1.313.099										
Eng. 22RE	01/08/92 ->, version Denso						1.313.273										
Eng. 22R	version Denso							1.413.027									
A10	CONDENSER	A20	CONTACT SET	A40	DISTRIBUTOR CAP	A50	ROTOR	A70	PICK-UP	C10	COIL	C20	IGNITION MODULE	C30	ELECTRONIC IGNITION KIT	E01	IGNITION CABLE SET

Vehicle	alim.	kW	Date	Engine	FUNCTIONS ON THE VEHICLE									
					A10	A20	A40	A50	A70	C10 - C30	C20	E01		
ENGINE														
2.4 i [USA]	Petrol	0	01/88->	22R, 22RE										
Engine	Information				A10	A20	A40	A50	A70	C10 - C30	C20	E01		
Eng. 22RE	01/08/92 ->									1.970.203	C10			
ENGINE														
3.0	Petrol	105	08/88-11/95	3VZ-E										
Engine	Information				A10	A20	A40	A50	A70	C10 - C30	C20	E01		
All engines	->year 01/08/91									1.970.202	C10			
All engines	01/08/91 ->									1.970.203	C10			
ENGINE														
3.0 i [USA]	Petrol	0	01/88->	3VZ-E										
Engine	Information				A10	A20	A40	A50	A70	C10 - C30	C20	E01		
All engines	->year 01/08/91									1.970.202	C10			
All engines	01/08/91 ->									1.970.203	C10			
URBAN CRUISER														
ENGINE														
1.33	Petrol	73	01/09-03/16	1NR-FE										
Engine	Information				A10	A20	A40	A50	A70	C10 - C30	C20	E01		
All engines	x 4, COIL ON PLUG									1.970.537	C10			
ENGINE														
1.33	Petrol	74	04/09-03/16	1NR-FE										
Engine	Information				A10	A20	A40	A50	A70	C10 - C30	C20	E01		
All engines	x 4, COIL ON PLUG									1.970.537	C10			
VENZA														
ENGINE														
2.7	Petrol	136	11/08-11/16	1AR-FE										
Engine	Information				A10	A20	A40	A50	A70	C10 - C30	C20	E01		
All engines	x 4, COIL ON PLUG, FOR: (J)									1.970.537	C10			
ENGINE														
2.7 4WD	Petrol	135	11/08-04/12	1AR-FE										
Engine	Information				A10	A20	A40	A50	A70	C10 - C30	C20	E01		
All engines	x 4, COIL ON PLUG, FOR: (J)									1.970.537	C10			
ENGINE														
2.7 4WD	Petrol	136	11/08-11/16	1AR-FE										
Engine	Information				A10	A20	A40	A50	A70	C10 - C30	C20	E01		
All engines	x 4, COIL ON PLUG, FOR: (J)									1.970.537	C10			
ENGINE														
3.5	Petrol	200	11/08-11/16	2GR-FE										
Engine	Information				A10	A20	A40	A50	A70	C10 - C30	C20	E01		
All engines	MADE BY: (J), x 6, COIL ON PLUG, x 6, COIL ON PLUG									1.970.538	C10			
ENGINE														
3.5 4WD	Petrol	200	11/08-11/16	2GR-FE										
Engine	Information				A10	A20	A40	A50	A70	C10 - C30	C20	E01		
All engines	MADE BY: (J), x 6, COIL ON PLUG, x 6, COIL ON PLUG									1.970.538	C10			
VERSO														
ENGINE														
1.6	Petrol	81	04/09-08/18	1ZR-FAE										
Engine	Information				A10	A20	A40	A50	A70	C10 - C30	C20	E01		
All engines	x 4, COIL ON PLUG									1.970.536	C10			
ENGINE														
1.6	Petrol	97	04/09-08/18	1ZR-FAE										
Engine	Information				A10	A20	A40	A50	A70	C10 - C30	C20	E01		
All engines	x 4, COIL ON PLUG									1.970.536	C10			
ENGINE														
1.8	Petrol	108	04/09-08/18	2ZR-FAE										
Engine	Information				A10	A20	A40	A50	A70	C10 - C30	C20	E01		
All engines	x 4, COIL ON PLUG									1.970.536	C10			
ENGINE														
VVTi	Petrol	108	04/09-08/18	2ZR-FAE										
Engine	Information				A10	A20	A40	A50	A70	C10 - C30	C20	E01		
All engines	x 4, COIL ON PLUG									1.970.536	C10			

A10 CONDENSER	A20 CONTACT SET	A40 DISTRIBUTOR CAP	A50 ROTOR	A70 PICK-UP
C10 COIL	C20 IGNITION MODULE	C30 ELECTRONIC IGNITION KIT	E01 IGNITION CABLE SET	

The present application list is a brief version. For the detailed information about the possibility of installation on a specific vehicle, please refer to our web-catalogue <http://catalogo.facet.eu/>

					FUNCTIONS ON THE VEHICLE							
Vehicle	alim.	kW	Date	Engine	A10	A20	A40	A50	A70	C10 - C30	C20	E01
ENGINE												
VVTi	Petrol	97	04/09-08/18	1ZR-FAE								
Engine	Information				A10	A20	A40	A50	A70	C10 - C30	C20	E01
All engines	x 4, COIL ON PLUG									1.970.536	C10	
VERSOS												
1.33	Petrol	70	11/10-10/16	1NR-FE								
Engine	Information				A10	A20	A40	A50	A70	C10 - C30	C20	E01
All engines	Qty: 4									1.970.537	C10	
VIOS / YARIS												
1.0	Petrol	52	09/05-10/13	1KR-FE								
Engine	Information				A10	A20	A40	A50	A70	C10 - C30	C20	E01
All engines	Qty: 3									1.970.461	C10	
1.3	Petrol	64	09/05-10/13	2NZ-FE, 2SZ-FE								
Engine	Information				A10	A20	A40	A50	A70	C10 - C30	C20	E01
All engines	Qty: 4									1.970.459	C10	
1.3 4WD	Petrol	64	09/05-04/13	2NZ-FE								
Engine	Information				A10	A20	A40	A50	A70	C10 - C30	C20	E01
All engines	Qty: 4									1.970.459	C10	
1.5	Petrol	81	08/07->	1NZ-FE								
Engine	Information				A10	A20	A40	A50	A70	C10 - C30	C20	E01
All engines	Qty: 4									1.970.459	C10	
YARIS I												
1.0	Petrol	48	03/03-09/05	1SZ-FE								
Engine	Information				A10	A20	A40	A50	A70	C10 - C30	C20	E01
All engines	Yaris, x 4, COIL ON PLUG									1.970.459	C10	
1.0	Petrol	50	04/99-09/05	1SZ-FE								
Engine	Information				A10	A20	A40	A50	A70	C10 - C30	C20	E01
All engines	Yaris, x 4, COIL ON PLUG									1.970.459	C10	
1.3	Petrol	63	08/99-11/05	2NZ-FE								
Engine	Information				A10	A20	A40	A50	A70	C10 - C30	C20	E01
All engines	Yaris, x 4, COIL ON PLUG									1.970.459	C10	
1.3	Petrol	64	04/02-09/05	2SZ-FE								
Engine	Information				A10	A20	A40	A50	A70	C10 - C30	C20	E01
All engines	Yaris, x 4, COIL ON PLUG									1.970.459	C10	
1.5	Petrol	110	03/00-07/05	1NZ-FE								
Engine	Information				A10	A20	A40	A50	A70	C10 - C30	C20	E01
All engines	Qty: 4									1.970.459	C10	
1.5	Petrol	77	01/03-11/05	1NZ-FE								
Engine	Information				A10	A20	A40	A50	A70	C10 - C30	C20	E01
All engines	Yaris, x 4, COIL ON PLUG									1.970.459	C10	
1.5	Petrol	78	04/01-09/05	1NZ-FE								
Engine	Information				A10	A20	A40	A50	A70	C10 - C30	C20	E01
All engines	Yaris, x 4, COIL ON PLUG									1.970.459	C10	

A10 CONDENSER	A20 CONTACT SET	A40 DISTRIBUTOR CAP	A50 ROTOR	A70 PICK-UP
C10 COIL	C20 IGNITION MODULE	C30 ELECTRONIC IGNITION KIT	E01 IGNITION CABLE SET	

Vehicle	alim.	kW	Date	Engine	FUNCTIONS ON THE VEHICLE							
					A10	A20	A40	A50	A70	C10 - C30	C20	E01

YARIS II

Vehicle	alim.	kW	Date	ENGINE
1.0 GPL	Petrol/ Liquified Petro- leum Gas (LPG)	51	01/06-12/11	1KR-FE

Engine	Information	A10	A20	A40	A50	A70	C10 - C30	C20	E01
All engines	Yaris, x 3, COIL ON PLUG						1,970.461	C10	

Vehicle	alim.	kW	Date	ENGINE
1.0 VVT-i	Petrol	51	08/05-12/11	1KR-FE

Engine	Information	A10	A20	A40	A50	A70	C10 - C30	C20	E01
All engines	Yaris, x 3, COIL ON PLUG						1,970.461	C10	

Vehicle	alim.	kW	Date	ENGINE
1.3 4WD	Petrol	64	08/07-11/10	2NZ-FE

Engine	Information	A10	A20	A40	A50	A70	C10 - C30	C20	E01
All engines	Qty: 4						1,970.459	C10	

Vehicle	alim.	kW	Date	ENGINE
1.3 VVT-i	Petrol	63	11/05-12/12	2NZ-FE, 2SZ-FE

Engine	Information	A10	A20	A40	A50	A70	C10 - C30	C20	E01
All engines	Qty: 4						1,970.459	C10	

Vehicle	alim.	kW	Date	ENGINE
1.3 VVT-i	Petrol	64	08/05-11/10	2SZ-FE

Engine	Information	A10	A20	A40	A50	A70	C10 - C30	C20	E01
All engines	Yaris, x 4, COIL ON PLUG						1,970.459	C10	

Vehicle	alim.	kW	Date	ENGINE
1.33 VVT-i	Petrol	73	07/10-05/11	1NR-FE

Engine	Information	A10	A20	A40	A50	A70	C10 - C30	C20	E01
All engines	Yaris, x 4, COIL ON PLUG						1,970.537	C10	

Vehicle	alim.	kW	Date	ENGINE
1.33 VVT-i	Petrol	74	11/08-12/11	1NR-FE

Engine	Information	A10	A20	A40	A50	A70	C10 - C30	C20	E01
All engines	Yaris, x 4, COIL ON PLUG						1,970.537	C10	

Vehicle	alim.	kW	Date	ENGINE
1.5	Petrol	80	11/05->	1NZ-FE

Engine	Information	A10	A20	A40	A50	A70	C10 - C30	C20	E01
All engines	Qty: 4						1,970.459	C10	

Vehicle	alim.	kW	Date	ENGINE
1.5	Petrol	81	11/05->	1NZ-FE

Engine	Information	A10	A20	A40	A50	A70	C10 - C30	C20	E01
All engines	Qty: 4						1,970.459	C10	

Vehicle	alim.	kW	Date	ENGINE
1.6 [CHN]	Petrol	0	05/08->	1ZR-FE

Engine	Information	A10	A20	A40	A50	A70	C10 - C30	C20	E01
All engines	Qty: 4, no specific info conc. application available						1,970.536	C10	

Vehicle	alim.	kW	Date	ENGINE
1.8 VVTi	Petrol	98	01/07-12/11	2ZR-FE

Engine	Information	A10	A20	A40	A50	A70	C10 - C30	C20	E01
All engines	Yaris, x 4, COIL ON PLUG						1,970.536	C10	

YARIS III

Vehicle	alim.	kW	Date	ENGINE
1.0	Petrol	51	12/10->	1KR-FE

Engine	Information	A10	A20	A40	A50	A70	C10 - C30	C20	E01
All engines	Yaris, x 3, COIL ON PLUG						1,970.461	C10	

Vehicle	alim.	kW	Date	ENGINE
1.0 VVTi	Petrol	51	07/14->	1KR-FE









Engine	Information	A10	A20	A40	A50	A70	C10 - C30	C20	E01
All engines	Yaris, x 3, COIL ON PLUG, FOR: (J)						1,970.459	C10	

Vehicle	alim.	kW	Date	ENGINE
1.3	Petrol	63	12/11->	2NZ-FE

Engine	Information	A10	A20	A40	A50	A70	C10 - C30	C20	E01
All engines	Qty: 4						1,970.459	C10	

A10 CONDENSER	A20 CONTACT SET	A40 DISTRIBUTOR CAP	A50 ROTOR	A70 PICK-UP
C10 COIL	C20 IGNITION MODULE	C30 ELECTRONIC IGNITION KIT	E01 IGNITION CABLE SET	

The present application list is a brief version. For the detailed information about the possibility of installation on a specific vehicle, please refer to our web-catalogue <http://catalogo.facet.eu/>









				FUNCTIONS ON THE VEHICLE								
Vehicle	alim.	kW	Date	Engine								
				ENGINE								
1.3	Petrol	73	09/11->	1NR-FE								
Engine		Information			A10	A20	A40	A50	A70	C10 - C30	C20	E01
All engines		Yaris, x 4, COIL ON PLUG								1.970.537	C10	
				ENGINE								
1.3 4WD	Petrol	70	12/10->	1NR-FE								
Engine		Information			A10	A20	A40	A50	A70	C10 - C30	C20	E01
All engines		Qty: 4								1.970.537	C10	
				ENGINE								
1.3 VVTi	Petrol	73	10/12->	1NR-FE								
Engine		Information			A10	A20	A40	A50	A70	C10 - C30	C20	E01
All engines		Yaris, x 4, COIL ON PLUG								1.970.537	C10	
				ENGINE								
1.5	Petrol	80	12/10->	1NZ-FE								
Engine		Information			A10	A20	A40	A50	A70	C10 - C30	C20	E01
All engines		Qty: 4								1.970.459	C10	
				ENGINE								
1.5	Petrol	82	03/17->	2NR-FKE								
Engine		Information			A10	A20	A40	A50	A70	C10 - C30	C20	E01
All engines		Yaris, x 4, COIL ON PLUG								1.970.537	C10	
				ENGINE								
1.5 Hybrid	Petrol/ Electric	54	04/15->	1NZ-FXE								
Engine		Information			A10	A20	A40	A50	A70	C10 - C30	C20	E01
All engines		Yaris, x 4, COIL ON PLUG								1.970.459	C10	
				ENGINE								
1.5 Hybrid	Petrol/ Electric	55	03/12->	1NZ-FXE								
Engine		Information			A10	A20	A40	A50	A70	C10 - C30	C20	E01
All engines		Yaris, x 4, COIL ON PLUG								1.970.459	C10	
				ENGINE								
1.5 VVTi	Petrol	82	03/17->	2NR-FKE								
Engine		Information			A10	A20	A40	A50	A70	C10 - C30	C20	E01
All engines		Yaris, x 4, COIL ON PLUG								1.970.537	C10	
				ENGINE								
1.8 GRMN	Petrol	156	09/17->	2ZR-FE								
Engine		Information			A10	A20	A40	A50	A70	C10 - C30	C20	E01
All engines		Yaris, x 4, COIL ON PLUG								1.970.536	C10	
				ENGINE								
YARIS VERSO				ENGINE								
1.3	Petrol	62	11/02-09/05	2NZ-FE								
Engine		Information			A10	A20	A40	A50	A70	C10 - C30	C20	E01
All engines		x 4, COIL ON PLUG								1.970.459	C10	
				ENGINE								
1.3	Petrol	63	08/99-10/02	2NZ-FE								
Engine		Information			A10	A20	A40	A50	A70	C10 - C30	C20	E01
All engines		x 4, COIL ON PLUG								1.970.459	C10	
				ENGINE								
1.3 VVTi	Petrol	62	04/03-09/05	2NZ-FE								
Engine		Information			A10	A20	A40	A50	A70	C10 - C30	C20	E01
All engines		x 4, COIL ON PLUG								1.970.459	C10	
				ENGINE								
1.3 VVTi	Petrol	63	03/00-09/05	2NZ-FE								
Engine		Information			A10	A20	A40	A50	A70	C10 - C30	C20	E01
All engines		x 4, COIL ON PLUG								1.970.459	C10	
				ENGINE								
1.5	Petrol	77	03/00-09/05	1NZ-FE								
Engine		Information			A10	A20	A40	A50	A70	C10 - C30	C20	E01
All engines		x 4, COIL ON PLUG								1.970.459	C10	

A10 CONDENSER	A20 CONTACT SET	A40 DISTRIBUTOR CAP	A50 ROTOR	A70 PICK-UP
C10 COIL	C20 IGNITION MODULE	C30 ELECTRONIC IGNITION KIT	E01 IGNITION CABLE SET	

Vehicle	alim.	kW	Date	Engine	FUNCTIONS ON THE VEHICLE								
					A10	A20	A40	A50	A70	C10 - C30	C20	E01	
ENGINE													
1.5	Petrol	78	03/00-09/05	1NZ-FE									
ENGINE													
Engine		Information			A10	A20	A40	A50	A70	C10 - C30	C20	E01	
All engines		x 4, COIL ON PLUG								1.970.459	C10		
ENGINE													
1.5	Petrol	80	08/02-09/05	1NZ-FE									
ENGINE													
Engine		Information			A10	A20	A40	A50	A70	C10 - C30	C20	E01	
All engines		Qty: 4								1.970.459	C10		
ENGINE													
1.5	Petrol	81	01/00-07/02	1NZ-FE									
ENGINE													
Engine		Information			A10	A20	A40	A50	A70	C10 - C30	C20	E01	
All engines		Qty: 4								1.970.459	C10		
ENGINE													
1.5 VVTi	Petrol	78	03/00-03/03	1NZ-FE									
ENGINE													
Engine		Information			A10	A20	A40	A50	A70	C10 - C30	C20	E01	
All engines		x 4, COIL ON PLUG								1.970.459	C10		

A10	CONDENSER	A20	CONTACT SET	A40	DISTRIBUTOR CAP	A50	ROTOR	A70	PICK-UP
C10	COIL	C20	IGNITION MODULE	C30	ELECTRONIC IGNITION KIT	E01	IGNITION CABLE SET		

The present application list is a brief version. For the detailed information about the possibility of installation on a specific vehicle, please refer to our web-catalogue <http://catalogo.facet.eu/>

				FUNCTIONS ON THE VEHICLE								
Vehicle	alim.	kW	Date	Engine	 A10	 A20	 A40	 A50	 A70	 C10 - C30	 C20	 E01
1300												
1.3	Petrol	46	01/65-12/70	ENGINE --								
Engine	Information			A10	A20	A40	A50	A70	C10 - C30	C20	E01	
All engines						1.328.075	1.428.006					
1.3 TC												
1.3 TC	Petrol	56	01/67-12/70	ENGINE --, GE1EH								
Engine	Information			A10	A20	A40	A50	A70	C10 - C30	C20	E01	
All engines						1.328.075	1.428.006					
1500												
1.5	Petrol	42	10/70-12/74	ENGINE --, 1EL								
Engine	Information			A10	A20	A40	A50	A70	C10 - C30	C20	E01	
All engines						1.328.075	1.428.006					
1.5												
1.5	Petrol	49	01/72-12/74	ENGINE --, 1EH								
Engine	Information			A10	A20	A40	A50	A70	C10 - C30	C20	E01	
All engines						1.328.075	1.428.006					
2.5 PI												
2.5	Petrol	90	10/68-10/75	ENGINE --, 25PI								
Engine	Information			A10	A20	A40	A50	A70	C10 - C30	C20	E01	
All engines							1.428.007					
2.5												
2.5	Petrol	99	01/68-12/75	ENGINE 25PI								
Engine	Information			A10	A20	A40	A50	A70	C10 - C30	C20	E01	
All engines							1.428.007					
2000												
2.0	Petrol	65	03/72-04/75	ENGINE 20TC								
Engine	Information			A10	A20	A40	A50	A70	C10 - C30	C20	E01	
All engines							1.428.007					
2.0												
2.0	Petrol	66	01/68-12/75	ENGINE --, 20TC								
Engine	Information			A10	A20	A40	A50	A70	C10 - C30	C20	E01	
All engines							1.428.007					
2.0 TC												
2.0 TC	Petrol	68	03/72-12/75	ENGINE --								
Engine	Information			A10	A20	A40	A50	A70	C10 - C30	C20	E01	
All engines							1.428.007					
GT6												
MKI	Petrol	70	01/66-12/68	ENGINE KE1L								
Engine	Information			A10	A20	A40	A50	A70	C10 - C30	C20	E01	
All engines							1.412.090					
MK II												
MK II	Petrol	77	12/68-12/70	ENGINE KE1L, KE2L								
Engine	Information			A10	A20	A40	A50	A70	C10 - C30	C20	E01	
All engines							1.412.090					
MK III												
MK III	Petrol	71	12/72-12/73	ENGINE KE2L								
Engine	Information			A10	A20	A40	A50	A70	C10 - C30	C20	E01	
All engines							1.412.090					
MK III												
MK III	Petrol	77	12/71-12/72	ENGINE KE2L								
Engine	Information			A10	A20	A40	A50	A70	C10 - C30	C20	E01	
All engines							1.412.090					

A10 CONDENSER	A20 CONTACT SET	A40 DISTRIBUTOR CAP	A50 ROTOR	A70 PICK-UP
C10 COIL	C20 IGNITION MODULE	C30 ELECTRONIC IGNITION KIT	E01 IGNITION CABLE SET	

Vehicle	alim.	kW	Date	Engine	FUNCTIONS ON THE VEHICLE									
					A10	A20	A40	A50	A70	C10 - C30	C20	E01		
HERALD														
1200	Petrol	29	01/61-10/67	ENGINE --, AJM										
Engine Information					A10	A20	A40	A50	A70	C10 - C30	C20	E01		
All engines						1.228.083MHV	1.328.075	1.428.006						
1200														
1200	Petrol	35	01/68-12/69	ENGINE AJM										
Engine Information					A10	A20	A40	A50	A70	C10 - C30	C20	E01		
All engines							1.328.075	1.428.006						
1200														
1200	Petrol	46	01/67-12/68	ENGINE --										
Engine Information					A10	A20	A40	A50	A70	C10 - C30	C20	E01		
All engines							1.328.075	1.428.006						
13/60														
13/60	Petrol	46	01/67-12/71	ENGINE --										
Engine Information					A10	A20	A40	A50	A70	C10 - C30	C20	E01		
All engines							1.328.075	1.428.006						
SPITFIRE														
1.2	Petrol	49	12/64-01/67	ENGINE AJM										
Engine Information					A10	A20	A40	A50	A70	C10 - C30	C20	E01		
All engines								1.412.090						
1.2 MK I														
1.2 MK I	Petrol	46	10/62-12/65	ENGINE AJM										
Engine Information					A10	A20	A40	A50	A70	C10 - C30	C20	E01		
All engines								1.412.090						
1.3														
1.3	Petrol	55	02/67-12/72	ENGINE --, FM3										
Engine Information					A10	A20	A40	A50	A70	C10 - C30	C20	E01		
All engines								1.412.090						
1.5														
1.5	Petrol	51	12/72-11/74	ENGINE --										
Engine Information					A10	A20	A40	A50	A70	C10 - C30	C20	E01		
All engines								1.412.090						
TOLEDO														
1300	Petrol	43	10/70-12/77	ENGINE --										
Engine Information					A10	A20	A40	A50	A70	C10 - C30	C20	E01		
All engines							1.328.075	1.428.006						
1500														
1500	Petrol	46	10/70-12/77	ENGINE --										
Engine Information					A10	A20	A40	A50	A70	C10 - C30	C20	E01		
All engines							1.328.075	1.428.006						
1500														
1500	Petrol	49	01/72-12/77	ENGINE --										
Engine Information					A10	A20	A40	A50	A70	C10 - C30	C20	E01		
All engines							1.328.075	1.428.006						
1500 TC														
1500 TC	Petrol	51	01/71-12/77	ENGINE --										
Engine Information					A10	A20	A40	A50	A70	C10 - C30	C20	E01		
All engines							1.328.075	1.428.006						
TR 2														
2.0	Petrol	66	01/53-12/55	ENGINE --, HCL										
Engine Information					A10	A20	A40	A50	A70	C10 - C30	C20	E01		
All engines								1.428.006						
TR 3														
2.0	Petrol	67	12/55-12/57	ENGINE --, HCL										
Engine Information					A10	A20	A40	A50	A70	C10 - C30	C20	E01		
All engines								1.428.006						

A10	CONDENSER	A20	CONTACT SET	A40	DISTRIBUTOR CAP	A50	ROTOR	A70	PICK-UP
C10	COIL	C20	IGNITION MODULE	C30	ELECTRONIC IGNITION KIT	E01	IGNITION CABLE SET		

The present application list is a brief version. For the detailed information about the possibility of installation on a specific vehicle, please refer to our web-catalogue <http://catalogo.facet.eu/>

Vehicle	alim.	kW	Date	Engine	FUNCTIONS ON THE VEHICLE							
					A10	A20	A40	A50	A70	C10 - C30	C20	E01

TR 3A

2.0	Petrol	70	12/57-12/61	ENGINE
				--

Engine	Information	A10	A20	A40	A50	A70	C10 - C30	C20	E01
All engines					1.428.006				

2.2	Petrol	74	01/59-12/61	ENGINE
				--, HE0H

Engine	Information	A10	A20	A40	A50	A70	C10 - C30	C20	E01
All engines					1.428.006				

TR 4

2.0	Petrol	75	01/61-12/65	ENGINE
				--

Engine	Information	A10	A20	A40	A50	A70	C10 - C30	C20	E01
All engines					1.428.006				

TR 4A

2.2	Petrol	76	12/65-12/67	ENGINE
				--, HE0H

Engine	Information	A10	A20	A40	A50	A70	C10 - C30	C20	E01
All engines					1.428.006				

TR 5

2.5 PI	Petrol	105	01/67-12/68	ENGINE
				--

Engine	Information	A10	A20	A40	A50	A70	C10 - C30	C20	E01
All engines					1.428.007				

TR 6

2.5	Petrol	121	03/69-01/74	ENGINE
				--, CR1H

Engine	Information	A10	A20	A40	A50	A70	C10 - C30	C20	E01
All engines					1.428.007				

2.5	Petrol	90	01/72-12/76	ENGINE
				CF1

Engine	Information	A10	A20	A40	A50	A70	C10 - C30	C20	E01
All engines			1.228.083MHV		1.428.007				

2.5 PI	Petrol	105	01/69-12/76	ENGINE
				--

Engine	Information	A10	A20	A40	A50	A70	C10 - C30	C20	E01
All engines					1.428.007				

VITESSE

1.6	Petrol	51	01/62-12/67	ENGINE
				--

Engine	Information	A10	A20	A40	A50	A70	C10 - C30	C20	E01
All engines					1.412.090, 1.428.007				

2.0	Petrol	70	12/65-12/71	ENGINE
				--, HB1LE

Engine	Information	A10	A20	A40	A50	A70	C10 - C30	C20	E01
All engines					1.412.090, 1.428.007				

2.0	Petrol	77	12/68-12/71	ENGINE
				--, HB1HE

Engine	Information	A10	A20	A40	A50	A70	C10 - C30	C20	E01
All engines					1.412.090, 1.428.007				

A10 CONDENSER	A20 CONTACT SET	A40 DISTRIBUTOR CAP	A50 ROTOR	A70 PICK-UP
C10 COIL	C20 IGNITION MODULE	C30 ELECTRONIC IGNITION KIT	E01 IGNITION CABLE SET	

Vehicle	alim.	kW	Date	Engine	FUNCTIONS ON THE VEHICLE							
					 A10	 A20	 A40	 A50	 A70	 C10 - C30	 C20	 E01

2500

				ENGINE
2.5	Petrol	78	01/72-12/77	--, CF1

Engine	Information	A10	A20	A40	A50	A70	C10 - C30	C20	E01
All engines					1.428.007				









VIXEN

				ENGINE
1800	Petrol	70	01/68-12/68	--

Engine	Information	A10	A20	A40	A50	A70	C10 - C30	C20	E01
All engines					1.428.006				

A10	CONDENSER	A20	CONTACT SET	A40	DISTRIBUTOR CAP	A50	ROTOR	A70	PICK-UP
C10	COIL	C20	IGNITION MODULE	C30	ELECTRONIC IGNITION KIT	E01	IGNITION CABLE SET		

The present application list is a brief version. For the detailed information about the possibility of installation on a specific vehicle, please refer to our web-catalogue <http://catalogo.facet.eu/>

					FUNCTIONS ON THE VEHICLE							
Vehicle	alim.	kW	Date	Engine	 A10	 A20	 A40	 A50	 A70	 C10 - C30	 C20	 E01
ADAM												
1.0	Petrol	66	07/14->	B 10 XFL								
ENGINE												
Engine		Information			A10	A20	A40	A50	A70	C10 - C30	C20	E01
All engines		Qty: 3								1.970.631	C10	
1.0	Petrol	85	07/14-11/18	B 10 XFT, D 10 XFT								
ENGINE												
Engine		Information			A10	A20	A40	A50	A70	C10 - C30	C20	E01
All engines		x 3, COIL ON PLUG								1.970.631	C10	
1.2	Petrol	51	10/12-04/19	A 12 XEL, B 12 XEL, D 12 XEL								
ENGINE												
Engine		Information			A10	A20	A40	A50	A70	C10 - C30	C20	E01
All engines		x 1, COIL ON RAIL								1.970.547	C10	
1.4	Petrol	64	10/12-02/19	A 14 XEL, B 14 XEL, D 14 XEL								
ENGINE												
Engine		Information			A10	A20	A40	A50	A70	C10 - C30	C20	E01
All engines		x 1, COIL ON RAIL								1.970.547	C10	
1.4	Petrol	74	10/12-02/19	A 14 XER, B 14 XER								
ENGINE												
Engine		Information			A10	A20	A40	A50	A70	C10 - C30	C20	E01
All engines		x 1, COIL ON RAIL								1.970.547	C10	
1.4 LPG	Petrol/ Liquified Petroleum Gas (LPG)	64	07/13->	A 14 XEL								
ENGINE												
Engine		Information			A10	A20	A40	A50	A70	C10 - C30	C20	E01
All engines										1.970.547	C10	
1.4 S	Petrol	110	11/14-01/19	B 14 NEH								
ENGINE												
Engine		Information			A10	A20	A40	A50	A70	C10 - C30	C20	E01
All engines		x 1, COIL ON RAIL								1.970.547	C10	
AGILA A												
1.0 12V	Petrol	43	09/00-08/05	Z 10 XE								
ENGINE												
Engine		Information			A10	A20	A40	A50	A70	C10 - C30	C20	E01
All engines		x 3, BOSCH, COIL ON PLUG								1.970.398	C10	
1.0 12V	Petrol	44	02/00-11/06	Z 10 XEP								
ENGINE												
Engine		Information			A10	A20	A40	A50	A70	C10 - C30	C20	E01
All engines		x 3, BOSCH, COIL ON PLUG, 12 Volt, Dia: 55 mm, for pre-resistance								1.970.398	C10	
1.2 16V	Petrol	55	09/00-03/08	Z 12 XE								
ENGINE												
Engine		Information			A10	A20	A40	A50	A70	C10 - C30	C20	E01
All engines		x 4, BOSCH, COIL ON PLUG								1.970.400	C10	
1.2 16V Twinport	Petrol	59	07/04-11/06	Z 12 XEP								
ENGINE												
Engine		Information			A10	A20	A40	A50	A70	C10 - C30	C20	E01
All engines		x 1, BOSCH, COIL ON PLUG, incl. spark plug connector								1.970.400	C10	
AMPERA												
EV 150	Petrol/ Electric	111	03/12->	4ET50, A 14 XFL								
ENGINE												
Engine		Information			A10	A20	A40	A50	A70	C10 - C30	C20	E01
Eng. 4ET50										1.970.547	C10	
Eng. A 14 XFL		x 1, COIL ON RAIL								1.970.547	C10	

A10 CONDENSER	A20 CONTACT SET	A40 DISTRIBUTOR CAP	A50 ROTOR	A70 PICK-UP
C10 COIL	C20 IGNITION MODULE	C30 ELECTRONIC IGNITION KIT	E01 IGNITION CABLE SET	

Vehicle	alim.	kW	Date	Engine	FUNCTIONS ON THE VEHICLE							
					A10	A20	A40	A50	A70	C10 - C30	C20	E01

ASTRA III				
1.4	Petrol	55	09/91-09/93	ENGINE 14 NV

Engine	Information	A10	A20	A40	A50	A70	C10 - C30	C20	E01
All engines	version Bosch			1.306.256	1.406.056R				
All engines								1.965.005	
All engines	->eng. 02BF1476, 19241623								1.501.237
All engines	eng. type 02BF1477, 19241624 ->								1.501.529

1.4 i				
1.4 i	Petrol	44	09/91-09/98	ENGINE C 14 NZ

Engine	Information	A10	A20	A40	A50	A70	C10 - C30	C20	E01
All engines	connector type SAE, version Bosch			1.306.249					
All engines	connector type M4, version Bosch			1.306.256					
All engines	version Bosch				1.406.121R				
All engines	version Lucas				1.428.028R	1.928.202			
All engines							1.970.140	C10	1.965.036
All engines	->eng. 02BF1476, 19241623								1.501.237
All engines	eng. type 02BF1477, 19241624 ->								1.501.529

1.4 i				
1.4 i	Petrol	60	03/91-03/01	ENGINE C 14 SE

Engine	Information	A10	A20	A40	A50	A70	C10 - C30	C20	E01
All engines	version Lucas			1.328.100	1.428.028R				
All engines							1.970.140	C10	1.965.036
All engines	eng. type 02T14053, 02BD1413 ->								1.500.634
All engines	->eng. 02T14052, 19880550								1.501.237
All engines	eng. type 02BD1413, 19280317 ->								1.501.531

1.4 i 16V				
1.4 i 16V	Petrol	66	01/96-03/01	ENGINE X 14 XE

Engine	Information	A10	A20	A40	A50	A70	C10 - C30	C20	E01
All engines									1.501.559

1.4 S				
1.4 S	Petrol	55	09/91-02/98	ENGINE 14 NV

Engine	Information	A10	A20	A40	A50	A70	C10 - C30	C20	E01
All engines	version Bosch			1.306.256	1.406.056R				
All engines								1.965.005	
All engines	->eng. 02BF1476, 19241623								1.501.237
All engines	eng. type 02BF1477, 19241624 ->								1.501.529

1.6				
1.6	Petrol	74	03/94-08/95	ENGINE C 16 SE

Engine	Information	A10	A20	A40	A50	A70	C10 - C30	C20	E01
All engines	->eng. 02BD0920								1.500.634
All engines	eng. type 02BD0921 ->								1.501.531

1.6 i				
1.6 i	Petrol	52	02/93-02/98	ENGINE X 16 SZ

Engine	Information	A10	A20	A40	A50	A70	C10 - C30	C20	E01
All engines	->eng. 02BE6166								1.500.634
All engines	eng. type 02BE6167 ->								1.501.531

1.6 i				
1.6 i	Petrol	55	09/91-03/01	ENGINE C 16 NZ, X 16 SZR

Engine	Information	A10	A20	A40	A50	A70	C10 - C30	C20	E01
Eng. C 16 NZ	version Delco Remy			1.312.073	1.412.100	1.912.010			
Eng. C 16 NZ							1.970.341	C10	1.965.025
Eng. C 16 NZ	->eng. 02V65825								1.500.514
Eng. X 16 SZR	->eng. 02BE6166								1.500.634
Eng. X 16 SZR	eng. type 02BE6167 ->								1.501.531

1.6 i				
1.6 i	Petrol	74	03/92-02/98	ENGINE C 16 SE

Engine	Information	A10	A20	A40	A50	A70	C10 - C30	C20	E01
All engines	->eng. 02BD0920								1.500.634
All engines	eng. type 02BD0921 ->								1.501.531

A10 CONDENSER	A20 CONTACT SET	A40 DISTRIBUTOR CAP	A50 ROTOR	A70 PICK-UP
C10 COIL	C20 IGNITION MODULE	C30 ELECTRONIC IGNITION KIT	E01 IGNITION CABLE SET	

The present application list is a brief version. For the detailed information about the possibility of installation on a specific vehicle, please refer to our web-catalogue <http://catalogo.facet.eu/>

Vehicle	alim.	kW	Date	Engine	FUNCTIONS ON THE VEHICLE							
					A10	A20	A40	A50	A70	C10 - C30	C20	E01

1.6 i 16V	Petrol	74	01/94-09/98	ENGINE X 16 XEL
------------------	--------	-----------	-------------	----------------------------------

Engine	Information	A10	A20	A40	A50	A70	C10 - C30	C20	E01
All engines	->eng. 20C17332								1.500.688
All engines	eng. type 20C17333 ->								1.501.559

1.6 Si	Petrol	74	03/91-12/94	ENGINE C 16 SE
---------------	--------	-----------	-------------	---------------------------------

Engine	Information	A10	A20	A40	A50	A70	C10 - C30	C20	E01
All engines	->eng. 02BD0920								1.500.634
All engines	eng. type 02BD0921 ->								1.501.531

1.8	Petrol	92	09/94-08/96	ENGINE C 18 XE
------------	--------	-----------	-------------	---------------------------------

Engine	Information	A10	A20	A40	A50	A70	C10 - C30	C20	E01
All engines							1.970.272	C10	
All engines	ch. W2000000 ->, ch. W5000000 ->, ch. W8000000 ->								1.501.506
All engines	->ch. V2999999, ->ch. V5999999, ->ch. V8999999								1.501.562

1.8 16V	Petrol	85	11/94-03/01	ENGINE C 18 XEL, X 18 XE
----------------	--------	-----------	-------------	---

Engine	Information	A10	A20	A40	A50	A70	C10 - C30	C20	E01
All engines							1.970.272	C10	
All engines	ch. W2000000 ->, ch. W5000000 ->, ch. W8000000 ->								1.501.506
All engines	->ch. V2999999, ->ch. V5999999, ->ch. V8999999								1.501.562

1.8 i	Petrol	66	09/91-09/98	ENGINE C 18 NZ
--------------	--------	-----------	-------------	---------------------------------

Engine	Information	A10	A20	A40	A50	A70	C10 - C30	C20	E01
All engines	version Bosch			1.306.257	1.406.127R				
All engines	version Ducellier			1.315.084	1.415.103R				
All engines							1.970.140	C10	1.965.036
All engines	FOR: (ZA)						1.970.192	C10	
All engines	eng. type 14349312 ->								1.500.689

1.8 i 16V	Petrol	82	09/95-02/98	ENGINE 18 SE
------------------	--------	-----------	-------------	-------------------------------

Engine	Information	A10	A20	A40	A50	A70	C10 - C30	C20	E01
All engines							1.970.192	C10	

1.8 i 16V	Petrol	85	01/94-02/98	ENGINE C 18 XEL, X 18 XE
------------------	--------	-----------	-------------	---

Engine	Information	A10	A20	A40	A50	A70	C10 - C30	C20	E01
All engines							1.970.272	C10	
All engines	ch. W2000000 ->, ch. W5000000 ->, ch. W8000000 ->								1.501.506
All engines	->ch. V2999999, ->ch. V5999999, ->ch. V8999999								1.501.562

1.8 i 16V	Petrol	92	06/93-02/98	ENGINE C 18 XE
------------------	--------	-----------	-------------	---------------------------------

Engine	Information	A10	A20	A40	A50	A70	C10 - C30	C20	E01
All engines							1.970.272	C10	
All engines	ch. W2000000 ->, ch. W5000000 ->, ch. W8000000 ->								1.501.506
All engines	->ch. V2999999, ->ch. V5999999, ->ch. V8999999								1.501.562

2.0 i	Petrol	85	09/91-09/98	ENGINE C 20 NE
--------------	--------	-----------	-------------	---------------------------------

Engine	Information	A10	A20	A40	A50	A70	C10 - C30	C20	E01
All engines	version Bosch			1.306.257	1.406.127R				
All engines	version Ducellier			1.315.084	1.415.103R				
All engines							1.970.192	C10	
All engines	eng. type 14672354 ->, ->ch. R2999999, ->ch. R3999999, ->ch. R4999999, ->ch. R5999999, ->ch. R6999999, ->ch. R8999999								1.500.689

2.0 i 16V	Petrol	100	01/94-09/98	ENGINE X 20 XEV
------------------	--------	------------	-------------	----------------------------------

Engine	Information	A10	A20	A40	A50	A70	C10 - C30	C20	E01
All engines							1.970.272	C10	
All engines	ch. W2000000 ->, ch. W5000000 ->, ch. W8000000 ->								1.501.506
All engines	->ch. V2999999, ->ch. V5999999, ->ch. V8999999								1.501.562

A10 CONDENSER	A20 CONTACT SET	A40 DISTRIBUTOR CAP	A50 ROTOR	A70 PICK-UP
C10 COIL	C20 IGNITION MODULE	C30 ELECTRONIC IGNITION KIT	E01 IGNITION CABLE SET	

Vehicle	alim.	kW	Date	Engine	FUNCTIONS ON THE VEHICLE									
					A10	A20	A40	A50	A70	C10 - C30	C20	E01		
ENGINE														
2.0 i 16V	Petrol	110	09/91-02/98	C 20 XE										
Engine	Information				A10	A20	A40	A50	A70	C10 - C30	C20	E01		
All engines	->eng. 14137012, version Bosch						1.306.257	1.406.121R						
All engines	eng. type 14137013 ->									1.970.273	C10			
All engines	eng. type 14002935 ->												1.500.688	
ASTRA IV														
ENGINE														
1.2 16V	Petrol	48	02/98-09/00	X 12 XE										
Engine	Information				A10	A20	A40	A50	A70	C10 - C30	C20	E01		
All engines										1.970.400	C10			
ENGINE														
1.2 16V	Petrol	55	09/00-05/05	Z 12 XE										
Engine	Information				A10	A20	A40	A50	A70	C10 - C30	C20	E01		
All engines										1.970.400	C10			
ENGINE														
1.4 16V	Petrol	66	02/98-05/05	X 14 XE, Z 14 XE										
Engine	Information				A10	A20	A40	A50	A70	C10 - C30	C20	E01		
All engines	x 1, COIL ON PLUG, incl. spark plug connector									1.970.399	C10			
ENGINE														
1.4 16V Dualfuel	Petrol/ Liquified Petro- leum Gas (LPG)	66	09/99-06/03	X 14 XE, Z 14 XE										
Engine	Information				A10	A20	A40	A50	A70	C10 - C30	C20	E01		
All engines	x 1, COIL ON PLUG, incl. spark plug connector									1.970.399	C10			
ENGINE														
1.6	Petrol	55	02/98-04/04	X 16 SZR										
Engine	Information				A10	A20	A40	A50	A70	C10 - C30	C20	E01		
All engines													1.501.904	
ENGINE														
1.6	Petrol	62	03/98-05/05	Z 16 SE										
Engine	Information				A10	A20	A40	A50	A70	C10 - C30	C20	E01		
All engines													1.501.904	
ENGINE														
1.6	Petrol	76	12/02-05/05	Z 16 XEP										
Engine	Information				A10	A20	A40	A50	A70	C10 - C30	C20	E01		
All engines	x 1, DELPHI, COIL ON PLUG, incl. spark plug connector									1.970.450	C10			
ENGINE														
1.6 16V	Petrol	74	02/98-10/05	X 16 XEL, Z 16 XE, Z 16 XEP										
Engine	Information				A10	A20	A40	A50	A70	C10 - C30	C20	E01		
Eng. X 16 XEL, Z 16 XE	x 1, COIL ON PLUG, incl. spark plug connector									1.970.399	C10			
Eng. Z 16 XEP										1.970.450	C10			
ENGINE														
1.6 16V	Petrol	76	03/00-10/05	Z 16 XEP										
Engine	Information				A10	A20	A40	A50	A70	C10 - C30	C20	E01		
All engines	x 1, DELPHI, COIL ON PLUG, incl. spark plug connector									1.970.450	C10			
ENGINE														
1.6 Dualfuel	Petrol/ Liquified Petro- leum Gas (LPG)	63	03/98-05/05	Z 16 XE										
Engine	Information				A10	A20	A40	A50	A70	C10 - C30	C20	E01		
All engines										1.970.399	C10			
ENGINE														
1.6 Dualfuel	Petrol/ Liquified Petro- leum Gas (LPG)	74	09/99-08/04	X 16 XEL, Z 16 XE										
Engine	Information				A10	A20	A40	A50	A70	C10 - C30	C20	E01		
All engines	x 1, COIL ON PLUG, incl. spark plug connector									1.970.399	C10			

A10	CONDENSER	A20	CONTACT SET	A40	DISTRIBUTOR CAP	A50	ROTOR	A70	PICK-UP
C10	COIL	C20	IGNITION MODULE	C30	ELECTRONIC IGNITION KIT	E01	IGNITION CABLE SET		

The present application list is a brief version. For the detailed information about the possibility of installation on a specific vehicle, please refer to our web-catalogue <http://catalogo.facet.eu/>

Vehicle	alim.	kW	Date	Engine	FUNCTIONS ON THE VEHICLE							
					A10	A20	A40	A50	A70	C10 - C30	C20	E01

ENGINE				
1.8 16V	Petrol	85	02/98-08/05	X 18 XE1

Engine	Information	A10	A20	A40	A50	A70	C10 - C30	C20	E01
All engines	x 1, COIL ON PLUG, incl. spark plug connector						1.970.508	C10	

ENGINE				
1.8 16V	Petrol	92	02/98-10/05	Z 18 XE

Engine	Information	A10	A20	A40	A50	A70	C10 - C30	C20	E01
All engines	x 1, COIL ON PLUG, incl. spark plug connector						1.970.508	C10	

ENGINE				
1.8 16V Dualfuel	Petrol/ Liquified Petro- leum Gas (LPG)	87	02/98-08/05	Z 18 XE

Engine	Information	A10	A20	A40	A50	A70	C10 - C30	C20	E01
All engines	x 1, COIL ON PLUG, incl. spark plug connector						1.970.508	C10	

ENGINE				
1.8 16V Dualfuel	Petrol/ Liquified Petro- leum Gas (LPG)	92	07/02-08/04	Z 18 XE

Engine	Information	A10	A20	A40	A50	A70	C10 - C30	C20	E01
All engines	x 1, COIL ON PLUG, incl. spark plug connector						1.970.508	C10	

ENGINE				
2.0	Petrol	118	10/99-08/00	X 20 XER

Engine	Information	A10	A20	A40	A50	A70	C10 - C30	C20	E01
All engines							1.970.272	C10	1.501.562

ENGINE				
2.0	Petrol	147	08/02-10/05	Z 20 LET

Engine	Information	A10	A20	A40	A50	A70	C10 - C30	C20	E01
All engines							1.970.507	C10	
All engines	x 1, COIL ON PLUG						1.970.507	C10	

ENGINE				
2.0 16V	Petrol	100	02/98-05/05	X 20 XEV

Engine	Information	A10	A20	A40	A50	A70	C10 - C30	C20	E01
All engines							1.970.272	C10	1.501.562
All engines	x 1, D.I.S.						1.970.272	C10	

ENGINE				
2.0 16V Turbo	Petrol	140	09/00-08/05	Z 20 LET

Engine	Information	A10	A20	A40	A50	A70	C10 - C30	C20	E01
All engines	x 1, COIL ON PLUG						1.970.507	C10	

ENGINE				
2.0 SRI Turbo	Petrol	141	11/01-05/05	Z 20 LET

Engine	Information	A10	A20	A40	A50	A70	C10 - C30	C20	E01
All engines	x 1, COIL ON PLUG						1.970.507	C10	

ENGINE				
2.0 Turbo	Petrol	141	03/02-10/05	Z 20 LET

Engine	Information	A10	A20	A40	A50	A70	C10 - C30	C20	E01
All engines							1.970.507	C10	
All engines	x 1, COIL ON PLUG						1.970.507	C10	

ENGINE				
2.0 Turbo	Petrol	147	08/03-05/05	Z 20 LET

Engine	Information	A10	A20	A40	A50	A70	C10 - C30	C20	E01
All engines							1.970.507	C10	

ASTRA V

ENGINE				
1.2	Petrol	59	08/05-10/10	Z 12 XEP

Engine	Information	A10	A20	A40	A50	A70	C10 - C30	C20	E01
All engines							1.970.400	C10	

ENGINE				
1.4	Petrol	55	08/04-10/10	Z 14 XEL









Engine	Information	A10	A20	A40	A50	A70	C10 - C30	C20	E01
All engines							1.970.400	C10	

A10 CONDENSER	A20 CONTACT SET	A40 DISTRIBUTOR CAP	A50 ROTOR	A70 PICK-UP
C10 COIL	C20 IGNITION MODULE	C30 ELECTRONIC IGNITION KIT	E01 IGNITION CABLE SET	

Vehicle	alim.	kW	Date	Engine	FUNCTIONS ON THE VEHICLE									
					A10	A20	A40	A50	A70	C10 - C30	C20	E01		
ENGINE														
1.4	Petrol	66	01/04-05/09	Z 14 XEP										
Engine	Information				A10	A20	A40	A50	A70	C10 - C30	C20	E01		
All engines	x 1, BOSCH, COIL ON PLUG, incl. spark plug connector									1.970.400	C10			
ENGINE														
1.4 i 16V	Petrol	66	03/05-11/10	Z 14 XEP										
Engine	Information				A10	A20	A40	A50	A70	C10 - C30	C20	E01		
All engines	x 1, BOSCH, COIL ON PLUG, incl. spark plug connector									1.970.400	C10			
ENGINE														
1.6	Petrol	132	08/04-11/10	A 16 LET, Z 16 LET										
Engine	Information				A10	A20	A40	A50	A70	C10 - C30	C20	E01		
All engines	x 1, DELPHI, COIL ON PLUG, incl. spark plug connector									1.970.450	C10			
ENGINE														
1.6	Petrol	77	01/04-11/10	Z 16 XE1, Z 16 XEP										
Engine	Information				A10	A20	A40	A50	A70	C10 - C30	C20	E01		
All engines	x 1, DELPHI, COIL ON PLUG, incl. spark plug connector									1.970.450	C10			
ENGINE														
1.6	Petrol	85	01/04-03/11	A 16 XER, Z 16 XER										
Engine	Information				A10	A20	A40	A50	A70	C10 - C30	C20	E01		
All engines	x 1, DELPHI, COIL ON PLUG, incl. spark plug connector									1.970.450	C10			
Eng. Z 16 XER										1.970.450	C10			
Eng. A 16 XER										1.970.545	C10			
ENGINE														
1.6 i 16V	Petrol	85	10/06-08/11	A 16 XER, Z 16 XER										
Engine	Information				A10	A20	A40	A50	A70	C10 - C30	C20	E01		
All engines	x 1, DELPHI, COIL ON PLUG, incl. spark plug connector									1.970.450	C10			
Eng. Z 16 XER										1.970.450	C10			
ENGINE														
1.6 Turbo	Petrol	132	09/06-09/09	A 16 LET, Z 16 LET										
Engine	Information				A10	A20	A40	A50	A70	C10 - C30	C20	E01		
All engines	x 1, DELPHI, COIL ON PLUG, incl. spark plug connector									1.970.450	C10			
ENGINE														
1.8	Petrol	103	01/04-11/10	A 18 XER, Z 18 XER										
Engine	Information				A10	A20	A40	A50	A70	C10 - C30	C20	E01		
All engines	x 1, DELPHI, COIL ON PLUG, incl. spark plug connector									1.970.450	C10			
Eng. A 18 XER										1.970.545	C10			
ENGINE														
1.8	Petrol	92	01/04-11/10	Z 18 XE										
Engine	Information				A10	A20	A40	A50	A70	C10 - C30	C20	E01		
All engines	x 1, COIL ON PLUG, incl. spark plug connector									1.970.508	C10			
All engines	x 1, COIL ON PLUG, incl. spark plug connector									1.970.508	C10			
ENGINE														
1.8 i 16V	Petrol	103	03/07-11/10	A 18 XER, Z 18 XER										
Engine	Information				A10	A20	A40	A50	A70	C10 - C30	C20	E01		
All engines	x 1, DELPHI, COIL ON PLUG, incl. spark plug connector									1.970.450	C10			
ENGINE														
2.0	Petrol	125	02/06-11/10	Z 20 LEL										
Engine	Information				A10	A20	A40	A50	A70	C10 - C30	C20	E01		
All engines	x 1, COIL ON PLUG									1.970.507	C10			
ENGINE														
2.0 Turbo	Petrol	125	01/04-11/10	Z 20 LER										
Engine	Information				A10	A20	A40	A50	A70	C10 - C30	C20	E01		
All engines	x 1, COIL ON PLUG									1.970.507	C10			
ENGINE														
2.0 Turbo	Petrol	147	01/04-11/10	Z 20 LER										
Engine	Information				A10	A20	A40	A50	A70	C10 - C30	C20	E01		
All engines	x 1, COIL ON PLUG									1.970.507	C10			
ENGINE														
2.0 Turbo	Petrol	177	01/04-05/09	Z 20 LEH										
Engine	Information				A10	A20	A40	A50	A70	C10 - C30	C20	E01		
All engines	x 1, COIL ON PLUG									1.970.507	C10			

A10	CONDENSER	A20	CONTACT SET	A40	DISTRIBUTOR CAP	A50	ROTOR	A70	PICK-UP
C10	COIL	C20	IGNITION MODULE	C30	ELECTRONIC IGNITION KIT	E01	IGNITION CABLE SET		

The present application list is a brief version. For the detailed information about the possibility of installation on a specific vehicle, please refer to our web-catalogue <http://catalogo.facet.eu/>

					FUNCTIONS ON THE VEHICLE							
Vehicle	alim.	kW	Date	Engine	 A10	 A20	 A40	 A50	 A70	 C10 - C30	 C20	 E01
2.0 VXR												
	Petrol	176	02/09-11/10	ENGINE Z 20 LEH								
Engine	Information				A10	A20	A40	A50	A70	C10 - C30	C20	E01
All engines	x 1, COIL ON PLUG									1.970.507	C10	
ASTRA VI												
1.4												
	Petrol	103	10/11-10/15	ENGINE A 14 NET, B 14 NET								
Engine	Information				A10	A20	A40	A50	A70	C10 - C30	C20	E01
All engines	x 1, COIL ON RAIL									1.970.547	C10	
1.4												
	Petrol	64	12/09-10/15	ENGINE A 14 XEL								
Engine	Information				A10	A20	A40	A50	A70	C10 - C30	C20	E01
All engines	x 1, COIL ON RAIL									1.970.547	C10	
1.4												
	Petrol	74	12/09-10/15	ENGINE A 14 XER, B 14 XER								
Engine	Information				A10	A20	A40	A50	A70	C10 - C30	C20	E01
All engines	x 1, COIL ON RAIL									1.970.547	C10	
1.4												
	Petrol	88	10/11-10/15	ENGINE A 14 NEL, B 14 NEL								
Engine	Information				A10	A20	A40	A50	A70	C10 - C30	C20	E01
All engines	x 1, COIL ON RAIL									1.970.547	C10	
1.4 Turbo												
	Petrol	103	12/09-10/15	ENGINE A 14 NET, B 14 NET								
Engine	Information				A10	A20	A40	A50	A70	C10 - C30	C20	E01
All engines	x 1, COIL ON RAIL									1.970.547	C10	
1.4 Turbo												
	Petrol	88	08/10->	ENGINE A 14 NEL								
Engine	Information				A10	A20	A40	A50	A70	C10 - C30	C20	E01
All engines										1.970.547	C10	
All engines	x 1, COIL ON RAIL									1.970.547	C10	
1.6												
	Petrol	132	10/11-10/15	ENGINE A 16 LET								
Engine	Information				A10	A20	A40	A50	A70	C10 - C30	C20	E01
All engines	x 1, COIL ON PLUG									1.970.545	C10	
1.6												
	Petrol	85	12/09-10/15	ENGINE A 16 XER, B 16 XER								
Engine	Information				A10	A20	A40	A50	A70	C10 - C30	C20	E01
All engines	x 1, COIL RAILS									1.970.545	C10	
1.6 Turbo												
	Petrol	132	12/09-10/15	ENGINE A 16 LET								
Engine	Information				A10	A20	A40	A50	A70	C10 - C30	C20	E01
All engines	x 1, COIL ON PLUG									1.970.545	C10	
ASTRA VII												
1.0												
	Petrol	77	07/15->	ENGINE B 10 XFL, D 10 XFL								
Engine	Information				A10	A20	A40	A50	A70	C10 - C30	C20	E01
All engines	x 3, COIL ON PLUG									1.970.631	C10	
1.4 Turbo												
	Petrol	110	07/15->	ENGINE B 14 XFT								
Engine	Information				A10	A20	A40	A50	A70	C10 - C30	C20	E01
All engines	x 4, COIL ON PLUG									1.970.631	C10	
1.4 Turbo												
	Petrol	92	07/15->	ENGINE B 14 XFL								
Engine	Information				A10	A20	A40	A50	A70	C10 - C30	C20	E01
All engines	x 4, COIL ON PLUG									1.970.631	C10	
ASTRAVAN I												
1.4 i												
	Petrol	44	09/91-08/95	ENGINE C 14 NZ								
Engine	Information				A10	A20	A40	A50	A70	C10 - C30	C20	E01
All engines	connector type SAE, version Bosch						1.306.249					
All engines	connector type M4, version Bosch						1.306.256					

A10 CONDENSER	A20 CONTACT SET	A40 DISTRIBUTOR CAP	A50 ROTOR	A70 PICK-UP
C10 COIL	C20 IGNITION MODULE	C30 ELECTRONIC IGNITION KIT	E01 IGNITION CABLE SET	

Vehicle	alim.	kW	Date	Engine	FUNCTIONS ON THE VEHICLE							
					A10	A20	A40	A50	A70	C10 - C30	C20	E01

ASTRAVAN I

				ENGINE
1.4 i	Petrol	44	09/91-08/95	C 14 NZ

Engine	Information	A10	A20	A40	A50	A70	C10 - C30	C20	E01
All engines	version Bosch				1.406.121R				
All engines	version Lucas				1.428.028R	1.928.202			
All engines							1.970.140	C10	1.965.036
All engines	->eng. 02BF1476, 19241623								1.501.237
All engines	eng. type 02BF1477, 19241624 ->								1.501.529

				ENGINE
1.6 i	Petrol	52	09/94-08/96	X 16 SZ

Engine	Information	A10	A20	A40	A50	A70	C10 - C30	C20	E01
All engines	->eng. 02BE6166								1.500.634
All engines	eng. type 02BE6167 ->								1.501.531

				ENGINE
1.6 i	Petrol	55	10/91-08/98	C 16 NZ

Engine	Information	A10	A20	A40	A50	A70	C10 - C30	C20	E01
All engines	version Delco Remy			1.312.073	1.412.100	1.912.010			
All engines							1.970.341	C10	1.965.025
All engines	->eng. 02V65825								1.500.514

ASTRAVAN II

				ENGINE
1.4 16V	Petrol	66	09/00-05/05	Z 14 XE

Engine	Information	A10	A20	A40	A50	A70	C10 - C30	C20	E01
All engines	x 1, COIL ON PLUG, incl. spark plug connector						1.970.399	C10	

				ENGINE
1.6 Dualfuel	Petrol/ Liquified Petro- leum Gas (LPG)	74	07/00-08/05	Z 16 XE, Z 16 XEP

Engine	Information	A10	A20	A40	A50	A70	C10 - C30	C20	E01
Eng. Z 16 XE	x 1, COIL ON PLUG, incl. spark plug connector						1.970.399	C10	
All engines	x 1, DELPHI, COIL ON PLUG, incl. spark plug connector						1.970.450	C10	

				ENGINE
1.6 Dualfuel 16V	Petrol/ Liquified Petro- leum Gas (LPG)	77	10/04-12/05	Z 16 XEP

Engine	Information	A10	A20	A40	A50	A70	C10 - C30	C20	E01
All engines	x 1, DELPHI, COIL ON PLUG, incl. spark plug connector						1.970.450	C10	

				ENGINE
1.6 i	Petrol	55	08/98-09/00	X 16 SZR

Engine	Information	A10	A20	A40	A50	A70	C10 - C30	C20	E01
All engines									1.501.904

				ENGINE
1.6 i	Petrol	62	09/00-08/06	Z 16 SE

Engine	Information	A10	A20	A40	A50	A70	C10 - C30	C20	E01
All engines									1.501.904

ASTRAVAN III

				ENGINE
1.4 i	Petrol	66	03/05->	Z 14 XEP

Engine	Information	A10	A20	A40	A50	A70	C10 - C30	C20	E01
All engines	x 1, BOSCH, COIL ON PLUG, incl. spark plug connector						1.970.400	C10	

				ENGINE
1.6	Petrol	76	03/05->	Z 16 XE1, Z 16 XEP

Engine	Information	A10	A20	A40	A50	A70	C10 - C30	C20	E01
All engines	x 1, DELPHI, COIL ON PLUG, incl. spark plug connector						1.970.450	C10	

CALIBRA

				ENGINE
2.0 i	Petrol	85	06/90-07/97	C 20 NE

Engine	Information	A10	A20	A40	A50	A70	C10 - C30	C20	E01
All engines	version Bosch			1.306.257	1.406.127R				
All engines	version Ducellier			1.315.084	1.415.103R				

A10	CONDENSER	A20	CONTACT SET	A40	DISTRIBUTOR CAP	A50	ROTOR	A70	PICK-UP
C10	COIL	C20	IGNITION MODULE	C30	ELECTRONIC IGNITION KIT	E01	IGNITION CABLE SET		

FUNCTIONS ON THE VEHICLE

Vehicle	alim.	kW	Date	Engine	 A10	 A20	 A40	 A50	 A70	 C10 - C30	 C20	 E01
---------	-------	----	------	--------	---	---	---	--	---	---	---	---

CALIBRA

				ENGINE
2.0 i	Petrol	85	06/90-07/97	C 20 NE

Engine	Information	A10	A20	A40	A50	A70	C10 - C30	C20	E01
All engines	->eng. 14180385, info WY						1.970.191	C10	
All engines	eng. type 14180386 ->, info WE						1.970.192	C10	
All engines	eng. type 14672353 ->, ->ch. R1..., R9..., no specific info conc. application available								1.500.689

				ENGINE
2.0 i 16V	Petrol	100	06/90-07/97	X 20 XEV

Engine	Information	A10	A20	A40	A50	A70	C10 - C30	C20	E01
All engines							1.970.272	C10	
All engines	ch. 14195307 ->								1.501.506
All engines	->ch. 14195306								1.501.562

				ENGINE
2.0 i 16V	Petrol	110	06/90-02/94	C 20 XE

Engine	Information	A10	A20	A40	A50	A70	C10 - C30	C20	E01
All engines	version Bosch			1.306.251	1.406.121R				
All engines	ch. P1000001, P9000001 ->						1.970.273	C10	1.500.688

				ENGINE
2.0 i 16V 4x4	Petrol	100	02/94-07/97	X 20 XEV

Engine	Information	A10	A20	A40	A50	A70	C10 - C30	C20	E01
All engines							1.970.272	C10	
All engines	ch. 14195307 ->								1.501.506
All engines	->ch. 14195306								1.501.562

				ENGINE
2.0 i 16V 4x4	Petrol	110	06/90-02/94	C 20 XE

Engine	Information	A10	A20	A40	A50	A70	C10 - C30	C20	E01
All engines	version Bosch			1.306.251	1.406.121R				
All engines	ch. P1000001, P9000001 ->						1.970.273	C10	1.500.688

				ENGINE
2.0 i 4x4	Petrol	85	06/90-07/97	C 20 NE

Engine	Information	A10	A20	A40	A50	A70	C10 - C30	C20	E01
All engines	version Bosch			1.306.257	1.406.127R				
All engines	version Ducellier			1.315.084	1.415.103R				
All engines	->eng. 14180385, info WY						1.970.191	C10	
All engines	eng. type 14180386 ->, info WE						1.970.192	C10	
All engines	eng. type 14672353 ->, ->ch. R1..., R9..., no specific info conc. application available								1.500.689

				ENGINE
2.0 i Turbo 4x4	Petrol	150	03/92-07/97	C 20 LET

Engine	Information	A10	A20	A40	A50	A70	C10 - C30	C20	E01
All engines	version Bosch			1.306.257	1.406.121R				

CASCADA

				ENGINE
1.4	Petrol	103	02/13->	A 14 NET, B 14 NET

Engine	Information	A10	A20	A40	A50	A70	C10 - C30	C20	E01
All engines	x 1, COIL ON RAIL						1.970.547	C10	

				ENGINE
1.4	Petrol	88	02/13->	A 14 NEL

Engine	Information	A10	A20	A40	A50	A70	C10 - C30	C20	E01
All engines							1.970.547	C10	

CAVALIER

				ENGINE
1.3	Petrol	43	08/77-01/81	--, LW4

Engine	Information	A10	A20	A40	A50	A70	C10 - C30	C20	E01
All engines					1.412.090				

				ENGINE
1300	Petrol	44	08/77-08/81	13 N









Engine	Information	A10	A20	A40	A50	A70	C10 - C30	C20	E01
All engines					1.412.090				

A10 CONDENSER	A20 CONTACT SET	A40 DISTRIBUTOR CAP	A50 ROTOR	A70 PICK-UP
C10 COIL	C20 IGNITION MODULE	C30 ELECTRONIC IGNITION KIT	E01 IGNITION CABLE SET	

Vehicle	alim.	kW	Date	Engine	FUNCTIONS ON THE VEHICLE									
					A10	A20	A40	A50	A70	C10 - C30	C20	E01		
CAVALIER CC														
1.3	Petrol	42	08/75-08/81	ENGINE --, LW4										
Engine	Information				A10	A20	A40	A50	A70	C10 - C30	C20	E01		
All engines								1.412.090						
CHEVETTE														
1.2	Petrol	39	09/76-12/85	ENGINE 13 N										
Engine	Information				A10	A20	A40	A50	A70	C10 - C30	C20	E01		
All engines								1.412.090						
1300	Petrol	39	03/75-12/85	ENGINE 13 N										
Engine	Information				A10	A20	A40	A50	A70	C10 - C30	C20	E01		
All engines								1.412.090						
1300	Petrol	42	09/74-12/85	ENGINE 13 S										
Engine	Information				A10	A20	A40	A50	A70	C10 - C30	C20	E01		
All engines								1.412.090						
COMBO B														
1.2	Petrol	33	07/94-10/01	ENGINE C 12 NZ, X 12 SZ										
Engine	Information				A10	A20	A40	A50	A70	C10 - C30	C20	E01		
Eng. C 12 NZ	version Bosch						1.306.256	1.406.121R						
Eng. C 12 NZ	version Lucas						1.328.100	1.428.028R						
Eng. C 12 NZ										1.970.140	C10	1.965.036		
All engines	ch. 19019894 ->, ->ch. 19334654												1.499.195	
All engines	ch. 19334657 ->												1.499.199	
All engines	->ch. 19019893												1.501.237	
1.4	Petrol	44	07/94-10/01	ENGINE C 14 NZ										
Engine	Information				A10	A20	A40	A50	A70	C10 - C30	C20	E01		
All engines	version Bosch						1.306.256	1.406.121R						
All engines	version Lucas						1.328.100	1.428.028R						
All engines										1.970.140	C10	1.965.036		
All engines	->ch. 02BF1475, 19241622												1.499.195	
All engines	ch. 02BF1476, 19241623 ->, -air conditioning												1.499.199	
All engines	ch. 02BF1476, 19241623 ->, +air conditioning												1.501.529	
1.4	Petrol	60	07/94-10/01	ENGINE C 14 SE										
Engine	Information				A10	A20	A40	A50	A70	C10 - C30	C20	E01		
All engines	->ch. 02BD1412, 19262000												1.500.634	
All engines	ch. 02HY3580 ->												1.501.904	
1.4 16V	Petrol	66	08/99-10/01	ENGINE X 14 XE										
Engine	Information				A10	A20	A40	A50	A70	C10 - C30	C20	E01		
All engines	->ch. 20C17331												1.500.688	
All engines	ch. 20C17332 ->												1.501.559	
COMBO C														
1.4	Petrol	66	10/04-09/10	ENGINE Z 14 XEP										
Engine	Information				A10	A20	A40	A50	A70	C10 - C30	C20	E01		
All engines	x 1, BOSCH, COIL ON PLUG, incl. spark plug connector									1.970.400	C10			
1.4 16V	Petrol	66	10/01-05/07	ENGINE Z 14 XE										
Engine	Information				A10	A20	A40	A50	A70	C10 - C30	C20	E01		
All engines										1.970.399	C10			
1.4 i 16V	Petrol	66	01/04-11/11	ENGINE Z 14 XEP										
Engine	Information				A10	A20	A40	A50	A70	C10 - C30	C20	E01		
All engines	x 1, BOSCH, COIL ON PLUG, incl. spark plug connector									1.970.400	C10			

A10 CONDENSER	A20 CONTACT SET	A40 DISTRIBUTOR CAP	A50 ROTOR	A70 PICK-UP
C10 COIL	C20 IGNITION MODULE	C30 ELECTRONIC IGNITION KIT	E01 IGNITION CABLE SET	

The present application list is a brief version. For the detailed information about the possibility of installation on a specific vehicle, please refer to our web-catalogue <http://catalogo.facet.eu/>

					FUNCTIONS ON THE VEHICLE							
Vehicle	alim.	kW	Date	Engine								
ENGINE												
1.6	Petrol	62	09/01-10/04	Z 16 SE								
Engine Information					A10	A20	A40	A50	A70	C10 - C30	C20	E01
All engines												1.501.904
ENGINE												
1.6	Petrol	64	10/01-11/11	Z 16 SE								
Engine Information					A10	A20	A40	A50	A70	C10 - C30	C20	E01
All engines												1.501.904
ENGINE												
1.6 CNG	Petrol/ Com- pressed Natural Gas (CNG)	69	06/06-09/10	Z 16 YNG								
Engine Information					A10	A20	A40	A50	A70	C10 - C30	C20	E01
All engines										1.970.399	C10	
ENGINE												
1.6 CNG	Petrol/ Com- pressed Natural Gas (CNG)	71	04/05-02/12	Z 16 YNG								
Engine Information					A10	A20	A40	A50	A70	C10 - C30	C20	E01
All engines										1.970.399	C10	
ENGINE												
1.6 CNG 16V	Petrol/ Com- pressed Natural Gas (CNG)	69	06/06-02/12	Y 16 YNG, Z 16 YNG								
Engine Information					A10	A20	A40	A50	A70	C10 - C30	C20	E01
All engines										1.970.399	C10	
ENGINE												
1.6 CNG 16V	Petrol/ Com- pressed Natural Gas (CNG)	71	04/05-02/12	Z 16 YNG								
Engine Information					A10	A20	A40	A50	A70	C10 - C30	C20	E01
All engines										1.970.399	C10	









COMBO D												
Vehicle	alim.	kW	Date	Engine								
1.4	Petrol	70	11/11->	A 14 FP								
Engine Information					A10	A20	A40	A50	A70	C10 - C30	C20	E01
All engines										1.970.442	C10	

CORSA												
Vehicle	alim.	kW	Date	Engine								
1.2	Petrol	55	07/19->	F 12 XEL (EB2FAD)								
Engine Information					A10	A20	A40	A50	A70	C10 - C30	C20	E01
All engines										1.970.609	C10	

CORSA B												
Vehicle	alim.	kW	Date	Engine								
1.0 i 12V	Petrol	40	11/96-09/00	X 10 XE								
Engine Information					A10	A20	A40	A50	A70	C10 - C30	C20	E01
All engines										1.970.398	C10	

ENGINE												
Vehicle	alim.	kW	Date	Engine								
1.2 i	Petrol	33	03/93-09/00	C 12 NZ, X 12 SZ								
Engine Information					A10	A20	A40	A50	A70	C10 - C30	C20	E01
Eng. C 12 NZ							1.306.256	1.406.121R				
Eng. C 12 NZ							1.328.100	1.428.028R				
Eng. C 12 NZ										1.970.140	C10	1.965.036
All engines												1.499.195
All engines												1.499.199
All engines												1.501.237

A10 CONDENSER	A20 CONTACT SET	A40 DISTRIBUTOR CAP	A50 ROTOR	A70 PICK-UP
C10 COIL	C20 IGNITION MODULE	C30 ELECTRONIC IGNITION KIT	E01 IGNITION CABLE SET	

					FUNCTIONS ON THE VEHICLE							
Vehicle	alim.	kW	Date	Engine	 A10	 A20	 A40	 A50	 A70	 C10 - C30	 C20	 E01
ENGINE												
1.4 16V	Petrol	66	09/00-10/06	Z 14 XE								
ENGINE												
Engine	Information				A10	A20	A40	A50	A70	C10 - C30	C20	E01
All engines	x 4, COIL ON PLUG, incl. spark plug connector									1.970.399	C10	
ENGINE												
1.4 Twinport	Petrol	66	06/03-10/06	Z 14 XEP								
ENGINE												
Engine	Information				A10	A20	A40	A50	A70	C10 - C30	C20	E01
All engines	x 1, BOSCH, COIL ON PLUG, incl. spark plug connector									1.970.400	C10	
ENGINE												
1.8 16V	Petrol	92	08/00-09/06	Z 18 XE								
ENGINE												
Engine	Information				A10	A20	A40	A50	A70	C10 - C30	C20	E01
All engines	x 1, COIL ON PLUG, incl. spark plug connector									1.970.508	C10	
CORSA D												
ENGINE												
1.0	Petrol	44	08/06-08/14	Z 10 XEP								
ENGINE												
Engine	Information				A10	A20	A40	A50	A70	C10 - C30	C20	E01
All engines	x 3, BOSCH, COIL ON PLUG, 12 Volt, Dia: 55 mm, for pre-resistance									1.970.398	C10	
ENGINE												
1.2	Petrol	51	06/10-08/14	A 12 XEL								
ENGINE												
Engine	Information				A10	A20	A40	A50	A70	C10 - C30	C20	E01
All engines	x 1, COIL ON RAIL									1.970.547	C10	
ENGINE												
1.2	Petrol	59	08/06-08/14	Z 12 XEP								
ENGINE												
Engine	Information				A10	A20	A40	A50	A70	C10 - C30	C20	E01
All engines	x 1, BOSCH, COIL ON PLUG, incl. spark plug connector									1.970.400	C10	
ENGINE												
1.2 i 16V	Petrol	63	12/09-08/14	A 12 XER								
ENGINE												
Engine	Information				A10	A20	A40	A50	A70	C10 - C30	C20	E01
All engines	x 1, COIL ON RAIL									1.970.547	C10	
ENGINE												
1.2 LPG	Petrol/ Liquified Petro- leum Gas (LPG)	59	09/09-08/14	Z 12 XEP								
ENGINE												
Engine	Information				A10	A20	A40	A50	A70	C10 - C30	C20	E01
All engines	x 1, BOSCH, COIL ON PLUG, incl. spark plug connector									1.970.400	C10	
ENGINE												
1.2 LPG	Petrol/ Liquified Petro- leum Gas (LPG)	61	06/11-08/14	A 12 XER								
ENGINE												
Engine	Information				A10	A20	A40	A50	A70	C10 - C30	C20	E01
All engines										1.970.547	C10	
ENGINE												
1.2 LPG	Petrol/ Liquified Petro- leum Gas (LPG)	63	08/11-08/14	A 12 XER								
ENGINE												
Engine	Information				A10	A20	A40	A50	A70	C10 - C30	C20	E01
All engines	x 1, COIL ON RAIL									1.970.547	C10	
ENGINE												
1.4	Petrol	64	09/09-08/14	A 14 XEL								
ENGINE												
Engine	Information				A10	A20	A40	A50	A70	C10 - C30	C20	E01
All engines										1.970.547	C10	
ENGINE												
1.4	Petrol	66	08/06-08/14	Z 14 XEP								
ENGINE												
Engine	Information				A10	A20	A40	A50	A70	C10 - C30	C20	E01
All engines	x 1, BOSCH, COIL ON PLUG, incl. spark plug connector									1.970.400	C10	
ENGINE												
1.4	Petrol	74	01/10-08/14	A 14 XER								
ENGINE												
Engine	Information				A10	A20	A40	A50	A70	C10 - C30	C20	E01
All engines	x 1, COIL ON RAIL									1.970.547	C10	

A10 CONDENSER	A20 CONTACT SET	A40 DISTRIBUTOR CAP	A50 ROTOR	A70 PICK-UP
C10 COIL	C20 IGNITION MODULE	C30 ELECTRONIC IGNITION KIT	E01 IGNITION CABLE SET	

Vehicle	alim.	kW	Date	Engine	FUNCTIONS ON THE VEHICLE							
					A10	A20	A40	A50	A70	C10 - C30	C20	E01

ENGINE				
1.4	Petrol	66	08/14->	B 14 XEJ, B 14 XEL, D 14 XEL

Engine	Information	A10	A20	A40	A50	A70	C10 - C30	C20	E01
Eng. B 14 XEJ							1.970.547	C10	
Eng. B 14 XEL, D 14 XEL	x 1, COIL ON RAIL						1.970.547	C10	

ENGINE				
1.4	Petrol	74	08/14->	B14NEJ, D 14 NEJ

Engine	Information	A10	A20	A40	A50	A70	C10 - C30	C20	E01
All engines	x 1, COIL ON RAIL						1.970.547	C10	

ENGINE				
1.4 LPG	Petrol/ Liquified Petro- leum Gas (LPG)	66	08/14->	B 14 XEL

Engine	Information	A10	A20	A40	A50	A70	C10 - C30	C20	E01
All engines							1.970.547	C10	

ENGINE				
1.6 VXR	Petrol	151	04/15->	B 16 LES

Engine	Information	A10	A20	A40	A50	A70	C10 - C30	C20	E01
All engines	x 1, COIL ON PLUG						1.970.545	C10	

CORSAVAN I

ENGINE				
1.4 i	Petrol	44	01/94-09/00	C 14 NZ

Engine	Information	A10	A20	A40	A50	A70	C10 - C30	C20	E01
All engines	version Bosch			1.306.256	1.406.121R				
All engines	version Lucas			1.328.100	1.428.028R				
All engines							1.970.140	C10	1.965.036
All engines	->ch. 02BF1475, 19241622								1.499.195
All engines	ch. 02BF1476, 19241623 ->, -air conditioning								1.499.199
All engines	ch. 02BF1476, 19241623 ->, +air conditioning								1.501.529

CORSAVAN II

ENGINE				
1.2 16V	Petrol	55	09/00-06/06	Z 12 XE

Engine	Information	A10	A20	A40	A50	A70	C10 - C30	C20	E01
All engines	->ch. 36999999, ch. 37000000 ->, x 1, x 4, BOSCH, COIL ON PLUG, incl. spark plug connector						1.970.400	C10	

ENGINE				
1.2 16V	Petrol	59	07/04-11/06	Z 12 XEP

Engine	Information	A10	A20	A40	A50	A70	C10 - C30	C20	E01
All engines	x 1, BOSCH, COIL ON PLUG, incl. spark plug connector						1.970.400	C10	

ENGINE				
1.2 16V Dualfuel	Petrol/ Liquified Petro- leum Gas (LPG)	55	08/01-06/06	Z 12 XE

Engine	Information	A10	A20	A40	A50	A70	C10 - C30	C20	E01
All engines	->ch. 36999999, ch. 37000000 ->, x 1, x 4, BOSCH, COIL ON PLUG, incl. spark plug connector						1.970.400	C10	

ENGINE				
1.2 16V Dualfuel	Petrol/ Liquified Petro- leum Gas (LPG)	59	07/04-12/05	Z 12 XEP

Engine	Information	A10	A20	A40	A50	A70	C10 - C30	C20	E01
All engines	x 1, BOSCH, COIL ON PLUG, incl. spark plug connector						1.970.400	C10	

ENGINE				
1.4	Petrol	66	11/03-06/06	Z 14 XEP

Engine	Information	A10	A20	A40	A50	A70	C10 - C30	C20	E01
All engines	x 1, BOSCH, COIL ON PLUG, incl. spark plug connector						1.970.400	C10	

CORSAVAN III

ENGINE				
1.2	Petrol	51	01/10->	A 12 XEL









Engine	Information	A10	A20	A40	A50	A70	C10 - C30	C20	E01
All engines	x 1, COIL ON RAIL						1.970.547	C10	

A10 CONDENSER	A20 CONTACT SET	A40 DISTRIBUTOR CAP	A50 ROTOR	A70 PICK-UP
C10 COIL	C20 IGNITION MODULE	C30 ELECTRONIC IGNITION KIT	E01 IGNITION CABLE SET	

Vehicle	alim.	kW	Date	Engine	FUNCTIONS ON THE VEHICLE									
					A10	A20	A40	A50	A70	C10 - C30	C20	E01		
ENGINE														
1.2	Petrol	59	07/09->	Z 12 XEP										
ENGINE														
All engines					x 1, BOSCH, COIL ON PLUG, incl. spark plug connector						1.970.400	C10		
CORSAVAN IV														
1.2	Petrol	51	10/14->	B 12 XEL										
ENGINE														
All engines					x 1, COIL ON RAIL						1.970.547	C10		
1.4	Petrol	55	10/14->	B 14 XEJ										
ENGINE														
All engines											1.970.547	C10		
CRESTA														
2.7	Petrol	84	01/64-10/72	--										
ENGINE														
All engines								1.412.090						
3.3	Petrol	91	01/64-10/72	--										
ENGINE														
All engines								1.412.090						
CROSSLAND X														
1.2	Petrol	61	03/17->	B 12 XE (EB2F), D 12 XE (EB2FA), F12XE(EB2FA)										
ENGINE														
All engines					x 3, COIL ON PLUG						1.970.609	C10		
1.2	Petrol	81	03/17->	B 12 XHL (EB2DT)										
ENGINE														
All engines					x 3, COIL ON PLUG						1.970.620	C10		
1.2	Petrol	96	03/17->	B 12 XHT (EB2DTS)										
ENGINE														
All engines					x 3, COIL ON PLUG						1.970.620	C10		
FIRENZA														
1300	Petrol	40	01/71-10/73	--										
ENGINE														
All engines								1.412.090						
FRONTERA A														
2.0	Petrol	85	04/95-08/98	C 20 NE, X 20 SE										
ENGINE														
Eng. C 20 NE					version Bosch			1.306.257	1.406.127R					
Eng. C 20 NE					version Ducellier			1.315.084	1.415.103R					
Eng. C 20 NE										1.970.192	C10			
Eng. X 20 SE										1.970.273	C10		1.501.947	
Eng. C 20 NE					->eng. 14672353								1.500.527	
Eng. C 20 NE					eng. type 14672354 ->								1.500.689	
2.0i	Petrol	85	03/92-10/98	C 20 NE, X 20 SE										
ENGINE														
Eng. C 20 NE					version Bosch			1.306.257	1.406.127R					
Eng. C 20 NE					version Ducellier			1.315.084	1.415.103R					
Eng. C 20 NE										1.970.192	C10			
Eng. X 20 SE										1.970.273	C10		1.501.947	
Eng. C 20 NE					->eng. 14672353								1.500.527	
Eng. C 20 NE					eng. type 14672354 ->								1.500.689	

A10	CONDENSER	A20	CONTACT SET	A40	DISTRIBUTOR CAP	A50	ROTOR	A70	PICK-UP
C10	COIL	C20	IGNITION MODULE	C30	ELECTRONIC IGNITION KIT	E01	IGNITION CABLE SET		

The present application list is a brief version. For the detailed information about the possibility of installation on a specific vehicle, please refer to our web-catalogue <http://catalogo.facet.eu/>









					FUNCTIONS ON THE VEHICLE							
Vehicle	alim.	kW	Date	Engine	 A10	 A20	 A40	 A50	 A70	 C10 - C30	 C20	 E01
ENGINE												
2.2 i	Petrol	100	03/95-10/98	X 22 XE								
ENGINE												
Engine		Information			A10	A20	A40	A50	A70	C10 - C30	C20	E01
All engines										1.970.273	C10	
ENGINE												
2.4 i	Petrol	92	03/92-10/98	C 24 NE								
ENGINE												
Engine		Information			A10	A20	A40	A50	A70	C10 - C30	C20	E01
All engines		version Bosch					1.306.256	1.406.121R				
All engines										1.970.192	C10	
GRANDLAND X												
ENGINE												
1.2 Turbo	Petrol	96	06/17->	B 12 XHT (EB2DTS)								
ENGINE												
Engine		Information			A10	A20	A40	A50	A70	C10 - C30	C20	E01
All engines		x 3, COIL ON PLUG								1.970.620	C10	
ENGINE												
1.6 Turbo Hybrid	Petrol/ Electric	133	12/19->	D 16 XHT (EP6FADTXHP)								
ENGINE												
Engine		Information			A10	A20	A40	A50	A70	C10 - C30	C20	E01
All engines		x 4, COIL ON PLUG								1.970.475	C10	
ENGINE												
1.6 Turbo Hybrid	Petrol/ Electric	165	12/19->	D 16 XHT (EP6FADTXHP)								
ENGINE												
Engine		Information			A10	A20	A40	A50	A70	C10 - C30	C20	E01
All engines		x 4, COIL ON PLUG								1.970.475	C10	
ENGINE												
1.6 Turbo Hybrid4	Petrol/ Electric	147	06/19->	D 16 XHT (EP6FADTXHP)								
ENGINE												
Engine		Information			A10	A20	A40	A50	A70	C10 - C30	C20	E01
All engines		x 4, COIL ON PLUG								1.970.475	C10	
ENGINE												
1.6 Turbo Hybrid4	Petrol/ Electric	221	06/19->	D 16 XHT (EP6FADTXHP)								
ENGINE												
Engine		Information			A10	A20	A40	A50	A70	C10 - C30	C20	E01
All engines		x 4, COIL ON PLUG								1.970.475	C10	
INSIGNIA												
ENGINE												
1.4	Petrol	103	04/11-05/17	A 14 NET, B 14 NET								
ENGINE												
Engine		Information			A10	A20	A40	A50	A70	C10 - C30	C20	E01
All engines		x 1, COIL ON RAIL								1.970.547	C10	
ENGINE												
1.4 LPG	Petrol/ Liquified Petroleum Gas (LPG)	103	07/12-05/17	A 14 NET								
ENGINE												
Engine		Information			A10	A20	A40	A50	A70	C10 - C30	C20	E01
All engines		x 1, COIL ON RAIL								1.970.547	C10	
ENGINE												
1.5	Petrol	103	03/17->	B 15 SFL, D 15 SFL								
ENGINE												
Engine		Information			A10	A20	A40	A50	A70	C10 - C30	C20	E01
All engines		x 4, COIL ON PLUG								1.970.631	C10	
ENGINE												
1.5	Petrol	121	03/17->	B 15 SFT, D 15 SFT, D15XHT								
ENGINE												
Engine		Information			A10	A20	A40	A50	A70	C10 - C30	C20	E01
All engines		x 4, COIL ON PLUG								1.970.631	C10	
ENGINE												
1.6	Petrol	85	07/08-05/17	A 16 XER								
ENGINE												
Engine		Information			A10	A20	A40	A50	A70	C10 - C30	C20	E01
All engines										1.970.545	C10	
All engines		x 1, COIL ON PLUG								1.970.545	C10	

A10 CONDENSER	A20 CONTACT SET	A40 DISTRIBUTOR CAP	A50 ROTOR	A70 PICK-UP
C10 COIL	C20 IGNITION MODULE	C30 ELECTRONIC IGNITION KIT	E01 IGNITION CABLE SET	

Vehicle	alim.	kW	Date	Engine	FUNCTIONS ON THE VEHICLE							
					A10	A20	A40	A50	A70	C10 - C30	C20	E01
ENGINE												
1.6 Turbo	Petrol	132	01/09-05/17	A 16 LET								
Engine	Information				A10	A20	A40	A50	A70	C10 - C30	C20	E01
All engines	x 1, DELPHI, COIL ON PLUG, incl. spark plug connector									1.970.450	C10	
ENGINE												
1.8	Petrol	103	07/08-05/17	A 18 XER, B 18 XER								
Engine	Information				A10	A20	A40	A50	A70	C10 - C30	C20	E01
All engines	x 1, COIL ON PLUG									1.970.545	C10	
Eng. B 18 XER										1.970.545	C10	
MERIVA I												
ENGINE												
1.4 16V Twinport	Petrol	66	01/03-06/10	Z 14 XEP								
Engine	Information				A10	A20	A40	A50	A70	C10 - C30	C20	E01
All engines	x 1, BOSCH, COIL ON PLUG, incl. spark plug connector									1.970.400	C10	
ENGINE												
1.6i	Petrol	64	01/03-06/10	Z 16 SE								
Engine	Information				A10	A20	A40	A50	A70	C10 - C30	C20	E01
All engines												1.501.904
ENGINE												
1.6i 16V	Petrol	74	01/03-09/05	Z 16 XE								
Engine	Information				A10	A20	A40	A50	A70	C10 - C30	C20	E01
All engines	x 4, COIL ON PLUG, incl. spark plug connector									1.970.399	C10	
ENGINE												
1.6i 16V Twinport	Petrol	77	05/03-06/10	Z 16 XEP								
Engine	Information				A10	A20	A40	A50	A70	C10 - C30	C20	E01
All engines	x 1, DELPHI, COIL ON PLUG, incl. spark plug connector									1.970.450	C10	
ENGINE												
1.6 Turbo	Petrol	132	05/06-06/10	Z 16 LET								
Engine	Information				A10	A20	A40	A50	A70	C10 - C30	C20	E01
All engines	x 1, DELPHI, COIL ON PLUG, incl. spark plug connector									1.970.450	C10	
ENGINE												
1.8i 16V	Petrol	92	05/03-06/10	Z 18 XE								
Engine	Information				A10	A20	A40	A50	A70	C10 - C30	C20	E01
All engines	x 1, COIL ON PLUG, incl. spark plug connector									1.970.508	C10	
MERIVA II												
ENGINE												
1.4	Petrol	103	06/10->	A 14 NET, B 14 NET								
Engine	Information				A10	A20	A40	A50	A70	C10 - C30	C20	E01
All engines	x 1, COIL ON RAIL									1.970.547	C10	
ENGINE												
1.4	Petrol	74	06/10->	A 14 XER, B 14 XER								
Engine	Information				A10	A20	A40	A50	A70	C10 - C30	C20	E01
All engines	x 1, COIL ON RAIL									1.970.547	C10	
ENGINE												
1.4	Petrol	88	06/10->	A 14 NEL, B 14 NEL								
Engine	Information				A10	A20	A40	A50	A70	C10 - C30	C20	E01
All engines	x 1, COIL ON RAIL									1.970.547	C10	
ENGINE												
1.4 LPG	Petrol/ Liquified Petro- leum Gas (LPG)	88	06/11->	A 14 NEL, B 14 NEL								
Engine	Information				A10	A20	A40	A50	A70	C10 - C30	C20	E01
Eng. A 14 NEL	x 1, COIL ON RAIL									1.970.547	C10	
Eng. B 14 NEL										1.970.547	C10	
MOKKA / MOKKA X												
ENGINE												
1.4	Petrol	103	04/13->	A 14 NET, B 14 NET, D 14 NET								
Engine	Information				A10	A20	A40	A50	A70	C10 - C30	C20	E01
All engines	x 1, COIL ON RAIL									1.970.547	C10	

A10	CONDENSER	A20	CONTACT SET	A40	DISTRIBUTOR CAP	A50	ROTOR	A70	PICK-UP
C10	COIL	C20	IGNITION MODULE	C30	ELECTRONIC IGNITION KIT	E01	IGNITION CABLE SET		

The present application list is a brief version. For the detailed information about the possibility of installation on a specific vehicle, please refer to our web-catalogue <http://catalogo.facet.eu/>









					FUNCTIONS ON THE VEHICLE							
Vehicle	alim.	kW	Date	Engine	 A10	 A20	 A40	 A50	 A70	 C10 - C30	 C20	 E01
ENGINE												
1.4 4x4	Petrol	103	06/12->	A 14 NET, B 14 NET, D 14 NET								
Engine	Information				A10	A20	A40	A50	A70	C10 - C30	C20	E01
All engines	x 1, COIL ON RAIL									1.970.547	C10	
ENGINE												
1.4 4x4	Petrol	112	06/16->	B 14 XFT								
Engine	Information				A10	A20	A40	A50	A70	C10 - C30	C20	E01
All engines	x 4, COIL ON PLUG									1.970.631	C10	
ENGINE												
1.6	Petrol	85	06/12->	A 16 XER, B 16 XER, D 16 XER								
Engine	Information				A10	A20	A40	A50	A70	C10 - C30	C20	E01
All engines	x 1, COIL RAILS									1.970.545	C10	
OMEGA B												
2.0	Petrol	85	03/94-09/99	20 SE, X 20 SE								
Engine	Information				A10	A20	A40	A50	A70	C10 - C30	C20	E01
Eng. 20 SE	->ch. K1999999, version Bosch						1.306.240					
Eng. 20 SE	ch. L1000001 ->, version Bosch						1.306.257					
Eng. 20 SE	version Ducellier						1.315.084	1.415.103R				
Eng. 20 SE	version Bosch						1.406.127R					
Eng. 20 SE	->eng. 14180385, ch. K1000099 ->									1.970.191	C10	
Eng. 20 SE	eng. type 14180386 ->									1.970.192	C10	
Eng. 20 SE	->ch. K1000098									1.970.194	C10	
Eng. X 20 SE										1.970.273	C10	
Eng. 20 SE	->eng. 14312950, eng. type 14180386 ->											1.500.527
Eng. 20 SE	eng. type 14312951 ->											1.500.689
ENGINE												
2.0 16V	Petrol	100	03/94-07/01	X 20 XEV								
Engine	Information				A10	A20	A40	A50	A70	C10 - C30	C20	E01
All engines										1.970.272	C10	1.501.562
SIGNUM												
1.8	Petrol	103	08/05-05/08	Z 18 XER								
Engine	Information				A10	A20	A40	A50	A70	C10 - C30	C20	E01
All engines	x 1, DELPHI, COIL ON PLUG, incl. spark plug connector									1.970.450	C10	
ENGINE												
1.8	Petrol	90	06/03-07/05	Z 18 XE								
Engine	Information				A10	A20	A40	A50	A70	C10 - C30	C20	E01
All engines	x 1, COIL ON PLUG, incl. spark plug connector									1.970.508	C10	
SINTRA												
2.2 i 16V	Petrol	104	11/96-04/99	X 22 XE								
Engine	Information				A10	A20	A40	A50	A70	C10 - C30	C20	E01
All engines	x 1, D.I.S.									1.970.389	C10	
All engines												1.501.562
SPEEDSTER												
2.0 Turbo	Petrol	147	03/01-09/06	Z 20 LET								
Engine	Information				A10	A20	A40	A50	A70	C10 - C30	C20	E01
All engines										1.970.507	C10	
ENGINE												
VXR20	Petrol	162	03/01-09/06	Z 20 LET								
Engine	Information				A10	A20	A40	A50	A70	C10 - C30	C20	E01
All engines										1.970.507	C10	
TIGRA A												
1.4 16V	Petrol	66	07/94-12/00	X 14 XE								
Engine	Information				A10	A20	A40	A50	A70	C10 - C30	C20	E01
All engines	->ch. 20C17331											1.500.688
All engines	ch. 20C17332 ->											1.501.559

A10 CONDENSER	A20 CONTACT SET	A40 DISTRIBUTOR CAP	A50 ROTOR	A70 PICK-UP
C10 COIL	C20 IGNITION MODULE	C30 ELECTRONIC IGNITION KIT	E01 IGNITION CABLE SET	

Vehicle	alim.	kW	Date	Engine	FUNCTIONS ON THE VEHICLE								
					A10	A20	A40	A50	A70	C10 - C30	C20	E01	
1.6 16V					ENGINE								
Petrol	78	07/94-12/00	X 16 XE										
Engine	Information				A10	A20	A40	A50	A70	C10 - C30	C20	E01	
All engines	->ch. 20C17331											1.500.688	
All engines	ch. 20C17332 ->											1.501.559	
TIGRA B					ENGINE								
1.4													
Petrol	66	06/04-08/09	Z 14 XEP										
Engine	Information				A10	A20	A40	A50	A70	C10 - C30	C20	E01	
All engines	x 1, BOSCH, COIL ON PLUG, incl. spark plug connector									1.970.400	C10		
1.8													
Petrol	92	06/04-08/09	Z 18 XE										
Engine	Information				A10	A20	A40	A50	A70	C10 - C30	C20	E01	
All engines	x 1, COIL ON PLUG, incl. spark plug connector									1.970.508	C10		
VECTRA B					ENGINE								
1.6 i													
Petrol	55	08/95-03/02	X 16 SZR										
Engine	Information				A10	A20	A40	A50	A70	C10 - C30	C20	E01	
All engines	->eng. 02HP7704											1.501.531	
All engines	eng. type 02HP7705 ->											1.501.904	
1.6 i 16V													
Petrol	74	08/95-03/02	X 16 XEL, Y 16 XE, Z 16 XE										
Engine	Information				A10	A20	A40	A50	A70	C10 - C30	C20	E01	
All engines	ch. W1285447 ->, ch. W5 ->, ch. W7154259 ->, ch. WL ->, ch. WP ->, ch. WS ->, x 1, COIL ON PLUG, incl. spark plug connector									1.970.399	C10		
All engines	ch. W1285447, W7154259 ->									1.970.399	C10		
Eng. X 16 XEL	->ch. W1285449, ->ch. W5276825, ->ch. W7154258											1.500.688	
1.8 Dualfuel													
Petrol/ Liquified Petro- leum Gas (LPG)	92	09/00-07/03	Z 18 XE										
Engine	Information				A10	A20	A40	A50	A70	C10 - C30	C20	E01	
All engines	x 1, COIL ON PLUG, incl. spark plug connector									1.970.508	C10		
1.8 i 16V													
Petrol	85	09/95-09/00	X 18 XE, X 18 XE1, Z 18 XEL										
Engine	Information				A10	A20	A40	A50	A70	C10 - C30	C20	E01	
Eng. X 18 XE										1.970.272	C10		
Eng. X 18 XE	x 1, D.I.S.									1.970.272	C10		
Eng. X 18 XE1	x 1, COIL ON PLUG, incl. spark plug connector									1.970.508	C10		
Eng. X 18 XE1, Z 18 XEL										1.970.508	C10		
Eng. X 18 XE	no specific info conc. application available											1.501.506, 1.501.562	
1.8 i 16V													
Petrol	92	09/00-07/03	Z 18 XE										
Engine	Information				A10	A20	A40	A50	A70	C10 - C30	C20	E01	
All engines	x 1, COIL ON PLUG, incl. spark plug connector									1.970.508	C10		
2.0 Dualfuel													
Petrol/ Liquified Petro- leum Gas (LPG)	100	05/98-01/01	X 20 XEV										
Engine	Information				A10	A20	A40	A50	A70	C10 - C30	C20	E01	
All engines	x 1, D.I.S.									1.970.272	C10		
2.0 i													
Petrol	82	10/95-03/02	20 NEJ										
Engine	Information				A10	A20	A40	A50	A70	C10 - C30	C20	E01	
All engines										1.970.273	C10		
2.0 i 16V													
Petrol	100	10/95-01/01	X 20 XEV										
Engine	Information				A10	A20	A40	A50	A70	C10 - C30	C20	E01	
All engines	x 1, D.I.S.									1.970.272	C10		

A10	CONDENSER	A20	CONTACT SET	A40	DISTRIBUTOR CAP	A50	ROTOR	A70	PICK-UP
C10	COIL	C20	IGNITION MODULE	C30	ELECTRONIC IGNITION KIT	E01	IGNITION CABLE SET		

The present application list is a brief version. For the detailed information about the possibility of installation on a specific vehicle, please refer to our web-catalogue <http://catalogo.facet.eu/>

					FUNCTIONS ON THE VEHICLE							
Vehicle	alim.	kW	Date	Engine								
ENGINE												
2.0 i 16V	Petrol	100	10/95-01/01	Z 20 XEV								
Engine	Information				A10	A20	A40	A50	A70	C10 - C30	C20	E01
All engines	no specific info conc. application available											1.501.506, 1.501.562
VECTRA C												
ENGINE												
1.6 16V	Petrol	74	06/04-07/08	Z 16 XE								
Engine	Information				A10	A20	A40	A50	A70	C10 - C30	C20	E01
All engines										1.970.399	C10	
ENGINE												
1.6 16V	Petrol	77	01/06-07/08	Z 16 XEP								
Engine	Information				A10	A20	A40	A50	A70	C10 - C30	C20	E01
All engines										1.970.450	C10	
ENGINE												
1.8	Petrol	103	01/06-07/08	Z 18 XER								
Engine	Information				A10	A20	A40	A50	A70	C10 - C30	C20	E01
All engines	x 1, DELPHI, COIL ON PLUG, incl. spark plug connector									1.970.450	C10	
ENGINE												
1.8	Petrol	81	04/02-07/08	Z 18 XEL								
Engine	Information				A10	A20	A40	A50	A70	C10 - C30	C20	E01
All engines										1.970.508	C10	
ENGINE												
1.8 16V	Petrol	90	04/02-07/08	Z 18 XE								
Engine	Information				A10	A20	A40	A50	A70	C10 - C30	C20	E01
All engines	x 1, COIL ON PLUG, incl. spark plug connector									1.970.508	C10	
ENGINE												
1.8 16V Dualfuel	Petrol/ Liquified Petro- leum Gas (LPG)	90	04/02-07/08	Z 18 XE								
Engine	Information				A10	A20	A40	A50	A70	C10 - C30	C20	E01
All engines	x 1, COIL ON PLUG, incl. spark plug connector									1.970.508	C10	
VELOX												
ENGINE												
2.7	Petrol	70	03/64-10/72	--								
Engine	Information				A10	A20	A40	A50	A70	C10 - C30	C20	E01
All engines								1.412.090				
ENGINE												
3.3	Petrol	85	09/64-07/65	--								
Engine	Information				A10	A20	A40	A50	A70	C10 - C30	C20	E01
All engines								1.412.090				
VENTORA												
ENGINE												
3300	Petrol	91	03/69-10/76	--								
Engine	Information				A10	A20	A40	A50	A70	C10 - C30	C20	E01
All engines								1.412.090				
VICTOR												
ENGINE												
3000	Petrol	91	03/68-09/72	--								
Engine	Information				A10	A20	A40	A50	A70	C10 - C30	C20	E01
All engines								1.412.090				
VISCOUNT												
ENGINE												
3300	Petrol	91	01/66-10/72	--								
Engine	Information				A10	A20	A40	A50	A70	C10 - C30	C20	E01
All engines								1.412.090				
VIVA												
ENGINE												
1100	Petrol	33	01/63-10/66	--								
Engine	Information				A10	A20	A40	A50	A70	C10 - C30	C20	E01
All engines								1.412.090				

A10 CONDENSER	A20 CONTACT SET	A40 DISTRIBUTOR CAP	A50 ROTOR	A70 PICK-UP
C10 COIL	C20 IGNITION MODULE	C30 ELECTRONIC IGNITION KIT	E01 IGNITION CABLE SET	

Vehicle	alim.	kW	Date	Engine	FUNCTIONS ON THE VEHICLE									
					A10	A20	A40	A50	A70	C10 - C30	C20	E01		
ENGINE														
1100	Petrol	35	01/66-09/71	--										
ENGINE														
All engines								1.412.090						
ENGINE														
1100 SL90	Petrol	44	01/65-10/70	--										
ENGINE														
All engines								1.412.090						
ENGINE														
1256	Petrol	43	10/71-10/75	--										
ENGINE														
All engines								1.412.090						
ENGINE														
1256 E	Petrol	43	10/71-10/75	--										
ENGINE														
All engines								1.412.090						
ENGINE														
1300	Petrol	43	10/75-10/79	--										
ENGINE														
All engines								1.412.090						
VIVARO														
ENGINE														
2.0 16V	Petrol	88	08/01-07/14	F4R 720										
ENGINE														
All engines											1.970.432	C10		
ENGINE														
2.0 ECOTEC	Petrol	86	08/06-07/14	F4R 820										
ENGINE														
All engines											1.970.432	C10		
VX220														
ENGINE														
2.0 i Turbo	Petrol	147	03/01-07/05	Z 20 LET										
ENGINE														
All engines											1.970.507	C10		
ENGINE														
2.0 VXR	Petrol	162	10/03-07/05	Z 20 LET										
ENGINE														
All engines											1.970.507	C10		
ZAFIRA A														
ENGINE														
1.6 16V	Petrol	74	04/99-08/05	X 16 XEL, Z 16 XE										
ENGINE														
All engines											1.970.399	C10		
ENGINE														
1.6 CNG	Petrol/ Com- pressed Natural Gas (CNG)	71	09/01-06/05	Z 16 YNG										
ENGINE														
All engines											1.970.399	C10		
ENGINE														
1.6 Dualfuel	Petrol/ Liquified Petro- leum Gas (LPG)	74	11/98-08/05	X 16 XEL										
ENGINE														
All engines											1.970.399	C10		
ENGINE														
1.8 16V	Petrol	85	05/99-08/00	X 18 XE1										
ENGINE														
All engines											1.970.508	C10		

A10 CONDENSER	A20 CONTACT SET	A40 DISTRIBUTOR CAP	A50 ROTOR	A70 PICK-UP
C10 COIL	C20 IGNITION MODULE	C30 ELECTRONIC IGNITION KIT	E01 IGNITION CABLE SET	

The present application list is a brief version. For the detailed information about the possibility of installation on a specific vehicle, please refer to our web-catalogue <http://catalogo.facet.eu/>

Vehicle	alim.	kW	Date	Engine	FUNCTIONS ON THE VEHICLE									
					A10	A20	A40	A50	A70	C10 - C30	C20	E01		
ENGINE														
1.8 16V	Petrol	92	09/00-08/05	Z 18 XE										
Engine		Information			A10	A20	A40	A50	A70	C10 - C30	C20	E01		
All engines		x 1, COIL ON PLUG, incl. spark plug connector								1.970.508	C10			
ENGINE														
1.8 Dualfuel	Petrol/ Liquified Petro- leum Gas (LPG)	92	09/00-08/05	Z 18 XE										
Engine		Information			A10	A20	A40	A50	A70	C10 - C30	C20	E01		
All engines		x 1, COIL ON PLUG, incl. spark plug connector								1.970.508	C10			
ENGINE														
2.0	Petrol	147	06/02-06/05	Z 20 LET										
Engine		Information			A10	A20	A40	A50	A70	C10 - C30	C20	E01		
All engines		x 1, COIL ON PLUG								1.970.507	C10			
ENGINE														
2.0 GSI Turbo	Petrol	141	09/01-06/05	Z 20 LET										
Engine		Information			A10	A20	A40	A50	A70	C10 - C30	C20	E01		
All engines		x 1, COIL ON PLUG								1.970.507	C10			
ZAFIRA B														
ENGINE														
1.6	Petrol	77	07/05-11/14	Z 16 XE1, Z 16 XEP										
Engine		Information			A10	A20	A40	A50	A70	C10 - C30	C20	E01		
All engines		x 1, DELPHI, COIL ON PLUG, incl. spark plug connector								1.970.450	C10			
ENGINE														
1.6	Petrol	85	12/07-11/14	A 16 XER, Z 16 XER										
Engine		Information			A10	A20	A40	A50	A70	C10 - C30	C20	E01		
All engines		x 1, DELPHI, COIL ON PLUG, incl. spark plug connector								1.970.450	C10			
ENGINE														
1.6 CNG	Petrol/ Com- pressed Natural Gas (CNG)	69	07/05-11/14	Z 16 YNG										
Engine		Information			A10	A20	A40	A50	A70	C10 - C30	C20	E01		
All engines										1.970.399	C10			
ENGINE														
1.6 CNG Turbo	Petrol/ Com- pressed Natural Gas (CNG)	110	02/09-11/14	A 16 XNT, Z 16 XNT										
Engine		Information			A10	A20	A40	A50	A70	C10 - C30	C20	E01		
All engines										1.970.450	C10			
ENGINE														
1.8	Petrol	103	04/05-11/14	A 18 XER, Z 18 XER										
Engine		Information			A10	A20	A40	A50	A70	C10 - C30	C20	E01		
All engines		x 1, DELPHI, COIL ON PLUG, incl. spark plug connector								1.970.450	C10			
ENGINE														
1.8	Petrol	88	04/13-11/14	A 18 XEL										
Engine		Information			A10	A20	A40	A50	A70	C10 - C30	C20	E01		
All engines		x 1, COIL ON PLUG								1.970.545	C10			
ENGINE														
2.0	Petrol	147	07/05-11/14	Z 20 LER										
Engine		Information			A10	A20	A40	A50	A70	C10 - C30	C20	E01		
All engines		x 1, COIL ON PLUG								1.970.507	C10			
ENGINE														
2.0	Petrol	176	01/06-11/14	Z 20 LEH										
Engine		Information			A10	A20	A40	A50	A70	C10 - C30	C20	E01		
All engines		x 1, COIL ON PLUG								1.970.507	C10			

A10	CONDENSER	A20	CONTACT SET	A40	DISTRIBUTOR CAP	A50	ROTOR	A70	PICK-UP
C10	COIL	C20	IGNITION MODULE	C30	ELECTRONIC IGNITION KIT	E01	IGNITION CABLE SET		

Vehicle	alim.	kW	Date	Engine	FUNCTIONS ON THE VEHICLE							
					A10	A20	A40	A50	A70	C10 - C30	C20	E01

ZAFIRA C

				ENGINE
1.4	Petrol	103	10/11-08/18	A 14 NET, B 14 NET

Engine	Information	A10	A20	A40	A50	A70	C10 - C30	C20	E01
All engines	x 1, COIL ON RAIL						1.970.547	C10	

				ENGINE
1.4	Petrol	88	10/11-08/18	A 14 NEL

Engine	Information	A10	A20	A40	A50	A70	C10 - C30	C20	E01
All engines	x 1, COIL ON RAIL						1.970.547	C10	

				ENGINE
1.4 LPG	Petrol/ Liquified Petro- leum Gas (LPG)	103	10/11-08/18	A 14 NET

Engine	Information	A10	A20	A40	A50	A70	C10 - C30	C20	E01
All engines							1.970.547	C10	

				ENGINE
1.6 CNG	Petrol/ Com- pressed Natural Gas (CNG)	110	10/11-08/18	A 16 XNT

Engine	Information	A10	A20	A40	A50	A70	C10 - C30	C20	E01
All engines	x 1, DELPHI, COIL ON PLUG, incl. spark plug connector						1.970.450	C10	

				ENGINE
1.8	Petrol	103	10/11-08/18	A 18 XER

Engine	Information	A10	A20	A40	A50	A70	C10 - C30	C20	E01
All engines	x 1, COIL ON PLUG						1.970.545	C10	

				ENGINE
1.8	Petrol	85	10/11-08/18	A 18 XEL

Engine	Information	A10	A20	A40	A50	A70	C10 - C30	C20	E01
All engines	x 1, COIL ON PLUG						1.970.545	C10	

				ENGINE
1.8	Petrol	88	10/11->	A 18 XEL

Engine	Information	A10	A20	A40	A50	A70	C10 - C30	C20	E01
All engines							1.970.545	C10	

A10	CONDENSER	A20	CONTACT SET	A40	DISTRIBUTOR CAP	A50	ROTOR	A70	PICK-UP
C10	COIL	C20	IGNITION MODULE	C30	ELECTRONIC IGNITION KIT	E01	IGNITION CABLE SET		

The present application list is a brief version. For the detailed information about the possibility of installation on a specific vehicle, please refer to our web-catalogue <http://catalogo.facet.eu/>

FUNCTIONS ON THE VEHICLE

Vehicle	alim.	kW	Date	Engine	 A10	 A20	 A40	 A50	 A70	 C10 - C30	 C20	 E01
---------	-------	----	------	--------	---	---	---	--	---	---	---	---

CADDY

				ENGINE
1.6i	Petrol	66	11/98->	MY4

Engine	Information	A10	A20	A40	A50	A70	C10 - C30	C20	E01
All engines	version Bosch			1.306.094	1.406.121R				
All engines						1.906.233	1.990.414	C30	

GOL

				ENGINE
1.0i	Petrol	0	11/96->	510

Engine	Information	A10	A20	A40	A50	A70	C10 - C30	C20	E01
All engines	version Bosch			1.306.094	1.406.121R	1.906.233			

				ENGINE
1.0i 16v	Petrol	0	09/97->	511

Engine	Information	A10	A20	A40	A50	A70	C10 - C30	C20	E01
All engines	version Bosch			1.306.094	1.406.121R	1.906.233			

				ENGINE
1.0i 16v Turbo	Petrol	0	06/00->	512

Engine	Information	A10	A20	A40	A50	A70	C10 - C30	C20	E01
All engines							1.990.420	C30	

				ENGINE
1.6i	Petrol	0	10/96->	540, 541

Engine	Information	A10	A20	A40	A50	A70	C10 - C30	C20	E01
All engines	version Bosch			1.306.094	1.406.121R	1.906.233			

				ENGINE
1.8i	Petrol	0	10/96->	542, 543

Engine	Information	A10	A20	A40	A50	A70	C10 - C30	C20	E01
All engines	version Bosch			1.306.094	1.406.121R	1.906.233			

				ENGINE
2.0i	Petrol	0	09/94->	528, 529, 546, 547

Engine	Information	A10	A20	A40	A50	A70	C10 - C30	C20	E01
All engines	version Bosch			1.306.094					
Eng. 528, 529	version Bosch				1.406.055R	1.906.160			
Eng. 546, 547	version Bosch				1.406.121R	1.906.233			

				ENGINE
2.0i 16V	Petrol	0	10/95->	112

Engine	Information	A10	A20	A40	A50	A70	C10 - C30	C20	E01
All engines							1.970.168	C10	

GOLF

				ENGINE
A4 1.6i	Petrol	74	10/99->	AKL

Engine	Information	A10	A20	A40	A50	A70	C10 - C30	C20	E01
All engines							1.990.420	C30	1.501.484

				ENGINE
A4 1.8i Turbo 20v	Petrol	110	10/99->	AGU

Engine	Information	A10	A20	A40	A50	A70	C10 - C30	C20	E01
All engines	incl. spark plug connector, Qty: 4						1.970.354	C10	
All engines	without spark plug connector, Qty: 4						1.970.354S	C10	

				ENGINE
A4 2.0i	Petrol	85	08/99->	APK

Engine	Information	A10	A20	A40	A50	A70	C10 - C30	C20	E01
All engines							1.990.420	C30	1.501.585

LOGUS

				ENGINE
2.0i	Petrol	0	12/92-12/96	526, 527, 809

Engine	Information	A10	A20	A40	A50	A70	C10 - C30	C20	E01
Eng. 526, 527	version Bosch			1.306.094	1.406.055R	1.906.160			
Eng. 809	version Bosch				1.406.121R				

PARATI

				ENGINE
1.0i 16v	Petrol	0	09/97->	511









Engine	Information	A10	A20	A40	A50	A70	C10 - C30	C20	E01
All engines	version Bosch			1.306.094	1.406.121R	1.906.233			

A10 CONDENSER	A20 CONTACT SET	A40 DISTRIBUTOR CAP	A50 ROTOR	A70 PICK-UP
C10 COIL	C20 IGNITION MODULE	C30 ELECTRONIC IGNITION KIT	E01 IGNITION CABLE SET	

Vehicle	alim.	kW	Date	Engine	FUNCTIONS ON THE VEHICLE									
					A10	A20	A40	A50	A70	C10 - C30	C20	E01		
ENGINE														
1.0i 16v Turbo	Petrol	0	06/00->	512										
Engine	Information				A10	A20	A40	A50	A70	C10 - C30	C20	E01		
All engines	version Bosch									1.990.420	C30			
ENGINE														
1.6i	Petrol	0	10/96->	540, 541										
Engine	Information				A10	A20	A40	A50	A70	C10 - C30	C20	E01		
All engines	version Bosch						1.306.094	1.406.121R	1.906.233					
ENGINE														
1.8i	Petrol	0	10/96->	542, 543										
Engine	Information				A10	A20	A40	A50	A70	C10 - C30	C20	E01		
All engines	version Bosch						1.306.094	1.406.121R	1.906.233					
ENGINE														
2.0i	Petrol	0	08/95->	528, 529, 546, 547										
Engine	Information				A10	A20	A40	A50	A70	C10 - C30	C20	E01		
All engines	version Bosch						1.306.094							
Eng. 528, 529	version Bosch							1.406.055R	1.906.160					
Eng. 546, 547	version Bosch							1.406.121R	1.906.233					
ENGINE														
2.0i 16V	Petrol	0	02/96->	112										
Engine	Information				A10	A20	A40	A50	A70	C10 - C30	C20	E01		
All engines	version Bosch									1.970.168	C10			
POINTER														
ENGINE														
2.0i	Petrol	0	11/93-12/96	526, 527, 809										
Engine	Information				A10	A20	A40	A50	A70	C10 - C30	C20	E01		
Eng. 526, 527	version Bosch						1.306.094	1.406.055R	1.906.160					
Eng. 809	version Bosch							1.406.121R						
POLO														
ENGINE														
1.4	Petrol	55	07/06->	BKY										
Engine	Information				A10	A20	A40	A50	A70	C10 - C30	C20	E01		
All engines	Qty: 4									1.970.474	C10			
ENGINE														
1.4 16V	Petrol	55	09/02->	BBY										
Engine	Information				A10	A20	A40	A50	A70	C10 - C30	C20	E01		
All engines	Qty: 4									1.970.474	C10			
ENGINE														
1.6	Petrol	74	02/02->	BAH, CCRA										
Engine	Information				A10	A20	A40	A50	A70	C10 - C30	C20	E01		
All engines	version Bosch									1.990.420	C30		1.501.723	
ENGINE														
2.0	Petrol	85	05/02->	BBX										
Engine	Information				A10	A20	A40	A50	A70	C10 - C30	C20	E01		
All engines	version Bosch									1.990.420	C30		1.501.585	
SAVEIRO														
ENGINE														
1.6i	Petrol	0	10/96->	540, 541										
Engine	Information				A10	A20	A40	A50	A70	C10 - C30	C20	E01		
All engines	version Bosch						1.306.094	1.406.121R	1.906.233					
ENGINE														
1.8i	Petrol	0	10/96->	542, 543										
Engine	Information				A10	A20	A40	A50	A70	C10 - C30	C20	E01		
All engines	version Bosch						1.306.094	1.406.121R	1.906.233					
ENGINE														
2.0i	Petrol	0	10/96->	546, 547										
Engine	Information				A10	A20	A40	A50	A70	C10 - C30	C20	E01		
All engines	version Bosch						1.306.094	1.406.121R	1.906.233					

A10	CONDENSER	A20	CONTACT SET	A40	DISTRIBUTOR CAP	A50	ROTOR	A70	PICK-UP
C10	COIL	C20	IGNITION MODULE	C30	ELECTRONIC IGNITION KIT	E01	IGNITION CABLE SET		

The present application list is a brief version. For the detailed information about the possibility of installation on a specific vehicle, please refer to our web-catalogue <http://catalogo.facet.eu/>

				FUNCTIONS ON THE VEHICLE								
Vehicle	alim.	kW	Date	Engine	 A10	 A20	 A40	 A50	 A70	 C10 - C30	 C20	 E01
140				ENGINE								
1.8	Petrol	55	08/66-07/68	B 18 A								
Engine	Information				A10	A20	A40	A50	A70	C10 - C30	C20	E01
All engines						1.206.021						
1.8 S				ENGINE								
1.8 S	Petrol	55	08/66-07/68	B 18 A								
Engine	Information				A10	A20	A40	A50	A70	C10 - C30	C20	E01
All engines						1.206.021						
1.8 S				ENGINE								
1.8 S	Petrol	74	08/66-01/72	B 18 B								
Engine	Information				A10	A20	A40	A50	A70	C10 - C30	C20	E01
All engines						1.206.047						
240				ENGINE								
1.8	Petrol	66	11/78-07/85	B 17 A								
Engine	Information				A10	A20	A40	A50	A70	C10 - C30	C20	E01
All engines	version Bosch					1.206.034HVS	1.306.079	1.406.025R				
2.0				ENGINE								
2.0	Petrol	100	10/82-08/84	B 19 ET								
Engine	Information				A10	A20	A40	A50	A70	C10 - C30	C20	E01
All engines	version Bosch						1.306.079	1.406.025R	1.906.153			
2.0				ENGINE								
2.0	Petrol	60	08/74-07/76	OJX4G20A6L								
Engine	Information				A10	A20	A40	A50	A70	C10 - C30	C20	E01
All engines	version Bosch					1.206.049HVS	1.306.079	1.406.025R				
2.0				ENGINE								
2.0	Petrol	76	08/84-07/90	B 200 K								
Engine	Information				A10	A20	A40	A50	A70	C10 - C30	C20	E01
All engines	version Bosch						1.306.079	1.406.122R				
2.0				ENGINE								
2.0	Petrol	82	09/88-12/93	B 200 F								
Engine	Information				A10	A20	A40	A50	A70	C10 - C30	C20	E01
All engines	version Bosch						1.306.079					
All engines	distr. num. 1367382, 1367468, version Bosch							1.406.121R				
All engines	distr. num. 1336690, 1346919, version Bosch							1.406.122R				
2.0				ENGINE								
2.0	Petrol	86	08/83-07/93	B 200 E								
Engine	Information				A10	A20	A40	A50	A70	C10 - C30	C20	E01
All engines	version Bosch						1.306.079	1.406.122R				
2.0				ENGINE								
2.0	Petrol	89	09/84-12/93	B 200 E								
Engine	Information				A10	A20	A40	A50	A70	C10 - C30	C20	E01
All engines	version Bosch						1.306.079	1.406.122R				
2.1 Turbo				ENGINE								
2.1 Turbo	Petrol	114	08/80-07/85	B 21 ET								
Engine	Information				A10	A20	A40	A50	A70	C10 - C30	C20	E01
All engines	version Bosch						1.306.079	1.406.025R	1.906.153			
2.1 Turbo				ENGINE								
2.1 Turbo	Petrol	121	08/80-07/85	B 21 FT								
Engine	Information				A10	A20	A40	A50	A70	C10 - C30	C20	E01
All engines	version Bosch						1.306.079	1.406.025R	1.906.153			
2.3				ENGINE								
2.3	Petrol	81	08/84-07/86	B 230 A								
Engine	Information				A10	A20	A40	A50	A70	C10 - C30	C20	E01
All engines	version Bosch						1.306.079	1.406.122R				
2.3				ENGINE								
2.3	Petrol	82	08/80-07/84	B 23 A								
Engine	Information				A10	A20	A40	A50	A70	C10 - C30	C20	E01
All engines								1.406.067R				

A10 CONDENSER	A20 CONTACT SET	A40 DISTRIBUTOR CAP	A50 ROTOR	A70 PICK-UP
C10 COIL	C20 IGNITION MODULE	C30 ELECTRONIC IGNITION KIT	E01 IGNITION CABLE SET	

Vehicle	alim.	kW	Date	Engine	FUNCTIONS ON THE VEHICLE									
					A10	A20	A40	A50	A70	C10 - C30	C20	E01		
ENGINE														
2.3	Petrol	83	08/86-07/87	B 230 F										
Engine	Information				A10	A20	A40	A50	A70	C10 - C30	C20	E01		
All engines	version Bosch						1.306.079							
All engines	distr. num. 1332587, version Bosch							1.406.055R						
All engines	distr. num. 1367382, version Bosch							1.406.121R						
ENGINE														
2.3	Petrol	85	08/86-07/93	B 230 FD, B 230 K										
Engine	Information				A10	A20	A40	A50	A70	C10 - C30	C20	E01		
All engines	version Bosch						1.306.079							
All engines	distr. num. 1367382, 1367468, version Bosch							1.406.121R						
Eng. B 230 FD	distr. num. 1336690, 1346919, version Bosch							1.406.122R						
ENGINE														
2.3	Petrol	96	08/83-07/92	B 230 E										
Engine	Information				A10	A20	A40	A50	A70	C10 - C30	C20	E01		
All engines	version Bosch						1.306.079	1.406.122R						
ENGINE														
2.3 Cat	Petrol	100	08/91-07/92	B 230 F										
Engine	Information				A10	A20	A40	A50	A70	C10 - C30	C20	E01		
All engines	version Bosch						1.306.079							
All engines	distr. num. 1367382, 1367468, version Bosch							1.406.121R						
All engines	distr. num. 1336690, 1346919, version Bosch							1.406.122R						
ENGINE														
2.3 i Cat	Petrol	85	08/86-07/93	B 230 F										
Engine	Information				A10	A20	A40	A50	A70	C10 - C30	C20	E01		
All engines	version Bosch						1.306.079							
All engines	distr. num. 1332587, version Bosch							1.406.055R						
All engines	distr. num. 1367382, 1367468, version Bosch							1.406.121R						
ENGINE														
2.8	Petrol	114	10/80-09/84	B 28 E										
Engine	Information				A10	A20	A40	A50	A70	C10 - C30	C20	E01		
All engines	version Bosch							1.406.023R						
260														
ENGINE														
2.8	Petrol	114	08/80-07/85	B 28 E										
Engine	Information				A10	A20	A40	A50	A70	C10 - C30	C20	E01		
All engines	version Bosch							1.406.023R						
340-360														
ENGINE														
1.3	Petrol	49	01/89-12/90	B 13										
Engine	Information				A10	A20	A40	A50	A70	C10 - C30	C20	E01		
All engines	version Ducellier						1.315.059	1.415.096R						
All engines										1.970.107	C10		1.501.332	
ENGINE														
1.4	Petrol	46	08/82-08/85	B 14.3 E										
Engine	Information				A10	A20	A40	A50	A70	C10 - C30	C20	E01		
All engines	version Ducellier						1.315.059	1.415.096R						
All engines								1.412.093R		1.970.107	C10		1.501.332	
ENGINE														
1.4	Petrol	50	08/86-12/88	B 14.4 S										
Engine	Information				A10	A20	A40	A50	A70	C10 - C30	C20	E01		
All engines	version Ducellier						1.315.059	1.415.096R						
All engines								1.412.093R		1.970.107	C10		1.501.332	
ENGINE														
1.4	Petrol	51	08/87-07/88	B 14.4 S										
Engine	Information				A10	A20	A40	A50	A70	C10 - C30	C20	E01		
All engines	version Ducellier						1.315.059	1.415.096R						
All engines								1.412.093R		1.970.107	C10		1.501.332	
ENGINE														
1.4	Petrol	52	08/83-07/86	B 14.4 S										
Engine	Information				A10	A20	A40	A50	A70	C10 - C30	C20	E01		
All engines	version Ducellier						1.315.059	1.415.096R						

A10	CONDENSER	A20	CONTACT SET	A40	DISTRIBUTOR CAP	A50	ROTOR	A70	PICK-UP
C10	COIL	C20	IGNITION MODULE	C30	ELECTRONIC IGNITION KIT	E01	IGNITION CABLE SET		

The present application list is a brief version. For the detailed information about the possibility of installation on a specific vehicle, please refer to our web-catalogue <http://catalogo.facet.eu/>

Vehicle	alim.	kW	Date	Engine	FUNCTIONS ON THE VEHICLE									
					A10	A20	A40	A50	A70	C10 - C30	C20	E01		
ENGINE														
2.0	Petrol	87	08/84-07/86	B 200 E										
ENGINE														
2.0														
Engine	Information				A10	A20	A40	A50	A70	C10 - C30	C20	E01		
All engines	MODEL TO: 1986, version Bosch							1.406.122R						
All engines										1.970.107	C10			
ENGINE														
440														
1.6	Petrol	61	09/88-12/96	B 16 F										
ENGINE														
1.6														
Engine	Information				A10	A20	A40	A50	A70	C10 - C30	C20	E01		
All engines	version Ducellier						1.315.069	1.415.097						
All engines	Kit, version Ducellier						1.315.071							
All engines										1.970.107	C10		1.500.415	
ENGINE														
1.7	Petrol	58	09/88-08/92	B 18 KD										
ENGINE														
1.7														
Engine	Information				A10	A20	A40	A50	A70	C10 - C30	C20	E01		
All engines	version Ducellier						1.315.069	1.415.097						
All engines	Kit, version Ducellier						1.315.071							
All engines										1.970.107	C10		1.500.415	
ENGINE														
1.7	Petrol	60	09/88-08/89	B 18 K										
ENGINE														
1.7														
Engine	Information				A10	A20	A40	A50	A70	C10 - C30	C20	E01		
All engines	version Ducellier						1.315.069	1.415.097						
All engines	Kit, version Ducellier						1.315.071							
All engines										1.970.107	C10		1.500.415	
ENGINE														
1.7	Petrol	64	09/88-12/96	B 18 KP										
ENGINE														
1.7														
Engine	Information				A10	A20	A40	A50	A70	C10 - C30	C20	E01		
All engines	version Ducellier						1.315.069	1.415.097						
All engines	Kit, version Ducellier						1.315.071							
All engines										1.970.107	C10		1.500.415	
ENGINE														
1.7	Petrol	70	08/88-07/89	B 18 F										
ENGINE														
1.7														
Engine	Information				A10	A20	A40	A50	A70	C10 - C30	C20	E01		
All engines	version Ducellier						1.315.069	1.415.097						
All engines	Kit, version Ducellier						1.315.071							
All engines										1.970.107	C10		1.500.415	
ENGINE														
1.7	Petrol	75	08/89-12/96	B 18 FP										
ENGINE														
1.7														
Engine	Information				A10	A20	A40	A50	A70	C10 - C30	C20	E01		
All engines	version Ducellier						1.315.069	1.415.097						
All engines	Kit, version Ducellier						1.315.071							
All engines										1.970.107	C10		1.500.415	
ENGINE														
1.7	Petrol	78	09/88-12/96	B 18 EP										
ENGINE														
1.7														
Engine	Information				A10	A20	A40	A50	A70	C10 - C30	C20	E01		
All engines	version Ducellier						1.315.069	1.415.097						
All engines	Kit, version Ducellier						1.315.071							
All engines										1.970.107	C10		1.500.415	
ENGINE														
1.7	Petrol	80	08/88-07/89	B 18 E										
ENGINE														
1.7														
Engine	Information				A10	A20	A40	A50	A70	C10 - C30	C20	E01		
All engines	version Ducellier						1.315.069	1.415.097						
All engines	Kit, version Ducellier						1.315.071							
All engines										1.970.107	C10		1.500.415	
ENGINE														
1.7 Turbo	Petrol	88	08/88-07/96	B 18 FT										
ENGINE														
1.7 Turbo														
Engine	Information				A10	A20	A40	A50	A70	C10 - C30	C20	E01		
All engines	version Ducellier						1.315.069	1.415.097						
All engines	Kit, version Ducellier						1.315.071							
All engines													1.500.417	

A10	CONDENSER	A20	CONTACT SET	A40	DISTRIBUTOR CAP	A50	ROTOR	A70	PICK-UP
C10	COIL	C20	IGNITION MODULE	C30	ELECTRONIC IGNITION KIT	E01	IGNITION CABLE SET		

The present application list is a brief version. For the detailed information about the possibility of installation on a specific vehicle, please refer to our web-catalogue <http://catalogo.facet.eu/>









				FUNCTIONS ON THE VEHICLE								
Vehicle	alim.	kW	Date	Engine								
				ENGINE								
1.7 Turbo	Petrol	90	01/91-12/96	B 18 FT								
Engine	Information			A10	A20	A40	A50	A70	C10 - C30	C20	E01	
All engines	version Ducellier					1.315.069	1.415.097					
All engines	Kit, version Ducellier					1.315.071						
All engines												1.500.417
				ENGINE								
1.8	Petrol	66	08/91-12/96	B 18 U								
Engine	Information			A10	A20	A40	A50	A70	C10 - C30	C20	E01	
All engines	version Ducellier					1.315.069	1.415.097					
All engines	Kit, version Ducellier					1.315.071						
All engines									1.970.107	C10		1.500.415
				ENGINE								
2.0	Petrol	80	08/93-07/96	B 20 F								
Engine	Information			A10	A20	A40	A50	A70	C10 - C30	C20	E01	
All engines	version Ducellier					1.315.069	1.415.097					
All engines	Kit, version Ducellier					1.315.071						
All engines									1.970.107	C10		1.500.415
				ENGINE								
2.0	Petrol	81	08/92-07/95	B 20 F								
Engine	Information			A10	A20	A40	A50	A70	C10 - C30	C20	E01	
All engines	version Ducellier					1.315.069	1.415.097					
All engines	Kit, version Ducellier					1.315.071						
All engines									1.970.107	C10		1.500.415
				ENGINE								
460												
				ENGINE								
1.6	Petrol	61	07/92-07/96	B 16 F								
Engine	Information			A10	A20	A40	A50	A70	C10 - C30	C20	E01	
All engines	version Ducellier					1.315.069	1.415.097					
All engines	Kit, version Ducellier					1.315.071						
All engines									1.970.107	C10		1.500.415
				ENGINE								
1.7	Petrol	58	08/89-07/92	B 18 K, B 18 KD								
Engine	Information			A10	A20	A40	A50	A70	C10 - C30	C20	E01	
All engines	version Ducellier					1.315.069	1.415.097					
All engines	Kit, version Ducellier					1.315.071						
All engines									1.970.107	C10		1.500.415
				ENGINE								
1.7	Petrol	64	09/88-07/96	B 18 KP								
Engine	Information			A10	A20	A40	A50	A70	C10 - C30	C20	E01	
All engines	version Ducellier					1.315.069	1.415.097					
All engines	Kit, version Ducellier					1.315.071						
All engines									1.970.107	C10		1.500.415
				ENGINE								
1.7	Petrol	66	09/90-07/96	B 18 KP								
Engine	Information			A10	A20	A40	A50	A70	C10 - C30	C20	E01	
All engines	version Ducellier					1.315.069	1.415.097					
All engines	Kit, version Ducellier					1.315.071						
All engines									1.970.107	C10		1.500.415
				ENGINE								
1.7	Petrol	75	08/89-07/95	B 18 EP, B 18 FP								
Engine	Information			A10	A20	A40	A50	A70	C10 - C30	C20	E01	
All engines	version Ducellier					1.315.069	1.415.097					
All engines	Kit, version Ducellier					1.315.071						
All engines									1.970.107	C10		1.500.415
				ENGINE								
1.7 Turbo	Petrol	88	08/89-07/96	B 18 FT								
Engine	Information			A10	A20	A40	A50	A70	C10 - C30	C20	E01	
All engines	version Ducellier					1.315.069	1.415.097					
All engines	Kit, version Ducellier					1.315.071						
All engines												1.500.417

A10 CONDENSER	A20 CONTACT SET	A40 DISTRIBUTOR CAP	A50 ROTOR	A70 PICK-UP
C10 COIL	C20 IGNITION MODULE	C30 ELECTRONIC IGNITION KIT	E01 IGNITION CABLE SET	

Vehicle	alim.	kW	Date	Engine	FUNCTIONS ON THE VEHICLE							
					A10	A20	A40	A50	A70	C10 - C30	C20	E01
ENGINE												
1.7 Turbo	Petrol	90	01/91-07/96	B 18 FT								
Engine	Information			A10	A20	A40	A50	A70	C10 - C30	C20	E01	
All engines	version Ducellier					1.315.069	1.415.097					
All engines	Kit, version Ducellier					1.315.071						
All engines											1.500.417	
ENGINE												
1.8	Petrol	66	08/91-07/96	B 18 U								
Engine	Information			A10	A20	A40	A50	A70	C10 - C30	C20	E01	
All engines	version Ducellier					1.315.069	1.415.097					
All engines	Kit, version Ducellier					1.315.071						
All engines								1.970.107	C10		1.500.415	
ENGINE												
2.0	Petrol	80	08/93-07/96	B 20 F								
Engine	Information			A10	A20	A40	A50	A70	C10 - C30	C20	E01	
All engines	version Ducellier					1.315.069	1.415.097					
All engines	Kit, version Ducellier					1.315.071						
All engines								1.970.107	C10		1.500.415	
ENGINE												
2.0	Petrol	81	08/92-07/95	B 20 F								
Engine	Information			A10	A20	A40	A50	A70	C10 - C30	C20	E01	
All engines	version Ducellier					1.315.069	1.415.097					
All engines	Kit, version Ducellier					1.315.071						
All engines								1.970.107	C10		1.500.415	
480												
ENGINE												
1.7	Petrol	70	08/87-07/89	B 18 F								
Engine	Information			A10	A20	A40	A50	A70	C10 - C30	C20	E01	
All engines	version Ducellier					1.315.069	1.415.097					
All engines	Kit, version Ducellier					1.315.071						
All engines								1.970.107	C10		1.500.415	
ENGINE												
1.7	Petrol	75	08/89-07/96	B 18 EP, B 18 FP								
Engine	Information			A10	A20	A40	A50	A70	C10 - C30	C20	E01	
All engines	version Ducellier					1.315.069	1.415.097					
All engines	Kit, version Ducellier					1.315.071						
All engines								1.970.107	C10		1.500.415	
ENGINE												
1.7	Petrol	78	04/86-09/95	B 18 E, B 18 EP								
Engine	Information			A10	A20	A40	A50	A70	C10 - C30	C20	E01	
All engines	version Ducellier					1.315.069	1.415.097					
All engines	Kit, version Ducellier					1.315.071						
All engines								1.970.107	C10		1.500.415	
ENGINE												
1.7	Petrol	80	08/86-07/88	B 18 E								
Engine	Information			A10	A20	A40	A50	A70	C10 - C30	C20	E01	
All engines	version Ducellier					1.315.069	1.415.097					
All engines	Kit, version Ducellier					1.315.071						
All engines								1.970.107	C10		1.500.415	
ENGINE												
1.7 Turbo	Petrol	88	08/87-07/96	B 18 FT								
Engine	Information			A10	A20	A40	A50	A70	C10 - C30	C20	E01	
All engines	version Ducellier					1.315.069	1.415.097					
All engines	Kit, version Ducellier					1.315.071						
All engines											1.500.417	
ENGINE												
1.7 Turbo	Petrol	90	01/91-07/96	B 18 FT								
Engine	Information			A10	A20	A40	A50	A70	C10 - C30	C20	E01	
All engines	version Ducellier					1.315.069	1.415.097					
All engines	Kit, version Ducellier					1.315.071						
All engines											1.500.417	

A10 CONDENSER	A20 CONTACT SET	A40 DISTRIBUTOR CAP	A50 ROTOR	A70 PICK-UP
C10 COIL	C20 IGNITION MODULE	C30 ELECTRONIC IGNITION KIT	E01 IGNITION CABLE SET	

The present application list is a brief version. For the detailed information about the possibility of installation on a specific vehicle, please refer to our web-catalogue <http://catalogo.facet.eu/>

				FUNCTIONS ON THE VEHICLE								
Vehicle	alim.	kW	Date	Engine								
				ENGINE								
2.0	Petrol	81	08/92-09/95	B 20 F								
				ENGINE								
Engine	Information			A10	A20	A40	A50	A70	C10 - C30	C20	E01	
All engines	version Ducellier					1.315.069	1.415.097					
All engines	Kit, version Ducellier					1.315.071						
All engines									1.970.107	C10		1.500.415
				740								
				ENGINE								
2.0	Petrol	118	01/86-08/90	B 200 ET								
				ENGINE								
Engine	Information			A10	A20	A40	A50	A70	C10 - C30	C20	E01	
All engines	version Bosch					1.306.127	1.406.118R					
All engines												1.500.372
				ENGINE								
2.0	Petrol	120	01/85-12/85	B 200 ET								
				ENGINE								
Engine	Information			A10	A20	A40	A50	A70	C10 - C30	C20	E01	
All engines	version Bosch					1.306.127	1.406.118R					
All engines												1.500.372
				ENGINE								
2.0	Petrol	76	09/88-08/90	B 200 K								
				ENGINE								
Engine	Information			A10	A20	A40	A50	A70	C10 - C30	C20	E01	
All engines	version Bosch					1.306.127	1.406.118R	1.906.222				
				ENGINE								
2.0	Petrol	86	01/87-08/88	B 200 E								
				ENGINE								
Engine	Information			A10	A20	A40	A50	A70	C10 - C30	C20	E01	
All engines	version Bosch					1.306.127	1.406.118R	1.906.222				
All engines												1.500.372
				ENGINE								
2.0	Petrol	89	08/85-07/92	B 200 G								
				ENGINE								
Engine	Information			A10	A20	A40	A50	A70	C10 - C30	C20	E01	
All engines	version Bosch					1.306.127	1.406.118R	1.906.222				
All engines												1.500.372
				ENGINE								
2.0 16V	Petrol	100	09/87-08/90	B 204 E								
				ENGINE								
Engine	Information			A10	A20	A40	A50	A70	C10 - C30	C20	E01	
All engines	version Bosch					1.306.127	1.406.118R					
				ENGINE								
2.0 16V Turbo	Petrol	136	08/89-07/90	B 204 GT								
				ENGINE								
Engine	Information			A10	A20	A40	A50	A70	C10 - C30	C20	E01	
All engines	version Bosch					1.306.127	1.406.118R					
				ENGINE								
2.0 16V Turbo	Petrol	140	08/89-07/90	B 204 FT								
				ENGINE								
Engine	Information			A10	A20	A40	A50	A70	C10 - C30	C20	E01	
All engines	version Bosch					1.306.127	1.406.118R					
				ENGINE								
2.0 GLE	Petrol	103	09/87-08/90	B 204 E								
				ENGINE								
Engine	Information			A10	A20	A40	A50	A70	C10 - C30	C20	E01	
All engines	version Bosch					1.306.127	1.406.118R					
				ENGINE								
2.0 Turbo	Petrol	114	09/90-08/91	B 200 FT								
				ENGINE								
Engine	Information			A10	A20	A40	A50	A70	C10 - C30	C20	E01	
All engines	version Bosch					1.306.127	1.406.118R					
All engines												1.500.372
				ENGINE								
2.0 Turbo	Petrol	115	09/87-08/90	B 200 ET								
				ENGINE								
Engine	Information			A10	A20	A40	A50	A70	C10 - C30	C20	E01	
All engines	version Bosch					1.306.127	1.406.118R					
All engines												1.500.372
				ENGINE								
2.3	Petrol	111	08/88-08/92	B 234 F								
				ENGINE								
Engine	Information			A10	A20	A40	A50	A70	C10 - C30	C20	E01	
All engines	version Bosch					1.306.127	1.406.118R					

A10 CONDENSER	A20 CONTACT SET	A40 DISTRIBUTOR CAP	A50 ROTOR	A70 PICK-UP
C10 COIL	C20 IGNITION MODULE	C30 ELECTRONIC IGNITION KIT	E01 IGNITION CABLE SET	

Vehicle	alim.	kW	Date	Engine	FUNCTIONS ON THE VEHICLE									
					A10	A20	A40	A50	A70	C10 - C30	C20	E01		
ENGINE														
2.3	Petrol	114	08/88-07/91	B 234 F										
ENGINE														
All engines							1.306.127	1.406.118R						
2.3	Petrol	117	08/87-07/89	B 234 F			1.306.127	1.406.118R						
ENGINE														
All engines							1.306.127	1.406.118R						
2.3	Petrol	82	08/84-07/86	B 230 A										
ENGINE														
All engines							1.306.079	1.406.122R						
2.3	Petrol	83	08/85-12/89	B 230 F										
ENGINE														
All engines							1.306.127	1.406.118R						
All engines									1.906.222					
All engines													1.500.372	
2.3	Petrol	84	08/84-07/90	B 230 F, B 230 K										
ENGINE														
All engines							1.306.127	1.406.118R						
All engines									1.906.222					
All engines													1.500.372	
2.3	Petrol	85	08/87-07/92	B 230 F										
ENGINE														
All engines							1.306.127	1.406.118R						
All engines									1.906.222					
All engines													1.500.372	
2.3	Petrol	86	08/84-07/90	B 230 K										
ENGINE														
All engines							1.306.127	1.406.118R	1.906.222					
All engines													1.500.372	
2.3	Petrol	94	08/91-07/92	B 230 G										
ENGINE														
All engines							1.306.127	1.406.118R						
All engines													1.500.372	
2.3	Petrol	96	08/84-12/92	B 230 E, B 230 FB										
ENGINE														
All engines							1.306.127	1.406.118R						
Eng. B 230 E									1.906.222					
All engines													1.500.372	
2.3 GL	Petrol	89	08/84-08/87	B 230 E										
ENGINE														
All engines							1.306.127	1.406.118R	1.906.222					
All engines													1.500.372	
2.3 Turbo	Petrol	115	08/86-07/89	B 230 FT										
ENGINE														
All engines							1.306.127	1.406.118R						
All engines									1.906.222					
All engines													1.500.372	
2.3 Turbo	Petrol	121	08/89-07/90	B 230 FT, B 230 GT										
ENGINE														
All engines							1.306.127	1.406.118R						

A10 CONDENSER	A20 CONTACT SET	A40 DISTRIBUTOR CAP	A50 ROTOR	A70 PICK-UP
C10 COIL	C20 IGNITION MODULE	C30 ELECTRONIC IGNITION KIT	E01 IGNITION CABLE SET	









The present application list is a brief version. For the detailed information about the possibility of installation on a specific vehicle, please refer to our web-catalogue <http://catalogo.facet.eu/>

					FUNCTIONS ON THE VEHICLE							
Vehicle	alim.	kW	Date	Engine	 A10	 A20	 A40	 A50	 A70	 C10 - C30	 C20	 E01
ENGINE												
2.3 Turbo	Petrol	121	08/89-07/90	B 230 FT, B 230 GT								
Engine	Information			A10	A20	A40	A50	A70	C10 - C30	C20	E01	
Eng. B 230 FT	distr. num. 1336087, version Bosch							1.906.222				
All engines											1.500.372	
ENGINE												
2.3 Turbo	Petrol	125	09/89-08/91	B 230 FT, B 230 GT								
Engine	Information			A10	A20	A40	A50	A70	C10 - C30	C20	E01	
All engines	version Bosch					1.306.127	1.406.118R					
Eng. B 230 FT	distr. num. 1336087, version Bosch							1.906.222				
All engines											1.500.372	
ENGINE												
2.3 Turbo	Petrol	134	08/85-12/88	B 230 ET								
Engine	Information			A10	A20	A40	A50	A70	C10 - C30	C20	E01	
All engines	version Bosch					1.306.127	1.406.118R					
All engines											1.500.372	
ENGINE												
2.3 Turbo	Petrol	140	08/89-07/90	B 230 FT								
Engine	Information			A10	A20	A40	A50	A70	C10 - C30	C20	E01	
All engines	version Bosch					1.306.127	1.406.118R					
All engines	distr. num. 1336087, version Bosch							1.906.222				
All engines											1.500.372	
760												
ENGINE												
2.3	Petrol	121	01/88-07/92	B 230 FT								
Engine	Information			A10	A20	A40	A50	A70	C10 - C30	C20	E01	
All engines	version Bosch					1.306.127	1.406.118R					
All engines	distr. num. 1336087, version Bosch							1.906.222				
All engines											1.500.372	
ENGINE												
2.3	Petrol	130	08/84-08/87	B 230 ET								
Engine	Information			A10	A20	A40	A50	A70	C10 - C30	C20	E01	
All engines	version Bosch					1.306.127	1.406.118R					
All engines											1.500.372	
ENGINE												
2.3	Petrol	84	08/84-08/87	B 230 K								
Engine	Information			A10	A20	A40	A50	A70	C10 - C30	C20	E01	
All engines	version Bosch					1.306.127	1.406.118R	1.906.222				
All engines											1.500.372	
ENGINE												
2.3 Turbo	Petrol	115	08/84-08/90	B 230 FT								
Engine	Information			A10	A20	A40	A50	A70	C10 - C30	C20	E01	
All engines	version Bosch					1.306.127	1.406.118R					
All engines	distr. num. 1336087, version Bosch							1.906.222				
All engines											1.500.372	
ENGINE												
2.3 Turbo	Petrol	119	08/83-07/84	B 23 FT								
Engine	Information			A10	A20	A40	A50	A70	C10 - C30	C20	E01	
All engines	version Bosch					1.306.079	1.406.055R					
ENGINE												
2.3 Turbo	Petrol	121	08/89-07/90	B 230 GT								
Engine	Information			A10	A20	A40	A50	A70	C10 - C30	C20	E01	
All engines	version Bosch					1.306.127	1.406.118R					
All engines											1.500.372	
ENGINE												
2.3 Turbo	Petrol	127	08/82-07/84	B 23 ET								
Engine	Information			A10	A20	A40	A50	A70	C10 - C30	C20	E01	
All engines	version Bosch					1.306.079	1.406.055R					
ENGINE												
2.3 Turbo	Petrol	134	08/84-08/90	B 230 ET								
Engine	Information			A10	A20	A40	A50	A70	C10 - C30	C20	E01	
All engines	version Bosch					1.306.127	1.406.118R					
Legend												
A10	CONDENSER	A20	CONTACT SET	A40	DISTRIBUTOR CAP	A50	ROTOR	A70	PICK-UP			
C10	COIL	C20	IGNITION MODULE	C30	ELECTRONIC IGNITION KIT	E01	IGNITION CABLE SET					

Vehicle	alim.	kW	Date	Engine	FUNCTIONS ON THE VEHICLE									
					A10	A20	A40	A50	A70	C10 - C30	C20	E01		
ENGINE														
2.3 Turbo	Petrol	134	08/84-08/90	B 230 ET										
Engine	Information				A10	A20	A40	A50	A70	C10 - C30	C20	E01		
All engines	version Bosch												1.500.372	
ENGINE														
2.8	Petrol	105	05/86-08/91	B 280 F										
Engine	Information				A10	A20	A40	A50	A70	C10 - C30	C20	E01		
All engines	version Bosch						1.306.236	1.406.119R						
ENGINE														
2.8	Petrol	108	08/86-07/90	B 280 F										
Engine	Information				A10	A20	A40	A50	A70	C10 - C30	C20	E01		
All engines	version Bosch						1.306.236	1.406.119R						
ENGINE														
2.8	Petrol	112	09/86-10/88	B 280 E										
Engine	Information				A10	A20	A40	A50	A70	C10 - C30	C20	E01		
All engines	version Bosch						1.306.236	1.406.119R						
ENGINE														
2.8	Petrol	114	08/82-04/86	B 28 F										
Engine	Information				A10	A20	A40	A50	A70	C10 - C30	C20	E01		
All engines	version Bosch							1.406.023R						
ENGINE														
2.8	Petrol	115	08/81-08/90	B 28 E, B 280 E										
Engine	Information				A10	A20	A40	A50	A70	C10 - C30	C20	E01		
Eng. B 280 E	version Bosch						1.306.236	1.406.119R						
Eng. B 28 E	version Bosch							1.406.023R						
ENGINE														
2.8	Petrol	125	08/84-08/90	B 280 E										
Engine	Information				A10	A20	A40	A50	A70	C10 - C30	C20	E01		
All engines	version Bosch						1.306.236	1.406.119R						
ENGINE														
2.8	Petrol	95	01/82-12/87	B 28 A										
Engine	Information				A10	A20	A40	A50	A70	C10 - C30	C20	E01		
All engines	version Bosch							1.406.023R						
780														
ENGINE														
2.0i	Petrol	0	01/87-12/90	B 204 GT										
Engine	Information				A10	A20	A40	A50	A70	C10 - C30	C20	E01		
All engines	version Bosch						1.306.127	1.406.118R						
ENGINE														
2.0i Turbo	Petrol	0	01/87-12/90	B 200 ET										
Engine	Information				A10	A20	A40	A50	A70	C10 - C30	C20	E01		
All engines	version Bosch						1.306.127	1.406.118R						
ENGINE														
2.9	Petrol	108	08/87-07/90	B 280 F										
Engine	Information				A10	A20	A40	A50	A70	C10 - C30	C20	E01		
All engines	version Bosch						1.306.236	1.406.119R						
ENGINE														
2.9	Petrol	115	08/86-07/87	B 280 E										
Engine	Information				A10	A20	A40	A50	A70	C10 - C30	C20	E01		
All engines	version Bosch						1.306.236	1.406.119R						
850														
ENGINE														
2.0	Petrol	105	06/91-12/96	B 5204 F										
Engine	Information				A10	A20	A40	A50	A70	C10 - C30	C20	E01		
All engines	version Bosch						1.306.260	1.406.147R						
All engines	MODEL FROM: 1996									1.990.423	C30			
All engines													1.499.064	
ENGINE														
2.0	Petrol	93	08/94-12/96	B 5202 S										
Engine	Information				A10	A20	A40	A50	A70	C10 - C30	C20	E01		
All engines	version Bosch						1.306.260	1.406.147R						

A10 CONDENSER	A20 CONTACT SET	A40 DISTRIBUTOR CAP	A50 ROTOR	A70 PICK-UP
C10 COIL	C20 IGNITION MODULE	C30 ELECTRONIC IGNITION KIT	E01 IGNITION CABLE SET	

The present application list is a brief version. For the detailed information about the possibility of installation on a specific vehicle, please refer to our web-catalogue <http://catalogo.facet.eu/>









				FUNCTIONS ON THE VEHICLE								
Vehicle	alim.	kW	Date	Engine								
				ENGINE								
2.0	Petrol	93	08/94-12/96	B 5202 S								
				ENGINE								
Engine		Information		A10	A20	A40	A50	A70	C10 - C30		C20	E01
All engines		MODEL FROM: 1996							1.990.423	C30		
All engines												1.499.064
				ENGINE								
2.0 Turbo	Petrol	132	09/93-10/97	B 5204 T2								
				ENGINE								
Engine		Information		A10	A20	A40	A50	A70	C10 - C30		C20	E01
All engines		version Bosch				1.306.260	1.406.147R					
All engines		MODEL FROM: 1996							1.990.423	C30		
All engines												1.499.064
				ENGINE								
2.0 Turbo	Petrol	155	02/93-12/96	B 5204 FT, B 5204 T								
				ENGINE								
Engine		Information		A10	A20	A40	A50	A70	C10 - C30		C20	E01
All engines		version Bosch				1.306.260	1.406.147R					
All engines		MODEL FROM: 1996							1.990.423	C30		
All engines												1.499.064
				ENGINE								
2.3	Petrol	106	01/96-10/96	B 5234 FS								
				ENGINE								
Engine		Information		A10	A20	A40	A50	A70	C10 - C30		C20	E01
All engines		version Bosch				1.306.260	1.406.147R					
All engines		MODEL FROM: 1996							1.990.423	C30		
All engines												1.499.064
				ENGINE								
2.3 T5	Petrol	166	02/93-12/96	9M9T 872								
				ENGINE								
Engine		Information		A10	A20	A40	A50	A70	C10 - C30		C20	E01
All engines		version Bosch				1.306.260	1.406.147R					
All engines		MODEL FROM: 1996							1.990.423	C30		
All engines												1.499.064
				ENGINE								
2.3 T5-R	Petrol	184	08/95-12/96	B 5234 T4								
				ENGINE								
Engine		Information		A10	A20	A40	A50	A70	C10 - C30		C20	E01
All engines		version Bosch				1.306.260	1.406.147R					
All engines		MODEL FROM: 1996							1.990.423	C30		
All engines												1.499.064
				ENGINE								
2.3 Turbo R	Petrol	177	06/95-10/97	B 5234 T5								
				ENGINE								
Engine		Information		A10	A20	A40	A50	A70	C10 - C30		C20	E01
All engines		version Bosch				1.306.260	1.406.147R					
All engines		MODEL FROM: 1996							1.990.423	C30		
All engines												1.499.064
				ENGINE								
2.4	Petrol	103	06/91-07/94	B 5252								
				ENGINE								
Engine		Information		A10	A20	A40	A50	A70	C10 - C30		C20	E01
All engines		version Bosch				1.306.260	1.406.147R					
All engines		MODEL FROM: 1996							1.990.423	C30		
All engines												1.499.064
				ENGINE								
2.4	Petrol	106	08/94-12/96	B 5252 FS								
				ENGINE								
Engine		Information		A10	A20	A40	A50	A70	C10 - C30		C20	E01
All engines		version Bosch				1.306.260	1.406.147R					
All engines		MODEL FROM: 1996							1.990.423	C30		
All engines												1.499.064
				ENGINE								
2.4	Petrol	125	08/91-12/96	B 5254 S								
				ENGINE								
Engine		Information		A10	A20	A40	A50	A70	C10 - C30		C20	E01
All engines		version Bosch				1.306.260	1.406.147R					
All engines		MODEL FROM: 1996							1.990.423	C30		
All engines												1.499.064
				ENGINE								
2.4 AWD	Petrol	142	04/96-12/96	B 5254 T								
				ENGINE								
Engine		Information		A10	A20	A40	A50	A70	C10 - C30		C20	E01
All engines		version Bosch				1.306.260	1.406.147R					
All engines		MODEL FROM: 1996							1.990.423	C30		
All engines												1.499.064

A10 CONDENSER	A20 CONTACT SET	A40 DISTRIBUTOR CAP	A50 ROTOR	A70 PICK-UP
C10 COIL	C20 IGNITION MODULE	C30 ELECTRONIC IGNITION KIT	E01 IGNITION CABLE SET	

Vehicle	alim.	kW	Date	Engine	FUNCTIONS ON THE VEHICLE									
					A10	A20	A40	A50	A70	C10 - C30	C20	E01		
ENGINE														
2.4 GLE	Petrol	142	09/93-10/97	B 5254 T										
Engine	Information				A10	A20	A40	A50	A70	C10 - C30	C20	E01		
All engines	version Bosch						1.306.260	1.406.147R						
All engines										1.990.423	C30		1.499.064	
ENGINE														
2.5 10V	Petrol	103	06/91-07/94	B 5252 FS										
Engine	Information				A10	A20	A40	A50	A70	C10 - C30	C20	E01		
All engines	version Bosch						1.306.260	1.406.147R						
All engines	MODEL FROM: 1996									1.990.423	C30			
All engines													1.499.064	
ENGINE														
2.5 10V	Petrol	106	08/94-12/97	B 5252 FS										
Engine	Information				A10	A20	A40	A50	A70	C10 - C30	C20	E01		
All engines	version Bosch						1.306.260	1.406.147R						
All engines	MODEL FROM: 1996									1.990.423	C30			
All engines													1.499.064	
940 I														
ENGINE														
2.0	Petrol	82	01/92-07/94	B 200 F										
Engine	Information				A10	A20	A40	A50	A70	C10 - C30	C20	E01		
All engines	version Bosch						1.306.127	1.406.118R						
All engines													1.500.372	
ENGINE														
2.0	Petrol	88	08/90-07/91	B 200 E										
Engine	Information				A10	A20	A40	A50	A70	C10 - C30	C20	E01		
All engines	version Bosch						1.306.127	1.406.118R						
All engines													1.500.372	
ENGINE														
2.0	Petrol	89	09/90-09/93	B 200 E, B 200 G										
Engine	Information				A10	A20	A40	A50	A70	C10 - C30	C20	E01		
All engines	version Bosch						1.306.127	1.406.118R						
Eng. B 200 E	version Bosch								1.906.222					
All engines													1.500.372	
ENGINE														
2.0 GL	Petrol	103	09/90-04/92	B 204 E										
Engine	Information				A10	A20	A40	A50	A70	C10 - C30	C20	E01		
All engines	version Bosch						1.306.127	1.406.118R						
ENGINE														
2.0 Turbo	Petrol	114	08/90-07/95	B 200 FT										
Engine	Information				A10	A20	A40	A50	A70	C10 - C30	C20	E01		
All engines	version Bosch						1.306.127	1.406.118R						
All engines													1.500.372	
ENGINE														
2.3	Petrol	114	08/90-07/91	B 234 F, B 234 G										
Engine	Information				A10	A20	A40	A50	A70	C10 - C30	C20	E01		
All engines	version Bosch						1.306.127	1.406.118R						
ENGINE														
2.3	Petrol	84	08/91-07/94	B 230 F										
Engine	Information				A10	A20	A40	A50	A70	C10 - C30	C20	E01		
All engines	version Bosch						1.306.127	1.406.118R						
All engines													1.500.372	
ENGINE														
2.3	Petrol	85	08/92-07/94	B 230 FD										
Engine	Information				A10	A20	A40	A50	A70	C10 - C30	C20	E01		
All engines	version Bosch						1.306.127	1.406.118R						
All engines													1.500.372	
ENGINE														
2.3	Petrol	90	08/90-12/94	B 230 E										
Engine	Information				A10	A20	A40	A50	A70	C10 - C30	C20	E01		
All engines	version Bosch						1.306.127	1.406.118R	1.906.222					
All engines													1.500.372	

A10	CONDENSER	A20	CONTACT SET	A40	DISTRIBUTOR CAP	A50	ROTOR	A70	PICK-UP
C10	COIL	C20	IGNITION MODULE	C30	ELECTRONIC IGNITION KIT	E01	IGNITION CABLE SET		









The present application list is a brief version. For the detailed information about the possibility of installation on a specific vehicle, please refer to our web-catalogue <http://catalogo.facet.eu/>

				FUNCTIONS ON THE VEHICLE								
Vehicle	alim.	kW	Date	Engine	 A10	 A20	 A40	 A50	 A70	 C10 - C30	 C20	 E01
				ENGINE								
2.3	Petrol	96	08/90-07/95	B 230 E, B 230 FB, B 230 G								
Engine	Information			A10	A20	A40	A50	A70	C10 - C30	C20	E01	
All engines	version Bosch					1.306.127	1.406.118R					
Eng. B 230 E	version Bosch							1.906.222				
All engines												1.500.372
				ENGINE								
2.3 16V	Petrol	114	08/90-07/92	B 234 G								
Engine	Information			A10	A20	A40	A50	A70	C10 - C30	C20	E01	
All engines	version Bosch					1.306.127	1.406.118R					
				ENGINE								
2.3 Turbo	Petrol	121	08/90-07/94	B 230 FT, B 230 GT								
Engine	Information			A10	A20	A40	A50	A70	C10 - C30	C20	E01	
All engines	version Bosch					1.306.127	1.406.118R					
Eng. B 230 FT												1.500.372
				ENGINE								
940 II												
				ENGINE								
2.0 GLT	Petrol	139	10/94-05/97	B 200 GT								
Engine	Information			A10	A20	A40	A50	A70	C10 - C30	C20	E01	
All engines	version Bosch					1.306.127	1.406.118R					
All engines												1.500.372
				ENGINE								
2.0 Turbo	Petrol	114	04/96-10/98	B 200 FT								
Engine	Information			A10	A20	A40	A50	A70	C10 - C30	C20	E01	
All engines	version Bosch					1.306.127	1.406.118R					
All engines												1.500.372
				ENGINE								
2.3	Petrol	113	10/94-05/97	B 230 GK								
Engine	Information			A10	A20	A40	A50	A70	C10 - C30	C20	E01	
All engines	version Bosch					1.306.127	1.406.118R					
All engines												1.500.372
				ENGINE								
2.3	Petrol	85	08/94-07/95	B 230 FD								
Engine	Information			A10	A20	A40	A50	A70	C10 - C30	C20	E01	
All engines	version Bosch					1.306.127	1.406.118R					
All engines												1.500.372
				ENGINE								
2.3 ti	Petrol	99	01/95-10/98	B 230 FK								
Engine	Information			A10	A20	A40	A50	A70	C10 - C30	C20	E01	
All engines	version Bosch					1.306.127	1.406.118R					
All engines												1.500.372
				ENGINE								
2.3 Turbo	Petrol	104	01/95-10/98	B 230 GK								
Engine	Information			A10	A20	A40	A50	A70	C10 - C30	C20	E01	
All engines	version Bosch					1.306.127	1.406.118R					
All engines												1.500.372
				ENGINE								
2.3 Turbo	Petrol	121	08/94-10/98	B 230 FT								
Engine	Information			A10	A20	A40	A50	A70	C10 - C30	C20	E01	
All engines	version Bosch					1.306.127	1.406.118R					
All engines												1.500.372
				ENGINE								
2.3 Turbo	Petrol	126	01/95-12/98	B 230 FT								
Engine	Information			A10	A20	A40	A50	A70	C10 - C30	C20	E01	
All engines	version Bosch					1.306.127	1.406.118R					
All engines												1.500.372
				ENGINE								
960 I												
				ENGINE								
2.0	Petrol	140	08/90-09/93	B 204 FT								
Engine	Information			A10	A20	A40	A50	A70	C10 - C30	C20	E01	
All engines	version Bosch					1.306.127	1.406.118R					
				FUNCTIONS ON THE VEHICLE								
A10	CONDENSER	A20	CONTACT SET	A40	DISTRIBUTOR CAP	A50	ROTOR	A70	PICK-UP			
C10	COIL	C20	IGNITION MODULE	C30	ELECTRONIC IGNITION KIT	E01	IGNITION CABLE SET					

Vehicle	alim.	kW	Date	Engine	FUNCTIONS ON THE VEHICLE									
					A10	A20	A40	A50	A70	C10 - C30	C20	E01		
ENGINE														
2.3	Petrol	121	08/90-07/94	B 230 GT										
Engine	Information				A10	A20	A40	A50	A70	C10 - C30	C20	E01		
All engines	version Bosch						1.306.127	1.406.118R						
All engines													1.500.372	
ENGINE														
2.3 Turbo	Petrol	121	09/90-08/93	B 230 FT										
Engine	Information				A10	A20	A40	A50	A70	C10 - C30	C20	E01		
All engines	version Bosch						1.306.127	1.406.118R						
All engines													1.500.372	
ENGINE														
2.8 GL	Petrol	108	09/90-05/92	B 280 F										
Engine	Information				A10	A20	A40	A50	A70	C10 - C30	C20	E01		
All engines	version Bosch						1.306.236	1.406.119R						
ENGINE														
2.8 GL	Petrol	115	09/90-05/92	B 280 E										
Engine	Information				A10	A20	A40	A50	A70	C10 - C30	C20	E01		
All engines	version Bosch						1.306.236	1.406.119R						
ENGINE														
C30														
ENGINE														
1.6	Petrol	74	10/06-12/12	B 4164 S3										
Engine	Information				A10	A20	A40	A50	A70	C10 - C30	C20	E01		
All engines	->ch. 242342, ch. 242343 ->, x 1, D.I.S.									1.970.481	C10			
All engines													1.499.242	
ENGINE														
1.8	Petrol	92	10/06-12/12	B 4184 S11										
Engine	Information				A10	A20	A40	A50	A70	C10 - C30	C20	E01		
All engines	x 4, COIL ON PLUG									1.970.480	C10			
ENGINE														
1.8 FlexFuel	Petrol/ Ethanol	92	01/07-12/12	B 4184 S8										
Engine	Information				A10	A20	A40	A50	A70	C10 - C30	C20	E01		
All engines	x 4, COIL ON PLUG									1.970.480	C10			
ENGINE														
2.0	Petrol	107	10/06-12/12	B 4204 S3										
Engine	Information				A10	A20	A40	A50	A70	C10 - C30	C20	E01		
All engines	x 4, COIL ON PLUG									1.970.480	C10			
ENGINE														
2.0 FlexFuel	Petrol/ Ethanol	107	01/10-12/12	B 4204 S4										
Engine	Information				A10	A20	A40	A50	A70	C10 - C30	C20	E01		
All engines	x 4, COIL ON PLUG									1.970.480	C10			
ENGINE														
2.4 i	Petrol	125	10/06-12/12	B 5244 S4										
Engine	Information				A10	A20	A40	A50	A70	C10 - C30	C20	E01		
All engines	x 5, COIL ON PLUG									1.970.478	C10			
ENGINE														
T5	Petrol	162	10/06-12/12	B 5254 T3										
Engine	Information				A10	A20	A40	A50	A70	C10 - C30	C20	E01		
All engines	x 5, COIL ON PLUG									1.970.478	C10			
ENGINE														
T5	Petrol	169	03/07-12/12	B 5254 T7										
Engine	Information				A10	A20	A40	A50	A70	C10 - C30	C20	E01		
All engines	x 5, COIL ON PLUG									1.970.478	C10			
ENGINE														
T5	Petrol	184	10/07-12/13	B 5254 T7										
Engine	Information				A10	A20	A40	A50	A70	C10 - C30	C20	E01		
All engines	x 5, COIL ON PLUG									1.970.478	C10			

A10	CONDENSER	A20	CONTACT SET	A40	DISTRIBUTOR CAP	A50	ROTOR	A70	PICK-UP
C10	COIL	C20	IGNITION MODULE	C30	ELECTRONIC IGNITION KIT	E01	IGNITION CABLE SET		









The present application list is a brief version. For the detailed information about the possibility of installation on a specific vehicle, please refer to our web-catalogue <http://catalogo.facet.eu/>

				FUNCTIONS ON THE VEHICLE								
Vehicle	alim.	kW	Date	Engine								
				A10	A20	A40	A50	A70	C10 - C30	C20	E01	
C70 I												
2.0	Petrol	132	03/97-10/05	B 5204 T2								
Engine	Information			A10	A20	A40	A50	A70	C10 - C30	C20	E01	
All engines	version Bosch					1.306.260	1.406.147R					
All engines									1.990.423	C30	1.499.064	
2.0T	Petrol	120	03/00-10/05	B 5204 T4								
Engine	Information			A10	A20	A40	A50	A70	C10 - C30	C20	E01	
All engines	x 5, COIL ON PLUG, incl. spark plug connector								1.970.448	C10		
2.0T	Petrol	166	03/97-10/05	B 5204 T3								
Engine	Information			A10	A20	A40	A50	A70	C10 - C30	C20	E01	
All engines	MODEL TO: 1998, version Bosch					1.306.260	1.406.147R					
All engines	x 5, COIL ON PLUG, incl. spark plug connector								1.970.448	C10		
All engines	MODEL TO: 1998										1.499.064	
2.3 T5	Petrol	176	03/98-10/05	B 5234 T3								
Engine	Information			A10	A20	A40	A50	A70	C10 - C30	C20	E01	
All engines	MODEL TO: 1998, version Bosch					1.306.260	1.406.147R					
All engines	x 5, COIL ON PLUG, incl. spark plug connector								1.970.448	C10		
All engines	MODEL TO: 1998										1.499.064	
2.3 T5	Petrol	180	07/02-10/05	B 5234 T9								
Engine	Information			A10	A20	A40	A50	A70	C10 - C30	C20	E01	
All engines	x 5, COIL ON PLUG, incl. spark plug connector								1.970.448	C10		
2.3 T-5	Petrol	176	03/97-09/02	B 5234 T3								
Engine	Information			A10	A20	A40	A50	A70	C10 - C30	C20	E01	
All engines	MODEL TO: 1998, version Bosch					1.306.260	1.406.147R					
All engines	x 5, COIL ON PLUG, incl. spark plug connector								1.970.448	C10		
All engines	MODEL TO: 1998										1.499.064	
2.4	Petrol	103	03/99-07/00	B 5244 S								
Engine	Information			A10	A20	A40	A50	A70	C10 - C30	C20	E01	
All engines	Qty: 5								1.970.448	C10		
2.4	Petrol	121	03/99-09/02	B 5254 S, B5254SDENS								
Engine	Information			A10	A20	A40	A50	A70	C10 - C30	C20	E01	
Eng. B 5254 S	Qty: 5								1.970.448	C10		
Eng. B5254SDENS	x 5, COIL ON PLUG, incl. spark plug connector								1.970.448	C10		
2.4	Petrol	125	06/98-10/05	B 5244 S, B 5254 S								
Engine	Information			A10	A20	A40	A50	A70	C10 - C30	C20	E01	
Eng. B 5244 S	x 5, COIL ON PLUG, incl. spark plug connector								1.970.448	C10		
Eng. B 5254 S	Qty: 5								1.970.448	C10		
2.4T	Petrol	142	03/97-10/05	B 5244 T, B 5254 T								
Engine	Information			A10	A20	A40	A50	A70	C10 - C30	C20	E01	
Eng. B 5254 T	MODEL TO: 1998, version Bosch					1.306.260	1.406.147R					
All engines	x 5, COIL ON PLUG, incl. spark plug connector								1.970.448	C10		
Eng. B 5254 T	MODEL FROM: 1999, Qty: 5								1.970.448	C10		
Eng. B 5254 T	MODEL TO: 1998								1.990.423	C30	1.499.064	
2.4T	Petrol	147	07/02-10/05	B 5244 T7								
Engine	Information			A10	A20	A40	A50	A70	C10 - C30	C20	E01	
All engines	x 5, COIL ON PLUG, incl. spark plug connector								1.970.448	C10		
C70 II												
2.4	Petrol	103	03/06-10/09	B 5244 S5								
Engine	Information			A10	A20	A40	A50	A70	C10 - C30	C20	E01	
All engines	x 5, COIL ON PLUG								1.970.478	C10		
A10	CONDENSER	A20	CONTACT SET	A40	DISTRIBUTOR CAP	A50	ROTOR	A70	PICK-UP			
C10	COIL	C20	IGNITION MODULE	C30	ELECTRONIC IGNITION KIT	E01	IGNITION CABLE SET					

Vehicle	alim.	kW	Date	Engine	FUNCTIONS ON THE VEHICLE									
					A10	A20	A40	A50	A70	C10 - C30	C20	E01		
ENGINE														
2.4 i	Petrol	125	03/06-10/09	B 5244 S4										
Engine	Information				A10	A20	A40	A50	A70	C10 - C30	C20	E01		
All engines	x 5, COIL ON PLUG									1.970.478	C10			
ENGINE														
T5	Petrol	162	03/06-02/07	B 5254 T3										
Engine	Information				A10	A20	A40	A50	A70	C10 - C30	C20	E01		
All engines	x 5, COIL ON PLUG									1.970.478	C10			
ENGINE														
T5	Petrol	169	03/07-06/13	B 5254 T3, B 5254 T7										
Engine	Information				A10	A20	A40	A50	A70	C10 - C30	C20	E01		
All engines	x 5, COIL ON PLUG									1.970.478	C10			
ENGINE														
P 121														
1.6	Petrol	44	05/59-09/66	B 16 A										
Engine	Information				A10	A20	A40	A50	A70	C10 - C30	C20	E01		
All engines	version BOSCH						1.306.076							
ENGINE														
1.8	Petrol	50	05/59-09/66	B 18 A										
Engine	Information				A10	A20	A40	A50	A70	C10 - C30	C20	E01		
All engines						1.206.021								
All engines	version BOSCH						1.306.076							
ENGINE														
1.8	Petrol	55	02/67-05/71	B 18										
Engine	Information				A10	A20	A40	A50	A70	C10 - C30	C20	E01		
All engines						1.206.021								
All engines	version BOSCH						1.306.076							
ENGINE														
2.0	Petrol	60	11/68-05/71	OJX4G20A6L										
Engine	Information				A10	A20	A40	A50	A70	C10 - C30	C20	E01		
All engines	version BOSCH						1.306.076							
ENGINE														
P 122 S AMAZON														
1.6	Petrol	61	05/59-09/66	B 16										
Engine	Information				A10	A20	A40	A50	A70	C10 - C30	C20	E01		
All engines	version BOSCH						1.306.076							
ENGINE														
1.8	Petrol	59	05/59-07/67	B 18										
Engine	Information				A10	A20	A40	A50	A70	C10 - C30	C20	E01		
All engines						1.206.021, 1.206.047								
All engines	version BOSCH						1.306.076							
ENGINE														
1.8	Petrol	63	09/66-05/71	B 18										
Engine	Information				A10	A20	A40	A50	A70	C10 - C30	C20	E01		
All engines						1.206.047								
All engines	version BOSCH						1.306.076							
ENGINE														
1.8	Petrol	66	02/67-05/71	B 18 D										
Engine	Information				A10	A20	A40	A50	A70	C10 - C30	C20	E01		
All engines						1.206.047	1.306.062							
All engines	version BOSCH						1.306.076							
ENGINE														
1.8	Petrol	76	09/66-05/71	B 18										
Engine	Information				A10	A20	A40	A50	A70	C10 - C30	C20	E01		
All engines						1.206.047								
All engines	version BOSCH						1.306.076							
ENGINE														
2.0	Petrol	74	11/68-05/71	B 20 B										
Engine	Information				A10	A20	A40	A50	A70	C10 - C30	C20	E01		
All engines	version BOSCH						1.306.076							

A10	CONDENSER	A20	CONTACT SET	A40	DISTRIBUTOR CAP	A50	ROTOR	A70	PICK-UP
C10	COIL	C20	IGNITION MODULE	C30	ELECTRONIC IGNITION KIT	E01	IGNITION CABLE SET		

The present application list is a brief version. For the detailed information about the possibility of installation on a specific vehicle, please refer to our web-catalogue <http://catalogo.facet.eu/>









				FUNCTIONS ON THE VEHICLE								
Vehicle	alim.	kW	Date	Engine	 A10	 A20	 A40	 A50	 A70	 C10 - C30	 C20	 E01
P 1800												
1.8	Petrol	66	04/62-05/70	B 18 A								
ENGINE												
Engine		Information			A10	A20	A40	A50	A70	C10 - C30	C20	E01
All engines						1.206.047						
1.8	Petrol	76	04/62-05/70	--								
ENGINE												
Engine		Information			A10	A20	A40	A50	A70	C10 - C30	C20	E01
All engines						1.206.047						
1.8S	Petrol	71	04/62-05/70	--								
ENGINE												
Engine		Information			A10	A20	A40	A50	A70	C10 - C30	C20	E01
All engines						1.206.047						
P 210 DUETT												
1.8	Petrol	55	08/61-07/67	B 18 A								
ENGINE												
Engine		Information			A10	A20	A40	A50	A70	C10 - C30	C20	E01
All engines		version BOSCH					1.306.076					
P 2200												
1.8	Petrol	50	09/64-08/67	B 18 A								
ENGINE												
Engine		Information			A10	A20	A40	A50	A70	C10 - C30	C20	E01
All engines						1.206.047						
1.8	Petrol	59	09/64-08/67	B 18 D								
ENGINE												
Engine		Information			A10	A20	A40	A50	A70	C10 - C30	C20	E01
All engines						1.206.047						
1.8	Petrol	63	09/64-08/67	B 18 B								
ENGINE												
Engine		Information			A10	A20	A40	A50	A70	C10 - C30	C20	E01
All engines						1.206.047						
PV 544												
1.6	Petrol	44	08/61-07/66	B 16 A								
ENGINE												
Engine		Information			A10	A20	A40	A50	A70	C10 - C30	C20	E01
All engines		version BOSCH					1.306.076					
1.6	Petrol	61	08/61-07/67	B 16 B								
ENGINE												
Engine		Information			A10	A20	A40	A50	A70	C10 - C30	C20	E01
All engines		version BOSCH					1.306.076					
1.8	Petrol	50	08/61-07/67	B 18 A								
ENGINE												
Engine		Information			A10	A20	A40	A50	A70	C10 - C30	C20	E01
All engines						1.206.021						
All engines		version BOSCH					1.306.076					
1.8	Petrol	59	08/61-07/67	B 18 D								
ENGINE												
Engine		Information			A10	A20	A40	A50	A70	C10 - C30	C20	E01
All engines		version BOSCH					1.306.076					
S40 I												
1.6	Petrol	77	09/95-08/99	B 4164 S								
ENGINE												
Engine		Information			A10	A20	A40	A50	A70	C10 - C30	C20	E01
All engines		Fitting Position:for cylinder 1, Fitting Position:for cylinder 4, x 1, D.I.S., connector type SAE								1.970.355	C10	
All engines		Fitting Position:for cylinder 2, Fitting Position:for cylinder 3, x 1, D.I.S., connector type SAE								1.970.356	C10	
All engines												1.499.061
1.6	Petrol	80	03/99-12/03	B 4164 S2								
ENGINE												
Engine		Information			A10	A20	A40	A50	A70	C10 - C30	C20	E01
All engines												1.499.059

A10 CONDENSER	A20 CONTACT SET	A40 DISTRIBUTOR CAP	A50 ROTOR	A70 PICK-UP
C10 COIL	C20 IGNITION MODULE	C30 ELECTRONIC IGNITION KIT	E01 IGNITION CABLE SET	

Vehicle	alim.	kW	Date	Engine	FUNCTIONS ON THE VEHICLE									
					A10	A20	A40	A50	A70	C10 - C30	C20	E01		
1.8	Petrol	85	07/95-12/03	ENGINE B 4184 S, B 4184 S2, B 4184 S3										
Engine	Information				A10	A20	A40	A50	A70	C10 - C30	C20	E01		
Eng. B 4184 S	Fitting Position:for cylinder 1, Fitting Position:for cylinder 4, x 1, D.I.S., connector type SAE									1.970.355	C10			
Eng. B 4184 S	Fitting Position:for cylinder 2, Fitting Position:for cylinder 3, x 1, D.I.S., connector type SAE									1.970.356	C10			
Eng. B 4184 S2, B 4184 S3													1.499.059	
Eng. B 4184 S													1.499.061	
1.8	Petrol	90	03/99-12/03	ENGINE B 4184 S2, B 4184 S9										
Engine	Information				A10	A20	A40	A50	A70	C10 - C30	C20	E01		
All engines													1.499.059	
1.8 16V	Petrol	90	08/00->	ENGINE B 4184 S10										
Engine	Information				A10	A20	A40	A50	A70	C10 - C30	C20	E01		
All engines													1.499.059	
1.9 T4	Petrol	147	05/97-07/00	ENGINE B 4194 T, B 4194 T2										
Engine	Information				A10	A20	A40	A50	A70	C10 - C30	C20	E01		
All engines													1.499.059	
2.0	Petrol	100	07/95-12/03	ENGINE B 4204 S, B 4204 S2										
Engine	Information				A10	A20	A40	A50	A70	C10 - C30	C20	E01		
All engines	Fitting Position:for cylinder 1, Fitting Position:for cylinder 4, production date -> 1999, x 1, D.I.S., connector type SAE									1.970.355	C10			
All engines	Fitting Position:for cylinder 2, Fitting Position:for cylinder 3, production date -> 1999, x 1, D.I.S., connector type SAE									1.970.356	C10			
Eng. B 4204 S2													1.499.059	
Eng. B 4204 S													1.499.061	
2.0	Petrol	103	07/95-08/99	ENGINE B 4204 S										
Engine	Information				A10	A20	A40	A50	A70	C10 - C30	C20	E01		
All engines	Fitting Position:for cylinder 1, Fitting Position:for cylinder 4, x 1, D.I.S., connector type SAE									1.970.355	C10			
All engines	Fitting Position:for cylinder 2, Fitting Position:for cylinder 3, x 1, D.I.S., connector type SAE									1.970.356	C10			
All engines													1.499.061	
2.0 T	Petrol	118	10/97-12/03	ENGINE B 4204 T										
Engine	Information				A10	A20	A40	A50	A70	C10 - C30	C20	E01		
All engines													1.499.059	
2.0 T	Petrol	120	06/01-12/03	ENGINE B 4204 T3										
Engine	Information				A10	A20	A40	A50	A70	C10 - C30	C20	E01		
All engines													1.499.059	
2.0 T4	Petrol	147	07/00-12/03	ENGINE B 4204 T5										
Engine	Information				A10	A20	A40	A50	A70	C10 - C30	C20	E01		
All engines													1.499.059	
S40 II														
1.6	Petrol	74	01/05-12/12	ENGINE B 4164 S3										
Engine	Information				A10	A20	A40	A50	A70	C10 - C30	C20	E01		
All engines	ch. 106167 ->, x 1, D.I.S.									1.970.481	C10			
All engines	->ch. 106166, x 1, D.I.S.									1.970.532	C10			
All engines													1.499.242	
1.8	Petrol	92	04/04-12/10	ENGINE B 4184 S11										
Engine	Information				A10	A20	A40	A50	A70	C10 - C30	C20	E01		
All engines	x 4, COIL ON PLUG									1.970.480	C10			









A10	CONDENSER	A20	CONTACT SET	A40	DISTRIBUTOR CAP	A50	ROTOR	A70	PICK-UP
C10	COIL	C20	IGNITION MODULE	C30	ELECTRONIC IGNITION KIT	E01	IGNITION CABLE SET		

The present application list is a brief version. For the detailed information about the possibility of installation on a specific vehicle, please refer to our web-catalogue <http://catalogo.facet.eu/>

					FUNCTIONS ON THE VEHICLE							
Vehicle	alim.	kW	Date	Engine								
ENGINE												
1.8 FlexFuel	Petrol/ Ethanol	92	01/06-12/10	B 4184 S8								
Engine	Information				A10	A20	A40	A50	A70	C10 - C30	C20	E01
All engines	x 4, COIL ON PLUG									1.970.480	C10	
ENGINE												
2.0	Petrol	107	10/06-12/12	B 4204 S3								
Engine	Information				A10	A20	A40	A50	A70	C10 - C30	C20	E01
All engines	x 4, COIL ON PLUG									1.970.480	C10	
ENGINE												
2.0 F	Petrol/ Ethanol	107	10/09-12/12	B 4204 S4								
Engine	Information				A10	A20	A40	A50	A70	C10 - C30	C20	E01
All engines	x 4, COIL ON PLUG									1.970.480	C10	
ENGINE												
2.4	Petrol	103	01/04-12/10	B 5244 S5								
Engine	Information				A10	A20	A40	A50	A70	C10 - C30	C20	E01
All engines	->ch. 81811, ch. 81812 ->, x 5, COIL ON PLUG									1.970.478	C10	
ENGINE												
2.4	Petrol	125	01/04-12/12	B 5244 S4								
Engine	Information				A10	A20	A40	A50	A70	C10 - C30	C20	E01
All engines	->ch. 83812, ch. 83813 ->, x 5, COIL ON PLUG									1.970.478	C10	
ENGINE												
T5	Petrol	162	01/04-12/07	B 5254 T3								
Engine	Information				A10	A20	A40	A50	A70	C10 - C30	C20	E01
All engines	x 5, COIL ON PLUG									1.970.478	C10	
ENGINE												
T5	Petrol	169	03/07-12/12	B 5254 T7								
Engine	Information				A10	A20	A40	A50	A70	C10 - C30	C20	E01
All engines	x 5, COIL ON PLUG									1.970.478	C10	
ENGINE												
T5 AWD	Petrol	162	04/04-12/07	B 5254 T3								
Engine	Information				A10	A20	A40	A50	A70	C10 - C30	C20	E01
All engines	x 5, COIL ON PLUG									1.970.478	C10	
ENGINE												
T5 AWD	Petrol	169	03/07-12/10	B 5254 T7								
Engine	Information				A10	A20	A40	A50	A70	C10 - C30	C20	E01
All engines	x 5, COIL ON PLUG									1.970.478	C10	
S60 I												
ENGINE												
2.0T	Petrol	132	07/00-04/10	B 5204 T5								
Engine	Information				A10	A20	A40	A50	A70	C10 - C30	C20	E01
All engines	->year 01/06/04, x 5, COIL ON PLUG, incl. spark plug connector									1.970.448	C10	
All engines	01/07/04 ->, x 5, COIL ON PLUG									1.970.478	C10	
ENGINE												
2.3 T5	Petrol	195	07/00-09/02	B 5234 T7								
Engine	Information				A10	A20	A40	A50	A70	C10 - C30	C20	E01
All engines	Qty: 5									1.970.448	C10	
All engines	x 5, COIL ON PLUG, incl. spark plug connector									1.970.448	C10	
ENGINE												
2.4	Petrol	103	07/00-04/10	B 5244 S2								
Engine	Information				A10	A20	A40	A50	A70	C10 - C30	C20	E01
All engines	x 5, COIL ON PLUG, incl. spark plug connector									1.970.448	C10	
ENGINE												
2.4	Petrol	125	11/00-04/10	B 5244 S								
Engine	Information				A10	A20	A40	A50	A70	C10 - C30	C20	E01
All engines	x 5, COIL ON PLUG, incl. spark plug connector									1.970.448	C10	
ENGINE												
2.4	Petrol	132	01/05-10/06	B 5244 T4								
Engine	Information				A10	A20	A40	A50	A70	C10 - C30	C20	E01
All engines	x 5, COIL ON PLUG, incl. spark plug connector									1.970.448	C10	

A10 CONDENSER	A20 CONTACT SET	A40 DISTRIBUTOR CAP	A50 ROTOR	A70 PICK-UP
C10 COIL	C20 IGNITION MODULE	C30 ELECTRONIC IGNITION KIT	E01 IGNITION CABLE SET	

Vehicle	alim.	kW	Date	Engine	FUNCTIONS ON THE VEHICLE									
					A10	A20	A40	A50	A70	C10 - C30	C20	E01		
ENGINE														
2.4 AWD	Petrol	191	02/04-04/10	B 5244 T5										
ENGINE														
All engines					Qty: 5						1.970.478	C10		
ENGINE														
2.4 Bifuel	Petrol/ Compressed Natural Gas (CNG)	103	07/01-04/10	B 5244 SG, B 5244 SG2										
ENGINE														
All engines					x 5, COIL ON PLUG, incl. spark plug connector						1.970.448	C10		
All engines					x 5, COIL ON PLUG, incl. spark plug connector						1.970.448	C10		
ENGINE														
2.4 T	Petrol	147	07/00-04/10	B 5244 T3										
ENGINE														
All engines					x 5, COIL ON PLUG, incl. spark plug connector						1.970.448	C10		
ENGINE														
2.4 T AWD	Petrol	147	06/01-04/10	B 5244 T3										
ENGINE														
All engines					x 5, COIL ON PLUG, incl. spark plug connector						1.970.448	C10		
ENGINE														
2.4 T5	Petrol	191	04/04-04/10	B 5244 T5										
ENGINE														
All engines					x 5, COIL ON PLUG, incl. spark plug connector						1.970.448	C10		
ENGINE														
2.5 AWD	Petrol	224	09/03-04/10	B 5254 T4										
ENGINE														
All engines					Qty: 5						1.970.478	C10		
ENGINE														
2.5 T	Petrol	154	01/03-04/10	B 5254 T2										
ENGINE														
All engines					x 5, COIL ON PLUG, incl. spark plug connector						1.970.448	C10		
ENGINE														
2.5 T AWD	Petrol	154	07/02-04/10	B 5254 T2										
ENGINE														
All engines					x 5, COIL ON PLUG, incl. spark plug connector						1.970.448	C10		
ENGINE														
R 2,5 T AWD	Petrol	221	01/03-04/10	B 5254 T4										
ENGINE														
All engines					x 5, COIL ON PLUG, incl. spark plug connector						1.970.448	C10		
ENGINE														
T5	Petrol	184	07/00-04/10	B 5234 T3										
ENGINE														
All engines					x 5, COIL ON PLUG, incl. spark plug connector						1.970.448	C10		
ENGINE														
S60 II														
ENGINE														
2.0 T	Petrol	132	05/12-12/15	B 5204 T8										
ENGINE														
All engines					x 5, COIL ON PLUG						1.970.478	C10		
ENGINE														
2.5 T	Petrol	183	01/13->	B 5254 T14										
ENGINE														
All engines					Qty: 5						1.970.478	C10		
ENGINE														
2.5 T5	Petrol	186	09/11-12/15	B 5254 T5										
ENGINE														
All engines					x 5, COIL ON PLUG						1.970.478	C10		
ENGINE														
2.5 T5 AWD	Petrol	183	03/15-12/18	B 5254 T14										
ENGINE														
All engines					x 5, COIL ON PLUG						1.970.478	C10		
A10	CONDENSER		A20	CONTACT SET		A40	DISTRIBUTOR CAP		A50	ROTOR		A70	PICK-UP	
C10	COIL		C20	IGNITION MODULE		C30	ELECTRONIC IGNITION KIT		E01	IGNITION CABLE SET				

				FUNCTIONS ON THE VEHICLE								
Vehicle	alim.	kW	Date	Engine								
				ENGINE								
2.5 T5 AWD	Petrol	186	09/12-12/15	B 5254 T5								
Engine				Information								
All engines				Qty: 5						1.970.478	C10	
				ENGINE								
T	Petrol	157	04/14->	B 5204 T9								
Engine				Information								
All engines				Qty: 5						1.970.478	C10	
				ENGINE								
T5 AWD	Petrol	187	08/15-12/18	B 5254 T12								
Engine				Information								
All engines				x 5, COIL ON PLUG						1.970.478	C10	
				ENGINE								
S70				ENGINE								
2.0	Petrol	105	01/97-11/00	B 5204 T2								
Engine				Information								
All engines										1.990.423	C30	
				ENGINE								
2.0	Petrol	120	01/97-11/00	B 5204 T4								
Engine				Information								
All engines				x 5, COIL ON PLUG, incl. spark plug connector						1.970.448	C10	
				ENGINE								
2.0	Petrol	132	01/97-11/00	B 5204 T2								
Engine				Information								
All engines				version Bosch			1.306.260	1.406.147R				
All engines										1.990.423	C30	1.499.064
				ENGINE								
2.0	Petrol	93	01/97-11/00	B 5202 FS, B 5202 S								
Engine				Information								
All engines				version Bosch			1.306.260	1.406.147R				
Eng. B 5202 FS										1.990.423	C30	
Eng. B 5202 S										1.990.423	C30	
All engines												1.499.064
				ENGINE								
2.0 Turbo	Petrol	155	01/97-11/00	B 5204 T2								
Engine				Information								
All engines										1.990.423	C30	
				ENGINE								
2.0 Turbo	Petrol	166	01/97-11/00	B 5204 T3								
Engine				Information								
All engines				MODEL TO: 1998, version Bosch			1.306.260	1.406.147R				
All engines										1.990.423	C30	
All engines				MODEL TO: 1998								1.499.064
				ENGINE								
2.3	Petrol	120	01/97-07/99	B 5234 F5								
Engine				Information								
All engines				MODEL TO: 1998, version Bosch			1.306.260	1.406.147R				
All engines				MODEL FROM: 1999, Qty: 5						1.970.448	C10	
All engines				MODEL TO: 1998						1.990.423	C30	1.499.064
				ENGINE								
2.3	Petrol	177	11/96-11/00	B 5234 T3								
Engine				Information								
All engines										1.990.423	C30	
				ENGINE								
2.3	Petrol	195	04/99-09/00	B 5234 T7								
Engine				Information								
All engines				MODEL TO: 1998, version Bosch			1.306.260	1.406.147R				
All engines				x 5, COIL ON PLUG, incl. spark plug connector						1.970.448	C10	
All engines				MODEL TO: 1998								1.499.064

A10 CONDENSER	A20 CONTACT SET	A40 DISTRIBUTOR CAP	A50 ROTOR	A70 PICK-UP
C10 COIL	C20 IGNITION MODULE	C30 ELECTRONIC IGNITION KIT	E01 IGNITION CABLE SET	

Vehicle	alim.	kW	Date	Engine	FUNCTIONS ON THE VEHICLE							
					A10	A20	A40	A50	A70	C10 - C30	C20	E01
ENGINE												
2.3 AWD	Petrol	195	04/99-09/00	B 5234 T7								
Engine	Information			A10	A20	A40	A50	A70	C10 - C30	C20	E01	
All engines	MODEL TO: 1998, version Bosch					1.306.260	1.406.147R					
All engines	MODEL FROM: 1999, Qty: 5								1.970.448	C10		
All engines	MODEL TO: 1998								1.990.423	C30	1.499.064	
ENGINE												
2.3 T-5	Petrol	176	01/97-11/00	B 5234 T3								
Engine	Information			A10	A20	A40	A50	A70	C10 - C30	C20	E01	
All engines	MODEL TO: 1998, version Bosch					1.306.260	1.406.147R					
All engines									1.990.423	C30		
All engines	MODEL TO: 1998										1.499.064	
ENGINE												
2.3 T5 AWD	Petrol	177	11/96-09/98	B 5234 T3								
Engine	Information			A10	A20	A40	A50	A70	C10 - C30	C20	E01	
All engines									1.990.423	C30		
ENGINE												
2.3 T5 AWD	Petrol	184	07/97-09/00	B 5234 T4								
Engine	Information			A10	A20	A40	A50	A70	C10 - C30	C20	E01	
All engines	version Bosch					1.306.260	1.406.147R					
All engines									1.990.423	C30	1.499.064	
ENGINE												
2.3 T5-R AWD	Petrol	176	11/96-09/98	B 5234 T2								
Engine	Information			A10	A20	A40	A50	A70	C10 - C30	C20	E01	
All engines	version Bosch					1.306.260	1.406.147R					
All engines									1.990.423	C30	1.499.064	
ENGINE												
2.3 Turbo	Petrol	184	01/97-11/00	B 5234 FT+, B 5234 T4								
Engine	Information			A10	A20	A40	A50	A70	C10 - C30	C20	E01	
Eng. B 5234 FT+	version Bosch					1.306.260	1.406.147R					
Eng. B 5234 FT+									1.990.423	C30	1.499.064	
Eng. B 5234 T4									1.990.423	C30		
ENGINE												
2.4	Petrol	103	08/99-11/00	B 5244 S2, B 5244 SG								
Engine	Information			A10	A20	A40	A50	A70	C10 - C30	C20	E01	
Eng. B 5244 S2	x 5, COIL ON PLUG, incl. spark plug connector								1.970.448	C10		
Eng. B 5244 SG	Qty: 5								1.970.448	C10		
ENGINE												
2.4	Petrol	106	01/97-11/00	B 5252 FS								
Engine	Information			A10	A20	A40	A50	A70	C10 - C30	C20	E01	
All engines									1.990.423	C30		
ENGINE												
2.4	Petrol	121	06/98-11/00	B 5254 S, B5254SDENS								
Engine	Information			A10	A20	A40	A50	A70	C10 - C30	C20	E01	
Eng. B 5254 S	MODEL TO: 1998, version Bosch					1.306.260	1.406.147R					
Eng. B 5254 S	MODEL FROM: 1999, Qty: 5								1.970.448	C10		
Eng. B5254SDENS	x 5, COIL ON PLUG, incl. spark plug connector								1.970.448	C10		
Eng. B 5254 S	MODEL TO: 1998								1.990.423	C30	1.499.064	
ENGINE												
2.4	Petrol	125	01/97-11/00	B 5244 S, B 5254 FS								
Engine	Information			A10	A20	A40	A50	A70	C10 - C30	C20	E01	
Eng. B 5244 S	x 5, COIL ON PLUG, incl. spark plug connector								1.970.448	C10		
Eng. B 5254 FS									1.990.423	C30		
ENGINE												
2.4 AWD	Petrol	103	04/99-09/00	B 5244 S2								
Engine	Information			A10	A20	A40	A50	A70	C10 - C30	C20	E01	
All engines	x 5, COIL ON PLUG, incl. spark plug connector								1.970.448	C10		
ENGINE												
2.4 AWD	Petrol	106	11/96-05/99	B 5252 FS								
Engine	Information			A10	A20	A40	A50	A70	C10 - C30	C20	E01	
All engines	version Bosch					1.306.260	1.406.147R					

A10	CONDENSER	A20	CONTACT SET	A40	DISTRIBUTOR CAP	A50	ROTOR	A70	PICK-UP
C10	COIL	C20	IGNITION MODULE	C30	ELECTRONIC IGNITION KIT	E01	IGNITION CABLE SET		

The present application list is a brief version. For the detailed information about the possibility of installation on a specific vehicle, please refer to our web-catalogue <http://catalogo.facet.eu/>

Vehicle	alim.	kW	Date	Engine	FUNCTIONS ON THE VEHICLE											
					A10	A20	A40	A50	A70	C10 - C30	C20	E01				
ENGINE																
T4	Petrol	132	01/12->	B 5204 T8												
Engine					A10	A20	A40	A50	A70	C10 - C30	C20	E01				
All engines										1.970.478	C10					
S80 I																
ENGINE																
2.0	Petrol	120	06/98-07/06	B 5204 T4												
Engine					A10	A20	A40	A50	A70	C10 - C30	C20	E01				
All engines										1.970.448	C10					
ENGINE																
2.0 T	Petrol	132	12/99-07/06	B 5204 T5												
Engine					A10	A20	A40	A50	A70	C10 - C30	C20	E01				
All engines										1.970.448	C10					
All engines										1.970.478	C10					
ENGINE																
2.0 T	Petrol	166	06/98-07/06	B 5204 T3												
Engine					A10	A20	A40	A50	A70	C10 - C30	C20	E01				
All engines										1.970.448	C10					
ENGINE																
2.3 R	Petrol	195	04/00-08/05	B 5234 T7												
Engine					A10	A20	A40	A50	A70	C10 - C30	C20	E01				
All engines										1.970.448	C10					
All engines										1.970.448	C10					
ENGINE																
2.4	Petrol	103	01/99-07/06	B 5244 S2												
Engine					A10	A20	A40	A50	A70	C10 - C30	C20	E01				
All engines										1.970.448	C10					
ENGINE																
2.4	Petrol	125	01/99-07/06	B 5244 S												
Engine					A10	A20	A40	A50	A70	C10 - C30	C20	E01				
All engines										1.970.448	C10					
ENGINE																
2.4 Bifuel	Petrol/ Com- pressed Natural Gas (CNG)	103	09/01-07/06	B 5244 SG, B 5244 SG2												
Engine					A10	A20	A40	A50	A70	C10 - C30	C20	E01				
Eng. B 5244 SG										1.970.448	C10					
Eng. B 5244 SG2										1.970.448	C10					
Eng. B 5244 SG										1.970.448	C10					
Eng. B 5244 SG2										1.970.448	C10					
ENGINE																
2.4 LTP	Petrol	132	06/04-07/06	B 5244 T4												
Engine					A10	A20	A40	A50	A70	C10 - C30	C20	E01				
All engines										1.970.478	C10					
ENGINE																
2.4 T	Petrol	147	06/00-07/06	B 5244 T3												
Engine					A10	A20	A40	A50	A70	C10 - C30	C20	E01				
All engines										1.970.448	C10					
ENGINE																
2.4 T5 AWD	Petrol	147	04/00-09/03	B 5244 T3												
Engine					A10	A20	A40	A50	A70	C10 - C30	C20	E01				
All engines										1.970.448	C10					
ENGINE																
2.5 T	Petrol	154	03/03-07/06	B 5254 T2												
Engine					A10	A20	A40	A50	A70	C10 - C30	C20	E01				
All engines										1.970.448	C10					
ENGINE																
2.5 T AWD	Petrol	154	07/03-07/06	B 5254 T2												
Engine					A10	A20	A40	A50	A70	C10 - C30	C20	E01				
All engines										1.970.448	C10					
A10	CONDENSER			A20	CONTACT SET			A40	DISTRIBUTOR CAP		A50	ROTOR		A70	PICK-UP	
C10	COIL			C20	IGNITION MODULE			C30	ELECTRONIC IGNITION KIT		E01	IGNITION CABLE SET				









Vehicle	alim.	kW	Date	Engine	FUNCTIONS ON THE VEHICLE									
					A10	A20	A40	A50	A70	C10 - C30	C20	E01		
ENGINE														
2.8 T6	Petrol	200	05/98-12/01	B 6284 T										
Engine	Information				A10	A20	A40	A50	A70	C10 - C30	C20	E01		
All engines	x 6, COIL ON PLUG, incl. spark plug connector									1.970.448	C10			
ENGINE														
2.9	Petrol	144	05/98-02/08	B 6294 S2										
Engine	Information				A10	A20	A40	A50	A70	C10 - C30	C20	E01		
All engines	x 6, COIL ON PLUG, incl. spark plug connector									1.970.448	C10			
ENGINE														
2.9	Petrol	147	03/99-07/06	B 6294 S										
Engine	Information				A10	A20	A40	A50	A70	C10 - C30	C20	E01		
All engines	x 6, COIL ON PLUG, incl. spark plug connector									1.970.448	C10			
ENGINE														
2.9	Petrol	150	05/98-07/06	B 6304 S3										
Engine	Information				A10	A20	A40	A50	A70	C10 - C30	C20	E01		
All engines	x 6, COIL ON PLUG, incl. spark plug connector									1.970.448	C10			
ENGINE														
2.9 T6	Petrol	200	06/01-07/06	B 6294 T										
Engine	Information				A10	A20	A40	A50	A70	C10 - C30	C20	E01		
All engines	x 6, COIL ON PLUG, incl. spark plug connector									1.970.448	C10			
ENGINE														
3.0	Petrol	144	06/01-07/06	B 6294 S2										
Engine	Information				A10	A20	A40	A50	A70	C10 - C30	C20	E01		
All engines	x 6, COIL ON PLUG, incl. spark plug connector									1.970.448	C10			
ENGINE														
3.0 T6	Petrol	200	06/01-07/06	B 6294 T										
Engine	Information				A10	A20	A40	A50	A70	C10 - C30	C20	E01		
All engines	x 6, COIL ON PLUG, incl. spark plug connector									1.970.448	C10			
S80 II														
ENGINE														
2.0	Petrol	107	01/08-09/12	B 4204 S3										
Engine	Information				A10	A20	A40	A50	A70	C10 - C30	C20	E01		
All engines	x 4, COIL ON PLUG									1.970.480	C10			
ENGINE														
2.0 FlexFuel	Petrol/ Ethanol	107	01/08-12/11	B 4204 S4										
Engine	Information				A10	A20	A40	A50	A70	C10 - C30	C20	E01		
All engines	x 4, COIL ON PLUG									1.970.480	C10			
ENGINE														
2.5 T	Petrol	147	03/06-12/11	B 5254 T6										
Engine	Information				A10	A20	A40	A50	A70	C10 - C30	C20	E01		
All engines	x 5, COIL ON PLUG									1.970.478	C10			
ENGINE														
2.5 T	Petrol	170	01/10-12/12	B 5254 T10										
Engine	Information				A10	A20	A40	A50	A70	C10 - C30	C20	E01		
All engines	x 5, COIL ON PLUG									1.970.478	C10			
ENGINE														
2.5 T	Petrol	183	09/12-12/16	B 5254 T14										
Engine	Information				A10	A20	A40	A50	A70	C10 - C30	C20	E01		
All engines	x 5, COIL ON PLUG									1.970.478	C10			
ENGINE														
2.5 T	Petrol	187	01/12-04/16	B 5254 T12										
Engine	Information				A10	A20	A40	A50	A70	C10 - C30	C20	E01		
All engines	x 5, COIL ON PLUG									1.970.478	C10			
ENGINE														
2.5 T AWD	Petrol	147	10/06-04/09	B 5254 T6										
Engine	Information				A10	A20	A40	A50	A70	C10 - C30	C20	E01		
All engines	Qty: 5									1.970.478	C10			

A10 CONDENSER	A20 CONTACT SET	A40 DISTRIBUTOR CAP	A50 ROTOR	A70 PICK-UP
C10 COIL	C20 IGNITION MODULE	C30 ELECTRONIC IGNITION KIT	E01 IGNITION CABLE SET	

Vehicle	alim.	kW	Date	Engine	FUNCTIONS ON THE VEHICLE									
					A10	A20	A40	A50	A70	C10 - C30	C20	E01		
ENGINE														
2.5 T FlexFuel	Petrol/ Ethanol	147	05/08-12/11	B 5254 T8										
Engine	Information				A10	A20	A40	A50	A70	C10 - C30	C20	E01		
All engines	x 5, COIL ON PLUG									1.970.478	C10			
ENGINE														
2.5 T FlexFuel	Petrol/ Ethanol	170	01/10-12/11	B 5254 T11										
Engine	Information				A10	A20	A40	A50	A70	C10 - C30	C20	E01		
All engines	x 5, COIL ON PLUG									1.970.478	C10			
V40 I														
ENGINE														
1.6	Petrol	77	12/95-08/99	B 4164 S										
Engine	Information				A10	A20	A40	A50	A70	C10 - C30	C20	E01		
All engines	Fitting Position:for cylinder 1, Fitting Position:for cylinder 4, x 1, D.I.S., connector type SAE									1.970.355	C10			
All engines	Fitting Position:for cylinder 2, Fitting Position:for cylinder 3, x 1, D.I.S., connector type SAE									1.970.356	C10			
All engines													1.499.061	
ENGINE														
1.6	Petrol	80	03/99-06/04	B 4164 S2										
Engine	Information				A10	A20	A40	A50	A70	C10 - C30	C20	E01		
All engines													1.499.059	
ENGINE														
1.8	Petrol	85	07/95-08/99	B 4184 S, B 4184 S3										
Engine	Information				A10	A20	A40	A50	A70	C10 - C30	C20	E01		
Eng. B 4184 S	Fitting Position:for cylinder 1, Fitting Position:for cylinder 4, x 1, D.I.S., connector type SAE									1.970.355	C10			
Eng. B 4184 S	Fitting Position:for cylinder 2, Fitting Position:for cylinder 3, x 1, D.I.S., connector type SAE									1.970.356	C10			
All engines													1.499.061	
ENGINE														
1.8	Petrol	90	03/99-06/04	B 4184 S2, B 4184 S3, B 4184 S9										
Engine	Information				A10	A20	A40	A50	A70	C10 - C30	C20	E01		
All engines													1.499.059	
ENGINE														
1.8 16V	Petrol	90	08/00->	B 4184 S10										
Engine	Information				A10	A20	A40	A50	A70	C10 - C30	C20	E01		
All engines													1.499.059	
ENGINE														
1.9 T4	Petrol	147	05/97-07/00	B 4194 T										
Engine	Information				A10	A20	A40	A50	A70	C10 - C30	C20	E01		
All engines													1.499.059	
ENGINE														
2.0	Petrol	100	07/95-06/04	B 4204 S, B 4204 S2										
Engine	Information				A10	A20	A40	A50	A70	C10 - C30	C20	E01		
Eng. B 4204 S	Fitting Position:for cylinder 1, Fitting Position:for cylinder 4, production date -> 1999, x 1, D.I.S., connector type SAE									1.970.355	C10			
Eng. B 4204 S	Fitting Position:for cylinder 2, Fitting Position:for cylinder 3, production date -> 1999, x 1, D.I.S., connector type SAE									1.970.356	C10			
Eng. B 4204 S2													1.499.059	
Eng. B 4204 S													1.499.061	
ENGINE														
2.0	Petrol	103	07/95-08/99	B 4204 S										
Engine	Information				A10	A20	A40	A50	A70	C10 - C30	C20	E01		
All engines	Fitting Position:for cylinder 1, Fitting Position:for cylinder 4, x 1, D.I.S., connector type SAE									1.970.355	C10			
All engines	Fitting Position:for cylinder 2, Fitting Position:for cylinder 3, x 1, D.I.S., connector type SAE									1.970.356	C10			
All engines													1.499.061	
ENGINE														
2.0 T	Petrol	118	10/97-07/00	B 4204 T										
Engine	Information				A10	A20	A40	A50	A70	C10 - C30	C20	E01		
All engines													1.499.059	

A10 CONDENSER	A20 CONTACT SET	A40 DISTRIBUTOR CAP	A50 ROTOR	A70 PICK-UP
C10 COIL	C20 IGNITION MODULE	C30 ELECTRONIC IGNITION KIT	E01 IGNITION CABLE SET	

The present application list is a brief version. For the detailed information about the possibility of installation on a specific vehicle, please refer to our web-catalogue <http://catalogo.facet.eu/>









				FUNCTIONS ON THE VEHICLE								
Vehicle	alim.	kW	Date	Engine								
				ENGINE								
2.0 T	Petrol	120	06/01-06/04	B 4204 T3								
Engine	Information				A10	A20	A40	A50	A70	C10 - C30	C20	E01
All engines												1.499.059
				ENGINE								
2.0 T	Petrol	121	07/99-06/04	B 4204 T2								
Engine	Information				A10	A20	A40	A50	A70	C10 - C30	C20	E01
All engines												1.499.059
				ENGINE								
2.0 T4	Petrol	147	07/00-06/04	B 4204 T5								
Engine	Information				A10	A20	A40	A50	A70	C10 - C30	C20	E01
All engines												1.499.059
				ENGINE								
V40 II				ENGINE								
T4	Petrol	132	07/13-12/15	B 5204 T8								
Engine	Information				A10	A20	A40	A50	A70	C10 - C30	C20	E01
All engines	x 5, COIL ON PLUG									1.970.478	C10	
				ENGINE								
T4 AWD	Petrol	132	07/13->	B 5204 T8								
Engine	Information				A10	A20	A40	A50	A70	C10 - C30	C20	E01
All engines	x 5, COIL ON PLUG									1.970.478	C10	
				ENGINE								
T5	Petrol	157	03/13-12/15	B 5204 T9								
Engine	Information				A10	A20	A40	A50	A70	C10 - C30	C20	E01
All engines	x 5, COIL ON PLUG									1.970.478	C10	
				ENGINE								
T5	Petrol	183	01/14->	B 5254 T14								
Engine	Information				A10	A20	A40	A50	A70	C10 - C30	C20	E01
All engines	x 5, COIL ON PLUG									1.970.478	C10	
				ENGINE								
T5	Petrol	187	12/12->	B 5254 T12								
Engine	Information				A10	A20	A40	A50	A70	C10 - C30	C20	E01
All engines	x 5, COIL ON PLUG									1.970.478	C10	
				ENGINE								
T5 AWD	Petrol	157	03/13->	B 5204 T9								
Engine	Information				A10	A20	A40	A50	A70	C10 - C30	C20	E01
All engines	x 5, COIL ON PLUG									1.970.478	C10	
				ENGINE								
T5 AWD	Petrol	183	01/14->	B 5254 T14								
Engine	Information				A10	A20	A40	A50	A70	C10 - C30	C20	E01
All engines	x 5, COIL ON PLUG									1.970.478	C10	
				ENGINE								
T5 AWD	Petrol	187	01/13->	B 5254 T12								
Engine	Information				A10	A20	A40	A50	A70	C10 - C30	C20	E01
All engines	x 5, COIL ON PLUG									1.970.478	C10	
				ENGINE								
				ENGINE								
V50				ENGINE								
1.6	Petrol	74	01/05-12/12	B 4164 S3								
Engine	Information				A10	A20	A40	A50	A70	C10 - C30	C20	E01
All engines	ch. 105440 ->, x 1, D.I.S.									1.970.481	C10	
All engines	->ch. 105439, x 1, D.I.S.									1.970.532	C10	
All engines												1.499.242
				ENGINE								
1.8	Petrol	92	04/04-12/10	B 4184 S11								
Engine	Information				A10	A20	A40	A50	A70	C10 - C30	C20	E01
All engines	x 4, COIL ON PLUG									1.970.480	C10	

A10 CONDENSER	A20 CONTACT SET	A40 DISTRIBUTOR CAP	A50 ROTOR	A70 PICK-UP
C10 COIL	C20 IGNITION MODULE	C30 ELECTRONIC IGNITION KIT	E01 IGNITION CABLE SET	

Vehicle	alim.	kW	Date	Engine	FUNCTIONS ON THE VEHICLE									
					A10	A20	A40	A50	A70	C10 - C30	C20	E01		
ENGINE														
1.8 BiFuel	Petrol/ Liquified Petroleum Gas (LPG)	93	01/09-09/10	B 4184 S8										
Engine	Information				A10	A20	A40	A50	A70	C10 - C30	C20	E01		
All engines	x 4, COIL ON PLUG									1.970.480	C10			
ENGINE														
1.8 FlexFuel	Petrol/ Ethanol	92	01/05-12/10	B 4184 S8										
Engine	Information				A10	A20	A40	A50	A70	C10 - C30	C20	E01		
All engines	x 4, COIL ON PLUG									1.970.480	C10			
ENGINE														
2.0	Petrol	107	10/06-12/12	B 4204 S3										
Engine	Information				A10	A20	A40	A50	A70	C10 - C30	C20	E01		
All engines	x 4, COIL ON PLUG									1.970.480	C10			
ENGINE														
2.0 FlexFuel	Petrol/ Ethanol	107	01/10-12/12	B 4204 S4										
Engine	Information				A10	A20	A40	A50	A70	C10 - C30	C20	E01		
All engines	x 4, COIL ON PLUG									1.970.480	C10			
ENGINE														
2.4	Petrol	103	04/04-12/10	B 5244 S5										
Engine	Information				A10	A20	A40	A50	A70	C10 - C30	C20	E01		
All engines	->ch. 81811, ch. 81812 ->, x 5, COIL ON PLUG									1.970.478	C10			
ENGINE														
2.4	Petrol	125	04/04-12/10	B 5244 S4										
Engine	Information				A10	A20	A40	A50	A70	C10 - C30	C20	E01		
All engines	->ch. 81811, ch. 81812 ->, x 5, COIL ON PLUG									1.970.478	C10			
ENGINE														
2.4 AWD	Petrol	125	08/06-12/09	B 5244 S4										
Engine	Information				A10	A20	A40	A50	A70	C10 - C30	C20	E01		
All engines	Qty: 5									1.970.478	C10			
ENGINE														
T5	Petrol	162	04/04-12/07	B 5254 T3										
Engine	Information				A10	A20	A40	A50	A70	C10 - C30	C20	E01		
All engines	x 5, COIL ON PLUG									1.970.478	C10			
ENGINE														
T5	Petrol	169	03/07-12/12	B 5254 T7										
Engine	Information				A10	A20	A40	A50	A70	C10 - C30	C20	E01		
All engines	x 5, COIL ON PLUG									1.970.478	C10			
ENGINE														
T5 AWD	Petrol	162	04/04-12/07	B 5254 T3										
Engine	Information				A10	A20	A40	A50	A70	C10 - C30	C20	E01		
All engines	x 5, COIL ON PLUG									1.970.478	C10			
ENGINE														
T5 AWD	Petrol	169	03/07-12/10	B 5254 T7										
Engine	Information				A10	A20	A40	A50	A70	C10 - C30	C20	E01		
All engines	x 5, COIL ON PLUG									1.970.478	C10			
V60 I														
ENGINE														
2.0 BiFuel	Petrol/ Liquified Petroleum Gas (LPG)	157	03/14-12/15	B 5204 T9										
Engine	Information				A10	A20	A40	A50	A70	C10 - C30	C20	E01		
All engines	x 5, COIL ON PLUG									1.970.478	C10			
ENGINE														
2.0 T	Petrol	132	01/14-07/18	B 5204 T8										
Engine	Information				A10	A20	A40	A50	A70	C10 - C30	C20	E01		
All engines	x 5, COIL ON PLUG									1.970.478	C10			

A10 CONDENSER	A20 CONTACT SET	A40 DISTRIBUTOR CAP	A50 ROTOR	A70 PICK-UP
C10 COIL	C20 IGNITION MODULE	C30 ELECTRONIC IGNITION KIT	E01 IGNITION CABLE SET	

The present application list is a brief version. For the detailed information about the possibility of installation on a specific vehicle, please refer to our web-catalogue <http://catalogo.facet.eu/>









				FUNCTIONS ON THE VEHICLE								
Vehicle	alim.	kW	Date	Engine								
				ENGINE								
T5	Petrol	157	10/13-05/18	B 5204 T9								
Engine	Information				A10	A20	A40	A50	A70	C10 - C30	C20	E01
All engines	x 5, COIL ON PLUG									1.970.478	C10	
				ENGINE								
T5 AWD	Petrol	183	03/15-05/18	B 5254 T14								
Engine	Information				A10	A20	A40	A50	A70	C10 - C30	C20	E01
All engines	x 5, COIL ON PLUG									1.970.478	C10	
				ENGINE								
T5 AWD	Petrol	187	04/15-05/18	B 5254 T12								
Engine	Information				A10	A20	A40	A50	A70	C10 - C30	C20	E01
All engines	x 5, COIL ON PLUG									1.970.478	C10	
				ENGINE								
V70				ENGINE								
2.4 LPG	LPG	103	07/97-03/00	B 5244 SG2								
Engine	Information				A10	A20	A40	A50	A70	C10 - C30	C20	E01
All engines	x 5, COIL ON PLUG, incl. spark plug connector									1.970.448	C10	
				ENGINE								
V70 I				ENGINE								
2.0	Petrol	105	12/95-03/00	B 5204 T2								
Engine	Information				A10	A20	A40	A50	A70	C10 - C30	C20	E01
All engines										1.990.423	C30	
				ENGINE								
2.0	Petrol	120	01/97-12/00	B 5204 T4								
Engine	Information				A10	A20	A40	A50	A70	C10 - C30	C20	E01
All engines	x 5, COIL ON PLUG, incl. spark plug connector									1.970.448	C10	
				ENGINE								
2.0	Petrol	132	11/96-03/00	B 5204 T2								
Engine	Information				A10	A20	A40	A50	A70	C10 - C30	C20	E01
All engines	version Bosch						1.306.260	1.406.147R				
All engines										1.990.423	C30	1.499.064
				ENGINE								
2.0	Petrol	93	12/95-03/00	B 5202 FS, B 5202 S								
Engine	Information				A10	A20	A40	A50	A70	C10 - C30	C20	E01
Eng. B 5202 S	version Bosch						1.306.260	1.406.147R				
Eng. B 5202 S										1.990.423	C30	1.499.064
Eng. B 5202 FS										1.990.423	C30	
				ENGINE								
2.0 Turbo	Petrol	155	12/95-03/00	B 5204 T2								
Engine	Information				A10	A20	A40	A50	A70	C10 - C30	C20	E01
All engines										1.990.423	C30	
				ENGINE								
2.0 Turbo	Petrol	166	11/96-12/00	B 5204 T3								
Engine	Information				A10	A20	A40	A50	A70	C10 - C30	C20	E01
All engines	MODEL TO: 1998, version Bosch						1.306.260	1.406.147R				
All engines										1.990.423	C30	
All engines	MODEL TO: 1998											1.499.064
				ENGINE								
2.0 Turbo AWD	Petrol	166	11/96-12/00	B 5204 T3								
Engine	Information				A10	A20	A40	A50	A70	C10 - C30	C20	E01
All engines	MODEL TO: 1998, version Bosch						1.306.260	1.406.147R				
All engines										1.990.423	C30	
All engines	MODEL TO: 1998											1.499.064
				ENGINE								
2.3	Petrol	120	01/97-07/99	B 5234 FS								
Engine	Information				A10	A20	A40	A50	A70	C10 - C30	C20	E01
All engines	MODEL TO: 1998, version Bosch						1.306.260	1.406.147R				
All engines	MODEL FROM: 1999, Qty: 5									1.970.448	C10	
All engines	MODEL TO: 1998									1.990.423	C30	1.499.064

A10 CONDENSER	A20 CONTACT SET	A40 DISTRIBUTOR CAP	A50 ROTOR	A70 PICK-UP
C10 COIL	C20 IGNITION MODULE	C30 ELECTRONIC IGNITION KIT	E01 IGNITION CABLE SET	

Vehicle	alim.	kW	Date	Engine	FUNCTIONS ON THE VEHICLE									
					A10	A20	A40	A50	A70	C10 - C30	C20	E01		
ENGINE														
2.3	Petrol	177	11/96-11/00	B 5234 T3										
ENGINE														
All engines											1.990.423	C30		
ENGINE														
2.3 AWD	Petrol	177	04/97-09/98	B 5234 T3										
ENGINE														
All engines							1.306.260	1.406.147R						
All engines										1.990.423	C30			
All engines														1.499.064
ENGINE														
2.3 AWD	Petrol	195	12/98-02/00	B 5234 T7, B 5234 T8										
ENGINE														
Eng. B 5234 T7							1.306.260	1.406.147R						
Eng. B 5234 T7										1.970.448	C10			
Eng. B 5234 T8										1.970.448	C10			
Eng. B 5234 T7										1.990.423	C30			1.499.064
ENGINE														
2.3 T AWD	Petrol	184	04/97-03/00	B 5234 FT+, B 5234 T4, B 5234 T6										
ENGINE														
All engines							1.306.260	1.406.147R						
Eng. B 5234 FT+, B 5234 T6										1.990.423	C30			
Eng. B 5234 T4, B 5234 T6										1.990.423	C30			
All engines														1.499.064
ENGINE														
2.3 T-5	Petrol	176	11/96-12/00	B 5234 T3										
ENGINE														
All engines							1.306.260	1.406.147R						
All engines										1.990.423	C30			
All engines														1.499.064
ENGINE														
2.3 T-5 AWD	Petrol	176	01/97-12/00	B 5234 T3										
ENGINE														
All engines							1.306.260	1.406.147R						
All engines										1.990.423	C30			
All engines														1.499.064
ENGINE														
2.3 Turbo	Petrol	160	01/97-12/98	B 5234 T2										
ENGINE														
All engines							1.306.260	1.406.147R						
All engines										1.990.423	C30			1.499.064
ENGINE														
2.3 Turbo	Petrol	184	12/95-03/00	B 5234 FT+, B 5234 T4										
ENGINE														
All engines							1.306.260	1.406.147R						
All engines										1.990.423	C30			1.499.064
Eng. B 5234 T4										1.990.423	C30			
ENGINE														
2.4	Petrol	103	03/99-12/00	B 5244 S2, B 5244 SG2										
ENGINE														
Eng. B 5244 S2										1.970.448	C10			
Eng. B 5244 SG2										1.970.448	C10			
ENGINE														
2.4	Petrol	106	12/95-03/00	B 5252 FS										
ENGINE														
All engines							1.306.260	1.406.147R		1.990.423	C30			
ENGINE														
2.4	Petrol	121	06/98-12/99	B 5254 S, B5254SDENS										
ENGINE														
Eng. B 5254 S							1.306.260	1.406.147R						
Eng. B 5254 S										1.970.448	C10			

A10	CONDENSER	A20	CONTACT SET	A40	DISTRIBUTOR CAP	A50	ROTOR	A70	PICK-UP
C10	COIL	C20	IGNITION MODULE	C30	ELECTRONIC IGNITION KIT	E01	IGNITION CABLE SET		

The present application list is a brief version. For the detailed information about the possibility of installation on a specific vehicle, please refer to our web-catalogue <http://catalogo.facet.eu/>

					FUNCTIONS ON THE VEHICLE							
Vehicle	alim.	kW	Date	Engine								
ENGINE												
2.4	Petrol	121	06/98-12/99	B 5254 S, B5254SDENS								
ENGINE												
Engine	Information			A10	A20	A40	A50	A70	C10 - C30		C20	E01
Eng. B5254SDENS	x 5, COIL ON PLUG, incl. spark plug connector								1.970.448	C10		
Eng. B 5254 S	MODEL TO: 1998								1.990.423	C30		1.499.064
ENGINE												
2.4	Petrol	125	12/95-05/00	B 5244 S, B 5254 FS								
ENGINE												
Engine	Information			A10	A20	A40	A50	A70	C10 - C30		C20	E01
Eng. B 5244 S	x 5, COIL ON PLUG, incl. spark plug connector								1.970.448	C10		
Eng. B 5254 FS									1.990.423	C30		
ENGINE												
2.4 AWD	Petrol	121	06/98-12/99	B5254SDENS								
ENGINE												
Engine	Information			A10	A20	A40	A50	A70	C10 - C30		C20	E01
All engines	x 5, COIL ON PLUG, incl. spark plug connector								1.970.448	C10		
ENGINE												
2.4 Bifuel	Natural Gas	103	08/99-03/00	B 5244 SG2								
ENGINE												
Engine	Information			A10	A20	A40	A50	A70	C10 - C30		C20	E01
All engines	Qty: 5								1.970.448	C10		
All engines	x 5, COIL ON PLUG, incl. spark plug connector								1.970.448	C10		
ENGINE												
2.4 Bifuel	Petrol/Compressed Natural Gas (CNG)	106	05/98-12/99	GB 5252 S								
ENGINE												
Engine	Information			A10	A20	A40	A50	A70	C10 - C30		C20	E01
All engines	version Bosch					1.306.260	1.406.147R					
All engines									1.990.423	C30		1.499.064
ENGINE												
2.4 Turbo	Petrol	142	04/96-12/00	B 5244 T, B 5254 T								
ENGINE												
Engine	Information			A10	A20	A40	A50	A70	C10 - C30		C20	E01
Eng. B 5244 T	x 5, COIL ON PLUG, incl. spark plug connector								1.970.448	C10		
Eng. B 5254 T									1.990.423	C30		
ENGINE												
2.4 Turbo AWD	Petrol	142	04/96-12/00	B 5244 T, B 5254 T								
ENGINE												
Engine	Information			A10	A20	A40	A50	A70	C10 - C30		C20	E01
Eng. B 5254 T	MODEL TO: 1998, version Bosch					1.306.260	1.406.147R					
Eng. B 5244 T	x 5, COIL ON PLUG, incl. spark plug connector								1.970.448	C10		
Eng. B 5254 T									1.990.423	C30		
Eng. B 5254 T	MODEL TO: 1998											1.499.064
ENGINE												
2.4 Turbo AWD	Petrol	195	03/99-12/00	B 5244 T2								
ENGINE												
Engine	Information			A10	A20	A40	A50	A70	C10 - C30		C20	E01
All engines	x 5, COIL ON PLUG, incl. spark plug connector								1.970.448	C10		
ENGINE												
2.5	Petrol	106	01/97-03/00	B 5252 FS								
ENGINE												
Engine	Information			A10	A20	A40	A50	A70	C10 - C30		C20	E01
All engines	version Bosch					1.306.260	1.406.147R					
All engines									1.990.423	C30		1.499.064
V70 II												
ENGINE												
2.0 T	Petrol	132	11/99-08/07	B 5204 T5								
ENGINE												
Engine	Information			A10	A20	A40	A50	A70	C10 - C30		C20	E01
All engines	x 5, COIL ON PLUG								1.970.478	C10		
ENGINE												
2.3	Petrol	195	10/00-09/04	B 5234 T7								
ENGINE												
Engine	Information			A10	A20	A40	A50	A70	C10 - C30		C20	E01
All engines	x 5, COIL ON PLUG, incl. spark plug connector								1.970.448	C10		
ENGINE												
2.3 AWD	Petrol	195	10/00-09/04	B 5234 T7								
ENGINE												
Engine	Information			A10	A20	A40	A50	A70	C10 - C30		C20	E01
All engines	Qty: 5								1.970.448	C10		
FUNCTIONS ON THE VEHICLE												
A10	CONDENSER	A20	CONTACT SET	A40	DISTRIBUTOR CAP	A50	ROTOR	A70	PICK-UP			
C10	COIL	C20	IGNITION MODULE	C30	ELECTRONIC IGNITION KIT	E01	IGNITION CABLE SET					

Vehicle	alim.	kW	Date	Engine	FUNCTIONS ON THE VEHICLE									
					A10	A20	A40	A50	A70	C10 - C30	C20	E01		
ENGINE														
2.3 T5	Petrol	184	11/99-12/04	B 5234 T3										
ENGINE														
Engine					A10	A20	A40	A50	A70	C10 - C30	C20	E01		
All engines										1.970.448	C10			
2.4	Petrol	103	03/00-08/07	B 5244 S2										
ENGINE														
Engine					A10	A20	A40	A50	A70	C10 - C30	C20	E01		
All engines										1.970.448	C10			
2.4	Petrol	125	03/00-08/07	B 5244 S										
ENGINE														
Engine					A10	A20	A40	A50	A70	C10 - C30	C20	E01		
All engines										1.970.448	C10			
2.4 Bifuel	Petrol/ Com- pressed Natural Gas (CNG)	103	09/01-08/07	B 5244 SG, B 5244 SG2										
ENGINE														
Engine					A10	A20	A40	A50	A70	C10 - C30	C20	E01		
All engines										1.970.448	C10			
All engines										1.970.448	C10			
2.4 T	Petrol	147	11/99-12/05	B 5244 T3, B 5244 T4										
ENGINE														
Engine					A10	A20	A40	A50	A70	C10 - C30	C20	E01		
Eng. B 5244 T3										1.970.448	C10			
Eng. B 5244 T4										1.970.478	C10			
2.4 T AWD	Petrol	147	09/01-08/02	B 5244 T3										
ENGINE														
Engine					A10	A20	A40	A50	A70	C10 - C30	C20	E01		
All engines										1.970.448	C10			
2.4 T5	Petrol	191	04/04-08/07	B 5244 T5										
ENGINE														
Engine					A10	A20	A40	A50	A70	C10 - C30	C20	E01		
All engines										1.970.478	C10			
2.5 AWD	Petrol	155	09/02-12/04	B 5254 T2										
ENGINE														
Engine					A10	A20	A40	A50	A70	C10 - C30	C20	E01		
All engines										1.970.448	C10			
2.5 R Sport	Petrol	221	12/02-08/07	B 5254 T4										
ENGINE														
Engine					A10	A20	A40	A50	A70	C10 - C30	C20	E01		
All engines										1.970.478	C10			
2.5 T	Petrol	154	07/01-08/07	B 5254 T2										
ENGINE														
Engine					A10	A20	A40	A50	A70	C10 - C30	C20	E01		
All engines										1.970.478	C10			
2.5 T AWD	Petrol	154	07/02-08/07	B 5254 T2										
ENGINE														
Engine					A10	A20	A40	A50	A70	C10 - C30	C20	E01		
All engines										1.970.478	C10			
R2,5 T AWD	Petrol	221	03/03-08/07	B 5254 T4										
ENGINE														
Engine					A10	A20	A40	A50	A70	C10 - C30	C20	E01		
All engines										1.970.478	C10			
V70 III														
2.0	Petrol	107	10/07-12/11	B 4204 S3										
ENGINE														
Engine					A10	A20	A40	A50	A70	C10 - C30	C20	E01		
All engines										1.970.480	C10			

A10 CONDENSER	A20 CONTACT SET	A40 DISTRIBUTOR CAP	A50 ROTOR	A70 PICK-UP
C10 COIL	C20 IGNITION MODULE	C30 ELECTRONIC IGNITION KIT	E01 IGNITION CABLE SET	

The present application list is a brief version. For the detailed information about the possibility of installation on a specific vehicle, please refer to our web-catalogue <http://catalogo.facet.eu/>

					FUNCTIONS ON THE VEHICLE							
Vehicle	alim.	kW	Date	Engine	A10	A20	A40	A50	A70	C10 - C30	C20	E01
ENGINE												
2.0 BiFuel	Petrol/ Liquified Petroleum Gas (LPG)	157	03/13-12/15	B 5204 T9, B5204T9CNG								
Engine	Information				A10	A20	A40	A50	A70	C10 - C30	C20	E01
Eng. B 5204 T9	Qty: 5									1.970.478	C10	
Eng. B5204T9CNG	x 5, COIL ON PLUG									1.970.478	C10	
ENGINE												
2.0 FlexiFuel	Petrol/ Ethanol	107	01/08-12/11	B 4204 S4								
Engine	Information				A10	A20	A40	A50	A70	C10 - C30	C20	E01
All engines	x 4, COIL ON PLUG									1.970.480	C10	
ENGINE												
2.0 GDI	Petrol	157	04/12-12/15	B 5204 T9								
Engine	Information				A10	A20	A40	A50	A70	C10 - C30	C20	E01
All engines	x 5, COIL ON PLUG									1.970.478	C10	
ENGINE												
2.5 T	Petrol	147	08/07-12/09	B 5254 T6								
Engine	Information				A10	A20	A40	A50	A70	C10 - C30	C20	E01
All engines	x 5, COIL ON PLUG									1.970.478	C10	
ENGINE												
2.5 T	Petrol	170	04/09-12/12	B 5254 T10								
Engine	Information				A10	A20	A40	A50	A70	C10 - C30	C20	E01
All engines	x 5, COIL ON PLUG									1.970.478	C10	
ENGINE												
2.5 T FlexiFuel	Petrol/ Ethanol	147	05/08-12/09	B 5254 T8								
Engine	Information				A10	A20	A40	A50	A70	C10 - C30	C20	E01
All engines	x 5, COIL ON PLUG									1.970.478	C10	
ENGINE												
2.5 T FlexiFuel	Petrol/ Ethanol	170	04/09-12/11	B 5254 T11								
Engine	Information				A10	A20	A40	A50	A70	C10 - C30	C20	E01
All engines	x 5, COIL ON PLUG									1.970.478	C10	
XC60 I												
T5 AWD	Petrol	183	04/14-02/17	B 5254 T12								
Engine	Information				A10	A20	A40	A50	A70	C10 - C30	C20	E01
All engines	x 5, COIL ON PLUG									1.970.478	C10	
ENGINE												
T5 AWD	Petrol	187	04/14-02/17	B 5254 T12								
Engine	Information				A10	A20	A40	A50	A70	C10 - C30	C20	E01
All engines	x 5, COIL ON PLUG									1.970.478	C10	
XC70 I												
2.3 T XC AWD	Petrol	195	01/01-07/04	B 5234 T7								
Engine	Information				A10	A20	A40	A50	A70	C10 - C30	C20	E01
All engines	Qty: 5									1.970.448	C10	
ENGINE												
2.4 T XC AWD	Petrol	147	01/05-12/06	B 5244 T4								
Engine	Information				A10	A20	A40	A50	A70	C10 - C30	C20	E01
All engines	Qty: 5									1.970.478	C10	
ENGINE												
2.5 T XC AWD	Petrol	154	09/02-08/07	B 5254 T2								
Engine	Information				A10	A20	A40	A50	A70	C10 - C30	C20	E01
All engines	x 5, COIL ON PLUG, incl. spark plug connector									1.970.448	C10	
XC70 II												
T5 AWD	Petrol	187	08/15-12/16	B 5254 T12								
Engine	Information				A10	A20	A40	A50	A70	C10 - C30	C20	E01
All engines	x 5, COIL ON PLUG									1.970.478	C10	

A10 CONDENSER	A20 CONTACT SET	A40 DISTRIBUTOR CAP	A50 ROTOR	A70 PICK-UP
C10 COIL	C20 IGNITION MODULE	C30 ELECTRONIC IGNITION KIT	E01 IGNITION CABLE SET	

Vehicle	alim.	kW	Date	Engine	FUNCTIONS ON THE VEHICLE							
					A10	A20	A40	A50	A70	C10 - C30	C20	E01

ENGINE				
T6 AWD	Petrol	183	03/15-12/16	B 5254 T14

Engine	Information	A10	A20	A40	A50	A70	C10 - C30	C20	E01
All engines	x 5, COIL ON PLUG						1.970.478	C10	

ENGINE				
--------	--	--	--	--

2.5 T AWD	Petrol	154	10/02-09/14	B 5254 T2, B 5254 T9
------------------	--------	------------	-------------	-----------------------------

Engine	Information	A10	A20	A40	A50	A70	C10 - C30	C20	E01
Eng. B 5254 T2	x 5, COIL ON PLUG, incl. spark plug connector						1.970.448	C10	
Eng. B 5254 T9	Qty: 5						1.970.448	C10	

ENGINE				
T6 AWD	Petrol	200	10/02-12/06	B 6294 T

Engine	Information	A10	A20	A40	A50	A70	C10 - C30	C20	E01
All engines	x 6, COIL ON PLUG, incl. spark plug connector						1.970.448	C10	

A10	CONDENSER	A20	CONTACT SET	A40	DISTRIBUTOR CAP	A50	ROTOR	A70	PICK-UP
C10	COIL	C20	IGNITION MODULE	C30	ELECTRONIC IGNITION KIT	E01	IGNITION CABLE SET		

The present application list is a brief version. For the detailed information about the possibility of installation on a specific vehicle, please refer to our web-catalogue <http://catalogo.facet.eu/>

Vehicle	alim.	kW	Date	Engine	FUNCTIONS ON THE VEHICLE							
					A10	A20	A40	A50	A70	C10 - C30	C20	E01

1500,1600

				ENGINE
1.5	Petrol	33	04/61-07/73	K

Engine	Information	A10	A20	A40	A50	A70	C10 - C30	C20	E01
All engines			1.206.032HV		1.406.014R				

				ENGINE
1.5 L	Petrol	33	07/68-07/73	K

Engine	Information	A10	A20	A40	A50	A70	C10 - C30	C20	E01
All engines			1.206.040						

				ENGINE
1.5 S	Petrol	40	08/63-07/65	--

Engine	Information	A10	A20	A40	A50	A70	C10 - C30	C20	E01
All engines			1.206.032HV		1.406.014R				

				ENGINE
1.6	Petrol	40	08/65-07/73	T, U

Engine	Information	A10	A20	A40	A50	A70	C10 - C30	C20	E01
All engines					1.406.014R				

				ENGINE
1.6 L	Petrol	37	07/64-07/73	P

Engine	Information	A10	A20	A40	A50	A70	C10 - C30	C20	E01
All engines			1.206.040						

				ENGINE
1.6 L	Petrol	40	08/65-07/73	T, U

Engine	Information	A10	A20	A40	A50	A70	C10 - C30	C20	E01
All engines					1.406.014R				

				ENGINE
1.6 TL	Petrol	40	08/65-07/73	T, U

Engine	Information	A10	A20	A40	A50	A70	C10 - C30	C20	E01
Eng. T			1.206.032HV						
All engines					1.406.014R				

AMAROK

				ENGINE
2.0 TSI	Petrol	118	12/10-10/16	CFPA

Engine	Information	A10	A20	A40	A50	A70	C10 - C30	C20	E01
All engines	x 4, ELDOR, Housing Colour:Black, COIL ON PLUG, incl. spark plug connector						1.970.426	C10	

ARTEON

				ENGINE
1.4 eHybrid	Petrol/ Electric	115	11/20->	DGEB

Engine	Information	A10	A20	A40	A50	A70	C10 - C30	C20	E01
All engines	x 4, ELDOR, COIL ON PLUG, Number of pins:4, incl. spark plug connector						1.970.599	C10	

				ENGINE
2.0 TSI	Petrol	140	05/17->	CZPB, DKZA, DNNA

Engine	Information	A10	A20	A40	A50	A70	C10 - C30	C20	E01
All engines	01/10/18 ->, x 4, HITACHI, COIL ON PLUG, incl. spark plug connector						1.970.636	C10	

				ENGINE
2.0 TSi 4motion	Petrol	200	09/20->	DLRB

Engine	Information	A10	A20	A40	A50	A70	C10 - C30	C20	E01
All engines	x 4, HITACHI, COIL ON PLUG, incl. spark plug connector						1.970.636	C10	

				ENGINE
2.0 TSI 4motion	Petrol	206	06/20->	DJHC

Engine	Information	A10	A20	A40	A50	A70	C10 - C30	C20	E01
All engines	x 4, HITACHI, COIL ON PLUG, incl. spark plug connector						1.970.636	C10	

BEETLE

				ENGINE
1.2 TSI	Petrol	77	07/11-07/19	CBZB









Engine	Information	A10	A20	A40	A50	A70	C10 - C30	C20	E01
All engines							1.990.420	C30	1.499.248

A10 CONDENSER	A20 CONTACT SET	A40 DISTRIBUTOR CAP	A50 ROTOR	A70 PICK-UP
C10 COIL	C20 IGNITION MODULE	C30 ELECTRONIC IGNITION KIT	E01 IGNITION CABLE SET	

Vehicle	alim.	kW	Date	Engine	FUNCTIONS ON THE VEHICLE							
					A10	A20	A40	A50	A70	C10 - C30	C20	E01
ENGINE												
1.2 TSI 16V	Petrol	77	12/14-07/19	CYVD								
Engine	Information			A10	A20	A40	A50	A70	C10 - C30	C20	E01	
All engines	x 4, BERU, ELDOR, COIL ON PLUG, incl. spark plug connector, Number of pins:4, incl. spark plug connector								1.970.599	C10		
ENGINE												
1.4 TSI	Petrol	110	12/14-07/19	CZDA								
Engine	Information			A10	A20	A40	A50	A70	C10 - C30	C20	E01	
All engines	x 4, BERU, ELDOR, COIL ON PLUG, incl. spark plug connector, Number of pins:4, incl. spark plug connector								1.970.599	C10		
ENGINE												
1.4 TSI	Petrol	118	10/11-07/16	CAVD, CNWA, CTHD, CTKA								
Engine	Information			A10	A20	A40	A50	A70	C10 - C30	C20	E01	
All engines	x 4, COIL ON PLUG, incl. spark plug connector								1.970.474	C10		
ENGINE												
2.0 TFSI	Petrol	147	04/11-07/16	CBFA, CCTA, CCZA								
Engine	Information			A10	A20	A40	A50	A70	C10 - C30	C20	E01	
All engines	x 4, ELDOR, Housing Colour:Black, COIL ON PLUG, incl. spark plug connector								1.970.426	C10		
ENGINE												
2.0 TSI	Petrol	155	12/12-07/19	CPLA, CPPA								
Engine	Information			A10	A20	A40	A50	A70	C10 - C30	C20	E01	
All engines	01/01/15 ->, x 4, BERU, COIL ON PLUG, incl. spark plug connector								1.970.636	C10		
ENGINE												
2.0 TSI	Petrol	162	12/14-09/18	CULC								
Engine	Information			A10	A20	A40	A50	A70	C10 - C30	C20	E01	
All engines	01/02/15 ->, x 4, BERU, COIL ON PLUG, incl. spark plug connector								1.970.636	C10		
ENGINE												
2.5	Petrol	125	04/11-07/19	CBTA, CBUA, CCA								
Engine	Information			A10	A20	A40	A50	A70	C10 - C30	C20	E01	
All engines	x 5, ELDOR, Housing Colour:Black, COIL ON PLUG, incl. spark plug connector								1.970.426	C10		
BORA												
ENGINE												
1.4 16V	Petrol	55	03/00-05/05	AHW, AKQ, APE, AXP, BCA								
Engine	Information			A10	A20	A40	A50	A70	C10 - C30	C20	E01	
Eng. BCA	x 4, COIL ON PLUG, incl. spark plug connector								1.970.474	C10		
Eng. AHW, AKQ, APE, AXP									1.990.420	C30	1.501.575	
ENGINE												
1.6	Petrol	74	10/98-05/05	AEH, AKL, APF								
Engine	Information			A10	A20	A40	A50	A70	C10 - C30	C20	E01	
All engines									1.990.420	C30	1.501.484	
ENGINE												
1.6	Petrol	75	08/00-05/05	AVU, BFQ								
Engine	Information			A10	A20	A40	A50	A70	C10 - C30	C20	E01	
All engines									1.990.420	C30	1.501.585	
ENGINE												
1.6 16V	Petrol	77	02/00-05/05	ATN, AUS, AZD, BCB								
Engine	Information			A10	A20	A40	A50	A70	C10 - C30	C20	E01	
Eng. AZD, BCB	x 4, COIL ON PLUG, incl. spark plug connector								1.970.474	C10		
Eng. ATN, AUS									1.990.420	C30	1.501.575	
ENGINE												
1.6 FSI	Petrol	81	01/02-05/05	BAD								
Engine	Information			A10	A20	A40	A50	A70	C10 - C30	C20	E01	
All engines	x 4, COIL ON PLUG, incl. spark plug connector								1.970.474	C10		
ENGINE												
1.8	Petrol	92	10/98-05/05	AGN								
Engine	Information			A10	A20	A40	A50	A70	C10 - C30	C20	E01	
All engines											1.501.489	

A10 CONDENSER	A20 CONTACT SET	A40 DISTRIBUTOR CAP	A50 ROTOR	A70 PICK-UP
C10 COIL	C20 IGNITION MODULE	C30 ELECTRONIC IGNITION KIT	E01 IGNITION CABLE SET	

The present application list is a brief version. For the detailed information about the possibility of installation on a specific vehicle, please refer to our web-catalogue <http://catalogo.facet.eu/>

				FUNCTIONS ON THE VEHICLE													
Vehicle	alim.	kW	Date	Engine													
ENGINE																	
1.8 4motion	Petrol	92	02/99-05/05	AGN													
Engine	Information				A10	A20	A40	A50	A70	C10 - C30	C20	E01					
All engines										1.990.420	C30	1.501.489					
ENGINE																	
1.8 T	Petrol	110	05/00-05/05	AGU, AUM													
Engine	Information				A10	A20	A40	A50	A70	C10 - C30	C20	E01					
Eng. AGU	x 4, COIL ON PLUG									1.970.354S	C10						
Eng. AUM	x 4, COIL ON PLUG, incl. spark plug connector									1.970.429	C10						
Eng. AGU											1.965.076						
ENGINE																	
1.8 T	Petrol	132	03/02-05/05	AUQ													
Engine	Information				A10	A20	A40	A50	A70	C10 - C30	C20	E01					
All engines	x 4, COIL ON PLUG, incl. spark plug connector									1.970.429	C10						
ENGINE																	
2.0	Petrol	85	10/98-12/13	APK, AQY, AZH, AZJ													
Engine	Information				A10	A20	A40	A50	A70	C10 - C30	C20	E01					
Eng. APK, AQY										1.990.420	C30						
Eng. AZH										1.990.420	C30						
Eng. AZJ												1.499.223					
Eng. APK, AQY, AZH												1.501.585					
ENGINE																	
2.0 4motion	Petrol	85	04/00-05/05	AZH, AZJ													
Engine	Information				A10	A20	A40	A50	A70	C10 - C30	C20	E01					
Eng. AZH										1.990.420	C30	1.501.585					
Eng. AZJ												1.499.223					
ENGINE																	
2.0 4motion	Petrol	88	12/99-05/03	AZH													
Engine	Information				A10	A20	A40	A50	A70	C10 - C30	C20	E01					
All engines										1.990.420	C30						
ENGINE																	
2.3 V5	Petrol	110	10/98-10/00	AGZ													
Engine	Information				A10	A20	A40	A50	A70	C10 - C30	C20	E01					
All engines											1.965.074						
ENGINE																	
2.3 V5	Petrol	125	10/00-05/05	AQN													
Engine	Information				A10	A20	A40	A50	A70	C10 - C30	C20	E01					
All engines	x 5, COIL ON PLUG									1.970.435	C10						
ENGINE																	
2.3 V5 4motion	Petrol	110	12/98-10/00	AGZ													
Engine	Information				A10	A20	A40	A50	A70	C10 - C30	C20	E01					
All engines											1.965.074						
ENGINE																	
2.3 V5 4motion	Petrol	125	10/00-05/05	AQN													
Engine	Information				A10	A20	A40	A50	A70	C10 - C30	C20	E01					
All engines	x 5, COIL ON PLUG									1.970.435	C10						
ENGINE																	
2.8 V6 4motion	Petrol	150	03/99-05/05	AUE, BDE													
Engine	Information				A10	A20	A40	A50	A70	C10 - C30	C20	E01					
All engines	01/05/01 ->, x 6, ch. 1J2000001 ->, COIL ON PLUG, x 6, COIL ON PLUG									1.970.435	C10						
ENGINE																	
2.8 VR6	Petrol	150	03/00-05/00	AUE													
Engine	Information				A10	A20	A40	A50	A70	C10 - C30	C20	E01					
All engines	ch. 1J-2-000 001 ->, Qty: 6									1.970.435	C10						
CADDY I																	
ENGINE																	
1.5	Petrol	51	08/82-07/83	JB													
Engine	Information				A10	A20	A40	A50	A70	C10 - C30	C20	E01					
All engines	version Bosch				1.106.196	1.206.034HVS	1.306.079	1.406.055R									
All engines	ch. 14-F-000 370 ->											1.500.725					
All engines	->ch. 14-F-000 369											1.500.727					
A10	CONDENSER	A20	CONTACT SET	A40	DISTRIBUTOR CAP	A50	ROTOR	A70	PICK-UP	C10	COIL	C20	IGNITION MODULE	C30	ELECTRONIC IGNITION KIT	E01	IGNITION CABLE SET

Vehicle	alim.	kW	Date	Engine	FUNCTIONS ON THE VEHICLE							
					A10	A20	A40	A50	A70	C10 - C30	C20	E01

				ENGINE
1.6	Petrol	53	08/83-07/89	HN

Engine	Information	A10	A20	A40	A50	A70	C10 - C30	C20	E01
All engines	version Bosch	1.106.196	1.206.034HVS						
All engines	version Bosch, ->ch. 14-F-002 256			1.306.079	1.406.055R				
All engines	version Bosch, ch. 14-F-002 257 ->			1.306.094	1.406.025R				
All engines	ch. 14-F-000 370 ->								1.500.725
All engines	->ch. 14-F-000 369								1.500.727

				ENGINE
1.6	Petrol	55	01/83-07/92	EW

Engine	Information	A10	A20	A40	A50	A70	C10 - C30	C20	E01
All engines	version Bosch	1.106.196	1.206.034HVS						
All engines	version Bosch, ->ch. 14-E-003 890			1.306.079	1.406.055R				
All engines	version Bosch, ch. 14-E-003 891 ->			1.306.094	1.406.025R				
All engines	ch. 14-F-000 370 ->								1.500.725
All engines	->ch. 14-F-000 369								1.500.727

				ENGINE
1.8	Petrol	70	08/85-07/92	JH

Engine	Information	A10	A20	A40	A50	A70	C10 - C30	C20	E01
All engines	->ch. 14-G-020 000, version Bosch			1.306.094					
All engines	ch. 14-H-000 001 ->, version Bosch			1.306.266					
All engines	version Bosch				1.406.055R	1.906.219			
All engines	->ch. 14-J-020 000						1.970.125	C10	
All engines	ch. 14-K-000 001 ->						1.970.126	C10	
All engines								1.965.007	
All engines	ch. 14-F-000 370 ->								1.500.725
All engines	->ch. 14-F-000 369								1.500.727

CADDY II

				ENGINE
1.4	Petrol	44	11/95-06/03	AEX, AKV, APQ, AUD

Engine	Information	A10	A20	A40	A50	A70	C10 - C30	C20	E01
Eng. AEX, AKV, APQ	version Bosch			1.306.094	1.406.121R	1.906.223			
Eng. AEX, AKV, APQ	version Marelli			1.330.116	1.430.057R				
Eng. AEX, APQ							1.990.414	C30	
Eng. AUD							1.990.420	C30	1.501.601
Eng. AEX, AKV, APQ									1.501.660

				ENGINE
1.4	Petrol	55	08/00-01/04	AUA

Engine	Information	A10	A20	A40	A50	A70	C10 - C30	C20	E01
All engines							1.990.420	C30	1.501.575

				ENGINE
1.4 16V	Petrol	55	08/00-01/04	AUA

Engine	Information	A10	A20	A40	A50	A70	C10 - C30	C20	E01
All engines							1.990.420	C30	1.501.575

				ENGINE
1.6	Petrol	55	11/95-12/00	1F, AEE

Engine	Information	A10	A20	A40	A50	A70	C10 - C30	C20	E01
Eng. AEE	version Bosch			1.306.094					
Eng. 1F	version Bosch			1.306.266					
Eng. 1F	version Duellier			1.315.068	1.415.099R				
Eng. AEE	version Marelli			1.330.116	1.430.057R				
All engines	version Bosch				1.406.121R	1.906.223			
All engines							1.990.414	C30	
Eng. 1F									1.500.965
Eng. AEE	Pickup								1.501.641
Eng. AEE									1.501.660

				ENGINE
60 1.4	Petrol	44	11/95-01/04	AEX, APQ, AUD

Engine	Information	A10	A20	A40	A50	A70	C10 - C30	C20	E01
Eng. AEX, APQ	version Bosch			1.306.094	1.406.121R	1.906.223			
Eng. AEX, APQ	version Marelli			1.330.116	1.430.057R				
Eng. AEX, APQ							1.990.414	C30	1.501.660
Eng. AUD							1.990.420	C30	1.501.601

A10	CONDENSER	A20	CONTACT SET	A40	DISTRIBUTOR CAP	A50	ROTOR	A70	PICK-UP
C10	COIL	C20	IGNITION MODULE	C30	ELECTRONIC IGNITION KIT	E01	IGNITION CABLE SET		

Vehicle	alim.	kW	Date	Engine	FUNCTIONS ON THE VEHICLE							
					A10	A20	A40	A50	A70	C10 - C30	C20	E01

ENGINE				
75 1.6	Petrol	55	11/95-09/00	1F, AEE

Engine	Information	A10	A20	A40	A50	A70	C10 - C30	C20	E01
Eng. AEE	version Bosch			1.306.094					
Eng. 1F	version Bosch			1.306.266					
Eng. 1F	version Ducellier			1.315.068	1.415.099R				
Eng. AEE	version Marelli			1.330.116	1.430.057R				
All engines	version Bosch				1.406.121R	1.906.223			
All engines							1.990.414	C30	
Eng. 1F									1.500.965
Eng. AEE									1.501.660

CADDY III				
ENGINE				
1.0 TSI	Petrol	62	11/18->	DKRD

Engine	Information	A10	A20	A40	A50	A70	C10 - C30	C20	E01
All engines	x 3, BERU, ELDOR, COIL ON PLUG, incl. spark plug connector, Number of pins:4, incl. spark plug connector						1.970.599	C10	

ENGINE				
1.0 TSI	Petrol	75	11/15->	CHZG, DKRE

Engine	Information	A10	A20	A40	A50	A70	C10 - C30	C20	E01
All engines	x 3, x 4, BERU, ELDOR, HITACHI, COIL ON PLUG, incl. spark plug connector, Number of pins:4, incl. spark plug connector						1.970.599	C10	

ENGINE				
1.2 TSI	Petrol	62	06/15->	CYVC

Engine	Information	A10	A20	A40	A50	A70	C10 - C30	C20	E01
All engines	x 4, BERU, ELDOR, HITACHI, COIL ON PLUG, incl. spark plug connector, Number of pins:4, incl. spark plug connector						1.970.599	C10	

ENGINE				
1.2 TSI	Petrol	63	09/10-05/15	CBZA

Engine	Information	A10	A20	A40	A50	A70	C10 - C30	C20	E01
All engines							1.990.420	C30	1.499.248

ENGINE				
1.2 TSI	Petrol	77	09/10-05/15	CBZB

Engine	Information	A10	A20	A40	A50	A70	C10 - C30	C20	E01
All engines							1.990.420	C30	1.499.248

ENGINE				
1.4	Petrol	55	03/04-05/06	BCA

Engine	Information	A10	A20	A40	A50	A70	C10 - C30	C20	E01
All engines	x 4, COIL ON PLUG, incl. spark plug connector						1.970.474	C10	

ENGINE				
1.4	Petrol	59	05/06-08/10	BUD

Engine	Information	A10	A20	A40	A50	A70	C10 - C30	C20	E01
All engines	x 4, COIL ON PLUG, incl. spark plug connector						1.970.474	C10	

ENGINE				
1.4 TGI CNG	Petrol/ Com- pressed Natural Gas (CNG)	81	06/15->	CPWA

Engine	Information	A10	A20	A40	A50	A70	C10 - C30	C20	E01
All engines	x 4, BERU, ELDOR, HITACHI, COIL ON PLUG, incl. spark plug connector, Number of pins:4, incl. spark plug connector						1.970.599	C10	

ENGINE				
1.4 TSI	Petrol	92	05/15->	CZCB









Engine	Information	A10	A20	A40	A50	A70	C10 - C30	C20	E01
All engines	x 4, BERU, ELDOR, HITACHI, COIL ON PLUG, incl. spark plug connector, Number of pins:4, incl. spark plug connector						1.970.599	C10	

ENGINE				
1.4 TSI	Petrol	96	07/18->	DJKD

Engine	Information	A10	A20	A40	A50	A70	C10 - C30	C20	E01
All engines	x 4, BERU, ELDOR, COIL ON PLUG, incl. spark plug connector, Number of pins:4, incl. spark plug connector						1.970.599	C10	

A10	CONDENSER	A20	CONTACT SET	A40	DISTRIBUTOR CAP	A50	ROTOR	A70	PICK-UP
C10	COIL	C20	IGNITION MODULE	C30	ELECTRONIC IGNITION KIT	E01	IGNITION CABLE SET		

Vehicle	alim.	kW	Date	Engine	FUNCTIONS ON THE VEHICLE														
					A10	A20	A40	A50	A70	C10 - C30	C20	E01							
ENGINE																			
1.6	Petrol	74	03/05-05/15	BRY															
ENGINE																			
ENGINE																			
1.6	Petrol	75	04/04-05/15	BGU, BSE, BSF															
ENGINE																			
ENGINE																			
1.6	Petrol	81	11/15-09/20	CWVA															
ENGINE																			
ENGINE																			
1.6 [ARG]	Petrol	69	10/05->	UVC															
ENGINE																			
ENGINE																			
1.6 BiFuel	Petrol/ Liquified Petro- leum Gas (LPG)	75	05/11-05/15	CHGA															
ENGINE																			
ENGINE																			
1.6 SRE	Petrol	81	11/15-09/20	CWVA															
ENGINE																			
ENGINE																			
1.8 [ARG]	Petrol	72	10/05->	BUR															
ENGINE																			
ENGINE																			
2.0 EcoFuel	CNG	80	04/06-05/15	BSX															
ENGINE																			
ENGINE																			
CADDY IV																			
1.6 SRE	Petrol	81	02/21->	DWYA															
ENGINE																			
ENGINE																			
CALIFORNIA																			
2.0 TSI	Petrol	110	07/12-07/19	CJKB															
ENGINE																			
ENGINE																			
2.0 TSI	Petrol	150	05/11-07/19	CJKA															
ENGINE																			
ENGINE																			
2.0 TSI 4motion	Petrol	150	07/11-07/19	CJKA															
ENGINE																			
ENGINE																			
CAMPMOBILE																			
2.0 Tsi	Petrol	110	07/12-08/15	CJKB															
ENGINE																			
ENGINE																			
A10	CONDENSER			A20	CONTACT SET			A40	DISTRIBUTOR CAP			A50	ROTOR			A70	PICK-UP		
C10	COIL			C20	IGNITION MODULE			C30	ELECTRONIC IGNITION KIT			E01	IGNITION CABLE SET						









					FUNCTIONS ON THE VEHICLE							
Vehicle	alim.	kW	Date	Engine								
ENGINE												
2.0 TSi	Petrol	150	05/11-08/15	CJKA								
Engine	Information				A10	A20	A40	A50	A70	C10 - C30	C20	E01
All engines	x 4, ELDOR, Housing Colour:Black, COIL ON PLUG, incl. spark plug connector									1.970.426	C10	
ENGINE												
2.0 TSi BlueMotion	Petrol	110	04/15-07/19	CJKB								
Engine	Information				A10	A20	A40	A50	A70	C10 - C30	C20	E01
All engines	x 4, ELDOR, Housing Colour:Black, COIL ON PLUG, incl. spark plug connector									1.970.426	C10	
ENGINE												
2.0 TSi BlueMotion	Petrol	150	04/15-07/19	CJKA								
Engine	Information				A10	A20	A40	A50	A70	C10 - C30	C20	E01
All engines	x 4, ELDOR, Housing Colour:Black, COIL ON PLUG, incl. spark plug connector									1.970.426	C10	
CC												
ENGINE												
1.4 TSi	Petrol	110	05/15-12/16	CZDA								
Engine	Information				A10	A20	A40	A50	A70	C10 - C30	C20	E01
All engines	x 4, BERU, ELDOR, COIL ON PLUG, incl. spark plug connector, Number of pins:4, incl. spark plug connector									1.970.599	C10	
ENGINE												
1.4 TSi	Petrol	118	11/11-12/16	CTHD								
Engine	Information				A10	A20	A40	A50	A70	C10 - C30	C20	E01
All engines	x 4, COIL ON PLUG, incl. spark plug connector									1.970.474	C10	
ENGINE												
1.4 TSi MultiFuel	Petrol/ Ethanol	118	11/11-12/16	CKMA								
Engine	Information				A10	A20	A40	A50	A70	C10 - C30	C20	E01
All engines	x 4, COIL ON PLUG, incl. spark plug connector									1.970.474	C10	
ENGINE												
1.8 TSi	Petrol	112	11/11-12/16	CDAB								
Engine	Information				A10	A20	A40	A50	A70	C10 - C30	C20	E01
All engines	x 4, ELDOR, Housing Colour:Black, COIL ON PLUG, incl. spark plug connector									1.970.426	C10	
ENGINE												
1.8 TSi	Petrol	118	11/11-12/16	CDA A								
Engine	Information				A10	A20	A40	A50	A70	C10 - C30	C20	E01
All engines	x 4, ELDOR, Housing Colour:Black, COIL ON PLUG, incl. spark plug connector									1.970.426	C10	
ENGINE												
2.0 TFSI	Petrol	147	11/11-12/16	CBFA, CCTA								
Engine	Information				A10	A20	A40	A50	A70	C10 - C30	C20	E01
All engines	x 4, ELDOR, Housing Colour:Black, COIL ON PLUG, incl. spark plug connector									1.970.426	C10	
ENGINE												
2.0 TSi	Petrol	147	11/11->	CBFA, CCTA								
Engine	Information				A10	A20	A40	A50	A70	C10 - C30	C20	E01
All engines	Qty: 4									1.970.426	C10	
ENGINE												
2.0 TSi	Petrol	155	11/11-12/16	CCZB								
Engine	Information				A10	A20	A40	A50	A70	C10 - C30	C20	E01
All engines	x 4, ELDOR, Housing Colour:Black, COIL ON PLUG, incl. spark plug connector									1.970.426	C10	
CORRADO												
ENGINE												
1.8 16V	Petrol	100	04/89-07/92	KR								
Engine	Information				A10	A20	A40	A50	A70	C10 - C30	C20	E01
All engines	version Bosch						1.306.266	1.406.121R	1.906.223			
All engines										1.970.126	C10	1.965.007
ENGINE												
1.8 G60	Petrol	118	09/88-09/93	PG								
Engine	Information				A10	A20	A40	A50	A70	C10 - C30	C20	E01
All engines	version Bosch						1.306.266	1.406.121R				
All engines										1.970.125	C10	1.965.007
												1.500.725

A10 CONDENSER	A20 CONTACT SET	A40 DISTRIBUTOR CAP	A50 ROTOR	A70 PICK-UP
C10 COIL	C20 IGNITION MODULE	C30 ELECTRONIC IGNITION KIT	E01 IGNITION CABLE SET	

Vehicle	alim.	kW	Date	Engine	FUNCTIONS ON THE VEHICLE									
					A10	A20	A40	A50	A70	C10 - C30	C20	E01		
ENGINE														
2.0 i	Petrol	85	04/93-12/95	2E, ADY										
Engine	Information				A10	A20	A40	A50	A70	C10 - C30	C20	E01		
All engines	version Bosch						1.306.266	1.406.121R						
All engines										1.990.414	C30			
Eng. ADY												1.965.007	1.500.725	
Eng. 2E													1.500.965	
ENGINE														
2.0 i 16V	Petrol	100	08/91-12/95	7TZ220XS560										
Engine	Information				A10	A20	A40	A50	A70	C10 - C30	C20	E01		
All engines	version Bosch						1.306.266	1.406.121R	1.906.223					
All engines											1.965.007			
ENGINE														
2.9 VR6	Petrol	140	08/91-12/95	ABV										
Engine	Information				A10	A20	A40	A50	A70	C10 - C30	C20	E01		
All engines	version Bosch						1.306.233							
All engines	-> ch. 50-N-018 000, version Bosch							1.406.148R						
All engines	ch. 50-N-018 001 ->, version Bosch							1.406.149R						
All engines	-> ch. 50-P-010 000									1.970.269	C10			
All engines											1.965.007			
DERBY														
ENGINE														
1.0	Petrol	29	10/81-12/84	GL										
Engine	Information				A10	A20	A40	A50	A70	C10 - C30	C20	E01		
All engines	version Bosch				1.106.196	1.206.049HVS	1.306.079	1.406.114R						
ENGINE														
1.1	Petrol	37	02/77-09/81	HB										
Engine	Information				A10	A20	A40	A50	A70	C10 - C30	C20	E01		
All engines	version Bosch				1.106.195	1.206.049HVS	1.306.079	1.406.026R						
All engines	version Ducellier							1.415.089R						
ENGINE														
1.3	Petrol	40	08/83-12/84	HK										
Engine	Information				A10	A20	A40	A50	A70	C10 - C30	C20	E01		
All engines	version Bosch						1.306.094	1.406.056R	1.906.193					
All engines										1.970.125	C10	1.965.004		
ENGINE														
1.3	Petrol	44	02/77-09/81	HH										
Engine	Information				A10	A20	A40	A50	A70	C10 - C30	C20	E01		
All engines	version Bosch				1.106.195	1.206.049HVS	1.306.079							
All engines	version Bosch, -> year 01/01/83							1.406.026R						
All engines	version Bosch, 01/01/83 ->							1.406.114R						
All engines	version Ducellier							1.415.089R						
ENGINE														
1.3	Petrol	55	09/82-12/84	GK										
Engine	Information				A10	A20	A40	A50	A70	C10 - C30	C20	E01		
All engines	version Bosch						1.306.094	1.406.121R	1.906.223					
All engines										1.970.125	C10	1.965.004		
EOS														
ENGINE														
1.4 TSI	Petrol	118	05/08-08/15	CAVD, CTHD										
Engine	Information				A10	A20	A40	A50	A70	C10 - C30	C20	E01		
All engines	x 4, COIL ON PLUG, incl. spark plug connector									1.970.474	C10			
ENGINE														
1.4 TSI	Petrol	90	11/07-08/15	CAXA										
Engine	Information				A10	A20	A40	A50	A70	C10 - C30	C20	E01		
All engines	x 4, COIL ON PLUG, incl. spark plug connector									1.970.474	C10			
ENGINE														
1.6 FSI	Petrol	85	06/06-05/08	BLF										
Engine	Information				A10	A20	A40	A50	A70	C10 - C30	C20	E01		
All engines	x 4, COIL ON PLUG, incl. spark plug connector									1.970.474	C10			

A10	CONDENSER	A20	CONTACT SET	A40	DISTRIBUTOR CAP	A50	ROTOR	A70	PICK-UP
C10	COIL	C20	IGNITION MODULE	C30	ELECTRONIC IGNITION KIT	E01	IGNITION CABLE SET		

The present application list is a brief version. For the detailed information about the possibility of installation on a specific vehicle, please refer to our web-catalogue <http://catalogo.facet.eu/>

				FUNCTIONS ON THE VEHICLE										
Vehicle	alim.	kW	Date	Engine	 A10	 A20	 A40	 A50	 A70	 C10 - C30	 C20	 E01		
				ENGINE										
2.0 FSI	Petrol	110	03/06-05/08	BVY, BVZ										
Engine		Information			A10	A20	A40	A50	A70	C10 - C30	C20	E01		
All engines		x 4, ELDOR, Housing Colour:Black, COIL ON PLUG, incl. spark plug connector								1.970.426	C10			
				ENGINE										
2.0 TFSI	Petrol	147	03/06-08/15	BPY, BWA, CAWB, CBFA, CCTA, CCZA										
Engine		Information			A10	A20	A40	A50	A70	C10 - C30	C20	E01		
All engines		01/06/08 ->, x 4, ELDOR, Housing Colour:Black, COIL ON PLUG, incl. spark plug connector								1.970.426	C10			
All engines		->year 01/05/08, x 4, COIL ON PLUG, incl. spark plug connector								1.970.474	C10			
				ENGINE										
2.0 TSI	Petrol	155	11/09-08/15	CCZB										
Engine		Information			A10	A20	A40	A50	A70	C10 - C30	C20	E01		
All engines		x 4, ELDOR, Housing Colour:Black, COIL ON PLUG, incl. spark plug connector								1.970.426	C10			
				ENGINE										
3.2 V6	Petrol	184	06/06-05/09	BUB, CBRA										
Engine		Information			A10	A20	A40	A50	A70	C10 - C30	C20	E01		
All engines		x 6, COIL ON PLUG, incl. spark plug connector								1.970.434	C10			
				FOX										
				ENGINE										
1.0	Petrol	52	10/03->	--										
Engine		Information			A10	A20	A40	A50	A70	C10 - C30	C20	E01		
All engines										1.990.420	C30	1.501.723		
				ENGINE										
1.0	Petrol	53	10/03->	AQZ, BNX										
Engine		Information			A10	A20	A40	A50	A70	C10 - C30	C20	E01		
All engines										1.990.420	C30	1.501.723		
				ENGINE										
1.0	Petrol	54	04/08->	CCNA										
Engine		Information			A10	A20	A40	A50	A70	C10 - C30	C20	E01		
All engines		->year 27/07/09								1.990.420	C30	1.501.723		
				ENGINE										
1.0 Alcohol	Petrol	53	10/03->	BJE, BNX										
Engine		Information			A10	A20	A40	A50	A70	C10 - C30	C20	E01		
All engines										1.990.420	C30	1.501.723		
				ENGINE										
1.0 Total Flex	Flexfuel	54	03/08->	CCNA										
Engine		Information			A10	A20	A40	A50	A70	C10 - C30	C20	E01		
All engines		->year 27/07/09								1.990.420	C30	1.501.723		
				ENGINE										
1.2	Petrol	40	04/05-07/11	BMD, CHFB										
Engine		Information			A10	A20	A40	A50	A70	C10 - C30	C20	E01		
All engines		x 3, COIL ON PLUG, incl. spark plug connector								1.970.431	C10			
				ENGINE										
1.2	Petrol	44	09/10-12/11	CHFA										
Engine		Information			A10	A20	A40	A50	A70	C10 - C30	C20	E01		
All engines		x 3, COIL ON PLUG, incl. spark plug connector								1.970.431	C10			
				ENGINE										
1.4	Petrol	55	04/05-12/09	BKR										
Engine		Information			A10	A20	A40	A50	A70	C10 - C30	C20	E01		
All engines										1.990.420	C30	1.501.723		
				ENGINE										
1.6	Petrol	74	10/03-08/14	BAH, BLH, BPA, CCRA, CFZA										
Engine		Information			A10	A20	A40	A50	A70	C10 - C30	C20	E01		
All engines										1.990.420	C30	1.501.723		
				ENGINE										
1.6 Alcohol	Petrol	76	10/03->	--										
Engine		Information			A10	A20	A40	A50	A70	C10 - C30	C20	E01		
All engines										1.990.420	C30	1.501.723		
				ENGINE										
A10	CONDENSER		A20	CONTACT SET		A40	DISTRIBUTOR CAP		A50	ROTOR		A70	PICK-UP	
C10	COIL		C20	IGNITION MODULE		C30	ELECTRONIC IGNITION KIT		E01	IGNITION CABLE SET				

Vehicle	alim.	kW	Date	Engine	FUNCTIONS ON THE VEHICLE									
					A10	A20	A40	A50	A70	C10 - C30	C20	E01		
ENGINE														
1.6 Total Flex	Petrol/ Ethanol	74	10/03-08/14	BJA, BPA, CCRA										
Engine	Information				A10	A20	A40	A50	A70	C10 - C30	C20	E01		
All engines										1.990.420	C30		1.501.723	
GOLF I														
ENGINE														
1.3	Petrol	40	08/83-07/86	HK										
Engine	Information				A10	A20	A40	A50	A70	C10 - C30	C20	E01		
All engines	version Bosch				1.106.195	1.206.049HVS		1.406.114R						
All engines	->ch. 15-E-027 000, version Bosch						1.306.079							
All engines	ch. 15-E-027 001 ->, version Bosch						1.306.094							
All engines	->ch. 15-E-027 000												1.500.727	
ENGINE														
1.6	Petrol	55	08/83-04/92	EW, HN										
Engine	Information				A10	A20	A40	A50	A70	C10 - C30	C20	E01		
All engines	version Bosch, ->eng. 012 000, ->eng. 005 000						1.306.079							
All engines	version Bosch, eng. type 012 001 ->, ->eng. 035 000, eng. type 005 001 ->, ->eng. 007 000						1.306.094							
All engines	version Bosch, eng. type 035 001 ->, eng. type 007 001 ->						1.306.266							
Eng. EW	version Ducellier, eng. type 012 001 ->						1.315.068	1.415.099R						
All engines	version Bosch, eng. type 007 001 ->							1.406.055R						
All engines	version Bosch, distr. num. 026 905 206 AD, eng. type 024 001 ->, ->eng. 025 000, ->eng. 005 000								1.906.219					
All engines	ch. 15-E-027 001 ->, ->ch. 15-J-035 000, ch. 15-L-000 001 ->									1.970.125	C10			
All engines	ch. 15-K-000 001 ->, ->ch. 15-K-035 000									1.970.126	C10			
All engines	->ch. 15-E-027 000									1.970.132	C10		1.500.727	
All engines											1.965.007			
All engines	ch. 15-E-027 001 ->												1.500.725	
ENGINE														
1.8	Petrol	66	08/83-09/92	EX										
Engine	Information				A10	A20	A40	A50	A70	C10 - C30	C20	E01		
All engines	version Bosch, ->eng. 015 000						1.306.079							
All engines	version Bosch, eng. type 015 001 ->, ->eng. 035 000						1.306.094							
All engines	version Bosch, eng. type 035 001 ->						1.306.266							
All engines	version Ducellier						1.315.068	1.415.099R						
All engines	version Bosch							1.406.055R	1.906.219					
All engines	ch. 15-E-027 001 ->, ->ch. 15-J-035 000, ch. 15-L-000 001 ->									1.970.125	C10			
All engines	ch. 15-K-000 001 ->, ->ch. 15-K-035 000									1.970.126	C10			
All engines	->ch. 15-E-027 000									1.970.132	C10		1.500.727	
All engines											1.965.007			
All engines	ch. 15-E-027 001 ->												1.500.725	
ENGINE														
1.8	Petrol	70	08/83-04/93	JH										
Engine	Information				A10	A20	A40	A50	A70	C10 - C30	C20	E01		
All engines	version Bosch, ->eng. 140 000						1.306.079	1.406.055R						
All engines	version Bosch, eng. type 140 001 ->, ->eng. 280 000						1.306.094							
All engines	version Bosch, eng. type 280 001 ->						1.306.266							
All engines	version Bosch, ->eng. 140 000, eng. type 280 001 ->								1.906.219					
All engines	ch. 15-E-027 001 ->, ->ch. 15-J-035 000, ch. 15-L-000 001 ->									1.970.125	C10			
All engines	ch. 15-K-000 001 ->, ->ch. 15-K-035 000									1.970.126	C10			
All engines	->ch. 15-E-027 000									1.970.132	C10		1.500.727	
All engines											1.965.007			
All engines	ch. 15-E-027 001 ->												1.500.725	
ENGINE														
1.8	Petrol	72	08/89-03/93	2H										
Engine	Information				A10	A20	A40	A50	A70	C10 - C30	C20	E01		
All engines	version Bosch, ch. 15-L-012 001 ->, ->ch. 15-M-021 000						1.306.094							
All engines	version Bosch, ->ch. 15-L-012 000, ch. 15-M-021 001 ->						1.306.266							
All engines	version Bosch							1.406.121R						
All engines	ch. 15-E-027 001 ->, ->ch. 15-J-035 000, ch. 15-L-000 001 ->									1.970.125	C10			
All engines	ch. 15-K-000 001 ->, ->ch. 15-K-035 000									1.970.126	C10			
All engines	->ch. 15-E-027 000									1.970.132	C10		1.500.727	
All engines											1.965.007			
All engines	ch. 15-E-027 001 ->												1.500.725	

A10	CONDENSER	A20	CONTACT SET	A40	DISTRIBUTOR CAP	A50	ROTOR	A70	PICK-UP
C10	COIL	C20	IGNITION MODULE	C30	ELECTRONIC IGNITION KIT	E01	IGNITION CABLE SET		

The present application list is a brief version. For the detailed information about the possibility of installation on a specific vehicle, please refer to our web-catalogue <http://catalogo.facet.eu/>

Vehicle	alim.	kW	Date	Engine	FUNCTIONS ON THE VEHICLE							
					A10	A20	A40	A50	A70	C10 - C30	C20	E01

ENGINE				
1.8	Petrol	72	08/89-03/93	2H

Engine	Information	A10	A20	A40	A50	A70	C10 - C30	C20	E01
All engines	->ch. 15-E-027 000						1.970.132	C10	1.500.727
All engines								1.965.007	
All engines	ch. 15-E-027 001 ->								1.500.725

ENGINE				
1.8	Petrol	82	08/82-12/92	DX, KT

Engine	Information	A10	A20	A40	A50	A70	C10 - C30	C20	E01
Eng. DX	version Bosch, ->eng. 110 000			1.306.079					
All engines	version Bosch, eng. type 110 001 ->, ->eng. 119 000, ->eng. 004 600			1.306.094	1.406.116R				
All engines	version Bosch, eng. type 119 001 ->, eng. type 004 601 ->			1.306.266					
All engines	version Bosch, ->eng. 110 000, eng. type 119 001 ->, eng. type 004 601 ->				1.406.055R				
All engines	version Bosch, eng. type 130 001 ->					1.906.219			
All engines	ch. 15-E-027 001 ->, ->ch. 15-J-035 000, ch. 15-L-000 001 ->						1.970.125	C10	
All engines	ch. 15-K-000 001 ->, ->ch. 15-K-035 000						1.970.126	C10	
All engines	->ch. 15-E-027 000						1.970.132	C10	1.500.727
All engines								1.965.007	
All engines	ch. 15-E-027 001 ->								1.500.725

GOLF II

ENGINE				
1.0	Petrol	33	11/83-08/85	GN

Engine	Information	A10	A20	A40	A50	A70	C10 - C30	C20	E01
All engines	version Bosch, no specific info conc. application available	1.106.195, 1.106.196							
All engines	version Bosch		1.206.049HVS		1.406.114R				
All engines	version Bosch, ->ch. 19-E-855 000			1.306.079					
All engines	version Bosch, ch. 19-E-855 001 ->			1.306.094					
All engines	ch. 19-E-855 001 ->								1.500.725
All engines	->ch. 19-E-855 000								1.500.727

ENGINE				
1.0	Petrol	37	08/85-10/91	HZ

Engine	Information	A10	A20	A40	A50	A70	C10 - C30	C20	E01
All engines	version Bosch, 01/09/86 ->, ->ch. 1G-MB150 000, ->ch. 1G-MW480 000			1.306.094					
All engines	version Bosch, ch. 1G-MB150 001 ->, ch. 1G-MW480 001 ->			1.306.266		1.906.234			
All engines	version Bosch, 01/09/86 ->				1.406.056R				
All engines	version Bosch, ->ch. 1G-MB150 000, ->ch. 1G-MW480 000					1.906.193			
All engines	no specific info conc. application available						1.970.125, 1.970.126	C10	
All engines								1.965.007	
All engines	01/08/88 ->, ch. 19-E-855 001 ->								1.500.493
All engines	01/08/86 ->, ->year 01/08/88								1.501.671

ENGINE				
1.3	Petrol	37	08/85-12/87	NU

Engine	Information	A10	A20	A40	A50	A70	C10 - C30	C20	E01
All engines	version Bosch, 01/08/86 ->			1.306.094	1.406.056R				
All engines	version Bosch					1.906.193			
All engines							1.970.125	C10	1.501.671

ENGINE				
1.3	Petrol	40	08/83-06/87	HK, MH

Engine	Information	A10	A20	A40	A50	A70	C10 - C30	C20	E01
Eng. HK	version Bosch	1.106.195	1.206.049HVS		1.406.114R				
Eng. HK	version Bosch, ->ch. 19-E-855 000			1.306.079					
All engines	version Bosch, ch. 19-E-855 001 ->, 01/08/86 ->			1.306.094					
Eng. MH	version Bosch, 01/08/86 ->				1.406.056R				
Eng. MH	version Bosch					1.906.193			
Eng. MH	->year 31/07/87						1.970.125	C10	
Eng. MH	01/08/87 ->						1.970.126	C10	
Eng. MH								1.965.007	
All engines	ch. 19-E-855 001 ->, ->year 31/07/86, 01/08/88 ->								1.500.493
Eng. HK	->ch. 19-E-855 000								1.500.727
Eng. MH	01/08/86 ->, ->year 31/07/88								1.501.671

A10 CONDENSER	A20 CONTACT SET	A40 DISTRIBUTOR CAP	A50 ROTOR	A70 PICK-UP
C10 COIL	C20 IGNITION MODULE	C30 ELECTRONIC IGNITION KIT	E01 IGNITION CABLE SET	

Vehicle	alim.	kW	Date	Engine	FUNCTIONS ON THE VEHICLE							
					A10	A20	A40	A50	A70	C10 - C30	C20	E01

ENGINE				
1.3	Petrol	43	08/83-10/86	GT

Engine	Information	A10	A20	A40	A50	A70	C10 - C30	C20	E01
All engines	version Bosch	1.106.195	1.206.049HVS		1.406.056R				
All engines	version Bosch, ->ch. 19-E-855 000			1.306.079					
All engines	version Bosch, ch. 19-E-855 001 ->			1.306.094					
All engines	ch. 19-E-855 001 ->								1.500.493
All engines	->ch. 19-E-855 000								1.500.727

ENGINE				
1.3 Cat	Petrol	40	06/86-12/92	2G, NZ

Engine	Information	A10	A20	A40	A50	A70	C10 - C30	C20	E01
All engines	01/01/87 ->, ->ch. 1G-MB150 000, ->ch. 1G-MW480 000, version Bosch, ->ch. 1G-MB150 000			1.306.094					
All engines	ch. 1G-MB150 001 ->, ch. 1G-MW480 001 ->, version Bosch			1.306.266					
All engines	version Bosch				1.406.056R				
All engines	->ch. 1G-MB150 000, ->ch. 1G-MW480 000, version Bosch, distr. num. 030 905 205 D					1.906.193			
All engines	ch. 1G-MB150 001 ->, ch. 1G-MW480 001 ->, version Bosch, distr. num. 030 805 205 S					1.906.234			
All engines	no specific info conc. application available						1.970.125, 1.970.126	C10	1.500.493
All engines								1.965.007	
Eng. NZ	no specific info conc. application available								1.501.671

ENGINE				
1.6	Petrol	51	10/86-12/92	PN

Engine	Information	A10	A20	A40	A50	A70	C10 - C30	C20	E01
All engines	version Bosch			1.306.266	1.406.055R				
All engines	version Ducellier			1.315.068	1.415.099R				
All engines	version Bosch, ->year 31/07/86					1.906.159			
All engines	version Bosch, 01/08/86 ->					1.906.219			
All engines	no specific info conc. application available						1.970.125, 1.970.126	C10	
All engines								1.965.007	1.500.725

ENGINE				
1.6	Petrol	53	02/86-10/91	RF

Engine	Information	A10	A20	A40	A50	A70	C10 - C30	C20	E01
All engines	version Bosch			1.306.266	1.406.055R	1.906.219			
All engines	version Ducellier			1.315.068	1.415.099R				
All engines	no specific info conc. application available						1.970.125, 1.970.126	C10	
All engines								1.965.007	1.500.725

ENGINE				
1.6	Petrol	55	08/83-07/92	ABN, EZ

Engine	Information	A10	A20	A40	A50	A70	C10 - C30	C20	E01
Eng. EZ	version Bosch, ->eng. 309 582	1.106.196	1.206.034HVS						
Eng. EZ	version Bosch, distr. num. 050 905 205 C, eng. type 185 001 ->, ->year 01/07/86			1.306.094					
All engines	version Bosch			1.306.266					
All engines	version Ducellier, 01/08/85 ->			1.315.068	1.415.099R				
Eng. EZ	version Bosch, eng. type 185 001 ->, ->eng. 309 582				1.406.025R				
All engines	version Bosch, distr. num. 026 905 206, distr. num. 050 905 205, distr. num. 050 905 205 C, ->eng. 185 000, eng. type 309 583 ->				1.406.055R				
All engines	version Bosch, distr. num. 050 905 205 C, eng. type 309 583 ->					1.906.219			
All engines	no specific info conc. application available						1.970.125	C10	
Eng. EZ	no specific info conc. application available						1.970.126	C10	
All engines								1.965.007	
All engines	ch. 19-E-855 001 ->								1.500.725
Eng. EZ	->ch. 19-E-855 000								1.500.727

ENGINE				
1.6 [CHE] [SWE]	Petrol	60	08/83-07/88	HM

Engine	Information	A10	A20	A40	A50	A70	C10 - C30	C20	E01
All engines	version Bosch, ->eng. 033 000	1.106.196	1.206.034HVS						
All engines	version Bosch, ->eng. 016 000			1.306.079					
All engines	version Bosch, eng. type 016 001 ->, ->year 01/07/86			1.306.094					
All engines	version Bosch, 01/08/86 ->			1.306.266					
All engines	version Bosch, eng. type 016 001 ->, ->eng. 033 000				1.406.025R				

A10	CONDENSER	A20	CONTACT SET	A40	DISTRIBUTOR CAP	A50	ROTOR	A70	PICK-UP
C10	COIL	C20	IGNITION MODULE	C30	ELECTRONIC IGNITION KIT	E01	IGNITION CABLE SET		

Vehicle	alim.	kW	Date	Engine	FUNCTIONS ON THE VEHICLE							
					A10	A20	A40	A50	A70	C10 - C30	C20	E01

ENGINE				
1.6 [CHE] [SWE]	Petrol	60	08/83-07/88	HM

Engine	Information	A10	A20	A40	A50	A70	C10 - C30	C20	E01
All engines	version Bosch, ->eng. 016 000, eng. type 033 001 ->, ->year 31/07/85, 01/08/86 ->				1.406.055R				
All engines	version Bosch, eng. type 033 001 ->					1.906.219			
All engines	ch. 19-F-350 000 ->						1.970.125	C10	
All engines								1.965.007	
All engines	ch. 19-E-855 001 ->								1.500.725
All engines	->ch. 19-E-855 000								1.500.727

ENGINE				
1.6 G	Petrol	51	08/86-07/91	EZA, PN

Engine	Information	A10	A20	A40	A50	A70	C10 - C30	C20	E01
All engines	version Bosch			1.306.266	1.406.055R				
All engines	version Ducellier			1.315.068	1.415.099R				
Eng. PN	version Bosch, ->year 31/07/86					1.906.159			
All engines	version Bosch, 01/08/86 ->					1.906.219			
All engines	no specific info conc. application available						1.970.125	C10	
Eng. PN	no specific info conc. application available						1.970.126	C10	
All engines								1.965.007	1.500.725

ENGINE				
1.8	Petrol	62	08/86-01/90	RH

Engine	Information	A10	A20	A40	A50	A70	C10 - C30	C20	E01
All engines	version Bosch			1.306.094	1.406.055R	1.906.219			
All engines							1.970.125	C10	1.965.007
									1.500.725

ENGINE				
1.8	Petrol	66	08/84-10/91	GU, GX

Engine	Information	A10	A20	A40	A50	A70	C10 - C30	C20	E01
Eng. GU	version Bosch, ->eng. 003 200			1.306.079					
All engines	version Bosch, eng. type 003 201 ->, ->eng. 31/07/87, ->year 31/07/86			1.306.094					
All engines	version Bosch, 01/08/87 ->, 01/08/86 ->			1.306.266					
Eng. GU	version Ducellier, 01/08/85 ->			1.315.068	1.415.099R				
All engines	version Bosch				1.406.055R	1.906.219			
All engines	ch. 19-E-855 001 ->						1.970.125	C10	1.500.725
Eng. GU	01/08/88 ->, ->year 31/07/89						1.970.126	C10	
All engines	->ch. 19-E-855 000						1.970.132	C10	1.500.727
All engines								1.965.007	

ENGINE				
1.8	Petrol	77	08/87-10/91	RV

Engine	Information	A10	A20	A40	A50	A70	C10 - C30	C20	E01
All engines	version Bosch, ch. 1G-LB100 001 ->, ch. 1G-LW320 001 ->, ->ch. 1G-MB150 000, ->ch. 1G-MW480 000			1.306.094					
All engines	version Bosch, ->ch. 1G-LB100 000, ->ch. 1G-LW320 000, ch. 1G-MB150 001 ->, ch. 1G-MW480 001 ->			1.306.266					
All engines	version Bosch				1.406.121R				
All engines							1.970.125	C10	1.965.007
									1.500.725

ENGINE				
1.8 [CHE] [SWE]	Petrol	66	04/84-07/87	HV

Engine	Information	A10	A20	A40	A50	A70	C10 - C30	C20	E01
All engines	version Bosch, 01/08/86 ->, ->year 31/07/87			1.306.266					
All engines	version Bosch, 01/08/86 ->				1.406.055R	1.906.219			
All engines	version Bosch, ->year 31/07/86					1.906.159			
All engines	ch. 19-E-855 001 ->						1.970.125	C10	1.500.725
All engines	->ch. 19-E-855 000						1.970.132	C10	1.500.727
All engines								1.965.007	

ENGINE				
1.8 GTI	Petrol	79	08/85-10/87	RD

Engine	Information	A10	A20	A40	A50	A70	C10 - C30	C20	E01
All engines	version Bosch			1.306.266	1.406.121R				
All engines							1.970.125	C10	1.965.007
									1.500.725

ENGINE				
1.8 GTI	Petrol	82	08/83-10/91	EV, PB

Engine	Information	A10	A20	A40	A50	A70	C10 - C30	C20	E01
Eng. EV	version Bosch, ->eng. 025 000			1.306.079					

A10 CONDENSER	A20 CONTACT SET	A40 DISTRIBUTOR CAP	A50 ROTOR	A70 PICK-UP
C10 COIL	C20 IGNITION MODULE	C30 ELECTRONIC IGNITION KIT	E01 IGNITION CABLE SET	

Vehicle	alim.	kW	Date	Engine	FUNCTIONS ON THE VEHICLE							
					A10	A20	A40	A50	A70	C10 - C30	C20	E01

				ENGINE
1.8 GTI	Petrol	82	08/83-10/91	EV, PB

Engine	Information	A10	A20	A40	A50	A70	C10 - C30	C20	E01
All engines	version Bosch, eng. type 025 001 ->, ->year 31/07/86, ch. 1G-LB100 001 ->, ch. 1G-LW320 001 ->, ->ch. 1G-MB150 000, ->ch. 1G-MW480 000			1.306.094					
All engines	version Bosch, 01/08/86 ->, ->ch. 1G-LB100 000, ->ch. 1G-LW320 000, ch. 1G-MB150 001 ->, ch. 1G-MW480 001 ->			1.306.266					
Eng. EV	version Bosch, 01/08/85 ->				1.406.055R				
Eng. EV	version Bosch, ->year 31/07/85				1.406.116R				
Eng. PB	version Bosch				1.406.121R				
Eng. EV	version Bosch					1.906.219			
All engines	ch. 19-E-855 001 ->						1.970.125	C10	1.500.725
Eng. EV	->ch. 19-E-855 000						1.970.132	C10	1.500.727
All engines								1.965.007	

				ENGINE
1.8 GTI 16V	Petrol	102	02/86-06/90	KR

Engine	Information	A10	A20	A40	A50	A70	C10 - C30	C20	E01
All engines	version Bosch			1.306.266	1.406.121R	1.906.223			
All engines							1.970.125	C10	1.965.007
All engines	->year 31/07/89								1.500.737

				ENGINE
1.8 GTI 16V	Petrol	95	02/86-10/91	PL

Engine	Information	A10	A20	A40	A50	A70	C10 - C30	C20	E01
All engines	version Bosch			1.306.266	1.406.121R	1.906.223			
All engines	no specific info conc. application available						1.970.125, 1.970.126	C10	
All engines								1.965.007	
All engines	->year 31/07/89								1.500.737

				ENGINE
1.8 GTI Cat	Petrol	79	01/87-10/91	PF

Engine	Information	A10	A20	A40	A50	A70	C10 - C30	C20	E01
All engines	version Bosch, ch. 1G-LB100 001 ->, ch. 1G-LW320 001 ->, ->ch. 1G-MB150 000, ->ch. 1G-MW480 000			1.306.094					
All engines	version Bosch, ->ch. 1G-LB100 000, ->ch. 1G-LW320 000, ch. 1G-MB150 001 ->, ch. 1G-MW480 001 ->			1.306.266					
All engines	version Bosch				1.406.121R				
All engines							1.970.125	C10	1.965.007
All engines									1.500.725

				ENGINE
1.8 GTI G60	Petrol	118	04/90-07/91	PG

Engine	Information	A10	A20	A40	A50	A70	C10 - C30	C20	E01
All engines	version Bosch, ->ch. 1G-MB150 000, ->ch. 1G-MW480 000			1.306.094					
All engines	version Bosch, ch. 1G-MB150 001 ->, ch. 1G-MW480 001 ->			1.306.266					
All engines	version Bosch				1.406.121R				
All engines							1.970.125	C10	1.965.007
All engines									1.500.725

				ENGINE
1.8 GTI G60 Syncro	Petrol	118	08/88-12/91	1H, PG

Engine	Information	A10	A20	A40	A50	A70	C10 - C30	C20	E01
All engines	version Bosch, ->ch. 1G-MB120 000, ->ch. 1G-MW480 000			1.306.094					
Eng. PG	version Bosch, ch. 1G-MB150 001 ->, ch. 1G-MW480 001 ->			1.306.266					
All engines	version Bosch				1.406.121R				
All engines							1.970.125	C10	1.965.007
All engines									1.500.725

				ENGINE
1.8 i	Petrol	66	08/87-07/91	RP

Engine	Information	A10	A20	A40	A50	A70	C10 - C30	C20	E01
All engines	version Bosch			1.306.266	1.406.055R	1.906.219			
All engines							1.970.125	C10	1.965.007
All engines									1.500.725

				ENGINE
1.8 i Cat	Petrol	66	08/87-10/91	GX, RP

Engine	Information	A10	A20	A40	A50	A70	C10 - C30	C20	E01
Eng. GX	version Bosch, ->year 31/07/86			1.306.094					
All engines	version Bosch, 01/08/86 ->			1.306.266					
All engines	version Bosch				1.406.055R	1.906.219			
All engines	ch. 19-E-855 001 ->						1.970.125	C10	1.500.725

A10 CONDENSER	A20 CONTACT SET	A40 DISTRIBUTOR CAP	A50 ROTOR	A70 PICK-UP
C10 COIL	C20 IGNITION MODULE	C30 ELECTRONIC IGNITION KIT	E01 IGNITION CABLE SET	

FUNCTIONS ON THE VEHICLE

Vehicle	alim.	kW	Date	Engine								
---------	-------	----	------	--------	---	---	---	--	---	---	---	---

				ENGINE
1.8 i Cat	Petrol	66	08/87-10/91	GX, RP

Engine	Information	A10	A20	A40	A50	A70	C10 - C30	C20	E01
Eng. GX	->ch. 19-E-855 000						1.970.132	C10	1.500.727
All engines								1.965.007	

				ENGINE
1.8 i Cat Syncro	Petrol	66	08/87-10/91	RP

Engine	Information	A10	A20	A40	A50	A70	C10 - C30	C20	E01
All engines	version Bosch			1.306.266	1.406.055R	1.906.219			
All engines							1.970.125	C10	1.965.007
									1.500.725

				ENGINE
1.8 Rallye syncro	Petrol	118	08/88-07/91	1H, PG

Engine	Information	A10	A20	A40	A50	A70	C10 - C30	C20	E01
All engines							1.970.125	C10	1.965.007
									1.500.725

				ENGINE
1.8 Syncro	Petrol	62	08/87-07/88	RH

Engine	Information	A10	A20	A40	A50	A70	C10 - C30	C20	E01
All engines							1.970.125	C10	1.965.007
									1.500.725

				ENGINE
1.8 Syncro	Petrol	66	02/86-07/91	GU, GX

Engine	Information	A10	A20	A40	A50	A70	C10 - C30	C20	E01
All engines	version Bosch, ->ch. 19-G-990 000			1.306.094					
Eng. GU	version Bosch, ch. ...H-000 001 ->			1.306.266					
Eng. GU	version Ducellier			1.315.068	1.415.099R				
All engines	version Bosch				1.406.055R	1.906.219			
All engines	->ch. 1G-J-990000, ch. 1G-L-000 001 ->						1.970.125	C10	
Eng. GU	->ch. 1G-K-990 000, ch. 1G-K-000 001 ->						1.970.126	C10	
All engines									1.965.007
									1.500.725

				ENGINE
1.8 Syncro	Petrol	72	08/88-07/91	3E82

Engine	Information	A10	A20	A40	A50	A70	C10 - C30	C20	E01
All engines	version Bosch			1.306.266	1.406.121R				
All engines	ch. 1G-L-000 001 ->						1.970.125	C10	
All engines	->ch. 1G-K-990 000						1.970.126	C10	
All engines									1.965.007
									1.500.725

				ENGINE
1.8i GTI [CHE] [SWE]	Petrol	82	01/84-07/87	GZ

Engine	Information	A10	A20	A40	A50	A70	C10 - C30	C20	E01
All engines	version Bosch, ->year 31/07/86			1.306.094					
All engines	version Bosch, 01/08/86 ->			1.306.266					
All engines	version Bosch, 01/08/85 ->				1.406.055R				
All engines	version Bosch, ->year 31/07/85				1.406.116R				
All engines	version Bosch					1.906.219			
All engines	ch. 19-E-855 001 ->						1.970.125	C10	1.500.725
All engines	->ch. 19-E-855 000						1.970.132	C10	1.500.727
All engines									1.965.007

				ENGINE
1.8i GTI [SWE]	Petrol	82	08/87-07/88	GZ

Engine	Information	A10	A20	A40	A50	A70	C10 - C30	C20	E01
All engines	version Bosch, 01/08/86 ->			1.306.266					
All engines	version Bosch, 01/08/85 ->				1.406.055R				
All engines	version Bosch					1.906.219			
All engines	ch. 19-E-855 001 ->						1.970.125	C10	1.500.725
All engines	->ch. 19-E-855 000						1.970.132	C10	1.500.727
All engines									1.965.007

GOLF III

				ENGINE
1.4	Petrol	40	11/91-04/99	ABD, AEX

Engine	Information	A10	A20	A40	A50	A70	C10 - C30	C20	E01
All engines	version Bosch, 01/08/94 ->			1.306.094					
Eng. ABD	version Bosch, ->year 31/07/94			1.306.266					
Eng. AEX	version Marelli			1.330.116	1.430.057R	1.930.182			

A10 CONDENSER	A20 CONTACT SET	A40 DISTRIBUTOR CAP	A50 ROTOR	A70 PICK-UP
C10 COIL	C20 IGNITION MODULE	C30 ELECTRONIC IGNITION KIT	E01 IGNITION CABLE SET	

Vehicle	alim.	kW	Date	Engine	FUNCTIONS ON THE VEHICLE							
					A10	A20	A40	A50	A70	C10 - C30	C20	E01

GOLF III				ENGINE
1.4	Petrol	40	11/91-04/99	ABD, AEX

Engine	Information	A10	A20	A40	A50	A70	C10 - C30	C20	E01
All engines	version Bosch				1.406.121R	1.906.223			
All engines							1.990.414	C30	
Eng. ABD	ch. 1H-P-640 001 ->								1.500.493
Eng. AEX									1.501.671

				ENGINE
1.4	Petrol	44	10/91-04/99	ABD, AEX

Engine	Information	A10	A20	A40	A50	A70	C10 - C30	C20	E01
All engines	version Bosch, 01/08/94 ->			1.306.094					
Eng. ABD	version Bosch, ->year 31/07/94			1.306.266					
Eng. AEX	version Marelli			1.330.116	1.430.057R	1.930.182			
All engines	version Bosch				1.406.121R	1.906.223			
All engines							1.990.414	C30	
Eng. ABD	ch. 1H-P-640 001 ->								1.500.493
Eng. AEX									1.501.671

				ENGINE
1.6	Petrol	55	09/92-08/97	ABU, AEA, AEE

Engine	Information	A10	A20	A40	A50	A70	C10 - C30	C20	E01
All engines	version Bosch, 01/08/94 ->			1.306.094					
Eng. ABU	version Bosch, ->year 31/07/94			1.306.266					
Eng. AEE	version Marelli			1.330.116	1.430.057R	1.930.182			
All engines	version Bosch				1.406.121R	1.906.223			
All engines							1.990.414	C30	
Eng. ABU	01/08/94 ->								1.500.493
Eng. ABU, AEA	ch. 1H-P-640 001 ->, ->year 31/07/94								1.501.364
Eng. AEE	no specific info conc. application available								1.501.609

				ENGINE
1.6	Petrol	74	07/94-04/99	AEK, AFT, AKS

Engine	Information	A10	A20	A40	A50	A70	C10 - C30	C20	E01
All engines	version Bosch			1.306.266	1.406.121R	1.906.223			
Eng. AEK	version Ducellier			1.315.068	1.415.099R				
All engines							1.990.414	C30	
Eng. AEK									1.501.551
Eng. AFT	->year 31/05/96								1.501.933
Eng. AFT, AKS	01/06/96 ->								1.501.937

				ENGINE
1.8	Petrol	55	08/91-04/99	AAM

Engine	Information	A10	A20	A40	A50	A70	C10 - C30	C20	E01
All engines	version Bosch			1.306.266	1.406.121R	1.906.223			
All engines	version Ducellier			1.315.068	1.415.099R				
All engines							1.990.414	C30	
All engines	->year 31/07/94								1.500.725
All engines	convertible								1.500.965
All engines	01/08/94 ->								1.501.549

				ENGINE
1.8	Petrol	66	08/91-04/99	ABS, ACC, ADZ

Engine	Information	A10	A20	A40	A50	A70	C10 - C30	C20	E01
Eng. ABS, ADZ	version Bosch			1.306.266	1.406.121R	1.906.223			
Eng. ABS, ADZ	version Ducellier			1.315.068	1.415.099R				
All engines							1.990.414	C30	
Eng. ABS, ADZ	convertible								1.500.725
Eng. ADZ									1.501.549

				ENGINE
1.8 Syncro	Petrol	66	01/93-04/99	ABS, ADZ

Engine	Information	A10	A20	A40	A50	A70	C10 - C30	C20	E01
All engines	version Bosch			1.306.266	1.406.121R				
All engines	version Ducellier			1.315.068	1.415.099R				
All engines							1.990.414	C30	
Eng. ABS									1.500.725
Eng. ADZ									1.501.549

A10 CONDENSER	A20 CONTACT SET	A40 DISTRIBUTOR CAP	A50 ROTOR	A70 PICK-UP
C10 COIL	C20 IGNITION MODULE	C30 ELECTRONIC IGNITION KIT	E01 IGNITION CABLE SET	

The present application list is a brief version. For the detailed information about the possibility of installation on a specific vehicle, please refer to our web-catalogue <http://catalogo.facet.eu/>

Vehicle	alim.	kW	Date	Engine	FUNCTIONS ON THE VEHICLE							
					A10	A20	A40	A50	A70	C10 - C30	C20	E01

				ENGINE
2.0	Petrol	79	08/95-04/96	AEP

Engine	Information	A10	A20	A40	A50	A70	C10 - C30	C20	E01
All engines	version Bosch			1.306.266	1.406.121R	1.906.223			
All engines	version Ducellier			1.315.068	1.415.099R				
All engines							1.990.414	C30	1.501.549

				ENGINE
2.0	Petrol	85	11/91-04/99	2E, ADY, AGG, AKR

Engine	Information	A10	A20	A40	A50	A70	C10 - C30	C20	E01
All engines	version Bosch			1.306.266	1.406.121R				
Eng. ADY, AGG, AKR	version Ducellier			1.315.068	1.415.099R				
Eng. ADY, AGG, AKR	version Bosch					1.906.223			
All engines							1.990.414	C30	
Eng. 2E									1.500.965
Eng. ADY, AGG, AKR									1.501.549

				ENGINE
2.0 GL	Petrol	79	08/95-09/97	AEP

Engine	Information	A10	A20	A40	A50	A70	C10 - C30	C20	E01
All engines	version Bosch			1.306.266	1.406.121R	1.906.223			
All engines	version Ducellier			1.315.068	1.415.099R				
All engines							1.990.414	C30	1.501.549

				ENGINE
2.0 GTI 16V	Petrol	110	08/92-08/97	ABF

Engine	Information	A10	A20	A40	A50	A70	C10 - C30	C20	E01
All engines	version Bosch			1.306.263		1.906.223			
All engines							1.990.414	C30	

				ENGINE
2.0 Syncro	Petrol	85	08/95-04/99	AGG

Engine	Information	A10	A20	A40	A50	A70	C10 - C30	C20	E01
All engines	version Bosch			1.306.266	1.406.121R	1.906.223			
All engines							1.990.414	C30	1.501.549

				ENGINE
2.8 VR6	Petrol	120	08/95-09/97	AAA

Engine	Information	A10	A20	A40	A50	A70	C10 - C30	C20	E01
All engines	version Bosch, ->ch. 1H-PB060 000, ->ch. 1H-PW480 000			1.306.233					
All engines	version Bosch, ->ch. 1H-NB060 000, ->ch. 1H-NW300 000				1.406.148R				
All engines	version Bosch, ch. 1H-NB060 001 ->, ch. 1H-NW300 000 ->, ->ch. 1H-PB060 000, ->ch. 1H-PW480 000				1.406.149R				
All engines	->ch. 1H-PB060 000, ->ch. 1H-PW480 000						1.970.269	C10	

				ENGINE
2.8 VR6	Petrol	128	01/92-08/97	AAA

Engine	Information	A10	A20	A40	A50	A70	C10 - C30	C20	E01
All engines	version Bosch, ->ch. 1H-PB060 000, ->ch. 1H-PW480 000			1.306.233					
All engines	version Bosch, ->ch. 1H-NB060 000, ->ch. 1H-NW300 000				1.406.148R				
All engines	version Bosch, ch. 1H-NB060 001 ->, ch. 1H-NW300 000 ->, ->ch. 1H-PB060 000, ->ch. 1H-PW480 000				1.406.149R				
All engines	->ch. 1H-PB060 000, ->ch. 1H-PW480 000						1.970.269	C10	

GOLF IV

				ENGINE
1.4	Petrol	55	05/00-06/06	AXP, BCA

Engine	Information	A10	A20	A40	A50	A70	C10 - C30	C20	E01
Eng. BCA	x 4, COIL ON PLUG, incl. spark plug connector						1.970.474	C10	
Eng. AXP							1.990.420	C30	

				ENGINE
1.4 16V	Petrol	55	10/97-06/06	AHW, AKQ, APE, AXP, BCA

Engine	Information	A10	A20	A40	A50	A70	C10 - C30	C20	E01
Eng. BCA	x 4, COIL ON PLUG, incl. spark plug connector						1.970.474	C10	
Eng. AHW, AKQ, APE, AXP							1.990.420	C30	1.501.575

A10 CONDENSER	A20 CONTACT SET	A40 DISTRIBUTOR CAP	A50 ROTOR	A70 PICK-UP
C10 COIL	C20 IGNITION MODULE	C30 ELECTRONIC IGNITION KIT	E01 IGNITION CABLE SET	

Vehicle	alim.	kW	Date	Engine	FUNCTIONS ON THE VEHICLE								
					A10	A20	A40	A50	A70	C10 - C30	C20	E01	
1.6	Petrol	74	08/97-05/04	ENGINE AEH, AFT, AKL, AKS, APF									
Engine	Information			A10	A20	A40	A50	A70	C10 - C30	C20	E01		
Eng. AFT, AKS	version Bosch					1.306.266	1.406.121R	1.906.223					
Eng. AFT, AKS									1.990.414	C30		1.501.932	
Eng. AEH, AKL									1.990.420	C30			
Eng. AEH, AKL, APF									1.990.420	C30			
Eng. AEH, AKL	->ch. 1J-W-050 000											1.501.479	
Eng. AEH, AKL, APF	ch. 1J-W-050 001 ->											1.501.484	
1.6	Petrol	75	08/00-06/06	ENGINE AVU, BFQ									
Engine	Information			A10	A20	A40	A50	A70	C10 - C30	C20	E01		
All engines									1.990.420	C30		1.501.585	
1.6	Petrol	77	05/00-06/06	ENGINE AUS, AZD, BCB									
Engine	Information			A10	A20	A40	A50	A70	C10 - C30	C20	E01		
Eng. AZD, BCB	x 4, COIL ON PLUG, incl. spark plug connector								1.970.474	C10			
Eng. AUS									1.990.420	C30			
1.6 16V	Petrol	77	02/00-06/06	ENGINE ATN, AUS, AZD, BCB									
Engine	Information			A10	A20	A40	A50	A70	C10 - C30	C20	E01		
Eng. AZD, BCB	x 4, COIL ON PLUG, incl. spark plug connector								1.970.474	C10			
Eng. ATN, AUS									1.990.420	C30		1.501.575	
1.6 FSI	Petrol	81	01/02-06/06	ENGINE BAD									
Engine	Information			A10	A20	A40	A50	A70	C10 - C30	C20	E01		
All engines	x 4, COIL ON PLUG, incl. spark plug connector								1.970.474	C10			
1.6 FSI	Petrol	85	10/03-07/04	ENGINE BAG									
Engine	Information			A10	A20	A40	A50	A70	C10 - C30	C20	E01		
All engines	Qty: 4								1.970.474	C10			
1.8	Petrol	55	06/98-06/02	ENGINE AAM, ANN									
Engine	Information			A10	A20	A40	A50	A70	C10 - C30	C20	E01		
All engines	version Bosch					1.306.266	1.406.121R						
All engines									1.990.414	C30		1.501.549	
1.8	Petrol	66	06/98-06/02	ENGINE ADZ, ANP									
Engine	Information			A10	A20	A40	A50	A70	C10 - C30	C20	E01		
All engines	version Bosch					1.306.266	1.406.121R						
Eng. ANP									1.990.414	C30		1.501.549	
Eng. ADZ									1.990.414	C30			
1.8	Petrol	92	08/97-06/05	ENGINE AGN									
Engine	Information			A10	A20	A40	A50	A70	C10 - C30	C20	E01		
All engines									1.990.420	C30		1.501.489	
1.8 4motion	Petrol	92	05/98-06/06	ENGINE AGN									
Engine	Information			A10	A20	A40	A50	A70	C10 - C30	C20	E01		
All engines									1.990.420	C30		1.501.489	
1.8 T	Petrol	110	08/97-06/06	ENGINE AGU, ARZ, AUM									
Engine	Information			A10	A20	A40	A50	A70	C10 - C30	C20	E01		
Eng. AGU	x 4, COIL ON PLUG								1.970.354S	C10			
Eng. AUM	01/01/02 ->, x 4, COIL ON PLUG, incl. spark plug connector								1.970.429	C10			
Eng. ARZ, AUM	->year 01/12/01, x 4, COIL ON PLUG, x 4, COIL ON PLUG, incl. spark plug connector, incl. spark plug connector								1.970.445	C10			
Eng. AGU												1.965.076	

A10	CONDENSER	A20	CONTACT SET	A40	DISTRIBUTOR CAP	A50	ROTOR	A70	PICK-UP
C10	COIL	C20	IGNITION MODULE	C30	ELECTRONIC IGNITION KIT	E01	IGNITION CABLE SET		

The present application list is a brief version. For the detailed information about the possibility of installation on a specific vehicle, please refer to our web-catalogue <http://catalogo.facet.eu/>

Vehicle	alim.	kW	Date	Engine	FUNCTIONS ON THE VEHICLE							
					A10	A20	A40	A50	A70	C10 - C30	C20	E01
ENGINE												
1.8 T GTI	Petrol	132	08/01-06/05	AUQ								
Engine	Information			A10	A20	A40	A50	A70	C10 - C30	C20	E01	
All engines	01/01/02 ->, x 4, COIL ON PLUG, incl. spark plug connector								1.970.429	C10		
All engines	->year 01/12/01, x 4, COIL ON PLUG, incl. spark plug connector								1.970.445	C10		
ENGINE												
2.0	Petrol	85	06/98-06/06	AGG, AKR, APK, AQY, ATU, AWF, AWG, AZG, AZJ								
Engine	Information			A10	A20	A40	A50	A70	C10 - C30	C20	E01	
Eng. AGG, AKR, ATU, AWF, AWG	version Bosch					1.306.266	1.406.121R					
Eng. AGG, AKR	version Ducellier					1.315.068	1.415.099R					
Eng. AGG, AKR, AWF, AWG	version Bosch							1.906.223				
Eng. AGG, AKR, ATU, AWF, AWG									1.990.414	C30		
Eng. APK, AQY									1.990.420	C30	1.501.585	
Eng. AZG, AZJ											1.499.223	
ENGINE												
2.0 4motion	Petrol	85	10/00-06/06	AZH, AZJ								
Engine	Information			A10	A20	A40	A50	A70	C10 - C30	C20	E01	
Eng. AZH									1.990.420	C30	1.501.585	
Eng. AZJ											1.499.223	
ENGINE												
2.0 Bi-Fuel	Petrol/ Com- pressed Natural Gas (CNG)	85	02/02-06/06	BEH								
Engine	Information			A10	A20	A40	A50	A70	C10 - C30	C20	E01	
All engines											1.499.223	
ENGINE												
2.3 V5	Petrol	110	08/97-06/06	AGZ								
Engine	Information			A10	A20	A40	A50	A70	C10 - C30	C20	E01	
All engines										1.965.074		
ENGINE												
2.3 V5	Petrol	125	10/00-06/06	AQN								
Engine	Information			A10	A20	A40	A50	A70	C10 - C30	C20	E01	
All engines	x 5, COIL ON PLUG								1.970.435	C10		
ENGINE												
2.3 V5 4motion	Petrol	110	12/98-06/06	AGZ								
Engine	Information			A10	A20	A40	A50	A70	C10 - C30	C20	E01	
All engines										1.965.074		
ENGINE												
2.3 V5 4motion	Petrol	125	10/00-06/06	AQN								
Engine	Information			A10	A20	A40	A50	A70	C10 - C30	C20	E01	
All engines	x 5, COIL ON PLUG								1.970.435	C10		
ENGINE												
2.8 V6 4motion	Petrol	150	05/99-06/06	AUE, BDE								
Engine	Information			A10	A20	A40	A50	A70	C10 - C30	C20	E01	
All engines	01/05/01 ->, x 6, ch. 1J2000001 ->, COIL ON PLUG, x 6, COIL ON PLUG								1.970.435	C10		
ENGINE												
2.8 VR6 4motion	Petrol	150	03/99-06/05	AUE, BDE								
Engine	Information			A10	A20	A40	A50	A70	C10 - C30	C20	E01	
All engines	01/05/01 ->, x 6, ch. 1J2000001 ->, COIL ON PLUG, x 6, COIL ON PLUG								1.970.435	C10		
ENGINE												
3.2 R32 4motion	Petrol	177	09/02-06/05	BFH, BML								
Engine	Information			A10	A20	A40	A50	A70	C10 - C30	C20	E01	
All engines	x 6, COIL ON PLUG								1.970.434	C10		

A10 CONDENSER	A20 CONTACT SET	A40 DISTRIBUTOR CAP	A50 ROTOR	A70 PICK-UP
C10 COIL	C20 IGNITION MODULE	C30 ELECTRONIC IGNITION KIT	E01 IGNITION CABLE SET	

Vehicle	alim.	kW	Date	Engine	FUNCTIONS ON THE VEHICLE									
					A10	A20	A40	A50	A70	C10 - C30	C20	E01		
GOLF PLUS														
1.2 TSi	Petrol	77	11/09-08/14	CBZB										
Engine	Information				A10	A20	A40	A50	A70	C10 - C30	C20	E01		
All engines										1.990.420	C30			
1.4 TSi	Petrol	118	01/09-09/12	CAVD										
Engine	Information				A10	A20	A40	A50	A70	C10 - C30	C20	E01		
All engines	x 4, COIL ON PLUG, incl. spark plug connector									1.970.474	C10			
1.4 TSi	Petrol	90	01/09-08/14	CAXA										
Engine	Information				A10	A20	A40	A50	A70	C10 - C30	C20	E01		
All engines	x 4, COIL ON PLUG, incl. spark plug connector									1.970.474	C10			
GOLF V														
1.2 TSi	Petrol	63	05/10-12/13	CBZA										
Engine	Information				A10	A20	A40	A50	A70	C10 - C30	C20	E01		
All engines										1.990.420	C30			
1.2 TSi	Petrol	77	11/09-12/13	CBZB										
Engine	Information				A10	A20	A40	A50	A70	C10 - C30	C20	E01		
All engines										1.990.420	C30			
1.4	Petrol	59	06/07-07/09	BUD										
Engine	Information				A10	A20	A40	A50	A70	C10 - C30	C20	E01		
All engines	x 4, COIL ON PLUG, incl. spark plug connector									1.970.474	C10			
1.4 16V	Petrol	55	10/03-11/06	BCA										
Engine	Information				A10	A20	A40	A50	A70	C10 - C30	C20	E01		
All engines	x 4, COIL ON PLUG, incl. spark plug connector									1.970.474	C10			
1.4 16V	Petrol	59	05/06-12/13	BUD, CGGA										
Engine	Information				A10	A20	A40	A50	A70	C10 - C30	C20	E01		
All engines	x 4, COIL ON PLUG, incl. spark plug connector									1.970.474	C10			
1.4 FSi	Petrol	66	10/03-11/06	BKG, BLN										
Engine	Information				A10	A20	A40	A50	A70	C10 - C30	C20	E01		
All engines	x 4, COIL ON PLUG, incl. spark plug connector									1.970.474	C10			
1.4 TSi	Petrol	103	05/06-07/09	BMY										
Engine	Information				A10	A20	A40	A50	A70	C10 - C30	C20	E01		
All engines	x 4, COIL ON PLUG, incl. spark plug connector									1.970.474	C10			
1.4 TSi	Petrol	118	06/08-12/13	CAVD, CNWA, CTHD										
Engine	Information				A10	A20	A40	A50	A70	C10 - C30	C20	E01		
All engines	x 4, COIL ON PLUG, incl. spark plug connector									1.970.474	C10			
1.4 TSi	Petrol	125	11/05-07/09	BLG										
Engine	Information				A10	A20	A40	A50	A70	C10 - C30	C20	E01		
All engines	x 4, COIL ON PLUG, incl. spark plug connector									1.970.474	C10			
1.4 TSi	Petrol	90	05/07-12/13	CAXA										
Engine	Information				A10	A20	A40	A50	A70	C10 - C30	C20	E01		
All engines	x 4, COIL ON PLUG, incl. spark plug connector									1.970.474	C10			
1.6	Natural Gas	75	11/08->	CHGA										
Engine	Information				A10	A20	A40	A50	A70	C10 - C30	C20	E01		
All engines										1.990.420	C30		1.501.585	
All engines										1.990.420	C30			
Eng. BGU										1.990.420	C30			

A10 CONDENSER	A20 CONTACT SET	A40 DISTRIBUTOR CAP	A50 ROTOR	A70 PICK-UP
C10 COIL	C20 IGNITION MODULE	C30 ELECTRONIC IGNITION KIT	E01 IGNITION CABLE SET	

The present application list is a brief version. For the detailed information about the possibility of installation on a specific vehicle, please refer to our web-catalogue <http://catalogo.facet.eu/>

Vehicle	alim.	kW	Date	Engine	FUNCTIONS ON THE VEHICLE							
					A10	A20	A40	A50	A70	C10 - C30	C20	E01

ENGINE				
1.6	Natural Gas	75	11/08->	CHGA

Engine	Information	A10	A20	A40	A50	A70	C10 - C30	C20	E01
Eng. BGU, BSE, BSF, CCSA									1.501.585

ENGINE				
1.6 BiFuel	Petrol/Liquified Petro-leum Gas (LPG)	75	05/09-12/13	CHGA

Engine	Information	A10	A20	A40	A50	A70	C10 - C30	C20	E01
All engines							1.990.420	C30	

ENGINE				
1.6 FSI	Petrol	85	10/03-07/08	BAG, BLF, BLP

Engine	Information	A10	A20	A40	A50	A70	C10 - C30	C20	E01
All engines	x 4, COIL ON PLUG, incl. spark plug connector						1.970.474	C10	

ENGINE				
1.6 MultiFuel	Petrol/Ethanol	75	10/07-12/13	CCSA, CMXA

Engine	Information	A10	A20	A40	A50	A70	C10 - C30	C20	E01
All engines							1.990.420	C30	
Eng. CCSA									1.501.585

ENGINE				
2.0	Petrol	85	01/05-11/08	BHY

Engine	Information	A10	A20	A40	A50	A70	C10 - C30	C20	E01
All engines							1.990.420	C30	1.501.585

ENGINE				
2.0 FSI	Petrol	110	01/04-11/08	AXW, BLR, BLX, BLY, BVX, BVY, BVZ

Engine	Information	A10	A20	A40	A50	A70	C10 - C30	C20	E01
All engines	x 4, ELDOR, Housing Colour:Black, COIL ON PLUG, incl. spark plug connector						1.970.426	C10	

ENGINE				
2.0 FSI 4motion	Petrol	110	08/04-11/08	BLX, BVX

Engine	Information	A10	A20	A40	A50	A70	C10 - C30	C20	E01
All engines	x 4, ELDOR, Housing Colour:Black, COIL ON PLUG, incl. spark plug connector						1.970.426	C10	

ENGINE				
2.0 GTI	Petrol	147	10/04-02/09	AXX, BPY, BWA, CAWB, CBFA

Engine	Information	A10	A20	A40	A50	A70	C10 - C30	C20	E01
All engines	x 4, ELDOR, Housing Colour:Black, COIL ON PLUG, incl. spark plug connector						1.970.426	C10	

ENGINE				
2.0 GTI	Petrol	169	09/06-12/08	BYD

Engine	Information	A10	A20	A40	A50	A70	C10 - C30	C20	E01
All engines	x 4, ELDOR, Housing Colour:Black, COIL ON PLUG, incl. spark plug connector						1.970.426	C10	

ENGINE				
2.0 TFSI	Petrol	147	06/07-07/09	BWA, CAWB

Engine	Information	A10	A20	A40	A50	A70	C10 - C30	C20	E01
All engines	x 4, ELDOR, Housing Colour:Black, COIL ON PLUG, incl. spark plug connector						1.970.426	C10	

ENGINE				
2.5	Petrol	125	05/07-11/08	CBTA, CBUA

Engine	Information	A10	A20	A40	A50	A70	C10 - C30	C20	E01
All engines	Qty: 5						1.970.426	C10	

ENGINE				
3.2 R32 4motion	Petrol	184	11/05-11/08	BUB

Engine	Information	A10	A20	A40	A50	A70	C10 - C30	C20	E01
All engines	x 6, COIL ON PLUG						1.970.434	C10	

GOLF VI				
1.2 TSI	Petrol	63	05/10->	CBZA









Engine	Information	A10	A20	A40	A50	A70	C10 - C30	C20	E01
All engines							1.990.420	C30	1.499.248

A10	CONDENSER	A20	CONTACT SET	A40	DISTRIBUTOR CAP	A50	ROTOR	A70	PICK-UP
C10	COIL	C20	IGNITION MODULE	C30	ELECTRONIC IGNITION KIT	E01	IGNITION CABLE SET		

Vehicle	alim.	kW	Date	Engine	FUNCTIONS ON THE VEHICLE							
					A10	A20	A40	A50	A70	C10 - C30	C20	E01
ENGINE												
1.2 TSI	Petrol	77	11/08->	CBZB								
Engine	Information			A10	A20	A40	A50	A70	C10 - C30	C20	E01	
All engines									1.990.420	C30	1.499.248	
ENGINE												
1.2 TSI 16V	Petrol	77	11/13-05/16	CJZA, CVVD								
Engine	Information			A10	A20	A40	A50	A70	C10 - C30	C20	E01	
All engines	x 4, BERU, ELDOR, COIL ON PLUG, incl. spark plug connector, Number of pins:4, incl. spark plug connector								1.970.599	C10		
ENGINE												
1.2 Tsi BlueMotion	Petrol	77	05/09-11/12	CBZB								
Engine	Information			A10	A20	A40	A50	A70	C10 - C30	C20	E01	
All engines									1.990.420	C30		
ENGINE												
1.4	Petrol	118	04/11-05/12	CNWA								
Engine	Information			A10	A20	A40	A50	A70	C10 - C30	C20	E01	
All engines	Qty: 4								1.970.474	C10		
ENGINE												
1.4	Petrol	59	10/08->	BUD, CGGA								
Engine	Information			A10	A20	A40	A50	A70	C10 - C30	C20	E01	
All engines	Qty: 4, Qty: 4								1.970.474	C10		
All engines	x 4, COIL ON PLUG, incl. spark plug connector								1.970.474	C10		
ENGINE												
1.4 16V	Petrol	59	01/09-05/11	BUD, CGGA								
Engine	Information			A10	A20	A40	A50	A70	C10 - C30	C20	E01	
All engines	Qty: 4, Qty: 4								1.970.474	C10		
ENGINE												
1.4 TSI	Petrol	110	11/13-05/16	CZDA								
Engine	Information			A10	A20	A40	A50	A70	C10 - C30	C20	E01	
All engines	x 4, BERU, ELDOR, COIL ON PLUG, incl. spark plug connector, Number of pins:4, incl. spark plug connector								1.970.599	C10		
ENGINE												
1.4 Tsi	Petrol	118	10/08->	CAVD, CNWA, CTHD, CTKA								
Engine	Information			A10	A20	A40	A50	A70	C10 - C30	C20	E01	
All engines	Qty: 4								1.970.474	C10		
All engines	x 4, COIL ON PLUG, x 4, COIL ON PLUG, incl. spark plug connector, incl. spark plug connector								1.970.474	C10		
ENGINE												
1.4 TSI	Petrol	90	10/08->	CAXA								
Engine	Information			A10	A20	A40	A50	A70	C10 - C30	C20	E01	
All engines	Qty: 4								1.970.474	C10		
All engines	x 4, COIL ON PLUG, incl. spark plug connector								1.970.474	C10		
ENGINE												
1.4 TSI	Petrol	92	11/13-05/16	CZCA								
Engine	Information			A10	A20	A40	A50	A70	C10 - C30	C20	E01	
All engines	x 4, BERU, ELDOR, COIL ON PLUG, incl. spark plug connector, Number of pins:4, incl. spark plug connector								1.970.599	C10		
ENGINE												
1.6	Petrol	75	10/08->	BSE, BSF, CCSA, CMXA								
Engine	Information			A10	A20	A40	A50	A70	C10 - C30	C20	E01	
All engines									1.990.420	C30	1.501.585	
ENGINE												
1.6 BiFuel	Natural Gas	75	05/11->	CHGA								
Engine	Information			A10	A20	A40	A50	A70	C10 - C30	C20	E01	
All engines									1.990.420	C30	1.501.585	
All engines									1.990.420	C30		
Eng. CHGA											1.501.585	
ENGINE												
1.6 MultiFuel	Natural Gas	75	05/09->	CHGA								
Engine	Information			A10	A20	A40	A50	A70	C10 - C30	C20	E01	
All engines									1.990.420	C30	1.501.585	
All engines									1.990.420	C30	1.501.585	

A10 CONDENSER	A20 CONTACT SET	A40 DISTRIBUTOR CAP	A50 ROTOR	A70 PICK-UP
C10 COIL	C20 IGNITION MODULE	C30 ELECTRONIC IGNITION KIT	E01 IGNITION CABLE SET	

The present application list is a brief version. For the detailed information about the possibility of installation on a specific vehicle, please refer to our web-catalogue <http://catalogo.facet.eu/>









				FUNCTIONS ON THE VEHICLE								
Vehicle	alim.	kW	Date	Engine								
				ENGINE								
1.8 TSI	Petrol	118	06/09-01/11	CDAA								
		Engine		Information	A10	A20	A40	A50	A70	C10 - C30	C20	E01
		All engines		x 4, ELDOR, Housing Colour:Black, COIL ON PLUG, incl. spark plug connector						1.970.426	C10	
				ENGINE								
2.0	Petrol	199	05/11->	CDLF								
		Engine		Information	A10	A20	A40	A50	A70	C10 - C30	C20	E01
		All engines		Qty: 4						1.970.426	C10	
				ENGINE								
2.0 GTi	Petrol	147	06/09-11/13	CBFA, CCTA								
		Engine		Information	A10	A20	A40	A50	A70	C10 - C30	C20	E01
		All engines		x 4, ELDOR, Housing Colour:Black, COIL ON PLUG, incl. spark plug connector						1.970.426	C10	
				ENGINE								
2.0 GTi	Petrol	155	02/09-05/16	CCZB								
		Engine		Information	A10	A20	A40	A50	A70	C10 - C30	C20	E01
		All engines		x 4, ELDOR, Housing Colour:Black, COIL ON PLUG, incl. spark plug connector						1.970.426	C10	
				ENGINE								
2.0 GTi	Petrol	173	05/11-11/12	CDLG								
		Engine		Information	A10	A20	A40	A50	A70	C10 - C30	C20	E01
		All engines		x 4, ELDOR, Housing Colour:Black, COIL ON PLUG, incl. spark plug connector						1.970.426	C10	
				ENGINE								
2.0 R	Petrol	195	01/13-05/16	CDLA								
		Engine		Information	A10	A20	A40	A50	A70	C10 - C30	C20	E01
		All engines		x 4, ELDOR, Housing Colour:Black, COIL ON PLUG, incl. spark plug connector						1.970.426	C10	
				ENGINE								
2.0 R 4motion	Petrol	188	11/09-11/13	CDLC								
		Engine		Information	A10	A20	A40	A50	A70	C10 - C30	C20	E01
		All engines		x 4, ELDOR, Housing Colour:Black, COIL ON PLUG, incl. spark plug connector						1.970.426	C10	
				ENGINE								
2.0 R 4motion	Petrol	199	11/09-11/12	CDLF								
		Engine		Information	A10	A20	A40	A50	A70	C10 - C30	C20	E01
		All engines		x 4, ELDOR, Housing Colour:Black, COIL ON PLUG, incl. spark plug connector						1.970.426	C10	
				ENGINE								
2.0 TFSi	Petrol	147	07/09-07/13	CCZA								
		Engine		Information	A10	A20	A40	A50	A70	C10 - C30	C20	E01
		All engines		x 4, ELDOR, Housing Colour:Black, COIL ON PLUG, incl. spark plug connector						1.970.426	C10	
				ENGINE								
2.0 TFSi	Petrol	188	11/11->	CRZA								
		Engine		Information	A10	A20	A40	A50	A70	C10 - C30	C20	E01
		All engines		Qty: 4						1.970.426	C10	
				ENGINE								
2.0 TFSi Gti	Petrol	147	05/11->	CBFA, CCTA								
		Engine		Information	A10	A20	A40	A50	A70	C10 - C30	C20	E01
		All engines		Qty: 4, version BOSCH						1.970.426	C10	
				ENGINE								
2.0 TFSi Gti	Petrol	155	05/11->	CCZB								
		Engine		Information	A10	A20	A40	A50	A70	C10 - C30	C20	E01
		All engines		Qty: 4, version BOSCH						1.970.426	C10	
				ENGINE								
2.0 TFSi Gti	Petrol	173	05/11->	CDLG								
		Engine		Information	A10	A20	A40	A50	A70	C10 - C30	C20	E01
		All engines		Qty: 4						1.970.426	C10	
				ENGINE								
2.0 TSI	Petrol	188	01/13->	CDLC								
		Engine		Information	A10	A20	A40	A50	A70	C10 - C30	C20	E01
		All engines		Qty: 4						1.970.426	C10	

A10 CONDENSER	A20 CONTACT SET	A40 DISTRIBUTOR CAP	A50 ROTOR	A70 PICK-UP
C10 COIL	C20 IGNITION MODULE	C30 ELECTRONIC IGNITION KIT	E01 IGNITION CABLE SET	

Vehicle	alim.	kW	Date	Engine	FUNCTIONS ON THE VEHICLE							
					A10	A20	A40	A50	A70	C10 - C30	C20	E01
ENGINE												
2.0 TSi R 4motion	Petrol	199	11/09-11/12	CDLF								
Engine	Information			A10	A20	A40	A50	A70	C10 - C30	C20	E01	
All engines	x 4, ELDOR, Housing Colour:Black, COIL ON PLUG, incl. spark plug connector								1.970.426	C10		
ENGINE												
2.5	Petrol	125	07/09->	CBTA, CBUA								
Engine	Information			A10	A20	A40	A50	A70	C10 - C30	C20	E01	
All engines	Qty: 5								1.970.426	C10		
All engines	x 5, ELDOR, Housing Colour:Black, COIL ON PLUG, incl. spark plug connector								1.970.426	C10		
ENGINE												
TSi	Petrol	90	10/08-11/12	CAXA								
Engine	Information			A10	A20	A40	A50	A70	C10 - C30	C20	E01	
All engines	x 4, COIL ON PLUG, incl. spark plug connector								1.970.474	C10		
GOLF VII												
ENGINE												
1.0 TSI	Petrol	63	01/17->	CHZK, DKLB								
Engine	Information			A10	A20	A40	A50	A70	C10 - C30	C20	E01	
All engines	x 3, BERU, ELDOR, HITACHI, COIL ON PLUG, incl. spark plug connector, Number of pins:4, incl. spark plug connector								1.970.599	C10		
ENGINE												
1.0 TSI	Petrol	81	11/16->	CHZC								
Engine	Information			A10	A20	A40	A50	A70	C10 - C30	C20	E01	
All engines	x 3, BERU, ELDOR, HITACHI, COIL ON PLUG, incl. spark plug connector, Number of pins:4, incl. spark plug connector								1.970.599	C10		
ENGINE												
1.0 TSI	Petrol	85	05/15->	CHZD, DKRF								
Engine	Information			A10	A20	A40	A50	A70	C10 - C30	C20	E01	
All engines	x 3, BERU, ELDOR, HITACHI, COIL ON PLUG, incl. spark plug connector, Number of pins:4, incl. spark plug connector								1.970.599	C10		
ENGINE												
1.2 TSI	Petrol	63	08/12->	CJZB, CVVA								
Engine	Information			A10	A20	A40	A50	A70	C10 - C30	C20	E01	
All engines	x 4, BERU, ELDOR, COIL ON PLUG, incl. spark plug connector, Number of pins:4, incl. spark plug connector								1.970.599	C10		
ENGINE												
1.2 TSI	Petrol	77	11/12->	CJZA								
Engine	Information			A10	A20	A40	A50	A70	C10 - C30	C20	E01	
All engines	x 4, BERU, ELDOR, COIL ON PLUG, incl. spark plug connector, Number of pins:4, incl. spark plug connector								1.970.599	C10		
ENGINE												
1.2 TSI	Petrol	81	04/14->	CVVB								
Engine	Information			A10	A20	A40	A50	A70	C10 - C30	C20	E01	
All engines	x 4, BERU, ELDOR, COIL ON PLUG, incl. spark plug connector, Number of pins:4, incl. spark plug connector								1.970.599	C10		
ENGINE												
1.2 TSi BlueMotion	Petrol	63	08/12->	CJZB, CVVA								
Engine	Information			A10	A20	A40	A50	A70	C10 - C30	C20	E01	
All engines	x 4, BERU, ELDOR, COIL ON PLUG, incl. spark plug connector, Number of pins:4, incl. spark plug connector								1.970.599	C10		
ENGINE												
1.2 TSi BlueMotion	Petrol	77	11/12->	CJZA								
Engine	Information			A10	A20	A40	A50	A70	C10 - C30	C20	E01	
All engines	x 4, BERU, ELDOR, COIL ON PLUG, incl. spark plug connector, Number of pins:4, incl. spark plug connector								1.970.599	C10		
ENGINE												
1.4 GTE Hybrid	Petrol/ Electric	110	05/14->	CUKB, DGEA								
Engine	Information			A10	A20	A40	A50	A70	C10 - C30	C20	E01	
All engines	x 4, BERU, ELDOR, HITACHI, COIL ON PLUG, incl. spark plug connector, Number of pins:4, incl. spark plug connector								1.970.599	C10		

A10	CONDENSER	A20	CONTACT SET	A40	DISTRIBUTOR CAP	A50	ROTOR	A70	PICK-UP
C10	COIL	C20	IGNITION MODULE	C30	ELECTRONIC IGNITION KIT	E01	IGNITION CABLE SET		

The present application list is a brief version. For the detailed information about the possibility of installation on a specific vehicle, please refer to our web-catalogue <http://catalogo.facet.eu/>

					FUNCTIONS ON THE VEHICLE							
Vehicle	alim.	kW	Date	Engine								
ENGINE												
1.4 TGI CNG	Petrol/ Compressed Natural Gas (CNG)	81	06/13->	CPWA, CZBA								
Engine	Information				A10	A20	A40	A50	A70	C10 - C30	C20	E01
All engines	x 4, BERU, ELDOR, HITACHI, x 4, BERU, COIL ON PLUG, ELDOR, COIL ON PLUG, incl. spark plug connector, Number of pins:4, incl. spark plug connector, Number of pins:4, incl. spark plug connector									1.970.599	C10	
ENGINE												
1.4 TSI	Petrol	103	08/12-03/17	CHPA, CPTA								
Engine	Information				A10	A20	A40	A50	A70	C10 - C30	C20	E01
All engines	x 4, BERU, ELDOR, COIL ON PLUG, incl. spark plug connector, Number of pins:4, incl. spark plug connector									1.970.599	C10	
ENGINE												
1.4 TSI	Petrol	110	02/14->	CHPB, CZDA, CZEA								
Engine	Information				A10	A20	A40	A50	A70	C10 - C30	C20	E01
All engines	x 4, BERU, ELDOR, HITACHI, x 4, BERU, COIL ON PLUG, ELDOR, COIL ON PLUG, incl. spark plug connector, Number of pins:4, incl. spark plug connector, Number of pins:4, incl. spark plug connector									1.970.599	C10	
Eng. CHPB	Qty: 4									1.970.599	C10	
ENGINE												
1.4 TSI	Petrol	90	11/12->	CMBA, CPVA, CXSA								
Engine	Information				A10	A20	A40	A50	A70	C10 - C30	C20	E01
Eng. CMBA, CXSA	x 4, BERU, ELDOR, COIL ON PLUG, incl. spark plug connector, Number of pins:4, incl. spark plug connector									1.970.599	C10	
Eng. CPVA	Qty: 4									1.970.599	C10	
ENGINE												
1.4 TSI	Petrol	92	04/14->	CPVB, CZCA, CZDD								
Engine	Information				A10	A20	A40	A50	A70	C10 - C30	C20	E01
Eng. CPVB, CZDD	Qty: 4									1.970.599	C10	
Eng. CZCA, CZDD	x 4, BERU, ELDOR, HITACHI, COIL ON PLUG, incl. spark plug connector, Number of pins:4, incl. spark plug connector									1.970.599	C10	
ENGINE												
1.4 TSi BlueMotion	Petrol	103	08/12->	CHPA								
Engine	Information				A10	A20	A40	A50	A70	C10 - C30	C20	E01
All engines	x 4, BERU, ELDOR, COIL ON PLUG, incl. spark plug connector, Number of pins:4, incl. spark plug connector									1.970.599	C10	
ENGINE												
1.4 TSi BlueMotion	Petrol	90	05/13->	CXSA								
Engine	Information				A10	A20	A40	A50	A70	C10 - C30	C20	E01
All engines	x 4, BERU, ELDOR, COIL ON PLUG, incl. spark plug connector, Number of pins:4, incl. spark plug connector									1.970.599	C10	
ENGINE												
1.4 TSI MultiFuel	Petrol/ Ethanol	90	04/13->	CPVA								
Engine	Information				A10	A20	A40	A50	A70	C10 - C30	C20	E01
All engines	x 4, BERU, ELDOR, COIL ON PLUG, incl. spark plug connector, Number of pins:4, incl. spark plug connector									1.970.599	C10	
ENGINE												
1.4 TSI MultiFuel	Petrol/ Ethanol	92	12/13->	CPVB								
Engine	Information				A10	A20	A40	A50	A70	C10 - C30	C20	E01
All engines	x 4, BERU, ELDOR, HITACHI, COIL ON PLUG, incl. spark plug connector, Number of pins:4, incl. spark plug connector									1.970.599	C10	
ENGINE												
1.6	Petrol	81	05/14->	CWVA								
Engine	Information				A10	A20	A40	A50	A70	C10 - C30	C20	E01
All engines	x 4, BERU, ELDOR, COIL ON PLUG, incl. spark plug connector, Number of pins:4, incl. spark plug connector									1.970.599	C10	
ENGINE												
1.8 TSI 4motion	Petrol	132	12/14->	CJSB								
Engine	Information				A10	A20	A40	A50	A70	C10 - C30	C20	E01
All engines	x 4, HITACHI, COIL ON PLUG, incl. spark plug connector									1.970.636	C10	

A10 CONDENSER	A20 CONTACT SET	A40 DISTRIBUTOR CAP	A50 ROTOR	A70 PICK-UP
C10 COIL	C20 IGNITION MODULE	C30 ELECTRONIC IGNITION KIT	E01 IGNITION CABLE SET	

Vehicle	alim.	kW	Date	Engine	FUNCTIONS ON THE VEHICLE							
					A10	A20	A40	A50	A70	C10 - C30	C20	E01
ENGINE												
2.0 GTI	Petrol	155	11/13->	CXCA								
ENGINE												
Engine	Information			A10	A20	A40	A50	A70	C10 - C30	C20	E01	
All engines	Qty: 4								1.970.636	C10		
2.0 GTI	Petrol	162	04/13->	CXDA								
ENGINE												
Engine	Information			A10	A20	A40	A50	A70	C10 - C30	C20	E01	
All engines	x 4, BERU, COIL ON PLUG, incl. spark plug connector								1.970.636	C10		
2.0 GTI TCR	Petrol	213	11/18->	CJXH, DNUC								
ENGINE												
Engine	Information			A10	A20	A40	A50	A70	C10 - C30	C20	E01	
All engines	01/11/19 ->, x 4, HITACHI, COIL ON PLUG, incl. spark plug connector								1.970.636	C10		
2.0 R 4motion	Petrol	213	12/16->	CJXD, DJHB, DNUC								
ENGINE												
Engine	Information			A10	A20	A40	A50	A70	C10 - C30	C20	E01	
All engines	01/11/19 ->, x 4, HITACHI, COIL ON PLUG, incl. spark plug connector								1.970.636	C10		
2.0 R 4motion	Petrol	221	11/13->	CJXC, DNUE								
ENGINE												
Engine	Information			A10	A20	A40	A50	A70	C10 - C30	C20	E01	
All engines	01/11/19 ->, x 4, HITACHI, COIL ON PLUG, incl. spark plug connector								1.970.636	C10		
2.0 R 4motion	Petrol	228	12/16->	CJXG, DJHA								
ENGINE												
Engine	Information			A10	A20	A40	A50	A70	C10 - C30	C20	E01	
All engines	01/11/19 ->, x 4, HITACHI, COIL ON PLUG, incl. spark plug connector								1.970.636	C10		
GOLF VIII												
ENGINE												
1.0 eTSI	Petrol/ Electric	81	06/20->	DLAA								
ENGINE												
Engine	Information			A10	A20	A40	A50	A70	C10 - C30	C20	E01	
All engines	x 3, HITACHI, COIL ON PLUG, incl. spark plug connector								1.970.599	C10		
1.0 TSI	Petrol	66	02/20->	DLAB								
ENGINE												
Engine	Information			A10	A20	A40	A50	A70	C10 - C30	C20	E01	
All engines	x 3, HITACHI, COIL ON PLUG, incl. spark plug connector								1.970.599	C10		
1.0 TSI	Petrol	81	02/20->	DLAA								
ENGINE												
Engine	Information			A10	A20	A40	A50	A70	C10 - C30	C20	E01	
All engines	x 3, HITACHI, COIL ON PLUG, incl. spark plug connector								1.970.599	C10		
1.4 GTE Plug-in Hybrid	Petrol/ Electric	110	07/20->	DGEA								
ENGINE												
Engine	Information			A10	A20	A40	A50	A70	C10 - C30	C20	E01	
All engines	x 4, ELDOR, COIL ON PLUG, Number of pins:4, incl. spark plug connector								1.970.599	C10		
1.4 GTE Plug-in Hybrid	Petrol/ Electric	180	07/20->	DGEA								
ENGINE												
Engine	Information			A10	A20	A40	A50	A70	C10 - C30	C20	E01	
All engines	x 4, ELDOR, COIL ON PLUG, Number of pins:4, incl. spark plug connector								1.970.599	C10		
1.4 TSI eHybrid	Petrol/ Electric	110	07/20->	DGEA								
ENGINE												
Engine	Information			A10	A20	A40	A50	A70	C10 - C30	C20	E01	
All engines	x 4, ELDOR, COIL ON PLUG, Number of pins:4, incl. spark plug connector								1.970.599	C10		
2.0 GTI	Petrol	180	09/20->	DNPA								
ENGINE												
Engine	Information			A10	A20	A40	A50	A70	C10 - C30	C20	E01	
All engines	x 4, HITACHI, COIL ON PLUG, incl. spark plug connector								1.970.636	C10		

A10	CONDENSER	A20	CONTACT SET	A40	DISTRIBUTOR CAP	A50	ROTOR	A70	PICK-UP
C10	COIL	C20	IGNITION MODULE	C30	ELECTRONIC IGNITION KIT	E01	IGNITION CABLE SET		

The present application list is a brief version. For the detailed information about the possibility of installation on a specific vehicle, please refer to our web-catalogue <http://catalogo.facet.eu/>

Vehicle	alim.	kW	Date	Engine	FUNCTIONS ON THE VEHICLE							
					A10	A20	A40	A50	A70	C10 - C30	C20	E01

ENGINE				
2.0 GTI Clubsport	Petrol	221	10/20->	DNFC

Engine	Information	A10	A20	A40	A50	A70	C10 - C30	C20	E01
All engines	x 4, HITACHI, COIL ON PLUG, incl. spark plug connector						1.970.636	C10	

ENGINE				
2.0 TSI R 4motion	Petrol	235	09/20->	DNFG, DSFE, DSFF

Engine	Information	A10	A20	A40	A50	A70	C10 - C30	C20	E01
All engines	x 4, HITACHI, COIL ON PLUG, incl. spark plug connector						1.970.636	C10	

JETTA II				
ENGINE				
1.0	Petrol	37	08/85-10/91	HZ

Engine	Information	A10	A20	A40	A50	A70	C10 - C30	C20	E01
All engines	->ch. 1G-MB150 000, ->ch. 1G-MW480 000, version Bosch			1.306.094		1.906.193			
All engines	ch. 1G-MB150 001 ->, ch. 1G-MW480 001 ->, version Bosch			1.306.266		1.906.234			
All engines	01/08/86 ->, version Bosch				1.406.056R				
All engines	no specific info conc. application available						1.970.125, 1.970.126	C10	
All engines								1.965.007	1.500.493

ENGINE				
1.3	Petrol	37	08/85-12/87	NU

Engine	Information	A10	A20	A40	A50	A70	C10 - C30	C20	E01
All engines	version Bosch			1.306.094	1.406.056R	1.906.193			
All engines							1.970.125	C10	1.501.671

ENGINE				
1.3	Petrol	40	01/84-06/87	HK, MH

Engine	Information	A10	A20	A40	A50	A70	C10 - C30	C20	E01
Eng. HK	version Bosch	1.106.195	1.206.049HVS		1.406.114R				
Eng. HK	->ch. 19-E-855 000, version Bosch			1.306.079					
All engines	ch. 19-E-855 001 ->, version Bosch			1.306.094					
Eng. MH	version Bosch				1.406.056R	1.906.193			
Eng. MH	->year 31/07/87						1.970.125	C10	
Eng. MH	01/08/87 ->						1.970.126	C10	
Eng. MH								1.965.007	
All engines	ch. 19-E-855 001 ->, ->year 31/07/86, 01/08/88 ->								1.500.493
Eng. HK	->ch. 19-E-855 000								1.500.727
Eng. MH	01/08/86 ->, ->year 31/07/88								1.501.671

ENGINE				
1.3	Petrol	43	01/84-10/86	GT

Engine	Information	A10	A20	A40	A50	A70	C10 - C30	C20	E01
All engines	version Bosch	1.106.195	1.206.049HVS		1.406.056R				
All engines	->ch. 19-E-855 000, version Bosch			1.306.079					
All engines	ch. 19-E-855 001 ->, version Bosch			1.306.094					
All engines	ch. 19-E-855 001 ->								1.500.493
All engines	->ch. 19-E-855 000								1.500.727

ENGINE				
1.3 Cat	Petrol	40	06/87-12/91	2G, MH, NZ

Engine	Information	A10	A20	A40	A50	A70	C10 - C30	C20	E01
All engines	->ch. 1G-MB150 000, ->ch. 1G-MW480 000, version Bosch			1.306.094					
Eng. 2G, NZ	ch. 1G-MB150 001 ->, ch. 1G-MW480 001 ->, version Bosch			1.306.266					
All engines	version Bosch				1.406.056R				
All engines	->ch. 1G-MB150 000, ->ch. 1G-MW480 000, version Bosch, distr. num. 030 905 205 D					1.906.193			
Eng. 2G, NZ	ch. 1G-MB150 001 ->, ch. 1G-MW480 001 ->, version Bosch, distr. num. 030 805 205 S					1.906.234			
All engines	->year 31/07/87, no specific info conc. application available						1.970.125	C10	
All engines	01/08/87 ->, no specific info conc. application available						1.970.126	C10	
All engines								1.965.007	
All engines	->year 31/07/86, ->year 31/01/87, 01/08/88 ->								1.500.493
Eng. MH, NZ	01/08/86 ->, 01/02/87 ->, ->year 31/07/88								1.501.671

ENGINE				
1.6	Petrol	51	08/86-10/91	EZA, PN

Engine	Information	A10	A20	A40	A50	A70	C10 - C30	C20	E01
All engines	version Bosch			1.306.266	1.406.055R				

A10 CONDENSER	A20 CONTACT SET	A40 DISTRIBUTOR CAP	A50 ROTOR	A70 PICK-UP
C10 COIL	C20 IGNITION MODULE	C30 ELECTRONIC IGNITION KIT	E01 IGNITION CABLE SET	

Vehicle	alim.	kW	Date	Engine	FUNCTIONS ON THE VEHICLE									
					A10	A20	A40	A50	A70	C10 - C30	C20	E01		
1.6	Petrol	51	08/86-10/91	ENGINE EZA, PN										
Engine	Information				A10	A20	A40	A50	A70	C10 - C30	C20	E01		
All engines	version Ducellier						1.315.068	1.415.099R						
Eng. PN	->year 31/07/86, version Bosch								1.906.159					
All engines	01/08/86 ->, version Bosch								1.906.219					
All engines	no specific info conc. application available									1.970.125	C10			
Eng. PN	no specific info conc. application available									1.970.126	C10			
All engines											1.965.007		1.500.725	
1.6	Petrol	53	03/86-10/91	ENGINE RF										
Engine	Information				A10	A20	A40	A50	A70	C10 - C30	C20	E01		
All engines	version Bosch						1.306.266	1.406.055R	1.906.219					
All engines	version Ducellier						1.315.068	1.415.099R						
All engines	no specific info conc. application available									1.970.125, 1.970.126	C10			
All engines											1.965.007		1.500.725	
1.6	Petrol	55	01/84-07/92	ENGINE ABN, EZ										
Engine	Information				A10	A20	A40	A50	A70	C10 - C30	C20	E01		
Eng. EZ	version Bosch				1.106.196	1.206.034HVS								
Eng. EZ	version Bosch, distr. num. 050 905 205 C, eng. type 185 001 ->, ->year 01/07/86						1.306.094							
All engines	version Bosch						1.306.266							
All engines	version Ducellier, 01/08/85 ->						1.315.068	1.415.099R						
Eng. EZ	version Bosch, eng. type 185 001 ->, ->eng. 309 582							1.406.025R						
All engines	version Bosch, distr. num. 026 905 206, distr. num. 050 905 205, distr. num. 050 905 205 C, ->eng. 185 000, eng. type 309 583 ->							1.406.055R						
All engines	version Bosch, distr. num. 050 905 205 C, eng. type 309 583 ->								1.906.219					
All engines	no specific info conc. application available									1.970.125	C10			
Eng. EZ	no specific info conc. application available									1.970.126	C10			
All engines											1.965.007			
All engines	ch. 19-E-855 001 ->												1.500.725	
Eng. EZ	->ch. 19-E-855 000												1.500.727	
1.6	Petrol	60	12/83-07/88	ENGINE HM										
Engine	Information				A10	A20	A40	A50	A70	C10 - C30	C20	E01		
All engines	version Bosch				1.106.196	1.206.034HVS		1.406.055R						
All engines	version Bosch, ->eng. 016 000						1.306.079							
All engines	version Bosch, eng. type 016 001 ->, ->year 01/07/86						1.306.094							
All engines	01/08/86 ->, version Bosch						1.306.266							
All engines	version Bosch, eng. type 033 001 ->								1.906.219					
All engines	ch. 19-F-350 000 ->									1.970.125	C10			
All engines											1.965.007			
All engines	ch. 19-E-855 001 ->												1.500.725	
All engines	->ch. 19-E-855 000												1.500.727	
1.8	Petrol	62	08/86-01/90	ENGINE RH										
Engine	Information				A10	A20	A40	A50	A70	C10 - C30	C20	E01		
All engines	version Bosch						1.306.094	1.406.055R	1.906.219					
All engines										1.970.125	C10	1.965.007	1.500.725	
1.8	Petrol	66	08/84-10/91	ENGINE GU, GX										
Engine	Information				A10	A20	A40	A50	A70	C10 - C30	C20	E01		
Eng. GU	version Bosch, ->eng. 003 200						1.306.079							
All engines	version Bosch, ->year 31/07/86, eng. type 003 201 ->, ->eng. 31/07/87						1.306.094							
All engines	version Bosch, 01/08/86 ->, 01/08/87 ->						1.306.266							
Eng. GU	version Ducellier, 01/08/85 ->						1.315.068	1.415.099R						
All engines	version Bosch							1.406.055R	1.906.219					
All engines	ch. 19-E-855 001 ->									1.970.125	C10		1.500.725	
All engines	->ch. 19-E-855 000									1.970.132	C10		1.500.727	
All engines											1.965.007			

A10	CONDENSER	A20	CONTACT SET	A40	DISTRIBUTOR CAP	A50	ROTOR	A70	PICK-UP
C10	COIL	C20	IGNITION MODULE	C30	ELECTRONIC IGNITION KIT	E01	IGNITION CABLE SET		

The present application list is a brief version. For the detailed information about the possibility of installation on a specific vehicle, please refer to our web-catalogue <http://catalogo.facet.eu/>

					FUNCTIONS ON THE VEHICLE							
Vehicle	alim.	kW	Date	Engine								
ENGINE												
1.8	Petrol	77	08/87-10/91	RV								
Engine	Information	A10	A20	A40	A50	A70	C10 - C30	C20	E01			
All engines	version Bosch, ch. 1G-LB100 001 ->, ch. 1G-LW320 001 ->, ->ch. 1G-MB150 000, ->ch. 1G-MW480 000			1.306.094								
All engines	version Bosch, ->ch. 1G-LB100 000, ->ch. 1G-LW320 000, ch. 1G-MB150 001 ->, ch. 1G-MW480 001 ->			1.306.266								
All engines	version Bosch				1.406.121R							
All engines							1.970.125	C10	1.965.007		1.500.725	
ENGINE												
1.8	Petrol	79	08/85-10/87	RD								
Engine	Information	A10	A20	A40	A50	A70	C10 - C30	C20	E01			
All engines	version Bosch			1.306.266	1.406.121R							
All engines							1.970.125	C10	1.965.007		1.500.725	
ENGINE												
1.8	Petrol	82	01/84-10/91	EV, PB								
Engine	Information	A10	A20	A40	A50	A70	C10 - C30	C20	E01			
Eng. EV	version Bosch, ->eng. 025 000			1.306.079								
All engines	version Bosch, eng. type 025 001 ->, ->year 31/07/86, ch. 1G-LB100 001 ->, ch. 1G-LW320 001 ->, ->ch. 1G-MB150 000, ->ch. 1G-MW480 000			1.306.094								
All engines	version Bosch, 01/08/86 ->, ->ch. 1G-LB100 000, ->ch. 1G-LW320 000, ch. 1G-MB150 001 ->, ch. 1G-MW480 001 ->			1.306.266								
Eng. EV	version Bosch, 01/08/85 ->				1.406.055R							
Eng. EV	version Bosch, ->year 31/07/85				1.406.116R							
Eng. PB	version Bosch				1.406.121R							
Eng. EV	version Bosch					1.906.219						
All engines	ch. 19-E-855 001 ->						1.970.125	C10			1.500.725	
Eng. EV	->ch. 19-E-855 000						1.970.132	C10			1.500.727	
All engines									1.965.007			
ENGINE												
1.8 16V	Petrol	102	06/87-12/89	KR								
Engine	Information	A10	A20	A40	A50	A70	C10 - C30	C20	E01			
All engines	version Bosch			1.306.266	1.406.121R	1.906.223						
All engines							1.970.125	C10	1.965.007			
All engines	->year 31/07/89										1.500.737	
ENGINE												
1.8 16V	Petrol	95	08/86-10/91	PL								
Engine	Information	A10	A20	A40	A50	A70	C10 - C30	C20	E01			
All engines	version Bosch			1.306.266	1.406.121R	1.906.223						
All engines	no specific info conc. application available						1.970.125, 1.970.126	C10				
All engines									1.965.007			
All engines	->year 31/07/89										1.500.737	
ENGINE												
1.8 Cat	Petrol	66	08/87-10/91	GX, RP								
Engine	Information	A10	A20	A40	A50	A70	C10 - C30	C20	E01			
Eng. GX	version Bosch, ->year 31/07/86			1.306.094								
All engines	version Bosch, 01/08/86 ->			1.306.266								
All engines	version Bosch				1.406.055R	1.906.219						
All engines	ch. 19-E-855 001 ->						1.970.125	C10			1.500.725	
Eng. GX	->ch. 19-E-855 000						1.970.132	C10			1.500.727	
All engines									1.965.007			
ENGINE												
1.8 Cat	Petrol	79	01/87-10/91	PF								
Engine	Information	A10	A20	A40	A50	A70	C10 - C30	C20	E01			
All engines	version Bosch, ch. 1G-LB100 001 ->, ch. 1G-LW320 001 ->, ->ch. 1G-MB150 000, ->ch. 1G-MW480 000			1.306.094								
All engines	version Bosch, ->ch. 1G-LB100 000, ->ch. 1G-LW320 000, ch. 1G-MB150 001 ->, ch. 1G-MW480 001 ->			1.306.266								
All engines	version Bosch				1.406.121R							
All engines							1.970.125	C10	1.965.007		1.500.725	
ENGINE												
1.8 G60	Petrol	118	04/90-07/91	PG								
Engine	Information	A10	A20	A40	A50	A70	C10 - C30	C20	E01			
All engines	version Bosch, ->ch. 1G-MB150 000, ->ch. 1G-MW480 000			1.306.094								

A10 CONDENSER	A20 CONTACT SET	A40 DISTRIBUTOR CAP	A50 ROTOR	A70 PICK-UP
C10 COIL	C20 IGNITION MODULE	C30 ELECTRONIC IGNITION KIT	E01 IGNITION CABLE SET	

Vehicle	alim.	kW	Date	Engine	FUNCTIONS ON THE VEHICLE								
					A10	A20	A40	A50	A70	C10 - C30	C20	E01	
ENGINE													
1.8 G60	Petrol	118	04/90-07/91	PG									
Engine	Information				A10	A20	A40	A50	A70	C10 - C30	C20	E01	
All engines	version Bosch, ch. 1G-MB150 001 ->, ch. 1G-MW480 001 ->						1.306.266						
All engines	version Bosch							1.406.121R					
All engines										1.970.125	C10	1.965.007	1.500.725
ENGINE													
1.8 Syncro	Petrol	62	08/87-07/88	RH									
Engine	Information				A10	A20	A40	A50	A70	C10 - C30	C20	E01	
All engines										1.970.125	C10	1.965.007	1.500.725
ENGINE													
1.8 Syncro	Petrol	66	08/85-12/88	GU, GX, RP									
Engine	Information				A10	A20	A40	A50	A70	C10 - C30	C20	E01	
Eng. GU	version Bosch, ->eng. 003 200						1.306.079						
Eng. GU	version Bosch, eng. type 003 201 ->, ->year 31/07/87						1.306.094						
Eng. GU, RP	version Bosch, 01/08/87 ->						1.306.266						
Eng. GU	version Ducellier, 01/08/85 ->						1.315.068	1.415.099R					
Eng. GU, RP	version Bosch							1.406.055R	1.906.219				
All engines	ch. 1G-L-000 001 ->									1.970.125	C10		
Eng. GU	->ch. 1G-K-990 000									1.970.126	C10		
All engines											1.965.007		
All engines	ch. 19-E-855 001 ->											1.500.725	
Eng. GU	->ch. 19-E-855 000											1.500.727	
ENGINE													
1.8 Syncro	Petrol	72	08/88-07/91	3E82									
Engine	Information				A10	A20	A40	A50	A70	C10 - C30	C20	E01	
All engines	ch. 1G-L-000 001 ->									1.970.125	C10		
All engines	->ch. 1G-K-990 000									1.970.126	C10		
All engines											1.965.007	1.500.725	
ENGINE													
1.8i GT	Petrol	82	12/83-07/88	GZ									
Engine	Information				A10	A20	A40	A50	A70	C10 - C30	C20	E01	
All engines	->year 31/07/86, version Bosch						1.306.094						
All engines	version Bosch, 01/08/86 ->						1.306.266						
All engines	version Bosch, 01/08/85 ->							1.406.055R					
All engines	version Bosch, ->year 31/07/85							1.406.116R					
All engines	version Bosch								1.906.219				
All engines	ch. 19-E-855 001 ->									1.970.125	C10	1.500.725	
All engines	->ch. 19-E-855 000									1.970.132	C10	1.500.727	
All engines											1.965.007		
JETTA V													
ENGINE													
1.4 TSI	Petrol	103	07/06-10/10	BMV									
Engine	Information				A10	A20	A40	A50	A70	C10 - C30	C20	E01	
All engines	x 4, COIL ON PLUG, incl. spark plug connector									1.970.474	C10		
ENGINE													
1.4 TSI	Petrol	118	07/08-10/10	CAVD									
Engine	Information				A10	A20	A40	A50	A70	C10 - C30	C20	E01	
All engines	x 4, COIL ON PLUG, incl. spark plug connector									1.970.474	C10		
ENGINE													
1.4 TSI	Petrol	125	07/06-10/10	BLG									
Engine	Information				A10	A20	A40	A50	A70	C10 - C30	C20	E01	
All engines	x 4, COIL ON PLUG, incl. spark plug connector									1.970.474	C10		
ENGINE													
1.4 TSI	Petrol	90	05/07-10/10	CAXA									
Engine	Information				A10	A20	A40	A50	A70	C10 - C30	C20	E01	
All engines	x 4, COIL ON PLUG, incl. spark plug connector									1.970.474	C10		
ENGINE													
1.6	Petrol	75	09/04-10/10	BSE, BSF, CCSA									
Engine	Information				A10	A20	A40	A50	A70	C10 - C30	C20	E01	
All engines										1.990.420	C30	1.501.585	

A10	CONDENSER	A20	CONTACT SET	A40	DISTRIBUTOR CAP	A50	ROTOR	A70	PICK-UP
C10	COIL	C20	IGNITION MODULE	C30	ELECTRONIC IGNITION KIT	E01	IGNITION CABLE SET		

The present application list is a brief version. For the detailed information about the possibility of installation on a specific vehicle, please refer to our web-catalogue <http://catalogo.facet.eu/>

					FUNCTIONS ON THE VEHICLE							
Vehicle	alim.	kW	Date	Engine	A10	A20	A40	A50	A70	C10 - C30	C20	E01
ENGINE												
1.6 [CHN]	Petrol	68	01/05->	BJG								
Engine	Information				A10	A20	A40	A50	A70	C10 - C30	C20	E01
All engines										1.990.420	C30	1.501.585
ENGINE												
1.6 FSI	Petrol	85	09/05-10/10	BLF								
Engine	Information				A10	A20	A40	A50	A70	C10 - C30	C20	E01
All engines	x 4, COIL ON PLUG, incl. spark plug connector									1.970.474	C10	
ENGINE												
1.6 MultiFuel	Petrol/ Ethanol	75	01/08-10/10	CCSA								
Engine	Information				A10	A20	A40	A50	A70	C10 - C30	C20	E01
All engines										1.990.420	C30	1.501.585
ENGINE												
2.0 FSI	Petrol	110	08/05-10/10	BLR, BLY, BVY, BVZ								
Engine	Information				A10	A20	A40	A50	A70	C10 - C30	C20	E01
All engines	x 4, ELDOR, Housing Colour:Black, COIL ON PLUG, incl. spark plug connector									1.970.426	C10	
ENGINE												
2.0 TFSI	Petrol	147	10/05-10/10	BPY, BWA, CAWB, CBFA, CCTA, CCZA								
Engine	Information				A10	A20	A40	A50	A70	C10 - C30	C20	E01
Eng. BPY, CCZA	Qty: 4									1.970.426	C10	
Eng. BWA, CAWB, CBFA, CCTA	x 4, ELDOR, Housing Colour:Black, COIL ON PLUG, incl. spark plug connector									1.970.426	C10	
ENGINE												
2.5	Petrol	110	01/05->	BGP, BGQ, BTK								
Engine	Information				A10	A20	A40	A50	A70	C10 - C30	C20	E01
Eng. BGP, BTK	->ch. 1K7133612, ch. 1K7133613 ->, x 5, COIL ON PLUG, ELDOR, Housing Colour:Black, COIL ON PLUG, incl. spark plug connector									1.970.426	C10	
Eng. BGQ	Qty: 5									1.970.426	C10	
ENGINE												
2.5	Petrol	125	07/08-10/10	CBTA, CCCA								
Engine	Information				A10	A20	A40	A50	A70	C10 - C30	C20	E01
Eng. CBTA	x 5, ELDOR, Housing Colour:Black, COIL ON PLUG, incl. spark plug connector									1.970.426	C10	
Eng. CCCA	Qty: 5									1.970.426	C10	
JETTA VI												
ENGINE												
1.2 TSI	Petrol	77	10/10->	CBZB, CYVD								
Engine	Information				A10	A20	A40	A50	A70	C10 - C30	C20	E01
Eng. CYVD	Qty: 4									1.970.599	C10	
Eng. CBZB										1.990.420	C30	1.499.248
ENGINE												
1.2 TSI 16V	Petrol	77	08/14-12/17	CYVD								
Engine	Information				A10	A20	A40	A50	A70	C10 - C30	C20	E01
All engines	x 4, BERU, ELDOR, COIL ON PLUG, incl. spark plug connector, Number of pins:4, incl. spark plug connector									1.970.599	C10	
ENGINE												
1.4 TSI	Petrol	110	04/11->	CAVA, CTHA, CZDA, CZTA								
Engine	Information				A10	A20	A40	A50	A70	C10 - C30	C20	E01
Eng. CAVA, CTHA	x 4, COIL ON PLUG, incl. spark plug connector									1.970.474	C10	
Eng. CZDA	x 4, BERU, ELDOR, COIL ON PLUG, incl. spark plug connector, Number of pins:4, incl. spark plug connector									1.970.599	C10	
Eng. CZTA	Qty: 4									1.970.599	C10	
ENGINE												
1.4 TSI	Petrol	118	04/11->	CAVD, CTHD								
Engine	Information				A10	A20	A40	A50	A70	C10 - C30	C20	E01
All engines	x 4, COIL ON PLUG, incl. spark plug connector									1.970.474	C10	
ENGINE												
1.4 TSI	Petrol	90	05/11->	CAXA, CMSB								
Engine	Information				A10	A20	A40	A50	A70	C10 - C30	C20	E01
All engines	x 4, COIL ON PLUG, incl. spark plug connector									1.970.474	C10	

A10 CONDENSER	A20 CONTACT SET	A40 DISTRIBUTOR CAP	A50 ROTOR	A70 PICK-UP
C10 COIL	C20 IGNITION MODULE	C30 ELECTRONIC IGNITION KIT	E01 IGNITION CABLE SET	

Vehicle	alim.	kW	Date	Engine	FUNCTIONS ON THE VEHICLE								
					A10	A20	A40	A50	A70	C10 - C30	C20	E01	
1.4 TSI	Petrol	92	08/14->	ENGINE CZCA									
Engine	Information				A10	A20	A40	A50	A70	C10 - C30	C20	E01	
All engines	x 4, BERU, ELDOR, HITACHI, COIL ON PLUG, incl. spark plug connector, Number of pins:4, incl. spark plug connector									1.970.599	C10		
1.4 TSI Hybrid	Petrol/ Electric	110	04/11->	ENGINE CNLA									
Engine	Information				A10	A20	A40	A50	A70	C10 - C30	C20	E01	
All engines	x 4, BERU, ELDOR, COIL ON PLUG, incl. spark plug connector, Number of pins:4, incl. spark plug connector									1.970.599	C10		
1.6	Petrol	63	03/13->	ENGINE CFNB									
Engine	Information				A10	A20	A40	A50	A70	C10 - C30	C20	E01	
All engines	x 4, COIL ON PLUG, incl. spark plug connector									1.970.474	C10		
1.6	Petrol	77	12/11->	ENGINE CFNA, CLRA									
Engine	Information				A10	A20	A40	A50	A70	C10 - C30	C20	E01	
All engines	x 4, COIL ON PLUG, incl. spark plug connector									1.970.474	C10		
1.6	Petrol	81	09/15->	ENGINE CWVA									
Engine	Information				A10	A20	A40	A50	A70	C10 - C30	C20	E01	
All engines	x 4, BERU, ELDOR, COIL ON PLUG, incl. spark plug connector, Number of pins:4, incl. spark plug connector									1.970.599	C10		
1.6 [RUS]	Petrol	66	01/15->	ENGINE CWVB									
Engine	Information				A10	A20	A40	A50	A70	C10 - C30	C20	E01	
All engines	Qty: 4									1.970.599	C10		
1.6 [RUS]	Petrol	81	01/15->	ENGINE CWVA									
Engine	Information				A10	A20	A40	A50	A70	C10 - C30	C20	E01	
All engines	Qty: 4									1.970.599	C10		
1.6 MPI	Petrol	66	09/15-04/18	ENGINE CWVB									
Engine	Information				A10	A20	A40	A50	A70	C10 - C30	C20	E01	
All engines	x 4, BERU, ELDOR, COIL ON PLUG, incl. spark plug connector, Number of pins:4, incl. spark plug connector									1.970.599	C10		
1.8 TSI	Petrol	125	07/14->	ENGINE CPKA, CPRA									
Engine	Information				A10	A20	A40	A50	A70	C10 - C30	C20	E01	
All engines	01/01/15 ->, x 4, BERU, COIL ON PLUG, incl. spark plug connector									1.970.636	C10		
2.0	Petrol	85	06/10-12/17	ENGINE CBPA, CKJA									
Engine	Information				A10	A20	A40	A50	A70	C10 - C30	C20	E01	
Eng. CBPA										1.990.420	C30	1.501.585	
Eng. CKJA												1.499.223	
2.0 TFSI	Petrol	147	12/10->	ENGINE CBFA, CCTA, CCZA									
Engine	Information				A10	A20	A40	A50	A70	C10 - C30	C20	E01	
All engines	x 4, ELDOR, Housing Colour:Black, COIL ON PLUG, incl. spark plug connector									1.970.426	C10		
2.0 TSI	Petrol	155	12/12-12/17	ENGINE CPLA, CPPA									
Engine	Information				A10	A20	A40	A50	A70	C10 - C30	C20	E01	
All engines	01/01/15 ->, x 4, BERU, COIL ON PLUG, incl. spark plug connector									1.970.636	C10		
2.5	Petrol	125	04/10->	ENGINE CBTA, CBUA, CCA									
Engine	Information				A10	A20	A40	A50	A70	C10 - C30	C20	E01	
All engines	x 5, ELDOR, Housing Colour:Black, COIL ON PLUG, incl. spark plug connector									1.970.426	C10		

A10	CONDENSER	A20	CONTACT SET	A40	DISTRIBUTOR CAP	A50	ROTOR	A70	PICK-UP
C10	COIL	C20	IGNITION MODULE	C30	ELECTRONIC IGNITION KIT	E01	IGNITION CABLE SET		

The present application list is a brief version. For the detailed information about the possibility of installation on a specific vehicle, please refer to our web-catalogue <http://catalogo.facet.eu/>

Vehicle	alim.	kW	Date	Engine	FUNCTIONS ON THE VEHICLE							
					A10	A20	A40	A50	A70	C10 - C30	C20	E01

KAEFER









1.2	Petrol	22	01/54-07/65	M51														
ENGINE																		
Engine	Information				A10	A20	A40	A50	A70	C10 - C30	C20	E01						
All engines						1.206.040	1.306.062	1.406.018R										
1200 1.2	Petrol	25	01/60-12/85	D														
ENGINE																		
Engine	Information				A10	A20	A40	A50	A70	C10 - C30	C20	E01						
All engines						1.206.040		1.406.021R										
1300 1.3	Petrol	27	08/65-07/70	E														
ENGINE																		
Engine	Information				A10	A20	A40	A50	A70	C10 - C30	C20	E01						
All engines						1.206.040		1.406.014R										
1300 1.3	Petrol	29	01/65-07/70	F														
ENGINE																		
Engine	Information				A10	A20	A40	A50	A70	C10 - C30	C20	E01						
All engines						1.206.040												
1300 1.3	Petrol	32	01/70-01/73	AB														
ENGINE																		
Engine	Information				A10	A20	A40	A50	A70	C10 - C30	C20	E01						
All engines						1.206.040		1.406.021R										
1302 1.2	Petrol	25	08/69-08/72	D														
ENGINE																		
Engine	Information				A10	A20	A40	A50	A70	C10 - C30	C20	E01						
All engines						1.206.040												
1302 1.3	Petrol	29	08/70-07/75	AC														
ENGINE																		
Engine	Information				A10	A20	A40	A50	A70	C10 - C30	C20	E01						
All engines						1.206.040												
1302 1.3	Petrol	32	08/70-08/72	AB														
ENGINE																		
Engine	Information				A10	A20	A40	A50	A70	C10 - C30	C20	E01						
All engines						1.206.040		1.406.021R										
1302 1.6	Petrol	34	08/70-07/74	AF														
ENGINE																		
Engine	Information				A10	A20	A40	A50	A70	C10 - C30	C20	E01						
All engines						1.206.040												
1302 1.6	Petrol	35	07/71-07/74	AE, AH, AK														
ENGINE																		
Engine	Information				A10	A20	A40	A50	A70	C10 - C30	C20	E01						
All engines						1.206.040												
1302 1.6	Petrol	37	01/70-01/73	AD														
ENGINE																		
Engine	Information				A10	A20	A40	A50	A70	C10 - C30	C20	E01						
All engines						1.206.040		1.406.021R										
1302,1303 1.6	Petrol	37	07/70-06/79	AD														
ENGINE																		
Engine	Information				A10	A20	A40	A50	A70	C10 - C30	C20	E01						
All engines						1.206.040												
1303 1.3	Petrol	32	08/72-07/75	AB, AR														
ENGINE																		
Engine	Information				A10	A20	A40	A50	A70	C10 - C30	C20	E01						
All engines						1.206.040												
1303 1.6	Petrol	35	08/70-12/79	AD, AE, AH, AK														
ENGINE																		
Engine	Information				A10	A20	A40	A50	A70	C10 - C30	C20	E01						
All engines						1.206.040												
1303 LS, S 1.6	Petrol	37	08/72-12/79	AD, AJ, AS														
ENGINE																		
Engine	Information				A10	A20	A40	A50	A70	C10 - C30	C20	E01						
All engines						1.206.040												

A10 CONDENSER	A20 CONTACT SET	A40 DISTRIBUTOR CAP	A50 ROTOR	A70 PICK-UP
C10 COIL	C20 IGNITION MODULE	C30 ELECTRONIC IGNITION KIT	E01 IGNITION CABLE SET	

Vehicle	alim.	kW	Date	Engine	FUNCTIONS ON THE VEHICLE									
					A10	A20	A40	A50	A70	C10 - C30	C20	E01		
ENGINE														
1500 1.5	Petrol	32	01/66-11/73	45C20M150Q6										
Engine	Information				A10	A20	A40	A50	A70	C10 - C30	C20	E01		
All engines						1.206.032HV, 1.206.040		1.406.014R, 1.406.021R						
ENGINE														
1500 1.6	Petrol	37	07/70-01/73	AD										
Engine	Information				A10	A20	A40	A50	A70	C10 - C30	C20	E01		
All engines						1.206.040								
KARMANN GHIA														
ENGINE														
1500	Petrol	32	01/66-12/69	45C20M150Q6										
Engine	Information				A10	A20	A40	A50	A70	C10 - C30	C20	E01		
All engines								1.406.021R						
ENGINE														
1600	Petrol	37	01/70-12/73	AD										
Engine	Information				A10	A20	A40	A50	A70	C10 - C30	C20	E01		
All engines								1.406.021R						
LT I														
ENGINE														
2.4	Petrol	66	12/82-07/92	DL										
Engine	Information				A10	A20	A40	A50	A70	C10 - C30	C20	E01		
All engines	version Bosch					1.206.034HVS		1.406.117R						
ENGINE														
2.4 4WD	Petrol	66	12/82-07/92	DL										
Engine	Information				A10	A20	A40	A50	A70	C10 - C30	C20	E01		
All engines	version Bosch					1.206.034HVS		1.406.117R						
ENGINE														
2.4 i	Petrol	69	08/89-06/96	1E										
Engine	Information				A10	A20	A40	A50	A70	C10 - C30	C20	E01		
All engines	version Bosch					1.206.034HVS	1.306.233							
All engines										1.970.125	C10			
LT II														
ENGINE														
2.3	Petrol	105	05/96-07/06	AGL										
Engine	Information				A10	A20	A40	A50	A70	C10 - C30	C20	E01		
All engines	LT 28, x 1, D.I.S., Dia: 4 mm, connector type, saw teeth									1.970.316	C10			
LUPO														
ENGINE														
1.0	Petrol	37	09/98-07/05	AER, ALD, ALL, ANV, AUC										
Engine	Information				A10	A20	A40	A50	A70	C10 - C30	C20	E01		
Eng. AER, ALL	version Bosch						1.306.094	1.406.121R	1.906.223					
Eng. AER, ALL	version Marelli						1.330.116	1.430.057R						
Eng. AER, ALL										1.990.414	C30		1.501.641	
Eng. ALD, ANV, AUC										1.990.420	C30			
Eng. ALD, ANV													1.501.595	
Eng. AUC													1.501.601	
ENGINE														
1.4	Petrol	44	10/00-07/05	AUD										
Engine	Information				A10	A20	A40	A50	A70	C10 - C30	C20	E01		
All engines										1.990.420	C30		1.501.601	
ENGINE														
1.4 16V	Petrol	55	09/98-07/05	AHW, AKQ, APE, AUA, BBY										
Engine	Information				A10	A20	A40	A50	A70	C10 - C30	C20	E01		
Eng. BBY	x 4, COIL ON PLUG, incl. spark plug connector									1.970.474	C10			
Eng. AHW, AKQ, APE, AUA										1.990.420	C30		1.501.575	
ENGINE														
1.4 16V	Petrol	74	08/99-07/05	AFK, ANM, AQQ, AUB										
Engine	Information				A10	A20	A40	A50	A70	C10 - C30	C20	E01		
All engines										1.990.420	C30			
Eng. AFK, AQQ, AUB													1.501.575	

A10	CONDENSER	A20	CONTACT SET	A40	DISTRIBUTOR CAP	A50	ROTOR	A70	PICK-UP
C10	COIL	C20	IGNITION MODULE	C30	ELECTRONIC IGNITION KIT	E01	IGNITION CABLE SET		

The present application list is a brief version. For the detailed information about the possibility of installation on a specific vehicle, please refer to our web-catalogue <http://catalogo.facet.eu/>

					FUNCTIONS ON THE VEHICLE							
Vehicle	alim.	kW	Date	Engine								
1.6 GTI												
Petrol 92 09/00-07/05 ENGINE AVY												
Engine Information					A10	A20	A40	A50	A70	C10 - C30	C20	E01
All engines										1.990.420 C30		1.501.575
MULTIVAN												
1.4 e-Hybrid												
Petrol/Electric 110 08/21-> ENGINE DGEA												
Engine Information					A10	A20	A40	A50	A70	C10 - C30	C20	E01
All engines x 4, ELDOR, COIL ON PLUG, incl. spark plug connector										1.970.599 C10		
1.4 e-Hybrid												
Petrol/Electric 160 08/21-> ENGINE DGEA												
Engine Information					A10	A20	A40	A50	A70	C10 - C30	C20	E01
All engines x 4, ELDOR, COIL ON PLUG, incl. spark plug connector										1.970.599 C10		
2.0												
Petrol 85 11/03-08/15 ENGINE AXA												
Engine Information					A10	A20	A40	A50	A70	C10 - C30	C20	E01
All engines										1.990.420 C30		1.501.585
2.0 TSI												
Petrol 110 07/12-07/19 ENGINE CJKB												
Engine Information					A10	A20	A40	A50	A70	C10 - C30	C20	E01
All engines x 4, ELDOR, Housing Colour:Black, COIL ON PLUG, incl. spark plug connector										1.970.426 C10		
2.0 TSI												
Petrol 150 05/11-> ENGINE CJKA, DRNB												
Engine Information					A10	A20	A40	A50	A70	C10 - C30	C20	E01
Eng. CJKA x 4, ELDOR, Housing Colour:Black, COIL ON PLUG, incl. spark plug connector										1.970.426 C10		
Eng. DRNB x 4, HITACHI, COIL ON PLUG, incl. spark plug connector										1.970.636 C10		
2.0 TSI 4motion												
Petrol 150 07/11-07/19 ENGINE CJKA												
Engine Information					A10	A20	A40	A50	A70	C10 - C30	C20	E01
All engines x 4, ELDOR, Housing Colour:Black, COIL ON PLUG, incl. spark plug connector										1.970.426 C10		
3.2 V6												
Petrol 170 02/04-06/04 ENGINE BDL												
Engine Information					A10	A20	A40	A50	A70	C10 - C30	C20	E01
All engines x 6, COIL ON PLUG										1.970.434 C10		
3.2 V6												
Petrol 173 02/04-12/09 ENGINE BKK, CFLA												
Engine Information					A10	A20	A40	A50	A70	C10 - C30	C20	E01
All engines x 6, COIL ON PLUG										1.970.434 C10		
3.2 V6 4motion												
Petrol 173 07/04-12/09 ENGINE BKK, CFLA												
Engine Information					A10	A20	A40	A50	A70	C10 - C30	C20	E01
All engines x 6, COIL ON PLUG										1.970.434 C10		
NEW BEETLE												
1.4												
Petrol 55 11/01-09/10 ENGINE BCA												
Engine Information					A10	A20	A40	A50	A70	C10 - C30	C20	E01
All engines x 4, COIL ON PLUG, incl. spark plug connector										1.970.474 C10		
1.6												
Petrol 74 10/99-09/00 ENGINE AWH												
Engine Information					A10	A20	A40	A50	A70	C10 - C30	C20	E01
All engines										1.990.420 C30		1.501.585
1.6												
Petrol 75 06/00-09/10 ENGINE AYD, BFS												
Engine Information					A10	A20	A40	A50	A70	C10 - C30	C20	E01
All engines										1.990.420 C30		1.501.585

A10 CONDENSER	A20 CONTACT SET	A40 DISTRIBUTOR CAP	A50 ROTOR	A70 PICK-UP
C10 COIL	C20 IGNITION MODULE	C30 ELECTRONIC IGNITION KIT	E01 IGNITION CABLE SET	

Vehicle	alim.	kW	Date	Engine	FUNCTIONS ON THE VEHICLE									
					A10	A20	A40	A50	A70	C10 - C30	C20	E01		
ENGINE														
1.8 T	Petrol	110	10/99-09/10	OD19TCIE2, AGU, APH, AVC, AWU, AWV, BKF										
Engine	Information				A10	A20	A40	A50	A70	C10 - C30	C20	E01		
Eng. AGU, APH, AVC, AWU, AWV, BKF	01/05/00 ->, x 4, ch. 1C1400001 ->, COIL ON PLUG, incl. spark plug connector, x 4, COIL ON PLUG, incl. spark plug connector									1.970.429	C10			
Eng. BKF	Qty: 4									1.970.429	C10			
Eng. AGU, APH, AVC, AWU, AWV	->year 01/04/00, ->ch. 1CY499999, x 4, COIL ON PLUG, incl. spark plug connector									1.970.445	C10			
Eng. OD19TCIE2, AVC, AWV											1.965.076			
ENGINE														
1.8 T	Petrol	132	11/01-06/05	AWP, BNU										
Engine	Information				A10	A20	A40	A50	A70	C10 - C30	C20	E01		
All engines	x 4, COIL ON PLUG, incl. spark plug connector									1.970.429	C10			
ENGINE														
2.0	Petrol	85	01/98-10/10	AEG, APK, AQY, AZG, AZJ, BDC, BEJ, BER, BEV, BGD, BHP, CBPA										
Engine	Information				A10	A20	A40	A50	A70	C10 - C30	C20	E01		
Eng. AEG, APK, AQY, BER										1.990.420	C30			
Eng. AQY										1.990.420	C30			
Eng. AZG, AZJ, BDC, BEJ, BER, BEV, BGD, BHP	->year 30/06/05												1.499.223	
Eng. AEG, APK, AQY, BER, BHP, CBPA	01/07/05 ->												1.501.585	
ENGINE														
2.3 V5	Petrol	125	10/00-09/10	AQN										
Engine	Information				A10	A20	A40	A50	A70	C10 - C30	C20	E01		
All engines	x 5, COIL ON PLUG									1.970.435	C10			
ENGINE														
2.5	Petrol	110	07/05-09/10	BPR, BPS										
Engine	Information				A10	A20	A40	A50	A70	C10 - C30	C20	E01		
All engines	->ch. 1C8518695, ch. 1C8518696 ->, ch. 1Y7418899 ->, ch. 1Y8418407 ->, ->ch. 1Y8418406, x 5, COIL ON PLUG, ELDOR, x 5, COIL ON PLUG, Housing Colour:Black, COIL ON PLUG, incl. spark plug connector									1.970.426	C10			
ENGINE														
3.2 RSI 4motion	Petrol	165	04/00-05/01	AXJ										
Engine	Information				A10	A20	A40	A50	A70	C10 - C30	C20	E01		
All engines	x 6, COIL ON PLUG									1.970.435	C10			
PASSAT														
ENGINE														
1.4 TSi BlueMotion	Petrol	90	08/10-12/14	CAXA										
Engine	Information				A10	A20	A40	A50	A70	C10 - C30	C20	E01		
All engines	x 4, COIL ON PLUG, incl. spark plug connector									1.970.474	C10			
ENGINE														
1.8 TFSi	Petrol	118	08/10-12/14	CDAA										
Engine	Information				A10	A20	A40	A50	A70	C10 - C30	C20	E01		
All engines	x 4, ELDOR, Housing Colour:Black, COIL ON PLUG, incl. spark plug connector									1.970.426	C10			
ENGINE														
2.0 TFSi	Petrol	155	11/10-12/14	CCZB										
Engine	Information				A10	A20	A40	A50	A70	C10 - C30	C20	E01		
All engines	x 4, ELDOR, Housing Colour:Black, COIL ON PLUG, incl. spark plug connector									1.970.426	C10			
PASSAT CC														
ENGINE														
1.4 TSI MultiFuel	Petrol/ Ethanol	118	01/11-01/12	CKMA										
Engine	Information				A10	A20	A40	A50	A70	C10 - C30	C20	E01		
All engines	x 4, COIL ON PLUG, incl. spark plug connector									1.970.474	C10			
ENGINE														
1.8 TSI	Petrol	112	11/08-05/10	CDAB, CGYA										
Engine	Information				A10	A20	A40	A50	A70	C10 - C30	C20	E01		
All engines	x 4, ELDOR, Housing Colour:Black, COIL ON PLUG, incl. spark plug connector									1.970.426	C10			

A10	CONDENSER	A20	CONTACT SET	A40	DISTRIBUTOR CAP	A50	ROTOR	A70	PICK-UP
C10	COIL	C20	IGNITION MODULE	C30	ELECTRONIC IGNITION KIT	E01	IGNITION CABLE SET		

The present application list is a brief version. For the detailed information about the possibility of installation on a specific vehicle, please refer to our web-catalogue <http://catalogo.facet.eu/>

Vehicle	alim.	kW	Date	Engine	FUNCTIONS ON THE VEHICLE							
					A10	A20	A40	A50	A70	C10 - C30	C20	E01

ENGINE				
1.8 TSI	Petrol	118	06/08-01/12	BZB, CDAА

Engine	Information	A10	A20	A40	A50	A70	C10 - C30	C20	E01
All engines	x 4, ELDOR, Housing Colour:Black, COIL ON PLUG, incl. spark plug connector						1.970.426	C10	

ENGINE				
2.0 TFSI	Petrol	147	06/08-01/12	CAWB, CBFA, CCTA, CCZA

Engine	Information	A10	A20	A40	A50	A70	C10 - C30	C20	E01
Eng. CAWB, CBFA, CCZA	x 4, ELDOR, Housing Colour:Black, COIL ON PLUG, incl. spark plug connector						1.970.426	C10	
Eng. CCTA	Qty: 4						1.970.426	C10	

ENGINE				
2.0 TSI	Petrol	155	11/10-01/12	CCZB

Engine	Information	A10	A20	A40	A50	A70	C10 - C30	C20	E01
All engines	x 4, ELDOR, Housing Colour:Black, COIL ON PLUG, incl. spark plug connector						1.970.426	C10	

PASSAT II

ENGINE				
1.3	Petrol	44	08/80-07/86	79SU16

Engine	Information	A10	A20	A40	A50	A70	C10 - C30	C20	E01
All engines	version Bosch			1.306.079	1.406.056R				
All engines							1.970.132	C10	1.965.004

ENGINE				
1.6	Petrol	55	08/80-03/88	DT

Engine	Information	A10	A20	A40	A50	A70	C10 - C30	C20	E01
All engines	version Bosch, ->year 31/12/84			1.306.079					
All engines	version Bosch, 01/01/85 ->			1.306.094					
All engines	version Ducellier, 01/01/85 ->			1.315.068					
All engines	version Bosch				1.406.055R				
All engines	version Ducellier				1.415.099R				
All engines	01/01/85 ->						1.970.125	C10	
All engines	->year 31/12/84						1.970.132	C10	
All engines									1.965.004

ENGINE				
1.8	Petrol	66	01/83-03/88	DS

Engine	Information	A10	A20	A40	A50	A70	C10 - C30	C20	E01
All engines	version Bosch			1.306.094	1.406.055R				
All engines	version Ducellier			1.315.068	1.415.099R				
All engines							1.970.125	C10	1.965.004

ENGINE				
1.8 Syncro	Petrol	66	01/86-03/88	DS

Engine	Information	A10	A20	A40	A50	A70	C10 - C30	C20	E01
All engines	version Bosch			1.306.094	1.406.055R				
All engines	version Ducellier			1.315.068	1.415.099R				
All engines							1.970.125	C10	1.965.004

ENGINE				
1.9	Petrol	85	01/81-07/83	WN

Engine	Information	A10	A20	A40	A50	A70	C10 - C30	C20	E01
All engines	version Bosch			1.306.093	1.406.059R				
All engines							1.970.132	C10	1.965.004

ENGINE				
2.0	Petrol	85	08/83-03/88	JS

Engine	Information	A10	A20	A40	A50	A70	C10 - C30	C20	E01
All engines	version Bosch			1.306.231	1.406.055R, 1.406.116R				
All engines	version Bosch, 01/01/88 ->					1.906.219			
All engines							1.970.125	C10	1.965.004

ENGINE				
2.0 Syncro	Petrol	85	05/84-03/88	JS

Engine	Information	A10	A20	A40	A50	A70	C10 - C30	C20	E01
All engines	version Bosch			1.306.231	1.406.055R, 1.406.116R				
All engines	version Bosch, 01/01/88 ->					1.906.219			
All engines							1.970.125	C10	1.965.004

A10 CONDENSER	A20 CONTACT SET	A40 DISTRIBUTOR CAP	A50 ROTOR	A70 PICK-UP
C10 COIL	C20 IGNITION MODULE	C30 ELECTRONIC IGNITION KIT	E01 IGNITION CABLE SET	

Vehicle	alim.	kW	Date	Engine	FUNCTIONS ON THE VEHICLE							
					A10	A20	A40	A50	A70	C10 - C30	C20	E01

ENGINE				
2.2	Petrol	85	01/85-03/88	KX

Engine	Information	A10	A20	A40	A50	A70	C10 - C30	C20	E01
All engines	version Bosch			1.306.093	1.406.055R				
All engines							1.970.132	C10	1.965.004

PASSAT III				
ENGINE				
1.6	Petrol	55	04/88-07/92	1F, ABN, EZ

Engine	Information	A10	A20	A40	A50	A70	C10 - C30	C20	E01
Eng. 1F, EZ	version Bosch, ->ch. 31-M-280 000			1.306.094					
All engines	version Bosch, ch. 31-M-280 001 ->			1.306.266					
All engines	version Bosch				1.406.055R				
Eng. 1F, EZ	version Bosch					1.906.219			
Eng. 1F, EZ	ch. 31-L-000 001 ->, ->ch. 31-M-240 000						1.970.125	C10	
Eng. 1F, EZ	->ch. 31-K-400 000						1.970.126	C10	
Eng. 1F, EZ	ch. 31-M-240 001 ->						1.970.159	C10	
All engines	pole nr. 3						1.990.414	C30	
All engines	pole nr. 6						1.990.416	C30	
Eng. 1F, EZ	->ch. 31-M-240 000								1.965.007
All engines									1.500.725

ENGINE				
1.6	Petrol	74	07/94-08/96	AEK, AFT

Engine	Information	A10	A20	A40	A50	A70	C10 - C30	C20	E01
All engines	version Bosch			1.306.266	1.406.121R				
Eng. AEK	version Ducellier			1.315.068	1.415.099R				
All engines							1.990.414	C30	
Eng. AEK									1.501.551
Eng. AFT									1.501.932

ENGINE				
1.8	Petrol	102	08/91-09/93	KR

Engine	Information	A10	A20	A40	A50	A70	C10 - C30	C20	E01
All engines	version Bosch			1.306.266	1.406.121R	1.906.223			
All engines	ch. 31-L-000 001 ->						1.970.125	C10	
All engines	->ch. 31-K-400 000						1.970.126	C10	
All engines									1.965.007

ENGINE				
1.8	Petrol	55	08/90-05/97	AAM

Engine	Information	A10	A20	A40	A50	A70	C10 - C30	C20	E01
All engines	version Bosch			1.306.266	1.406.121R				
All engines	version Ducellier			1.315.068	1.415.099R				
All engines	pole nr. 3						1.990.414	C30	
All engines	pole nr. 6						1.990.416	C30	
All engines	->year 30/09/93								1.500.725
All engines	01/10/93 ->								1.500.965

ENGINE				
1.8	Petrol	66	02/88-05/97	ABS, ADZ, RP

Engine	Information	A10	A20	A40	A50	A70	C10 - C30	C20	E01
All engines	version Bosch			1.306.266					
Eng. ABS, ADZ	version Ducellier			1.315.068	1.415.099R				
Eng. RP	version Bosch, ->ch. 31-L-400 000				1.406.055R				
All engines	version Bosch, ch. 31-L-400 001 ->				1.406.121R				
Eng. RP	version Bosch					1.906.219			
Eng. RP							1.970.125	C10	
All engines	pole nr. 3						1.990.414	C30	
Eng. RP	pole nr. 6						1.990.416	C30	
Eng. ABS, RP	->year 30/09/93								1.500.725
Eng. ABS, ADZ	01/10/93 ->								1.500.965

ENGINE				
1.8	Petrol	79	04/88-07/93	PF

Engine	Information	A10	A20	A40	A50	A70	C10 - C30	C20	E01
All engines	version Bosch, ch. 31-L-160 001 ->			1.306.094					
All engines	version Bosch, ->ch. 31-L-160 000			1.306.266					
All engines	version Bosch				1.406.121R				

A10	CONDENSER	A20	CONTACT SET	A40	DISTRIBUTOR CAP	A50	ROTOR	A70	PICK-UP
C10	COIL	C20	IGNITION MODULE	C30	ELECTRONIC IGNITION KIT	E01	IGNITION CABLE SET		

The present application list is a brief version. For the detailed information about the possibility of installation on a specific vehicle, please refer to our web-catalogue <http://catalogo.facet.eu/>

Vehicle	alim.	kW	Date	Engine	FUNCTIONS ON THE VEHICLE									
					A10	A20	A40	A50	A70	C10 - C30	C20	E01		
ENGINE														
2.0i	Petrol	78	08/92-12/96	ACX										
Engine	Information				A10	A20	A40	A50	A70	C10 - C30	C20	E01		
All engines	version Bosch						1.306.266	1.406.121R						
All engines										1.990.414	C30		1.500.725	
ENGINE														
2.8 VR6	Petrol	128	06/91-05/97	AAA										
Engine	Information				A10	A20	A40	A50	A70	C10 - C30	C20	E01		
All engines	->year 31/07/93, version Bosch						1.306.233							
All engines	->ch. 31-N-240 000, version Bosch							1.406.148R						
All engines	ch. 31-N-240 001 ->, version Bosch							1.406.149R						
All engines	->ch. 31-P-136 398									1.970.269	C10			
PASSAT IV														
ENGINE														
1.6	Petrol	74	10/96-11/00	ADP, AHL, ANA, ARM										
Engine	Information				A10	A20	A40	A50	A70	C10 - C30	C20	E01		
Eng. ADP	version Bosch						1.306.266	1.406.121R	1.906.223					
Eng. ADP	version Ducellier						1.315.068	1.415.099R						
Eng. AHL, ANA, ARM										1.990.420	C30		1.501.585	
Eng. ADP													1.501.353	
ENGINE														
1.6	Petrol	75	11/00-05/05	ALZ										
Engine	Information				A10	A20	A40	A50	A70	C10 - C30	C20	E01		
All engines										1.990.420	C30		1.501.585	
ENGINE														
1.8	Petrol	85	01/97-11/00	AFY										
Engine	Information				A10	A20	A40	A50	A70	C10 - C30	C20	E01		
All engines													1.501.491	
ENGINE														
1.8	Petrol	92	10/96-03/05	ADR, APT, ARG										
Engine	Information				A10	A20	A40	A50	A70	C10 - C30	C20	E01		
All engines													1.501.491	
ENGINE														
1.8 [CHN]	Petrol	110	06/01->	AWL										
Engine	Information				A10	A20	A40	A50	A70	C10 - C30	C20	E01		
All engines	Qty: 4									1.970.429	C10			
ENGINE														
1.8 [CHN]	Petrol	92	03/00-12/03	ANQ										
Engine	Information				A10	A20	A40	A50	A70	C10 - C30	C20	E01		
All engines	Qty: 4									1.970.445	C10			
ENGINE														
1.8 4motion	Petrol	125	03/01-05/05	AWM										
Engine	Information				A10	A20	A40	A50	A70	C10 - C30	C20	E01		
All engines	Qty: 4									1.970.429	C10			
All engines	x 4, COIL ON PLUG, incl. spark plug connector									1.970.429	C10			
ENGINE														
1.8 Syncro/4motion	Petrol	92	12/96-11/00	ADR, APT, ARG										
Engine	Information				A10	A20	A40	A50	A70	C10 - C30	C20	E01		
All engines													1.501.491	
ENGINE														
1.8 T	Petrol	110	10/96-11/00	AEB, ANB, APU										
Engine	Information				A10	A20	A40	A50	A70	C10 - C30	C20	E01		
All engines	x 4, COIL ON PLUG									1.970.354S	C10			
All engines	ch. 3B-W-045 001 ->												1.965.072	
Eng. AEB	->ch. 3B-W-045 000												1.965.076	
ENGINE														
1.8 T	Petrol	125	02/01-11/05	AWM										
Engine	Information				A10	A20	A40	A50	A70	C10 - C30	C20	E01		
All engines	x 4, COIL ON PLUG, incl. spark plug connector									1.970.429	C10			

A10 CONDENSER	A20 CONTACT SET	A40 DISTRIBUTOR CAP	A50 ROTOR	A70 PICK-UP
C10 COIL	C20 IGNITION MODULE	C30 ELECTRONIC IGNITION KIT	E01 IGNITION CABLE SET	

The present application list is a brief version. For the detailed information about the possibility of installation on a specific vehicle, please refer to our web-catalogue <http://catalogo.facet.eu/>

				FUNCTIONS ON THE VEHICLE								
Vehicle	alim.	kW	Date	Engine	A10	A20	A40	A50	A70	C10 - C30	C20	E01
				ENGINE								
1.8 T 20V	Petrol	110	11/00-05/05	AWL, AWT								
Engine	Information			A10	A20	A40	A50	A70	C10 - C30	C20	E01	
Eng. AWL	Qty: 4								1.970.429	C10		
Eng. AWT	x 4, COIL ON PLUG, incl. spark plug connector								1.970.429	C10		
				ENGINE								
1.8 T 4motion	Petrol	125	11/03-05/05	AWM								
Engine	Information			A10	A20	A40	A50	A70	C10 - C30	C20	E01	
All engines	x 4, COIL ON PLUG, incl. spark plug connector								1.970.429	C10		
				ENGINE								
1.8 T Syncro	Petrol	110	11/96-08/00	AEB								
Engine	Information			A10	A20	A40	A50	A70	C10 - C30	C20	E01	
All engines	incl. spark plug connector, Qty: 4								1.970.354	C10		
All engines	without spark plug connector, Qty: 4								1.970.354	C10		
All engines	ch. 3B-W-045 001 ->										1.965.072	
All engines	->ch. 3B-W-045 000										1.965.076	
				ENGINE								
2.0	Petrol	85	11/00-05/05	AZM, BFF								
Engine	Information			A10	A20	A40	A50	A70	C10 - C30	C20	E01	
Eng. AZM									1.990.420	C30		
Eng. BFF									1.990.420	C30		
All engines												1.501.585
				ENGINE								
2.0	Petrol	96	11/01-05/05	ALT								
Engine	Information			A10	A20	A40	A50	A70	C10 - C30	C20	E01	
All engines	x 4, COIL ON PLUG, incl. spark plug connector								1.970.429	C10		
				ENGINE								
2.0 [CHN]	Petrol	85	06/03->	BFF								
Engine	Information			A10	A20	A40	A50	A70	C10 - C30	C20	E01	
All engines									1.990.420	C30		1.501.585
				ENGINE								
2.0 4motion	Petrol	85	11/00-05/05	AZM								
Engine	Information			A10	A20	A40	A50	A70	C10 - C30	C20	E01	
All engines									1.990.420	C30		1.501.585
				ENGINE								
2.3 V5	Petrol	125	11/00-05/05	AZX								
Engine	Information			A10	A20	A40	A50	A70	C10 - C30	C20	E01	
All engines	x 1, D.I.S.								1.970.437	C10		
				ENGINE								
2.3 V5 4motion	Petrol	125	11/00-05/05	AZX								
Engine	Information			A10	A20	A40	A50	A70	C10 - C30	C20	E01	
All engines	x 1, D.I.S.								1.970.437	C10		
				ENGINE								
2.3 VR5	Petrol	110	10/96-11/00	AGZ								
Engine	Information			A10	A20	A40	A50	A70	C10 - C30	C20	E01	
All engines											1.965.074	
				ENGINE								
2.3 VR5	Petrol	125	11/00-05/05	AZX								
Engine	Information			A10	A20	A40	A50	A70	C10 - C30	C20	E01	
All engines	x 1, D.I.S.								1.970.437	C10		
				ENGINE								
2.3 VR5 4motion	Petrol	125	11/00-05/05	AZX								
Engine	Information			A10	A20	A40	A50	A70	C10 - C30	C20	E01	
All engines	x 1, D.I.S.								1.970.437	C10		
				ENGINE								
2.3 VR5 Syncro/4motion	Petrol	110	10/97-11/00	AGZ								
Engine	Information			A10	A20	A40	A50	A70	C10 - C30	C20	E01	
All engines											1.965.074	

A10 CONDENSER	A20 CONTACT SET	A40 DISTRIBUTOR CAP	A50 ROTOR	A70 PICK-UP
C10 COIL	C20 IGNITION MODULE	C30 ELECTRONIC IGNITION KIT	E01 IGNITION CABLE SET	

Vehicle	alim.	kW	Date	Engine	FUNCTIONS ON THE VEHICLE									
					A10	A20	A40	A50	A70	C10 - C30	C20	E01		
PASSAT V														
1.4 TSI	Petrol	118	11/12-12/14	CTHD										
Engine	Information				A10	A20	A40	A50	A70	C10 - C30	C20	E01		
All engines	x 4, COIL ON PLUG, incl. spark plug connector									1.970.474	C10			
1.4 TSI	Petrol	90	05/07-12/14	CAXA										
Engine	Information				A10	A20	A40	A50	A70	C10 - C30	C20	E01		
All engines	x 4, COIL ON PLUG, incl. spark plug connector									1.970.474	C10			
1.4 TSI EcoFuel	Petrol/ Com- pressed Natural Gas (CNG)	110	01/09-12/14	CDGA										
Engine	Information				A10	A20	A40	A50	A70	C10 - C30	C20	E01		
All engines	x 4, COIL ON PLUG, incl. spark plug connector									1.970.474	C10			
1.4 TSI MultiFuel	Petrol/ Ethanol	118	11/10-12/14	CKMA										
Engine	Information				A10	A20	A40	A50	A70	C10 - C30	C20	E01		
All engines	x 4, COIL ON PLUG, incl. spark plug connector									1.970.474	C10			
1.6	Petrol	75	05/05-11/10	BSE, BSF										
Engine	Information				A10	A20	A40	A50	A70	C10 - C30	C20	E01		
All engines										1.990.420	C30		1.501.585	
1.6 FSI	Petrol	85	03/05-06/08	BLF										
Engine	Information				A10	A20	A40	A50	A70	C10 - C30	C20	E01		
All engines	x 4, COIL ON PLUG, incl. spark plug connector									1.970.474	C10			
1.8 TSI	Petrol	112	11/09-12/14	CDAB, CGYA										
Engine	Information				A10	A20	A40	A50	A70	C10 - C30	C20	E01		
All engines	x 4, ELDOR, Housing Colour:Black, COIL ON PLUG, incl. spark plug connector									1.970.426	C10			
1.8 TSI	Petrol	118	05/07-12/14	BZB, CDAA										
Engine	Information				A10	A20	A40	A50	A70	C10 - C30	C20	E01		
All engines	x 4, ELDOR, Housing Colour:Black, COIL ON PLUG, incl. spark plug connector									1.970.426	C10			
1.8 TSI	Petrol	125	06/13->	CPKA, CPRA										
Engine	Information				A10	A20	A40	A50	A70	C10 - C30	C20	E01		
All engines	Qty: 4, version NAR									1.970.636	C10			
2.0 FSI	Petrol	110	03/05-11/10	BLR, BLY, BVY, BVZ										
Engine	Information				A10	A20	A40	A50	A70	C10 - C30	C20	E01		
All engines	x 4, ELDOR, Housing Colour:Black, COIL ON PLUG, incl. spark plug connector									1.970.426	C10			
2.0 FSI	Petrol	125	08/07-11/10	CCTB										
Engine	Information				A10	A20	A40	A50	A70	C10 - C30	C20	E01		
All engines	Qty: 4									1.970.426	C10			
All engines	x 4, ELDOR, Housing Colour:Black, COIL ON PLUG, incl. spark plug connector									1.970.426	C10			
2.0 FSI 4motion	Petrol	110	09/05-11/10	BLX, BLY, BVX										
Engine	Information				A10	A20	A40	A50	A70	C10 - C30	C20	E01		
All engines	x 4, ELDOR, Housing Colour:Black, COIL ON PLUG, incl. spark plug connector									1.970.426	C10			
2.0 TFSI	Petrol	147	07/05-11/10	AXX, BPY, BWA, CAWB										
Engine	Information				A10	A20	A40	A50	A70	C10 - C30	C20	E01		
All engines	x 4, ELDOR, Housing Colour:Black, COIL ON PLUG, incl. spark plug connector									1.970.426	C10			

A10 CONDENSER	A20 CONTACT SET	A40 DISTRIBUTOR CAP	A50 ROTOR	A70 PICK-UP
C10 COIL	C20 IGNITION MODULE	C30 ELECTRONIC IGNITION KIT	E01 IGNITION CABLE SET	

The present application list is a brief version. For the detailed information about the possibility of installation on a specific vehicle, please refer to our web-catalogue <http://catalogo.facet.eu/>

Vehicle	alim.	kW	Date	Engine	FUNCTIONS ON THE VEHICLE							
					A10	A20	A40	A50	A70	C10 - C30	C20	E01
ENGINE												
2.0 TSI	Petrol	155	11/10-12/15	CCZB								
Engine	Information			A10	A20	A40	A50	A70	C10 - C30	C20	E01	
All engines	x 4, ELDOR, Housing Colour:Black, COIL ON PLUG, incl. spark plug connector								1.970.426	C10		
ENGINE												
2.0 TSI 4motion	Petrol	155	01/12-12/14	CCZB								
Engine	Information			A10	A20	A40	A50	A70	C10 - C30	C20	E01	
All engines	x 4, ELDOR, Housing Colour:Black, COIL ON PLUG, incl. spark plug connector								1.970.426	C10		
ENGINE												
2.5 SRE	Petrol	125	01/11->	CBTA, CBUA, CCA								
Engine	Information			A10	A20	A40	A50	A70	C10 - C30	C20	E01	
All engines	Qty: 5								1.970.426	C10		
ENGINE												
3.2 FSI 4motion	Petrol	184	11/05-11/10	AXZ								
Engine	Information			A10	A20	A40	A50	A70	C10 - C30	C20	E01	
All engines	01/05/07->, ->year 01/04/08, ->ch. 3C8270000, x 6, COIL ON PLUG, incl. spark plug connector								1.970.434	C10		
ENGINE												
3.6 FSI	Petrol	206	06/05-11/10	BLV								
Engine	Information			A10	A20	A40	A50	A70	C10 - C30	C20	E01	
All engines	->ch. 3C-8-270 000, Qty: 6								1.970.434	C10		
ENGINE												
3.6 FSI 4motion	Petrol	206	09/05-11/10	BLV								
Engine	Information			A10	A20	A40	A50	A70	C10 - C30	C20	E01	
All engines	->ch. 3C-8-270 000, Qty: 6								1.970.434	C10		
ENGINE												
3.6 R36 4motion	Petrol	220	04/07-11/10	BWS								
Engine	Information			A10	A20	A40	A50	A70	C10 - C30	C20	E01	
All engines	->year 01/04/08, ->ch. 3C8270000, x 6, COIL ON PLUG, x 6, COIL ON PLUG, incl. spark plug connector, incl. spark plug connector								1.970.434	C10		
PASSAT VI												
ENGINE												
1.4 GTE Hybrid	Petrol/ Electric	115	06/15->	CUKC, DGEB								
Engine	Information			A10	A20	A40	A50	A70	C10 - C30	C20	E01	
All engines	x 4, BERU, ELDOR, COIL ON PLUG, incl. spark plug connector, Number of pins:4, incl. spark plug connector								1.970.599	C10		
ENGINE												
1.4 TSI	Petrol	110	11/14->	CZDA, CZIA								
Engine	Information			A10	A20	A40	A50	A70	C10 - C30	C20	E01	
All engines	x 4, BERU, ELDOR, HITACHI, COIL ON PLUG, incl. spark plug connector, Number of pins:4, incl. spark plug connector								1.970.599	C10		
ENGINE												
1.4 TSI	Petrol	92	11/14->	CZCA								
Engine	Information			A10	A20	A40	A50	A70	C10 - C30	C20	E01	
All engines	x 4, BERU, ELDOR, COIL ON PLUG, incl. spark plug connector, Number of pins:4, incl. spark plug connector								1.970.599	C10		
ENGINE												
1.4 TSI 4motion	Petrol	110	02/15->	CZEA								
Engine	Information			A10	A20	A40	A50	A70	C10 - C30	C20	E01	
All engines	x 4, BERU, ELDOR, COIL ON PLUG, incl. spark plug connector, Number of pins:4, incl. spark plug connector								1.970.599	C10		
ENGINE												
1.8 TSI	Petrol	132	02/15->	CJSA, CJSC								
Engine	Information			A10	A20	A40	A50	A70	C10 - C30	C20	E01	
All engines	x 4, HITACHI, COIL ON PLUG, incl. spark plug connector								1.970.636	C10		
ENGINE												
2.0 TSI	Petrol	140	11/18->	CZPB, DKZA, DRFA								
Engine	Information			A10	A20	A40	A50	A70	C10 - C30	C20	E01	
All engines	x 4, HITACHI, COIL ON PLUG, incl. spark plug connector								1.970.636	C10		

A10 CONDENSER	A20 CONTACT SET	A40 DISTRIBUTOR CAP	A50 ROTOR	A70 PICK-UP
C10 COIL	C20 IGNITION MODULE	C30 ELECTRONIC IGNITION KIT	E01 IGNITION CABLE SET	

Vehicle	alim.	kW	Date	Engine	FUNCTIONS ON THE VEHICLE							
					A10	A20	A40	A50	A70	C10 - C30	C20	E01

ENGINE				
2.0 TSI	Petrol	162	08/14->	CXDA

Engine	Information	A10	A20	A40	A50	A70	C10 - C30	C20	E01
All engines	x 4, BERU, COIL ON PLUG, incl. spark plug connector						1.970.636	C10	

PHAETON

ENGINE				
3.2 V6	Petrol	177	04/02-05/05	AYT, BKL

Engine	Information	A10	A20	A40	A50	A70	C10 - C30	C20	E01
All engines	x 6, COIL ON PLUG						1.970.434	C10	

ENGINE				
3.2 V6 4motion	Petrol	177	02/04-11/08	BKL, BRK

Engine	Information	A10	A20	A40	A50	A70	C10 - C30	C20	E01
All engines	x 6, COIL ON PLUG						1.970.434	C10	

ENGINE				
4.2 V8 4motion	Petrol	246	05/03-03/16	BGH, BGJ

Engine	Information	A10	A20	A40	A50	A70	C10 - C30	C20	E01
All engines	x 8, COIL ON PLUG						1.970.425	C10	

POLO II

ENGINE				
1.0	Petrol	29	10/81-10/86	GL

Engine	Information	A10	A20	A40	A50	A70	C10 - C30	C20	E01
All engines	version Bosch	1.106.196	1.206.049HVS		1.406.114R				
All engines	version Bosch, ->ch. 86-E-150 000			1.306.079					
All engines	version Bosch, ch. 86-E-150 001 ->			1.306.094					
All engines	version Bosch, +catalytic converter				1.406.056R				
All engines	ch. ...E-150 001 ->, ->ch. 80-K-140 000								1.500.493

ENGINE				
1.0	Petrol	33	01/85-09/94	AAK, AAU, HZ

Engine	Information	A10	A20	A40	A50	A70	C10 - C30	C20	E01
All engines	version Bosch, ->ch. 80-M-100 000			1.306.094					
Eng. AAU, HZ	version Bosch, ch. 80-M-100 001 ->			1.306.266					
Eng. AAK, HZ	version Bosch				1.406.056R				
Eng. AAU	version Bosch				1.406.121R	1.906.223			
Eng. AAK, HZ	version Bosch, ->ch. 80-M-100 000					1.906.193			
Eng. HZ	version Bosch, ch. 80-M-100 001 ->					1.906.234			
Eng. AAK, HZ	ch. ...G-000 001 ->, ->ch. 80-H-220 000, ch. 80-L-000 001 ->, ->year 30/09/90						1.970.125	C10	
Eng. HZ	ch. 80-J-000 001 ->, ->ch. 80-K-220 000						1.970.126	C10	
Eng. AAU, HZ	01/10/90 ->, pole nr. 3						1.990.414	C30	
Eng. HZ	01/10/90 ->, pole nr. 6						1.990.416	C30	
Eng. HZ	->ch. ...H-060 000							1.965.004	
Eng. AAK, HZ	ch. ...H-060 001 ->							1.965.007	
Eng. AAK, HZ	ch. ...E-150 001 ->, ->ch. 80-K-140 000								1.500.493
Eng. AAU, HZ	ch. 80-P-320 001 ->								1.501.364
Eng. AAU, HZ	01/10/90 ->, ->ch. 80-P-320 000								1.501.518

ENGINE				
1.0 Cat	Petrol	33	08/89-09/94	AAK, AAU, ACM

Engine	Information	A10	A20	A40	A50	A70	C10 - C30	C20	E01
Eng. AAK, AAU	version Bosch, ->ch. 80-M-100 000			1.306.094					
Eng. AAU, ACM	version Bosch, ch. 80-M-100 001 ->			1.306.266					
Eng. AAK, ACM	version Bosch				1.406.056R				
Eng. AAU	version Bosch				1.406.121R	1.906.223			
Eng. AAK	version Bosch					1.906.193			
Eng. ACM	version Bosch					1.906.234			
Eng. AAK							1.970.125	C10	1.965.007
Eng. AAU, ACM	pole nr. 3						1.990.414	C30	
Eng. ACM	pole nr. 6						1.990.416	C30	
Eng. AAK	ch. ...E-150 001 ->, ->ch. 80-K-140 000								1.500.493
Eng. AAU, ACM	ch. 80-P-320 001 ->								1.501.364
Eng. AAU, ACM	->ch. 80-P-320 000								1.501.518

A10 CONDENSER	A20 CONTACT SET	A40 DISTRIBUTOR CAP	A50 ROTOR	A70 PICK-UP
C10 COIL	C20 IGNITION MODULE	C30 ELECTRONIC IGNITION KIT	E01 IGNITION CABLE SET	

The present application list is a brief version. For the detailed information about the possibility of installation on a specific vehicle, please refer to our web-catalogue <http://catalogo.facet.eu/>

				FUNCTIONS ON THE VEHICLE								
Vehicle	alim.	kW	Date	Engine								
					A10	A20	A40	A50	A70	C10 - C30	C20	E01

ENGINE				
1.1	Petrol	37	10/81-09/89	HB

Engine	Information	A10	A20	A40	A50	A70	C10 - C30	C20	E01
All engines	version Bosch	1.106.195	1.206.049HVS		1.406.026R				
All engines	version Bosch, ->ch. 86-E-150 000			1.306.079					
All engines	version Bosch, ch. 86-E-150 001 ->			1.306.094					
All engines	version Ducellier				1.415.089R				
All engines	->ch. 80-K-140 000, ch. ...-E-150 001 ->								1.500.493

ENGINE				
1.3	Petrol	37	08/83-07/85	HW

Engine	Information	A10	A20	A40	A50	A70	C10 - C30	C20	E01
All engines	version Bosch	1.106.195	1.206.049HVS	1.306.079	1.406.114R				
All engines	ch. ...-E-150 001 ->, ->ch. 80-K-140 000								1.500.493

ENGINE				
1.3	Petrol	40	08/83-07/94	AAV, HK, MH

Engine	Information	A10	A20	A40	A50	A70	C10 - C30	C20	E01
Eng. HK	version Bosch	1.106.195	1.206.049HVS		1.406.114R				
Eng. HK	version Bosch, ->ch. 86-E-150 000			1.306.079					
All engines	version Bosch, ch. 86-E-150 001 ->, ->ch. 80-M-100 000			1.306.094					
Eng. AAV	version Bosch, ch. 80-M-100 001 ->			1.306.266					
Eng. MH	version Bosch				1.406.056R	1.906.193			
Eng. AAV	version Bosch				1.406.121R	1.906.223			
Eng. AAV							1.990.414	C30	
Eng. MH	->ch. ...-H-060 000								1.965.004
Eng. MH	ch. ...-H-060 001 ->								1.965.007
Eng. HK, MH	ch. ...-E-150 001 ->, ->ch. 80-K-140 000								1.500.493
Eng. AAV	ch. 80-P-320 001 ->								1.501.364
Eng. AAV	->ch. 80-P-320 000								1.501.518

ENGINE				
1.3	Petrol	43	08/82-07/88	GT, HJ

Engine	Information	A10	A20	A40	A50	A70	C10 - C30	C20	E01
All engines	version Bosch	1.106.195	1.206.049HVS		1.406.026R				
All engines	version Bosch, ->ch. 86-E-150 000			1.306.079					
All engines	version Bosch, ch. 86-E-150 001 ->			1.306.094					
All engines	ch. ...-E-150 001 ->, ->ch. 80-K-140 000								1.500.493

ENGINE				
1.3	Petrol	44	10/81-07/83	HH

Engine	Information	A10	A20	A40	A50	A70	C10 - C30	C20	E01
All engines	version Bosch	1.106.195	1.206.049HVS	1.306.079	1.406.026R				
All engines	version Ducellier				1.415.089R				
All engines	ch. ...-E-150 001 ->, ->ch. 80-K-140 000								1.500.493

ENGINE				
1.3	Petrol	55	09/82-09/89	GK

Engine	Information	A10	A20	A40	A50	A70	C10 - C30	C20	E01
All engines	version Bosch, ->ch. 86-E-150 000			1.306.079					
All engines	version Bosch, ch. 86-E-150 001 ->			1.306.094					
All engines	version Bosch, ->eng. GK012.822				1.406.056R				
All engines	version Bosch, eng. type GK012.823 ->				1.406.121R				
All engines	version Bosch					1.906.223			
All engines	ch. ...-E-150 001 ->, ->ch. 80-H-220 000						1.970.125	C10	
All engines	ch. 80-J-000 001 ->, ->ch. 80-K-220 000						1.970.126	C10	
All engines	->ch. ...-E-150 000						1.970.132	C10	
All engines	ch. ...-E-150 001 ->, ->ch. 80-K-140 000								1.500.493

ENGINE				
1.3	Petrol	56	10/90-08/94	3F

Engine	Information	A10	A20	A40	A50	A70	C10 - C30	C20	E01
All engines	version Bosch, ->ch. 80-M-100 000			1.306.094					
All engines	version Bosch, ch. 80-M-100 001 ->			1.306.266					
All engines	version Bosch				1.406.121R				
All engines	version Bosch, 01/10/90 ->					1.906.233			
All engines	->year 30/09/90						1.970.125	C10	1.965.007
All engines	01/10/90 ->						1.990.414	C30	
All engines	ch. 80-P-320 001 ->								1.501.364

A10	CONDENSER	A20	CONTACT SET	A40	DISTRIBUTOR CAP	A50	ROTOR	A70	PICK-UP
C10	COIL	C20	IGNITION MODULE	C30	ELECTRONIC IGNITION KIT	E01	IGNITION CABLE SET		

Vehicle	alim.	kW	Date	Engine	FUNCTIONS ON THE VEHICLE							
					A10	A20	A40	A50	A70	C10 - C30	C20	E01
ENGINE												
1.3	Petrol	56	10/90-08/94	3F								
Engine	Information			A10	A20	A40	A50	A70	C10 - C30	C20	E01	
All engines	01/10/90 ->, ->ch. 80-P-320 000										1.501.518	
ENGINE												
1.3	Petrol	57	03/91-09/94	3F								
Engine	Information			A10	A20	A40	A50	A70	C10 - C30	C20	E01	
All engines	version Bosch, ->ch. 80-M-100 000					1.306.094						
All engines	version Bosch, ch. 80-M-100 001 ->					1.306.266						
All engines	version Bosch						1.406.121R					
All engines	version Bosch, 01/10/90 ->							1.906.233				
All engines	->year 30/09/90								1.970.125	C10	1.965.007	
All engines	01/10/90 ->								1.990.414	C30		
All engines	ch. 80-P-320 001 ->										1.501.364	
All engines	01/10/90 ->, ->ch. 80-P-320 000										1.501.518	
ENGINE												
1.3 Cat	Petrol	40	07/87-09/94	2G, AAV, MH, NZ								
Engine	Information			A10	A20	A40	A50	A70	C10 - C30	C20	E01	
All engines	version Bosch, ->ch. 80-M-100 000					1.306.094						
Eng. 2G, AAV	version Bosch, ch. 80-M-100 001 ->					1.306.266						
Eng. 2G, MH, NZ	version Bosch						1.406.056R					
Eng. AAV	version Bosch						1.406.121R	1.906.223				
Eng. 2G, MH, NZ	version Bosch, ->ch. 80-M-100 000							1.906.193				
Eng. 2G	version Bosch, ch. 80-M-100 001 ->							1.906.234				
Eng. 2G, MH, NZ	ch. ...-G-000 001 ->, ->ch. 80-H-220 000, ch. 80-L-000 001 ->, ->year 30/09/90								1.970.125	C10		
Eng. 2G, MH, NZ	ch. 80-J-000 001 ->, ->ch. 80-K-220 000								1.970.126	C10		
All engines	01/10/90 ->, pole nr. 3								1.990.414	C30		
Eng. 2G, MH, NZ	01/10/90 ->, pole nr. 6								1.990.416	C30		
Eng. MH, NZ	->ch. ...-H-060 000										1.965.004	
Eng. 2G, MH, NZ	ch. ...-H-060 001 ->, ->year 30/09/90										1.965.007	
Eng. 2G, MH, NZ	ch. ...-E-150 001 ->, ->ch. 80-K-140 000										1.500.493	
All engines	ch. 80-P-320 001 ->										1.501.364	
All engines	01/10/90 ->, ->ch. 80-P-320 000										1.501.518	
ENGINE												
1.3 Cat	Petrol	55	10/89-09/94	3F								
Engine	Information			A10	A20	A40	A50	A70	C10 - C30	C20	E01	
All engines	version Bosch, ->ch. 80-M-100 000					1.306.094						
All engines	version Bosch, ch. 80-M-100 001 ->					1.306.266						
All engines	version Bosch						1.406.121R					
All engines	version Bosch, 01/10/90 ->							1.906.233				
All engines	->year 30/09/90								1.970.125	C10	1.965.007	
All engines	01/10/90 ->								1.990.414	C30		
All engines	ch. 80-P-320 001 ->										1.501.364	
All engines	01/10/90 ->, ->ch. 80-P-320 000										1.501.518	
ENGINE												
1.3 G40	Petrol	83	08/90-09/94	PY								
Engine	Information			A10	A20	A40	A50	A70	C10 - C30	C20	E01	
All engines	version Bosch, ->ch. 80-M-100 000					1.306.094						
All engines	version Bosch, ch. 80-M-100 001 ->					1.306.266						
All engines	version Bosch						1.406.121R	1.906.233				
All engines	ch. 80-P-320 001 ->								1.990.414	C30		
All engines	->ch. 80-P-320 000										1.501.518	
ENGINE												
1.3 G40	Petrol	85	01/87-08/90	PY								
Engine	Information			A10	A20	A40	A50	A70	C10 - C30	C20	E01	
All engines	version Bosch					1.306.094	1.406.121R	1.906.233				
All engines	->ch. 80-K-140 000, ch. ...-E-150 001 ->								1.970.125	C10	1.965.007	
All engines											1.500.493	

A10	CONDENSER	A20	CONTACT SET	A40	DISTRIBUTOR CAP	A50	ROTOR	A70	PICK-UP
C10	COIL	C20	IGNITION MODULE	C30	ELECTRONIC IGNITION KIT	E01	IGNITION CABLE SET		

The present application list is a brief version. For the detailed information about the possibility of installation on a specific vehicle, please refer to our web-catalogue <http://catalogo.facet.eu/>

Vehicle	alim.	kW	Date	Engine	FUNCTIONS ON THE VEHICLE							
					A10	A20	A40	A50	A70	C10 - C30	C20	E01

POLO III

1.0	Petrol	33	10/94-12/99	ENGINE AEV
------------	--------	-----------	-------------	----------------------

Engine	Information	A10	A20	A40	A50	A70	C10 - C30	C20	E01
All engines							1.990.414	C30	

1.0	Petrol	37	05/99-05/02	ENGINE AER, ALD, ALL, AUC
------------	--------	-----------	-------------	-------------------------------------

Engine	Information	A10	A20	A40	A50	A70	C10 - C30	C20	E01
All engines							1.990.414	C30	
Eng. ALD, AUC							1.990.420	C30	1.501.601

1.4	Petrol	40	12/98-09/01	ENGINE AEX, AKP, ANX
------------	--------	-----------	-------------	--------------------------------

Engine	Information	A10	A20	A40	A50	A70	C10 - C30	C20	E01
Eng. ANX	version Bosch			1.306.094	1.406.121R	1.906.223			
Eng. ANX	version Marelli			1.330.116	1.430.057R				
Eng. AEX, ANX							1.990.414	C30	
Eng. AKP							1.990.420	C30	1.501.601
Eng. ANX									1.501.640

1.4	Petrol	44	05/97-09/01	ENGINE AEX, AKK, AKV, ANW, APQ, AUD
------------	--------	-----------	-------------	---

Engine	Information	A10	A20	A40	A50	A70	C10 - C30	C20	E01
Eng. AEX, AKV, APQ	version Bosch			1.306.094	1.406.121R	1.906.223			
Eng. AEX, AKV, APQ	version Marelli			1.330.116	1.430.057R				
Eng. AEX, AKV, APQ							1.990.414	C30	
Eng. APQ							1.990.414	C30	
Eng. AKK, ANW, AUD							1.990.420	C30	1.501.601
Eng. AEX, AKV, APQ	->ch. 6N-V-300 000								1.501.640
Eng. AEX	ch. 6N-W-000 001 ->								1.501.641

1.4	Petrol	55	06/00-09/01	ENGINE AUA
------------	--------	-----------	-------------	----------------------

Engine	Information	A10	A20	A40	A50	A70	C10 - C30	C20	E01
All engines							1.990.420	C30	

1.4 16V	Petrol	55	10/99-09/01	ENGINE AHW, APE, AUA
----------------	--------	-----------	-------------	--------------------------------

Engine	Information	A10	A20	A40	A50	A70	C10 - C30	C20	E01
All engines							1.990.420	C30	1.501.575

1.4 16V	Petrol	74	10/99-09/01	ENGINE AFH, AFK, AUB
----------------	--------	-----------	-------------	--------------------------------

Engine	Information	A10	A20	A40	A50	A70	C10 - C30	C20	E01
Eng. AFH							1.990.414	C30	
Eng. AFK, AUB							1.990.420	C30	1.501.575

1.6	Petrol	55	09/94-09/01	ENGINE AEA, AEE, ALM
------------	--------	-----------	-------------	--------------------------------

Engine	Information	A10	A20	A40	A50	A70	C10 - C30	C20	E01
All engines	version Bosch			1.306.094	1.406.121R	1.906.223			
All engines	version Marelli			1.330.116	1.430.057R				
Eng. AEE, ALM							1.990.414	C30	1.501.640
Eng. AEA							1.990.414	C30	

1.6	Petrol	65	05/96-09/01	ENGINE AKL
------------	--------	-----------	-------------	----------------------

Engine	Information	A10	A20	A40	A50	A70	C10 - C30	C20	E01
All engines							1.990.420	C30	

1.6	Petrol	74	05/97-09/01	ENGINE AEH, AFT, AKL, APF, AUR
------------	--------	-----------	-------------	--

Engine	Information	A10	A20	A40	A50	A70	C10 - C30	C20	E01
Eng. AFT	version Bosch			1.306.266	1.406.121R	1.906.223			
Eng. AFT							1.990.414	C30	1.501.932
Eng. AEH, AKL, APF, AUR							1.990.420	C30	
Eng. AEH, AKL									1.501.484
Eng. APF, AUR									1.501.585
Eng. AFT	+automatic transmission								1.501.933

A10 CONDENSER	A20 CONTACT SET	A40 DISTRIBUTOR CAP	A50 ROTOR	A70 PICK-UP
C10 COIL	C20 IGNITION MODULE	C30 ELECTRONIC IGNITION KIT	E01 IGNITION CABLE SET	

Vehicle	alim.	kW	Date	Engine	FUNCTIONS ON THE VEHICLE									
					A10	A20	A40	A50	A70	C10 - C30	C20	E01		
ENGINE														
1.6 16V GTI	Petrol	92	10/99-09/01	ARC, AVY										
Engine	Information				A10	A20	A40	A50	A70	C10 - C30	C20	E01		
All engines										1.990.420	C30		1.501.575	
ENGINE														
100 1.4 16V	Petrol	74	04/96-10/99	AFH, AFK, AUB										
Engine	Information				A10	A20	A40	A50	A70	C10 - C30	C20	E01		
Eng. AFH	version Bosch						1.306.094	1.406.121R	1.906.223					
Eng. AFH	version Marelli						1.330.116	1.430.057R						
Eng. AFH										1.990.414	C30		1.501.580	
Eng. AFK, AUB										1.990.420	C30			
ENGINE														
100 1.6	Petrol	74	12/95-09/01	AEH, AFT, AKL, APF, AUR										
Engine	Information				A10	A20	A40	A50	A70	C10 - C30	C20	E01		
Eng. AFT	version Bosch						1.306.266	1.406.121R	1.906.223					
Eng. AFT										1.990.414	C30		1.501.932	
Eng. AEH, AKL, APF, AUR										1.990.420	C30			
Eng. AEH, AKL													1.501.484	
Eng. APF, AUR													1.501.585	
Eng. AFT	+automatic transmission												1.501.933	
ENGINE														
120 1.6 16V GTI	Petrol	88	09/98-10/99	AJV										
Engine	Information				A10	A20	A40	A50	A70	C10 - C30	C20	E01		
All engines										1.990.420	C30		1.501.575	
ENGINE														
2.0	Petrol	85	08/99-09/01	ADC										
Engine	Information				A10	A20	A40	A50	A70	C10 - C30	C20	E01		
All engines	version Bosch						1.306.266	1.406.121R						
All engines										1.990.414	C30			
All engines	->ch. 6K-Y-502 794												1.501.551	
ENGINE														
45 1.0	Petrol	33	10/94-09/96	AEV										
Engine	Information				A10	A20	A40	A50	A70	C10 - C30	C20	E01		
All engines	version Bosch						1.306.094	1.406.121R	1.906.223					
All engines										1.990.414	C30		1.501.364	
ENGINE														
50 1.0	Petrol	37	09/96-10/99	AER, ALD, ALL, AUC										
Engine	Information				A10	A20	A40	A50	A70	C10 - C30	C20	E01		
Eng. AER, ALL	version Bosch						1.306.094	1.406.121R	1.906.223					
Eng. AER, ALL	version Marelli						1.330.116	1.430.057R						
All engines										1.990.414	C30			
Eng. ALD, AUC										1.990.420	C30			
Eng. AER	->ch. 6N-V-300 000												1.501.364	
Eng. AER, ALL	ch. 6N-W-000 001 ->												1.501.641	
ENGINE														
54 1.4	Petrol	40	01/98-08/99	ANX										
Engine	Information				A10	A20	A40	A50	A70	C10 - C30	C20	E01		
All engines	version Bosch						1.306.094	1.406.121R	1.906.223					
All engines	version Marelli						1.330.116	1.430.057R						
All engines										1.990.414	C30		1.501.640	
ENGINE														
55 1.3	Petrol	40	10/94-04/97	ADX										
Engine	Information				A10	A20	A40	A50	A70	C10 - C30	C20	E01		
All engines	version Bosch						1.306.094	1.406.121R	1.906.223					
All engines	version Marelli						1.330.116	1.430.057R						
All engines										1.990.414	C30		1.501.364	
ENGINE														
55 1.4	Petrol	40	08/95-10/99	AEX, AKP, ANX										
Engine	Information				A10	A20	A40	A50	A70	C10 - C30	C20	E01		
Eng. AEX	version Bosch						1.306.094	1.406.121R	1.906.223					
Eng. AEX	version Marelli						1.330.116	1.430.057R						
Eng. AEX, ANX										1.990.414	C30			

A10 CONDENSER	A20 CONTACT SET	A40 DISTRIBUTOR CAP	A50 ROTOR	A70 PICK-UP
C10 COIL	C20 IGNITION MODULE	C30 ELECTRONIC IGNITION KIT	E01 IGNITION CABLE SET	

The present application list is a brief version. For the detailed information about the possibility of installation on a specific vehicle, please refer to our web-catalogue <http://catalogo.facet.eu/>

Vehicle	alim.	kW	Date	Engine	FUNCTIONS ON THE VEHICLE							
					A10	A20	A40	A50	A70	C10 - C30	C20	E01

ENGINE				
55 1.4	Petrol	40	08/95-10/99	AEX, AKP, ANX

Engine	Information	A10	A20	A40	A50	A70	C10 - C30	C20	E01
Eng. AKP							1.990.420	C30	
Eng. AEX	->ch. 6N-V-300 000								1.501.640
Eng. AEX	ch. 6N-W-000 001 ->								1.501.641

ENGINE				
60 1.4	Petrol	44	07/95-09/01	AEX, AKK, AKV, ANW, APQ, AUD

Engine	Information	A10	A20	A40	A50	A70	C10 - C30	C20	E01
Eng. AEX, AKV, APQ	version Bosch			1.306.094	1.406.121R	1.906.223			
Eng. AEX, AKV, APQ	version Marelli			1.330.116	1.430.057R				
Eng. AEX, AKV, APQ							1.990.414	C30	
Eng. AKK, ANW, AUD							1.990.420	C30	1.501.601
Eng. AEX, AKV, APQ	->ch. 6N-V-300 000								1.501.640
Eng. AEX, AKV	ch. 6N-W-000 001 ->								1.501.641

ENGINE				
75 1.4 16V	Petrol	55	10/99-09/01	APE, AUA

Engine	Information	A10	A20	A40	A50	A70	C10 - C30	C20	E01
All engines							1.990.420	C30	1.501.575

ENGINE				
75 1.6	Petrol	55	10/94-09/01	1F, AEA, AEE, AHS, ALM

Engine	Information	A10	A20	A40	A50	A70	C10 - C30	C20	E01
Eng. AEA, AEE, AHS, ALM	version Bosch			1.306.094		1.906.223			
Eng. 1F	version Bosch			1.306.266					
Eng. 1F	version Ducellier			1.315.068	1.415.099R				
Eng. AEA, AEE, AHS, ALM	version Marelli			1.330.116	1.430.057R				
All engines	version Bosch				1.406.121R				
All engines							1.990.414	C30	
Eng. 1F									1.500.965
Eng. AEE, ALM	->ch. 6N-V-300 000								1.501.640
Eng. AEE, AHS	ch. 6N-W-000 001 ->								1.501.641

ENGINE				
75 1.6 4motion	Petrol	55	08/95-10/99	AEA

Engine	Information	A10	A20	A40	A50	A70	C10 - C30	C20	E01
All engines	version Bosch			1.306.094	1.406.121R	1.906.223			
All engines	version Marelli			1.330.116	1.430.057R				

ENGINE				
90 1.8	Petrol	66	01/97-09/01	ADD

Engine	Information	A10	A20	A40	A50	A70	C10 - C30	C20	E01
All engines	version Bosch			1.306.266	1.406.121R				
All engines							1.990.414	C30	1.501.549

POLO IV				
---------	--	--	--	--

ENGINE				
1.0	Petrol	37	08/96-12/01	AER

Engine	Information	A10	A20	A40	A50	A70	C10 - C30	C20	E01
All engines	version Bosch			1.306.094	1.406.121R	1.906.223			
All engines	version Marelli			1.330.116	1.430.057R				
All engines							1.990.414	C30	
All engines	->ch. 6N-V-300 000								1.501.364
All engines	ch. 6N-W-000 001 ->								1.501.641

ENGINE				
1.0	Petrol	58	02/03-10/03	ARA

Engine	Information	A10	A20	A40	A50	A70	C10 - C30	C20	E01
All engines									1.501.575

ENGINE				
1.2	Petrol	40	01/02-05/07	AWY, BMD

Engine	Information	A10	A20	A40	A50	A70	C10 - C30	C20	E01
All engines	x 3, COIL ON PLUG, incl. spark plug connector						1.970.431	C10	

A10 CONDENSER	A20 CONTACT SET	A40 DISTRIBUTOR CAP	A50 ROTOR	A70 PICK-UP
C10 COIL	C20 IGNITION MODULE	C30 ELECTRONIC IGNITION KIT	E01 IGNITION CABLE SET	

Vehicle	alim.	kW	Date	Engine	FUNCTIONS ON THE VEHICLE									
					A10	A20	A40	A50	A70	C10 - C30	C20	E01		
ENGINE														
1.2	Petrol	44	05/07-11/09	BBM										
ENGINE														
Engine					Information	A10	A20	A40	A50	A70	C10 - C30	C20	E01	
All engines					x 3, COIL ON PLUG, incl. spark plug connector						1.970.431	C10		
1.2 12V	Petrol	47	10/01-07/07	AZQ, BME										
ENGINE														
Engine					Information	A10	A20	A40	A50	A70	C10 - C30	C20	E01	
All engines					x 3, COIL ON PLUG, incl. spark plug connector						1.970.474	C10		
1.2 12V	Petrol	51	05/07-11/09	BZG										
ENGINE														
Engine					Information	A10	A20	A40	A50	A70	C10 - C30	C20	E01	
All engines					x 3, COIL ON PLUG, incl. spark plug connector						1.970.474	C10		
1.4	Petrol	55	11/02-04/12	BBY, BKY										
ENGINE														
Engine					Information	A10	A20	A40	A50	A70	C10 - C30	C20	E01	
All engines					x 4, COIL ON PLUG, incl. spark plug connector						1.970.474	C10		
1.4	Petrol	61	08/02-08/10	BLM										
ENGINE														
Engine					Information	A10	A20	A40	A50	A70	C10 - C30	C20	E01	
All engines											1.990.420	C30	1.501.723	
1.4	Petrol	63	12/03-05/05	BLM										
ENGINE														
Engine					Information	A10	A20	A40	A50	A70	C10 - C30	C20	E01	
All engines											1.990.420	C30	1.501.723	
1.4	Petrol	74	11/03-06/05	BBZ										
ENGINE														
Engine					Information	A10	A20	A40	A50	A70	C10 - C30	C20	E01	
All engines					x 4, COIL ON PLUG, incl. spark plug connector						1.970.474	C10		
1.4 16V	Petrol	55	10/01-05/08	AUA, BBY, BKY										
ENGINE														
Engine					Information	A10	A20	A40	A50	A70	C10 - C30	C20	E01	
Eng. BBY, BKY					x 4, COIL ON PLUG, incl. spark plug connector						1.970.474	C10		
Eng. AUA											1.990.420	C30	1.501.575	
1.4 16V	Petrol	59	05/06-11/09	BUD										
ENGINE														
Engine					Information	A10	A20	A40	A50	A70	C10 - C30	C20	E01	
All engines					x 4, COIL ON PLUG, incl. spark plug connector						1.970.474	C10		
1.4 16V	Petrol	74	10/01-05/08	AUB, BBZ										
ENGINE														
Engine					Information	A10	A20	A40	A50	A70	C10 - C30	C20	E01	
All engines					x 4, COIL ON PLUG, incl. spark plug connector						1.970.474	C10		
1.4 BiFuel	Petrol/ Liquified Petroleum Gas (LPG)	60	05/06-11/09	BUD										
ENGINE														
Engine					Information	A10	A20	A40	A50	A70	C10 - C30	C20	E01	
All engines					x 4, COIL ON PLUG, incl. spark plug connector						1.970.474	C10		
1.4 FSI	Petrol	63	02/02-07/06	AXU										
ENGINE														
Engine					Information	A10	A20	A40	A50	A70	C10 - C30	C20	E01	
All engines					x 4, COIL ON PLUG, incl. spark plug connector						1.970.474	C10		
1.6	Petrol	74	08/02->	BAH, BPA										
ENGINE														
Engine					Information	A10	A20	A40	A50	A70	C10 - C30	C20	E01	
All engines											1.990.420	C30	1.501.723	
Eng. BAH											1.990.420	C30		
1.6 16V	Petrol	77	05/06-11/09	BTS										
ENGINE														
Engine					Information	A10	A20	A40	A50	A70	C10 - C30	C20	E01	
All engines					x 4, COIL ON PLUG, incl. spark plug connector						1.970.474	C10		

A10	CONDENSER	A20	CONTACT SET	A40	DISTRIBUTOR CAP	A50	ROTOR	A70	PICK-UP
C10	COIL	C20	IGNITION MODULE	C30	ELECTRONIC IGNITION KIT	E01	IGNITION CABLE SET		

The present application list is a brief version. For the detailed information about the possibility of installation on a specific vehicle, please refer to our web-catalogue <http://catalogo.facet.eu/>

Vehicle	alim.	kW	Date	Engine	FUNCTIONS ON THE VEHICLE							
					A10	A20	A40	A50	A70	C10 - C30	C20	E01

ENGINE												
1.6 Flex	Petrol/ Ethanol	76	12/04-10/14	BPA								
Engine	Information				A10	A20	A40	A50	A70	C10 - C30	C20	E01
All engines										1.990.420	C30	1.501.723

ENGINE												
1.6 Total Flex	Petrol/ Ethanol	74	10/04-06/06	BPA								
Engine	Information				A10	A20	A40	A50	A70	C10 - C30	C20	E01
All engines										1.990.420	C30	1.501.723

ENGINE												
1.8 GTI	Petrol	110	09/05-11/09	BJX								
Engine	Information				A10	A20	A40	A50	A70	C10 - C30	C20	E01
All engines	x 4, COIL ON PLUG, incl. spark plug connector									1.970.429	C10	

ENGINE												
1.8 GTi Cup Edition	Petrol	132	05/06-11/09	BBU								
Engine	Information				A10	A20	A40	A50	A70	C10 - C30	C20	E01
All engines	x 4, COIL ON PLUG, incl. spark plug connector									1.970.429	C10	

ENGINE												
2.0	Petrol	85	09/02->	BBX								
Engine	Information				A10	A20	A40	A50	A70	C10 - C30	C20	E01
All engines										1.990.420	C30	1.501.585

POLO V

ENGINE												
1.0	Petrol	44	01/14->	CHYA								
Engine	Information				A10	A20	A40	A50	A70	C10 - C30	C20	E01
All engines	x 3, BERU, ELDOR, COIL ON PLUG, incl. spark plug connector, Number of pins:4, incl. spark plug connector									1.970.599	C10	

ENGINE												
1.0	Petrol	55	01/14->	CHYB								
Engine	Information				A10	A20	A40	A50	A70	C10 - C30	C20	E01
All engines	x 3, BERU, ELDOR, COIL ON PLUG, incl. spark plug connector, Number of pins:4, incl. spark plug connector									1.970.599	C10	

ENGINE												
1.0 TSI	Petrol	70	11/14->	CHZB								
Engine	Information				A10	A20	A40	A50	A70	C10 - C30	C20	E01
All engines	x 3, BERU, ELDOR, COIL ON PLUG, incl. spark plug connector, Number of pins:4, incl. spark plug connector									1.970.599	C10	

ENGINE												
1.0 TSI	Petrol	81	11/14->	CHZC								
Engine	Information				A10	A20	A40	A50	A70	C10 - C30	C20	E01
All engines	x 3, BERU, ELDOR, COIL ON PLUG, incl. spark plug connector, Number of pins:4, incl. spark plug connector									1.970.599	C10	

ENGINE												
1.2	Petrol	44	03/09->	CGPB								
Engine	Information				A10	A20	A40	A50	A70	C10 - C30	C20	E01
All engines	x 3, COIL ON PLUG, incl. spark plug connector									1.970.474	C10	

ENGINE												
1.2	Petrol	51	06/09->	CGPA								
Engine	Information				A10	A20	A40	A50	A70	C10 - C30	C20	E01
All engines	x 3, COIL ON PLUG, incl. spark plug connector									1.970.474	C10	

ENGINE												
1.2 [IND]	Petrol	55	08/11->	CJLA								
Engine	Information				A10	A20	A40	A50	A70	C10 - C30	C20	E01
All engines	Qty: 3									1.970.474	C10	

ENGINE												
1.2 BlueMotion	Petrol	51	03/09-05/14	CGPA								
Engine	Information				A10	A20	A40	A50	A70	C10 - C30	C20	E01
All engines	x 3, COIL ON PLUG, incl. spark plug connector									1.970.474	C10	

ENGINE												
1.2 TSI	Petrol	66	05/11->	CBZC, CJZC								
Engine	Information				A10	A20	A40	A50	A70	C10 - C30	C20	E01
Eng. CJZC	x 4, BERU, ELDOR, COIL ON PLUG, incl. spark plug connector, Number of pins:4, incl. spark plug connector									1.970.599	C10	
Eng. CBZC										1.990.420	C30	1.499.248

A10 CONDENSER	A20 CONTACT SET	A40 DISTRIBUTOR CAP	A50 ROTOR	A70 PICK-UP
C10 COIL	C20 IGNITION MODULE	C30 ELECTRONIC IGNITION KIT	E01 IGNITION CABLE SET	

Vehicle	alim.	kW	Date	Engine	FUNCTIONS ON THE VEHICLE								
					A10	A20	A40	A50	A70	C10 - C30	C20	E01	
ENGINE													
1.2 TSI	Petrol	77	11/09->	CBZB									
Engine	Information												
All engines									1.990.420	C30		1.499.248	
ENGINE													
1.2 TSI	Petrol	81	01/14->	CJZD									
Engine	Information												
All engines	x 4, BERU, ELDOR, COIL ON PLUG, incl. spark plug connector, Number of pins:4, incl. spark plug connector								1.970.599	C10			
ENGINE													
1.2 TSI 16V	Petrol	66	02/14-10/17	CJZC									
Engine	Information												
All engines	x 4, BERU, ELDOR, COIL ON PLUG, incl. spark plug connector, Number of pins:4, incl. spark plug connector								1.970.599	C10			
ENGINE													
1.2 TSi BlueMotion	Petrol	77	11/09-05/14	CBZB									
Engine	Information												
All engines									1.990.420	C30			
ENGINE													
1.4	Petrol	63	03/09-05/14	CDDA, CGGB, CLPA									
Engine	Information												
Eng. CDDA	Qty: 4								1.970.474	C10			
Eng. CGGB, CLPA	x 4, COIL ON PLUG, incl. spark plug connector								1.970.474	C10			
ENGINE													
1.4 BiFuel	Petrol/ Liquified Petro- leum Gas (LPG)	60	03/10-01/11	CMAA									
Engine	Information												
All engines	x 4, COIL ON PLUG, incl. spark plug connector								1.970.474	C10			
ENGINE													
1.4 GTi	Petrol	132	05/10->	CAVE, CTHE									
Engine	Information												
All engines	x 4, COIL ON PLUG, incl. spark plug connector								1.970.474	C10			
ENGINE													
1.4 TSI	Petrol	103	10/12-05/14	CPTA									
Engine	Information												
All engines	x 4, BERU, ELDOR, COIL ON PLUG, incl. spark plug connector, Number of pins:4, incl. spark plug connector								1.970.599	C10			
ENGINE													
1.4 TSI	Petrol	110	05/14->	CZEA									
Engine	Information												
All engines	x 4, BERU, ELDOR, COIL ON PLUG, incl. spark plug connector, Number of pins:4, incl. spark plug connector								1.970.599	C10			
ENGINE													
1.4 TSi	Petrol	92	05/16->	CZCA									
Engine	Information												
All engines	x 4, BERU, ELDOR, COIL ON PLUG, incl. spark plug connector, Number of pins:4, incl. spark plug connector								1.970.599	C10			
ENGINE													
1.4 TSi [RUS]	Petrol	92	05/14->	CZCA									
Engine	Information												
All engines	Qty: 4								1.970.599	C10			
ENGINE													
1.6	Petrol	63	05/10->	CFNB									
Engine	Information												
All engines	Qty: 4								1.970.474	C10			
All engines	x 4, COIL ON PLUG, incl. spark plug connector								1.970.474	C10			
ENGINE													
1.6	Petrol	66	07/14->	CWVB									
Engine	Information												
All engines	x 4, BERU, ELDOR, COIL ON PLUG, incl. spark plug connector, Number of pins:4, incl. spark plug connector								1.970.599	C10			

A10	CONDENSER	A20	CONTACT SET	A40	DISTRIBUTOR CAP	A50	ROTOR	A70	PICK-UP
C10	COIL	C20	IGNITION MODULE	C30	ELECTRONIC IGNITION KIT	E01	IGNITION CABLE SET		

The present application list is a brief version. For the detailed information about the possibility of installation on a specific vehicle, please refer to our web-catalogue <http://catalogo.facet.eu/>

Vehicle	alim.	kW	Date	Engine	FUNCTIONS ON THE VEHICLE							
					A10	A20	A40	A50	A70	C10 - C30	C20	E01

ENGINE				
1.6	Petrol	77	01/10->	CFNA, CLSA

Engine	Information	A10	A20	A40	A50	A70	C10 - C30	C20	E01
All engines	x 4, COIL ON PLUG, x 4, COIL ON PLUG, incl. spark plug connector, incl. spark plug connector						1.970.474	C10	
Eng. CLSA	Qty: 4						1.970.474	C10	

ENGINE				
1.6	Petrol	81	07/14->	CWVA

Engine	Information	A10	A20	A40	A50	A70	C10 - C30	C20	E01
All engines	x 4, BERU, ELDOR, COIL ON PLUG, incl. spark plug connector, Number of pins:4, incl. spark plug connector						1.970.599	C10	

ENGINE				
1.6 BiFuel	Petrol/ Liquified Petro- leum Gas (LPG)	60	01/11-05/14	CNKA

Engine	Information	A10	A20	A40	A50	A70	C10 - C30	C20	E01
All engines	x 4, COIL ON PLUG, incl. spark plug connector						1.970.474	C10	

ENGINE				
1.8 GTI	Petrol	141	11/14->	DAJA, DAJB

Engine	Information	A10	A20	A40	A50	A70	C10 - C30	C20	E01
All engines	x 4, HITACHI, COIL ON PLUG, incl. spark plug connector						1.970.636	C10	

ENGINE				
2.0 RWRC	Petrol	162	08/13-05/14	CDLJ

Engine	Information	A10	A20	A40	A50	A70	C10 - C30	C20	E01
All engines	x 4, ELDOR, Housing Colour:Black, COIL ON PLUG, incl. spark plug connector						1.970.426	C10	

POLO VI

ENGINE				
1.0	Petrol	48	08/17-02/20	CHYC, DFNB

Engine	Information	A10	A20	A40	A50	A70	C10 - C30	C20	E01
All engines	x 3, BERU, ELDOR, HITACHI, COIL ON PLUG, incl. spark plug connector, Number of pins:4, incl. spark plug connector						1.970.599	C10	

ENGINE				
1.0	Petrol	55	06/17-08/21	CHYB

Engine	Information	A10	A20	A40	A50	A70	C10 - C30	C20	E01
All engines	x 3, x 4, BERU, ELDOR, HITACHI, COIL ON PLUG, incl. spark plug connector, Number of pins:4, incl. spark plug connector						1.970.599	C10	

ENGINE				
1.0 TGI	Petrol/ Com- pressed Natural Gas (CNG)	66	09/17->	DBYA

Engine	Information	A10	A20	A40	A50	A70	C10 - C30	C20	E01
All engines	x 3, BERU, ELDOR, COIL ON PLUG, incl. spark plug connector, Number of pins:4, incl. spark plug connector						1.970.599	C10	

ENGINE				
1.0 TSI	Petrol	70	06/17->	CHZL, DKLA, DLAC

Engine	Information	A10	A20	A40	A50	A70	C10 - C30	C20	E01
All engines	x 3, BERU, ELDOR, HITACHI, COIL ON PLUG, incl. spark plug connector, Number of pins:4, incl. spark plug connector						1.970.599	C10	

ENGINE				
1.0 TSI	Petrol	81	07/20->	DLAA

Engine	Information	A10	A20	A40	A50	A70	C10 - C30	C20	E01
All engines	x 3, BERU, ELDOR, HITACHI, COIL ON PLUG, incl. spark plug connector, Number of pins:4, incl. spark plug connector						1.970.599	C10	

ENGINE				
1.0 TSI	Petrol	85	09/17->	CHZJ, DKJA, DKRF

Engine	Information	A10	A20	A40	A50	A70	C10 - C30	C20	E01
All engines	x 3, BERU, ELDOR, COIL ON PLUG, incl. spark plug connector, Number of pins:4, incl. spark plug connector						1.970.599	C10	

ENGINE				
2.0 GTI	Petrol	147	11/17->	CZPC, DKZC

Engine	Information	A10	A20	A40	A50	A70	C10 - C30	C20	E01
All engines	x 4, HITACHI, COIL ON PLUG, incl. spark plug connector						1.970.636	C10	

A10	CONDENSER	A20	CONTACT SET	A40	DISTRIBUTOR CAP	A50	ROTOR	A70	PICK-UP
C10	COIL	C20	IGNITION MODULE	C30	ELECTRONIC IGNITION KIT	E01	IGNITION CABLE SET		

Vehicle	alim.	kW	Date	Engine	FUNCTIONS ON THE VEHICLE							
					A10	A20	A40	A50	A70	C10 - C30	C20	E01

SANTANA

1.6	Petrol	55	08/81-12/84	ENGINE DT
-----	--------	----	-------------	--------------

Engine	Information	A10	A20	A40	A50	A70	C10 - C30	C20	E01
All engines	version Bosch			1.306.094	1.406.055R	1.906.231			
All engines							1.970.125	C10	1.965.004

1.8	Petrol	66	01/83-12/84	ENGINE DS
-----	--------	----	-------------	--------------

Engine	Information	A10	A20	A40	A50	A70	C10 - C30	C20	E01
All engines	version Bosch			1.306.094	1.406.055R	1.906.231			
All engines							1.970.125	C10	1.965.004

1.9	Petrol	85	08/81-07/83	ENGINE WN
-----	--------	----	-------------	--------------

Engine	Information	A10	A20	A40	A50	A70	C10 - C30	C20	E01
All engines	version Bosch			1.306.093	1.406.116R				
All engines							1.970.132	C10	1.965.004

2.0	Petrol	85	08/83-12/84	ENGINE JS
-----	--------	----	-------------	--------------

Engine	Information	A10	A20	A40	A50	A70	C10 - C30	C20	E01
All engines	version Bosch			1.306.231	1.406.116R				
All engines	version Bosch, 01/01/88 ->					1.906.219			
All engines							1.970.125	C10	1.965.004

SCIROCCO I

1.1	Petrol	37	04/74-07/79	ENGINE FA
-----	--------	----	-------------	--------------

Engine	Information	A10	A20	A40	A50	A70	C10 - C30	C20	E01
All engines	version Bosch	1.106.195	1.206.034HVS	1.306.079	1.406.121R				
All engines	version Ducellier				1.415.089R				
All engines									1.500.727

1.3	Petrol	44	08/79-07/80	ENGINE GF
-----	--------	----	-------------	--------------

Engine	Information	A10	A20	A40	A50	A70	C10 - C30	C20	E01
All engines	version Bosch	1.106.195	1.206.049HVS	1.306.079	1.406.114R				
All engines									1.500.727

1.5	Petrol	51	08/77-07/80	ENGINE JB
-----	--------	----	-------------	--------------

Engine	Information	A10	A20	A40	A50	A70	C10 - C30	C20	E01
All engines	version Bosch	1.106.196	1.206.034HVS	1.306.079	1.406.055R				
All engines									1.500.727

SCIROCCO II

1.3	Petrol	40	08/83-07/84	ENGINE HK
-----	--------	----	-------------	--------------

Engine	Information	A10	A20	A40	A50	A70	C10 - C30	C20	E01
All engines	version Bosch	1.106.195	1.206.049HVS		1.406.114R				
All engines	version Bosch, ->ch. 53-E-046 000			1.306.079					
All engines	version Bosch, ch. 53-E-046 001 ->			1.306.094					
All engines	ch. 53-E-046 001 ->								1.500.493
All engines	->ch. 53-E-046 000								1.500.727

1.3	Petrol	44	08/80-12/83	ENGINE GF
-----	--------	----	-------------	--------------

Engine	Information	A10	A20	A40	A50	A70	C10 - C30	C20	E01
All engines	version Bosch			1.306.079	1.406.056R				
All engines							1.970.132	C10	1.965.004

1.6	Petrol	51	08/83-07/84	ENGINE EWA
-----	--------	----	-------------	---------------

Engine	Information	A10	A20	A40	A50	A70	C10 - C30	C20	E01
All engines	version Bosch			1.306.266	1.406.055R	1.906.219			
All engines	version Ducellier			1.315.068	1.415.099R				
All engines	ch. 53-E-046 001 ->						1.970.125	C10	1.500.725
All engines	->ch. 53-E-046 000						1.970.132	C10	1.500.727

A10	CONDENSER	A20	CONTACT SET	A40	DISTRIBUTOR CAP	A50	ROTOR	A70	PICK-UP
C10	COIL	C20	IGNITION MODULE	C30	ELECTRONIC IGNITION KIT	E01	IGNITION CABLE SET		

The present application list is a brief version. For the detailed information about the possibility of installation on a specific vehicle, please refer to our web-catalogue <http://catalogo.facet.eu/>

Vehicle	alim.	kW	Date	Engine	FUNCTIONS ON THE VEHICLE							
					A10	A20	A40	A50	A70	C10 - C30	C20	E01

ENGINE				
1.6	Petrol	53	08/83-07/90	HN, RE

Engine	Information	A10	A20	A40	A50	A70	C10 - C30	C20	E01
Eng. HN	version Bosch, ->eng. HN 005 000			1.306.079					
Eng. HN	version Bosch, eng. type HN 005 001 ->, ->eng. HN 007 000			1.306.094					
All engines	version Bosch, eng. type HN 007 001 ->			1.306.266					
Eng. RE	version Ducellier			1.315.068	1.415.099R				
All engines	version Bosch				1.406.055R	1.906.219			
All engines	ch. 53-E-046 001 ->, ->ch. 53-J-020 000, ch. 53-L-000 001 ->						1.970.125	C10	
Eng. RE	ch. 53-K-000 001 ->, ->ch. 53-K-020 000						1.970.126	C10	
Eng. HN	->ch. 53-E-046 000						1.970.132	C10	1.500.727
Eng. HN								1.965.007	
All engines	ch. 53-E-046 001 ->								1.500.725

ENGINE				
1.6	Petrol	55	01/83-12/89	EW

Engine	Information	A10	A20	A40	A50	A70	C10 - C30	C20	E01
All engines	version Bosch, ->eng. EW 012 000			1.306.079					
All engines	version Bosch, eng. type EW 012 001 ->, ->eng. EW 035 000			1.306.094					
All engines	version Bosch, eng. type EW 035 001 ->			1.306.266					
All engines	version Ducellier			1.315.068	1.415.099R				
All engines	version Bosch				1.406.055R	1.906.219			
All engines	ch. 53-E-046 001 ->, ->ch. 53-J-020 000, ch. 53-L-000 001 ->						1.970.125	C10	
All engines	ch. 53-K-000 001 ->, ->ch. 53-K-020 000						1.970.126	C10	
All engines	->ch. 53-E-046 000						1.970.132	C10	1.500.727
All engines								1.965.007	
All engines	ch. 53-E-046 001 ->								1.500.725

ENGINE				
1.6	Petrol	63	08/80-04/84	1HyFAD

Engine	Information	A10	A20	A40	A50	A70	C10 - C30	C20	E01
All engines	version Bosch	1.106.196	1.206.034HVS	1.306.079	1.406.027R				

ENGINE				
1.8	Petrol	66	08/83-07/92	EX

Engine	Information	A10	A20	A40	A50	A70	C10 - C30	C20	E01
All engines	version Bosch, ->eng. EX 015 000			1.306.079					
All engines	version Bosch, eng. type EX 015 001 ->, ->eng. EX 035 000			1.306.094					
All engines	version Bosch, eng. type EX 035 000 ->			1.306.266					
All engines	version Ducellier			1.315.068	1.415.099R				
All engines	version Bosch				1.406.055R	1.906.219			
All engines	ch. 53-E-046 001 ->, ->ch. 53-J-020 000, ch. 53-L-000 001 ->						1.970.125	C10	
All engines	ch. 53-K-000 001 ->, ->ch. 53-K-020 000						1.970.126	C10	
All engines	->ch. 53-E-046 000						1.970.132	C10	1.500.727
All engines								1.965.007	
All engines	ch. 53-E-046 001 ->								1.500.725

ENGINE				
1.8	Petrol	70	11/85-07/92	JH

Engine	Information	A10	A20	A40	A50	A70	C10 - C30	C20	E01
All engines	version Bosch, ->eng. JH 240 000			1.306.079					
All engines	version Bosch, eng. type JH 240 001 ->, ->eng. JH 280 000			1.306.094					
All engines	version Bosch, eng. type JH 280 001 ->			1.306.266					
All engines	version Bosch				1.406.055R	1.906.219			
All engines	ch. 53-E-046 001 ->, ->ch. 53-J-020 000, ch. 53-L-000 001 ->						1.970.125	C10	
All engines	ch. 53-K-000 001 ->, ->ch. 53-K-020 000						1.970.126	C10	
All engines	->ch. 53-E-046 000						1.970.132	C10	1.500.727
All engines								1.965.007	
All engines	ch. 53-E-046 001 ->								1.500.725

ENGINE				
1.8	Petrol	82	08/82-12/89	DX, KT

Engine	Information	A10	A20	A40	A50	A70	C10 - C30	C20	E01
Eng. DX	version Bosch, ->eng. DX 110 000			1.306.079					
All engines	version Bosch, eng. type DX 110 001 ->, ->eng. DX 119 000, ->eng. KT 004 600			1.306.094	1.406.116R				

A10	CONDENSER	A20	CONTACT SET	A40	DISTRIBUTOR CAP	A50	ROTOR	A70	PICK-UP
C10	COIL	C20	IGNITION MODULE	C30	ELECTRONIC IGNITION KIT	E01	IGNITION CABLE SET		

Vehicle	alim.	kW	Date	Engine	FUNCTIONS ON THE VEHICLE							
					A10	A20	A40	A50	A70	C10 - C30	C20	E01

ENGINE				
1.8	Petrol	82	08/82-12/89	DX, KT

Engine	Information	A10	A20	A40	A50	A70	C10 - C30	C20	E01
All engines	version Bosch, eng. type DX 119 001 ->, eng. type KT 004 601 ->			1.306.266					
All engines	version Bosch, ->eng. DX 110 000, eng. type DX 119 001 ->, eng. type KT 004 601 ->				1.406.055R				
All engines	version Bosch					1.906.219			
All engines	ch. 53-E-046 001 ->, ->ch. 53-J-020 000, ch. 53-L-000 001 ->						1.970.125	C10	
All engines	ch. 53-K-000 001 ->, ->ch. 53-K-020 000						1.970.126	C10	
All engines	->ch. 53-E-046 000						1.970.132	C10	1.500.727
All engines								1.965.007	
All engines	ch. 53-E-046 001 ->								1.500.725

ENGINE				
1.8 16V	Petrol	102	10/85-07/89	KR

Engine	Information	A10	A20	A40	A50	A70	C10 - C30	C20	E01
All engines	version Bosch			1.306.266	1.406.121R	1.906.223			
All engines	ch. 53-E-046 001 ->, ->ch. 53-J-020 000, ch. 53-L-000 001 ->						1.970.125	C10	
All engines	ch. 53-K-000 001 ->, ->ch. 53-K-020 000						1.970.126	C10	
All engines	->ch. 53-E-046 000						1.970.132	C10	
All engines								1.965.007	1.500.737

ENGINE				
1.8 16V	Petrol	95	03/86-07/92	PL

Engine	Information	A10	A20	A40	A50	A70	C10 - C30	C20	E01
All engines	version Bosch			1.306.266	1.406.121R	1.906.223			
All engines	ch. 53-L-000 001 ->						1.970.125	C10	
All engines	->ch. 53-K-020 000						1.970.126	C10	
All engines								1.965.007	1.500.737

SCIROCCO III

ENGINE				
1.4 TSI	Petrol	110	07/15-11/17	CZDA

Engine	Information	A10	A20	A40	A50	A70	C10 - C30	C20	E01
All engines	x 4, BERU, ELDOR, COIL ON PLUG, incl. spark plug connector, Number of pins:4, incl. spark plug connector						1.970.599	C10	

ENGINE				
1.4 TSI	Petrol	118	05/08-11/17	CAVD, CNWA, CTHD, CTKA

Engine	Information	A10	A20	A40	A50	A70	C10 - C30	C20	E01
All engines	x 4, COIL ON PLUG, incl. spark plug connector						1.970.474	C10	

ENGINE				
1.4 TSI	Petrol	90	08/08-11/17	CAXA, CMSB

Engine	Information	A10	A20	A40	A50	A70	C10 - C30	C20	E01
All engines	x 4, COIL ON PLUG, incl. spark plug connector						1.970.474	C10	

ENGINE				
1.4 TSI	Petrol	92	11/13-11/17	CZCA

Engine	Information	A10	A20	A40	A50	A70	C10 - C30	C20	E01
All engines	x 4, BERU, ELDOR, COIL ON PLUG, incl. spark plug connector, Number of pins:4, incl. spark plug connector						1.970.599	C10	

ENGINE				
1.4 TSI	Petrol	96	07/15->	CZDC

Engine	Information	A10	A20	A40	A50	A70	C10 - C30	C20	E01
All engines	Qty: 4						1.970.599	C10	









ENGINE				
2.0 R	Petrol	188	11/09-11/17	CDLC

Engine	Information	A10	A20	A40	A50	A70	C10 - C30	C20	E01
All engines	x 4, ELDOR, Housing Colour:Black, COIL ON PLUG, incl. spark plug connector						1.970.426	C10	

ENGINE				
2.0 R	Petrol	195	11/09-11/17	CDLA

Engine	Information	A10	A20	A40	A50	A70	C10 - C30	C20	E01
All engines	x 4, ELDOR, Housing Colour:Black, COIL ON PLUG, incl. spark plug connector						1.970.426	C10	







A10	CONDENSER	A20	CONTACT SET	A40	DISTRIBUTOR CAP	A50	ROTOR	A70	PICK-UP
C10	COIL	C20	IGNITION MODULE	C30	ELECTRONIC IGNITION KIT	E01	IGNITION CABLE SET		

					FUNCTIONS ON THE VEHICLE							
Vehicle	alim.	kW	Date	Engine	 A10	 A20	 A40	 A50	 A70	 C10 - C30	 C20	 E01
ENGINE												
2.0 R	Petrol	206	05/14-11/17	CDLK								
Engine	Information				A10	A20	A40	A50	A70	C10 - C30	C20	E01
All engines	x 4, ELDOR, Housing Colour:Black, COIL ON PLUG, incl. spark plug connector									1.970.426	C10	
ENGINE												
2.0 TFSI	Petrol	147	05/08-11/09	CAWB								
Engine	Information				A10	A20	A40	A50	A70	C10 - C30	C20	E01
All engines	x 4, ELDOR, Housing Colour:Black, COIL ON PLUG, incl. spark plug connector									1.970.426	C10	
ENGINE												
2.0 TFSi	Petrol	155	11/09-05/14	CCZB								
Engine	Information				A10	A20	A40	A50	A70	C10 - C30	C20	E01
All engines	x 4, ELDOR, Housing Colour:Black, COIL ON PLUG, incl. spark plug connector									1.970.426	C10	
ENGINE												
2.0 TSI	Petrol	155	11/09-11/17	CCZB								
Engine	Information				A10	A20	A40	A50	A70	C10 - C30	C20	E01
All engines	x 4, ELDOR, Housing Colour:Black, COIL ON PLUG, incl. spark plug connector									1.970.426	C10	
SHARAN I												
ENGINE												
1.8 T 20V	Petrol	110	09/97-03/10	AJH, AWC								
Engine	Information				A10	A20	A40	A50	A70	C10 - C30	C20	E01
Eng. AJH	x 4, COIL ON PLUG									1.970.3545	C10	
Eng. AWC	x 4, COIL ON PLUG, incl. spark plug connector									1.970.445	C10	
Eng. AJH											1.965.076	
ENGINE												
2.0	Petrol	85	09/95-03/10	ADY, ATM								
Engine	Information				A10	A20	A40	A50	A70	C10 - C30	C20	E01
Eng. ADY	version Bosch						1.306.266	1.406.121R				
Eng. ADY										1.990.414	C30	1.501.667
Eng. ATM										1.990.420	C30	1.501.585
ENGINE												
2.0 LPG	Petrol/ Liquified Petro- leum Gas (LPG)	85	04/06-03/10	ATM								
Engine	Information				A10	A20	A40	A50	A70	C10 - C30	C20	E01
All engines										1.990.420	C30	1.501.585
ENGINE												
2.8 V6 24V	Petrol	150	04/00-03/10	AYL								
Engine	Information				A10	A20	A40	A50	A70	C10 - C30	C20	E01
All engines	x 6, COIL ON PLUG									1.970.435	C10	
ENGINE												
2.8 V6 24V 4motion	Petrol	150	04/00-03/10	AYL								
Engine	Information				A10	A20	A40	A50	A70	C10 - C30	C20	E01
All engines	x 6, COIL ON PLUG									1.970.435	C10	
ENGINE												
2.8 VR6	Petrol	150	08/01-05/03	AYL								
Engine	Information				A10	A20	A40	A50	A70	C10 - C30	C20	E01
All engines	x 6, COIL ON PLUG									1.970.435	C10	
SHARAN II												
ENGINE												
1.4 TSI	Petrol	110	05/10->	CAVA, CTHA, CZDA, DJKA								
Engine	Information				A10	A20	A40	A50	A70	C10 - C30	C20	E01
Eng. CAVA, CTHA	x 4, COIL ON PLUG, x 4, COIL ON PLUG, incl. spark plug connector, incl. spark plug connector									1.970.474	C10	
Eng. CZDA, DJKA	x 4, BERU, ELDOR, HITACHI, COIL ON PLUG, incl. spark plug connector, Number of pins:4, incl. spark plug connector									1.970.599	C10	
ENGINE												
1.8 TSI	Petrol	118	11/11->	CDA A								
Engine	Information				A10	A20	A40	A50	A70	C10 - C30	C20	E01
All engines	Qty: 4									1.970.426	C10	
Legend												
A10	CONDENSER	A20	CONTACT SET	A40	DISTRIBUTOR CAP	A50	ROTOR	A70	PICK-UP			
C10	COIL	C20	IGNITION MODULE	C30	ELECTRONIC IGNITION KIT	E01	IGNITION CABLE SET					

Vehicle	alim.	kW	Date	Engine	FUNCTIONS ON THE VEHICLE							
					A10	A20	A40	A50	A70	C10 - C30	C20	E01
ENGINE												
2.0 TFSI	Petrol	147	12/10-11/15	CCZA								
Engine	Information				A10	A20	A40	A50	A70	C10 - C30	C20	E01
All engines	x 4, ELDOR, Housing Colour:Black, COIL ON PLUG, incl. spark plug connector									1.970.426	C10	
ENGINE												
2.0 TSI	Petrol	147	12/10-11/15	CCZA								
Engine	Information				A10	A20	A40	A50	A70	C10 - C30	C20	E01
All engines	x 4, ELDOR, Housing Colour:Black, COIL ON PLUG, incl. spark plug connector									1.970.426	C10	
SPACEFOX / SPACE CROSS												
ENGINE												
1.6	Petrol	74	03/06->	BAH, BLH								
Engine	Information				A10	A20	A40	A50	A70	C10 - C30	C20	E01
All engines										1.990.420	C30	1.501.723
ENGINE												
1.6 FSI	Petrol	74	03/06->	BPA, CCRA, CFZA								
Engine	Information				A10	A20	A40	A50	A70	C10 - C30	C20	E01
All engines										1.990.420	C30	1.501.723
ENGINE												
1.6 Total Flex	Flexfuel	74	03/06->	BPA, CCRA, CFZA								
Engine	Information				A10	A20	A40	A50	A70	C10 - C30	C20	E01
All engines										1.990.420	C30	1.501.723
TAIGO												
ENGINE												
1.0 TSI	Petrol	70	09/21->	DLAC								
Engine	Information				A10	A20	A40	A50	A70	C10 - C30	C20	E01
All engines	x 4, ELDOR, HITACHI, COIL ON PLUG, incl. spark plug connector									1.970.599	C10	
ENGINE												
1.0 TSI	Petrol	81	09/21->	DLAA								
Engine	Information				A10	A20	A40	A50	A70	C10 - C30	C20	E01
All engines	x 4, ELDOR, HITACHI, COIL ON PLUG, incl. spark plug connector									1.970.599	C10	
TAOS												
ENGINE												
1.4 TSI	Petrol	110	10/20->	DJKA								
Engine	Information				A10	A20	A40	A50	A70	C10 - C30	C20	E01
All engines	x 4, ELDOR, HITACHI, COIL ON PLUG, incl. spark plug connector									1.970.599	C10	
ENGINE												
1.4 TSI 4motion	Petrol	110	05/21->	DJKA								
Engine	Information				A10	A20	A40	A50	A70	C10 - C30	C20	E01
All engines	x 4, ELDOR, HITACHI, COIL ON PLUG, incl. spark plug connector									1.970.599	C10	
ENGINE												
1.6 MPI	Petrol	81	07/21->	DWYA								
Engine	Information				A10	A20	A40	A50	A70	C10 - C30	C20	E01
All engines	x 4, ELDOR, HITACHI, COIL ON PLUG, incl. spark plug connector									1.970.599	C10	
TARO												
ENGINE												
1.8	Petrol	61	04/89-09/94	2Y								
Engine	Information				A10	A20	A40	A50	A70	C10 - C30	C20	E01
All engines	->ch. 7A-L9503 250, ->ch. 7A-LH003 500, version Denso					1.213.011HV	1.313.114	1.413.014				
All engines	ch. 7A-L9503 251 ->, ch. 7A-LH003 501 ->, version Denso						1.313.113	1.413.027				
ENGINE												
2.2	Petrol	69	06/89-07/94	4Y								
Engine	Information				A10	A20	A40	A50	A70	C10 - C30	C20	E01
All engines	->ch. 7A-L9503 250, ->ch. 7A-LH003 500, version Denso					1.213.011HV	1.313.114	1.413.014				
All engines	ch. 7A-L9503 251 ->, ch. 7A-LH003 501 ->, version Denso						1.313.113	1.413.027				

A10 CONDENSER	A20 CONTACT SET	A40 DISTRIBUTOR CAP	A50 ROTOR	A70 PICK-UP
C10 COIL	C20 IGNITION MODULE	C30 ELECTRONIC IGNITION KIT	E01 IGNITION CABLE SET	

The present application list is a brief version. For the detailed information about the possibility of installation on a specific vehicle, please refer to our web-catalogue <http://catalogo.facet.eu/>









					FUNCTIONS ON THE VEHICLE							
Vehicle	alim.	kW	Date	Engine								
ENGINE												
2.2 4x4	Petrol	69	06/89-07/94	4Y								
Engine	Information				A10	A20	A40	A50	A70	C10 - C30	C20	E01
All engines	->ch. 7A-L9503 250, ->ch. 7A-LH003 500, version Denso					1.213.011HV	1.313.114	1.413.014				
All engines	ch. 7A-L9503 251 ->, ch. 7A-LH003 501 ->, version Denso						1.313.113	1.413.027				
ENGINE												
2.4 i 4x4	Petrol	84	06/89-03/97	22R								
Engine	Information				A10	A20	A40	A50	A70	C10 - C30	C20	E01
All engines	->ch. 7A-N9510 000, version Denso						1.313.099					
All engines	ch. 7A-P9500 001 ->, version Denso						1.313.273					
All engines	ch. 7A-P9500 001 ->								1.970.203	C10		
T-CROSS												
ENGINE												
1.0 TSi	Petrol	70	12/18->	CHZL, DKLA, DLAC								
Engine	Information				A10	A20	A40	A50	A70	C10 - C30	C20	E01
All engines	x 3, BERU, ELDOR, HITACHI, COIL ON PLUG, incl. spark plug connector, Number of pins:4, incl. spark plug connector									1.970.599	C10	
ENGINE												
1.0 TSI	Petrol	81	06/20->	DLAA								
Engine	Information				A10	A20	A40	A50	A70	C10 - C30	C20	E01
All engines	x 3, BERU, COIL ON PLUG, incl. spark plug connector									1.970.599	C10	
ENGINE												
1.0 TSI	Petrol	85	12/18->	DKJA, DKRF								
Engine	Information				A10	A20	A40	A50	A70	C10 - C30	C20	E01
All engines	x 3, BERU, ELDOR, HITACHI, COIL ON PLUG, incl. spark plug connector, Number of pins:4, incl. spark plug connector									1.970.599	C10	
TIGUAN I												
ENGINE												
1.4 [CHN]	Petrol	96	11/11->	CFBA.								
Engine	Information				A10	A20	A40	A50	A70	C10 - C30	C20	E01
All engines	Qty: 4									1.970.474	C10	
ENGINE												
1.4 TSI	Petrol	110	05/08-07/18	BWK, CAVA, CZDA								
Engine	Information				A10	A20	A40	A50	A70	C10 - C30	C20	E01
Eng. BWK	Qty: 4									1.970.474	C10	
Eng. CAVA	x 4, COIL ON PLUG, incl. spark plug connector									1.970.474	C10	
Eng. CZDA	x 4, BERU, ELDOR, COIL ON PLUG, incl. spark plug connector, Number of pins:4, incl. spark plug connector									1.970.599	C10	
ENGINE												
1.4 TSI	Petrol	118	05/11-07/18	CAVD, CTHD								
Engine	Information				A10	A20	A40	A50	A70	C10 - C30	C20	E01
All engines	x 4, COIL ON PLUG, incl. spark plug connector									1.970.474	C10	
ENGINE												
1.4 TSI	Petrol	90	08/10-07/18	CAXA								
Engine	Information				A10	A20	A40	A50	A70	C10 - C30	C20	E01
All engines	x 4, COIL ON PLUG, incl. spark plug connector									1.970.474	C10	
ENGINE												
1.4 TSI	Petrol	92	05/15-07/18	CZDB								
Engine	Information				A10	A20	A40	A50	A70	C10 - C30	C20	E01
All engines	x 4, BERU, ELDOR, COIL ON PLUG, incl. spark plug connector, Number of pins:4, incl. spark plug connector									1.970.599	C10	
ENGINE												
1.4 TSI 4motion	Petrol	110	09/07-07/18	BWK, CAVA								
Engine	Information				A10	A20	A40	A50	A70	C10 - C30	C20	E01
All engines	x 4, COIL ON PLUG, incl. spark plug connector									1.970.474	C10	
ENGINE												
1.4 TSI 4motion	Petrol	118	05/11-07/18	CAVD, CTHD								
Engine	Information				A10	A20	A40	A50	A70	C10 - C30	C20	E01
All engines	x 4, COIL ON PLUG, incl. spark plug connector									1.970.474	C10	

A10 CONDENSER	A20 CONTACT SET	A40 DISTRIBUTOR CAP	A50 ROTOR	A70 PICK-UP
C10 COIL	C20 IGNITION MODULE	C30 ELECTRONIC IGNITION KIT	E01 IGNITION CABLE SET	

Vehicle	alim.	kW	Date	Engine	FUNCTIONS ON THE VEHICLE								
					A10	A20	A40	A50	A70	C10 - C30	C20	E01	
ENGINE													
2.0 TFSI	Petrol	125	05/08->	CCTB									
Engine	Information				A10	A20	A40	A50	A70	C10 - C30	C20	E01	
All engines	Qty: 4									1.970.426	C10		
ENGINE													
2.0 TFSI	Petrol	147	11/07-07/18	CAWB, CCTA									
Engine	Information				A10	A20	A40	A50	A70	C10 - C30	C20	E01	
All engines	x 4, ELDOR, Housing Colour:Black, COIL ON PLUG, incl. spark plug connector									1.970.426	C10		
ENGINE													
2.0 TFSI 4motion	Petrol	125	09/07-07/18	CAWA, CCTB, CCZC									
Engine	Information				A10	A20	A40	A50	A70	C10 - C30	C20	E01	
All engines	x 4, ELDOR, Housing Colour:Black, COIL ON PLUG, incl. spark plug connector									1.970.426	C10		
ENGINE													
2.0 TFSI 4motion	Petrol	147	09/07-07/18	CAWB, CCTA, CCZA									
Engine	Information				A10	A20	A40	A50	A70	C10 - C30	C20	E01	
All engines	x 4, ELDOR, Housing Colour:Black, COIL ON PLUG, incl. spark plug connector									1.970.426	C10		
ENGINE													
2.0 TSI 4motion	Petrol	125	11/09-05/11	CCZC									
Engine	Information				A10	A20	A40	A50	A70	C10 - C30	C20	E01	
All engines	x 4, ELDOR, Housing Colour:Black, COIL ON PLUG, incl. spark plug connector									1.970.426	C10		
ENGINE													
2.0 TSI 4motion	Petrol	132	05/11-07/18	CCZD									
Engine	Information				A10	A20	A40	A50	A70	C10 - C30	C20	E01	
All engines	x 4, ELDOR, Housing Colour:Black, COIL ON PLUG, incl. spark plug connector									1.970.426	C10		
ENGINE													
2.0 TSI 4motion	Petrol	147	11/09-05/11	CCZA									
Engine	Information				A10	A20	A40	A50	A70	C10 - C30	C20	E01	
All engines	x 4, ELDOR, Housing Colour:Black, COIL ON PLUG, incl. spark plug connector									1.970.426	C10		
ENGINE													
2.0 TSI 4motion	Petrol	155	05/11-07/18	CCZB									
Engine	Information				A10	A20	A40	A50	A70	C10 - C30	C20	E01	
All engines	x 4, ELDOR, Housing Colour:Black, COIL ON PLUG, incl. spark plug connector									1.970.426	C10		
TIGUAN II													
ENGINE													
1.4 TSI	Petrol	110	05/16->	CZDA, CZEA, DJVA									
Engine	Information				A10	A20	A40	A50	A70	C10 - C30	C20	E01	
All engines	x 4, BERU, ELDOR, HITACHI, COIL ON PLUG, incl. spark plug connector, Number of pins:4, incl. spark plug connector									1.970.599	C10		
ENGINE													
1.4 TSI	Petrol	92	01/16->	CZCA, CZDB									
Engine	Information				A10	A20	A40	A50	A70	C10 - C30	C20	E01	
All engines	x 4, BERU, ELDOR, HITACHI, COIL ON PLUG, incl. spark plug connector, Number of pins:4, incl. spark plug connector									1.970.599	C10		
ENGINE													
1.4 TSI 4motion	Petrol	110	05/16-07/18	CZDA, CZEA									
Engine	Information				A10	A20	A40	A50	A70	C10 - C30	C20	E01	
All engines	x 4, BERU, ELDOR, HITACHI, COIL ON PLUG, incl. spark plug connector, Number of pins:4, incl. spark plug connector									1.970.599	C10		
ENGINE													
2.0 TSI	Petrol	137	04/17->	DGUA, DTEA									
Engine	Information				A10	A20	A40	A50	A70	C10 - C30	C20	E01	
All engines	x 4, HITACHI, x 4, BERU, COIL ON PLUG, HITACHI, COIL ON PLUG, incl. spark plug connector, incl. spark plug connector									1.970.636	C10		
ENGINE													
2.0 TSI 4motion	Petrol	132	01/16->	CZPA, DGVA									
Engine	Information				A10	A20	A40	A50	A70	C10 - C30	C20	E01	
All engines	x 4, HITACHI, x 4, BERU, COIL ON PLUG, HITACHI, COIL ON PLUG, incl. spark plug connector, incl. spark plug connector									1.970.636	C10		

A10 CONDENSER	A20 CONTACT SET	A40 DISTRIBUTOR CAP	A50 ROTOR	A70 PICK-UP
C10 COIL	C20 IGNITION MODULE	C30 ELECTRONIC IGNITION KIT	E01 IGNITION CABLE SET	

The present application list is a brief version. For the detailed information about the possibility of installation on a specific vehicle, please refer to our web-catalogue <http://catalogo.facet.eu/>

					FUNCTIONS ON THE VEHICLE							
Vehicle	alim.	kW	Date	Engine								
ENGINE												
2.0 TSI 4motion	Petrol	137	04/17->	DGUA, DTEA								
Engine	Information			A10	A20	A40	A50	A70	C10 - C30	C20	E01	
All engines	x 4, HITACHI, x 4, BERU, COIL ON PLUG, HITACHI, COIL ON PLUG, incl. spark plug connector, incl. spark plug connector								1.970.636	C10		
ENGINE												
2.0 TSI 4motion	Petrol	140	09/18->	DKZA, DNLA, DNNA								
Engine	Information			A10	A20	A40	A50	A70	C10 - C30	C20	E01	
All engines	x 4, HITACHI, COIL ON PLUG, incl. spark plug connector								1.970.636	C10		
ENGINE												
2.0 TSI 4motion	Petrol	162	07/17->	CXDA, DNJA								
Engine	Information			A10	A20	A40	A50	A70	C10 - C30	C20	E01	
All engines	x 4, BERU, HITACHI, COIL ON PLUG, incl. spark plug connector								1.970.636	C10		
ENGINE												
2.0 TSI 4motion	Petrol	180	09/20->	DNPA								
Engine	Information			A10	A20	A40	A50	A70	C10 - C30	C20	E01	
All engines	x 4, HITACHI, COIL ON PLUG, incl. spark plug connector								1.970.636	C10		
ENGINE												
2.0 TSI R 4motion	Petrol	235	11/20->	DNFG								
Engine	Information			A10	A20	A40	A50	A70	C10 - C30	C20	E01	
All engines	x 4, HITACHI, COIL ON PLUG, incl. spark plug connector								1.970.636	C10		
ENGINE												
3.2 V6	Petrol	162	10/02-11/06	AZZ, BAA, BKJ, BMV, BMX, BRJ								
Engine	Information			A10	A20	A40	A50	A70	C10 - C30	C20	E01	
Eng. AZZ, BKJ, BMV, BMX, BRJ	->year 01/06/06, x 6, COIL ON PLUG								1.970.434	C10		
Eng. BAA	Qty: 6								1.970.434	C10		
ENGINE												
3.2 V6	Petrol	177	11/04-11/06	BKJ, BMV, BMX, BRJ								
Engine	Information			A10	A20	A40	A50	A70	C10 - C30	C20	E01	
All engines	->year 01/05/05, ->ch. 7L5090000, x 6, COIL ON PLUG 01/06/05 ->, ch. 7L6000001 ->, x 6, COIL ON PLUG								1.970.434	C10		
ENGINE												
3.6 V6 FSI	Petrol	206	10/05-05/10	BHL								
Engine	Information			A10	A20	A40	A50	A70	C10 - C30	C20	E01	
All engines	Qty: 6								1.970.434	C10		
ENGINE												
4.2 V8	Petrol	228	12/02-11/06	AXQ								
Engine	Information			A10	A20	A40	A50	A70	C10 - C30	C20	E01	
All engines	->year 01/05/05, x 8, COIL ON PLUG								1.970.425	C10		
All engines	01/06/05 ->, x 8, Colour:Red, COIL ON PLUG, incl. spark plug connector								1.970.427	C10		
ENGINE												
4.2 V8 FSI	Petrol	257	06/06-05/10	BAR								
Engine	Information			A10	A20	A40	A50	A70	C10 - C30	C20	E01	
All engines	x 8, ELDOR, Housing Colour:Black, COIL ON PLUG, incl. spark plug connector								1.970.426	C10		
All engines	x 8, Colour:Red, COIL ON PLUG, incl. spark plug connector								1.970.427	C10		
ENGINE												
2.0 TFSi 4motion	Petrol	183	05/18->	CYRC								
Engine	Information			A10	A20	A40	A50	A70	C10 - C30	C20	E01	
All engines	x 4, HITACHI, COIL ON PLUG, incl. spark plug connector								1.970.636	C10		
ENGINE												
3.0 TFSi	Petrol	235	01/15->	CYJA								
Engine	Information			A10	A20	A40	A50	A70	C10 - C30	C20	E01	
All engines	Qty: 6								1.970.427	C10		
ENGINE												
3.0 V6 TSI	Petrol	213	08/10-03/18	CJTA								
Engine	Information			A10	A20	A40	A50	A70	C10 - C30	C20	E01	
All engines	x 6, Colour:Red, COIL ON PLUG, incl. spark plug connector								1.970.427	C10		

A10 CONDENSER	A20 CONTACT SET	A40 DISTRIBUTOR CAP	A50 ROTOR	A70 PICK-UP
C10 COIL	C20 IGNITION MODULE	C30 ELECTRONIC IGNITION KIT	E01 IGNITION CABLE SET	

Vehicle	alim.	kW	Date	Engine	FUNCTIONS ON THE VEHICLE									
					A10	A20	A40	A50	A70	C10 - C30	C20	E01		
ENGINE														
3.0 V6 TSI Hybrid	Petrol/ Electric	245	04/10-03/18	CGEA, CGFA										
Engine	Information				A10	A20	A40	A50	A70	C10 - C30	C20	E01		
All engines	x 6, Colour:Red, COIL ON PLUG, incl. spark plug connector									1.970.427	C10			
ENGINE														
4.2 V8 FSI	Petrol	265	01/11-03/18	CGNA										
Engine	Information				A10	A20	A40	A50	A70	C10 - C30	C20	E01		
All engines	x 8, Colour:Red, COIL ON PLUG, incl. spark plug connector									1.970.427	C10			
TOURAN I														
ENGINE														
1.2 TSI	Petrol	77	05/10-05/15	CBZB										
Engine	Information				A10	A20	A40	A50	A70	C10 - C30	C20	E01		
All engines										1.990.420	C30		1.499.248	
ENGINE														
1.4 TSI	Petrol	103	02/06-05/15	BMY, CAVC, CTHC										
Engine	Information				A10	A20	A40	A50	A70	C10 - C30	C20	E01		
All engines	x 4, COIL ON PLUG, incl. spark plug connector									1.970.474	C10			
ENGINE														
1.4 TSI	Petrol	125	11/06-05/15	BLG, CAVB, CTHB										
Engine	Information				A10	A20	A40	A50	A70	C10 - C30	C20	E01		
All engines	x 4, COIL ON PLUG, incl. spark plug connector									1.970.474	C10			
ENGINE														
1.4 TSI EcoFuel	CNG	110	05/09-05/10	CDGA										
Engine	Information				A10	A20	A40	A50	A70	C10 - C30	C20	E01		
All engines	x 4, COIL ON PLUG, incl. spark plug connector									1.970.474	C10			
All engines	x 4, COIL ON PLUG, incl. spark plug connector									1.970.474	C10			
ENGINE														
1.6	Petrol	75	07/03-05/10	BGU, BSE, BSF										
Engine	Information				A10	A20	A40	A50	A70	C10 - C30	C20	E01		
All engines										1.990.420	C30		1.501.585	
ENGINE														
1.6 BiFuel	Petrol/ Liquified Petroleum Gas (LPG)	75	11/06-05/10	BSF										
Engine	Information				A10	A20	A40	A50	A70	C10 - C30	C20	E01		
All engines										1.990.420	C30			
ENGINE														
1.6 FSI	Petrol	85	02/03-01/07	BAG, BLF, BLP										
Engine	Information				A10	A20	A40	A50	A70	C10 - C30	C20	E01		
All engines	x 4, COIL ON PLUG, incl. spark plug connector									1.970.474	C10			
Eng. BLP	Qty: 4									1.970.474	C10			
ENGINE														
2.0 EcoFuel	CNG	80	02/06-05/09	BSX										
Engine	Information				A10	A20	A40	A50	A70	C10 - C30	C20	E01		
All engines													1.499.223	
ENGINE														
2.0 FSI	Petrol	110	10/03-01/07	AXW, BLR, BLX, BLY, BVY, BVZ										
Engine	Information				A10	A20	A40	A50	A70	C10 - C30	C20	E01		
All engines	x 4, ELDOR, Housing Colour:Black, COIL ON PLUG, incl. spark plug connector									1.970.426	C10			
Eng. AXW, BLX, BVY	Qty: 4									1.970.426	C10			
ENGINE														
2.0 FSI	Petrol	85	10/04-05/10	BJZ										
Engine	Information				A10	A20	A40	A50	A70	C10 - C30	C20	E01		
All engines										1.990.420	C30		1.501.585	
ENGINE														
2.0 TDI [CHN]	Petrol	88	04/09->	CGZA										
Engine	Information				A10	A20	A40	A50	A70	C10 - C30	C20	E01		
All engines										1.990.420	C30		1.501.585	

A10 CONDENSER	A20 CONTACT SET	A40 DISTRIBUTOR CAP	A50 ROTOR	A70 PICK-UP
C10 COIL	C20 IGNITION MODULE	C30 ELECTRONIC IGNITION KIT	E01 IGNITION CABLE SET	

The present application list is a brief version. For the detailed information about the possibility of installation on a specific vehicle, please refer to our web-catalogue <http://catalogo.facet.eu/>

Vehicle	alim.	kW	Date	Engine	FUNCTIONS ON THE VEHICLE							
					A10	A20	A40	A50	A70	C10 - C30	C20	E01

				ENGINE
FSI	Petrol	85	02/03-11/06	BAG, BLF, BLP

Engine	Information	A10	A20	A40	A50	A70	C10 - C30	C20	E01
All engines	x 4, COIL ON PLUG, incl. spark plug connector						1.970.474	C10	

TOURAN II

				ENGINE
1.0 TSI	Petrol	85	12/18->	DKRB

Engine	Information	A10	A20	A40	A50	A70	C10 - C30	C20	E01
All engines	x 3, BERU, ELDOR, COIL ON PLUG, incl. spark plug connector, Number of pins:4, incl. spark plug connector						1.970.599	C10	

				ENGINE
1.2 TSI	Petrol	81	05/15->	CVVB

Engine	Information	A10	A20	A40	A50	A70	C10 - C30	C20	E01
All engines	x 4, BERU, ELDOR, HITACHI, COIL ON PLUG, incl. spark plug connector, Number of pins:4, incl. spark plug connector						1.970.599	C10	

				ENGINE
1.4 TSI	Petrol	110	05/15->	CZDA

Engine	Information	A10	A20	A40	A50	A70	C10 - C30	C20	E01
All engines	x 4, BERU, ELDOR, HITACHI, COIL ON PLUG, incl. spark plug connector, Number of pins:4, incl. spark plug connector						1.970.599	C10	

				ENGINE
1.8 TSI	Petrol	132	11/15->	CJSA

Engine	Information	A10	A20	A40	A50	A70	C10 - C30	C20	E01
All engines	->year 01/09/18, x 4, HITACHI, COIL ON PLUG, incl. spark plug connector						1.970.636	C10	

TRANSPORTER II

				ENGINE
2.0	Petrol	51	08/75-04/79	CJ, GD, GE

Engine	Information	A10	A20	A40	A50	A70	C10 - C30	C20	E01
All engines					1.406.067R				

TRANSPORTER III

				ENGINE
1.9	Petrol	44	08/82-07/92	DF

Engine	Information	A10	A20	A40	A50	A70	C10 - C30	C20	E01
All engines					1.406.067R			1.965.007	1.499.159
All engines	ch. 24-L-000 001 ->						1.970.125	C10	
All engines	->ch. 24-K-175 000						1.970.126	C10	

				ENGINE
1.9	Petrol	57	08/82-07/92	DG

Engine	Information	A10	A20	A40	A50	A70	C10 - C30	C20	E01
All engines					1.406.067R			1.965.007	1.499.159
All engines	ch. 24-L-000 001 ->						1.970.125	C10	
All engines	->ch. 24-K-175 000						1.970.126	C10	

				ENGINE
1.9 Syncro	Petrol	57	11/84-07/92	DG

Engine	Information	A10	A20	A40	A50	A70	C10 - C30	C20	E01
All engines					1.406.067R			1.965.007	1.499.159
All engines	ch. 24-L-000 001 ->						1.970.125	C10	
All engines	->ch. 24-K-175 000						1.970.126	C10	

				ENGINE
2.1	Petrol	64	10/86-07/92	SR

Engine	Information	A10	A20	A40	A50	A70	C10 - C30	C20	E01
All engines							1.970.125	C10	1.965.007

				ENGINE
2.1	Petrol	70	08/85-07/92	MV

Engine	Information	A10	A20	A40	A50	A70	C10 - C30	C20	E01
All engines							1.970.125	C10	1.965.007

				ENGINE
2.1	Petrol	82	08/84-07/92	DJ

Engine	Information	A10	A20	A40	A50	A70	C10 - C30	C20	E01
All engines	ch. 24-L-000 001 ->						1.970.125	C10	
All engines	->ch. 24-K-175 000						1.970.126	C10	
All engines								1.965.007	1.499.159

A10 CONDENSER	A20 CONTACT SET	A40 DISTRIBUTOR CAP	A50 ROTOR	A70 PICK-UP
C10 COIL	C20 IGNITION MODULE	C30 ELECTRONIC IGNITION KIT	E01 IGNITION CABLE SET	

Vehicle	alim.	kW	Date	Engine	FUNCTIONS ON THE VEHICLE									
					A10	A20	A40	A50	A70	C10 - C30	C20	E01		
ENGINE														
2.1 Cat	Petrol	70	06/89-07/92	MV										
ENGINE														
Engine	Information				A10	A20	A40	A50	A70	C10 - C30	C20	E01		
All engines										1.970.125	C10	1.965.007		
ENGINE														
2.1 i	Petrol	68	07/89-07/92	SS										
ENGINE														
Engine	Information				A10	A20	A40	A50	A70	C10 - C30	C20	E01		
All engines										1.970.125	C10	1.965.007		
ENGINE														
2.1 Syncro	Petrol	64	10/86-07/92	SR										
ENGINE														
Engine	Information				A10	A20	A40	A50	A70	C10 - C30	C20	E01		
All engines										1.970.125	C10	1.965.007		
ENGINE														
2.1 Syncro	Petrol	70	08/85-07/92	MV										
ENGINE														
Engine	Information				A10	A20	A40	A50	A70	C10 - C30	C20	E01		
All engines										1.970.125	C10	1.965.007		
ENGINE														
2.1 Syncro	Petrol	82	01/86-07/92	DJ										
ENGINE														
Engine	Information				A10	A20	A40	A50	A70	C10 - C30	C20	E01		
All engines	ch. 24-L-000 001 ->									1.970.125	C10			
All engines	->ch. 24-K-175 000									1.970.126	C10			
All engines											1.965.007	1.499.159		
TRANSPORTER IV														
ENGINE														
1.8	Petrol	49	12/90-07/92	5K7M 710										
ENGINE														
Engine	Information				A10	A20	A40	A50	A70	C10 - C30	C20	E01		
All engines	version Bosch						1.306.266	1.406.055R						
All engines										1.990.416	C30			
All engines	->ch. 70-N-180 000												1.501.671	
ENGINE														
2.0	Petrol	62	07/90-04/03	AAC										
ENGINE														
Engine	Information				A10	A20	A40	A50	A70	C10 - C30	C20	E01		
All engines	->ch. 70-M-040 000, version Bosch						1.306.094							
All engines	ch. 70-M-040 001 ->, version Bosch						1.306.266							
All engines	version Bosch							1.406.121R						
All engines										1.990.414	C30			
All engines	->ch. 70-N-180 000												1.501.671	
ENGINE														
2.5	Petrol	81	09/90-06/03	AAF, ACU, AEU										
ENGINE														
Engine	Information				A10	A20	A40	A50	A70	C10 - C30	C20	E01		
All engines	version Bosch						1.306.231	1.406.121R						
Eng. ACU, AEU	version Bosch								1.906.223					
All engines										1.990.414	C30			
ENGINE														
2.5	Petrol	85	08/96-04/03	AET, APL, AVT										
ENGINE														
Engine	Information				A10	A20	A40	A50	A70	C10 - C30	C20	E01		
All engines	version Bosch						1.306.231	1.406.121R	1.906.223					
All engines										1.990.414	C30			
ENGINE														
2.5 Syncro	Petrol	81	08/92-04/03	AAF, ACU, AEU										
ENGINE														
Engine	Information				A10	A20	A40	A50	A70	C10 - C30	C20	E01		
All engines	version Bosch						1.306.231	1.406.121R						
Eng. ACU, AEU	version Bosch								1.906.223					
All engines										1.990.414	C30			
ENGINE														
2.5 Syncro	Petrol	85	07/96-04/03	AET, APL, AVT										
ENGINE														
Engine	Information				A10	A20	A40	A50	A70	C10 - C30	C20	E01		
All engines	version Bosch						1.306.231	1.406.121R	1.906.223					
All engines										1.990.414	C30			

A10	CONDENSER	A20	CONTACT SET	A40	DISTRIBUTOR CAP	A50	ROTOR	A70	PICK-UP
C10	COIL	C20	IGNITION MODULE	C30	ELECTRONIC IGNITION KIT	E01	IGNITION CABLE SET		

The present application list is a brief version. For the detailed information about the possibility of installation on a specific vehicle, please refer to our web-catalogue <http://catalogo.facet.eu/>

Vehicle	alim.	kW	Date	Engine	FUNCTIONS ON THE VEHICLE							
					A10	A20	A40	A50	A70	C10 - C30	C20	E01

TRANSPORTER V

2.0	Petrol	85	11/03-08/15	ENGINE AXA
-----	--------	----	-------------	---------------

Engine	Information	A10	A20	A40	A50	A70	C10 - C30	C20	E01
All engines							1.990.420 C30		1.501.585

2.0 BiFuel	Petrol/ Com- pressed Natural Gas (CNG)	85	05/11-08/15	ENGINE AXA
------------	---	----	-------------	---------------

Engine	Information	A10	A20	A40	A50	A70	C10 - C30	C20	E01
All engines							1.990.420 C30		

2.0 CNG	Petrol/ Com- pressed Natural Gas (CNG)	85	11/03-08/15	ENGINE AXACNG
---------	---	----	-------------	------------------

Engine	Information	A10	A20	A40	A50	A70	C10 - C30	C20	E01
All engines							1.990.420 C30		

2.0 TSI	Petrol	110	07/12-08/15	ENGINE CJKB
---------	--------	-----	-------------	----------------

Engine	Information	A10	A20	A40	A50	A70	C10 - C30	C20	E01
All engines	x 4, ELDOR, Housing Colour:Black, COIL ON PLUG, incl. spark plug connector						1.970.426 C10		

2.0 TSI	Petrol	150	05/11-08/15	ENGINE CJKA
---------	--------	-----	-------------	----------------

Engine	Information	A10	A20	A40	A50	A70	C10 - C30	C20	E01
All engines	x 4, ELDOR, Housing Colour:Black, COIL ON PLUG, incl. spark plug connector						1.970.426 C10		

2.0 TSI 4motion	Petrol	150	07/11-08/15	ENGINE CJKA
-----------------	--------	-----	-------------	----------------

Engine	Information	A10	A20	A40	A50	A70	C10 - C30	C20	E01
All engines	x 4, ELDOR, Housing Colour:Black, COIL ON PLUG, incl. spark plug connector						1.970.426 C10		

3.2 4motion	Petrol	170	11/03-11/09	ENGINE BDL
-------------	--------	-----	-------------	---------------

Engine	Information	A10	A20	A40	A50	A70	C10 - C30	C20	E01
All engines	x 6, COIL ON PLUG						1.970.434 C10		

3.2 4motion	Petrol	173	11/03-11/09	ENGINE BKK, CFLA
-------------	--------	-----	-------------	---------------------

Engine	Information	A10	A20	A40	A50	A70	C10 - C30	C20	E01
All engines	x 6, COIL ON PLUG						1.970.434 C10		

3.2 V6	Petrol	170	04/03-11/09	ENGINE BDL
--------	--------	-----	-------------	---------------

Engine	Information	A10	A20	A40	A50	A70	C10 - C30	C20	E01
All engines	x 6, COIL ON PLUG						1.970.434 C10		

3.2 V6	Petrol	173	08/03-11/09	ENGINE BKK, CFLA
--------	--------	-----	-------------	---------------------

Engine	Information	A10	A20	A40	A50	A70	C10 - C30	C20	E01
All engines	x 6, COIL ON PLUG						1.970.434 C10		
Eng. BKK	Qty: 6						1.970.434 C10		

3.2 V6 4motion	Petrol	170	04/03-06/05	ENGINE BDL
----------------	--------	-----	-------------	---------------

Engine	Information	A10	A20	A40	A50	A70	C10 - C30	C20	E01
All engines	x 6, COIL ON PLUG						1.970.434 C10		

3.2 V6 4motion	Petrol	173	11/03-12/09	ENGINE BKK, CFLA
----------------	--------	-----	-------------	---------------------

Engine	Information	A10	A20	A40	A50	A70	C10 - C30	C20	E01
All engines	x 6, COIL ON PLUG						1.970.434 C10		

A10 CONDENSER	A20 CONTACT SET	A40 DISTRIBUTOR CAP	A50 ROTOR	A70 PICK-UP
C10 COIL	C20 IGNITION MODULE	C30 ELECTRONIC IGNITION KIT	E01 IGNITION CABLE SET	

Vehicle	alim.	kW	Date	Engine	FUNCTIONS ON THE VEHICLE							
					A10	A20	A40	A50	A70	C10 - C30	C20	E01

TRANSPORTER VI

				ENGINE
2.0 TSI	Petrol	110	04/15-07/19	CJKB

Engine	Information	A10	A20	A40	A50	A70	C10 - C30	C20	E01
All engines	x 4, ELDOR, Housing Colour:Black, COIL ON PLUG, incl. spark plug connector						1.970.426	C10	

				ENGINE
2.0 TSI	Petrol	150	04/15-07/19	CJKA

Engine	Information	A10	A20	A40	A50	A70	C10 - C30	C20	E01
All engines	x 4, ELDOR, Housing Colour:Black, COIL ON PLUG, incl. spark plug connector						1.970.426	C10	

				ENGINE
2.0 TSI 4motion	Petrol	150	06/15-07/19	CJKA

Engine	Information	A10	A20	A40	A50	A70	C10 - C30	C20	E01
All engines	x 4, ELDOR, Housing Colour:Black, COIL ON PLUG, incl. spark plug connector						1.970.426	C10	

T-ROC

				ENGINE
1.0 TSI	Petrol	81	09/20->	DLA A

Engine	Information	A10	A20	A40	A50	A70	C10 - C30	C20	E01
All engines	x 3, ELDOR, HITACHI, COIL ON PLUG, incl. spark plug connector, Number of pins:4, incl. spark plug connector						1.970.599	C10	

				ENGINE
1.0 TSI	Petrol	85	07/17-11/20	CHZJ, DKRF

Engine	Information	A10	A20	A40	A50	A70	C10 - C30	C20	E01
All engines	x 3, BERU, ELDOR, HITACHI, x 3, BERU, COIL ON PLUG, ELDOR, HITACHI, COIL ON PLUG, incl. spark plug connector, Number of pins:4, incl. spark plug connector, Number of pins:4, incl. spark plug connector						1.970.599	C10	

				ENGINE
2.0 R 4motion	Petrol	221	09/19->	DNFC, DNU E

Engine	Information	A10	A20	A40	A50	A70	C10 - C30	C20	E01
All engines	01/11/19 ->, x 4, HITACHI, COIL ON PLUG, incl. spark plug connector						1.970.636	C10	

				ENGINE
2.0 TSI 4motion	Petrol	140	07/17->	CZPB, DKZA, DNNA

Engine	Information	A10	A20	A40	A50	A70	C10 - C30	C20	E01
All engines	01/10/18 ->, x 4, HITACHI, COIL ON PLUG, incl. spark plug connector						1.970.636	C10	

UP

				ENGINE
1.0	Petrol	44	08/11->	CHYA, CHYE, DAFA

Engine	Information	A10	A20	A40	A50	A70	C10 - C30	C20	E01
All engines	x 3, BERU, ELDOR, HITACHI, COIL ON PLUG, incl. spark plug connector, Number of pins:4, incl. spark plug connector						1.970.599	C10	
Eng. DAFA	Qty: 3						1.970.599	C10	

				ENGINE
1.0	Petrol	55	08/11-11/19	CHYB

Engine	Information	A10	A20	A40	A50	A70	C10 - C30	C20	E01
All engines	x 3, BERU, ELDOR, HITACHI, COIL ON PLUG, incl. spark plug connector, Number of pins:4, incl. spark plug connector						1.970.599	C10	

				ENGINE
1.0	Petrol	56	01/14->	--

Engine	Information	A10	A20	A40	A50	A70	C10 - C30	C20	E01
All engines	Qty: 3						1.970.599	C10	

				ENGINE
1.0 EcoFuel	Petrol/ Com- pressed Natural Gas (CNG)	50	11/12->	CPGA

Engine	Information	A10	A20	A40	A50	A70	C10 - C30	C20	E01
All engines	x 3, x 4, BERU, ELDOR, HITACHI, COIL ON PLUG, incl. spark plug connector, Number of pins:4, incl. spark plug connector						1.970.599	C10	

A10 CONDENSER	A20 CONTACT SET	A40 DISTRIBUTOR CAP	A50 ROTOR	A70 PICK-UP
C10 COIL	C20 IGNITION MODULE	C30 ELECTRONIC IGNITION KIT	E01 IGNITION CABLE SET	

Vehicle	alim.	kW	Date	Engine	FUNCTIONS ON THE VEHICLE							
					A10	A20	A40	A50	A70	C10 - C30	C20	E01
ENGINE												
1.0 GTI	Petrol	85	11/17->	DKRA								
Engine	Information				A10	A20	A40	A50	A70	C10 - C30	C20	E01
All engines	x 3, BERU, ELDOR, HITACHI, COIL ON PLUG, incl. spark plug connector, Number of pins:4, incl. spark plug connector									1.970.599	C10	
ENGINE												
1.0 TSI	Petrol	66	05/16-09/18	CHZA, DKLC								
Engine	Information				A10	A20	A40	A50	A70	C10 - C30	C20	E01
All engines	x 3, x 4, BERU, ELDOR, HITACHI, COIL ON PLUG, incl. spark plug connector, Number of pins:4, incl. spark plug connector									1.970.599	C10	
VENTO												
ENGINE												
1.4	Petrol	40	11/91-09/98	ABD, AEX								
Engine	Information				A10	A20	A40	A50	A70	C10 - C30	C20	E01
Eng. ABD	version Bosch						1.306.094	1.406.121R	1.906.223			
All engines										1.990.414	C30	
Eng. ABD												1.500.493
Eng. AEX	01/06/96 ->											1.501.640
ENGINE												
1.4	Petrol	44	11/91-09/98	ABD, AEX, APQ								
Engine	Information				A10	A20	A40	A50	A70	C10 - C30	C20	E01
Eng. ABD	version Bosch						1.306.094	1.406.121R	1.906.223			
All engines										1.990.414	C30	
Eng. ABD												1.500.493
Eng. AEX	01/06/96 ->											1.501.640
Eng. APQ												1.501.660
ENGINE												
1.6	Petrol	55	09/92-09/98	ABU, AEA, AEE								
Engine	Information				A10	A20	A40	A50	A70	C10 - C30	C20	E01
Eng. ABU, AEA	version Bosch						1.306.094	1.406.121R				
Eng. AEA	version Bosch								1.906.223			
All engines										1.990.414	C30	
Eng. ABU	->ch. 1H-P-560 000											1.500.736
Eng. ABU	ch. 1H-P-560 001 ->											1.501.364
Eng. AEA												1.501.549
Eng. AEE	01/06/96 ->											1.501.609
ENGINE												
1.6	Petrol	74	10/94-02/99	AEK, AFT, AKS								
Engine	Information				A10	A20	A40	A50	A70	C10 - C30	C20	E01
All engines	version Bosch						1.306.266	1.406.121R	1.906.223			
Eng. AEK	version Ducellier						1.315.068	1.415.099R				
All engines										1.990.414	C30	
Eng. AEK												1.501.551
Eng. AFT	->year 31/05/96											1.501.933
Eng. AFT, AKS	01/06/96 ->											1.501.937
ENGINE												
1.8	Petrol	55	11/91-09/98	AAM								
Engine	Information				A10	A20	A40	A50	A70	C10 - C30	C20	E01
All engines	version Bosch						1.306.094	1.406.121R				
All engines	version Ducellier						1.315.068	1.415.099R				
All engines										1.990.414	C30	
All engines	->ch. 1H-R-990 000											1.500.725
All engines	ch. 1H-S-000 001 ->											1.501.549
ENGINE												
1.8	Petrol	66	11/91-02/99	ABS, ADZ, ANP								
Engine	Information				A10	A20	A40	A50	A70	C10 - C30	C20	E01
Eng. ABS, ADZ	version Bosch						1.306.094	1.406.121R				
Eng. ABS, ADZ	version Ducellier						1.315.068	1.415.099R				
All engines										1.990.414	C30	
Eng. ABS												1.500.725
Eng. ADZ, ANP												1.501.549

A10 CONDENSER	A20 CONTACT SET	A40 DISTRIBUTOR CAP	A50 ROTOR	A70 PICK-UP
C10 COIL	C20 IGNITION MODULE	C30 ELECTRONIC IGNITION KIT	E01 IGNITION CABLE SET	

Vehicle	alim.	kW	Date	Engine	FUNCTIONS ON THE VEHICLE							
					A10	A20	A40	A50	A70	C10 - C30	C20	E01

ENGINE				
2.0	Petrol	85	11/91-09/98	2E, ADY, AGG, AKR

Engine	Information	A10	A20	A40	A50	A70	C10 - C30	C20	E01
Eng. 2E, ADY	version Bosch			1.306.094	1.406.121R				
All engines							1.990.414	C30	
Eng. AKR									1.500.725
Eng. 2E									1.500.965
Eng. ADY, AGG									1.501.549

ENGINE				
2.0 GL	Petrol	79	05/96-12/97	AEP

Engine	Information	A10	A20	A40	A50	A70	C10 - C30	C20	E01
All engines							1.990.414	C30	1.501.549

ENGINE				
2.8 VR6	Petrol	120	08/95-04/96	AAA









Engine	Information	A10	A20	A40	A50	A70	C10 - C30	C20	E01
All engines	->ch. 1H-PW480 000, ->ch. 1H-PB060 000, version Bosch			1.306.233					
All engines	->ch. 1H-NW300 000, ->ch. 1H-NB060 000, version Bosch				1.406.148R				
All engines	ch. 1H-NW300 001 ->, ->ch. 1H-PW480 000, ch. 1H-NB060 001 ->, ->ch. 1H-PB060 000, version Bosch				1.406.149R				
All engines	->ch. 1H-PW480 000						1.970.269	C10	

ENGINE				
2.8 VR6	Petrol	128	01/92-09/98	AAA

Engine	Information	A10	A20	A40	A50	A70	C10 - C30	C20	E01
All engines	->ch. 1H-PW480 000, ->ch. 1H-PB060 000, version Bosch			1.306.233					
All engines	->ch. 1H-NW300 000, ->ch. 1H-NB060 000, version Bosch				1.406.148R				
All engines	ch. 1H-NW300 001 ->, ->ch. 1H-PW480 000, ch. 1H-NB060 001 ->, ->ch. 1H-PB060 000, version Bosch				1.406.149R				
All engines	->ch. 1H-PW480 000						1.970.269	C10	

A10	CONDENSER	A20	CONTACT SET	A40	DISTRIBUTOR CAP	A50	ROTOR	A70	PICK-UP
C10	COIL	C20	IGNITION MODULE	C30	ELECTRONIC IGNITION KIT	E01	IGNITION CABLE SET		

The present application list is a brief version. For the detailed information about the possibility of installation on a specific vehicle, please refer to our web-catalogue <http://catalogo.facet.eu/>

					FUNCTIONS ON THE VEHICLE							
Vehicle	alim.	kW	Date	Engine	 A10	 A20	 A40	 A50	 A70	 C10 - C30	 C20	 E01
1300												
1.3	Petrol	43	01/68-10/71	ENGINE --, 12 H								
Engine Information					A10	A20	A40	A50	A70	C10 - C30	C20	E01
All engines							1.328.075	1.428.006				
1.3 TC												
1.3 TC	Petrol	48	10/71-10/73	ENGINE --, 12 H								
Engine Information					A10	A20	A40	A50	A70	C10 - C30	C20	E01
All engines							1.328.075	1.428.006				
16/60												
1.6	Petrol	46	01/61-12/71	ENGINE --								
Engine Information					A10	A20	A40	A50	A70	C10 - C30	C20	E01
All engines							1.328.075	1.428.006				
18/85												
1.8	Petrol	64	08/69-12/72	ENGINE --, 18HL								
Engine Information					A10	A20	A40	A50	A70	C10 - C30	C20	E01
All engines							1.328.075	1.428.006				
1.8 S												
1.8 S	Petrol	71	01/70-12/72	ENGINE --, 18HH								
Engine Information					A10	A20	A40	A50	A70	C10 - C30	C20	E01
All engines							1.328.075	1.428.006				
HORNET												
1.0	Petrol	28	01/61-12/70	ENGINE --, 99LFD								
Engine Information					A10	A20	A40	A50	A70	C10 - C30	C20	E01
All engines						1.228.083MHV		1.428.006				
SIX												
2.2	Petrol	82	01/72-10/75	ENGINE --								
Engine Information					A10	A20	A40	A50	A70	C10 - C30	C20	E01
All engines								1.428.007				

A10 CONDENSER	A20 CONTACT SET	A40 DISTRIBUTOR CAP	A50 ROTOR	A70 PICK-UP
C10 COIL	C20 IGNITION MODULE	C30 ELECTRONIC IGNITION KIT	E01 IGNITION CABLE SET	

Vehicle	alim.	kW	Date	Engine	FUNCTIONS ON THE VEHICLE							
					 A10	 A20	 A40	 A50	 A70	 C10 - C30	 C20	 E01

311

				ENGINE
1.1	Petrol	41	04/83-04/91	128A4

Engine	Information	A10	A20	A40	A50	A70	C10 - C30	C20	E01
All engines			1.206.029HV						

511

				ENGINE
1.1	Petrol	41	04/83-04/91	128A4

Engine	Information	A10	A20	A40	A50	A70	C10 - C30	C20	E01
All engines			1.206.029HV						

A10	CONDENSER	A20	CONTACT SET	A40	DISTRIBUTOR CAP	A50	ROTOR	A70	PICK-UP
C10	COIL	C20	IGNITION MODULE	C30	ELECTRONIC IGNITION KIT	E01	IGNITION CABLE SET		

The present application list is a brief version. For the detailed information about the possibility of installation on a specific vehicle, please refer to our web-catalogue <http://catalogo.facet.eu/>

Vehicle	alim.	kW	Date	Engine	FUNCTIONS ON THE VEHICLE							
					A10	A20	A40	A50	A70	C10 - C30	C20	E01

101

1.1	Petrol	37	12/75-01/80	ENGINE
				128 A.000

Engine	Information	A10	A20	A40	A50	A70	C10 - C30	C20	E01
All engines			1.230.140	1.330.081	1.430.036R		1.970.101D	C10	

1.1	Petrol	40	06/73-01/90	ENGINE
				128 A.000

Engine	Information	A10	A20	A40	A50	A70	C10 - C30	C20	E01
All engines	version Cajavec		1.207.701	1.307.701	1.407.701R				
All engines							1.970.101D	C10	

1.1	Petrol	41	05/75-12/93	ENGINE
				128 A.064

Engine	Information	A10	A20	A40	A50	A70	C10 - C30	C20	E01
All engines			1.230.140	1.330.081	1.430.036R		1.970.101D	C10	

1.1 Super	Petrol	47	07/79-09/81	ENGINE
				128 AC5.000

Engine	Information	A10	A20	A40	A50	A70	C10 - C30	C20	E01
All engines			1.230.140	1.330.081	1.430.036R		1.970.101D	C10	

YUGO

0.9	Petrol	33	04/80-06/92	ENGINE
				9A

Engine	Information	A10	A20	A40	A50	A70	C10 - C30	C20	E01
All engines	version Cajavec		1.207.701	1.307.701	1.407.701R				
All engines	version Marelli		1.230.140		1.430.036R				





A10	CONDENSER	A20	CONTACT SET	A40	DISTRIBUTOR CAP	A50	ROTOR	A70	PICK-UP
C10	COIL	C20	IGNITION MODULE	C30	ELECTRONIC IGNITION KIT	E01	IGNITION CABLE SET		



GLOSSARY OF FUNCTIONS ON THE VEHICLE

EPS-IGN22Q1

·GLOSSARIO PER FUNZIONI SU VETTURA ·GLOSSAIRE DES FONCTIONS SUR LE VÉHICULE ·GLOSSAR NACH FUNKTION IM AUTO ·GLOSARIO DE LAS FUNCIONES EN LOS VEHICULOS

#	ENGLISH 	ITALIANO 	FRANÇAIS 	DEUTSCH 	ESPAÑOL 
A10	CONDENSERS	CONDENSATORI	CONDENSATEURS	KONDENSATOREN	CONDENSADORES
A20	CONTACT SET	COPPIA CONTATTI	RUPTEUR	KONTAKTSATZ	PLATINOS
A40	DISTRIBUTOR CAP	CALOTTA	TETE D'ALLUMEUR	VERTEILERKAPPE	TAPA DEL DISTRIBUIDOR
A50	ROTOR	DISTRIBUTORE	DISRUPTEUR	VERTEILERLÄUFER	ROTOR DEL DISTRIBUIDOR
A70	PICK-UP	IMPULSORE	CAPTEUR	IMPULSGEBER	CAPTADOR
C10	COIL	BOBINA	BOBINE	ZÜNDSPULE	BOBINA
C20	IGNITION MODULE	MODULO DI ACCENSIONE	MODULES D'ALLUMAGE	ZÜNDUNGSMODUL	MÓDULO DE ENCENDIDO
C30	ELECTRONIC IGNITION KIT	KIT ACCENSIONE ELETTRONICA	KIT POUR ALLUMAGE ELECTRONIQUE	ELEKTRONISCHE ZÜNDUNGSSATZ	JUEGO DE ENCENDIDO ELECTRÓNICO
E01	IGNITION CABLE SET	SERIE CAVI COMPLETA	JEU CABLES D'ALLUMAGE	ZÜNDKABELSATZ	JUEGO DE CABLES DE ENCENDIDO



PRODUCTS BY VEHICLE MANUFACTURER

EPS-IGN22Q1

-ELENCO PRODOTTI PER MARCA -PRODUITS PAR FABRICANT VEHICULE -LISTE DER PRODUKTE JE NACH FAHRZEUGMARKE -PRODUCTOS POR FABRICANTE DE VEHÍCULO

ABARTH

A50

ROTOR
- DISTRIBUTORE
- DISRUPTEUR
- VERTEILERLÄUFER
- ROTOR DEL DISTRIBUIDOR
1.430.054R

A70

PICK-UP
- IMPULSORE
- CAPTEUR
- IMPULSGEBER
- CAPTADOR
1.930.161/1

G10

COIL
- BOBINA
- BOBINE
- ZÜNDSPULE
- BOBINA
1.970.549

ACURA

A40

DISTRIBUTOR CAP
- CALOTTA
- TETE D'ALLUMEUR
- VERTEILERKAPPE
- TAPA DEL DISTRIBUIDOR
1.322.068
1.322.069
1.322.084

A50

ROTOR
- DISTRIBUTORE
- DISRUPTEUR
- VERTEILERLÄUFER
- ROTOR DEL DISTRIBUIDOR
1.422.056
1.422.082
1.422.095
1.422.095, 1.422.097R

G10

COIL
- BOBINA
- BOBINE
- ZÜNDSPULE
- BOBINA
1.970.212
1.970.213
1.970.214
1.970.215

G20

IGNITION MODULE
- MODULO DI ACCENSIONE
- MODULES D'ALLUMAGE
- ZÜNDUNGSMODUL
- MÓDULO DE ENCENDIDO
1.965.052

ALFA ROMEO

A10

CONDENSER
- CONDENSATORE
- CONDENSATEUR
- KONDENSATOR
- CONDENSADOR
1.115.034
1.130.117

A20

CONTACT SET
- COPPIA CONTATTI
- RUPTEUR
- KONTAKTSATZ
- PLATINOS
1.206.029HV
1.206.034HVS
1.206.047

A40

DISTRIBUTOR CAP
- CALOTTA
- TETE D'ALLUMEUR
- VERTEILERKAPPE
- TAPA DEL DISTRIBUIDOR
1.306.062
1.306.076
1.306.079
1.306.081
1.306.236
1.315.049
1.315.054
1.330.115

A50

ROTOR
- DISTRIBUTORE
- DISRUPTEUR
- VERTEILERLÄUFER
- ROTOR DEL DISTRIBUIDOR
1.406.024R
1.406.025R
1.406.055R
1.406.061R
1.406.113R
1.406.119R
1.406.121R
1.406.123R
1.430.042R
1.430.051R
1.430.054R
1.430.055R
1.430.059

A70

PICK-UP
- IMPULSORE
- CAPTEUR
- IMPULSGEBER
- CAPTADOR
1.906.153

G10

COIL
- BOBINA
- BOBINE
- ZÜNDSPULE
- BOBINA
1.970.101D
1.970.146
1.970.168
1.970.313
1.970.386
1.970.386K
1.970.387
1.970.387K
1.970.397
1.970.397K
1.970.423
1.970.442
1.970.450
1.970.549

G20

IGNITION MODULE
- MODULO DI ACCENSIONE
- MODULES D'ALLUMAGE
- ZÜNDUNGSMODUL
- MÓDULO DE ENCENDIDO
1.965.005

E01

IGNITION CABLE SET
- SERIE CAVI COMPLETA
- JEU CABLES D'ALLUMAGE
- ZÜNDKABELSATZ
- JUEGO DE CABLES DE ENCENDIDO
1.499.170
1.500.623
1.500.660
1.500.666
1.500.716
1.501.607
1.501.608

ALPINA

G10

COIL
- BOBINA
- BOBINE
- ZÜNDSPULE
- BOBINA
1.970.475

ALPINE

A40

DISTRIBUTOR CAP
- CALOTTA
- TETE D'ALLUMEUR
- VERTEILERKAPPE
- TAPA DEL DISTRIBUIDOR
1.306.236

A50

ROTOR
- DISTRIBUTORE
- DISRUPTEUR
- VERTEILERLÄUFER
- ROTOR DEL DISTRIBUIDOR
1.406.023R
1.406.119R

G10

COIL
- BOBINA
- BOBINE
- ZÜNDSPULE
- BOBINA
1.970.107

ASTON MARTIN

A20

CONTACT SET
- COPPIA CONTATTI
- RUPTEUR
- KONTAKTSATZ
- PLATINOS
1.228.083MHV

A50

ROTOR
- DISTRIBUTORE
- DISRUPTEUR
- VERTEILERLÄUFER
- ROTOR DEL DISTRIBUIDOR
1.428.007

G10

COIL
- BOBINA
- BOBINE
- ZÜNDSPULE
- BOBINA
1.970.537

AUDI

A20

CONTACT SET
- COPPIA CONTATTI
- RUPTEUR
- KONTAKTSATZ
- PLATINOS

A20

1.206.029HV

A40

DISTRIBUTOR CAP
- CALOTTA
- TETE D'ALLUMEUR
- VERTEILERKAPPE
- TAPA DEL DISTRIBUIDOR
1.306.079
1.306.093
1.306.094
1.306.129
1.306.231
1.306.248
1.306.266
1.315.068

A50

ROTOR
- DISTRIBUTORE
- DISRUPTEUR
- VERTEILERLÄUFER
- ROTOR DEL DISTRIBUIDOR
1.406.021R
1.406.055R
1.406.059R
1.406.116R
1.406.121R
1.415.099R

A70

PICK-UP
- IMPULSORE
- CAPTEUR
- IMPULSGEBER
- CAPTADOR
1.906.219
1.906.223
1.906.231

G10

COIL
- BOBINA
- BOBINE
- ZÜNDSPULE
- BOBINA
1.970.125
1.970.126
1.970.127
1.970.132
1.970.354S
1.970.422
1.970.426
1.970.427
1.970.429
1.970.433
1.970.434
1.970.436
1.970.445
1.970.474
1.970.599
1.970.636



PRODUCTS BY VEHICLE MANUFACTURER

EPS-IGN22Q1

-ELENCO PRODOTTI PER MARCA -PRODUITS PAR FABRICANT VEHICULE -LISTE DER PRODUKTE JE NACH FAHRZEUGMARKE -PRODUCTOS POR FABRICANTE DE VEHÍCULO

€20

IGNITION MODULE
- MODULO DI ACCENSIONE
- MODULES D'ALLUMAGE
- ZÜNDUNGSMODUL
- MÓDULO DE ENCENDIDO

1.965.004**1.965.007****1.965.051****1.965.072****1.965.076****€30**

ELECTRONIC IGNITION KIT
- KIT ACCENSIONE ELETTRONICA
- KIT POUR ALLUMAGE ELECTRONIQUE
- ELEKTRONISCHE ZÜNDUNGSSATZ
- JUEGO DE ENCENDIDO ELECTRÓNICO

1.990.414**1.990.420****E01**

IGNITION CABLE SET
- SERIE CAVI COMPLETA
- JEU CABLES D'ALLUMAGE
- ZÜNDKABELSATZ
- JUEGO DE CABLES DE ENCENDIDO

1.499.248**1.500.768****1.501.353****1.501.356****1.501.479****1.501.484****1.501.489****1.501.491****1.501.575****1.501.585****1.501.682****AUSTIN****A20**

CONTACT SET
- COPPIA CONTATTI
- RUPTEUR
- KONTAKTSATZ
- PLATINOS

1.228.083MHV**A40**

DISTRIBUTOR CAP
- CALOTTA
- TETE D'ALLUMEUR
- VERTEILERKAPPE
- TAPA DEL DISTRIBUIDOR

1.328.075**1.328.093****1.328.094****A50**

ROTOR
- DISTRIBUTORE
- DISRUPTEUR
- VERTEILERLÄUFER
- ROTOR DEL DISTRIBUIDOR

1.428.006**1.428.024R****1.428.025****AUSTIN-HEALEY****A50**

ROTOR
- DISTRIBUTORE
- DISRUPTEUR
- VERTEILERLÄUFER
- ROTOR DEL DISTRIBUIDOR

1.428.006**1.428.007****BEDFORD****A50**

ROTOR
- DISTRIBUTORE
- DISRUPTEUR
- VERTEILERLÄUFER
- ROTOR DEL DISTRIBUIDOR

1.412.090**BENTLEY****€10**

COIL
- BOBINA
- BOBINE
- ZÜNDSPULE
- BOBINA

1.970.636**BMW****A20**

CONTACT SET
- COPPIA CONTATTI
- RUPTEUR
- KONTAKTSATZ
- PLATINOS

1.206.029HV**1.206.062****A40**

DISTRIBUTOR CAP
- CALOTTA
- TETE D'ALLUMEUR
- VERTEILERKAPPE
- TAPA DEL DISTRIBUIDOR

1.306.062**1.306.081****1.306.094****1.306.121****1.306.238****1.306.247****A50**

ROTOR
- DISTRIBUTORE
- DISRUPTEUR
- VERTEILERLÄUFER
- ROTOR DEL DISTRIBUIDOR

1.406.018R**1.406.055R****1.406.055R,****1.406.115R****1.406.060R,****1.406.112R****1.406.112R****1.406.115R****1.406.119R****€10**

COIL
- BOBINA
- BOBINE
- ZÜNDSPULE
- BOBINA

1.970.112**1.970.162S****1.970.352****1.970.412****1.970.413****1.970.475****1.970.607****1.970.632****€20**

IGNITION MODULE
- MODULO DI ACCENSIONE
- MODULES D'ALLUMAGE
- ZÜNDUNGSMODUL
- MÓDULO DE ENCENDIDO

1.965.005**E01**

IGNITION CABLE SET
- SERIE CAVI COMPLETA
- JEU CABLES D'ALLUMAGE
- ZÜNDKABELSATZ
- JUEGO DE CABLES DE ENCENDIDO

1.499.069**1.500.572****1.500.573****1.500.578****1.500.587****1.500.597****1.500.605****1.500.900****1.501.921****BOND****A40**

DISTRIBUTOR CAP
- CALOTTA
- TETE D'ALLUMEUR
- VERTEILERKAPPE
- TAPA DEL DISTRIBUIDOR

1.328.075**A50**

ROTOR
- DISTRIBUTORE
- DISRUPTEUR
- VERTEILERLÄUFER
- ROTOR DEL DISTRIBUIDOR

1.412.090, 1.428.007**1.428.006****BORGWARD****A50**

ROTOR
- DISTRIBUTORE
- DISRUPTEUR
- VERTEILERLÄUFER
- ROTOR DEL DISTRIBUIDOR

1.406.018R**CHEVROLET****A40**

DISTRIBUTOR CAP
- CALOTTA
- TETE D'ALLUMEUR
- VERTEILERKAPPE
- TAPA DEL DISTRIBUIDOR

1.331.139**1.331.172****A50**

ROTOR
- DISTRIBUTORE
- DISRUPTEUR
- VERTEILERLÄUFER
- ROTOR DEL DISTRIBUIDOR

1.431.131**1.431.139****€10**

COIL
- BOBINA
- BOBINE
- ZÜNDSPULE
- BOBINA

1.970.219**1.970.545****1.970.547****1.970.585****E01**

IGNITION CABLE SET
- SERIE CAVI COMPLETA
- JEU CABLES D'ALLUMAGE
- ZÜNDKABELSATZ
- JUEGO DE CABLES DE ENCENDIDO

1.499.006**1.499.007****1.499.247****1.499.249****1.501.509****1.501.634****1.501.677****1.501.680****1.501.730****1.501.731****CHRYSLER****A40**

DISTRIBUTOR CAP
- CALOTTA
- TETE D'ALLUMEUR
- VERTEILERKAPPE
- TAPA DEL DISTRIBUIDOR

1.331.116**1.331.161****A50**

ROTOR
- DISTRIBUTORE
- DISRUPTEUR
- VERTEILERLÄUFER
- ROTOR DEL DISTRIBUIDOR

1.410.179**1.431.109****€10**

COIL
- BOBINA
- BOBINE
- ZÜNDSPULE
- BOBINA

1.970.417**1.970.423****1.970.549****E01**

IGNITION CABLE SET
- SERIE CAVI COMPLETA
- JEU CABLES D'ALLUMAGE
- ZÜNDKABELSATZ
- JUEGO DE CABLES DE ENCENDIDO

1.501.343**1.501.345****1.501.507****1.501.508****1.501.511****1.501.511, 1.501.764****1.501.719****1.501.990**



PRODUCTS BY VEHICLE MANUFACTURER

EPS-IGN22Q1

-ELENCO PRODOTTI PER MARCA -PRODUITS PAR FABRICANT VEHICULE -LISTE DER PRODUKTE JE NACH FAHRZEUGMARKE -PRODUCTOS POR FABRICANTE DE VEHÍCULO

CITROËN

A10

CONDENSER

- CONDENSATORE
- CONDENSATEUR
- KONDENSATOR
- CONDENSADOR

1.115.034

A20

CONTACT SET

- COPPIA CONTATTI
- RUPTEUR
- KONTAKTSATZ
- PLATINOS

1.215.064

A40

DISTRIBUTOR CAP

- CALOTTA
- TÊTE D'ALLUMEUR
- VERTEILERKAPPE
- TAPA DEL DISTRIBUIDOR

1.306.124**1.306.241****1.306.252****1.315.058****1.315.059****1.315.067****1.315.074****1.315.077****1.315.078****1.315.087**

A50

ROTOR

- DISTRIBUTORE
- DISRUPTEUR
- VERTEILERLÄUFER
- ROTOR DEL DISTRIBUIDOR

1.406.056R**1.406.061R****1.406.119R****1.415.083R****1.415.088****1.415.091****1.415.094****1.415.102R****1.415.104****1.430.060**

A70

PICK-UP

- IMPULSORE
- CAPTEUR
- IMPULSgeber
- CAPTADOR

1.915.017**1.915.019**

G10

COIL

- BOBINA
- BOBINE
- ZÜNDSPULE
- BOBINA

1.970.105**1.970.106****1.970.155****1.970.168****1.970.188****1.970.189****1.970.403****1.970.405****1.970.407****1.970.408****1.970.459****1.970.461****1.970.475****1.970.476****1.970.483****1.970.497****1.970.505****1.970.509****1.970.609****1.970.620**

G20

IGNITION MODULE

- MODULO DI ACCENSIONE
- MODULES D'ALLUMAGE
- ZÜNDUNGSMODUL
- MÓDULO DE ENCENDIDO

1.965.005**1.965.034**

E01

IGNITION CABLE SET

- SERIE CAVI COMPLETA
- JEU CABLES D'ALLUMAGE
- ZÜNDKABELSATZ
- JUEGO DE CABLES DE ENCENDIDO

1.500.491**1.500.494****1.500.655****1.500.674****1.500.747****1.501.374****1.501.376**

CUPRA

G10

COIL

- BOBINA
- BOBINE
- ZÜNDSPULE
- BOBINA

1.970.599**1.970.636**

DACIA

A10

CONDENSER

- CONDENSATORE
- CONDENSATEUR
- KONDENSATOR
- CONDENSADOR

1.115.023

A20

CONTACT SET

- COPPIA CONTATTI
- RUPTEUR
- KONTAKTSATZ
- PLATINOS

1.215.055**1.215.101**

A40

DISTRIBUTOR CAP

- CALOTTA
- TÊTE D'ALLUMEUR
- VERTEILERKAPPE
- TAPA DEL DISTRIBUIDOR

1.315.049**1.315.054**

A50

ROTOR

- DISTRIBUTORE
- DISRUPTEUR
- VERTEILERLÄUFER
- ROTOR DEL DISTRIBUIDOR

1.415.091

G10

COIL

- BOBINA
- BOBINE
- ZÜNDSPULE
- BOBINA

1.970.101D**1.970.432****1.970.518****1.970.552****1.970.596****1.970.613**

E01

IGNITION CABLE SET

- SERIE CAVI COMPLETA
- JEU CABLES D'ALLUMAGE
- ZÜNDKABELSATZ
- JUEGO DE CABLES DE ENCENDIDO

1.499.244**1.499.246****1.499.252****1.500.511**

DAEWOO

A40

DISTRIBUTOR CAP

- CALOTTA
- TÊTE D'ALLUMEUR
- VERTEILERKAPPE
- TAPA DEL DISTRIBUIDOR

1.312.075**1.331.139****1.331.172**

A50

ROTOR

- DISTRIBUTORE
- DISRUPTEUR
- VERTEILERLÄUFER
- ROTOR DEL DISTRIBUIDOR

1.412.098**1.431.131****1.431.139**

G10

COIL

- BOBINA
- BOBINE
- ZÜNDSPULE
- BOBINA

1.970.219**1.970.316****1.970.585**

E01

IGNITION CABLE SET

- SERIE CAVI COMPLETA
- JEU CABLES D'ALLUMAGE
- ZÜNDKABELSATZ
- JUEGO DE CABLES DE ENCENDIDO

1.499.006**1.499.007****1.501.433****1.501.509****1.501.634****1.501.677****1.501.680****1.501.730****1.501.731****1.501.942**

DAIHATSU

A20

CONTACT SET

- COPPIA CONTATTI
- RUPTEUR
- KONTAKTSATZ
- PLATINOS

1.213.011HV

A40

DISTRIBUTOR CAP

- CALOTTA
- TÊTE D'ALLUMEUR
- VERTEILERKAPPE
- TAPA DEL DISTRIBUIDOR

1.313.094

A40

1.313.128**1.313.257****1.313.258**

A50

ROTOR

- DISTRIBUTORE
- DISRUPTEUR
- VERTEILERLÄUFER
- ROTOR DEL DISTRIBUIDOR

1.413.014**1.413.028****1.413.029****1.413.030**

G10

COIL

- BOBINA
- BOBINE
- ZÜNDSPULE
- BOBINA

1.970.252**1.970.461****1.970.537**

E01

IGNITION CABLE SET

- SERIE CAVI COMPLETA
- JEU CABLES D'ALLUMAGE
- ZÜNDKABELSATZ
- JUEGO DE CABLES DE ENCENDIDO

1.501.436**1.501.732**

DAIMLER

A50

ROTOR

- DISTRIBUTORE
- DISRUPTEUR
- VERTEILERLÄUFER
- ROTOR DEL DISTRIBUIDOR

1.428.007

DS

G10

COIL

- BOBINA
- BOBINE
- ZÜNDSPULE
- BOBINA

1.970.475**1.970.609****1.970.620**



PRODUCTS BY VEHICLE MANUFACTURER

EPS-IGN22Q1

-ELENCO PRODOTTI PER MARCA -PRODUITS PAR FABRICANT VEHICULE -LISTE DER PRODUKTE JE NACH FAHRZEUGMARKE -PRODUCTOS POR FABRICANTE DE VEHÍCULO

FIAT**A10****CONDENSER**

- CONDENSATORE
- CONDENSATEUR
- KONDENSATOR
- CONDENSADOR

1.115.023

1.115.034

1.115.039

1.130.117

1.130.127

1.130.128

A20**CONTACT SET**

- COPPIA CONTATTI
- RUPTEUR
- KONTAKTSATZ
- PLATINOS

1.215.055

1.215.056

1.215.056HV

1.215.101

1.215.105

1.215.106

1.215.122

1.217.020

1.230.120

1.230.132

1.230.139

1.230.140

1.230.142

1.230.146M

1.230.149M

1.230.150M

A40**DISTRIBUTOR CAP**

- CALOTTA
- TETE D'ALLUMEUR
- VERTEILERKAPPE
- TAPA DEL DISTRIBUIDOR

1.306.079

1.315.045

1.315.049

1.315.054

1.315.058

1.315.059

1.315.080

1.315.087

1.317.016

1.330.059

1.330.069

1.330.081

1.330.082

1.330.086

1.330.090

1.330.093

1.330.098

1.330.101

1.330.104

A40

1.330.109

1.330.114

1.330.115

A50**ROTOR**

- DISTRIBUTORE
- DISRUPTEUR
- VERTEILERLÄUFER
- ROTOR DEL DISTRIBUIDOR

1.406.025R

1.406.061R

1.415.083R

1.415.091

1.415.094

1.415.096R

1.417.052

1.417.052R

1.430.029

1.430.036R

1.430.037

1.430.037R

1.430.040

1.430.041

1.430.042R

1.430.047R

1.430.047R, 1.430.060

1.430.054R

1.430.055R

1.430.057R

1.430.059

1.430.060

A70**PICK-UP**

- IMPULSORE
- CAPTEUR
- IMPULSGEBER
- CAPTADOR

1.906.153

1.915.019

1.930.161/1

1.930.176M

1.930.177/1

1.930.180M

G10**COIL**

- BOBINA
- BOBINE
- ZÜNDSPULE
- BOBINA

1.970.101D

1.970.102

1.970.103

1.970.108

1.970.146

1.970.148

1.970.158

1.970.168

1.970.188

1.970.314

1.970.345

G10

1.970.384

1.970.405

1.970.408

1.970.416

1.970.423

1.970.442

1.970.450

1.970.549

1.970.570

G20**IGNITION MODULE**

- MODULO DI ACCENSIONE
- MODULES D'ALLUMAGE
- ZÜNDUNGSMODUL
- MÓDULO DE ENCENDIDO

1.965.005

1.965.020

1.965.029

G30**ELECTRONIC IGNITION KIT**

- KIT ACCENSIONE ELETTRONICA
- KIT POUR ALLUMAGE ELECTRONIQUE
- ELEKTRONISCHE ZÜNDUNGSSATZ
- JUEGO DE ENCENDIDO ELECTRONICO

1.990.303

E01**IGNITION CABLE SET**

- SERIE CAVI COMPLETA
- JEU CABLES D'ALLUMAGE
- ZÜNDKABELSATZ
- JUEGO DE CABLES DE ENCENDIDO

1.499.013

1.499.170

1.500.347

1.500.351

1.500.354

1.500.386

1.500.398

1.500.429

1.500.432

1.500.456

1.500.466

1.500.494

1.500.507

1.500.613

1.500.615

1.500.616

1.500.650

1.500.655

1.500.674

1.500.692

1.500.694

1.500.700

1.500.808

1.500.815

1.500.887

1.500.888

1.500.889

1.501.363

1.501.451

E01

1.501.503

1.501.504

1.501.505

1.501.527

FIAT (BR)**A40****DISTRIBUTOR CAP**

- CALOTTA
- TETE D'ALLUMEUR
- VERTEILERKAPPE
- TAPA DEL DISTRIBUIDOR

1.330.101

1.330.114

1.330.115

A50**ROTOR**

- DISTRIBUTORE
- DISRUPTEUR
- VERTEILERLÄUFER
- ROTOR DEL DISTRIBUIDOR

1.430.055R

1.430.059

1.430.060

A70**PICK-UP**

- IMPULSORE
- CAPTEUR
- IMPULSGEBER
- CAPTADOR

1.930.177/1

G10**COIL**

- BOBINA
- BOBINE
- ZÜNDSPULE
- BOBINA

1.970.146

1.970.168

1.970.314

1.970.345

1.970.384

1.970.416

G30**ELECTRONIC IGNITION KIT**

- KIT ACCENSIONE ELETTRONICA
- KIT POUR ALLUMAGE ELECTRONIQUE
- ELEKTRONISCHE ZÜNDUNGSSATZ
- JUEGO DE ENCENDIDO ELECTRONICO

1.990.303

E01**IGNITION CABLE SET**

- SERIE CAVI COMPLETA
- JEU CABLES D'ALLUMAGE
- ZÜNDKABELSATZ
- JUEGO DE CABLES DE ENCENDIDO

E01

1.500.650

1.500.655

1.501.503

1.501.505

FORD**A20****CONTACT SET**

- COPPIA CONTATTI
- RUPTEUR
- KONTAKTSATZ
- PLATINOS

1.206.021

1.206.049HVS

1.219.043HV

1.219.044HV

1.228.083MHV

A40**DISTRIBUTOR CAP**

- CALOTTA
- TETE D'ALLUMEUR
- VERTEILERKAPPE
- TAPA DEL DISTRIBUIDOR

1.306.062

1.306.079

1.306.079, 1.306.109

1.306.081

1.306.109

1.306.235

1.306.253

1.319.083

1.319.092

1.322.046

1.322.089

1.328.070

1.328.070, 1.328.075

1.328.075

1.328.083

1.328.096

1.330.098

1.330.101

1.331.121

A50**ROTOR**

- DISTRIBUTORE
- DISRUPTEUR
- VERTEILERLÄUFER
- ROTOR DEL DISTRIBUIDOR

1.406.012R

1.406.018R

1.406.025R

1.406.060R

1.406.060R,

1.406.061R

1.406.061R

1.406.112R

1.406.121R



PRODUCTS BY VEHICLE MANUFACTURER

EPS-IGN22Q1

-ELENCO PRODOTTI PER MARCA -PRODUITS PAR FABRICANT VEHICULE -LISTE DER PRODUKTE JE NACH FAHRZEUGMARKE -PRODUCTOS POR FABRICANTE DE VEHÍCULO

A50
1.406.140R
1.419.085
1.419.092
1.419.094R
1.422.070
1.422.102
1.428.006
1.428.007
1.428.026R
1.430.057R
1.431.132
1.431.137

A70
PICK-UP -IMPULSORE -CAPTEUR -IMPULSGEBER -CAPTADOR
1.906.233

G10
COIL -BOBINA -BOBINE -ZÜNDSPULE -BOBINA
1.970.135
1.970.135, 1.970.312
1.970.169
1.970.169, 1.970.312
1.970.170
1.970.289
1.970.299
1.970.299, 1.970.312
1.970.299S
1.970.312
1.970.312, 1.970.364
1.970.364
1.970.366S
1.970.423
1.970.435
1.970.478
1.970.480
1.970.481
1.970.532
1.970.619
1.970.623

E01
IGNITION CABLE SET -SERIE CAVI COMPLETA -JEU CABLES D'ALLUMAGE -ZÜNDKABELSATZ -JUEGO DE CABLES DE ENCENDIDO
1.499.170
1.499.208
1.499.214
1.499.242
1.500.864
1.501.007
1.501.078
1.501.145

E01
1.501.281
1.501.568
1.501.619
1.501.624
1.501.625
1.501.630
1.501.639
1.501.789
1.501.976

FORD (BR)

G10
COIL -BOBINA -BOBINE -ZÜNDSPULE -BOBINA
1.970.532

E01
IGNITION CABLE SET -SERIE CAVI COMPLETA -JEU CABLES D'ALLUMAGE -ZÜNDKABELSATZ -JUEGO DE CABLES DE ENCENDIDO
1.501.691

FORD AUSTRALIA

A20
CONTACT SET -COPPIA CONTATTI -RUPTEUR -KONTAKTSATZ -PLATINOS
1.206.034HVS

A40
DISTRIBUTOR CAP -CALOTTA -TETE D'ALLUMEUR -VERTEILERKAPPE -TAPA DEL DISTRIBUIDOR
1.306.079
1.306.244
1.322.077, 1.322.092
1.331.003/00
1.331.003/00,
1.331.109
1.331.003/00,
1.331.109, 1.331.118
1.331.109
1.331.131
1.331.137, 1.331.149
1.331.150

A50
ROTOR -DISTRIBUTORE -DISRUPTEUR -VERTEILERLÄUFER -ROTOR DEL DISTRIBUIDOR
1.406.012R
1.406.131
1.422.094, 1.422.102
1.431.023
1.431.119
1.431.132
1.431.133, 1.431.134

G10
COIL -BOBINA -BOBINE -ZÜNDSPULE -BOBINA
1.970.170

FORD USA

A40
DISTRIBUTOR CAP -CALOTTA -TETE D'ALLUMEUR -VERTEILERKAPPE -TAPA DEL DISTRIBUIDOR
1.331.137

A50
ROTOR -DISTRIBUTORE -DISRUPTEUR -VERTEILERLÄUFER -ROTOR DEL DISTRIBUIDOR
1.431.133
1.431.134

G10
COIL -BOBINA -BOBINE -ZÜNDSPULE -BOBINA
1.970.170
1.970.289

FSO

A10
CONDENSER -CONDENSATORE -CONDENSATEUR -KONDENSATOR -CONDENSADOR
1.130.128

A20
CONTACT SET -COPPIA CONTATTI -RUPTEUR -KONTAKTSATZ -PLATINOS
1.230.120
1.230.127
1.230.146M
1.230.150M
1.249.350

A40
DISTRIBUTOR CAP -CALOTTA -TETE D'ALLUMEUR -VERTEILERKAPPE -TAPA DEL DISTRIBUIDOR
1.330.086

A50
ROTOR -DISTRIBUTORE -DISRUPTEUR -VERTEILERLÄUFER -ROTOR DEL DISTRIBUIDOR
1.430.040

G10
COIL -BOBINA -BOBINE -ZÜNDSPULE -BOBINA
1.970.101D

GINETTA

A50
ROTOR -DISTRIBUTORE -DISRUPTEUR -VERTEILERLÄUFER -ROTOR DEL DISTRIBUIDOR
1.428.006

HOLDEN

A20
CONTACT SET -COPPIA CONTATTI -RUPTEUR -KONTAKTSATZ -PLATINOS
1.206.034HVS
1.213.011HV
1.222.056HV

A40
DISTRIBUTOR CAP -CALOTTA -TETE D'ALLUMEUR -VERTEILERKAPPE -TAPA DEL DISTRIBUIDOR
1.306.080
1.306.112
1.306.256
1.306.257
1.312.075
1.313.092
1.313.093
1.313.254
1.313.265
1.313.267
1.313.278
1.322.003
1.322.057
1.322.060
1.328.100
1.331.131
1.331.132

A50
ROTOR -DISTRIBUTORE -DISRUPTEUR -VERTEILERLÄUFER -ROTOR DEL DISTRIBUIDOR
1.406.056R
1.406.121R
1.406.127R
1.406.131
1.412.098
1.413.014
1.413.027
1.413.028
1.413.029
1.413.030
1.422.052
1.422.069
1.428.028R
1.431.108
1.431.119

G10
COIL -BOBINA -BOBINE -ZÜNDSPULE -BOBINA
1.970.140
1.970.197
1.970.198
1.970.199
1.970.219
1.970.272
1.970.273



PRODUCTS BY VEHICLE MANUFACTURER

EPS-IGN22Q1

-ELENCO PRODOTTI PER MARCA -PRODUITS PAR FABRICANT VEHICULE -LISTE DER PRODUKTE JE NACH FAHRZEUGMARKE -PRODUCTOS POR FABRICANTE DE VEHÍCULO

C20

IGNITION MODULE
- MODULO DI ACCENSIONE
- MODULES D'ALLUMAGE
- ZÜNDUNGSMODUL
- MÓDULO DE ENCENDIDO

1.965.036**E01**

IGNITION CABLE SET
- SERIE CAVI COMPLETA
- JEU CABLES D'ALLUMAGE
- ZÜNDKABELSATZ
- JUEGO DE CABLES DE ENCENDIDO

1.499.020**1.500.688****1.500.689****1.501.209****1.501.237****1.501.562****1.501.793****1.501.947****HONDA****A40**

DISTRIBUTOR CAP
- CALOTTA
- TÊTE D'ALLUMEUR
- VERTEILERKAPPE
- TAPA DEL DISTRIBUIDOR

1.322.022**1.322.060****1.322.068****1.322.069****1.322.071****1.322.076****1.322.076, 1.322.082****1.322.082****1.322.093****1.328.106****A50**

ROTOR
- DISTRIBUTORE
- DISRUPTEUR
- VERTEILERLÄUFER
- ROTOR DEL DISTRIBUIDOR

1.422.056**1.422.069****1.422.081****1.422.082****1.422.092****1.422.095****1.422.095, 1.422.098****1.422.097R****1.422.098****1.422.102****G10**

COIL
- BOBINA
- BOBINE
- ZÜNDSPULE
- BOBINA

1.970.168**1.970.211****1.970.212****1.970.213****1.970.214****1.970.215****1.970.216****1.970.347****1.970.457****1.970.522****1.970.527****1.970.529****1.970.529, 1.970.608****1.970.603****1.970.608****C20**

IGNITION MODULE
- MODULO DI ACCENSIONE
- MODULES D'ALLUMAGE
- ZÜNDUNGSMODUL
- MÓDULO DE ENCENDIDO

1.965.052**E01**

IGNITION CABLE SET
- SERIE CAVI COMPLETA
- JEU CABLES D'ALLUMAGE
- ZÜNDKABELSATZ
- JUEGO DE CABLES DE ENCENDIDO

1.501.686**1.501.699****1.501.702****1.501.709****1.501.711****HYUNDAI****A20**

CONTACT SET
- COPPIA CONTATTI
- RUPTEUR
- KONTAKTSATZ
- PLATINOS

1.231.084**A40**

DISTRIBUTOR CAP
- CALOTTA
- TÊTE D'ALLUMEUR
- VERTEILERKAPPE
- TAPA DEL DISTRIBUIDOR

1.306.124**1.331.003/00****1.331.116****1.331.121****1.331.170****A50**

ROTOR
- DISTRIBUTORE
- DISRUPTEUR
- VERTEILERLÄUFER
- ROTOR DEL DISTRIBUIDOR

1.406.121R**1.431.023****1.431.107****1.431.109****1.431.138****A70**

PICK-UP
- IMPULSORE
- CAPTEUR
- IMPULSGEBER
- CAPTADOR

1.906.244**G10**

COIL
- BOBINA
- BOBINE
- ZÜNDSPULE
- BOBINA

1.970.394**1.970.492****1.970.495****1.970.496****1.970.543****1.970.543, 1.970.611****1.970.556****1.970.579****1.970.580****1.970.581****1.970.582****1.970.582, 1.970.583****1.970.582, 1.970.584****1.970.583****1.970.584****1.970.585****1.970.586****1.970.587****1.970.611****1.970.612****1.970.614****1.970.622****1.970.638****1.970.647****E01**

IGNITION CABLE SET
- SERIE CAVI COMPLETA
- JEU CABLES D'ALLUMAGE
- ZÜNDKABELSATZ
- JUEGO DE CABLES DE ENCENDIDO

1.499.111**1.499.119****1.499.120****1.499.235****1.499.236****1.499.241****1.499.255****1.501.385****E01****1.501.401****INFINITI****A40**

DISTRIBUTOR CAP
- CALOTTA
- TÊTE D'ALLUMEUR
- VERTEILERKAPPE
- TAPA DEL DISTRIBUIDOR

1.322.073**1.331.151****A50**

ROTOR
- DISTRIBUTORE
- DISRUPTEUR
- VERTEILERLÄUFER
- ROTOR DEL DISTRIBUIDOR

1.422.085**1.431.136****G10**

COIL
- BOBINA
- BOBINE
- ZÜNDSPULE
- BOBINA

1.970.533**1.970.552****1.970.626****INNOCENTI****A40**

DISTRIBUTOR CAP
- CALOTTA
- TÊTE D'ALLUMEUR
- VERTEILERKAPPE
- TAPA DEL DISTRIBUIDOR

1.330.101**1.330.104****1.330.114****1.330.115****A50**

ROTOR
- DISTRIBUTORE
- DISRUPTEUR
- VERTEILERLÄUFER
- ROTOR DEL DISTRIBUIDOR

1.430.047R, 1.430.060**1.430.059****1.430.060****A70**

PICK-UP
- IMPULSORE
- CAPTEUR
- IMPULSGEBER
- CAPTADOR

1.930.176M**1.930.177/1****G10**

COIL
- BOBINA
- BOBINE
- ZÜNDSPULE
- BOBINA

1.970.146**1.970.148****1.970.158****1.970.188****C20**

IGNITION MODULE
- MODULO DI ACCENSIONE
- MODULES D'ALLUMAGE
- ZÜNDUNGSMODUL
- MÓDULO DE ENCENDIDO

1.965.020**E01**

IGNITION CABLE SET
- SERIE CAVI COMPLETA
- JEU CABLES D'ALLUMAGE
- ZÜNDKABELSATZ
- JUEGO DE CABLES DE ENCENDIDO

1.500.655**ISUZU****A40**

DISTRIBUTOR CAP
- CALOTTA
- TÊTE D'ALLUMEUR
- VERTEILERKAPPE
- TAPA DEL DISTRIBUIDOR

1.312.075**A50**

ROTOR
- DISTRIBUTORE
- DISRUPTEUR
- VERTEILERLÄUFER
- ROTOR DEL DISTRIBUIDOR

1.412.098**1.422.069****G10**

COIL
- BOBINA
- BOBINE
- ZÜNDSPULE
- BOBINA

1.970.219



PRODUCTS BY VEHICLE MANUFACTURER

EPS-IGN22Q1

-ELENCO PRODOTTI PER MARCA -PRODUITS PAR FABRICANT VEHICULE -LISTE DER PRODUKTE JE NACH FAHRZEUGMARKE -PRODUCTOS POR FABRICANTE DE VEHÍCULO

C20

IGNITION MODULE
- MODULO DI ACCENSIONE
- MODULES D'ALLUMAGE
- ZÜNDUNGSMODUL
- MÓDULO DE ENCENDIDO

1.965.025**IVECO****C10**

COIL
- BOBINA
- BOBINE
- ZÜNDSPULE
- BOBINA

1.970.345**1.970.442****JAGUAR****A20**

CONTACT SET
- COPPIA CONTATTI
- RUPTEUR
- KONTAKTSATZ
- PLATINOS

1.228.083MHV**A40**

DISTRIBUTOR CAP
- CALOTTA
- TÊTE D'ALLUMEUR
- VERTEILERKAPPE
- TAPA DEL DISTRIBUIDOR

1.328.098**1.330.110****A50**

ROTOR
- DISTRIBUTORE
- DISRUPTEUR
- VERTEILERLÄUFER
- ROTOR DEL DISTRIBUIDOR

1.428.007**1.428.027R****1.430.058****C10**

COIL
- BOBINA
- BOBINE
- ZÜNDSPULE
- BOBINA

1.970.170**JEEP****A40**

DISTRIBUTOR CAP
- CALOTTA
- TÊTE D'ALLUMEUR
- VERTEILERKAPPE
- TAPA DEL DISTRIBUIDOR

1.319.093**A50**

ROTOR
- DISTRIBUTORE
- DISRUPTEUR
- VERTEILERLÄUFER
- ROTOR DEL DISTRIBUIDOR

1.419.092**C10**

COIL
- BOBINA
- BOBINE
- ZÜNDSPULE
- BOBINA

1.970.107**1.970.549****E01**

IGNITION CABLE SET
- SERIE CAVI COMPLETA
- JEU CABLES D'ALLUMAGE
- ZÜNDKABELSATZ
- JUEGO DE CABLES DE ENCENDIDO

1.499.181**JENSEN****A40**

DISTRIBUTOR CAP
- CALOTTA
- TÊTE D'ALLUMEUR
- VERTEILERKAPPE
- TAPA DEL DISTRIBUIDOR

1.328.075**A50**

ROTOR
- DISTRIBUTORE
- DISRUPTEUR
- VERTEILERLÄUFER
- ROTOR DEL DISTRIBUIDOR

1.428.006**KIA****A40**

DISTRIBUTOR CAP
- CALOTTA
- TÊTE D'ALLUMEUR
- VERTEILERKAPPE
- TAPA DEL DISTRIBUIDOR

1.331.121**1.331.122****A50**

ROTOR
- DISTRIBUTORE
- DISRUPTEUR
- VERTEILERLÄUFER
- ROTOR DEL DISTRIBUIDOR

1.431.108**C10**

COIL
- BOBINA
- BOBINE
- ZÜNDSPULE
- BOBINA

1.970.168**1.970.219****1.970.492****1.970.495****1.970.543****1.970.543, 1.970.611****1.970.556****1.970.579****1.970.580****1.970.580, 1.970.587****1.970.581****1.970.582****1.970.584****1.970.586****1.970.587****1.970.589****1.970.611****1.970.612****1.970.614****1.970.622****1.970.638****1.970.647****E01**

IGNITION CABLE SET
- SERIE CAVI COMPLETA
- JEU CABLES D'ALLUMAGE
- ZÜNDKABELSATZ
- JUEGO DE CABLES DE ENCENDIDO

1.499.111**1.499.119****1.499.235****1.499.236****1.499.239****1.499.241****1.501.385****1.501.398****1.501.401****1.501.841****1.501.851****LADA****A20**

CONTACT SET
- COPPIA CONTATTI
- RUPTEUR
- KONTAKTSATZ
- PLATINOS

A20**1.246.070****1.246.071****A40**

DISTRIBUTOR CAP
- CALOTTA
- TÊTE D'ALLUMEUR
- VERTEILERKAPPE
- TAPA DEL DISTRIBUIDOR

1.347.025**1.347.027****A50**

ROTOR
- DISTRIBUTORE
- DISRUPTEUR
- VERTEILERLÄUFER
- ROTOR DEL DISTRIBUIDOR

1.446.014R**1.446.016R****C10**

COIL
- BOBINA
- BOBINE
- ZÜNDSPULE
- BOBINA

1.970.101D**1.970.432****1.970.596****1.970.613****E01**

IGNITION CABLE SET
- SERIE CAVI COMPLETA
- JEU CABLES D'ALLUMAGE
- ZÜNDKABELSATZ
- JUEGO DE CABLES DE ENCENDIDO

1.500.511**LANCIA****A10**

CONDENSER
- CONDENSATORE
- CONDENSATEUR
- KONDENSATOR
- CONDENSADOR

1.115.023**A20**

CONTACT SET
- COPPIA CONTATTI
- RUPTEUR
- KONTAKTSATZ
- PLATINOS

1.215.101**A40**

DISTRIBUTOR CAP
- CALOTTA
- TÊTE D'ALLUMEUR
- VERTEILERKAPPE
- TAPA DEL DISTRIBUIDOR

1.306.079**1.306.236****1.315.058****1.315.080****1.330.093****1.330.098****1.330.101****1.330.101, 1.330.104****1.330.104****1.330.109****1.330.114****1.330.115****A50**

ROTOR
- DISTRIBUTORE
- DISRUPTEUR
- VERTEILERLÄUFER
- ROTOR DEL DISTRIBUIDOR

1.406.023R**1.406.025R****1.406.119R****1.415.083R****1.415.094****1.430.047R****1.430.054R****1.430.055R****1.430.055R, 1.430.059****1.430.057R****1.430.057R, 1.430.060****1.430.059****1.430.060****A70**

PICK-UP
- IMPULSORE
- CAPTEUR
- IMPULSgeber
- CAPTADOR

1.930.161/1**1.930.163/1****1.930.176M****1.930.177/1****1.930.180M****C10**

COIL
- BOBINA
- BOBINE
- ZÜNDSPULE
- BOBINA

1.970.101D**1.970.103****1.970.108****1.970.126****1.970.146****1.970.148****1.970.158****1.970.168**



PRODUCTS BY VEHICLE MANUFACTURER

EPS-IGN22Q1

-ELENCO PRODOTTI PER MARCA -PRODUITS PAR FABRICANT VEHICULE -LISTE DER PRODUKTE JE NACH FAHRZEUGMARKE -PRODUCTOS POR FABRICANTE DE VEHÍCULO

G10

1.970.188
1.970.313
1.970.314
1.970.345
1.970.384
1.970.408
1.970.423
1.970.442
1.970.549

G20**IGNITION MODULE**

- MODULO DI ACCENSIONE
- MODULES D'ALLUMAGE
- ZÜNDUNGSMODUL
- MÓDULO DE ENCENDIDO

1.965.020
1.965.029

G30**ELECTRONIC IGNITION KIT**

- KIT ACCENSIONE ELETTRONICA
- KIT POUR ALLUMAGE ELECTRONIQUE
- ELEKTRONISCHE ZÜNDUNGSATZ
- JUEGO DE ENCENDIDO ELECTRÓNICO

1.990.303

E01**IGNITION CABLE SET**

- SERIE CAVI COMPLETA
- JEU CABLES D'ALLUMAGE
- ZÜNDKABELSATZ
- JUEGO DE CABLES DE ENCENDIDO

1.499.170
1.500.347
1.500.354
1.500.398
1.500.456
1.500.471
1.500.616
1.500.650
1.500.655
1.500.692
1.500.694
1.500.700
1.500.888
1.500.889
1.501.363
1.501.451
1.501.503
1.501.504
1.501.505

LAND ROVER**A10****CONDENSER**

- CONDENSATORE
- CONDENSATEUR
- KONDENSATOR
- CONDENSADOR

A10

1.115.034

A20**CONTACT SET**

- COPPIA CONTATTI
- RUPTEUR
- KONTAKTSATZ
- PLATINOS

1.228.083MHV
1.228.089

A40**DISTRIBUTOR CAP**

- CALOTTA
- TETE D'ALLUMEUR
- VERTEILERKAPPE
- TAPA DEL DISTRIBUIDOR

1.315.054
1.328.070, 1.328.075
1.328.078
1.328.091
1.328.093

A50**ROTOR**

- DISTRIBUTORE
- DISRUPTEUR
- VERTEILERLÄUFER
- ROTOR DEL DISTRIBUIDOR

1.415.091
1.428.006
1.428.012
1.428.021, 1.428.022
1.428.022
1.428.029R

G10**COIL**

- BOBINA
- BOBINE
- ZÜNDSPULE
- BOBINA

1.970.101D
1.970.168
1.970.352
1.970.374
1.970.413

E01**IGNITION CABLE SET**

- SERIE CAVI COMPLETA
- JEU CABLES D'ALLUMAGE
- ZÜNDKABELSATZ
- JUEGO DE CABLES DE ENCENDIDO

1.499.107
1.501.889
1.501.900

LEXUS**G10****COIL**

- BOBINA
- BOBINE
- ZÜNDSPULE
- BOBINA

1.970.202
1.970.203
1.970.458
1.970.466
1.970.536
1.970.537
1.970.538

LOTUS**A40****DISTRIBUTOR CAP**

- CALOTTA
- TETE D'ALLUMEUR
- VERTEILERKAPPE
- TAPA DEL DISTRIBUIDOR

1.328.075

MAN**A40****DISTRIBUTOR CAP**

- CALOTTA
- TETE D'ALLUMEUR
- VERTEILERKAPPE
- TAPA DEL DISTRIBUIDOR

1.306.081
1.306.081, 1.306.258

G10**COIL**

- BOBINA
- BOBINE
- ZÜNDSPULE
- BOBINA

1.970.417

MARUTI**A20****CONTACT SET**

- COPPIA CONTATTI
- RUPTEUR
- KONTAKTSATZ
- PLATINOS

1.213.011HV

A40**DISTRIBUTOR CAP**

- CALOTTA
- TETE D'ALLUMEUR
- VERTEILERKAPPE
- TAPA DEL DISTRIBUIDOR

A40

1.313.107

A50**ROTOR**

- DISTRIBUTORE
- DISRUPTEUR
- VERTEILERLÄUFER
- ROTOR DEL DISTRIBUIDOR

1.413.030

MASERATI**A50****ROTOR**

- DISTRIBUTORE
- DISRUPTEUR
- VERTEILERLÄUFER
- ROTOR DEL DISTRIBUIDOR

1.430.054R

MAZDA**A20****CONTACT SET**

- COPPIA CONTATTI
- RUPTEUR
- KONTAKTSATZ
- PLATINOS

1.231.084

A40**DISTRIBUTOR CAP**

- CALOTTA
- TETE D'ALLUMEUR
- VERTEILERKAPPE
- TAPA DEL DISTRIBUIDOR

1.322.077

1.322.077, 1.322.092

1.322.088

1.322.092

1.331.003/00

1.331.109

1.331.117

1.331.118

1.331.118, 1.331.132

1.331.121

1.331.121, 1.331.131

1.331.122

1.331.122, 1.331.132

1.331.125

1.331.125, 1.331.132

1.331.131

1.331.132

1.331.137

1.331.149

1.331.150

1.331.154

A50**ROTOR**

- DISTRIBUTORE
- DISRUPTEUR
- VERTEILERLÄUFER
- ROTOR DEL DISTRIBUIDOR

1.422.073
1.422.094
1.422.094, 1.422.102
1.422.102
1.431.023
1.431.108
1.431.108, 1.431.119
1.431.113
1.431.119
1.431.132
1.431.132, 1.431.137
1.431.133
1.431.134
1.431.137

G10**COIL**

- BOBINA
- BOBINE
- ZÜNDSPULE
- BOBINA

1.970.135
1.970.135, 1.970.312
1.970.233
1.970.289
1.970.299
1.970.299, 1.970.312
1.970.366S
1.970.480
1.970.481
1.970.514
1.970.516
1.970.532
1.970.627

G20**IGNITION MODULE**

- MODULO DI ACCENSIONE
- MODULES D'ALLUMAGE
- ZÜNDUNGSMODUL
- MÓDULO DE ENCENDIDO

1.965.073

E01**IGNITION CABLE SET**

- SERIE CAVI COMPLETA
- JEU CABLES D'ALLUMAGE
- ZÜNDKABELSATZ
- JUEGO DE CABLES DE ENCENDIDO

1.499.242
1.499.245
1.500.884
1.501.231
1.501.398
1.501.729
1.501.738
1.501.739
1.501.740
1.501.741



PRODUCTS BY VEHICLE MANUFACTURER

EPS-IGN22Q1

-ELENCO PRODOTTI PER MARCA -PRODUITS PAR FABRICANT VEHICULE -LISTE DER PRODUKTE JE NACH FAHRZEUGMARKE -PRODUCTOS POR FABRICANTE DE VEHÍCULO

E011.501.745
1.501.760
1.501.767**MERCEDES-BENZ****A20****CONTACT SET**
- COPPIA CONTATTI
- RUPTEUR
- KONTAKTSATZ
- PLATINOS1.206.021
1.206.021,
1.206.029HV
1.206.029HV
1.206.029HV,
1.206.062
1.206.034HVS
1.206.062**A40****DISTRIBUTOR CAP**
- CALOTTA
- TETE D'ALLUMEUR
- VERTEILERKAPPE
- TAPA DEL DISTRIBUIDOR1.306.062
1.306.079
1.306.090
1.306.092
1.306.108
1.306.123
1.306.234
1.306.237
1.306.239**A50****ROTOR**
- DISTRIBUTORE
- DISRUPTEUR
- VERTEILERLÄUFER
- ROTOR DEL DISTRIBUIDOR1.406.018R
1.406.021R
1.406.023R
1.406.024R
1.406.025R
1.406.034R
1.406.049R
1.406.055R
1.406.060R
1.406.121R
1.406.125R
1.406.126R
1.406.146R**G10****COIL**
- BOBINA
- BOBINE
- ZÜNDSPULE
- BOBINA1.970.101D
1.970.178
1.970.179
1.970.180
1.970.316
1.970.316K
1.970.317
1.970.417
1.970.417, 1.970.487
1.970.420
1.970.487
1.970.613
1.970.626**E01****IGNITION CABLE SET**
- SERIE CAVI COMPLETA
- JEU CABLES D'ALLUMAGE
- ZÜNDKABELSATZ
- JUEGO DE CABLES DE ENCENDIDO1.499.232
1.499.234
1.501.300
1.501.305
1.501.323
1.501.649
1.501.654
1.501.657**MG****A20****CONTACT SET**
- COPPIA CONTATTI
- RUPTEUR
- KONTAKTSATZ
- PLATINOS

1.228.083MHV

A40**DISTRIBUTOR CAP**
- CALOTTA
- TETE D'ALLUMEUR
- VERTEILERKAPPE
- TAPA DEL DISTRIBUIDOR1.328.075
1.328.093**A50****ROTOR**
- DISTRIBUTORE
- DISRUPTEUR
- VERTEILERLÄUFER
- ROTOR DEL DISTRIBUIDOR1.428.006
1.428.007
1.428.029R**G10****COIL**
- BOBINA
- BOBINE
- ZÜNDSPULE
- BOBINA1.970.374
1.970.413**E01****IGNITION CABLE SET**
- SERIE CAVI COMPLETA
- JEU CABLES D'ALLUMAGE
- ZÜNDKABELSATZ
- JUEGO DE CABLES DE ENCENDIDO1.501.888
1.501.889**MINI****G10****COIL**
- BOBINA
- BOBINE
- ZÜNDSPULE
- BOBINA1.970.475
1.970.632**E01****IGNITION CABLE SET**
- SERIE CAVI COMPLETA
- JEU CABLES D'ALLUMAGE
- ZÜNDKABELSATZ
- JUEGO DE CABLES DE ENCENDIDO

1.501.719

MITSUBISHI**A20****CONTACT SET**
- COPPIA CONTATTI
- RUPTEUR
- KONTAKTSATZ
- PLATINOS

1.231.085

A40**DISTRIBUTOR CAP**
- CALOTTA
- TETE D'ALLUMEUR
- VERTEILERKAPPE
- TAPA DEL DISTRIBUIDOR1.313.117
1.331.003/00
1.331.116
1.331.131
1.331.134
1.331.134, 1.331.158
1.331.135
1.331.138
1.331.138, 1.331.168**A40**1.331.143
1.331.147
1.331.158
1.331.168
1.331.169**A50****ROTOR**
- DISTRIBUTORE
- DISRUPTEUR
- VERTEILERLÄUFER
- ROTOR DEL DISTRIBUIDOR1.413.030
1.431.023
1.431.107
1.431.109
1.431.119
1.431.131
1.431.136
1.431.136, 1.431.137
1.431.137**G10****COIL**
- BOBINA
- BOBINE
- ZÜNDSPULE
- BOBINA1.970.497
1.970.503
1.970.505**E01****IGNITION CABLE SET**
- SERIE CAVI COMPLETA
- JEU CABLES D'ALLUMAGE
- ZÜNDKABELSATZ
- JUEGO DE CABLES DE ENCENDIDO1.499.251
1.501.278
1.501.344
1.501.401
1.501.753
1.501.764
1.501.882
1.501.883**MORRIS****A20****CONTACT SET**
- COPPIA CONTATTI
- RUPTEUR
- KONTAKTSATZ
- PLATINOS

1.228.083MHV

A40**DISTRIBUTOR CAP**
- CALOTTA
- TETE D'ALLUMEUR
- VERTEILERKAPPE
- TAPA DEL DISTRIBUIDOR

1.328.075

A50**ROTOR**
- DISTRIBUTORE
- DISRUPTEUR
- VERTEILERLÄUFER
- ROTOR DEL DISTRIBUIDOR

1.428.006

NISSAN**A10****CONDENSER**
- CONDENSATORE
- CONDENSATEUR
- KONDENSATOR
- CONDENSADOR

1.131.131

A20**CONTACT SET**
- COPPIA CONTATTI
- RUPTEUR
- KONTAKTSATZ
- PLATINOS1.222.056HV
1.231.085**A40****DISTRIBUTOR CAP**
- CALOTTA
- TETE D'ALLUMEUR
- VERTEILERKAPPE
- TAPA DEL DISTRIBUIDOR1.322.003
1.322.040
1.322.046
1.322.057
1.322.063
1.322.073
1.322.079
1.322.089
1.328.101
1.328.102
1.328.103
1.328.104
1.328.1051.322.089
1.328.101
1.328.102
1.328.103
1.328.104
1.328.104, 1.328.105
1.328.105
1.331.003/001.331.114
1.331.120
1.331.126
1.331.136
1.331.151
1.331.152
1.331.155



PRODUCTS BY VEHICLE MANUFACTURER

EPS-IGN22Q1

-ELENCO PRODOTTI PER MARCA -PRODUITS PAR FABRICANT VEHICULE -LISTE DER PRODUKTE JE NACH FAHRZEUGMARKE -PRODUCTOS POR FABRICANTE DE VEHÍCULO

A50

ROTOR
-DISTRIBUTORE
-DISRUPTEUR
-VERTEILERLÄUFER
-ROTOR DEL DISTRIBUIDOR

1.422.052
1.422.066
1.422.070
1.422.070, 1.422.086
1.422.070, 1.422.102
1.422.085
1.422.086
1.422.102
1.428.030
1.431.023
1.431.030
1.431.110
1.431.118
1.431.131
1.431.136

G10

COIL
-BOBINA
-BOBINE
-ZÜNDSPULE
-BOBINA

1.970.296
1.970.419
1.970.432
1.970.489
1.970.518
1.970.533
1.970.551
1.970.552
1.970.557
1.970.596
1.970.602
1.970.613

E01

IGNITION CABLE SET
-SERIE CAVI COMPLETA
-JEU CABLES D'ALLUMAGE
-ZÜNDKABELSATZ
-JUEGO DE CABLES DE ENCENDIDO

1.499.230
1.499.244
1.499.246
1.500.608
1.500.609
1.501.399
1.501.411
1.501.658
1.501.789

NSU**A50**

ROTOR
-DISTRIBUTORE
-DISRUPTEUR
-VERTEILERLÄUFER
-ROTOR DEL DISTRIBUIDOR

1.406.021R

OPEL**A10**

CONDENSER
-CONDENSATORE
-CONDENSATEUR
-KONDENSATOR
-CONDENSADOR

1.106.212

A20

CONTACT SET
-COPPIA CONTATTI
-RUPTEUR
-KONTAKTSATZ
-PLATINOS

1.206.029HV
1.206.034HVS
1.206.049HVS
1.212.055HVS

A40

DISTRIBUTOR CAP
-CALOTTA
-TETE D'ALLUMEUR
-VERTEILERKAPPE
-TAPA DEL DISTRIBUIDOR

1.306.062
1.306.076
1.306.080
1.306.081
1.306.099
1.306.240
1.306.249
1.306.251
1.306.256
1.306.257
1.306.258
1.312.066
1.312.073
1.312.074
1.313.093
1.313.254
1.315.084
1.322.060
1.328.099
1.328.100

A50

ROTOR
-DISTRIBUTORE
-DISRUPTEUR
-VERTEILERLÄUFER
-ROTOR DEL DISTRIBUIDOR

1.406.012R

A50

1.406.026R
1.406.055R
1.406.056R
1.406.061R
1.406.067R
1.406.121R
1.406.127R
1.412.093
1.412.093R
1.412.095R
1.412.096
1.412.097
1.412.100
1.413.030
1.415.103R
1.422.069
1.428.028R

A70

PICK-UP
-IMPULSORE
-CAPTEUR
-IMPULSGEBER
-CAPTADOR

1.912.010
1.912.011
1.928.202

G10

COIL
-BOBINA
-BOBINE
-ZÜNDSPULE
-BOBINA

1.970.109
1.970.111
1.970.140
1.970.191
1.970.192
1.970.194
1.970.219
1.970.272
1.970.273
1.970.341
1.970.389
1.970.398
1.970.399
1.970.400
1.970.432
1.970.442
1.970.450
1.970.475
1.970.507
1.970.508
1.970.545
1.970.547
1.970.609
1.970.620
1.970.631

G20

IGNITION MODULE
-MODULO DI ACCENSIONE
-MODULES D'ALLUMAGE
-ZÜNDUNGSMODUL
-MÓDULO DE ENCENDIDO

1.965.004
1.965.005
1.965.025
1.965.034
1.965.036

E01

IGNITION CABLE SET
-SERIE CAVI COMPLETA
-JEU CABLES D'ALLUMAGE
-ZÜNDKABELSATZ
-JUEGO DE CABLES DE ENCENDIDO

1.499.195
1.499.199
1.500.509
1.500.513
1.500.514
1.500.527
1.500.634
1.500.688
1.500.689
1.500.956
1.501.237
1.501.506
1.501.506, 1.501.562
1.501.529
1.501.531
1.501.559
1.501.562
1.501.904
1.501.942
1.501.947

PEUGEOT**A10**

CONDENSER
-CONDENSATORE
-CONDENSATEUR
-KONDENSATOR
-CONDENSADOR

1.115.023
1.115.034

A20

CONTACT SET
-COPPIA CONTATTI
-RUPTEUR
-KONTAKTSATZ
-PLATINOS

1.206.040
1.206.040,
1.215.111U
1.215.055
1.215.076
1.215.102
1.215.103

A20

1.215.105
1.215.111U
1.230.146M

A40

DISTRIBUTOR CAP
-CALOTTA
-TETE D'ALLUMEUR
-VERTEILERKAPPE
-TAPA DEL DISTRIBUIDOR

1.306.079
1.306.124
1.306.241
1.306.252
1.315.049
1.315.054
1.315.058
1.315.059
1.315.067
1.315.074
1.315.077
1.315.078
1.315.079
1.330.098
1.330.101

A50

ROTOR
-DISTRIBUTORE
-DISRUPTEUR
-VERTEILERLÄUFER
-ROTOR DEL DISTRIBUIDOR

1.406.014R
1.406.025R
1.406.026R
1.406.049R
1.406.055R
1.406.056R
1.406.061R
1.406.119R
1.415.088
1.415.091
1.415.094
1.415.102R
1.415.104
1.430.047R
1.430.060

A70

PICK-UP
-IMPULSORE
-CAPTEUR
-IMPULSGEBER
-CAPTADOR

1.906.153
1.906.159
1.915.017
1.915.019
1.930.178M



PRODUCTS BY VEHICLE MANUFACTURER

EPS-IGN22Q1

-ELENCO PRODOTTI PER MARCA -PRODUITS PAR FABRICANT VEHICULE -LISTE DER PRODUKTE JE NACH FAHRZEUGMARKE -PRODUCTOS POR FABRICANTE DE VEHÍCULO

G10**COIL**

- BOBINA
- BOBINE
- ZÜNDSPULE
- BOBINA

1.970.101D**1.970.105****1.970.105, 1.970.155****1.970.106****1.970.155****1.970.168****1.970.188****1.970.189****1.970.403****1.970.405****1.970.407****1.970.408****1.970.459****1.970.461****1.970.475****1.970.476****1.970.483****1.970.497****1.970.505****1.970.509****1.970.609****1.970.620****G20****IGNITION MODULE**

- MODULO DI ACCENSIONE
- MODULES D'ALLUMAGE
- ZÜNDUNGSMODUL
- MÓDULO DE ENCENDIDO

1.965.005**1.965.034****E01****IGNITION CABLE SET**

- SERIE CAVI COMPLETA
- JEU CABLES D'ALLUMAGE
- ZÜNDKABELSATZ
- JUEGO DE CABLES DE ENCENDIDO

1.500.491**1.500.494****1.500.655****1.500.674****1.500.747****1.500.748****1.500.780****1.500.846****1.501.025****1.501.374****PIAGGIO****A50****ROTOR**

- DISTRIBUTORE
- DISRUPTEUR
- VERTEILERLÄUFER
- ROTOR DEL DISTRIBUIDOR

A50**1.413.030****PORSCHE****A20****CONTACT SET**

- COPPIA CONTATTI
- RUPTEUR
- KONTAKTSATZ
- PLATINOS

1.206.047**1.206.062****A40****DISTRIBUTOR CAP**

- CALOTTA
- TETE D'ALLUMEUR
- VERTEILERKAPPE
- TAPA DEL DISTRIBUIDOR

1.306.072**1.306.076****1.306.079****1.306.090****1.306.117****1.306.123****1.306.128****A50****ROTOR**

- DISTRIBUTORE
- DISRUPTEUR
- VERTEILERLÄUFER
- ROTOR DEL DISTRIBUIDOR

1.406.018R,**1.406.021R****1.406.021R****1.406.025R****1.406.070R****1.406.113R****G10****COIL**

- BOBINA
- BOBINE
- ZÜNDSPULE
- BOBINA

1.970.427**1.970.434****1.970.636****G20****IGNITION MODULE**

- MODULO DI ACCENSIONE
- MODULES D'ALLUMAGE
- ZÜNDUNGSMODUL
- MÓDULO DE ENCENDIDO

1.965.034**PUCH****A20****CONTACT SET**

- COPPIA CONTATTI
- RUPTEUR
- KONTAKTSATZ
- PLATINOS

1.206.034HVS**A40****DISTRIBUTOR CAP**

- CALOTTA
- TETE D'ALLUMEUR
- VERTEILERKAPPE
- TAPA DEL DISTRIBUIDOR

1.306.092**1.306.108****1.306.123****1.306.234****1.306.237****A50****ROTOR**

- DISTRIBUTORE
- DISRUPTEUR
- VERTEILERLÄUFER
- ROTOR DEL DISTRIBUIDOR

1.406.024R**1.406.034R****1.406.055R****1.406.060R****1.406.121R****1.406.125R****G10****COIL**

- BOBINA
- BOBINE
- ZÜNDSPULE
- BOBINA

1.970.178**1.970.180****1.970.316****1.970.316K****1.970.417****E01****IGNITION CABLE SET**

- SERIE CAVI COMPLETA
- JEU CABLES D'ALLUMAGE
- ZÜNDKABELSATZ
- JUEGO DE CABLES DE ENCENDIDO

1.501.654**1.501.657****RELIANT****A40****DISTRIBUTOR CAP**

- CALOTTA
- TETE D'ALLUMEUR
- VERTEILERKAPPE
- TAPA DEL DISTRIBUIDOR

1.328.075**A50****ROTOR**

- DISTRIBUTORE
- DISRUPTEUR
- VERTEILERLÄUFER
- ROTOR DEL DISTRIBUIDOR

1.428.006**RENAULT****A10****CONDENSER**

- CONDENSATORE
- CONDENSATEUR
- KONDENSATOR
- CONDENSADOR

1.115.023**1.115.034****1.117.097****1.142.056****A20****CONTACT SET**

- COPPIA CONTATTI
- RUPTEUR
- KONTAKTSATZ
- PLATINOS

1.206.040**1.215.055****1.215.061****1.215.086****1.215.126****1.217.024****1.217.026****1.230.148M****1.242.054****A40****DISTRIBUTOR CAP**

- CALOTTA
- TETE D'ALLUMEUR
- VERTEILERKAPPE
- TAPA DEL DISTRIBUIDOR

1.306.094**1.306.236****1.306.260****1.315.041****1.315.054****1.315.059****1.315.062****1.315.063****1.315.065****1.315.066****1.315.069****1.315.070****1.315.072****1.315.073****1.315.079****1.315.081****1.315.082****1.315.083****1.315.085****1.315.086****A40****1.315.088****1.315.091****1.317.023****1.330.098****1.330.101****1.330.111****1.342.043****A50****ROTOR**

- DISTRIBUTORE
- DISRUPTEUR
- VERTEILERLÄUFER
- ROTOR DEL DISTRIBUIDOR

1.406.012R**1.406.014R****1.406.023R****1.406.119R****1.406.147R****1.415.081****1.415.088****1.415.091****1.415.094****1.415.097****1.415.101****1.417.058****1.430.047R****1.430.059****G10****COIL**

- BOBINA
- BOBINE
- ZÜNDSPULE
- BOBINA

1.970.101D**1.970.107****1.970.196****1.970.228****1.970.275****1.970.276****1.970.355****1.970.356****1.970.365****1.970.376****1.970.378****1.970.419****1.970.432****1.970.489****1.970.518****1.970.533****1.970.551****1.970.552****1.970.596****1.970.613****G30****ELECTRONIC IGNITION KIT**

- KIT ACCENSIONE ELETTRONICA
- KIT POUR ALLUMAGE ELECTRONIQUE
- ELEKTRONISCHE ZÜNDUNGSSATZ
- JUEGO DE ENCENDIDO ELECTRONICO

1.990.423



PRODUCTS BY VEHICLE MANUFACTURER

EPS-IGN22Q1

-ELENCO PRODOTTI PER MARCA -PRODUITS PAR FABRICANT VEHICULE -LISTE DER PRODUKTE JE NACH FAHRZEUGMARKE -PRODUCTOS POR FABRICANTE DE VEHÍCULO

E01

IGNITION CABLE SET
- SERIE CAVI COMPLETA
- JEU CABLES D'ALLUMAGE
- ZÜNDKABELSATZ
- JUEGO DE CABLES DE ENCENDIDO

1.499.049

1.499.061

1.499.064

1.499.229

1.499.230

1.499.244

1.499.246

1.499.252

1.500.415

1.500.539

1.500.543

1.500.801

1.500.802

1.500.839

1.500.920

1.501.332

1.501.443

1.501.446

1.501.447

1.501.492

1.501.497

1.501.499

1.501.501

1.501.681

RILEY

A40

DISTRIBUTOR CAP
- CALOTTA
- TETE D'ALLUMEUR
- VERTEILERKAPPE
- TAPA DEL DISTRIBUIDOR

1.328.075

A50

ROTOR
- DISTRIBUTORE
- DISRUPTEUR
- VERTEILERLÄUFER
- ROTOR DEL DISTRIBUIDOR

1.428.006

ROLLS-ROYCE

G10

COIL
- BOBINA
- BOBINE
- ZÜNDSPULE
- BOBINA

1.970.475

ROVER

A20

CONTACT SET
- COPPIA CONTATTI
- RUPTEUR
- KONTAKTSATZ
- PLATINOS

1.228.083MHV

A40

DISTRIBUTOR CAP
- CALOTTA
- TETE D'ALLUMEUR
- VERTEILERKAPPE
- TAPA DEL DISTRIBUIDOR

1.322.022

1.322.068

1.322.069

1.322.082

1.328.075

1.328.093

1.328.094

1.328.106

A50

ROTOR
- DISTRIBUTORE
- DISRUPTEUR
- VERTEILERLÄUFER
- ROTOR DEL DISTRIBUIDOR

1.422.056

1.422.082

1.422.095

1.422.098

1.422.102

1.428.006

1.428.024R

1.428.025

1.428.026R

1.428.029R

G10

COIL
- BOBINA
- BOBINE
- ZÜNDSPULE
- BOBINA

1.970.189

1.970.211

1.970.213

1.970.214

1.970.347

1.970.374

1.970.413

G20

IGNITION MODULE
- MODULO DI ACCENSIONE
- MODULES D'ALLUMAGE
- ZÜNDUNGSMODUL
- MÓDULO DE ENCENDIDO

1.965.052

E01

IGNITION CABLE SET
- SERIE CAVI COMPLETA
- JEU CABLES D'ALLUMAGE
- ZÜNDKABELSATZ
- JUEGO DE CABLES DE ENCENDIDO

1.501.711

1.501.888

1.501.889

1.501.914

SAAB

A40

DISTRIBUTOR CAP
- CALOTTA
- TETE D'ALLUMEUR
- VERTEILERKAPPE
- TAPA DEL DISTRIBUIDOR

1.306.079

1.306.124

A50

ROTOR
- DISTRIBUTORE
- DISRUPTEUR
- VERTEILERLÄUFER
- ROTOR DEL DISTRIBUIDOR

1.406.021R

1.406.026R

1.406.055R

1.406.121R

1.406.123R

A70

PICK-UP
- IMPULSORE
- CAPTEUR
- IMPULSgeber
- CAPTADOR

1.906.193

1.906.244

G10

COIL
- BOBINA
- BOBINE
- ZÜNDSPULE
- BOBINA

1.970.192

1.970.450

1.970.508

G20

IGNITION MODULE
- MODULO DI ACCENSIONE
- MODULES D'ALLUMAGE
- ZÜNDUNGSMODUL
- MÓDULO DE ENCENDIDO

1.965.004

1.965.007

1.965.034

E01

IGNITION CABLE SET
- SERIE CAVI COMPLETA
- JEU CABLES D'ALLUMAGE
- ZÜNDKABELSATZ
- JUEGO DE CABLES DE ENCENDIDO

1.501.138

1.501.140

SEAT

A10

CONDENSER
- CONDENSATORE
- CONDENSATEUR
- KONDENSATOR
- CONDENSADOR

1.115.039

1.130.117

1.130.128

A20

CONTACT SET
- COPPIA CONTATTI
- RUPTEUR
- KONTAKTSATZ
- PLATINOS

1.217.020

1.230.132

1.230.142

1.230.146M

A40

DISTRIBUTOR CAP
- CALOTTA
- TETE D'ALLUMEUR
- VERTEILERKAPPE
- TAPA DEL DISTRIBUIDOR

1.306.079

1.306.094

1.306.263

1.306.266

1.315.058

1.315.068

1.317.014

1.317.016

1.317.016, 1.317.029

1.330.076

1.330.098

1.330.101

1.330.116

A50

ROTOR
- DISTRIBUTORE
- DISRUPTEUR
- VERTEILERLÄUFER
- ROTOR DEL DISTRIBUIDOR

1.406.055R

1.406.056R

1.406.121R

1.415.083R

1.415.091

A50

1.415.099R

1.417.052

1.417.052R

1.430.037

1.430.042R

1.430.047R

1.430.054R

1.430.057R

A70

PICK-UP
- IMPULSORE
- CAPTEUR
- IMPULSgeber
- CAPTADOR

1.906.159

1.906.193

1.906.223

1.906.233

1.906.234

1.930.182

G10

COIL
- BOBINA
- BOBINE
- ZÜNDSPULE
- BOBINA

1.970.101D

1.970.125

1.970.159

1.970.196

1.970.354S

1.970.426

1.970.429

1.970.431

1.970.434

1.970.435

1.970.445

1.970.474

1.970.599

1.970.636

G20

IGNITION MODULE
- MODULO DI ACCENSIONE
- MODULES D'ALLUMAGE
- ZÜNDUNGSMODUL
- MÓDULO DE ENCENDIDO

1.965.007

1.965.074

1.965.076

G30

ELECTRONIC IGNITION KIT
- KIT ACCENSIONE ELETTRONICA
- KIT POUR ALLUMAGE ELECTRONIQUE
- ELEKTRONISCHE ZÜNDUNGSSATZ
- JUEGO DE ENCENDIDO ELECTRONICO

1.990.414

1.990.416

1.990.420



PRODUCTS BY VEHICLE MANUFACTURER

EPS-IGN22Q1

-ELENCO PRODOTTI PER MARCA -PRODUITS PAR FABRICANT VEHICULE -LISTE DER PRODUKTE JE NACH FAHRZEUGMARKE -PRODUCTOS POR FABRICANTE DE VEHÍCULO

E01

IGNITION CABLE SET
 - SERIE CAVI COMPLETA
 - JEU CABLES D'ALLUMAGE
 - ZÜNDKABELSATZ
 - JUEGO DE CABLES DE ENCENDIDO

1.499.248

1.500.612

1.500.725

1.500.736

1.500.965

1.501.364

1.501.484

1.501.489

1.501.549

1.501.569

1.501.575

1.501.585

1.501.595

1.501.601

1.501.640

1.501.641

1.501.660

1.501.667

1.501.723

1.501.932

1.501.937

SKODA**A20**

CONTACT SET
 - COPPIA CONTATTI
 - RUPTEUR
 - KONTAKTSATZ
 - PLATINOS

1.236.045

A40

DISTRIBUTOR CAP
 - CALOTTA
 - TETE D'ALLUMEUR
 - VERTEILERKAPPE
 - TAPA DEL DISTRIBUIDOR

1.306.094

1.330.116

1.338.242

1.338.243

A50

ROTOR
 - DISTRIBUTORE
 - DISRUPTEUR
 - VERTEILERLÄUFER
 - ROTOR DEL DISTRIBUIDOR

1.406.121R

1.430.057R

1.438.262R

1.438.262R,

1.438.263R

1.438.263R

A70

PICK-UP
 - IMPULSORE
 - CAPTEUR
 - IMPULSGEBER
 - CAPTADOR

1.906.223

G10

COIL
 - BOBINA
 - BOBINE
 - ZÜNDSPULE
 - BOBINA

1.970.3545

1.970.426

1.970.429

1.970.431

1.970.445

1.970.474

1.970.599

1.970.636

G20

IGNITION MODULE
 - MODULO DI ACCENSIONE
 - MODULES D'ALLUMAGE
 - ZÜNDUNGSMODUL
 - MÓDULO DE ENCENDIDO

1.965.076

G30

ELECTRONIC IGNITION KIT
 - KIT ACCENSIONE ELETTRONICA
 - KIT POUR ALLUMAGE ELECTRONIQUE
 - ELEKTRONISCHE ZÜNDUNGSSATZ
 - JUEGO DE ENCENDIDO ELECTRONICO

1.990.414

1.990.420

E01

IGNITION CABLE SET
 - SERIE CAVI COMPLETA
 - JEU CABLES D'ALLUMAGE
 - ZÜNDKABELSATZ
 - JUEGO DE CABLES DE ENCENDIDO

1.499.223

1.499.248

1.501.373

1.501.479

1.501.484

1.501.489

1.501.569

1.501.575

1.501.585

1.501.609

SMART**G10**

COIL
 - BOBINA
 - BOBINE
 - ZÜNDSPULE
 - BOBINA

1.970.414

1.970.503

1.970.613

E01

IGNITION CABLE SET
 - SERIE CAVI COMPLETA
 - JEU CABLES D'ALLUMAGE
 - ZÜNDKABELSATZ
 - JUEGO DE CABLES DE ENCENDIDO

1.501.643

SSANGYONG**G10**

COIL
 - BOBINA
 - BOBINE
 - ZÜNDSPULE
 - BOBINA

1.970.316

SUBARU**A40**

DISTRIBUTOR CAP
 - CALOTTA
 - TETE D'ALLUMEUR
 - VERTEILERKAPPE
 - TAPA DEL DISTRIBUIDOR

1.313.123

1.313.259

1.322.041

1.322.046

1.322.048

1.322.075

1.331.145

A50

ROTOR
 - DISTRIBUTORE
 - DISRUPTEUR
 - VERTEILERLÄUFER
 - ROTOR DEL DISTRIBUIDOR

1.413.014

1.413.028

1.413.029

1.422.073

1.422.093

1.431.119

G10

COIL
 - BOBINA
 - BOBINE
 - ZÜNDSPULE
 - BOBINA

1.970.265

1.970.266

1.970.537

1.970.570

E01

IGNITION CABLE SET
 - SERIE CAVI COMPLETA
 - JEU CABLES D'ALLUMAGE
 - ZÜNDKABELSATZ
 - JUEGO DE CABLES DE ENCENDIDO

1.499.100

1.499.106

1.501.813

1.501.817

1.501.819

1.501.835

1.501.887

SUZUKI**A20**

CONTACT SET
 - COPPIA CONTATTI
 - RUPTEUR
 - KONTAKTSATZ
 - PLATINOS

1.213.011HV

A40

DISTRIBUTOR CAP
 - CALOTTA
 - TETE D'ALLUMEUR
 - VERTEILERKAPPE
 - TAPA DEL DISTRIBUIDOR

1.313.093

1.313.107

1.313.123

1.313.245

1.313.256

1.322.046

1.331.132

1.331.140

1.331.144

A50

ROTOR
 - DISTRIBUTORE
 - DISRUPTEUR
 - VERTEILERLÄUFER
 - ROTOR DEL DISTRIBUIDOR

1.413.014

1.413.028

1.413.030

1.413.034

1.413.036

1.422.073

A50

1.431.108

1.431.131

1.431.136

G10

COIL
 - BOBINA
 - BOBINE
 - ZÜNDSPULE
 - BOBINA

1.970.201

1.970.535

1.970.570

1.970.591

1.970.621

E01

IGNITION CABLE SET
 - SERIE CAVI COMPLETA
 - JEU CABLES D'ALLUMAGE
 - ZÜNDKABELSATZ
 - JUEGO DE CABLES DE ENCENDIDO

1.499.004

1.499.005

1.499.013

1.499.020

1.499.028

1.499.231

1.501.413

1.501.415, 1.501.417

1.501.434

TALBOT**A10**

CONDENSER
 - CONDENSATORE
 - CONDENSATEUR
 - KONDENSATOR
 - CONDENSADOR

1.115.034

A20

CONTACT SET
 - COPPIA CONTATTI
 - RUPTEUR
 - KONTAKTSATZ
 - PLATINOS

1.215.103

1.215.111U

A40

DISTRIBUTOR CAP
 - CALOTTA
 - TETE D'ALLUMEUR
 - VERTEILERKAPPE
 - TAPA DEL DISTRIBUIDOR

1.306.079

1.315.054

1.315.058

1.328.075



PRODUCTS BY VEHICLE MANUFACTURER

EPS-IGN22Q1

-ELENCO PRODOTTI PER MARCA -PRODUITS PAR FABRICANT VEHICULE -LISTE DER PRODUKTE JE NACH FAHRZEUGMARKE -PRODUCTOS POR FABRICANTE DE VEHÍCULO

A50**ROTOR**
-DISTRIBUTORE
-DISRUPTEUR
-VERTEILERLÄUFER
-ROTOR DEL DISTRIBUIDOR**1.406.025R**
1.406.049R
1.406.061R
1.412.090, 1.428.006
1.415.088
1.415.091
1.415.094**A70****PICK-UP**
-IMPULSORE
-CAPTEUR
-IMPULSGEBER
-CAPTADOR**1.906.153****G10****COIL**
-BOBINA
-BOBINE
-ZÜNDSPULE
-BOBINA**1.970.101D****TOYOTA****A40****DISTRIBUTOR CAP**
-CALOTTA
-TETE D'ALLUMEUR
-VERTEILERKAPPE
-TAPA DEL DISTRIBUIDOR**1.306.094**
1.313.099
1.313.113
1.313.113, 1.313.114
1.313.114
1.313.119
1.313.122
1.313.122, 1.313.278
1.313.240
1.313.248
1.313.251
1.313.252
1.313.262
1.313.265
1.313.267
1.313.272
1.313.273
1.313.275
1.313.278**A50****ROTOR**
-DISTRIBUTORE
-DISRUPTEUR
-VERTEILERLÄUFER
-ROTOR DEL DISTRIBUIDOR**1.406.014R**
1.406.121R
1.413.014
1.413.027
1.413.029
1.413.029, 1.413.036
1.413.030
1.413.036**G10****COIL**
-BOBINA
-BOBINE
-ZÜNDSPULE
-BOBINA**1.970.197**
1.970.198
1.970.198, 1.970.199
1.970.198, 1.970.2855
1.970.199
1.970.199, 1.970.2855
1.970.202
1.970.203
1.970.2855
1.970.322
1.970.458
1.970.458, 1.970.466
1.970.459
1.970.461
1.970.466
1.970.536
1.970.537
1.970.538
1.970.609
1.970.632
1.970.645**E01****IGNITION CABLE SET**
-SERIE CAVI COMPLETA
-JEU CABLES D'ALLUMAGE
-ZÜNDKABELSATZ
-JUEGO DE CABLES DE ENCENDIDO**1.501.209**
1.501.209, 1.501.879
1.501.393
1.501.435
1.501.792
1.501.793
1.501.823
1.501.856
1.501.879
1.501.880**TRIUMPH****A20****CONTACT SET**
-COPPIA CONTATTI
-RUPTEUR
-KONTAKTSATZ
-PLATINOS**1.228.083MHV****A40****DISTRIBUTOR CAP**
-CALOTTA
-TETE D'ALLUMEUR
-VERTEILERKAPPE
-TAPA DEL DISTRIBUIDOR**1.328.075****A50****ROTOR**
-DISTRIBUTORE
-DISRUPTEUR
-VERTEILERLÄUFER
-ROTOR DEL DISTRIBUIDOR**1.412.090**
1.412.090, 1.428.007
1.428.006
1.428.007**TVR****A50****ROTOR**
-DISTRIBUTORE
-DISRUPTEUR
-VERTEILERLÄUFER
-ROTOR DEL DISTRIBUIDOR**1.428.006**
1.428.007**VAUXHALL****A40****DISTRIBUTOR CAP**
-CALOTTA
-TETE D'ALLUMEUR
-VERTEILERKAPPE
-TAPA DEL DISTRIBUIDOR**1.306.240**
1.306.249
1.306.251
1.306.256
1.306.257
1.312.073
1.315.084
1.328.100**A50****ROTOR**
-DISTRIBUTORE
-DISRUPTEUR
-VERTEILERLÄUFER
-ROTOR DEL DISTRIBUIDOR**1.406.056R****A50****1.406.121R**
1.406.127R
1.412.090
1.412.100
1.415.103R
1.428.028R**A70****PICK-UP**
-IMPULSORE
-CAPTEUR
-IMPULSGEBER
-CAPTADOR**1.912.010**
1.928.202**G10****COIL**
-BOBINA
-BOBINE
-ZÜNDSPULE
-BOBINA**1.970.140**
1.970.191
1.970.192
1.970.194
1.970.272
1.970.273
1.970.341
1.970.389
1.970.398
1.970.399
1.970.400
1.970.432
1.970.442
1.970.450
1.970.475
1.970.507
1.970.508
1.970.545
1.970.547
1.970.609
1.970.620
1.970.631**G20****IGNITION MODULE**
-MODULO DI ACCENSIONE
-MODULES D'ALLUMAGE
-ZÜNDUNGSMODUL
-MÓDULO DE ENCENDIDO**1.965.005**
1.965.025
1.965.036**E01****IGNITION CABLE SET**
-SERIE CAVI COMPLETA
-JEU CABLES D'ALLUMAGE
-ZÜNDKABELSATZ
-JUEGO DE CABLES DE ENCENDIDO**1.499.195**
1.499.199**E01****1.500.514**
1.500.527
1.500.634
1.500.688
1.500.689
1.501.237
1.501.506
1.501.506, 1.501.562
1.501.529
1.501.531
1.501.559
1.501.562
1.501.904
1.501.947**VOLKSWAGEN (BR)****A40****DISTRIBUTOR CAP**
-CALOTTA
-TETE D'ALLUMEUR
-VERTEILERKAPPE
-TAPA DEL DISTRIBUIDOR**1.306.094****A50****ROTOR**
-DISTRIBUTORE
-DISRUPTEUR
-VERTEILERLÄUFER
-ROTOR DEL DISTRIBUIDOR**1.406.055R**
1.406.121R**A70****PICK-UP**
-IMPULSORE
-CAPTEUR
-IMPULSGEBER
-CAPTADOR**1.906.160**
1.906.233**G10****COIL**
-BOBINA
-BOBINE
-ZÜNDSPULE
-BOBINA**1.970.168**
1.970.354
1.970.354S
1.970.474**G30****ELECTRONIC IGNITION KIT**
-KIT ACCENSIONE ELETTRONICA
-KIT POUR ALLUMAGE ELECTRONIQUE
-ELEKTRONISCHE ZÜNDUNGSSATZ
-JUEGO DE ENCENDIDO ELECTRONICO**1.990.414**



PRODUCTS BY VEHICLE MANUFACTURER

EPS-IGN22Q1

-ELENCO PRODOTTI PER MARCA -PRODUITS PAR FABRICANT VEHICULE -LISTE DER PRODUKTE JE NACH FAHRZEUGMARKE -PRODUCTOS POR FABRICANTE DE VEHÍCULO

G30**1.990.420****E01****IGNITION CABLE SET**

- SERIE CAVI COMPLETA
- JEU CABLES D'ALLUMAGE
- ZÜNDKABELSATZ
- JUEGO DE CABLES DE ENCENDIDO

1.501.484**1.501.585****1.501.723****VOLVO****A20****CONTACT SET**

- COPPIA CONTATTI
- RUPTEUR
- KONTAKTSATZ
- PLATINOS

1.206.021**1.206.021, 1.206.047****1.206.034HVS****1.206.047****1.206.049HVS****A40****DISTRIBUTOR CAP**

- CALOTTA
- TETE D'ALLUMEUR
- VERTEILERKAPPE
- TAPA DEL DISTRIBUIDOR

1.306.062**1.306.076****1.306.079****1.306.127****1.306.236****1.306.260****1.315.059****1.315.062****1.315.063****1.315.069****1.315.071****A50****ROTOR**

- DISTRIBUTORE
- DISRUPTEUR
- VERTEILERLÄUFER
- ROTOR DEL DISTRIBUIDOR

1.406.023R**1.406.025R****1.406.055R****1.406.067R****1.406.118R****1.406.119R****1.406.121R****1.406.122R****1.406.147R****1.412.093R****1.415.096R****A50****1.415.097****A70****PICK-UP**

- IMPULSORE
- CAPTEUR
- IMPULSGEBER
- CAPTADOR

1.906.153**1.906.222****G10****COIL**

- BOBINA
- BOBINE
- ZÜNDSPULE
- BOBINA

1.970.107**1.970.355****1.970.356****1.970.448****1.970.478****1.970.480****1.970.481****1.970.532****G30****ELECTRONIC IGNITION KIT**

- KIT ACCENSIONE ELETTRONICA
- KIT POUR ALLUMAGE ELECTRONIQUE
- ELEKTRONISCHE ZÜNDUNGSSATZ
- JUEGO DE ENCENDIDO ELECTRONICO

1.990.423**E01****IGNITION CABLE SET**

- SERIE CAVI COMPLETA
- JEU CABLES D'ALLUMAGE
- ZÜNDKABELSATZ
- JUEGO DE CABLES DE ENCENDIDO

1.499.059**1.499.061****1.499.064****1.499.242****1.500.372****1.500.415****1.500.417****1.501.332****VW****A10****CONDENSER**

- CONDENSATORE
- CONDENSATEUR
- KONDENSATOR
- CONDENSADOR

1.106.195**1.106.195, 1.106.196****1.106.196****A20****CONTACT SET**

- COPPIA CONTATTI
- RUPTEUR
- KONTAKTSATZ
- PLATINOS

1.206.032HV**1.206.032HV,****1.206.040****1.206.034HVS****1.206.040****1.206.049HVS****1.213.011HV****A40****DISTRIBUTOR CAP**

- CALOTTA
- TETE D'ALLUMEUR
- VERTEILERKAPPE
- TAPA DEL DISTRIBUIDOR

1.306.062**1.306.079****1.306.093****1.306.094****1.306.231****1.306.233****1.306.263****1.306.266****1.313.099****1.313.113****1.313.114****1.313.273****1.315.068****1.330.116****A50****ROTOR**

- DISTRIBUTORE
- DISRUPTEUR
- VERTEILERLÄUFER
- ROTOR DEL DISTRIBUIDOR

1.406.014R**1.406.014R,****1.406.021R****1.406.018R****1.406.021R****1.406.025R****1.406.026R****1.406.027R****1.406.055R****1.406.055R,****1.406.116R****1.406.056R****1.406.059R****1.406.067R****1.406.114R****1.406.116R****1.406.117R****1.406.121R****1.406.148R****1.406.149R****1.413.014****1.413.027****1.415.089R****1.415.099R****1.430.057R****A70****PICK-UP**

- IMPULSORE
- CAPTEUR
- IMPULSGEBER
- CAPTADOR

1.906.159**1.906.193****1.906.219****1.906.223****1.906.231****1.906.233****1.906.234****1.930.182****G10****COIL**

- BOBINA
- BOBINE
- ZÜNDSPULE
- BOBINA

1.970.125**1.970.125, 1.970.126****1.970.126****1.970.132****1.970.159****1.970.203****1.970.269****1.970.316****1.970.354****1.970.354S****1.970.425****1.970.426****1.970.427****1.970.429****1.970.431****1.970.434****1.970.435****1.970.437****1.970.445****1.970.474****1.970.599****1.970.636****G20****IGNITION MODULE**

- MODULO DI ACCENSIONE
- MODULES D'ALLUMAGE
- ZÜNDUNGSMÖDUL
- MÓDULO DE ENCENDIDO

1.965.004**1.965.007****1.965.072****1.965.074****1.965.076****G30****ELECTRONIC IGNITION KIT**

- KIT ACCENSIONE ELETTRONICA
- KIT POUR ALLUMAGE ELECTRONIQUE
- ELEKTRONISCHE ZÜNDUNGSSATZ
- JUEGO DE ENCENDIDO ELECTRONICO

1.990.414**1.990.416****1.990.420****E01****IGNITION CABLE SET**

- SERIE CAVI COMPLETA
- JEU CABLES D'ALLUMAGE
- ZÜNDKABELSATZ
- JUEGO DE CABLES DE ENCENDIDO

1.499.159**1.499.223****1.499.248****1.500.493****1.500.725****1.500.727****1.500.736****1.500.737****1.500.965****1.501.353****1.501.364****1.501.479****1.501.484****1.501.489****1.501.491****1.501.518****1.501.549****1.501.551****1.501.575****1.501.580****1.501.585****1.501.595****1.501.601****1.501.609****1.501.640****1.501.641****1.501.641****1.501.660****1.501.667****1.501.671****1.501.723****1.501.932****1.501.933****1.501.937****WOLSELEY****A20****CONTACT SET**

- COPPIA CONTATTI
- RUPTEUR
- KONTAKTSATZ
- PLATINOS

1.228.083MHV**A40****DISTRIBUTOR CAP**

- CALOTTA
- TETE D'ALLUMEUR
- VERTEILERKAPPE
- TAPA DEL DISTRIBUIDOR

1.328.075



PRODUCTS BY VEHICLE MANUFACTURER

EPS-IGN22Q1

-ELENCO PRODOTTI PER MARCA -PRODUITS PAR FABRICANT VEHICULE -LISTE DER PRODUKTE JE NACH FAHRZEUGMARKE -PRODUCTOS POR FABRICANTE DE VEHÍCULO

A50

ROTOR

- DISTRIBUTORE
- DISRUPTEUR
- VERTEILERLÄUFER
- ROTOR DEL DISTRIBUIDOR

1.428.006

1.428.007

YUGO

A20

CONTACT SET

- COPPIA CONTATTI
- RUPTEUR
- KONTAKTSATZ
- PLATINOS

1.206.029HV

ZASTAVA

A20

CONTACT SET

- COPPIA CONTATTI
- RUPTEUR
- KONTAKTSATZ
- PLATINOS

1.207.701

1.230.140

A40

DISTRIBUTOR CAP

- CALOTTA
- TETE D'ALLUMEUR
- VERTEILERKAPPE
- TAPA DEL DISTRIBUIDOR

1.307.701

1.330.081

A50

ROTOR

- DISTRIBUTORE
- DISRUPTEUR
- VERTEILERLÄUFER
- ROTOR DEL DISTRIBUIDOR

1.407.701R

1.430.036R

G10

COIL

- BOBINA
- BOBINE
- ZÜNDSPULE
- BOBINA

1.970.101D



APPLICATION LIST GLOSSARY

EPS-IGN22Q1

·GLOSSARIO GUIDA APPLICAZIONI ·GLOSSAIRE LISTE D'APPLICATIONS ·GLOSSAR DER VERWENDUNGSLISTE ·GLOSARIO LISTA APLICACIONES

#	ENGLISH 	ITALIANO 	FRANÇAIS 	DEUTSCH 	ESPAÑOL
->ch.: xxx	Vehicle Identification Number to: xxx	N° telaio fino a: xxx	N° de châssis jusqu'à: xxx	Fahrgestellnummer bis: xxx	n° de chasis hasta: xxx
->eng.: xxx	Engine Number to: xxx	N° motore fino a: xxx	N° de moteur à: xxx	Motornummer bis: xxx	n° de motor hasta: xxx
->prod. nr.: xxx	Production number to: xxx	N° produzione fino a: xxx	N° de production jusqu'à: xxx	Produktionsnummer bis: xxx	n° de producción hasta: xxx
->VET.: xxx	VET Number to: xxx	N° VET fino a: xxx	Numéro VET jusqu'à: xxx	VET-Nummer bis: xxx	n° VET hasta: xxx
->year: xxx	Construction year to: xxx	Anno fino a: xxx	Année jusqu'à: xxx	Baujahr bis: xxx	año construcción hasta: xxx
3 Speed	Number of Gears: 3 Speed	N° marce: 3 marce	Nombre de vitesses: 3 vitesses	Ganganzahl: 3-Gang	Número de marchas: 3 velocidades
4 Speed	Number of Gears: 4 Speed	N° marce: 4 marce	Nombre de vitesses: 4 vitesses	Ganganzahl: 4-Gang	Número de marchas: 4 velocidades
5 Speed	Number of Gears: 5 Speed	N° marce: 5 marce	Nombre de vitesses: 5 vitesses	Ganganzahl: 5-Gang	Número de marchas: 5 velocidades
6 Speed	Number of Gears: 6 Speed	N° marce: 6 marce	Nombre de vitesses: 6 vitesses	Ganganzahl: 6-Gang	Número de marchas: 6 velocidades
96 EEC	Emission Standard: 96 EEC	Norma sui gas di scarico: 96 EEC	Norme concernant les gaz d'échappement: 96 EEC	Abgasnorm: 96 EEC	Norma de emisiones: 96 EEC
Black	Housing Colour: xxx	Colore alloggiamento: xxx	Couleur du carter: xxx	Gehäusefarbe: xxx	Color de carcasa: xxx
Blue	Housing Colour: xxx	Colore alloggiamento: xxx	Couleur du carter: xxx	Gehäusefarbe: xxx	Color de carcasa: xxx
Brown	Housing Colour: xxx	Colore alloggiamento: xxx	Couleur du carter: xxx	Gehäusefarbe: xxx	Color de carcasa: xxx
ch.: xxx	Vehicle Identification Number: xxx	N° telaio: xxx	N° de châssis: xxx	Fahrgestellnummer: xxx	N° de chasis: xxx
ch.: xxx->	Vehicle Identification Number from: xxx	N° telaio da: xxx	N° de châssis à partir de: xxx	Fahrgestellnummer ab: xxx	n° de chasis desde: xxx
Chrome / Black	Housing Colour: xxx	Colore alloggiamento: xxx	Couleur du carter: xxx	Gehäusefarbe: xxx	Color de carcasa: xxx
COL: xxx	Colour: xxx	Colore: xxx	Couleur: xxx	Farbe: xxx	Color: xxx
cyl. num.: xxx	Number of Cylinders: xxx	N° cilindri: xxx	Nombre de cylindres: xxx	Zylinderanzahl: xxx	Número de cilindros: xxx
Dia: xxxmm	Diameter [mm]: xxx	Diametro [mm]: xxx	Diamètre [mm]: xxx	Durchmesser [mm]: xxx	Diámetro [mm]: xxx
distr. num.: xxx	Distributor Number: xxx	N° distributore accensione: xxx	Numéro de distributeur: xxx	Zündverteilernummer: xxx	Número de distribuidor de encendido: xxx
DOHC	Camshaft: DOHC	Albero a camme: DOHC	Arbre à cames: DOHC	Nockenwelle: DOHC	Árbol de levas: DOHC
electronic carburettor	Fuel Mixture Formation: Electronic Carburettor	Preparazione carburante: Carburatore elettronico	Préparation de carburant: Carburateur électronique	Kraftstoffaufbereitung: Elektronischer Vergaser	Preparación del combustible: Carburador electrónico
eng. type: xxx->	Engine Number from: xxx	N° motore da: xxx	N° de moteur de: xxx	Motornummer ab: xxx	n° de motor desde: xxx
eng.: xxx	Engine Code: xxx	Codice motore: xxx	Code moteur: xxx	Motorcode: xxx	Código de motor: xxx
-eng.: xxx	not for engine code: xxx	non per codice motore: xxx	pas pour code moteur: xxx	nicht für Motorcode: xxx	no para código de motor: xxx
euro 1	Emission Standard: Euro 1	Norma sui gas di scarico: Euro 1	Norme concernant les gaz d'échappement: Euro 1	Abgasnorm: Euro 1	Norma de emisiones: Euro 1
euro 2	Emission Standard: Euro 2	Norma sui gas di scarico: Euro 2	Norme concernant les gaz d'échappement: Euro 2	Abgasnorm: Euro 2	Norma de emisiones: Euro 2
euro 3	Emission Standard: Euro 3	Norma sui gas di scarico: Euro 3	Norme concernant les gaz d'échappement: Euro 3	Abgasnorm: Euro 3	Norma de emisiones: Euro 3
euro 3 (D3)	Emission Standard: Euro 3 (D3)	Norma sui gas di scarico: Euro 3 (D3)	Norme concernant les gaz d'échappement: Euro 3 (D3)	Abgasnorm: Euro 3 (D3)	Norma de emisiones: Euro 3
euro 4 (D4)	Emission Standard: Euro 4 (D4)	Norma sui gas di scarico: Euro 4 (D4)	Norme concernant les gaz d'échappement: Euro 4 (D4)	Abgasnorm: Euro 4 (D4)	Norma de emisiones: Euro 4
euro 5	Emission Standard: Euro 5	Norma sui gas di scarico: Euro 5	Norme concernant les gaz d'échappement: Euro 5	Abgasnorm: Euro 5	Norma de emisiones: Euro 5
euro 6	Emission Standard: Euro 6	Norma sui gas di scarico: Euro 6	Norme concernant les gaz d'échappement: Euro 6	Abgasnorm: Euro 6	Norma de emisiones: Euro 6
euro1/euro2	Emission Standard: Euro1/ Euro2	Norma sui gas di scarico: Euro1/Euro2	Norme concernant les gaz d'échappement: Euro1/Euro2	Abgasnorm: Euro1/Euro2	Norma de emisiones: Euro1/Euro2
euro2/euro3	Emission Standard: Euro2/ Euro3	Norma sui gas di scarico: Euro2/Euro3	Norme concernant les gaz d'échappement: Euro2/Euro3	Abgasnorm: Euro2/Euro3	Norma de emisiones: Euro2/Euro3
euro3/euro4	Emission Standard: Euro3/ Euro4	Norma sui gas di scarico: Euro3/Euro4	Norme concernant les gaz d'échappement: Euro3/Euro4	Abgasnorm: Euro3/Euro4	Norma de emisiones: Euro3/Euro4
euro4/euro5	Emission Standard: Euro4/ Euro5	Norma sui gas di scarico: Euro4/Euro5	Norme concernant les gaz d'échappement: euro4 euro5	Abgasnorm: Euro4/Euro5	Norma de emisiones: Euro 4/Euro 5



APPLICATION LIST GLOSSARY

EPS-IGN22Q1

-GLOSSARIO GUIDA APPLICAZIONI -GLOSSAIRE LISTE D'APPLICATIONS -GLOSSAR DER VERWENDUNGSLISTE -GLOSARIO LISTA APLICACIONES





#	ENGLISH 	ITALIANO 	FRANÇAIS 	DEUTSCH 	ESPAÑOL
euro5/euro6	Emission Standard: Euro5/ Euro6	Norma sui gas di scarico: Euro5/Euro6	Norme concernant les gaz d'échappement: Euro5/Euro6	Abgasnorm: Euro5/Euro6	Norma de emisiones: Euro5/Euro6
ext. thread: xxxmm	External Thread [mm]: xxx	Filetto esterno [mm]: xxx	Filetage extérieur [mm]: xxx	Außengewinde [mm]: xxx	Rosca exterior [mm]: xxx
for 1st gear	Number of Gears: for 1st gear	N° marce: per 1ª marcia	Nombre de vitesses: pour 1re vitesse	Ganganzahl: für 1. Gang	Número de marchas: para primera marcha
for emission-controlled vehicles	for emission-controlled vehicles: xxx	per veicoli sveleniti gas scarico: xxx	pour véhicules à émissions de gaz limitées: xxx	für abgasentgiftete Fahrzeuge: xxx	para vehículos con decontaminación de gases: xxx
for individual equipment ID: xxx	for individual equipment ID: xxx	per ID-equipaggiamento individuale: xxx	pour ID d'équipement individuel: xxx	für Individualausstattungs-ID: xxx	para ID equipamiento individual: xxx
for manuf. exhaust norm: xxx	for manufacturer exhaust norm: xxx	per norma sui gas di scarico-Costruttore: xxx	pour norme des gaz d'échappementdes fabricants: xxx	für Hersteller-Abgasnorm: xxx	para norma de emisión/fabricante: xxx
FOR MODEL: xxx	for model year: xxx	per anno d. modello: xxx	pour année: xxx	für Modelljahr: xxx	para modelo (año): xxx
FOR: xxx	Country-spec. model: xxx	Modello p. paesi: xxx	Type de pays: xxx	Länderausführung: xxx	Modelo por país: xxx
FP: after soot particulate filter	Fitting Position: after soot particulate filter	Lato montaggio: dopo il/ al Filtro antiparticolato	Côté d'assemblage: après filtre à particules	Einbauseite: nach Rußpartikelfilter	Lado de montaje: con filtro de partículas
FP: Air Filter Housing	Fitting Position: Air Filter Housing	Lato montaggio: Carter filtro aria	Côté d'assemblage: Boîtier de filtre à air	Einbauseite: Luftfiltergehäuse	Lado de montaje: Caja filtro de aire
FP: before soot particulate filter	Fitting Position: before soot particulate filter	Lato montaggio: davanti al filtro antiparticolato	Côté d'assemblage: devant le filtre à particules	Einbauseite: vor Rußpartikelfilter	Lado de montaje: antes de filtro de partículas
FP: Behind exhaust turbo charger	Fitting Position: Behind exhaust turbo charger	Lato montaggio: a valle del turbocompressore	Côté d'assemblage: derrière turbocompresseur	Einbauseite: nach Abgasturbolader	Lado de montaje: al turbocompresor de gases de escape
FP: Boot	Fitting Position: Boot	Lato montaggio: Bagagliaio	Côté d'assemblage: Coffre à bagages	Einbauseite: Kofferraum	Lado de montaje: Maletero
FP: Brake Booster	Fitting Position: Brake Booster	Lato montaggio: Servofreno	Côté d'assemblage: Servofrein	Einbauseite: Bremskraftverstärker	Lado de montaje: Servofrenos
FP: Centre	Fitting Position: Centre	Lato montaggio: centro	Côté d'assemblage: centre	Einbauseite: mitte	Lado de montaje: centro
FP: Compressor Side	Fitting Position: Compressor Side	Lato montaggio: Lato compressore	Côté d'assemblage: Côté compresseur	Einbauseite: Verdichterseite	Lado de montaje: compresor
FP: Cylinder Head	Fitting Position: Cylinder Head	Lato montaggio: Testa a cilindro	Côté d'assemblage: Culasse de cylindre	Einbauseite: Zylinderkopf	Lado de montaje: Cabeza cilíndrica
FP: Elbow at exhaust manifold	Fitting Position: Elbow at exhaust manifold	Lato montaggio: Curva al collettore per scarico	Côté d'assemblage: Tube coudé au collecteur d'échappement	Einbauseite: Rohrkrümmer an Abgaskrümmer	Lado de montaje: codo en colector de escape
FP: End Silencer	Fitting Position: End Silencer	Lato montaggio: Silenziatore posteriore	Côté d'assemblage: Silencieux arrière	Einbauseite: Endschalldämpfer	Lado de montaje: Silenciador posterior
FP: Engine Side	Fitting Position: Engine Side	Lato montaggio: Lato motore	Côté d'assemblage: du côté moteur	Einbauseite: motorseitig	Lado de montaje: motor
FP: Exhaust Manifold	Fitting Position: Exhaust Manifold	Lato montaggio: Collettore gas scarico	Côté d'assemblage: Collecteur des gaz d'échappement	Einbauseite: Abgaskrümmer	Lado de montaje: Colector de escape
FP: Exhaust Pipe at exh. Turbocharger	Fitting Position: Exhaust Pipe at exhaust turbocharger	Lato montaggio: Condotto gas scarico a Turbocompressore a gas scarico	Côté d'assemblage: Tuyau d'échappement au turbocompresseur	Einbauseite: Abgasrohr an Abgasturbolader	Lado de montaje: Colector de escape en turbocompresor
FP: Exhaust Pipe on silencer	Fitting Position: Exhaust Pipe on silencer	Lato montaggio: Tubo gas scarico alla marmitta	Côté d'assemblage: Tuyau d'échappement au silencieux	Einbauseite: Abgasrohr an Schalldämpfer	Lado de montaje: Tubo de escape en silenciador
FP: Fan side	Fitting Position: Fan side	Lato montaggio: lato ventola	Côté d'assemblage: du côté du ventilateur	Einbauseite: Lüfterseitig	Lado de montaje: del lado del ventilador
FP: Flywheel side	Fitting Position: Flywheel side	Lato montaggio: lato disco del volante	Côté d'assemblage: du côté du volant moteur	Einbauseite: schwungradscheibenseitig	Lado de montaje: del lado del volante
FP: Front	Fitting Position: Front	Lato montaggio: anteriore	Côté d'assemblage: avant	Einbauseite: vorne	Lado de montaje: delante
FP: Front and Rear	Fitting Position: Front and Rear	Lato montaggio: anteriore e posteriore	Côté d'assemblage: avant et arrière	Einbauseite: vorne und hinten	Lado de montaje: delante y detrás
FP: Front Axle Left	Fitting Position: Front Axle Left	Lato montaggio: Assale anteriore Sx	Côté d'assemblage: Essieu avant gauche	Einbauseite: Vorderachse links	Lado de montaje: Eje delantero, izquierda
FP: Front Axle left and right	Fitting Position: Front Axle left and right	Lato montaggio: Assale anteriore bilaterale	Côté d'assemblage: des deux côtés de l'essieu avant	Einbauseite: Vorderachse beidseitig	Lado de montaje: eje delantero, ambos lados
FP: Front Axle Right	Fitting Position: Front Axle Right	Lato montaggio: Assale anteriore Dx	Côté d'assemblage: Essieu avant droit	Einbauseite: Vorderachse rechts	Lado de montaje: Eje delantero, derecha
FP: Fuel Line	Fitting Position: Fuel Line	Lato montaggio: Condotto carburante	Côté d'assemblage: Tube d'alimentation	Einbauseite: Kraftstoffleitung	Lado de montaje: Tubería de combustible



APPLICATION LIST GLOSSARY

EPS-IGN22Q1

·GLOSSARIO GUIDA APPLICAZIONI ·GLOSSAIRE LISTE D'APPLICATIONS ·GLOSSAR DER VERWENDUNGSLISTE ·GLOSARIO LISTA APLICACIONES

#	ENGLISH 	ITALIANO 	FRANÇAIS 	DEUTSCH 	ESPAÑOL 
FP: In front of exhaust turbocharger	Fitting Position: in front of exhaust turbocharger	Lato montaggio: davanti a turbocompressore	Côté d'assemblage: devant le turbocompresseur à gaz d'échappement	Einbauseite: vor Abgasturbolader	Lado de montaje: de turbocompresor escape
FP: In front of the catalyst	Fitting Position: in front of the catalyst	Lato montaggio: davanti al catalizzatore	Côté d'assemblage: devant le catalyseur	Einbauseite: vor Katalysator	Lado de montaje: delante del catalizador
FP: In front of the radiator	Fitting Position: in front of the radiator	Lato montaggio: davanti al radiatore	Côté d'assemblage: devant le radiateur	Einbauseite: vor dem Kühler	Lado de montaje: delante del radiador
FP: In fuel tank	Fitting Position: in fuel tank	Lato montaggio: nel serbatoio carburante	Côté d'assemblage: dans le réservoir de carburant	Einbauseite: im Kraftstoffbehälter	Lado de montaje: incl. depósito combustible
FP: in transm.housing	Fitting Position: in transmission housing	Lato montaggio: nella scatola del cambio	Côté d'assemblage: dans la boîte de transmission	Einbauseite: im Getriebegehäuse	Lado de montaje: en cárter de transmisión
FP: Inlet	Fitting Position: Inlet	Lato montaggio: Entrata	Côté d'assemblage: Entrée	Einbauseite: Eingang	Lado de montaje: Entrada
FP: Inner	Fitting Position: inner	Lato montaggio: interno	Côté d'assemblage: intérieur	Einbauseite: innen	Lado de montaje: interior
FP: Intake Manifold	Fitting Position: Intake Manifold	Lato montaggio: Collettore d'aspirazione	Côté d'assemblage: Collecteur d'admission	Einbauseite: Ansaugkrümmer	Lado de montaje: Colector de admisión
FP: Intake Side	Fitting Position: Intake Side	Lato montaggio: Lato aspirazione	Côté d'assemblage: Côté d'admission	Einbauseite: Einlassseite	Lado de montaje: Lado de admisión
FP: Intercooler	Fitting Position: Intercooler	Lato montaggio: Intercooler	Côté d'assemblage: Intercooler, échangeur	Einbauseite: Ladeluftkühler	Lado de montaje: Refrigerador de aire de sobrealimentación
FP: Left	Fitting Position: Left	Lato montaggio: Sx	Côté d'assemblage: gauche	Einbauseite: links	Lado de montaje: izquierda
FP: Left and right	Fitting Position: Left and right	Lato montaggio: bilaterale	Côté d'assemblage: côté conducteur + passager av.	Einbauseite: beidseitig	Lado de montaje: ambos lados
FP: Left Front	Fitting Position: Left Front	Lato montaggio: anteriore Sx	Côté d'assemblage: avant gauche	Einbauseite: vorne links	Lado de montaje: Delante, izquierda
FP: Left Front	Fitting Position: Left	Lato montaggio: Sx	Côté d'assemblage: gauche	Einbauseite: links	Lado de montaje: izquierda
FP: Left Rear	Fitting Position: Left Rear	Lato montaggio: posteriore Sx	Côté d'assemblage: arrière gauche	Einbauseite: hinten links	Lado de montaje: Atrás izquierda
FP: Lower	Fitting Position: Lower	Lato montaggio: inferiore	Côté d'assemblage: inférieur	Einbauseite: unten	Lado de montaje: debajo
FP: Middle Silencer	Fitting Position: Middle Silencer	Lato montaggio: Silenziatore centrale	Côté d'assemblage: Pot de détente	Einbauseite: Mittelschalldämpfer	Lado de montaje: silenciador del medio
FP: Outer	Fitting Position: Outer	Lato montaggio: Esterno	Côté d'assemblage: extérieur	Einbauseite: außen	Lado de montaje: exterior
FP: Outlet	Fitting Position: Outlet	Lato montaggio: Uscita	Côté d'assemblage: Sortie	Einbauseite: Ausgang	Lado de montaje: Salida
FP: Outlet Side	Fitting Position: Exhaust Side	Lato montaggio: Lato scarico	Côté d'assemblage: Côté d'échappement	Einbauseite: Auslassseite	Lado de montaje: Lado de escape
FP: Particulate Filter	Fitting Position: Particulate Filter	Lato montaggio: Filtro particellare	Côté d'assemblage: Filtre à particules	Einbauseite: Partikelfilter	Lado de montaje: Filtro de partículas
FP: Pipe at EGR valve	Fitting Position: Pipe at EGR valve	Lato montaggio: Condotto a valvola-EGR	Côté d'assemblage: Ligne à la valve EGR	Einbauseite: Leitung an AGR-Ventil	Lado de montaje: Tubo en válvula EGR
FP: Post-catalyst	Fitting Position: Post-catalyst	Lato montaggio: al Catalizzatore	Côté d'assemblage: après catalyseur	Einbauseite: nach Katalysator	Lado de montaje: después de catalizador
FP: Rear	Fitting Position: Rear	Lato montaggio: posteriore	Côté d'assemblage: arrière	Einbauseite: hinten	Lado de montaje: posterior
FP: Rear Axle	Fitting Position: Rear Axle	Lato montaggio: Assale posteriore	Côté d'assemblage: Essieu arrière	Einbauseite: Hinterachse	Lado de montaje: Eje trasero
FP: Rear Axle Left	Fitting Position: Rear Axle Left	Lato montaggio: Assale posteriore Sx	Côté d'assemblage: Essieu arrière gauche	Einbauseite: Hinterachse links	Lado de montaje: Eje trasero izquierda
FP: Rear Axle left and right	Fitting Position: Rear Axle left and right	Lato montaggio: Assale post. bilaterale	Côté d'assemblage: des deux côtés du pont arrière	Einbauseite: Hinterachse beidseitig	Lado de montaje: eje trasero ambos lados
FP: Rear Axle Right	Fitting Position: Rear Axle Right	Lato montaggio: Assale posteriore Dx	Côté d'assemblage: Essieu arrière droit	Einbauseite: Hinterachse rechts	Lado de montaje: Eje trasero, derecha
FP: right	Fitting Position: Right	Lato montaggio: Dx	Côté d'assemblage: droite	Einbauseite: rechts	Lado de montaje: derecha
FP: Right front	Fitting Position: Right Front	Lato montaggio: anteriore Dx	Côté d'assemblage: avant droite	Einbauseite: vorne rechts	Lado de montaje: Delante, derecha
FP: Right Rear	Fitting Position: Right Rear	Lato montaggio: posteriore Dx	Côté d'assemblage: arrière droite	Einbauseite: hinten rechts	Lado de montaje: Atrás derecha
FP: Throttle Housing	Fitting Position: Throttle Housing	Lato montaggio: Sede valvola a farfalla	Côté d'assemblage: Boîtier papillon	Einbauseite: Drosselklappengehäuse	Lado de montaje: Caja mariposa
FP: to cylinder 3	Fitting Position: to cylinder 3	Lato montaggio: al cilindro 3	Côté d'assemblage: au cylindre 3	Einbauseite: zum Zylinder 3	Lado de montaje: al cilindro 3
FP: to cylinder 4	Fitting Position: to cylinder 4	Lato montaggio: al cilindro 4	Côté d'assemblage: au cylindre 4	Einbauseite: zum Zylinder 4	Lado de montaje: al cilindro 4



APPLICATION LIST GLOSSARY

EPS-IGN22Q1

-GLOSSARIO GUIDA APPLICAZIONI -GLOSSAIRE LISTE D'APPLICATIONS -GLOSSAR DER VERWENDUNGSLISTE -GLOSARIO LISTA APLICACIONES





#	ENGLISH 	ITALIANO 	FRANÇAIS 	DEUTSCH 	ESPAÑOL
FP: Transmission End	Fitting Position: Transmission End	Lato montaggio: sul lato del cambio	Côté d'assemblage: du côté boîte de vitesses	Einbauseite: getriebeseitig	Lado de montaje: lado de engranaje
FP: Turbine Inlet	Fitting Position: Turbine Inlet	Lato montaggio: Entrata turbina	Côté d'assemblage: Entrée de turbine	Einbauseite: Turbineneingang	Lado de montaje: Entrada turbina
FP: Upper	Fitting Position: Upper	Lato montaggio: Superiore	Côté d'assemblage: supérieur	Einbauseite: oben	Lado de montaje: arriba
FP: Water Pump	Fitting Position: Water Pump	Lato montaggio: Pompa acqua	Côté d'assemblage: Pompe à eau	Einbauseite: Wasserpumpe	Lado de montaje: bomba de agua
fuel formation: carburettor	Fuel Mixture Formation: Carburettor	Preparazione carburante: Carburatore	Préparation de carburant: Carburateur	Kraftstoffaufbereitung: Vergaser	Preparación del combustible: Carburador
fuel formation: direct injection	Fuel Mixture Formation: Direct Injection	Preparazione carburante: Iniezione diretta	Préparation de carburant: Injection directe	Kraftstoffaufbereitung: Direkteinspritzung	Preparación del combustible: Inyección directa
fuel formation: motronic	Fuel Mixture Formation: Motronic	Preparazione carburante: Motronic	Préparation de carburant: Motronic	Kraftstoffaufbereitung: Motronic	Preparación del combustible: Motronic
Green	Housing Colour: xxx	Colore alloggiamento: xxx	Couleur du carter: xxx	Gehäusefarbe: xxx	Color de carcasa: xxx
Grey	Housing Colour: xxx	Colore alloggiamento: xxx	Couleur du carter: xxx	Gehäusefarbe: xxx	Color de carcasa: xxx
info: xxx	Technical Information Number: xxx	N° informazione tecnica: xxx	Numéro d'information technique: xxx	Technische Informationsnummer: xxx	N° de información técnica: xxx
interference suppressed	Interference suppressed: xxx	schermato/a: xxx	déparasité: xxx	entstört: xxx	con supresión de interferencias: xxx
L: xxxmm	Length [mm]: xxx	Lunghezza [mm]: xxx	Longueur [mm]: xxx	Länge [mm]: xxx	Longitud [mm]: xxx
L3	Emission Standard: L3	Norma sui gas di scarico: L3	Norme concernant les gaz d'échappement: L3	Abgasnorm: L3	Norma de emisiones: L3
L4	Emission Standard: L4	Norma sui gas di scarico: L 4	Norme concernant les gaz d'échappement: L4	Abgasnorm: L4	Norma de emisiones: L4
MADE BY: xxx	Vehicle Production Country: xxx	Paese produzione veicolo: xxx	Pays constructeur du véhicule: xxx	Fahrzeugproduktionsland: xxx	País producción vehículo: xxx
MODEL FROM: xxx	Model year from: xxx	Anno modello da: xxx	Année à partir de: xxx	Modelljahr ab: xxx	año modelo desde: xxx
MODEL TO: xxx	Model year to: xxx	Anno modello fino a: xxx	Année jusqu'à: xxx	Modelljahr bis: xxx	año modelo hasta: xxx
-model: xxx	not for code: xxx	non per modello: xxx	pas pour le modèle: xxx	nicht für Baumuster: xxx	no apto para el tipo: xxx
Multi Point Injection (MPI)	Injection System: Multi Point Injection (MPI)	Sistema iniezione: MPI (Multipoint)	Système d'injection: MPI (MultiPoint)	Einspritzsystem: MPI (MultiPoint)	Sistema de inyección: MPI (MultiPoint)
NOT FOR: xxx	not for country-spec. model: xxx	non per versione per paese: xxx	pas pour version-pays: xxx	nicht für Länderausführung: xxx	no para modelo país: xxx
NOT MADE BY: xxx	not for vehicle production country: xxx	non per paese produzione veicolo: xxx	pas pour pays constructeur du véhicule: xxx	nicht für Fahrzeugproduktionsland: xxx	no para país producción vehículos: xxx
oe: xxx	for OE number: xxx	per N° OE: xxx	pour numéro OE: xxx	für OE-Nummer: xxx	para OE N°: xxx
Orange	Housing Colour: xxx	Colore alloggiamento: xxx	Couleur du carter: xxx	Gehäusefarbe: xxx	Color de carcasa: xxx
org.: xxx->	for organisation number from: xxx	per numero organizzazione da: xxx	pour numéro d'organisation à partir de: xxx	für Organisationsnummer ab: xxx	para números de organización desde: xxx
petrol injection	Fuel Mixture Formation: Petrol Injection	Preparazione carburante: Iniezione benzina	Préparation de carburant: Injection d'essence	Kraftstoffaufbereitung: Benzineinspritzung	Preparación del combustible: Inyección de gasolina
pole nr.: xxx	Number of Poles: xxx	N° poli: xxx	Nombres de pôles: xxx	Pol-Anzahl: xxx	Número de polos: xxx
prod. nr.: xxx->	Production number from: xxx	N° produzione da: xxx	N° de production à partir de: xxx	Produktionsnummer ab: xxx	n° de producción desde: xxx
production date ->: xxx	Production date to: xxx	Data di produzione fino a: xxx	Date de production jusqu'à: xxx	Produktionsdatum bis: xxx	fecha de producción hasta: xxx
production date: xxx->	Production date from: xxx	Data di produzione da: xxx	Date de production à partir de: xxx	Produktionsdatum ab: xxx	fecha de producción desde: xxx
Qty: xxx	Quantity: xxx	Quantità: xxx	Quantité: xxx	Menge: xxx	Cantidad: xxx
Red	Housing Colour: xxx	Colore alloggiamento: xxx	Couleur du carter: xxx	Gehäusefarbe: xxx	Color de carcasa: xxx
resist.: xxxohm	Resistance [Ohm]: xxx	Resistenza [Ohm]: xxx	Résistance [ohm]: xxx	Widerstand [Ohm]: xxx	Resistencia [Ohm]: xxx
RPM to: xxx[1/min]	RPM to [1/min]: xxx	N° giri fino a [1/min.]: xxx	Régime mot. jusqu'à [1/min]: xxx	Drehzahl bis [1/min]: xxx	vel. giro hasta [1/min]: xxx
SA: xxx	for SA code: xxx	per codice SA: xxx	pour SA code: xxx	für SA Code: xxx	para código SA: xxx
-SA: xxx	not for SA code: xxx	non per codice SA: xxx	pas pour SA code: xxx	nicht für SA Code: xxx	no para código SA: xxx
SOHC/OHC	Camshaft: SOHC/OHC	Albero a camme: SOHC/OHC	Arbre à cames: SOHC/OHC	Nockenwelle: SOHC/OHC	Árbol de levas: SOHC/OHC
t.tnr.: xxx	Transmission Type: xxx	Tipo di trasmissione: xxx	Type de boîte de vitesses: xxx	Getriebetyp: xxx	Tipo de caja de cambios: xxx



APPLICATION LIST GLOSSARY

EPS-IGN22Q1

•GLOSSARIO GUIDA APPLICAZIONI •GLOSSAIRE LISTE D'APPLICATIONS •GLOSSAR DER VERWENDUNGSLISTE •GLOSARIO LISTA APLICACIONES

#	ENGLISH 	ITALIANO 	FRANÇAIS 	DEUTSCH 	ESPAÑOL 
-transm. type: xxx	not for transmission type: xxx	non per tipo di trasmissione: xxx	pas pour type de transmission: xxx	nicht für Getriebetyp: xxx	no para tipo de transmisión: xxx
version: xxx	Version: xxx	Versione: xxx	Version: xxx	Version: xxx	Versión: xxx
VET.: xxx->	VET Number from: xxx	N° VET da: xxx	Numéro VET à partir de: xxx	VET-Nummer ab: xxx	n° VET desde: xxx
White	Housing Colour: xxx	Colore alloggio: xxx	Couleur du carter: xxx	Gehäusefarbe: xxx	Color de carcasa: xxx
xxx->	Construction year from: xxx	Anno da: xxx	Année à partir de: xxx	Baujahr ab: xxx	año construcción desde: xxx
xxxkW	Power [kW]: xxx	Potenza [KW]: xxx	Puissance [kW]: xxx	Leistung [kW]: xxx	Potencia [kW]: xxx
Yellow	Housing Colour: xxx	Colore alloggio: xxx	Couleur du carter: xxx	Gehäusefarbe: xxx	Color de carcasa: xxx

ILLUSTRATED SECTION

EPS-IGN22Q1

-PARTE FIGURATA -PARTIE ILLUSTRÉE -BILDTEIL -PARTE ILUSTRADA





CONDENSERS

-CONDENSATORI -CONDENSATEURS -KONDENSATOREN -CONDENSADORES

(A) P/NRS. - NOTES

- CODICI - NOTE
- RÉFS. - NOTES
- ARTIKEL-NR. - ANMERKUNGEN
- CODIGOS - NOTAS

1.106.196



1

CONDENSERS

Adatt./Su...ole: **BOSCH**

BOSCH

1 237 330 310

GENERAL MOTORS

93 150 082

VW

060 905 295

⁰³ Supplied until depletion

- Fornibile fino ad esaurimento delle scorte
- Fourni jusqu'à épuisement du stock
- Lieferbar solange vorrat reicht
- Suministrado hasta el stock termina

(A)

1 # EPS

2 **OEM P/NRS.**
 • CODICI ORIGINALI
 • RÉFS. D'ORIGINE
 • ORIGINALTEILE-NR.
 • CODIGOS ORIGINALES

3 **PACKAGING SIZE**
 • FORMATO CONFEZIONE
 • FORMAT DU CONDITIONNEMENT
 • ABPACKENSGROSSE
 • TAMAÑO DEL ENVASE

4 **NOTE**
 • NOTE
 • NOTES
 • BEMERKUNGEN
 • NOTAS

(B) PICTURE + TECHNICAL INFO

- FOTO + INFORMAZIONE TECNICA
- ILLUSTRATION + INFORMATION TECHNIQUE
- BILD + TECHNISCHE INFO
- FOTO + INFORMACIÓN TÉCNICA

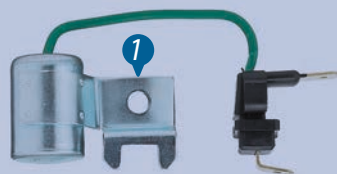

Ø=mm	h=mm	µF
18	25	0,23

(C) APPLICATION LIST

- GUIDA APPLICAZIONI
- LISTE D'APPLICATIONS
- ANWENDUNGSTABELLE
- LISTA DE APLICACIONES

VW		
CADDY I 1.5	JB	08/82 ⇒ 07/83
CADDY I 1.6	EW, HN	01/83 ⇒ 07/92
DERBY 1.0	GL	10/81 ⇒ 12/84
GOLF II 1.0	GN	11/83 ⇒ 08/85
GOLF II 1.6	EZ	08/83 ⇒ 07/92
GOLF II 1.6 (CHE) [SWE]	HM	08/83 ⇒ 07/85
JETTA II 1.6	EZ, HM	12/83 ⇒ 07/92
POLO II 1.0	GL	10/81 ⇒ 10/86
SCIROCCO I 1.5	JB	08/77 ⇒ 07/80
SCIROCCO II 1.6	FR, FR	08/80 ⇒ 04/84

(B)

1 **PICTURE**
 • FOTO
 • PHOTO
 • BILD
 • FOTO

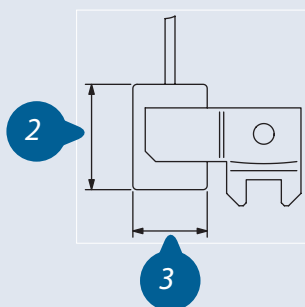

4 **CAPACITY**
 • CAPACITÀ
 • CAPACITÉ
 • CAPAZITÄT
 • CAPACIDAD

EPS 1.106.030



CONDENSERS

Adatt./Suitable: BOSCH

BOSCH

1 237 330 035
1 237 330 036
1 237 330 039
2 207 330 011

⁰³ Supplied until depletion

- Fornibile fino ad esaurimento delle scorte
- Fourni jusqu'à épuisement du stock
- Lieferbar solange vorrat reicht
- Suministrado hasta el stock termina

VW

411 963 073



Ø=mm	h=mm	µF
18	21	0,18

EPS 1.106.180



CONDENSERS

Adatt./Suitable: BOSCH

BOSCH

2 207 330 041
2 207 330 050

⁰⁰ Eliminated on 01-03-2022. Please verify the availability through our local distributors

- Eliminato il 01-03-2022. Verificare la disponibilità presso i nostri distributori
- Éliminé le 01-03-2022. Vérifier la disponibilité auprès de nos distributeurs sur place
- Am 01-03-2022 gestrichen. Evtl. Verfügbarkeit bitte bei unseren Händlern prüfen
- Eliminado en fecha 01-03-2022. Verificar la disponibilidad a través de nuestros distribuidores locales



Ø=mm	h=mm	µF
18	21	0,18

EPS 1.106.195



CONDENSERS

Adatt./Suitable: BOSCH

BOSCH

1 237 330 316

GENERAL MOTORS
93 150 083

SAAB

93 51 743

VW

052 905 295

⁰⁰ Eliminated on 07-04-2021. Please verify the availability through our local distributors

- Eliminato il 07-04-2021. Verificare la disponibilità presso i nostri distributori
- Éliminé le 07-04-2021. Vérifier la disponibilité auprès de nos distributeurs sur place
- Am 07-04-2021 gestrichen. Evtl. Verfügbarkeit bitte bei unseren Händlern prüfen
- Eliminado en fecha 07-04-2021. Verificar la disponibilidad a través de nuestros distribuidores locales

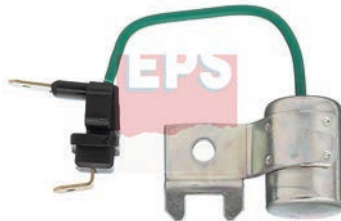

Ø=mm	h=mm	µF
18	25	0,23

VW

POLO II 1.1	HB	10/81 ⇨ 09/89
POLO II 1.3	GT, HH, HJ, HK, HW	10/81 ⇨ 07/88
JETTA II 1.3	GT, HK	01/84 ⇨ 06/87
DERBY 1.1	HB	02/77 ⇨ 09/81
DERBY 1.3	HH	02/77 ⇨ 09/81
GOLF I 1.3	HK	08/83 ⇨ 07/86
GOLF II 1.0	GN	11/83 ⇨ 08/85
GOLF II 1.3	GT, HK	08/83 ⇨ 06/87
SCIROCCO I 1.1	FA	04/74 ⇨ 07/79
SCIROCCO I 1.3	GF	08/79 ⇨ 07/80
SCIROCCO II 1.3	HK	08/83 ⇨ 07/84

EPS 1.106.196



CONDENSERS

Adatt./Suitable: BOSCH

BOSCH

1 237 330 310

GENERAL MOTORS
93 150 082

VW

060 905 295

⁰³ Supplied until depletion

- Fornibile fino ad esaurimento delle scorte
- Fourni jusqu'à épuisement du stock
- Lieferbar solange vorrat reicht
- Suministrado hasta el stock termina



Ø=mm	h=mm	µF
18	25	0,23

VW

POLO II 1.0	GL	10/81 ⇨ 10/86
JETTA II 1.6	EZ, HM	12/83 ⇨ 07/92
CADDY I 1.5	JB	08/82 ⇨ 07/83
CADDY I 1.6	EW, HN	01/83 ⇨ 07/92
DERBY 1.0	GL	10/81 ⇨ 12/84

VW

GOLF II 1.0	GN	11/83 ⇨ 08/85
GOLF II 1.6	EZ	08/83 ⇨ 07/92
GOLF II 1.6 [CHE] [SWE]	HM	08/83 ⇨ 07/85
SCIROCCO I 1.5	JB	08/77 ⇨ 07/80
SCIROCCO II 1.6	1HyFAD	08/80 ⇨ 04/84

EPS 1.106.212



CONDENSERS

Adatt./Suitable: BOSCH

BOSCH

1 237 330 307
1 237 330 340
1 237 330 353

GENERAL MOTORS

90 009 490
90 114 106
93 150 118
93 150 586

OPEL

12 12 253
12 12 259
12 12 260
90009490

⁰³ Supplied until depletion

- Fornibile fino ad esaurimento delle scorte
- Fourni jusqu'à épuisement du stock
- Lieferbar solange vorrat reicht
- Suministrado hasta el stock termina



Ø=mm	h=mm	µF
18	25	0,23

OPEL

CORSA A 1.0	10S	09/82 ⇨ 03/93
CORSA A 1.2	12N, 12NC	09/82 ⇨ 08/90
CORSA A 1.2 N	12NC	01/85 ⇨ 10/87
KADETT B 1.1	11N	08/71 ⇨ 08/73
KADETT D 1.0	10N	09/79 ⇨ 08/82
KADETT E 1.2	12SC	09/84 ⇨ 07/86

EPS 1.106.257



CONDENSERS

Adatt./Suitable: BOSCH

BOSCH

1 237 330 348

VW

036 905 295 B

⁰³ Supplied until depletion

- Fornibile fino ad esaurimento delle scorte
- Fourni jusqu'à épuisement du stock
- Lieferbar solange vorrat reicht
- Suministrado hasta el stock termina



Ø=mm	h=mm	µF
18	25	0,23

EPS 1.115.023



CONDENSERS

Adatt./Suitable: DUCELLIER

ALFA ROMEO

116 55 05 011 03/04

BOSCH

1 237 330 801

1 237 330 803

DUCELLIER

1203

FIAT

9934266

GENERAL MOTORS

3 474 600

LANCIA

9934266

Motorcraft

EDC 62

EDC 173

PEUGEOT

5948 05

5948 06

RENAULT

08 53 712 500

77 01 022 130

VOLVO

3102885

31028855

3277441

32774416

⁰⁰ Eliminated on 10-12-2021. Please verify the availability through our local distributors

- Eliminato il 10-12-2021. Verificare la disponibilità presso i nostri distributori
- Éliminé le 10-12-2021. Vérifier la disponibilité auprès de nos distributeurs sur place
- Am 10-12-2021 gestrichen. Evtl. Verfügbarkeit bitte bei unseren Händlern prüfen
- Eliminado en fecha 10-12-2021. Verificar la disponibilidad a través de nuestros distribuidores locales



Ø=mm	h=mm	µF
17	38,5	0,23

FIAT		
127 0.9	100GL.048	06/71 ⇨ 05/83
128 1.1	128A.000	03/69 ⇨ 12/84
131 1.3 Mirafiori	131A6.000	10/74 ⇨ 09/81
132 1.6	132C.000	05/77 ⇨ 09/82
242 1.6	124B3.000	10/75 ⇨ 07/82
FIORINO I 900	100GL.000	10/77 ⇨ 10/86
LANCIA		
A 112 0.9 Junior	A112A5.000	03/81 ⇨ 06/86
PEUGEOT		
504 1.8 Injection	KF5, KF6	07/68 ⇨ 02/71
RENAULT		
4 0.8	80001, 800705	09/71 ⇨ 12/88
5 1.3	810719, 810726	09/76 ⇨ 09/84
20 2.0	829700, 829701, 829702, 829703, 829.01	10/77 ⇨ 12/83

EPS 1.115.034



CONDENSERS

Adatt./Suitable: DUCELLIER

ALFA ROMEO

700 299

60748381

9950152

BOSCH

1 237 330 805

1 237 330 806

DUCELLIER

609 504

FIAT

9937715

GENERAL MOTORS

7 992 353

7 992 359

93 150 117

93 150 124

PEUGEOT

5948 11

5948 17

5948 27

RENAULT

77 01 018 729

77 01 020 079

ROVER

GSC113

RTC6620

⁰⁰ Eliminated on 31-08-2021. Please verify the availability through our local distributors

- Eliminato il 31-08-2021. Verificare la disponibilità presso i nostri distributori
- Éliminé le 31-08-2021. Vérifier la disponibilité auprès de nos distributeurs sur place
- Am 31-08-2021 gestrichen. Evtl. Verfügbarkeit bitte bei unseren Händlern prüfen
- Eliminado en fecha 31-08-2021. Verificar la disponibilidad a través de nuestros distribuidores locales

⁰³ Supplied until depletion

- Fornibile fino ad esaurimento delle scorte
- Fourni jusqu'à épuisement du stock
- Lieferbar solange vorrat reicht
- Suministrado hasta el stock termina



Ø=mm	h=mm	µF
17	38,5	0,23

ALFA ROMEO		
ALFASUD 1.2	AR30102	06/72 ⇨ 09/84
CITROËN		
AXEL 11	G11/631	01/84 ⇨ 03/91
CX I 2400	M23-623	08/76 ⇨ 06/80
FIAT		
DUCATO 11.8	169B	01/82 ⇨ 12/88
LAND ROVER		
90 2.5 4x4	17H	09/85 ⇨ 08/90
110/127 2.5 4x4	17H	10/85 ⇨ 07/90
DEFENDER 2.25	--	01/87 ⇨
PEUGEOT		
104 0.9	108(XV5)	10/79 ⇨ 10/83
305 1.5	117(XR5S)	05/80 ⇨ 09/82
505 1.8	105(XM7), 105C(XM7A)	06/81 ⇨ 10/86
J9 1.6	XC7P	03/80 ⇨ 06/87
RENAULT		
5 1.4 Alpine A5	840725	09/77 ⇨ 09/81
14 1.4	150	09/79 ⇨ 06/83

ROVER		
MINI 1.0	--	01/85 ⇨
MINI 1.3	--	01/85 ⇨
TALBOT		
SAMBA 1.1	XW7	01/81 ⇨ 06/86

EPS 1.115.039



CONDENSERS

Adatt./Suitable: DUCELLIER

DUCELLIER

450 005

FIAT

9936734

9938166

GENERAL MOTORS

93 150 455

SEAT

000 389 973 1

000 993 673 4

SE 141914.007C

⁰⁰ Eliminated on 02-08-2021. Please verify the availability through our local distributors

- Eliminato il 02-08-2021. Verificare la disponibilità presso i nostri distributori
- Éliminé le 02-08-2021. Vérifier la disponibilité auprès de nos distributeurs sur place
- Am 02-08-2021 gestrichen. Evtl. Verfügbarkeit bitte bei unseren Händlern prüfen
- Eliminado en fecha 02-08-2021. Verificar la disponibilidad a través de nuestros distribuidores locales



Ø=mm	h=mm	µF
17	38,5	0,23

FIAT		
PANDA I 750	141B.000	01/86 ⇨ 01/95
PANDA I 800	100GL6.000	02/81 ⇨ 12/85
PANDA I 900	100GL3.000	10/80 ⇨ 06/94
PANDA I 900 CL	146A.048	01/86 ⇨ 04/91
REGATA 1.1 60, 60 L	138B.000	10/83 ⇨ 08/86
REGATA 1.6	149A.000	10/84 ⇨ 06/89
REGATA 70 1.3	138B2.000, 149A3.000	09/83 ⇨ 07/89
REGATA 85 1.6	149A.000	10/83 ⇨ 06/90
RITMO I 1.1	146A4.048	04/85 ⇨ 12/87
RITMO I 1.3	149A3.000	11/83 ⇨ 08/85
RITMO II 75 1.5	138A2.000	09/85 ⇨ 12/88
UNO 45 0.9	146A.000, 146A1.000	03/83 ⇨ 07/96
UNO 45 0.9 Trend	146A.048	09/89 ⇨ 09/92
UNO 60 1.1 SX	--	01/83 ⇨ 12/85
SEAT		
FURA 0.9	100GL3000	01/82 ⇨ 06/86
IBIZA I 0.9	146A000	08/86 ⇨ 05/93
PANDA 34 850	--	01/80 ⇨ 12/83
PANDA 35 850	--	01/80 ⇨ 12/83

EPS 1.117.097



CONDENSERS

Adatt./Suitable: **FEMSA****BOSCH**
9 232 337 354
9 232 337 354 706**FEMSA**
10249-43**RENAULT**
77 02 124 317

- ⁰³ Supplied until depletion
- Fornibile fino ad esaurimento delle scorte
 - Fourni jusqu'à épuisement du stock
 - Lieferbar solange vorrat reicht
 - Suministrado hasta el stock termina



Ø=mm	h=mm	µF
18	31,5	0,25

RENAULT

4.0.8 | 8001 | 09/71 ⇨ 12/88

EPS 1.130.117



CONDENSERS

Adatt./Suitable: **MARELLI****ALFA ROMEO**
701 707
116 55 05 011 01/09
60730444
60749285**BOSCH**
1 237 330 828**FIAT**
9928245**GENERAL MOTORS**
93 150 084**MAGNETI MARELLI**
CE 22 B
CE 22 C
CE 39 A
CE 39 G**SEAT**
000 389 806 0
NG1 811 683 1

- ⁰³ Supplied until depletion
- Fornibile fino ad esaurimento delle scorte
 - Fourni jusqu'à épuisement du stock
 - Lieferbar solange vorrat reicht
 - Suministrado hasta el stock termina



Ø=mm	h=mm	µF
18	25	0,25

ALFA ROMEO

ALFASUD 1.2	AR30102	06/72 ⇨ 09/84
ALFETTA 1.8	AR01608X	07/74 ⇨ 04/82
GIULIETTA 1.3	AR01644	10/77 ⇨ 06/83

FIAT

127 0.9	100GL.048	06/71 ⇨ 05/83
127 1.0	127A.000	01/77 ⇨ 12/86
131 1.3 Mirafiori	131A6.000	10/74 ⇨ 09/81

FIAT

132 1.6	132C.000	05/77 ⇨ 09/82
ARGENTA 1600	132D.000	04/81 ⇨ 12/85
ARGENTA 1600 i.e	132D.000	04/81 ⇨ 12/85
FIORINO 1 1.0	127A.000	01/80 ⇨ 12/87
FIORINO 1 1050	127A.000	01/80 ⇨ 12/87
FIORINO 1 900	100GL.000	10/77 ⇨ 10/86
PANDA 1 800	100GL6.000	02/81 ⇨ 12/85
PANDA 1 950	A112B1.054	09/82 ⇨ 08/83
PANDA 1 950 4x4	A112B1.054	09/83 ⇨ 12/86

SEAT

FURA 0.9	100GL3000	01/82 ⇨ 06/86
PANDA 34 850	--	01/80 ⇨ 12/83
PANDA 35 850	--	01/80 ⇨ 12/83

EPS 1.130.127



CONDENSERS

Adatt./Suitable: **MARELLI****FIAT**
9938268**MAGNETI MARELLI**
CE 39 P

- ⁰³ Supplied until depletion
- Fornibile fino ad esaurimento delle scorte
 - Fourni jusqu'à épuisement du stock
 - Lieferbar solange vorrat reicht
 - Suministrado hasta el stock termina



Ø=mm	h=mm	µF
18	25	0,25

FIAT

REGATA 1.6	149A.000	10/84 ⇨ 06/89
REGATA 70 1.3	138B2.000, 149A3.000	09/83 ⇨ 07/89
REGATA 85 1.6	149A.000	10/83 ⇨ 06/90
UNO 60 1.1 SX	--	01/83 ⇨ 12/85

EPS 1.130.128



CONDENSERS

Adatt./Suitable: **MARELLI****FIAT**
9938269**MAGNETI MARELLI**
CE 39 R**SEAT**
SE 141914.007A

- ⁰³ Supplied until depletion
- Fornibile fino ad esaurimento delle scorte
 - Fourni jusqu'à épuisement du stock
 - Lieferbar solange vorrat reicht
 - Suministrado hasta el stock termina



Ø=mm	h=mm	µF
18	25	0,25

FIAT

126 700	126A2.000, 126A2.048	09/87 ⇨ 06/96
PANDA 1 750	141B.000	01/86 ⇨ 01/95
PANDA 1 900	100GL3.000	10/80 ⇨ 06/94
PANDA 1 900 CL	146A.048	01/86 ⇨ 12/92
UNO 45 0.9	146A.000, 146A1.000	03/83 ⇨ 07/96
UNO 45 0.9 Trend	146A.048	09/89 ⇨ 09/92

FSO

126P 0.6	126A1.048	07/77 ⇨ 12/91
----------	-----------	---------------

SEAT

IBIZA 1 0.9	146A000	08/86 ⇨ 05/93
MARBELLA 0.9	09NCA	01/87 ⇨ 12/93
TERRA 0.9	09NCA	02/87 ⇨ 12/96

1.131.131

EPS 1.131.131



1

CONDENSERS

Adatt./Suitable: **MITSUBISHI****BOSCH**

F 005 X04 582

NISSAN

22102-01M11

⁰³ Supplied until depletion

- Fornibile fino ad esaurimento delle scorte
- Fourni jusqu'à épuisement du stock
- Lieferbar solange vorrat reicht
- Suministrado hasta el stock termina



Ø=mm	h=mm	µF
15	23	0,22

NISSAN

VANETTE II 2.0

Z20S, Z20S

07/87 ⇨ 08/94

EPS 1.142.056



1

CONDENSERS

Adatt./Suitable: **SEV****BOSCH**

0 190 309 009

1 237 330 810

1 237 330 811

DAF

200889

GENERAL MOTORS

7 992 253

7 992 680

7 992 850

7 992 852

MAGIRUS-DEUTZ

1169097

MAN

90.80110-1111

MERCEDES-BENZ

A 001 154 43 06

A 001 154 48 06

PEUGEOT

5948 04

RENAULT

08 02 119 800

08 51 877 600

08 54 233 000

08 54 910 100

08 54 923 300

08 54 943 800

77 01 000 998

77 01 008 855

77 01 012 471

77 01 021 676

⁰⁰ Eliminated on 10-12-2021. Please verify the availability through our local distributors

- Eliminato il 10-12-2021. Verificare la disponibilità presso i nostri distributori

- Éliminé le 10-12-2021. Vérifier la disponibilité auprès de nos distributeurs sur place

- Am 10-12-2021 gestrichen. Evtl. Verfügbarkeit bitte bei unseren Händlern prüfen

- Eliminado en fecha 10-12-2021. Verificar la disponibilidad a través de nuestros distribuidores locales



Ø=mm	h=mm	µF
17	38,5	0,23

RENAULT

4 0.8

800705

10/83 ⇨ 10/88



CONTACT SETS

-COPPIE CONTATTI -RUPTEURS -KONTAKTSÄTZE -PLATINOS

(A) P/NRS. - NOTES

- CODICI - NOTE
- RÉFS. - NOTES
- ARTIKEL-NR. - ANMERKUNGEN
- CODIGOS - NOTAS

1.230.140 1

CONTACT SETS

Adatt./Suitable: **MARELLI**

FIAT
8660
9919623
9919723

MAGNETI MARELLI
711 185 01
711 985 01

RENAULT
77 02 038 190

ZASTAVA
1335052

Ventilated contact set:

- Contatti ventilati:
- Rupteur en version ventilée:
- Belüfteter Kontaktsatz:
- Juego platinos ventilados:

1.230.140HV

(A) # EPS

2 OEM P/NRS.

- CODICI ORIGINALI
- RÉFS. D'ORIGINE
- ORIGINALTEILE-NR.
- CODIGOS ORIGINALES

3 PACKAGING SIZE

- FORMATO CONFEZIONE
- FORMAT DU CONDITIONNEMENT
- ABPACKENSGROSSE
- TAMAÑO DEL ENVASE

4 NOTE

- NOTE
- NOTES
- BEMERKUNGEN
- NOTAS

(B) PICTURE + TECHNICAL INFO

- FOTO + INFORMAZIONE TECNICA
- ILLUSTRATION + INFORMATION TECHNIQUE
- BILD + TECHNISCHE INFO
- FOTO + INFORMACIÓN TÉCNICA

(C) APPLICATION LIST

- GUIDA APPLICAZIONI
- LISTE D'APPLICATIONS
- ANWENDUNGSTABELLE
- LISTA DE APLICACIONES

FIAT		
X 1/9 1.3	128A5.000	10/75 ⇨ 06/78
ZASTAVA		
101 1.1	128A.000, 128A.064	05/75 ⇨ 12/93
101 1.1 Super	128AC5.000	07/79 ⇨ 09/81
YUGO 0.9	9A, 9A	04/80 ⇨ 06/92

(B)

1 PICTURE

- FOTO
- PHOTO
- BILD
- FOTO

EPS 1.201.005



CONTACT SETS

Adatt./Suitable: ACME

ACME

1002
101.300
711.101.300

EPS 1.201.006



CONTACT SETS

Adatt./Suitable: ACME

ACME

005.300
3186
711.005.300

EPS 1.206.021



CONTACT SETS

Adatt./Suitable: BOSCH

BOSCH

1 237 013 008

FORD

1 151 630 2
5 441 16
G 516 302

GENERAL MOTORS

7 992 221

MERCEDES-BENZ

A 000 158 20 90

PORSCHE

616 602 226 00

VOLVO

238036
2380368
238859
2388593

- ⁰³ Supplied until depletion
- Fornibile fino ad esaurimento delle scorte
 - Fourni jusqu'à épuisement du stock
 - Lieferbar solange vorrat reicht
 - Suministrado hasta el stock termina



FORD

TAUNUS 12M 1.2	--	12/51 ⇒ 04/67
TAUNUS 12M 1.5	--	09/58 ⇒ 04/67
TAUNUS 12M 1.5 TS	--	12/62 ⇒ 04/67
TAUNUS 15M 1.5	--, TV15H	09/54 ⇒ 07/71
TAUNUS 15M 1.5 XL/RS	--, TV15H	01/68 ⇒ 06/71
TAUNUS 17M 1.5	--	09/60 ⇒ 10/68
TAUNUS 17M 1.7	--	08/57 ⇒ 04/74
TAUNUS 17M 1.7 S	--	09/60 ⇒ 01/65
TRANSIT I 1.5	--	06/58 ⇒ 08/65
TRANSIT I 1250 S-2 Klein-LKW	--	10/57 ⇒ 07/67
TRANSIT I K-40 1.5	--	04/55 ⇒ 04/67

MERCEDES-BENZ

CLASSE S I 250 SE	M129.980	01/66 ⇒ 12/67
-------------------	----------	---------------

MERCEDES-BENZ

CLASSE SL III 300 SL	M103.982	09/85 ⇒ 08/89
COUPE 250 SE	M129.980, M129.981	01/65 ⇒ 12/67
COUPE 280 SE	M130.980, M130.984	01/67 ⇒ 12/71
HECKFLOSSE 200	M121.940	07/65 ⇒ 02/68
PAGODE 250 SL	M129.982	01/66 ⇒ 01/68

VOLVO

140 1.8	B18A	08/66 ⇒ 07/68
140 1.8 S	B18A	08/66 ⇒ 07/68
P 121 1.8	B18, B18A	05/59 ⇒ 05/71
P 122 S AMAZON 1.8	B18	05/59 ⇒ 07/67
PV 544 1.8	B18A	08/61 ⇒ 07/67

EPS 1.206.029HV



CONTACT SETS

Adatt./Suitable: BOSCH

BOSCH

1 237 013 006

FIAT

9927624

MERCEDES-BENZ

A 000 158 07 90
A 000 158 18 90

OPEL

16 12 006
RP121202

VOLVO

233910
2339109

VW

SP 183
SP 184
111 998 053
111 998 055
181 998 053
892 031 090

ALFA ROMEO

GIULIA 1300 Super	AR00530	01/74 ⇒ 12/78
GIULIA 1300 TI	--	04/69 ⇒ 07/75

AUDI

90 SUPER 1.8	21, 8921	09/66 ⇒ 08/71
--------------	----------	---------------

BMW

1500-2000 1600	M10B16(16A)	04/64 ⇒ 04/68
1500-2000 1800	M118	08/63 ⇒ 09/69
1500-2000 1800 Ti	M118	10/63 ⇒ 04/68
1500-2000 2000 Ti / Tilux	18F209	01/66 ⇒ 07/72
1502-2002 1600 Ti	M10B16(16A)	09/67 ⇒ 11/69
1502-2002 2002	18F209	02/68 ⇒ 07/75
1502-2002 2002 Ti	18F209	06/68 ⇒ 04/72
1502-2002 2002 Tii	18F209	01/71 ⇒ 07/75
1600 GT 1.6	M10B16(16A)	10/67 ⇒ 05/69
2000 CS	18F209	10/65 ⇒ 06/70

MERCEDES-BENZ

/8 230.6	M180.954	01/68 ⇒ 11/76
/8 250	M114.920	01/68 ⇒ 08/72
/8 250 C	M114.920	04/69 ⇒ 06/72
/8 250 CE	M114.980	04/69 ⇒ 04/72
/8 280	M110.921	06/72 ⇒ 11/76
/8 280 C	M110.921	06/72 ⇒ 02/77
CLASSE S I 280 S	M110.922	08/72 ⇒ 07/80
CLASSE SL I 190 SL	M121.921, M121.928	01/55 ⇒ 12/63
HECKFLOSSE 190 C	M121.924	04/61 ⇒ 08/65
HECKFLOSSE 200	M121.940	07/65 ⇒ 02/68
PONTON 190 b	M121.920	06/59 ⇒ 12/61

OPEL

ADMIRAL 2.6 S	26S	04/64 ⇒ 09/65
---------------	-----	---------------

YUGO

311 1.1	128A4	04/83 ⇒ 04/91
511 1.1	128A4	04/83 ⇒ 04/91

EPS 1.206.032HV



CONTACT SETS

Adatt./Suitable: BOSCH

BOSCH

1 237 013 039

GENERAL MOTORS

7 992 222

VW

SP 186
111 998 059⁰³ Supplied until depletion

- Fornibile fino ad esaurimento delle scorte
- Fourni jusqu'à épuisement du stock
- Lieferbar solange vorrat reicht
- Suministrado hasta el stock termina



VW

1500,1600 1.5	K	04/61 ⇒ 07/73
1500,1600 1.5 S	--	08/63 ⇒ 07/65
1500,1600 1.6 TL	T	08/65 ⇒ 07/73
KAEFER 1500 1.5	45C20M150Q6	08/66 ⇒ 11/73

EPS 1.206.034HVS



CONTACT SETS

Adatt./Suitable: BOSCH

ALFA ROMEO

700 220
140 20 05 011 00/01
60739126

BMW

12 11 1 243 843
12 11 1 267 391
12 11 1 267 393
12 11 1 354 502
12 11 1 359 705
12 11 1 359 873
12 11 1 360 648
12 11 1 361 760
12 11 8 730 024

BOSCH

1 237 013 044
9 232 081 044

DAF

163791
509890

FIAT

7073052
82305235

FORD

4 641 63
77HF-12107-AA

MERCEDES-BENZ

0001582890
0001583790
A 000 158 23 90
A 000 158 24 90
A 000 158 40 90
A 607 158 00 90

OPEL

12 16 011
16 12 011
16 12 385
RP 1 212 007

PEUGEOT

5927 50

PORSCHE

177 860 820 20
616 602 223 00

RENAULT

77 02 037 711

SAAB

78 66 353

SEAT

NG9 810 442 9

TOYOTA

19145-40010C

VOLVO

1306169
13061692
241664
2416642
243460
245664
2456642

VW

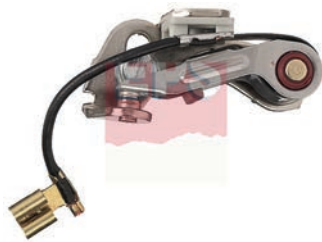
059 998 015
059 998 051
059 998 051 B
073 998 051
111 998 295
311 998 063
311 998 063 1

ALFA ROMEO

ALFASUD 1.2	AR30102	06/72 ⇨ 09/84
ALFETTA 1.8	AR01608X	07/74 ⇨ 04/82
GIULIETTA I 1.3	AR01644	10/77 ⇨ 06/83

FIAT (BR)

147 1.1	--	01/76 ⇨ 12/81
PREMIO	--	01/85 ⇨ 12/88
UNO 1.05	1.05	01/85 ⇨ 12/87
UNO 1.3	1.3	01/85 ⇨ 12/91
UNO 1.3 Furgoneta	1.3	01/85 ⇨ 12/91
UNO CS 1.3	1.3	01/85 ⇨ 12/91

FORD AUSTRALIA

CORTINA 2.0	--	06/77 ⇨ 08/82
ESCORT 2.0	--	01/77 ⇨ 12/81
ESCORT 2.0 RS	--	01/77 ⇨ 12/81

HOLDEN

COMMODORE 1.9	--	09/78 ⇨ 04/86
---------------	----	---------------

MERCEDES-BENZ

CLASSE G 1230 G	M115.973	03/79 ⇨ 07/93
CLASSE G 1280 GE	M110.994	11/79 ⇨ 08/89

OPEL

ASCONA C 1.3 N	13N	09/81 ⇨ 08/86
CORSA A 1.0	10S	09/82 ⇨ 03/93
CORSA A 1.2	12N, 12NC	09/82 ⇨ 08/90
CORSA A 1.2 N	12NC	01/85 ⇨ 10/87
KADETT B 1.1	11N	08/71 ⇨ 08/73
KADETT D 1.0	10N	09/79 ⇨ 08/82
KADETT E 1.2	12SC	09/84 ⇨ 07/86
MANTA B 1.3 N	13N	03/79 ⇨ 12/80
MANTA B 1.6 S	16S	09/75 ⇨ 12/81
MANTA B 1.9 N	19N	08/76 ⇨ 12/81
MANTA B 2.0	20N	08/77 ⇨ 12/80

PUCH

G-MODELL 280 GE	M110.994	01/86 ⇨ 12/91
-----------------	----------	---------------

VOLKSWAGEN (BR)

VWB 1.5	--	01/75 ⇨ 12/82
---------	----	---------------

VOLVO

240 1.8	B17A	11/78 ⇨ 07/85
---------	------	---------------

VW

JETTA II 1.6	EZ, HM	12/83 ⇨ 07/92
CADDY I 1.5	JB	08/82 ⇨ 07/83
CADDY I 1.6	EW, HN	01/83 ⇨ 07/92
GOLF II 1.6	EZ	08/83 ⇨ 07/92
GOLF II 1.6 [CHE] [SWE]	HM	08/83 ⇨ 07/85
LT I 2.4	DL	12/82 ⇨ 07/92
LT I 2.4 4WD	DL	12/82 ⇨ 07/92
LT I 2.4 i	1E	08/89 ⇨ 06/96
SCIROCCO I 1.1	FA	04/74 ⇨ 07/79
SCIROCCO I 1.5	JB	08/77 ⇨ 07/80
SCIROCCO II 1.6	1HyFAD	08/80 ⇨ 04/84

EPS 1.206.040



CONTACT SETS

Adatt./Suitable: BOSCH

BOSCH

1 237 013 057

GENERAL MOTORS

7 992 226
7 992 645

PEUGEOT

5927 30

RENAULT

77 01 200 876

VW

111 998 063

Eliminated on 28-09-2020. Please verify the availability through our local distributors

• Eliminato il 28-09-2020. Verificare la disponibilità presso i nostri distributori

• Éliminé le 28-09-2020. Vérifier la disponibilité auprès de nos distributeurs sur place

• Am 28-09-2020 gestrichen. Evtl. Verfügbarkeit bitte bei unseren Händlern prüfen

• Eliminado en fecha 28-09-2020. Verificar la disponibilidad a través de nuestros distribuidores locales



PEUGEOT

404 1.6	XC6	04/63 ⇨ 12/71
504 1.8	XM7	01/71 ⇨ 07/86
504 2.0	106(XN1)	03/71 ⇨ 07/86
504 2.0 TI	107(XN2)	01/71 ⇨ 06/83
505 1.8	105(XM7)	06/81 ⇨ 10/85
505 2.0	--, 106(XN1)	11/80 ⇨ 11/87

RENAULT

4 1.1	688712, C1E714, C1E719	06/78 ⇨ 06/90
5 1.0	689710	01/72 ⇨ 12/85
5 1.3	810725, 810726	09/75 ⇨ 09/84
5 1.4	847725, C2J713	01/82 ⇨ 12/85
5 1.4 Automatik	847712	06/82 ⇨ 09/84
12 1.3	810.02, 810.05, 810.06, 810-02/97	10/69 ⇨ 08/80
12 1.3 TS	810.05, 810.06	08/72 ⇨ 08/80
18 1.4	847720, 847722	04/78 ⇨ 07/86

VW

1500,1600 1.5 L	K	07/68 ⇨ 07/73
1500,1600 1.6 L	P	07/64 ⇨ 07/73
KAEFER 1.2	MS1	01/54 ⇨ 07/65
KAEFER 1200 1.2	D	01/60 ⇨ 12/85
KAEFER 1300 1.3	AB, E, F	01/65 ⇨ 01/73
KAEFER 1302 1.2	D	08/69 ⇨ 08/72
KAEFER 1302 1.3	AB, AC	08/70 ⇨ 07/75
KAEFER 1302 1.6	AD, AE, AF, AH, AK	01/70 ⇨ 07/74
KAEFER 1302,1303 1.6	AD	07/70 ⇨ 06/79

VW

KAEFER 1303 1.3	AB, AR	08/72 ⇨ 07/75
KAEFER 1303 1.6	AD, AE, AH, AK	08/70 ⇨ 12/79
KAEFER 1303 LS, S 1.6	AD, AJ, AS	08/72 ⇨ 12/79
KAEFER 1500 1.5	45C20M150Q6	01/66 ⇨ 12/70
KAEFER 1500 1.6	AD	07/70 ⇨ 01/73

EPS 1.206.047



CONTACT SETS

Adatt./Suitable: BOSCH

BOSCH

1 237 013 000

FORD

1 154 411 5
G 509 193

GENERAL MOTORS

7 992 219
7 992 658

OPEL

16 12 005
RP121201

PORSCHE

616 602 226 02
901 602 960 03

VOLVO

240149
2401495

VW

SP 181
111 998 051**Eliminated on 26-10-2021. Please verify the availability through our local distributors**

• Eliminato il 26-10-2021. Verificare la disponibilità presso i nostri distributori

• Éliminé le 26-10-2021. Vérifier la disponibilité auprès de nos distributeurs sur place

• Am 26-10-2021 gestrichen. Evtl. Verfügbarkeit bitte bei unseren Händlern prüfen

• Eliminado en fecha 26-10-2021. Verificar la disponibilidad a través de nuestros distribuidores locales



ALFA ROMEO

1750-2000 1.7	AR10525	04/68 ⇨ 11/71
1750-2000 1750	AR00548	03/68 ⇨ 10/72
GIULIA 1600 Super	AR00526	06/64 ⇨ 08/69
GT 1.8	AR10525	04/68 ⇨ 11/71
GT 1300 Junior	AR00530	01/66 ⇨ 12/77
GT V 1750	AR00548	01/67 ⇨ 12/72
SPIDER I 1.7	AR10525	04/68 ⇨ 11/71
SPIDER I 1300	AR00530	01/68 ⇨ 12/77
SPIDER I 1600	AR00526, AR00536, AR01600	03/66 ⇨ 12/68
SPIDER I 1750	AR00548	01/67 ⇨ 12/71

PORSCHE

356 A 1600	--	01/55 ⇨ 12/59
356 A 1600 GS Carrera	--	01/55 ⇨ 12/61
356 A 1600 S	616.15	01/55 ⇨ 12/59
356 A 1600 Super	616.15	01/55 ⇨ 12/59
356 B 1600	--	09/59 ⇨ 08/63
356 B 1600 Super 75	616.15	01/59 ⇨ 12/63
356 B 1600 Super 90	--	01/59 ⇨ 12/63
356 C 1600	616.15	01/63 ⇨ 12/65
356 C 1600 SC	--	01/63 ⇨ 12/65
911 1.2.0 L	--	08/67 ⇨ 11/68
911 1.2.0 S	901.02, 901.08, 901.10	07/66 ⇨ 02/72
912 1.6	616.36, 616.39, 616.40	01/65 ⇨ 02/70

VOLVO

140 1.8 S	B18B	08/66 ⇨ 01/72
P 122 S AMAZON 1.8	B18, B18D	08/61 ⇨ 05/71
P 1800 1.8	--, B18A	04/62 ⇨ 05/70
P 1800 1.8 S	--	04/62 ⇨ 05/70
P 2200 1.8	B18A, B18B, B18D	09/64 ⇨ 08/67

EPS 1.206.049HVS



CONTACT SETS

Adatt./Suitable: **BOSCH****BMW**12 11 1 267 394
12 11 1 354 584
12 11 1 356 919**BOSCH**

1 237 013 052

FIAT00009049
38326146
638326146
82289883
AXE2055**FORD**0 464 163
0 548 495
1 154 849 5
1 568 737
1 584 304
1 584 305
5 018 844
5 019 831
5 484 95
6 138 918
77BF-12107-AA
77BF-12171-AA**MAN**

51.26310-0003

MERCEDES-BENZ0001582790
A 000 158 22 90
A 000 158 31 90**OPEL**

16 12 433

PEUGEOT

5927 65

PORSCHE

901 602 960 00

RENAULT

77 01 012 533

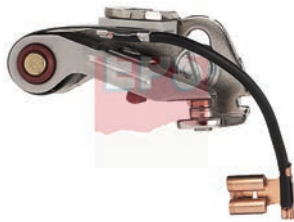
SAAB83 55 919
93 59 597**VOLVO**241652
2416527**VW**036 998 051
036 998 051 A
036 998 051 C
036 998 051 D
052 998 051
052 998 051 D

FORD		
ESCORT III 1.1	GSE	08/83 ⇒ 12/85
FIESTA I 0.9	TKA, TKW, TLA	05/76 ⇒ 08/83
FIESTA I 1.1	GLA, GLW	05/76 ⇒ 08/83
FIESTA II 1.1	GLC, GSF	09/83 ⇒ 02/89
TRANSIT II 1.6	LAC, LAT	09/85 ⇒ 09/92
TRANSIT II 2.0	NAT, NAV, NAW	09/85 ⇒ 09/92
TRANSIT II 2.0 L	NAW, NAX	10/85 ⇒ 03/91
INNOCENTI		
MINI 120	--	01/75 ⇒ 12/83
NISSAN		
200 B [AUS]	--	01/78 ⇒ 12/81
OPEL		
KADETT D 1.3 S	13S	08/79 ⇒ 08/84
VOLVO		
240 2.0	0JX4G20A6L	08/74 ⇒ 07/76
VW		
POLO II 1.0	GL	10/81 ⇒ 10/86
POLO II 1.1	HB	10/81 ⇒ 09/89
POLO II 1.3	GT, HH, HJ, HK, HW	10/81 ⇒ 07/88
JETTA II 1.3	GT, HK	01/84 ⇒ 06/87
DERBY 1.0	GL	10/81 ⇒ 12/84
DERBY 1.1	HB	02/77 ⇒ 09/81
DERBY 1.3	HH	02/77 ⇒ 09/81
GOLF I 1.3	HK	08/83 ⇒ 07/86
GOLF II 1.0	GN	11/83 ⇒ 08/85
GOLF II 1.3	GT, HK	08/83 ⇒ 06/87
SCIROCCO I 1.3	GF	08/79 ⇒ 07/80
SCIROCCO II 1.3	HK	08/83 ⇒ 07/84

EPS 1.206.060



CONTACT SETS

Adatt./Suitable: **BOSCH****BOSCH**

1 217 013 001

⁰³ Supplied until depletion

- Fornibile fino ad esaurimento delle scorte
- Fourni jusqu'à épuisement du stock
- Lieferbar solange vorrat reicht
- Suministrado hasta el stock termina



EPS 1.206.062



CONTACT SETS

Adatt./Suitable: **BOSCH****BMW**12 11 1 267 392
12 11 1 271 687
12 11 1 355 624**BOSCH**

1 237 013 075

GENERAL MOTORS

7 992 344

MERCEDES-BENZA 000 158 28 90
A 000 158 35 90
A 000 158 37 90
A 000 158 39 90**VOLVO**243801
2438018**VW**058 998 051
058 998 051 A
058 998 051 B

BMW		
3 I 320 i	18F209	06/75 ⇒ 08/82
2500-3.3.3.0 S	M30B30	05/71 ⇒ 04/77
MERCEDES-BENZ		
/8 280	M110.921	06/72 ⇒ 11/76
/8 280 C	M110.921	06/72 ⇒ 02/77
/8 280 CE	M110.981	06/72 ⇒ 01/77
/8 280 E	M110.981	06/72 ⇒ 11/76
PORSCHE		
911 I 2.7	911.41, 911.43, 911.46, 911.48, 911.81, 911.82, 911.84, 911.85, 911.86, 911.89, 911.90, 911.92, 911.94, 911.97, 911.99	09/73 ⇒ 06/77
911 I 2.7 S	911.42, 911.47, 911.93, 911.98	08/73 ⇒ 01/76
911 I 2.7 S Carrera	911.42, 911.47, 911.93, 911.98	08/73 ⇒ 01/76
911 I 2.7 SC Carrera RS	911.83	08/72 ⇒ 01/79

EPS 1.206.064



CONTACT SETS

Adatt./Suitable: **BOSCH****BOSCH**

1 217 013 009

⁰⁰ Eliminated on 06-07-2021. Please verify the availability through our local distributors

- Eliminato il 06-07-2021. Verificare la disponibilità presso i nostri distributori
- Éliminé le 06-07-2021. Vérifier la disponibilité auprès de nos distributeurs sur place
- Am 06-07-2021 gestrichen. Evtl. Verfügbarkeit bitte bei unseren Händlern prüfen
- Eliminado en fecha 06-07-2021. Verificar la disponibilidad a través de nuestros distribuidores locales



EPS 1.206.068



CONTACT SETS

Adatt./Suitable: **BOSCH****BOSCH**

1 217 013 021



EPS 1.206.071



CONTACT SETS

Adatt./Suitable: **BOSCH****MOTO GUZZI**

77 900 507 97

⁰³ Supplied until depletion

- Fornibile fino ad esaurimento delle scorte
- Fourni jusqu'à épuisement du stock
- Lieferbar solange vorrat reicht
- Suministrado hasta el stock termina



EPS 1.206.083



CONTACT SETS

Adatt./Suitable: BOSCH

BOSCH
1 217 013 020⁰³ Supplied until depletion

- Fornibile fino ad esaurimento delle scorte
- Fourni jusqu'à épuisement du stock
- Lieferbar solange vorrat reicht
- Suministrado hasta el stock termina



EPS 1.207.701



CONTACT SETS

Adatt./Suitable: CAJAVEC

CAJAVEC
5247810
ZASTAVA
46600861

ZASTAVA

101 1.1	128A.000	06/73 ⇒ 01/90
YUGO 0.9	9A	04/80 ⇒ 06/92

EPS 1.211.046



CONTACT SETS

Adatt./Suitable: DANSI

MOTO GUZZI
19 709 620

EPS 1.212.055HVS



CONTACT SETS

Adatt./Suitable: DELCO REMY

DELCO REMY
3 470 026

GENERAL MOTORS

03 470 026
3 470 026
90 010 696

OPEL

12 12 154
16 12 229
RP 1 212 154

VOLVO

3277840
32778409⁰³ Supplied until depletion

- Fornibile fino ad esaurimento delle scorte
- Fourni jusqu'à épuisement du stock
- Lieferbar solange vorrat reicht
- Suministrado hasta el stock termina



OPEL

CORSA A 1.0	10S	09/82 ⇒ 03/93
KADETT B 1.1	11N	08/71 ⇒ 08/73
KADETT D 1.0	10N	09/79 ⇒ 08/82
KADETT E 1.2	12SC	09/84 ⇒ 07/86

EPS 1.213.011HV



CONTACT SETS

Adatt./Suitable: DENSO

DAIHATSU

02935-00200
19145-26060-000
19145-87203-000
19145-87206-000
19145-87701
19145-87701-000
99329-35902

FIAT

553221203
6553202203
6553221203

HOLDEN

3314074010

SUZUKI

33140-74010
33140-74010-000

TOYOTA

04191-41010
19145-26060
19145-38011
19145-40010
19145-41010
19145-41020
19145-41030
19145-87701

VW

J19 145 260 60

^{**} Available contact set only-not plate

- Fornibile solo contatto, no piastra
- Disponible rupteur seul, pas le plateau
- Erhältlich nur unterbrecher, nicht die platte
- Disponible el platino solo, no la plancha



DAIHATSU

850 0.8	--	07/86 ⇒ 12/89
1000 1.0	CB10	07/86 ⇒ 12/89
CHARADE III 1.0	CB23, CB22	03/87 ⇒ 02/93
FEROZA 1.6i	--	01/84 ⇒ 12/89
HIJET I 1.0	CB	06/86 ⇒ 12/89

HOLDEN

SCURRY_NB 1.0 F10A 10/85 ⇒ 05/86

INNOCENTI

500 L; LS -- ⇒ 12/86
SMALL 990 -- 07/90 ⇒ 12/92

MARUTI

800 0.8 F8B 01/91 ⇒ 12/06

SUZUKI

ALTO I 0.8	F8A, F8B	06/82 ⇒ 08/84
SJ410 1.0	F10A	09/81 ⇒ 07/91
SUPER CARRY 1.0	F10A	10/85 ⇒ 03/99

VW

TARO 1.8	2Y	04/89 ⇒ 09/94
TARO 2.2	4Y	06/89 ⇒ 07/94
TARO 2.2 4x4	4Y	06/89 ⇒ 07/94

EPS 1.213.022HV



CONTACT SETS

Adatt./Suitable: DENSO

DAIHATSU

19103-87204-000
19145-87204-000
19145-87205-000

FIAT

6553206203

GENERAL MOTORS

93 150 904
94 208 408

ISUZU

8-94208403-0
8-94208408-0

SUBARU

39146-4302
39146-4312

TOYOTA

19145-10020
19145-14010
98989-01161⁰³ Supplied until depletion

- Fornibile fino ad esaurimento delle scorte
- Fourni jusqu'à épuisement du stock
- Lieferbar solange vorrat reicht
- Suministrado hasta el stock termina

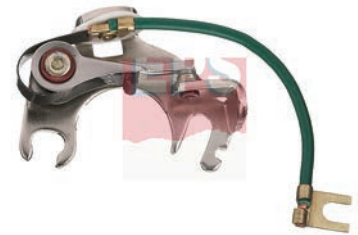

INNOCENTI

SMALL 500 -- 07/90 ⇒ 12/92

SUBARU

L-SERIES 1.3	--	01/87 ⇒ 12/91
M60 600	--	01/88 ⇒ 12/89
M70 700	--	01/88 ⇒ 12/89

EPS 1.215.055



CONTACT SETS

Adatt./Suitable: DUCELLIER

ALFA ROMEO

116 55 05 011 03/02
60730445

CHRYSLER

83 300 134

CITROËN

54 524 22G

DM 211-17

DUCELLIER

71 133

608 012

618 701

FIAT

9916118

PEUGEOT

5927 09

RENAULT

08 54 137 800

VOLVO

3100134

31001340

3267443

32674434



DACIA

1210 1.2	--	01/69 ⇒
1310 1.3	810-02/-99	05/83 ⇒ 07/04
1410 1.4	--	01/69 ⇒

FIAT

242 1.6 12483.000 10/75 ⇒ 07/82

1.215.056

PEUGEOT		
504 1.8 Injection	KF5, KF6	07/68 ⇒ 02/71
RENAULT		
4 0.8	800705	10/83 ⇒ 10/88

EPS 1.215.056



CONTACT SETS

Adatt./Suitable: **DUCELLIER**

CITROËN

54 463 39M

DUCELLIER

71 129

FIAT

9919038

9919040

9921039

GENERAL MOTORS

7 992 668

LEYLAND

GCS160

RENAULT

08 54 954 600

⁰⁰Eliminated on 15-01-2020. Please verify the availability through our local distributors

• Eliminato il 15-01-2020. Verificare la disponibilità presso i nostri distributori

• Éliminé le 15-01-2020. Vérifier la disponibilité auprès de nos distributeurs sur place

• Am 15-01-2020 gestrichen. Evtl. Verfügbarkeit bitte bei unseren Händlern prüfen

• Eliminado en fecha 15-01-2020. Verificar la disponibilidad a través de nuestros distribuidores locales



FIAT		
124 1200	124A.000	07/66 ⇒ 10/73
124 1400 Special	124B2.000	12/68 ⇒ 12/72
124 1600 Special T	132AC.000	01/73 ⇒ 07/75
850 0.8	100G.000	07/64 ⇒ 10/72

EPS 1.215.056HV



CONTACT SETS

Adatt./Suitable: **DUCELLIER**

⁰⁰Eliminated on 15-01-2020. Please verify the availability through our local distributors

• Eliminato il 15-01-2020. Verificare la disponibilità presso i nostri distributori

• Éliminé le 15-01-2020. Vérifier la disponibilité auprès de nos distributeurs sur place

• Am 15-01-2020 gestrichen. Evtl. Verfügbarkeit bitte bei unseren Händlern prüfen

• Eliminado en fecha 15-01-2020. Verificar la disponibilidad a través de nuestros distribuidores locales



FIAT		
128 1.1	128A.000	03/69 ⇒ 12/84
131 1.3 Mirafiori	131A6.000	10/74 ⇒ 09/81
132 1.6	132C.000	05/77 ⇒ 09/82

FIAT		
FIORINO 1 900	100GL.000	10/77 ⇒ 10/86

EPS 1.215.061



CONTACT SETS

Adatt./Suitable: **DUCELLIER**

DUCELLIER

71 974

GENERAL MOTORS

7 992 228

RENAULT

08 54 725 600

⁰³Supplied until depletion

• Fornibile fino ad esaurimento delle scorte

• Fourni jusqu'à épuisement du stock

• Lieferbar solange vorrat reicht

• Suministrado hasta el stock termina



RENAULT		
4 0.8	80001	09/71 ⇒ 12/88
5 1.3	810719	06/79 ⇒ 09/84

EPS 1.215.064



CONTACT SETS

Adatt./Suitable: **DUCELLIER**

CITROËN

54 747 41

AZ 211-17

DUCELLIER

23 263

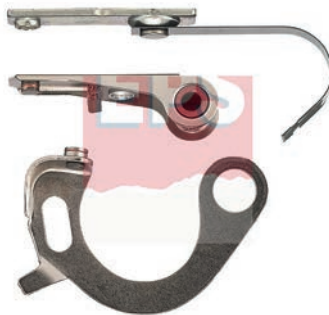

CITROËN		
2 CV 6	A06/635, A06/664	02/70 ⇒ 10/85
ACADIANE 6	M28(AM2)	08/78 ⇒ 10/88
DYANE 4	A79/1(AVA2)	04/68 ⇒ 07/75
MEHARI 0.6	M28/1(AK2)	05/68 ⇒ 10/79

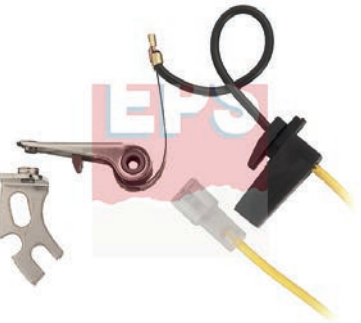

CONTACT SETS

Adatt./Suitable: **DUCELLIER**

DUCELLIER

608 640

⁰⁰Eliminated on 18-02-2022. Please verify the availability through our local distributors

• Eliminato il 18-02-2022. Verificare la disponibilità presso i nostri distributori

• Éliminé le 18-02-2022. Vérifier la disponibilité auprès de nos distributeurs sur place

• Am 18-02-2022 gestrichen. Evtl. Verfügbarkeit bitte bei unseren Händlern prüfen

• Eliminado en fecha 18-02-2022. Verificar la disponibilidad a través de nuestros distribuidores locales

L = mm

700

EPS 1.215.076



CONTACT SETS

Adatt./Suitable: **DUCELLIER**

CITROËN

79 015 927 44

DUCELLIER

618 015

GENERAL MOTORS

7 992 346

PEUGEOT

5927 43

5927 44

⁰⁰ Eliminated on 18-02-2022. Please verify the availability through our local distributors

- Eliminato il 18-02-2022. Verificare la disponibilità presso i nostri distributori

- Éliminé le 18-02-2022. Vérifier la disponibilité auprès de nos distributeurs sur place

- Am 18-02-2022 gestrichen. Evtl. Verfügbarkeit bitte bei unseren Händlern prüfen

- Eliminado en fecha 18-02-2022. Verificar la disponibilidad a través de nuestros distribuidores locales



L = mm

260

PEUGEOT

104 0.9	108(XV3), 108(XV5)	10/72 ⇨ 10/83
104 1.1	109(XW3)	07/76 ⇨ 06/83

EPS 1.215.086



CONTACT SETS

Adatt./Suitable: **DUCELLIER**

CHRYSLER

83 300 133

CITROËN

95 534 913

DUCELLIER

582 018

GENERAL MOTORS

93 150 077

RENAULT

77 01 200 739

⁰³ Supplied until depletion

- Fornibile fino ad esaurimento delle scorte

- Fourni jusqu'à épuisement du stock

- Lieferbar solange vorrat reicht

- Suministrado hasta el stock termina



RENAULT

5 1.3	810726	09/76 ⇨ 09/79
20 2.0	829700, 829701, 829702, 829703, 829.01	10/77 ⇨ 12/83

EPS 1.215.101



CONTACT SETS

Adatt./Suitable: **DUCELLIER**

DUCELLIER

618 642

618 765

FIAT

9935150

⁰³ Supplied until depletion

- Fornibile fino ad esaurimento delle scorte

- Fourni jusqu'à épuisement du stock

- Lieferbar solange vorrat reicht

- Suministrado hasta el stock termina

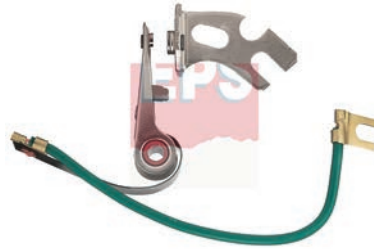

DACIA

ARO 10 -- 01/72 ⇨ 12/80

FIAT

127 0.9 100GL.048 06/71 ⇨ 05/83

LANCIA

A 112 0.9 Junior A112A5.000 03/81 ⇨ 06/86

EPS 1.215.102



CONTACT SETS

Adatt./Suitable: **DUCELLIER**

DUCELLIER

582 130

PEUGEOT

5927 73

⁰⁰ Eliminated on 14-04-2020. Please verify the availability through our local distributors

- Eliminato il 14-04-2020. Verificare la disponibilità presso i nostri distributori

- Éliminé le 14-04-2020. Vérifier la disponibilité auprès de nos distributeurs sur place

- Am 14-04-2020 gestrichen. Evtl. Verfügbarkeit bitte bei unseren Händlern prüfen

- Eliminado en fecha 14-04-2020. Verificar la disponibilidad a través de nuestros distribuidores locales



L = mm

240

PEUGEOT

305 1.5 117(XR5S) 05/80 ⇨ 09/82

EPS 1.215.103



CONTACT SETS

Adatt./Suitable: **DUCELLIER**

CITROËN

79 015 927 83

DUCELLIER

582 133

PEUGEOT

5927 83

5927 96

⁰⁰ Eliminated on 22-02-2021. Please verify the availability through our local distributors

- Eliminato il 22-02-2021. Verificare la disponibilità presso i nostri distributori

- Éliminé le 22-02-2021. Vérifier la disponibilité auprès de nos distributeurs sur place

- Am 22-02-2021 gestrichen. Evtl. Verfügbarkeit bitte bei unseren Händlern prüfen

- Eliminado en fecha 22-02-2021. Verificar la disponibilidad a través de nuestros distribuidores locales



L = mm

250

PEUGEOT

104 0.9 108(XV5) 10/79 ⇨ 10/83

TALBOT

SAMBA 1.1 XW7 01/81 ⇨ 06/86

EPS 1.215.105



1

CONTACT SETS

Adatt./Suitable: **DUCELLIER****DUCELLIER**

582 156

FIAT

9937709

PEUGEOT

5927 92

⁰³ Supplied until depletion

- Fornibile fino ad esaurimento delle scorte
- Fourni jusqu'à épuisement du stock
- Lieferbar solange vorrat reicht
- Suministrado hasta el stock termina



L = mm

650

FIAT			
DUCATO I 1.8	169B	01/82 ⇨	12/88
PEUGEOT			
505 1.8	105(XM7)	06/81 ⇨	10/85
J9 1.6	XC7P	03/80 ⇨	06/87

EPS 1.215.106



1

CONTACT SETS

Adatt./Suitable: **DUCELLIER****DUCELLIER**

582 186

582 191

582 199

FIAT

9936677

⁰³ Supplied until depletion

- Fornibile fino ad esaurimento delle scorte
- Fourni jusqu'à épuisement du stock
- Lieferbar solange vorrat reicht
- Suministrado hasta el stock termina



L = mm

200

FIAT			
PANDA I 800	100GL6.000	02/81 ⇨	12/85
RITMO I 1.3	149A3.000	11/83 ⇨	08/85
RITMO II 75 1.5	138A2.000	09/85 ⇨	12/88

SEAT

PANDA 34 850	--	01/80 ⇨	12/83
PANDA 35 850	--	01/80 ⇨	12/83

EPS 1.215.111U



1

CONTACT SETS

Adatt./Suitable: **DUCELLIER****DUCELLIER**

608 514

⁰⁰ Eliminated on 18-02-2022. Please verify the availability through our local distributors

- Eliminato il 18-02-2022. Verificare la disponibilità presso i nostri distributori
- Éliminé le 18-02-2022. Vérifier la disponibilité auprès de nos distributeurs sur place
- Am 18-02-2022 gestrichen. Evtl. Verfügbarkeit bitte bei unseren Händlern prüfen
- Eliminado en fecha 18-02-2022. Verificar la disponibilidad a través de nuestros distribuidores locales

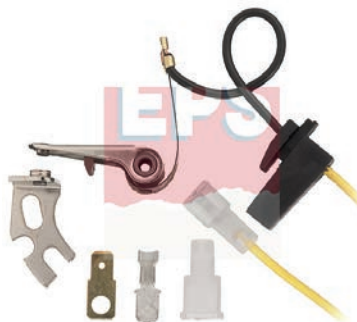
**PEUGEOT**

204 1.1	XX, XK4, XK5	10/65 ⇨	07/77
204 1.1 Grand Luxe	XK4	05/69 ⇨	10/77

PEUGEOT

504 1.8 XM7 01/71 ⇨ 07/86

TALBOT

MATRA BAGHEERA 1.3 3G4 01/74 ⇨ 03/78

EPS 1.215.112U



1

CONTACT SETS

Adatt./Suitable: **DUCELLIER****DUCELLIER**

608 719

PEUGEOT

5927 35

⁰⁰ Eliminated on 22-02-2021. Please verify the availability through our local distributors

- Eliminato il 22-02-2021. Verificare la disponibilità presso i nostri distributori
- Éliminé le 22-02-2021. Vérifier la disponibilité auprès de nos distributeurs sur place
- Am 22-02-2021 gestrichen. Evtl. Verfügbarkeit bitte bei unseren Händlern prüfen
- Eliminado en fecha 22-02-2021. Verificar la disponibilidad a través de nuestros distribuidores locales



EPS 1.215.122



1

CONTACT SETS

Adatt./Suitable: **DUCELLIER****DUCELLIER**

582 309

FIAT

9938573



L = mm

215

FIAT			
PANDA I 750	141B.000	01/86 ⇨	01/95
PANDA I 900	100GL3.000	10/80 ⇨	06/94
PANDA I 900 CL	146A.048	01/86 ⇨	04/91
UNO 45 0.9	146A.000, 146A1.000	03/83 ⇨	07/96
UNO 45 0.9 Trend	146A.048	09/89 ⇨	09/92

EPS 1.215.126



3

CONTACT SETS

Adatt./Suitable: **DUCELLIER****DUCELLIER**582 482 *P
2 590 166 *P**RENAULT**
77 01 031 149 *P
77 01 032 418 *P***P Kit Condenser - Contact set**

- Kit Condensatore - Contatto
- Kit Condensateur - Rupteur
- Bausatz Kondensator - unterbrecher
- Juego Condensador - Platino

03 Supplied until depletion

- Fornibile fino ad esaurimento delle scorte
- Fourni jusqu'à épuisement du stock
- Lieferbar solange vorrat reicht
- Suministrado hasta el stock termina



Ø = mm	h = mm	µF
17	38,5	0,23

RENAULT

9 1.1	C1E715	09/81 ⇒ 05/87
9 1.2	C1G700, C1G710	09/85 ⇒ 12/88
11 1.1	C1E715, C1E720	03/83 ⇒ 06/86
11 1.2	C1G700, C1G710	10/84 ⇒ 12/88
19 1.4	C1J	01/89 ⇒ 12/92
CLIO 1.1	C1E700	01/91 ⇒ 09/98
EXPRESS 955	C1C	01/85 ⇒ 10/90

EPS 1.215.127



3

CONTACT SETS

Adatt./Suitable: **DUCELLIER****RENAULT**

77 01 031 411 *P

***P Kit Condenser - Contact set**

- Kit Condensatore - Contatto
- Kit Condensateur - Rupteur
- Bausatz Kondensator - unterbrecher
- Juego Condensador - Platino

03 Supplied until depletion

- Fornibile fino ad esaurimento delle scorte
- Fourni jusqu'à épuisement du stock
- Lieferbar solange vorrat reicht
- Suministrado hasta el stock termina



Ø = mm	h = mm	µF
17	38,5	0,23

RENAULT

EXPRESS 1.1 | C1E | 01/85 ⇒ 10/90

EPS 1.217.020



1

CONTACT SETS

Adatt./Suitable: **FEMSA****FEMSA**

23373- 1

FIAT

9936823

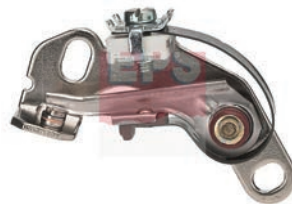
SEATNGO 020 010 6
SE 127914.006A**FIAT**

127 0.9	100GL.048	06/71 ⇒ 05/83
131 1.3 Mirafiori	131A6.000	10/74 ⇒ 09/81
132 1.6	132C.000	05/77 ⇒ 09/82
PANDA I 800	100GL6.000	02/81 ⇒ 12/85

SEAT

FURA 0.9	100GL3000	01/82 ⇒ 06/86
MARBELLA 0.8	5K9K718	08/86 ⇒ 12/93
PANDA 34 850	--	01/80 ⇒ 12/83
PANDA 35 850	--	01/80 ⇒ 12/83

EPS 1.217.024



1

CONTACT SETS

Adatt./Suitable: **FEMSA****FEMSA**

33924- 2

LAND ROVER
00000A.00071**RENAULT**

77 02 124 314

00 Eliminated on 12-04-2021. Please verify the availability through our local distributors

- Eliminato il 12-04-2021. Verificare la disponibilità presso i nostri distributori
- Éliminé le 12-04-2021. Vérifier la disponibilité auprès de nos distributeurs sur place
- Am 12-04-2021 gestrichen. Evtl. Verfügbarkeit bitte bei unseren Händlern prüfen
- Eliminado en fecha 12-04-2021. Verificar la disponibilidad a través de nuestros distribuidores locales

**RENAULT**

4 0.8 | 80001 | 09/71 ⇒ 12/88

EPS 1.217.026



1

CONTACT SETS

Adatt./Suitable: **FEMSA****FEMSA**

33924- 4

RENAULT
77 02 163 081**03 Supplied until depletion**

- Fornibile fino ad esaurimento delle scorte
- Fourni jusqu'à épuisement du stock
- Lieferbar solange vorrat reicht
- Suministrado hasta el stock termina

**RENAULT**

4 1.1	688712	02/78 ⇒ 06/90
9 1.2	C1G700, C1G710	09/85 ⇒ 12/88
11 1.2	C1G700, C1G710	10/84 ⇒ 12/88
11 1.7	F2N700	10/83 ⇒ 12/87
EXPRESS 1.1	C1E	01/85 ⇒ 10/90
EXPRESS 955	C1C	01/85 ⇒ 10/90

EPS 1.219.043HV



CONTACT SETS

Adatt./Suitable: **FORD****FORD**

1 458 944
681F-12107-AA
C3DF-12171-A
C3DZ-12171-A
C5AZ-12171-A
C6AH-12171-A

⁰³ Supplied until depletion

- Fornibile fino ad esaurimento delle scorte
- Fourni jusqu'à épuisement du stock
- Lieferbar solange vorrat reicht
- Suministrado hasta el stock termina

Motorcraft
EDP 1



FORD		
CORTINA 1300	KL13H	10/70 ⇒ 03/72
FIESTA I 0.9	TKA, TKW, TLA	05/76 ⇒ 08/83
FIESTA I 1.3	J3E	08/77 ⇒ 08/83

EPS 1.219.044HV



CONTACT SETS

Adatt./Suitable: **FORD****FORD**

1 458 945
5 027 482
6 234 60
682F-12107-AA
920X-12107-BA
C6CH-12171-A

⁰³ Supplied until depletion

- Fornibile fino ad esaurimento delle scorte
- Fourni jusqu'à épuisement du stock
- Lieferbar solange vorrat reicht
- Suministrado hasta el stock termina

GENERAL MOTORS
7 992 202

Motorcraft
EDP 2



FORD		
TAUNUS 1.6	LCJ	07/79 ⇒ 07/82
TRANSIT I 1.6	4RB	11/77 ⇒ 10/86
TRANSIT I 2.0	4RC	11/77 ⇒ 07/82

EPS 1.222.056HV



CONTACT SETS

Adatt./Suitable:

BOSCH

1 987 231 004
1 987 231 904
F 005 X04 543

⁰³ Supplied until depletion

- Fornibile fino ad esaurimento delle scorte
- Fourni jusqu'à épuisement du stock
- Lieferbar solange vorrat reicht
- Suministrado hasta el stock termina

DAIHATSU

19145-87301

FORD

A720-X12171-EA
A730-X12171-BA

GENERAL MOTORS

7 992 340
94 022 297

HITACHI

4461-13301
44613330
4461-3330 A
4461-4330 AY
44A5-13301
44A513301Z
44AZ-13301

HOLDEN

GH203

HONDA

30105-590-075
30105-634-005
30105-634-0051
30105-657-005
30105-679-005
33105-590-075

ISUZU

2-23115-15
8-23115-14
8-23115-15
9-40222-97
9-82311515-0
9-82311518-0

Motorcraft

ADP 5007

NISSAN

22145-18005
22145-71301
22145-78506
22145-U6001
22145-U6002

SUBARU

49146-7011
89146-4111
89146-4821



HOLDEN		
ASTRA_LB 1.5	E15	08/84 ⇒ 01/86
NISSAN		
PATROL III 2.8	L28	07/80 ⇒ 08/88
SUBARU		
L-SERIES 1.3	--	01/79 ⇒ 12/87

EPS 1.227.093



CONTACT SETS

Adatt./Suitable: **LOMBARDINI**

EPS 1.228.083MHV



CONTACT SETS

Adatt./Suitable: **LUCAS****FIAT**

31322118
631322118

FORD

EOTA 12 160
EOTA 12 162 C
EOTA 12 199 C

LAND ROVER

269987
RTC3270
RTC3313
RTC3881

Motorcraft

ADP 1



ASTON MARTIN		
DB6 4.0	--, AJ6	10/64 ⇒ 12/70
AUSTIN		
1000-SERIES 1100	--	01/70 ⇒ 12/74
1000-SERIES 1300	--	01/70 ⇒ 12/74
1000-SERIES 1300 GT	--	01/70 ⇒ 12/74
ALLEGRO 1.3	12H	05/73 ⇒ 03/82
ALLEGRO 1.5 Super	14H	05/73 ⇒ 03/82
MAXI 1500	--, 14H	04/69 ⇒ 07/80
MAXI 1750	17H	04/69 ⇒ 10/80
MAXI 1750 HL	--, 17LA	10/72 ⇒ 10/80
MINI 1000	99H	10/67 ⇒ 09/84
MINI 1275 GT	12H	10/69 ⇒ 08/80
FORD		
CORTINA 1200	--	10/62 ⇒ 09/66
CORTINA 1500	--	10/62 ⇒ 09/66
CORTINA GT	--	10/62 ⇒ 09/66
JAGUAR		
E-TYPE 4.2	XK4.2(82-87)	05/64 ⇒ 09/70
II 240	--	09/59 ⇒ 10/69
II 340	--	09/55 ⇒ 10/70
LAND ROVER		
88/109 2.3 4x4	10H, 11H	09/61 ⇒ 12/86
MG		
MAGNETTE 1.6	--	03/61 ⇒ 09/68
MGB 1.8	--	05/62 ⇒ 12/80
MGB GT 1.8	--, 18G	07/65 ⇒ 11/80
MORRIS		
MARINA 1.8	--	04/71 ⇒ 12/79
MARINA 1.8 TC	--	04/71 ⇒ 09/75
MARINA 1300	--	04/71 ⇒ 06/80
MARINA 1800	--	04/71 ⇒ 12/75
MARINA 1800 TC	--	04/71 ⇒ 12/75
ROVER		
2000-3500 2200	--	10/73 ⇒ 05/76
A60 CAMBRIDGE 1.7	--	01/62 ⇒ 10/69
TRIUMPH		
HERALD 1200	--, AJM	01/61 ⇒ 10/67
TR 6 2.5	CF1	01/72 ⇒ 12/76
WOLSELEY		
HORNET 1.0	--, 99LFD	01/61 ⇒ 12/70

EPS 1.228.089



CONTACT SETS

Adatt./Suitable: **LUCAS****FORD**
6 087 381
815F-12171-CA**JAGUAR**
JLM 9522**LAND ROVER**
RTC3282
RTC5946
RTC5947
RTC6627**RENAULT**
77 01 025 238**ROVER**
GCS124
RTC6627⁰⁰ Eliminated on 28-07-2021. Please verify the availability through our local distributors

- Eliminato il 28-07-2021. Verificare la disponibilità presso i nostri distributori
- Éliminé le 28-07-2021. Vérifier la disponibilité auprès de nos distributeurs sur place
- Am 28-07-2021 gestrichen. Evtl. Verfügbarkeit bitte bei unseren Händlern prüfen
- Eliminado en fecha 28-07-2021. Verificar la disponibilidad a través de nuestros distribuidores locales

²²¹ Replaces old code ..."HDV"

- Sostituisce vecchio codice ..."HDV"
- Remplace l'ancien modèle ..."HDV"
- Ersetzt alten Artikel ..."HDV"
- Sustituye el precedente modelo ..."HDV"

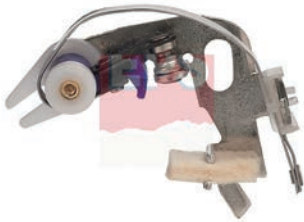

JAGUAR		
XJ 3.4 Series 3	--	01/86 ⇨ 12/94
LAND ROVER		
90 2.5 4x4	17H	09/85 ⇨ 08/90
110/127 2.5 4x4	17H	10/85 ⇨ 07/90
DEFENDER 2.25	--	01/87 ⇨
DEFENDER 2.5 90, 110	--	08/90 ⇨ 09/01
ROVER		
MINI 1.0	--	01/85 ⇨

EPS 1.230.096



CONTACT SETS

Adatt./Suitable: **MARELLI****MAGNETI MARELLI**
718 098 01⁰³ Supplied until depletion

- Fornibile fino ad esaurimento delle scorte
- Fourni jusqu'à épuisement du stock
- Lieferbar solange vorrat reicht
- Suministrado hasta el stock termina



EPS 1.230.120



CONTACT SETS

Adatt./Suitable: **MARELLI****FIAT**
9903324
9909413
9911552**MAGNETI MARELLI**
710 067 01**MOTO GUZZI**
12 715 445**SEAT**
007083.06

FIAT		
126 600	126A.000	09/72 ⇨ 06/77
500 0.5	110F.000, 120.000	01/60 ⇨ 12/75
500 0.6	111A000	08/68 ⇨ 01/76
600 0.6	--	03/55 ⇨ 05/61
PANDA I 650	141A.000	01/82 ⇨ 07/04
FSO		
126P 0.6	--	09/72 ⇨ 07/77

EPS 1.230.123



CONTACT SETS

Adatt./Suitable: **MARELLI****FIAT**
2194051
9911554**GENERAL MOTORS**
7 992 318**MAGNETI MARELLI**
701 184 01
710 070 01⁰³ Supplied until depletion

- Fornibile fino ad esaurimento delle scorte
- Fourni jusqu'à épuisement du stock
- Lieferbar solange vorrat reicht
- Suministrado hasta el stock termina

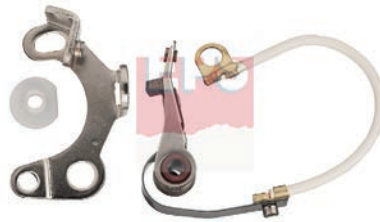

EPS 1.230.126



CONTACT SETS

Adatt./Suitable: **MARELLI****MAGNETI MARELLI**
718 097 01⁰⁰ Eliminated on 12-01-2021. Please verify the availability through our local distributors

- Eliminato il 12-01-2021. Verificare la disponibilità presso i nostri distributori
- Éliminé le 12-01-2021. Vérifier la disponibilité auprès de nos distributeurs sur place
- Am 12-01-2021 gestrichen. Evtl. Verfügbarkeit bitte bei unseren Händlern prüfen
- Eliminado en fecha 12-01-2021. Verificar la disponibilidad a través de nuestros distribuidores locales



EPS 1.230.127



CONTACT SETS

Adatt./Suitable: **MARELLI****ALFA ROMEO**
105 02 05 011 00/03
60710643**FIAT**
82205020
9911453
9912921
9912922**SEAT**
102541.06

FSO		
POLONEZ I 1.5	AA	10/77 ⇨ 08/88



EPS 1.230.132



CONTACT SETS

Adatt./Suitable: **MARELLI**

FIAT

9913862

MAGNETI MARELLI

710 650 01
711 985 02

PEUGEOT

00 600 665 00

PORSCHE

901 602 932 00

RENAULT

08 57 113 600
77 02 001 761

SEAT

000 389 117 3
121461.06
NG1 214 610 6
SE 141914.006B

TALBOT

0060 06 6500

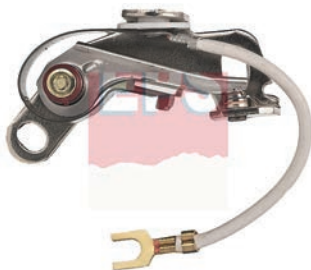

FIAT		
124 1200	124A.000	07/66 ⇒ 10/73
124 1400 Special	124B2.000	12/68 ⇒ 12/72
124 1600 Special T	132AC.000	01/73 ⇒ 07/75
850 0.8	100G.000	07/64 ⇒ 10/72

SEAT		
IBIZA I 0.9	146A000	08/86 ⇒ 05/93
MARBELLA 0.9	09NCA	01/87 ⇒ 12/93
PANDA 0.9	100GL3000	10/80 ⇒ 12/86
PANDA 45	--	01/82 ⇒ 12/85
TERRA 0.9	09NCA	02/87 ⇒ 12/96

EPS 1.230.139



CONTACT SETS

Adatt./Suitable: **MARELLI**

ALFA ROMEO

105 48 05 011 04/03
116 34 05 011 00/03
60714274
60727364

FIAT

3895010
7980793
82272761
8661
9919346
9920036
9925257
9929182

MOTO GUZZI

14 715 429

SEAT

233731.06
NG1 116 013 1
NG2 337 310 6

FIAT		
127 0.9	100GL.000	09/71 ⇒ 12/84
131 1.3 Mirafiori	131A6.000	10/74 ⇒ 09/81
132 1.6	132C.000	05/77 ⇒ 09/82
242 1.6	124B3.000	10/75 ⇒ 07/82
DUCCATO I 1.8	169B	01/82 ⇒ 12/88
ARGENTA 1600	132D.000	04/81 ⇒ 12/85
ARGENTA 1600 i.e	132D.000	04/81 ⇒ 12/85

MOTO GUZZI (I)

850 LeMans III	--	01/76 ⇒
850 T3 California	--	01/76 ⇒
850 T3,T4	--	01/76 ⇒
1000 SP	--	01/76 ⇒
V1000 Californiall	--	01/76 ⇒
V1000 Convert	--	01/76 ⇒
V1000 G5	--	01/76 ⇒

EPS 1.230.140



CONTACT SETS

Adatt./Suitable: **MARELLI**

FIAT

8660
9919623
9919723

MAGNETI MARELLI

711 185 01
711 985 01

RENAULT

77 02 038 190

ZASTAVA

1335052



FIAT		
X 1/9 1.3	128AS.000	10/75 ⇒ 06/78

ZASTAVA		
101 1.1	128A.000, 128A.064	05/75 ⇒ 12/93
101 1.1 Super	128AC5.000	07/79 ⇒ 09/81
YUGO 0.9	9A	04/80 ⇒ 06/92

EPS 1.230.140HV



CONTACT SETS

Adatt./Suitable: **MARELLI**

Eliminated on 20-09-2019. Please verify the availability through our local distributors

- Eliminato il 20-09-2019. Verificare la disponibilità presso i nostri distributori
- Éliminé le 20-09-2019. Vérifier la disponibilité auprès de nos distributeurs sur place
- Am 20-09-2019 gestrichen. Evtl. Verfügbarkeit bitte bei unseren Händlern prüfen
- Eliminado en fecha 20-09-2019. Verificar la disponibilidad a través de nuestros distribuidores locales

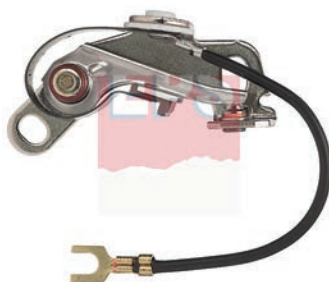

EPS 1.230.142



CONTACT SETS

Adatt./Suitable: **MARELLI**

CITROËN

54 862 21M

FIAT

9928255
9929188

MAGNETI MARELLI

711 975 01
711 975 02

SEAT

000 992 918 8
NG1 975 023 1
SE 127914.006B

FIAT		
127 0.9	100GL.048	06/71 ⇒ 05/83
127 1.0	127A.000	01/77 ⇒ 12/86
128 1.1	128A.000	03/69 ⇒ 12/84
131 1.3 Mirafiori	131A6.000	10/74 ⇒ 09/81
132 1.6	132C.000	05/77 ⇒ 09/82
ARGENTA 1600	132D.000	04/81 ⇒ 12/85
ARGENTA 1600 i.e	132D.000	04/81 ⇒ 12/85
FIORINO I 1.0	127A.000	01/80 ⇒ 12/87
FIORINO I 1050	127A.000	01/80 ⇒ 12/87
FIORINO I 900	100GL.000	10/77 ⇒ 10/86
PANDA 1800	100GL6.000	02/81 ⇒ 12/85
PANDA 1950	A112B1.054	09/82 ⇒ 08/83
PANDA 1950 4x4	A112B1.054	09/83 ⇒ 12/86

SEAT		
FURA 0.9	100GL3000	01/82 ⇒ 06/86
MARBELLA 0.8	5K9K718	08/86 ⇒ 12/93
PANDA 34 850	--	01/80 ⇒ 12/83
PANDA 35 850	--	01/80 ⇒ 12/83

EPS 1.230.143



CONTACT SETS

Adatt./Suitable: **MARELLI**

MAGNETI MARELLI

711 476 01

MOTO GUZZI

14 715 430



MOTO GUZZI (I)		
850 LeMans III	--	01/76 ⇒
850 T3 California	--	01/76 ⇒
850 T3,T4	--	01/76 ⇒
1000 SP	--	01/76 ⇒
V1000 Californiall	--	01/76 ⇒
V1000 Convert	--	01/76 ⇒
V1000 G5	--	01/76 ⇒

EPS 1.230.146M



3,5

CONTACT SETS

Adatt./Suitable: MARELLI

FIAT

9938276

MAGNETI MARELLI

071277902010
712 478 02
712 779 02
712 779 03

PEUGEOT

5945 10

SEAT

SE 141914.006A

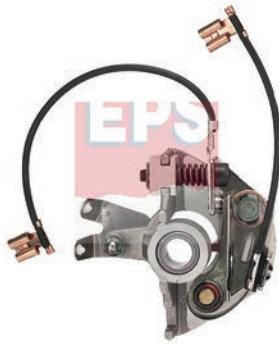

FIAT		
PANDA I 750	141B.000	01/86 ⇨ 01/95
PANDA I 900	100GL3.000	10/80 ⇨ 06/94
PANDA I 900 CL	146A.048	01/86 ⇨ 12/92
REGATA 1.1 60, 60 L	138B.000	10/83 ⇨ 08/86
REGATA 1.6	149A.000	10/84 ⇨ 06/89
REGATA 70 1.3	138B2.000, 149A3.000	09/83 ⇨ 07/89
REGATA 85 1.6	149A.000	10/83 ⇨ 06/90
RITMO I 1.1	146A4.048	04/85 ⇨ 12/87
UNO 45 0.9	146A.000, 146A1.000	03/83 ⇨ 07/96
UNO 45 0.9 Trend	146A.048	09/89 ⇨ 09/92
UNO 60 1.1 SX	--	01/83 ⇨ 12/85
FSO		
126P 0.6	126A1.048	07/77 ⇨ 12/91
PEUGEOT		
305 1.5	117(XR55)	05/80 ⇨ 09/82
SEAT		
IBIZA I 0.9	146A000	08/86 ⇨ 05/93
MARBELLA 0.9	09NCA	01/87 ⇨ 12/93
TERRA 0.9	09NCA	02/87 ⇨ 12/96

EPS 1.230.148M



3,5

CONTACT SETS

Adatt./Suitable: MARELLI

MAGNETI MARELLI

071293402010
712 934 02

RENAULT

77 01 031 989



RENAULT		
11 1.7	F2N700	10/83 ⇨ 12/87

EPS 1.230.149



1

CONTACT SETS

Adatt./Suitable: MARELLI

⁰⁰Eliminated on 27-01-2021. Please verify the availability through our local distributors

- Eliminato il 27-01-2021. Verificare la disponibilità presso i nostri distributori
- Éliminé le 27-01-2021. Vérifier la disponibilité auprès de nos distributeurs sur place
- Am 27-01-2021 gestrichen. Evtl. Verfügbarkeit bitte bei unseren Händlern prüfen
- Eliminado en fecha 27-01-2021. Verificar la disponibilidad a través de nuestros distribuidores locales

¹¹¹Paired article numbers

- N° articolo appaiato
- Numéro d'article en paire
- paarige Artikelnummer
- Referencia artículo par

1.230.149M

EPS 1.230.149M



3,5

CONTACT SETS

Adatt./Suitable: MARELLI

FIAT

9940569

MAGNETI MARELLI

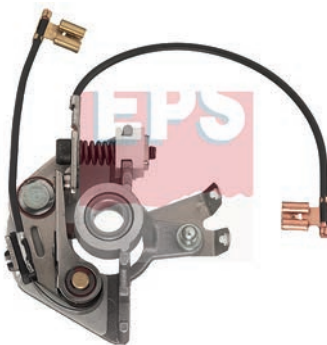
071277905010
712 779 05

FIAT		
PANDA I 1000	156A2.000	12/93 ⇨
PANDA I 1000 CLX	156A2.000	05/91 ⇨ 12/94
PANDA I 1000 Fire	156A2.000	05/86 ⇨ 04/91
PANDA I 750	156A4.000	01/86 ⇨ 10/03

EPS 1.230.150M



1

CONTACT SETS

Adatt./Suitable: MARELLI

FIAT

9909412

⁰³Supplied until depletion

- Fornibile fino ad esaurimento delle scorte
- Fourni jusqu'à épuisement du stock
- Lieferbar solange vorrat reicht
- Suministrado hasta el stock termina



FIAT		
126 650	126A1.048	07/77 ⇨ 09/87
FSO		
126P 0.6	126A1.048	07/77 ⇨ 12/91

EPS 1.231.084



1

CONTACT SETS

Adatt./Suitable: MITSUBISHI

GENERAL MOTORS

93 150 421
93 150 584

HYUNDAI

27135-11000

MAZDA

0494-24-314
3763-24-314
3823-24-314
3879-24-314

MITSUBISHI

MD607101

SUBARU

22107-KA080
22136-KA050 *F**^{*F}Available contact set only-not plate**

- Disponibile solo contatto, no piastra
- Disponible rupteur seul, pas le plateau
- Erhältlich nur unterbrecher, nicht die platte
- Disponible el platino solo, no la plancha

⁰³Supplied until depletion

- Fornibile fino ad esaurimento delle scorte
- Fourni jusqu'à épuisement du stock
- Lieferbar solange vorrat reicht
- Suministrado hasta el stock termina



FORD AUSTRALIA		
COURIER 1.8	--	01/79 ⇨ 12/84
COURIER 2.0	--	01/79 ⇨
HYUNDAI		
STELLAR 1.4	4G33	10/83 ⇨ 08/86
STELLAR 1.6	G32B	10/83 ⇨ 12/91
MAZDA		
929 I 2.0	MA	05/79 ⇨ 07/86
SUBARU		
J-SERIES 1.0	--	01/87 ⇨ 12/91

EPS 1.231.085



CONTACT SETS

Adatt./Suitable: **MITSUBISHI****NISSAN**22145-73415
22145-89900
22145-89901
22145-89905**03 Supplied until depletion**

- Fornibile fino ad esaurimento delle scorte
- Fourni jusqu'à épuisement du stock
- Lieferbar solange vorrat reicht
- Suministrado hasta el stock termina

**MITSUBISHI**

COLT I 1.2 GL	4G11	12/78 ⇨ 01/84
CORDIA 1.8 [USA]	G62B	01/82 ⇨ 12/84
CORDIA 1.8 Turbo [USA]	G62B	01/82 ⇨ 12/84
PAJERO I 2.6	4G54	01/83 ⇨ 11/90
PAJERO I 2.6 4WD	4G54	01/83 ⇨ 05/91
SHOGUN I 2.6 4x4	4G54	01/84 ⇨ 02/91

NISSAN

URVAN III 2.0	Z20	05/87 ⇨ 05/97
VANETTE II 1.5	A15	04/87 ⇨ 11/94
VANETTE II 2.0	Z20S	07/87 ⇨ 08/94

EPS 1.236.045



CONTACT SETS

Adatt./Suitable: **PAL****SKODA**

113 911 401

03 Supplied until depletion

- Fornibile fino ad esaurimento delle scorte
- Fourni jusqu'à épuisement du stock
- Lieferbar solange vorrat reicht
- Suministrado hasta el stock termina

**SKODA**

105,120 1.0	33*	08/76 ⇨ 12/89
105,120 1.0 105 S, L	742.10	08/76 ⇨ 12/90
105,120 1.0 105 S, L, GL	742.10	08/76 ⇨ 08/83
105,120 1.0 105 S, L, LS	742.10	10/83 ⇨ 12/90
105,120 1.2	37*, 55*	08/76 ⇨ 12/89
105,120 1.2 120 GLS	742.12X	02/83 ⇨ 12/90
105,120 1.2 120 L	742.12, 742.12X	08/76 ⇨ 12/90
105,120 1.2 120 LS	742.12X	08/76 ⇨ 12/90
130 1.3	43*	01/84 ⇨ 12/88
135 1.3	43*	01/87 ⇨ 12/89
136 1.3	46*	01/87 ⇨ 12/89

EPS 1.242.054



CONTACT SETS

Adatt./Suitable: **SEV****GENERAL MOTORS**

7 992 234

RENAULT08 54 921 500
77 01 003 813
77 01 008 141**SEV-MARCHAL**

S 406

03 Supplied until depletion

- Fornibile fino ad esaurimento delle scorte
- Fourni jusqu'à épuisement du stock
- Lieferbar solange vorrat reicht
- Suministrado hasta el stock termina

**RENAULT**

40.8	800705	10/83 ⇨ 10/88
------	--------	---------------

EPS 1.246.070



CONTACT SETS

Adatt./Suitable: **U.D.S.S.R.****LADA**21010-3706800-10
2101-3706800-10**03 Supplied until depletion**

- Fornibile fino ad esaurimento delle scorte
- Fourni jusqu'à épuisement du stock
- Lieferbar solange vorrat reicht
- Suministrado hasta el stock termina

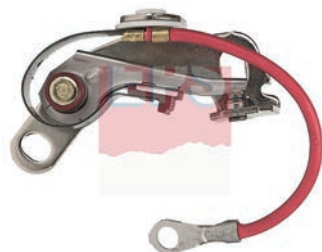
**LADA**

LADA 1.2	--	01/80 ⇨
LADA 1.3	--	01/80 ⇨
LADA 1.5	--	01/80 ⇨
NIVA I 1600	BA32121	12/76 ⇨ 12/93
RIVA 1.5	--	01/85 ⇨
RIVA 1.6	--	01/85 ⇨

EPS 1.246.071



CONTACT SETS

Adatt./Suitable: **U.D.S.S.R.****FIAT**

9918269

LADA

2101-3706800

**LADA**

LADA 1.2	--	01/80 ⇨
LADA 1.3	--	01/80 ⇨
LADA 1.5	--	01/80 ⇨
NIVA I 1600	BA32121, BA32121	12/76 ⇨ 12/93

EPS 1.249.350



CONTACT SETS

Adatt./Suitable: **ZELMOT****FIAT**

9942108

03 Supplied until depletion

- Fornibile fino ad esaurimento delle scorte
- Fourni jusqu'à épuisement du stock
- Lieferbar solange vorrat reicht
- Suministrado hasta el stock termina

**FSO**

126P 0.6	126A1.048	07/77 ⇨ 12/91
----------	-----------	---------------



DISTRIBUTOR CAPS

-CALOTTE -TETES D'ALLUMEUR -VERTEILERKAPPEN -TAPAS DEL DISTRIBUIDOR

(A) P/NRS. - NOTES

- CODICI - NOTE
- RÉFS. - NOTES
- ARTIKEL-NR. - ANMERKUNGEN
- CODIGOS - NOTAS

1.306.234 **05**

DISTRIBUTOR CAPS

Adatt./Suitable: **BOSCH**

BOSCH **2**

1 235 522 340 *A
1 235 522 381

MERCEDES-BENZ

A 000 158 48 02 *A
A 000 158 49 02

***A without cover**

- senza copertura
- sans revêtement
- ohne Abdeckung
- sin cubierta **4**

210 Interference Suppression 1k0hm

- schermato/a, 1 k0hm
- Antiparasitage, 1k0hm
- entstört, 1 k0hm
- supresión de interferencias, 1 k0hm

(A)

1 # EPS

2 OEM P/NRS.

- CODICI ORIGINALI
- RÉFS. D'ORIGINE
- ORIGINALTEILE-NR.
- CODIGOS ORIGINALES

3 PACKAGING SIZE

- FORMATO CONFEZIONE
- FORMAT DU CONDITIONNEMENT
- ABPACKENSGROSSE
- TAMAÑO DEL ENVASE

4 NOTE

- NOTE
- NOTES
- BERMERKUNGEN
- NOTAS

(B) PICTURE + TECHNICAL INFO

- FOTO + INFORMAZIONE TECNICA
- ILLUSTRATION + INFORMATION TECHNIQUE
- BILD + TECHNISCHE INFO
- FOTO + INFORMACIÓN TÉCNICA



(C) APPLICATION LIST

- GUIDA APPLICAZIONI
- LISTE D'APPLICATIONS
- ANWENDUNGSTABELLE
- LISTA DE APLICACIONES

MERCEDES-BENZ		
190 2.3	M102.985	09/87 ⇨ 09/88
190 2.3 E	M102.985	10/82 ⇨ 09/88
190 E 1.8	M102.910, M102.919	04/90 ⇨ 12/93
190 E 2.0	M102.962	10/82 ⇨ 08/93
190 E 2.3	M102.985	09/86 ⇨ 08/93
190 E 2.3-16	M102.983	04/84 ⇨ 08/88
190 E 2.5-16	M102.990, M102.991	09/88 ⇨ 08/93
190 E Evolution II 2.5	M102.992	05/90 ⇨ 08/93
CLASSE G I 230 GE	M102.998	05/87 ⇨ 08/92
CLASSE G II 200 GE	M102.965	01/90 ⇨ 07/93
CLASSE G II 230 G	M102.958	04/92 ⇨
CLASSE G II 230 GE	M102.979, M102.989, M102.996, M102.997, M102.998	09/89 ⇨
COUPE 200 CE	M102.963	09/89 ⇨ 06/93
COUPE 230 CE	M102.982	03/87 ⇨ 12/92
COUPE 230 CE Cat	M102.982	06/89 ⇨ 12/92

(B)

1 PICTURE

- FOTO
- PHOTO
- BILD
- FOTO

EPS 1.306.062



04

DISTRIBUTOR CAPS

Adatt./Suitable: **BOSCH****ALFA ROMEO**

130 85 50 06/07

BMW12 11 1 271 656
12 11 1 354 499
12 11 1 354 999
12 11 8 630 146
12 11 8 730 055**BOSCH**1 235 522 107
1 235 522 134
1 235 522 157**MERCEDES-BENZ**

A 000 158 06 02

OPEL12 12 128
12 12 147**PORSCHE**

616 602 215 00

VOLVO233260
2332609
241655
870690
8706905**VW**

111 905 207 B



ALFA ROMEO		
GT 1300 Junior	AR00530	01/66 ⇌ 12/77
BMW		
51 518	M10B18(184VB)	07/74 ⇌ 05/81
1502-2002 1602	M10B16A	04/71 ⇌ 07/75
FORD		
TAUNUS 17M 1.5	--	09/64 ⇌ 10/68
MERCEDES-BENZ		
CLASSE SL 1 190 SL	M121.921, M121.928	01/55 ⇌ 12/63
OPEL		
GT 1.1	11SR	09/68 ⇌ 12/70
VOLVO		
P 122 S AMAZON 1.8	B18D	02/67 ⇌ 05/71
VW		
KAEFFER 1.2	M51	01/54 ⇌ 07/65

EPS 1.306.072



04

DISTRIBUTOR CAPS

Adatt./Suitable: **BOSCH****BMW**12 11 1 351 446
12 11 1 353 117
12 11 1 354 501**BOSCH**

1 235 522 051

DAF163793
232634**FORD**0 710 256
1 144 700 2
1 171 025 6
1 171 026 8**MERCEDES-BENZ**10001585302
A 000 158 07 02
A 000 158 16 02
A 000 158 25 02
A 000 158 53 02**OPEL**12 12 131
12 12 135
12 12 138**PORSCHE**901 602 901 00
901 602 963 00**VOLVO**241669
2416691

PORSCHE		
911 12.0L	901.01, 901.05	01/67 ⇌ 12/68

EPS 1.306.076



04

DISTRIBUTOR CAPS

Adatt./Suitable: **BOSCH****ALFA ROMEO**105 48 05 011 06/01
60714282**BOSCH**1 235 522 050
1 235 522 058
1 235 522 059**FORD**0 710 255
1 171 025 5**MERCEDES-BENZ**

A 000 158 24 02

OPEL12 11 253
12 12 136
12 12 137**PORSCHE**

616 602 215 02

VOLVO241653
2416535
243632
2436327**VW**059 905 207
111 905 207 D
892 031 048

ALFA ROMEO		
GT 1300 Junior	AR00530	01/66 ⇌ 12/77
GT 1600	AR00526S	03/63 ⇌ 12/66

ALFA ROMEO		
GT A 1600	AR10538	01/65 ⇌ 12/70
OPEL		
GT 1.1	11SR	09/68 ⇌ 12/70
GT 1.9	19S	09/68 ⇌ 08/73
PORSCHE		
356 A 1600 S	616.15	01/55 ⇌ 12/59
356 A 1600 Super	616.15	01/55 ⇌ 12/59
912 1.6	616.36, 616.39, 616.40	01/65 ⇌ 02/70
VOLVO		
P 121 1.6	B16A	05/59 ⇌ 09/66
P 121 1.8	B18, B18A	05/59 ⇌ 05/71
P 121 2.0	OJX4G20A6L	11/68 ⇌ 05/71
P 122 S AMAZON 1.6	B16	05/59 ⇌ 09/66
P 122 S AMAZON 1.8	B18, B18D	05/59 ⇌ 05/71
P 122 S AMAZON 2.0	B20B	11/68 ⇌ 05/71
P 210 DUETT 1.8	B18A	08/61 ⇌ 07/67
PV 544 1.6	B16A, B16B	08/61 ⇌ 07/67
PV 544 1.8	B18A, B18D	08/61 ⇌ 07/67

EPS 1.306.079



04

DISTRIBUTOR CAPS

Adatt./Suitable: **BOSCH****ALFA ROMEO**700 216
705 410
105 48 05 011 08/02
116 55 05 011 00/02
165 55 05 011 00/02
60714284
60801306
82305237
96586846**BMW**12 11 1 354 449
12 11 1 359 874
12 11 1 363 191
12 11 1 363 291
12 11 1 363 423**BOSCH**1 235 522 056
1 235 522 183**DAF**

744626

FIAT7080442
82301920
82305237
82348987
82361894
9934652
9936014**FORD**0 710 254
1 144 706 9
1 171 025 4
1 523 817
3 240 336
72HF-12106-AA
DIFZ-12106-A**MERCEDES-BENZ**A 000 158 18 02
A 000 158 28 02**OPEL**

12 12 143

PEUGEOT

5941 27

RENAULT77 01 012 536
77 01 029 263
77 02 038 122**SEAT**000 398 066 5
SE 021914.001A**VOLVO**243797
2437978
546279**VW**043 905 207
049 905 207
058 905 207
113 905 207 A
113 905 207 B
113 905 207 C**ZASTAVA**46600193
5248175

ALFA ROMEO		
3311.2	AR30585	06/83 ⇌ 12/89

ALFA ROMEO			
33 I 1.3	AR30168, AR30586, AR30587	06/83 ⇒ 12/89	
33 I 1.3 i.e.	AR30168	05/83 ⇒ 12/89	
33 I 1.4	AR30587	01/84 ⇒ 12/88	
33 I 1.5	AR30588	07/86 ⇒ 12/89	
33 I 1.5 4x4	AR30508, AR30588	07/86 ⇒ 12/89	
33 I 1.5 QV	AR30146, AR30508, AR30588	06/84 ⇒ 12/89	
33 I 1.7	AR30550	01/86 ⇒ 06/90	
33 I 1.7 i.e.	AR30558	09/88 ⇒ 12/89	
33 I 1.7 i.e. 4x4	AR30558	09/88 ⇒ 12/89	
33 I 1.7 QV	AR30550	03/88 ⇒ 12/89	
33 II 1.2	AR30743	01/90 ⇒ 08/91	
33 II 1.3	AR30732	09/91 ⇒ 10/94	
33 II 1.4 4x4	AR30755	07/90 ⇒ 12/92	
33 II 1.4 i.e.	AR30755	06/91 ⇒ 09/94	
33 II 1.4 i.e. 4x4	AR30755	07/90 ⇒ 09/94	
33 II 1.5	AR30734	01/90 ⇒ 04/93	
33 II 1.5 i.e.	AR30751	01/90 ⇒ 09/94	
33 II 1.5 i.e.	AR30750	07/90 ⇒ 08/91	
33 II 1.7 16V	AR30746, AR30747	01/90 ⇒ 09/94	
33 II 1.7 16V 4x4	AR30746, AR30747	01/90 ⇒ 09/94	
33 II 1.7 i.e.	AR30736, AR30737	01/90 ⇒ 09/94	
33 II 1.7 i.e. 4x4	AR30736, AR30737	01/90 ⇒ 09/94	
75 1.6	AR06100	05/85 ⇒ 09/89	
75 1.6 Cat	AR61101	05/89 ⇒ 02/92	
75 1.8	AR06168, AR06202, AR61102, AR61201	09/85 ⇒ 02/92	
75 1.8 i.e.	61202	08/89 ⇒ 02/92	
75 1.8 i.e. Turbo America	61203	02/86 ⇒ 01/90	
75 1.8 Turbo	AR06134	09/86 ⇒ 02/92	
75 2.0 T.S. Cat	AR06224	05/85 ⇒ 02/92	
75 2.0 T.S.	AR06166, AR06224	01/87 ⇒ 02/92	
90 1.8	AR06202	10/84 ⇒ 07/87	
90 2.0 i.e.	AR06210	10/84 ⇒ 07/87	
164 2.0 T.S.	AR06416, AR06420	06/87 ⇒ 09/92	
164 2.0 Twin Spark	AR06420	06/87 ⇒ 09/92	
ALFASUD 1.2	AR30102	06/72 ⇒ 09/84	
ALFASUD 1.5 ti	AR30128	05/80 ⇒ 06/84	
ALFETTA 1.6	AR01600	01/75 ⇒ 12/84	
ALFETTA 1.8	AR01608, AR01608X	07/74 ⇒ 12/84	
GIULIETTA I 1.3	AR01644	10/77 ⇒ 06/83	
GIULIETTA I 1.6	AR01600	10/77 ⇒ 04/85	
GIULIETTA I 1.8	AR01678	04/79 ⇒ 04/85	
GIULIETTA I 2.0	AR01655	06/80 ⇒ 04/85	
SPIDER I 1600	AR00526, AR01563	03/76 ⇒ 12/93	
SPIDER I 2.0i [CAN]	AR01588	09/90 ⇒ 10/93	
SPIDER I 2.0i [USA]	AR01588	09/90 ⇒ 10/93	
SPIDER I 2.0i Veloce [CAN]	AR01588	09/90 ⇒ 10/93	
SPIDER I 2.0i Veloce [USA]	AR01588	09/90 ⇒ 10/93	
SPIDER I 2000	AR01544, AR01588, AR01590	01/77 ⇒ 12/93	

AUDI			
80 II 1.6	WV	08/78 ⇒ 07/86	
100 III 1.8	DR	08/82 ⇒ 12/87	

FIAT			
132 2.0	132C2.000	01/76 ⇒ 06/81	
DUCATO I 1.8	169B	01/82 ⇒ 12/88	
ARGENTA 2000	132D1.000	06/78 ⇒ 12/85	

FIAT (BR)			
147 1.1	--	01/82 ⇒ 12/84	
PREMIO	--	01/85 ⇒ 12/88	
PREMIO 1.3	--	01/85 ⇒	
UNO 1.3	1.3	01/85 ⇒ 12/91	
UNO 1.5	1.5	01/91 ⇒ 12/93	
UNO CS 1.3	1.3	01/85 ⇒ 12/91	
UNO CS 1.5	1.5	01/91 ⇒ 12/93	
UNO CS 1.5 Furgoneta	1.5	01/91 ⇒ 12/93	
UNO MILLE 1.0	1.0	01/91 ⇒ 04/93	

FORD			
CAPRI III 1.3	J1E	01/78 ⇒ 06/85	
ESCORT III 1.1	GSE	08/83 ⇒ 12/85	
ESCORT III 1.4 i	F6B, F6D, FUC	02/86 ⇒ 07/90	
ESCORT IV 1.4	F6B, F6D, FUA, FUC	01/86 ⇒ 07/90	
ESCORT IV 1.6 Turbo RS	LNB	01/86 ⇒ 07/90	
ESCORT IV 1.6 XR3i	LR2, LRB	01/86 ⇒ 07/90	
FIESTA 10.9	TKA, TKW, TLA	05/76 ⇒ 08/83	
FIESTA I 1.1	GLA, GLW	05/76 ⇒ 08/83	
FIESTA I 1.6 XR2	L3E	08/81 ⇒ 08/83	
FIESTA II 1.1	GLC, GSF, GSH	09/83 ⇒ 02/89	
FIESTA II 1.3	JPC	09/83 ⇒ 09/89	
FIESTA II 1.4	FUB, FUD	10/85 ⇒ 11/89	
FIESTA III 1.4	F6E	03/89 ⇒ 12/95	
GRANADA 1.7	TV17LC	08/77 ⇒ 05/82	
GRANADA 2.0	NEP	08/79 ⇒ 08/85	
SIERRA I 2.0	NET, NR2, NRD, NYT	08/82 ⇒ 12/86	
SIERRA I 2.0 i	NR2	03/85 ⇒ 12/86	
ORION I 1.3	JPA	11/86 ⇒ 07/88	
ORION I 1.4	FUA, FUC	12/85 ⇒ 07/90	

FORD			
ORION I 1.4 Cat	F6B, F6D	02/87 ⇒ 07/90	
ORION I 1.6 i	LRB	03/86 ⇒ 07/90	
SCORPIO I 1.8	REC	04/85 ⇒ 02/92	
SCORPIO I 2.0	TL20H-NE4, TL20H-NER	10/84 ⇒ 02/90	
SCORPIO I 2.0 i	NRA, NRI	04/85 ⇒ 02/92	
SIERRA II 2.0	N8C, NES	01/87 ⇒ 02/93	
TRANSIT I 1.6	4RB	11/77 ⇒ 10/86	
TRANSIT I 2.0	4RC	11/77 ⇒ 07/82	
TRANSIT II 1.6	LAC, LAT	09/85 ⇒ 09/92	
TRANSIT II 2.0	N6TS, NAT, NAV, NAW, NBA, NCA	09/85 ⇒ 09/94	
TRANSIT II 2.0 Cat	N6T	11/85 ⇒ 09/92	
TRANSIT II 2.0 EFI	--	08/91 ⇒ 08/94	
TRANSIT II 2.0 i	NCA	09/91 ⇒ 07/94	
TRANSIT II 2.0 L	NAW, NAX	10/85 ⇒ 03/91	

FORD AUSTRALIA			
CORTINA 2.0	--	06/77 ⇒ 08/82	
ESCORT 2.0	--	01/77 ⇒ 12/81	
ESCORT 2.0 RS	--	01/77 ⇒ 12/81	

LANCIA			
BETA 1600	828B.000	08/73 ⇒ 07/82	

MERCEDES-BENZ			
O 309	M115.952	01/68 ⇒ 02/89	

PEUGEOT			
505 2.0	106E(XN1A)	09/85 ⇒ 09/95	
505 2.0 Ti, STI	829(ZEJ)	08/79 ⇒ 10/86	
505 2.1 i	XN9T	01/83 ⇒ 12/88	
505 2.2	851(ZDJJ), 851X(ZDJL)	05/81 ⇒ 12/93	
505 2.2 GTI	851B(ZDJL)	08/83 ⇒ 12/93	

PORSCHE			
924 2.0 Turbo	M31.03	06/80 ⇒ 10/86	

SAAB			
90 2.0	B20I	08/84 ⇒ 08/87	
900 I 2.0 -16	5B6304GS, B202XI	01/86 ⇒ 06/94	
900 I 2.0 c	B201XC	09/79 ⇒ 12/88	
900 I 2.0 i	OTLE4G15, B201XI	11/80 ⇒ 08/90	
900 I 2.0 S Turbo-16	B202S	07/91 ⇒ 06/94	
900 I 2.0 Turbo	B201XL	01/86 ⇒ 12/91	
900 I 2.0 Turbo-16	B202L, B202XL	11/85 ⇒ 06/94	
900 I 2.0 Turbo-16 S	B202XL	01/84 ⇒ 06/94	
900 I 2.0 Turbo-16 S Cat	B202XL	01/89 ⇒ 12/93	
900 I 2.1 -16	B212I	08/90 ⇒ 06/94	
9000 2.0 -16	5B6304GS, B202XI	12/85 ⇒ 01/93	
9000 2.0 -16 CS	5B6304GS	01/89 ⇒ 12/98	
9000 2.0 -16 Turbo	B202XL	09/84 ⇒ 08/93	
9000 2.0 -16 Turbo CD	B202XL	09/88 ⇒ 08/93	
9000 2.3 -16 CD	B234I	08/89 ⇒ 12/98	
9000 2.3 -16 CS	B234I	09/89 ⇒ 12/98	

SEAT			
CORDOBA I 1.6 i	ALM	02/93 ⇒ 12/02	
IBIZA I 1.2	O21A1000	11/84 ⇒ 12/93	
IBIZA I 1.2 i	O21C.1000	01/89 ⇒ 05/93	
IBIZA I 1.5 i	O21B.2000	10/86 ⇒ 05/93	
MALAGA 1.2	O21A1000	05/85 ⇒ 12/93	
MALAGA 1.5	O21A2000	05/85 ⇒ 12/93	
MALAGA 1.5 i	O21B.2000	01/87 ⇒ 12/93	

TALBOT			
1307-1510 Simca 1307 1.3	--	07/75 ⇒ 01/80	
SIMCA 1309	--	01/78 ⇒ 12/86	
SOLARA 1.3	2M102.979	02/80 ⇒ 07/86	
TAGORA 2.1	5N2	06/80 ⇒ 12/83	

VOLVO			
240 1.8	B17A	11/78 ⇒ 07/85	
240 2.0	OJX4G20A6L, B19ET, B200E, B200F, B200K	08/74 ⇒ 12/93	
240 2.1 Turbo	B21ET, B21FT	08/80 ⇒ 07/85	
240 2.3	B230A, B230E, B230F, B230FD, B230FX, B230K	08/83 ⇒ 08/93	
240 2.3 Cat	B230F	08/91 ⇒ 07/92	
240 2.3 i Cat	B230F	08/86 ⇒ 07/93	
340-360 2.0	B200E, B200EA, B200F, B200K	08/84 ⇒ 07/90	
740 2.3	B230A	08/84 ⇒ 07/86	
760 2.3 Turbo	B23ET, B23FT	08/82 ⇒ 07/84	

VW			
PASSAT II 1.3	79SU16	08/80 ⇒ 07/86	
PASSAT II 1.6	DT	08/80 ⇒ 03/88	
POLO II 1.0	GL	10/81 ⇒ 10/86	
POLO II 1.1	HB	10/81 ⇒ 09/89	
POLO II 1.3	GK, GT, HH, HJ, HK, HW	10/81 ⇒ 09/89	
JETTA II 1.3	GT, HK	01/84 ⇒ 06/87	
JETTA II 1.6	HM	12/83 ⇒ 07/88	
JETTA II 1.8	EV, GU	01/84 ⇒ 10/91	
JETTA II 1.8 Syncro	GU	08/87 ⇒ 12/88	
CADDY I 1.5	JB	08/82 ⇒ 07/83	
CADDY I 1.6	EW, HN	01/83 ⇒ 07/92	
DERBY 1.0	GL	10/81 ⇒ 12/84	
DERBY 1.1	HB	02/77 ⇒ 09/81	
DERBY 1.3	HH	02/77 ⇒ 09/81	

VW			
GOLF I 1.3	HK	08/83 ⇒ 07/86	
GOLF I 1.6	EW, HN	08/83 ⇒ 04/92	
GOLF I 1.8	DX, EX, JH	08/82 ⇒ 04/93	
GOLF II 1.0	GN	11/83 ⇒ 08/85	
GOLF II 1.3	GT, HK	08/83 ⇒ 06/87	
GOLF II 1.6 [CHE] [SWE]	HM	08/83 ⇒ 07/85	
GOLF II 1.8	GU	08/84 ⇒ 10/91	
GOLF II 1.8 GTI	EV	08/83 ⇒ 10/91	
QUANTUM 1.7	--	01/85 ⇒ 12/87	
SCIROCCO I 1.1	FA	04/74 ⇒ 07/79	
SCIROCCO I 1.3	GF	08/79 ⇒ 07/80	
SCIROCCO I 1.5	JB	08/77 ⇒ 07/80	
SCIROCCO II 1.3	GF, HK	08/80 ⇒ 07/84	
SCIROCCO II 1.6	1HyFAD, EW, HN	08/80 ⇒ 12/89	
SCIROCCO II 1.8	DX, EX, JH	08/82 ⇒ 07/92	

ZASTAVA			
YUGO 45 [USA]	--	01/86 ⇒	

EPS **1.306.080**  **04**

DISTRIBUTOR CAPS

Adatt./Suitable: **BOSCH**

BOSCH

1 235 522 196

1 235 522 409 *A

OPEL

03469033

12 11 252

12 11 265

12 11 267 *A

*A Available distributor cap only not screen

• Fornita solo calotta, no copertura

• Disponible seulement la tete et non pas le couvercle

• Erhältlich nur die kappe, nicht die haube

• Disponible solo la tapa, no la cobertura



HOLDEN			
CAMIRA 1.6	16JH	08/82 ⇒ 02/86	
CAMIRA 1.8 MPFI	6T2204XS85K01	11/84 ⇒ 01/86	
CAMIRA 1.8 SPFI	6T2204XS85K01	02/86 ⇒ 03/87	

OPEL			
ASCONA C 1.3 N	13N	09/81 ⇒ 08/86	
ASCONA C 1.6	16N	09/81 ⇒ 08/88	
ASCONA C 1.6 S	16SH	09/81 ⇒ 08/86	
ASCONA C 1.8 E	C18NE	01/85 ⇒ 08/86	
ASCONA C 1.8 i	18E	09/82 ⇒ 08/86	
CORSA A 1.0	10S	09/82 ⇒ 03/93	
CORSA A 1.2	12N, 12NC, E12GV	09/82 ⇒ 08/90	
CORSA A 1.2 N	12NC, E12GV	01/85 ⇒ 10/87	
CORSA A 1.6 GSI	E16SE	05/88 ⇒ 03/92	
KADETT B 1.1	11N	08/71 ⇒ 08/73	
KADETT D 1.0	10N	09/79 ⇒ 08/82	
KADETT E 1.2	12SC	09/84 ⇒ 07/86	
KADETT E 1.6 S	16S	09/84 ⇒ 08/86	
KADETT E 1.8 E	C18NE	10/85 ⇒ 08/86	
KADETT E 1.8 GSI	18E	09/84 ⇒ 08/86	
KADETT E 1.8 i	18E, C18NE, C18NT	08/84 ⇒ 09/92	
MANTA B 1.3 N	13N	03/79 ⇒ 12/80	
MANTA B 1.3 S	13S	08/81 ⇒ 08/86	
MANTA B 1.6 S	16S	09/75 ⇒ 12/81	
MANTA B 1.9 N	19N	08/76 ⇒ 12/81	
MANTA B 2.0	20N	08/77 ⇒ 12/80	
OMEGA A 2.4 i	C24NE	09/88 ⇒ 03/94	
VECTRA A 1.4 S	14NV	04/88 ⇒ 06/92	

EPS 1.306.081



05

DISTRIBUTOR CAPS

Adatt./Suitable: BOSCH

ALFA ROMEO
119 00 05 011 04/02
60735405

*A Available distributor cap only not screen

- Fornita solo calotta, no copertura
- Disponible seulement la tete et non pas le couvercle
- Erhältlich nur die kappe, nicht die haube
- Disponible solo la tapa, no la cobertura

BMW
12 11 1 271 657
12 11 1 355 626
12 11 1 359 706
12 11 1 363 292
12 11 1 363 422

BOSCH
1 235 522 040
1 235 522 362 *A

DAF
698594

FORD
1 523 785
1 583 458
72TF-12106-AA
78TF-12106-AA

MAN
51.26310-0001

MERCEDES-BENZ
A 000 158 22 02
A 000 158 50 02

OPEL
12 11 250
12 12 141

PORSCHE
930 602 904 00
930 602 908 00

VOLVO
243658
2436582
243803
2438034

VW
073 905 207



ALFA ROMEO

6.2.0	AR01932	07/81 ⇒ 12/86
75 2.5 V6	AR01646, AR01648, AR01911	05/85 ⇒ 08/86
75 3.0 V6	AR06120, AR61503	01/87 ⇒ 02/92
75 3.0 V6 Cat	AR06124	01/87 ⇒ 02/92
90 2.5 i.e. V6	AR01646	10/84 ⇒ 07/87

BMW

5 II 525 i	M30B25(256EA)	06/81 ⇒ 12/87
5 II 528 i	M30B28(286EA)	06/81 ⇒ 12/87
6 I 628 CSi	M30B28	09/79 ⇒ 08/87
7 I 728	M30B28	05/77 ⇒ 08/79
7 I 728 i	M30B28	09/77 ⇒ 08/86
7 I 730	M30B30	05/77 ⇒ 08/79

FORD

TRANSIT II 2.9 i	BRT	01/91 ⇒ 09/94
------------------	-----	---------------

MAN

E2000	E2866DF01	05/00 ⇒
F2000	E2866DF01	03/00 ⇒
NG	E2866DUH01	01/95 ⇒ 07/99
NL	E2866DUH01, E2866DUH02	05/93 ⇒ 07/99

OPEL

OMEGA A 3.0	30NE, C30LE, C30NE	03/87 ⇒ 03/94
OMEGA A 3.0 Cat	C30NE	03/87 ⇒ 03/94
SENATOR B 2.5 i	25NE	09/90 ⇒ 09/93
SENATOR B 3.0	30NE, C30LE	09/87 ⇒ 09/93
SENATOR B 3.0 i Cat	C30NE	01/88 ⇒ 09/93

EPS 1.306.090



07

DISTRIBUTOR CAPS

Adatt./Suitable: BOSCH

BOSCH
0 290 004 500 *A
0 290 004 502 *A
1 235 522 208

*A Available distributor cap only not screen

- Fornita solo calotta, no copertura
- Disponible seulement la tete et non pas le couvercle
- Erhältlich nur die kappe, nicht die haube
- Disponible solo la tapa, no la cobertura

MERCEDES-BENZ
A 000 158 34 02 *A
A 000 158 42 02 *A

PORSCHE
928 602 902 00 *A

210 interference Suppression 1k0hm

- schermato/a, 1 k0hm
- Antiparasitage, 1k0hm
- entstört, 1 k0hm
- supresión de interferencias, 1 k0hm



MERCEDES-BENZ

CLASSE S II 380 SE, SEL	M116.961, M116.963	09/80 ⇒ 08/85
CLASSE S II 380 SEC	M116.963	10/81 ⇒ 07/85
CLASSE S II 500 SE, SEL	M117.961, M117.963	12/79 ⇒ 08/85
CLASSE S II 500 SEC	M117.963	08/80 ⇒ 08/85
CLASSE SL III 380 SL	M116.960, M116.962	09/80 ⇒ 08/85

PORSCHE

928 4.7 S	M28.11, M28.12	09/79 ⇒ 07/83
-----------	----------------	---------------

EPS 1.306.092



07

DISTRIBUTOR CAPS

Adatt./Suitable: BOSCH

BOSCH
0 290 004 501 *A
0 290 004 503
1 235 522 074
1 235 522 323

*A Available distributor cap only not screen

- Fornita solo calotta, no copertura
- Disponible seulement la tete et non pas le couvercle
- Erhältlich nur die kappe, nicht die haube
- Disponible solo la tapa, no la cobertura

MERCEDES-BENZ
A 000 158 27 02 *A
A 000 158 36 02 *A
A 000 158 41 02 *A

210 interference Suppression 1k0hm

- schermato/a, 1 k0hm
- Antiparasitage, 1k0hm
- entstört, 1 k0hm
- supresión de interferencias, 1 k0hm



MERCEDES-BENZ

CLASSE G I 280 GE	M110.994	11/79 ⇒ 08/89
CLASSE G II 280 GE	M110.994	04/92 ⇒
CLASSE S II 280 S	M110.924	12/79 ⇒ 07/85
CLASSE SL III 280 SL	M110.986	06/76 ⇒ 09/81
CLASSE SL III 280 SLC	M110.986	06/76 ⇒ 09/81
TRE VOLUMI I 280 E	M110.984	02/76 ⇒ 11/85

PUCH

G-MODELL 280 GE	M110.994	01/86 ⇒ 12/91
-----------------	----------	---------------

EPS 1.306.093



04

DISTRIBUTOR CAPS

Adatt./Suitable: BOSCH

AUDI
035 905 207 A
BOSCH
1 235 522 218

⁰³ Supplied until depletion

- Fornibile fino ad esaurimento delle scorte
- Fourni jusqu'à épuisement du stock
- Lieferbar solange vorrat reicht
- Suministrado hasta el stock termina

VW
035 905 207
035 905 207 A



AUDI

100 III 1.9	WH	08/82 ⇒ 07/84
100 III 2.2	KZ	10/84 ⇒ 09/86

VW

PASSAT II 1.9	WN	01/81 ⇒ 07/83
PASSAT II 2.2	KX	01/85 ⇒ 03/88
SANTANA 1.9	WN	08/81 ⇒ 07/83

EPS 1.306.094



04

DISTRIBUTOR CAPS

Adatt./Suitable: BOSCH

AUDI
027 905 207
030 905 207

BMW
12 11 1 326 765
12 11 1 706 122

BOSCH
1 235 522 213

SEAT
026 905 207 2
030 905 207

TOYOTA
19101-02020

VW
026 905 207 2
027 905 207
030 905 207
055 905 207
281 905 207
325 905 207 2



AUDI

80 II 1.3	EP	09/78 ⇒ 07/86
80 II 1.6	DT, JU, WV	08/78 ⇒ 03/87
80 II 1.8	DS, JN	01/83 ⇒ 08/86
80 II 1.8 CC quattro	JN, JV	08/84 ⇒ 08/86
80 II 1.8 GTE	DZ	10/84 ⇒ 08/86
80 IV 2.0 E quattro	ABK	09/91 ⇒ 12/94
90 I 1.8	JN	06/84 ⇒ 03/87
100 IV 2.0 E quattro	AAD	12/90 ⇒ 07/92

BMW

3 II 316	M10B18(184VC), M10B18(184VD)	09/83 ⇒ 06/88
3 II 316 i	M10B18(184KA)	08/87 ⇒ 08/88
3 II 318 i	M10B18(184EA), M10B18(184KA)	09/82 ⇒ 08/88
3 I 315	M10B16(164VB)	03/81 ⇒ 03/84
5 II 518	M10B18(184VC), M10B18(184VD)	06/81 ⇒ 09/84
5 II 518 i	M10B18(184EB)	05/81 ⇒ 12/87
5 I 518	M10B18(184VB)	07/74 ⇒ 05/81

RENAULT

FUEGO 1.6 [USA] R1368	A7L752	01/82 ⇒ 12/84
-----------------------	--------	---------------

SEAT			
AROSA 1.0	AER, ALL	05/97	⇒ 06/04
AROSA 1.4	AEX, AKV, APQ	05/97	⇒ 06/04
CORDOBA I 1.0 16V	AST, AVZ	05/00	⇒ 10/02
CORDOBA I 1.0 i	AER	09/96	⇒ 10/02
CORDOBA I 1.4	ANX	12/97	⇒ 04/99
CORDOBA I 1.4 i	ABD, AEX, AKV, APQ	06/94	⇒ 12/02
CORDOBA I 1.4 i 16V	AFH	09/96	⇒ 10/02
CORDOBA I 1.6 i	1F, ABU, AEE, AFT	02/93	⇒ 06/99
CORDOBA I 1.8 i	ABS, ACC, ADZ	02/93	⇒ 09/02
CORDOBA I 1.8 i 16V	148D	10/93	⇒ 08/96
CORDOBA I 2.0 i	2E	02/93	⇒ 06/99
IBIZA II 1.0	AAU	03/93	⇒ 09/96
IBIZA II 1.0 i	AER	09/96	⇒ 02/02
IBIZA II 1.3 i	AAV	03/93	⇒ 08/99
IBIZA II 1.4	ANX	12/97	⇒ 04/99
IBIZA II 1.4 i	ABD, AEX, AKV, APQ	09/93	⇒ 02/02
IBIZA II 1.4 i 16V	AFH	06/97	⇒ 02/02
IBIZA II 1.6 i	1F, ABU, AEE, AFT, ALM	03/93	⇒ 06/99
IBIZA II 1.8 i	ABS, ACC, ADZ	03/93	⇒ 08/99
IBIZA II 1.8 i 16V	148D	11/93	⇒ 08/96
IBIZA II 2.0 i	2E, AGG	03/93	⇒ 08/99
INCA 1.4 i	AEX, AKV, APQ	11/95	⇒ 06/03
INCA 1.6 i	1F, AEE	11/95	⇒ 05/98
TOLEDO I 1.6 i	1F, ABN, EZ	05/91	⇒ 03/99
TOLEDO I 1.8 16V	KR, PL	05/91	⇒ 03/99
TOLEDO I 1.8 GT	KR	05/91	⇒ 11/92
TOLEDO I 1.8 i	ABS, RP	05/91	⇒ 12/96
TOLEDO I 2.0 i	2E	05/91	⇒ 03/99

SKODA			
FELICIA 1.6	6A16XHT	06/97	⇒ 04/02
FELICIA 1.6 GLX	6A16XHT	08/95	⇒ 03/98
FELICIA 1.6 LX	6A16XHT	08/95	⇒ 03/98
OCTAVIA I 1.6	6A16XHT	09/96	⇒ 09/04

TOYOTA			
AVENSIS I 1.6	4A-FE	09/97	⇒ 10/00
CARINA E 1.6	4A-FE	04/92	⇒ 09/97
CARINA E 1.6 16V	4A-FE	12/94	⇒ 09/97
CARINA E 1.6 GLI	4A-FE	04/92	⇒ 09/97
CARINA E 1.6 i	4A-FE	02/95	⇒ 09/97

VOLKSWAGEN (BR)			
APOLLO 1.8	424, 599	06/90	⇒ 11/92
CADDY 1.6i	MY4	11/98	⇒
GOL 1.0i	510	11/96	⇒
GOL 1.0i 16v	511	09/97	⇒
GOL 1.6	504, 505	09/94	⇒ 01/97
GOL 1.6i	540, 541	10/96	⇒
GOL 1.8	521, 522	04/94	⇒ 01/97
GOL 1.8i	542, 543	10/96	⇒
GOL 2.0i	528, 529, 546, 547	09/94	⇒
LOGUS 1.6	504, 505	10/94	⇒ 12/96
LOGUS 1.8	524, 525, 599	12/92	⇒ 12/96
LOGUS 2.0	653	11/93	⇒ 05/94
LOGUS 2.0i	526, 527	05/94	⇒ 12/96
PARATI 1.0i 16v	511	09/97	⇒
PARATI 1.6	504, 505	08/95	⇒ 01/97
PARATI 1.6i	540, 541	10/96	⇒
PARATI 1.8	521, 522	08/95	⇒ 01/97
PARATI 1.8i	542	10/96	⇒
PARATI 2.0i	528, 529, 546, 547	08/95	⇒
POINTER 1.8	524, 525, 599	11/93	⇒ 12/96
POINTER 2.0	653	12/92	⇒ 05/94
POINTER 2.0i	526, 527	05/94	⇒ 12/96
POLO 1.6	MJ3, MY4	07/00	⇒
POLO 1.8	MJ2, MY5, MY6	12/96	⇒
SAVEIRO 1.6i	540, 541	10/96	⇒
SAVEIRO 1.8i	542, 543	10/96	⇒
SAVEIRO 2.0i	546, 547	10/96	⇒

VW			
PASSAT II 1.6	DT	08/80	⇒ 03/88
PASSAT II 1.8	DS	01/83	⇒ 03/88
PASSAT II 1.8 Syncro	DS	01/86	⇒ 03/88
POLO II 1.0	AAK, AAU, GL, HZ	10/81	⇒ 09/94
POLO II 1.0 Cat	AAK, AAU	08/89	⇒ 09/94
POLO II 1.1	HB	10/81	⇒ 09/89
POLO II 1.3	3F, AAV, GK, GT, HJ, HK, MH	08/82	⇒ 09/94
POLO II 1.3 Cat	2G, 3F, AAV, MH, NZ	07/87	⇒ 09/94
POLO II 1.3 G40	PY	01/87	⇒ 09/94
JETTA II 1.0	HZ	08/85	⇒ 10/91
JETTA II 1.3	GT, HK, MH, NU	01/84	⇒ 12/87
JETTA II 1.3 Cat	2G, MH, NZ	06/87	⇒ 12/91
JETTA II 1.6	EZ, HM	12/83	⇒ 07/92
JETTA II 1.8	EV, GU, GX, PB, RH, RV	01/84	⇒ 10/91
JETTA II 1.8 Cat	GX, PF	01/87	⇒ 10/91
JETTA II 1.8 G60	PG	04/90	⇒ 07/91
JETTA II 1.8 Syncro	GU	08/87	⇒ 12/88
JETTA II 1.8i GT	GZ	12/83	⇒ 07/88
CADDY I 1.6	EW, HN	01/83	⇒ 07/92

VW			
CADDY I 1.8	JH	08/85	⇒ 07/92
CADDY II 1.4	AEX, AKV, APQ	11/95	⇒ 06/03
CADDY II 1.6	AEE	06/96	⇒ 12/00
CADDY II 60 1.4	AEX, APQ	11/95	⇒ 01/04
CADDY II 75 1.6	AEE	11/95	⇒ 09/00
DERBY 1.3	GK, HK	09/82	⇒ 12/84
GOLF I 1.3	HK	08/83	⇒ 07/86
GOLF I 1.6	EW, HN	08/83	⇒ 04/92
GOLF I 1.8	2H, DX, EX, JH, KT	08/82	⇒ 04/93
GOLF II 1.0	GN, HZ	11/83	⇒ 10/91
GOLF II 1.3	GT, HK, MH, NU	08/83	⇒ 12/87
GOLF II 1.3 Cat	2G, NZ	06/86	⇒ 12/92
GOLF II 1.6	EZ	08/83	⇒ 07/92
GOLF II 1.6 [CHE] [SWE]	HM	08/83	⇒ 07/86
GOLF II 1.8	GU, GX, RH, RV	08/84	⇒ 10/91
GOLF II 1.8 GTI	EV, PB	08/83	⇒ 10/91
GOLF II 1.8 GTI Cat	PF	01/87	⇒ 10/91
GOLF II 1.8 GTI G60	PG	04/90	⇒ 07/91
GOLF II 1.8 GTI G60 Syncro	1H, PG	08/88	⇒ 12/91
GOLF II 1.8 i Cat	GX	08/87	⇒ 10/91
GOLF II 1.8 Syncro	GU, GX	02/86	⇒ 07/91
GOLF II 1.8i GTI [CHE] [SWE]	GZ	01/84	⇒ 07/86
GOLF III 1.4	ABD, AEX	10/91	⇒ 04/99
GOLF III 1.6	ABU, AEA, AEE	09/92	⇒ 08/97
LUPU 1.0	AER, ALL	09/98	⇒ 07/05
POLO III 1.4	AEX, AKV, ANX, APQ	05/97	⇒ 09/01
POLO III 1.6	AEA, AEE, ALM	09/94	⇒ 09/01
POLO III 100 1.4 16V	AFH	04/96	⇒ 10/99
POLO III 45 1.0	AEV	10/94	⇒ 09/96
POLO III 50 1.0	AER, ALL	09/96	⇒ 10/99
POLO III 54 1.4	ANX	01/98	⇒ 08/99
POLO III 55 1.3	ADX	10/94	⇒ 04/97
POLO III 55 1.4	AEX	08/95	⇒ 10/99
POLO III 60 1.4	AEX, AKV, APQ	07/95	⇒ 09/01
POLO III 75 1.6	AEA, AEE, AHS, ALM	10/94	⇒ 09/01
POLO III 75 1.6 4motion	AEA	08/95	⇒ 10/99
PASSAT III 1.6	1F, EZ	04/88	⇒ 07/92
PASSAT III 1.8	PB, PF	04/88	⇒ 07/93
PASSAT III 2.0	ZE	02/90	⇒ 05/97
PASSAT III 2.0 Syncro	2E	03/90	⇒ 12/96
POLO IV 1.0	AER	08/96	⇒ 12/01
SANTANA 1.6	DT	08/81	⇒ 12/84
SANTANA 1.8	DS	01/83	⇒ 12/84
SCIROCCO II 1.3	HK	08/83	⇒ 07/84
SCIROCCO II 1.6	EW, HN	01/83	⇒ 12/89
SCIROCCO II 1.8	DX, EX, JH, KT	08/82	⇒ 07/92
TRANSPORTER IV 2.0	AAC	07/90	⇒ 04/03
VENTO 1.4	ABD	11/91	⇒ 09/98
VENTO 1.6	ABU, AEA	09/92	⇒ 09/98
VENTO 1.8	AAM, ABS, ADZ	11/91	⇒ 09/98
VENTO 2.0	2E, ADY	11/91	⇒ 09/98

EPS 1.306.098 04

DISTRIBUTOR CAPS

Adatt./Suitable: BOSCH

BOSCH
9 231 081 319
9 231 081 413
9 231 081 678

FIAT
7073055

VW
041 905 207 2
71 314 348

⁰⁰Eliminated on 17-12-2019. Please verify the availability through our local distributors

- Eliminato il 17-12-2019. Verificare la disponibilità presso i nostri distributori
- Éliminé le 17-12-2019. Vérifier la disponibilité auprès de nos distributeurs sur place
- Am 17-12-2019 gestrichen. Evtl. Verfügbarkeit bitte bei unseren Händlern prüfen
- Eliminado en fecha 17-12-2019. Verificar la disponibilidad a través de nuestros distribuidores locales



FIAT (BR)			
147 1.1	--	01/76	⇒ 12/81
PREMIO	--	01/85	⇒ 12/88
UNO 1.05	1.05	01/85	⇒ 12/87
UNO 1.3	1.3	01/85	⇒ 12/91

FIAT (BR)			
UNO 1.3 Furgoneta	1.3	01/85	⇒ 12/91
UNO CS 1.3	1.3	01/85	⇒ 12/91

VOLKSWAGEN (BR)			
VWB 1.5	--	01/75	⇒ 12/82

EPS 1.306.099 05

DISTRIBUTOR CAPS

Adatt./Suitable: BOSCH

BOSCH
1 235 522 307

⁰⁰Eliminated on 22-02-2022. Please verify the availability through our local distributors

- Eliminato il 22-02-2022. Verificare la disponibilità presso i nostri distributori
- Éliminé le 22-02-2022. Vérifier la disponibilité auprès de nos distributeurs sur place
- Am 22-02-2022 gestrichen. Evtl. Verfügbarkeit bitte bei unseren Händlern prüfen
- Eliminado en fecha 22-02-2022. Verificar la disponibilidad a través de nuestros distribuidores locales



OPEL			
KADETT D 1.3 S	135	08/79	⇒ 08/84

EPS 1.306.108 05

DISTRIBUTOR CAPS

Adatt./Suitable: BOSCH

BOSCH
1 235 522 326
1 235 522 327 *A

MERCEDES-BENZ
A 000 158 43 02 *A

^{*A}Available distributor cap only not screen

- Fornita solo calotta, no copertura
- Disponible seulement la tete et non pas le couvercle
- Erhältlich nur die kappe, nicht die haube
- Disponible solo la tapa, no la cobertura

²¹⁰interference Suppression 1k0hm

- schermato/a, 1 k0hm
- Antiparasitage, 1k0hm
- entstört, 1 k0hm
- supresión de interferencias, 1 k0hm



MERCEDES-BENZ			
124 200 CE	M102.963	09/89	⇒ 06/93
124 230 CE	M102.982	03/87	⇒ 12/92
124 230 CE Cat	M102.982	06/89	⇒ 12/92
190 2.0	M102.921, M102.924	10/82	⇒ 05/90
190 2.3	M102.985	09/87	⇒ 09/88
190 2.3 E	M102.985	10/82	⇒ 09/88
190 E 2.0	M102.962	10/82	⇒ 08/93
190 E 2.3	M102.985	09/86	⇒ 08/93

CLASSE G I 200 GE	M102.964	02/80 ⇒ 08/92
CLASSE G I 230 G	M115.973	03/79 ⇒ 07/93
CLASSE G I 230 GE	M102.981, M102.987	04/82 ⇒ 08/92
CLASSE G II 230 GE	M102.981	04/92 ⇒
KOMBI I 200 T	M102.920, M102.939	11/80 ⇒ 11/85
KOMBI II 200 T	M102.922	09/85 ⇒ 05/90
KOMBI II 200 TE	M102.962, M102.963	09/88 ⇒ 08/92
KOMBI II 230 E Chassis	M102.982	09/86 ⇒ 06/93
KOMBI II 230 TE	M102.982	09/85 ⇒ 08/92
KOMBI II 230 TE Cat	M102.982	06/89 ⇒ 08/92
O 309	M102.943	01/68 ⇒ 02/89
T1 210 2.3	M102.942, M102.945	04/77 ⇒ 02/96
T1 310 2.3	M102.942, M102.945	08/82 ⇒ 02/96
T1 410 2.3	M102.942, M102.945	08/82 ⇒ 06/95
T2/LN1 510	M102.946	04/86 ⇒ 12/94
TRE VOLUMI II 200	M102.922	12/85 ⇒ 10/92
TRE VOLUMI II 200 E	M102.963	09/88 ⇒ 08/93
TRE VOLUMI II 230 E	M102.982	12/84 ⇒ 06/93
TRE VOLUMI II 230 E Cat	M102.982	06/89 ⇒ 06/93

PUCH

G-MODELL 230 GE	M102.981, M102.987	03/79 ⇒ 12/91
-----------------	--------------------	---------------

EPS 1.306.109



DISTRIBUTOR CAPS

Adatt./Suitable: **BOSCH****BOSCH**

1 235 522 322

FORD1 595 255
6 077 549
81SF-12106-EA**Motorcraft**

EDH 125

* Supplied until depletion

- Fornibile fino ad esaurimento delle scorte
- Fourni jusqu'à épuisement du stock
- Lieferbar solange vorrat reicht
- Suministrado hasta el stock termina

**FORD**

CORTINA 1300	KL13H	10/70 ⇒ 03/72
SIERRA I 1.3	JCT	08/82 ⇒ 12/86
SIERRA I 2.0	NET, NYT	08/82 ⇒ 12/86
P 100 2.0	NAE	10/87 ⇒ 12/92
TRANSIT I 1.6	4RB	11/77 ⇒ 10/86
TRANSIT II 1.6	LAC, LAT	09/85 ⇒ 09/92
TRANSIT II 2.0	NAT, NAV, NAW, NBA, NCA	09/85 ⇒ 09/94
TRANSIT II 2.0 i	NCA	09/91 ⇒ 07/94
TRANSIT II 2.0 L	NAW, NAX	10/85 ⇒ 03/91

EPS 1.306.112



DISTRIBUTOR CAPS

Adatt./Suitable: **BOSCH****BOSCH**9 231 065 501
9 231 065 506
9 231 065 516
9 231 065 546**GENERAL MOTORS**

V 510 867

HOLDENGB835
GB926**FORD AUSTRALIA**

BRONCO 5.8	--	01/81 ⇒ 12/85
------------	----	---------------

HOLDEN

CALAIS_VN 5.0i	5.0V8EFI	08/88 ⇒ 09/91
CALAIS_VP 5.0i Sedan	5.0V8EFI	10/91 ⇒ 07/93
CALAIS_VR 5.0i Sedan	5.0PFIV8	07/93 ⇒ 04/95
CALAIS_VS 5.0i Sedan	5.0V8PFI	04/95 ⇒ 05/96
CALAIS_VS-II 5.0i Sedan	5.0V8PFI	06/96 ⇒ 08/97
CAPRICE_VQ 5.0i Sedan	5.0V8EFI	03/90 ⇒ 11/93
CAPRICE_VR 5.0i Sedan	5.0PFIV8	12/93 ⇒ 04/95
CAPRICE_VS 5.0i Sedan	5.0V8PFI	03/95 ⇒ 08/96
CAPRICE_VS-II 5.0i Sedan	5.0V8PFI	09/96 ⇒ 08/97
COMMODORE VR 5.0i	5.0PFIV8	07/93 ⇒ 04/95
COMMODORE VR 5.0i Wagon	5.0PFIV8	07/93 ⇒ 04/95
COMMODORE VS 5.0i	5.0V8PFI	04/95 ⇒ 05/96
COMMODORE VS-II 5.0i	5.0V8PFI	06/96 ⇒ 08/97
COMMODORE_VL 5.0i Group A SS	5.0V8EFI	02/87 ⇒ 07/88
COMMODORE_VN 5.0i	5.0V8EFI	08/88 ⇒ 09/91
COMMODORE_VN 5.0i Group A SS	5.0V8EFI	08/88 ⇒ 09/91
COMMODORE_VP 5.0i	5.0V8EFI	10/91 ⇒ 07/93
FORMULA_VR 5.0i	5.0PFIV8	07/93 ⇒ 04/95
STATESMAN_VQ 5.0i	5.0V8EFI	03/90 ⇒ 11/93
STATESMAN_VR 5.0i	5.0PFIV8	12/93 ⇒ 04/95
STATESMAN_VS 5.0i	5.0V8PFI	03/95 ⇒ 08/96
STATESMAN_VS-II 5.0i	5.0V8PFI	09/96 ⇒ 08/97
UTILITY_VG 5.0i	5.0V8EFI	08/88 ⇒ 09/91
UTILITY_VP 5.0i	5.0V8EFI	10/91 ⇒ 07/93
UTILITY_VR COUPE 5.0i	5.0PFIV8	07/93 ⇒ 04/95

EPS 1.306.117



DISTRIBUTOR CAPS

Adatt./Suitable: **BOSCH****BOSCH**

1 235 522 325 *A

PORSCHE944 602 251 00 *A
944 602 902 00 *A

*A Available distributor cap only not screen

- Fornita solo calotta, no copertura
- Disponible seulement la tete et non pas le couvercle
- Erhältlich nur die kappe, nicht die haube
- Disponible solo la tapa, no la cobertura

210 interference Suppression 1kOhm

- schermato/a, 1 kOhm
- Antiparasitage, 1kOhm
- entstört, 1 kOhm
- supresión de interferencias, 1 kOhm

**PORSCHE**

924 2.5 S	M44.07	09/85 ⇒ 07/87
928 4.7 S	M28.11, M28.12	09/79 ⇒ 07/83

EPS 1.306.121



DISTRIBUTOR CAPS

Adatt./Suitable: **BOSCH****BMW**12 111 284 372
12 111 289 519**BOSCH**1 235 522 333
1 235 522 361**BMW**

3 II 323 i	M20B23(236EC)	09/82 ⇒ 09/86
5 II 520 i	M20B20(206EA)	06/81 ⇒ 12/87

EPS 1.306.123



07

DISTRIBUTOR CAPS

Adatt./Suitable: BOSCH

BOSCH

1 235 522 329
1 235 522 330 *A
1 235 522 368

MERCEDES-BENZ

A 000 158 44 02 *A

PORSCHE

930 602 919 00 *A

*A Available distributor cap only not screen

- Fornita solo calotta, no copertura
- Disponible seulement la tete et non pas le couvrle
- Erhältlich nur die kappe, nicht die haube
- Disponible solo la tapa, no la cobertura

210 interference Suppression 1kOhm

- schermato/a, 1 kOhm
- Antiparasitage, 1kOhm
- entstört, 1 kOhm
- supresión de interferencias, 1 kOhm



MERCEDES-BENZ

123 280 CE	M110.988	03/77 ⇒ 11/85
CLASSE G I 280 GE	M110.994	11/79 ⇒ 08/89
CLASSE G II 280 GE	M110.994	04/92 ⇒
CLASSE S II 280 SE, SEL	M110.989	10/79 ⇒ 07/85
TRE VOLUMI I 280 E	M110.988	02/76 ⇒ 11/85

PORSCHE

911 I 3.2 SC Carrera	930.20	08/83 ⇒ 08/89
911 III 3.6 Turbo 4	M64.60	03/95 ⇒ 09/97
911 III 3.6 Turbo GT2	M64.60R	03/95 ⇒ 09/97
911 III 3.6 Turbo GT2 4	M64.60R, M64.60RS	08/95 ⇒ 09/97

PUCH

G-MODELL 280 GE	M110.994	01/86 ⇒ 12/91
-----------------	----------	---------------

EPS 1.306.124



05

DISTRIBUTOR CAPS

Adatt./Suitable: BOSCH

BOSCH

1 235 522 332

CITROËN

94 059 413 28

HYUNDAI

27110-22000

PEUGEOT

5941 32

SAAB

91 70 259



CITROËN

BX 1.4	150C, K1F, K2D	07/86 ⇒ 12/94
BX 1.4 E	150B(XY8), 150J, 150Y, K1F, KAZ	09/82 ⇒ 12/94
BX 1.6	182A, B2C, B6D, B6E	01/87 ⇒ 12/94
BX 1.9	159B, 159C, D6U, DKK	05/85 ⇒ 12/94
BX 1.9 GTi	D6D, D6K	01/87 ⇒ 01/92
BX 14	150C	01/86 ⇒ 02/93
BX 14 E	150A, 150C, K1G	10/82 ⇒ 02/93
BX 15	B1E(XU51C)	01/87 ⇒ 05/92
BX 16	171A, 171B, 171C, 171D, 180Z, 23DH, B1E(XU51C), BAY(XU5CP), BAZ(XU5CP)	10/82 ⇒ 12/94
BX 19	159A, D2A(XU92C), D2C(XU92C), D2E, D6A(XU9J2), DKZ(XU9JA)	09/84 ⇒ 12/94

CITROËN

BX 19 Cat	DFZ(XU9J1)	07/86 ⇒ 12/94
BX 19 E 4x4	D2F	04/89 ⇒ 02/93
BX 19 GTi	D6A(XU9J2), DKZ(XU9JA)	07/86 ⇒ 02/93
BX 19 GTi 4x4	DKZ(XU9JA)	06/88 ⇒ 02/93
C15 1.0	108C	10/84 ⇒ 07/88
C15 1.0 E	TU9K	11/92 ⇒ 07/96
C15 1.1	109K, E1A, XW7	10/84 ⇒ 12/96
C15 1.3	G1A	07/87 ⇒ 05/88
C15 1.4	150D(XY7)	05/87 ⇒ 10/92
C15 1.4 E	150D(XY7)	05/87 ⇒ 12/96
LNA 1.1	109/5E	07/82 ⇒ 04/85
VISA 11 E	109K	09/78 ⇒ 06/88

HYUNDAI

S COUPE 1.5 i	G4EK	04/92 ⇒ 05/96
S COUPE 1.5 i Turbo	G4EK-TC	04/91 ⇒ 05/96

PEUGEOT

104 1.0	108C(XV8)	09/83 ⇒ 06/88
205 I 1.0	108C(XV8)	02/83 ⇒ 12/90
205 I 1.3	G1A	02/84 ⇒ 10/87
205 I 1.4	150B(XY8), 150G(XY7), 150H(XY8), J2	01/83 ⇒ 12/90
205 I 1.5	Y2/K	02/84 ⇒ 10/87
205 I 1.6	B1A(XU51C), B1E(XU51C), BAZ(XU5CP)	08/86 ⇒ 10/87
205 I 1.6 GTI	180A(XU5J), B6D(XU5JA), XU5J1	01/83 ⇒ 12/90
205 I 1.9 GTI	DFZ(XU9J1)	03/87 ⇒ 10/87
205 II 1.1 XA	E1	07/87 ⇒ 10/88
205 II 1.2	F1	01/87 ⇒ 12/90
205 II 1.3	G1A	08/90 ⇒ 07/92
205 II 1.4	150B(XY8), 150G(XY7), 150H(XY8), J2	10/87 ⇒ 12/94
205 II 1.4 CJ	150G(XY7)	03/88 ⇒ 05/89
205 II 1.4 CT	150B(XY8), 150H(XY8)	04/86 ⇒ 12/88
205 II 1.6	B1A(XU51C), B1E(XU51C), BAZ(XU5CP)	10/87 ⇒ 09/98
205 II 1.6 GTI	180A(XU5J), 180Z(XU5J)	03/86 ⇒ 10/90
205 II 1.6 GTi	180A(XU5J), 180Z(XU5J)	10/87 ⇒ 12/89
205 II 1.9 CTi	DFZ(XU9J1)	10/87 ⇒ 12/94
205 II 1.9 GTi Cat	DFZ(XU9J1)	10/87 ⇒ 07/94
309 I 1.1	E1	10/85 ⇒ 07/89
309 I 1.1	G1A, G2S	10/85 ⇒ 08/89
309 I 1.5	Y2/K	06/87 ⇒ 12/89
309 I 1.6	--, 180Z(XU5J), B1A(XU51C), B1D(XU51C), B1E(XU51C), B6B(XU5J), J2, XU5JA	10/85 ⇒ 07/89
309 I 1.6 Cat	BAZ(XU5CP)	09/86 ⇒ 12/89
309 I 1.9	D2B(XU9S), DFZ(XU9J1), XU92C	10/85 ⇒ 07/89
309 II 1.6	18EM, J2, XU5JA	07/89 ⇒ 12/93
309 II 1.6 GTi	--	09/89 ⇒ 10/93
309 II 1.9	XU92C	07/89 ⇒ 12/93
405 I 1.9	DFZ(XU9J1)	05/88 ⇒ 08/92
405 I 1.9 Antipollution	XU92C	01/87 ⇒ 12/92
405 I 1.9 Injection	DFZ(XU9J1)	07/87 ⇒ 12/92
405 I 1.9 Trazione integrale	DFZ(XU9J1)	09/88 ⇒ 07/92

SAAB

9-3 2.0 i	B204I	02/98 ⇒ 08/03
9-3 2.3 i	B234I	02/98 ⇒ 08/03
900 II 2.0 i	B204I, B206I	07/93 ⇒ 02/98
900 II 2.3 -16	B234I	07/93 ⇒ 02/98

EPS 1.306.127



07

DISTRIBUTOR CAPS

Adatt./Suitable: BOSCH

BOSCH

1 235 522 366
1 235 522 382 *A

VOLVO

1346788 *A
13467881 *A

*A Available distributor cap only not screen

- Fornita solo calotta, no copertura
- Disponible seulement la tete et non pas le couvrle
- Erhältlich nur die kappe, nicht die haube
- Disponible solo la tapa, no la cobertura



VOLVO

960 I 2.0	B204FT	08/90 ⇒ 09/93
960 I 2.3	B230GT	08/90 ⇒ 07/94
960 I 2.3 Turbo	B230FT	09/90 ⇒ 08/93
740 2.0	B200E, B200ET, B200G, B200K	01/85 ⇒ 07/92
740 2.0 16V	B204E	09/87 ⇒ 08/90
740 2.0 16V Turbo	B204FT, B204GT	08/89 ⇒ 07/90
740 2.0 GLE	B204E	09/87 ⇒ 08/90
740 2.0 Turbo	B200ET, B200FT	09/87 ⇒ 08/91
740 2.3	B230E, B230F, B230FB, B230G, B230K, B234F	08/84 ⇒ 12/92
740 2.3 GL	B230E	08/84 ⇒ 08/87
740 2.3 Turbo	B230ET, B230FT, B230GT	08/85 ⇒ 08/91
760 2.3	B230ET, B230FT, B230K	08/84 ⇒ 07/92
760 2.3 Turbo	B230ET, B230FT, B230GT	08/84 ⇒ 08/90
780 2.0i	B204GT	01/87 ⇒ 12/90
780 2.0i Turbo	B200ET	01/87 ⇒ 12/90
940 I 2.0	B200E, B200F, B200G	08/90 ⇒ 07/94
940 I 2.0 GL	B204E	09/90 ⇒ 04/92
940 I 2.0 Turbo	B200FT	08/90 ⇒ 07/95
940 I 2.3	B230E, B230F, B230FB, B230FD, B230G, B234F, B234G	08/90 ⇒ 07/95
940 I 2.3 16V	B234G	08/90 ⇒ 07/92
940 I 2.3 Turbo	B230FT, B230GT	08/90 ⇒ 07/94
940 II 2.0 GLT	B200GT	10/94 ⇒ 05/97
940 II 2.0 Turbo	B200FT	04/96 ⇒ 10/98
940 II 2.3	B230FD, B230GK	08/94 ⇒ 05/97
940 II 2.3 ti	B230FK	01/95 ⇒ 10/98
940 II 2.3 Turbo	B230FT, B230GK	08/94 ⇒ 12/98

EPS 1.306.128



07

DISTRIBUTOR CAPS

Adatt./Suitable: BOSCH

BOSCH

1 235 522 395 *A

PORSCHE

928 602 211 01 *A

*A Available distributor cap only not screen

- Fornita solo calotta, no copertura
- Disponible seulement la tete et non pas le couvrle
- Erhältlich nur die kappe, nicht die haube
- Disponible solo la tapa, no la cobertura



PORSCHE

928 4.7 S	M28.21, M28.22	08/83 ⇒ 07/86
928 5.4 GTS	M28.49, M28.50	08/91 ⇒ 11/95
968 3.0	M44.43, M44.44	06/91 ⇒ 11/95

1.306.129

EPS 1.306.129



04

DISTRIBUTOR CAPS

Adatt./Suitable: **BOSCH**

AUDI

026 905 209

BOSCH
1 235 522 370

VW

026 905 207
026 905 209
325 905 207 1

AUDI

80 III 1.8 quattro	SD	09/86 ⇒ 08/90
80 III 1.8 S quattro	JN	09/86 ⇒ 09/91
80 III 2.0 E quattro	3A	08/88 ⇒ 09/90
100 III 1.8	DS, JW, NP	08/83 ⇒ 07/89
100 III 1.8 Cat quattro	4B	08/85 ⇒ 11/90
100 III 1.8 quattro	NP, SH	10/84 ⇒ 07/90

EPS 1.306.231



04

DISTRIBUTOR CAPS

Adatt./Suitable: **BOSCH**

AUDI

023 905 207 *A

034 905 207 B *A

BOSCH

0 290 004 032 *A

0 290 004 035 *A

1 235 522 369

1 235 522 371

1 235 522 385 *A

1 235 522 404 *A

1 235 522 405 *A

VW

023 905 207 *A

034 905 207 *A

034 905 207 A *A

034 905 207 B *A

035 905 209 B



AUDI

80 II 2.0	HP, JS	10/83 ⇒ 09/84
80 II 2.0 quattro	JS	10/83 ⇒ 09/84
80 IV 2.3 E	NG	09/91 ⇒ 01/96
80 IV 2.3 E quattro	NG	09/91 ⇒ 11/94
90 I 2.0	HP, JL, JS, SK	10/84 ⇒ 03/87
90 I 2.0 quattro	JS	08/84 ⇒ 08/86
90 I 2.2	9C54, HY, KX	10/84 ⇒ 03/87
90 I 2.2 E quattro	9C54	11/84 ⇒ 03/87
90 II 2.0	PS	07/88 ⇒ 09/91
90 II 2.0 20V quattro	NM	08/88 ⇒ 09/91
90 II 2.2 E	9C54	04/87 ⇒ 07/91
90 II 2.2 E quattro	9C54	04/87 ⇒ 09/91
90 II 2.3 E	NG	04/87 ⇒ 09/91
90 II 2.3 E 20V quattro	7A	06/88 ⇒ 09/91
90 II 2.3 E quattro	NG	04/87 ⇒ 09/91
100 III 2.0	KP	08/84 ⇒ 12/87
100 III 2.0 Cat	RT	01/88 ⇒ 11/90
100 III 2.0 E	KP	01/85 ⇒ 12/87
100 III 2.0 E Cat	RT	01/88 ⇒ 11/90
100 III 2.2 Cat	KU	06/89 ⇒ 11/90
100 III 2.2 Cat quattro	KU	06/89 ⇒ 11/90

AUDI

100 III 2.2 E Turbo quattro	MC	08/86 ⇒ 11/90
100 III 2.2 Turbo	MC	08/86 ⇒ 11/90
100 III 2.3	NF	08/86 ⇒ 11/90
100 III 2.3 E	NF	10/86 ⇒ 11/90
100 III 2.3 E quattro	NF	08/86 ⇒ 11/90
100 III 2.3 quattro	NF	01/90 ⇒ 11/90
100 IV 2.3 E	7M15A-FKS	12/90 ⇒ 07/94
100 IV 2.3 E quattro	7M15A-FKS	12/90 ⇒ 07/94
200 II 2.2	KU	08/84 ⇒ 07/85
200 II 2.2 Turbo	1B, MC	08/85 ⇒ 09/91
200 II 2.2 Turbo quattro	1B, MC	01/85 ⇒ 12/91
A6 I 2.3	7M15A-FKS	06/94 ⇒ 12/95
A6 I 2.3 quattro	7M15A-FKS	06/94 ⇒ 12/95
CABRIOLET 2.3 E	NG	05/91 ⇒ 07/94
COUPE 2.0 20V	NM	08/89 ⇒ 07/91
COUPE 2.0 20V quattro	NM	08/89 ⇒ 07/91
COUPE 2.2	9C54	11/88 ⇒ 07/91
COUPE 2.2 GT	9C54	09/84 ⇒ 10/88
COUPE 2.2 quattro	9C54, JT	10/84 ⇒ 07/91
COUPE 2.3	NG	10/88 ⇒ 12/96
COUPE 2.3 20V	7A	08/89 ⇒ 07/91
COUPE 2.3 20V quattro	7A	11/88 ⇒ 12/96
COUPE 2.3 quattro	NG	01/87 ⇒ 12/96
COUPE S2	3B	09/90 ⇒ 09/92
COUPE S2 quattro	3B	09/90 ⇒ 09/92

VW

PASSAT II 2.0	JS	08/83 ⇒ 03/88
PASSAT II 2.0 Syncro	JS	05/84 ⇒ 03/88
QUANTUM 2.1	--	01/81 ⇒ 12/89
SANTANA 2.0	JS	08/83 ⇒ 12/84
TRANSPORTER IV 2.5	AAF, ACU, AET, AEU, APL, AVT	09/90 ⇒ 06/03
TRANSPORTER IV 2.5 Syncro	AAF, ACU, AET, AEU, APL, AVT	08/92 ⇒ 04/03

EPS 1.306.233



07

DISTRIBUTOR CAPS

Adatt./Suitable: **BOSCH**

BOSCH

1 235 522 390

1 235 522 426

1 235 522 449 *A

VW

021 905 207 *A

073 905 207 B

*A Available distributor cap only not screen

- Fornita solo calotta, no copertura
- Disponible seulement la tete et non pas le couvrcl
- Erhältlich nur die kappe, nicht die haube
- Disponible solo la tapa, no la copertura

*A Available distributor cap only not screen

- Fornita solo calotta, no copertura
- Disponible seulement la tete et non pas le couvrcl
- Erhältlich nur die kappe, nicht die haube
- Disponible solo la tapa, no la copertura

*B Supplied until depletion

- Fornibile fino ad esaurimento delle scorte
- Fourni jusqu'à épuisement du stock
- Lieferbar solange vorrat reicht
- Suministrado hasta el stock termina



VW

CORRADO 2.9 VR6	ABV	08/91 ⇒ 12/95
GOLF III 2.8 VR6	AAA	01/92 ⇒ 09/97
LT I 2.4 i	1E	08/89 ⇒ 06/96
PASSAT III 2.8 VR6	AAA	06/91 ⇒ 05/97
VENTO 2.8 VR6	AAA	01/92 ⇒ 09/98

EPS 1.306.234



05

DISTRIBUTOR CAPS

Adatt./Suitable: **BOSCH**

BOSCH

1 235 522 380 *A

1 235 522 381

MERCEDES-BENZ

A 000 158 48 02

A 000 158 49 02 *A

*A Available distributor cap only not screen

- Fornita solo calotta, no copertura
- Disponible seulement la tete et non pas le couvrcl
- Erhältlich nur die kappe, nicht die haube
- Disponible solo la tapa, no la copertura

*B interference Suppression 1kOhm

- schermato/a, 1 kOhm
- Antiparasitage, 1kOhm
- entstört, 1 kOhm
- supresión de interferencias, 1 kOhm



MERCEDES-BENZ

124 200 CE	M102.963	09/89 ⇒ 06/93
124 230 CE	M102.982	03/87 ⇒ 12/92
124 230 CE Cat	M102.982	06/89 ⇒ 12/92
190 2.3	M102.985	09/87 ⇒ 09/88
190 2.3 E	M102.985	10/82 ⇒ 09/88
190 E 1.8	M102.910, M102.919	04/90 ⇒ 12/93
190 E 2.0	M102.962	10/82 ⇒ 08/93
190 E 2.3	M102.985	09/86 ⇒ 08/93
190 E 2.3-16	M102.983	04/84 ⇒ 08/88
190 E 2.5-16	M102.990	09/88 ⇒ 08/93
190 E 2.5-16 Evolution	M102.991	03/89 ⇒ 08/93
190 E 2.5-16 Evolution II	M102.992	05/90 ⇒ 08/93
CLASSE G I 230 GE	M102.998	05/87 ⇒ 08/92
CLASSE G II 200 GE	M102.965	01/90 ⇒ 07/93
CLASSE G II 230 G	M102.958	04/92 ⇒
CLASSE G II 230 GE	M102.979, M102.989, M102.996, M102.997, M102.998	09/89 ⇒
KOMBI II 200 T	M102.922	09/85 ⇒ 05/90
KOMBI II 200 TE	M102.962, M102.963	09/88 ⇒ 08/92
KOMBI II 230 E Chassis	M102.982	09/86 ⇒ 06/93
KOMBI II 230 TE	M102.982	09/85 ⇒ 08/92
KOMBI II 230 TE Cat	M102.982	06/89 ⇒ 08/92
TRE VOLUMI II 200	M102.922	12/85 ⇒ 10/92
TRE VOLUMI II 200 E	M102.963	09/88 ⇒ 08/93
TRE VOLUMI II 230 E	M102.982	12/84 ⇒ 06/93
TRE VOLUMI II 230 E Cat	M102.982	06/89 ⇒ 06/93

PUCH

G-MODELL 230 GE	M102.989	07/89 ⇒ 07/00
-----------------	----------	---------------

EPS 1.306.235



05

DISTRIBUTOR CAPS

Adatt./Suitable: BOSCH

BOSCH
 1 235 522 374

FORD
 6 146 423

Motorcraft
 EDH 183

00 Eliminated on 22-02-2021. Please verify the availability through our local distributors

- Eliminato il 22-02-2021. Verificare la disponibilità presso i nostri distributori
- Éliminé le 22-02-2021. Vérifier la disponibilité auprès de nos distributeurs sur place
- Am 22-02-2021 gestrichen. Evtl. Verfügbarkeit bitte bei unseren Händlern prüfen
- Eliminado en fecha 22-02-2021. Verificar la disponibilidad a través de nuestros distribuidores locales



FORD

SIERRA I 1.8	REB	10/84 ⇒ 12/86
SIERRA I 2.0	NET, NYT	08/82 ⇒ 12/86

EPS 1.306.236



07,5

DISTRIBUTOR CAPS

Adatt./Suitable: BOSCH

ALFA ROMEO
 195 32 05 021 00/00
 60513050 *A

BOSCH
 1 235 522 387
 1 235 522 388 *A

CHRYSLER
 T0267694 *A

FIAT
 60809702
 7700267694

LANCIA
 60809702

PEUGEOT
 5941 42 *A

RENAULT
 77 00 267 694 *A
 77 00 267 728 *A
 77 01 041 745 *A

VOLVO
 1269920 *A
 12699203 *A

***A Available distributor cap only not screen**

- Fornita solo calotta, no copertura
- Disponible seulement la tete et non pas le couvercle
- Erhältlich nur die kappe, nicht die haube
- Disponible solo la tapa, no la cobertura

03 Supplied until depletion

- Fornibile fino ad esaurimento delle scorte
- Fourni jusqu'à épuisement du stock
- Lieferbar solange vorrat reicht
- Suministrado hasta el stock termina



ALFA ROMEO

164 2.0 Turbo	AR64102	07/90 ⇒ 10/92
164 2.0 V6 Turbo	AR64101, AR64102	03/91 ⇒ 09/98
164 3.0	AR06410	11/87 ⇒ 09/91
164 3.0 i.e. QV	AR64301	09/90 ⇒ 09/92
164 3.0 Lusso [USA] [CAN]	AR06412	10/91 ⇒ 03/93
164 3.0 Sport [CAN] [USA]	AR64301	11/90 ⇒ 03/92
164 3.0 Super	64303	06/87 ⇒ 09/92
164 3.0 V6	AR06410, AR06412	06/87 ⇒ 09/92
GTV 2.0 V6 Turbo	AR16202	06/95 ⇒ 09/98
SPIDER II 2.0 V6 Turbo	AR16202	05/98 ⇒ 04/05

ALPINE

V6 TURBO	Z7U730, Z7U732, Z7U734	01/88 ⇒ 12/90
----------	------------------------	---------------

LANCIA

THEMA 2850 V6 i.e.	834E.146	06/88 ⇒ 05/92
--------------------	----------	---------------

RENAULT

25 2.4 V6 Turbo	Z7U702	10/84 ⇒ 05/90
-----------------	--------	---------------

RENAULT

25 2.5 V6 Turbo	Z7U700	01/90 ⇒ 12/92
25 2.8 V6	Z7W700, Z7W701	06/87 ⇒ 02/90
25 2.8 V6 Injection	Z7W706, Z7W707, Z7W709	06/87 ⇒ 12/92
ESPACE II 2.8 V6	Z7W712, Z7W713, Z7W717	01/91 ⇒ 10/96
SAFRANE I 3.0	Z7X723	02/93 ⇒ 06/96
SAFRANE I 3.0 Biturbo 4x4	Z7X726	02/93 ⇒ 07/96
SAFRANE I 3.0 V6	Z7X721, Z7X722, Z7X723, Z7X753	12/92 ⇒ 07/96
SAFRANE I 3.0 V6 4x4	Z7X721, Z7X722, Z7X723	12/92 ⇒ 07/96
SAFRANE II 2.9 24V	L7X713	03/99 ⇒ 12/00
SAFRANE II 3.0 V6	6216K4FU	10/96 ⇒ 12/00

VOLVO

760 2.8	B280E, B280F	08/81 ⇒ 08/91
780 2.9	B280E, B280F	08/86 ⇒ 07/90
960 I 2.8 GL	B280E, B280F	09/90 ⇒ 05/92

EPS 1.306.237



07

DISTRIBUTOR CAPS

Adatt./Suitable: BOSCH

BOSCH
 1 235 522 384

MERCEDES-BENZ
 A 103 158 00 02

03 Supplied until depletion

- Fornibile fino ad esaurimento delle scorte
- Fourni jusqu'à épuisement du stock
- Lieferbar solange vorrat reicht
- Suministrado hasta el stock termina

210 interference Suppression 1kOhm

- schermato/a, 1 kOhm
- Antiparasitage, 1kOhm
- entstört, 1 kOhm
- supresión de interferencias, 1 kOhm



MERCEDES-BENZ

CLASSE E I E 300 4-matic	M103.985	06/93 ⇒ 06/95
CLASSE E I E 300 T 4-matic	M103.985	06/93 ⇒ 06/96
124 300 CE	M103.983	03/87 ⇒ 05/93
190 2.6	M103.942	10/82 ⇒ 09/88
190 E 2.6	M103.942	09/86 ⇒ 08/93
190 E 3.2 AMG	M103.983	01/88 ⇒
CLASSE G II 300 GE	M103.987	09/89 ⇒ 09/97
CLASSE S II 260 SE	M103.941	09/85 ⇒ 06/91
CLASSE S II 300 SE, SEL	M103.981	09/85 ⇒ 06/91
CLASSE SL III 300 SL	M103.982	09/85 ⇒ 08/89
CLASSE SL IV 300 SL	M103.984	03/89 ⇒ 08/93
KOMBI II 260 TE FGST.	M103.940	09/89 ⇒ 08/92
KOMBI II 300 TE	M103.983	01/86 ⇒ 08/92
KOMBI II 300 TE 4-matic	M103.985	09/86 ⇒ 06/93
TRE VOLUMI II 260 E	M103.940	09/85 ⇒ 08/92
TRE VOLUMI II 260 E 4-matic	M103.943	09/86 ⇒ 08/92
TRE VOLUMI II 300 E	M103.983	06/85 ⇒ 08/92
TRE VOLUMI II 300 E 4-matic	M103.943, M103.983, M103.985	01/86 ⇒ 12/93

PUCH

G-MODELL 300 GE	M103.987	06/89 ⇒ 08/93
-----------------	----------	---------------

EPS 1.306.238



07,5

DISTRIBUTOR CAPS

Adatt./Suitable: BOSCH

BMW
 1 715 903

 12 11 1 285 058 *A
 12 11 1 720 124
 12 11 1 722 649
 12 11 1 725 070

BOSCH
 1 235 522 364
 1 235 522 365 *A
 1 235 522 421

***A Available distributor cap only not screen**

- Fornita solo calotta, no copertura
- Disponible seulement la tete et non pas le couvercle
- Erhältlich nur die kappe, nicht die haube
- Disponible solo la tapa, no la cobertura

03 Supplied until depletion

- Fornibile fino ad esaurimento delle scorte
- Fourni jusqu'à épuisement du stock
- Lieferbar solange vorrat reicht
- Suministrado hasta el stock termina



BMW

3 II 320 i	M20B20(206EB), M20B20(206KA)	09/82 ⇒ 11/93
3 II 325 e 2.7	M20B27(276KA), M20B27(276KB)	10/83 ⇒ 12/88
3 II 325 i	M20B25(256E1), M20B25(256E2), M20B25(256EX), M20B25(256K1)	09/83 ⇒ 11/93
3 II 325 i X	M20B25(256E1), M20B25(256E2), M20B25(256EX), M20B25(256K1)	03/86 ⇒ 10/93
5 II 520 i	M20B20(206KA)	08/85 ⇒ 12/87
5 II 525 e	M20B27(276EA), M20B27(276EB), M20B27(276KA), M20B27(276KB)	09/81 ⇒ 12/87
5 II 528 i [USA]	--	01/81 ⇒ 12/87
5 II 530 i	--	01/84 ⇒ 12/88
5 II 535 i	M30B34(346EC)	01/85 ⇒ 12/87
5 II 535 i, M 535 i	M30B34(346KA), M30B35(Motronic)	01/85 ⇒ 12/87
5 II M5	S38B35(356ED)	08/85 ⇒ 12/87
5 III 520 i	M20B20(206KA)	06/87 ⇒ 09/90
5 III 525 i	M20B25(256K1)	02/88 ⇒ 08/90
5 III 530 i	M30B30(306KA)	01/88 ⇒ 04/90
5 III 535 i	M30B34(346KB)	11/87 ⇒ 02/93
5 III M5	S38B36(366S1)	09/88 ⇒ 03/92
5 III M5 Cat	S38B36(366S1)	09/88 ⇒ 03/92
6 I 635 CSI	M30B35(Motronic, 9.3:1)	06/78 ⇒ 04/82
6 I M 635 CSI	M88B35(356ED), S38B35(356ED)	04/84 ⇒ 02/89
7 I 735 i	M30B35(Motronic)	04/85 ⇒ 08/86
7 II 730 i, iL	M30B30(306EA), M30B30(306KA)	03/85 ⇒ 03/94
7 II 735 i, iL	M30B34(346KB), M30B35(Motronic, 9.2:1)	06/86 ⇒ 07/92
7 II 750 i, iL V12	M70B50(5012A)	09/87 ⇒ 09/94
7 III 750 i, iL	M73B54(54121), M73B54(54122)	11/94 ⇒ 07/01
8 850 CSI	S70B56(56121)	11/92 ⇒ 12/96
8 850 i, Ci	M70B50(5012A)	01/90 ⇒ 08/94
Z1 2.5	M20B25(256K1)	06/88 ⇒ 06/91

EPS 1.306.239



08

DISTRIBUTOR CAPS

Adatt./Suitable: BOSCH

BOSCH

1 235 522 391
1 235 522 392 *A

MERCEDES-BENZ

A 000 158 52 02 *A

*A Available distributor cap only not screen

- Fornita solo calotta, no copertura
- Disponible seulement la tete et non pas le couvrle
- Erhältlich nur die kappe, nicht die haube
- Disponibile solo la tapa, no la copertura

210 Interference Suppression 1kOhm

- schermato/a, 1 kOhm
- Antiparasitage, 1kOhm
- entstört, 1 kOhm
- supresión de interferencias, 1 kOhm

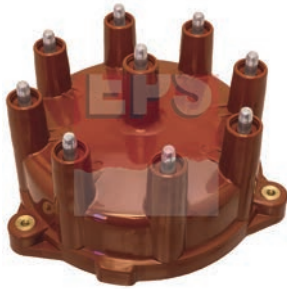

MERCEDES-BENZ

CLASSE G II 500 GE	M117.965	09/93 ⇒ 12/94
CLASSE S II 420 SE, SEL	M116.965	10/85 ⇒ 06/91
CLASSE S II 420 SEC	M116.965	10/85 ⇒ 06/91
CLASSE S II 500 SE, SEL	M117.965	09/85 ⇒ 06/91
CLASSE S II 500 SE, SEL Cat	M117.965	06/89 ⇒ 06/91
CLASSE S II 500 SEC	M117.965	09/85 ⇒ 06/91
CLASSE S II 500 SEC Cat	M117.965	06/89 ⇒ 06/91
CLASSE S II 560 SE, SEL	M117.968	10/85 ⇒ 06/91
CLASSE S II 560 SEC	M117.968	10/85 ⇒ 06/91
CLASSE SL III 420 SL	M116.964	01/86 ⇒ 08/89
CLASSE SL III 500 SL	M117.964	01/86 ⇒ 08/89
CLASSE SL III 560 SL	M117.967	09/85 ⇒ 12/89

EPS 1.306.240



07

DISTRIBUTOR CAPS

Adatt./Suitable: BOSCH

BOSCH

1 235 522 399
1 235 522 400 *A

GENERAL MOTORS

90 230 575 *A

OPEL

12 11 261 *A
90230575

*A Available distributor cap only not screen

- Fornita solo calotta, no copertura
- Disponible seulement la tete et non pas le couvrle
- Erhältlich nur die kappe, nicht die haube
- Disponibile solo la tapa, no la copertura

03 Supplied until depletion

- Fornibile fino ad esaurimento delle scorte
- Fourni jusqu'à épuisement du stock
- Lieferbar solange vorrat reicht
- Suministrado hasta el stock termina



OPEL

ASCONA C 1.8	18SE, E18NV	09/81 ⇒ 08/88
ASCONA C 1.8 E	S18NV	01/85 ⇒ 08/86
ASCONA C 2.0 i	20NE	09/86 ⇒ 08/88
ASCONA C 2.0 i Cat	C20NE	09/86 ⇒ 08/88
ASCONA C 2.0 i GT	20SEH	03/87 ⇒ 08/88
KADETT E 1.8	18SE	01/86 ⇒ 08/91

OPEL

KADETT E 1.8 i	S18NV	06/85 ⇒ 08/91
KADETT E 1.8 S	E18NV	09/87 ⇒ 08/91
KADETT E 2.0 GSI	20NE, 20SEH	09/86 ⇒ 08/91
KADETT E 2.0 GSI Cat	20NE	09/86 ⇒ 08/91
KADETT E 2.0 i	C20NE	10/86 ⇒ 02/93
KADETT E 2.0 i Cat	C20NE	10/86 ⇒ 02/93
OMEGA A 1.8	18SEH, E18NVR, S18NV	09/86 ⇒ 03/94
OMEGA A 1.8 N	18NV	09/86 ⇒ 08/87
OMEGA A 1.8 S	18SV	09/86 ⇒ 03/94
OMEGA A 2.0	20SE, C20NE	09/86 ⇒ 04/94
OMEGA A 2.0 i	C20NE	09/86 ⇒ 04/94
OMEGA B 2.0	20SE	03/94 ⇒ 12/00
VECTRA A 1.8 i	18SV	09/88 ⇒ 10/90
VECTRA A 1.8 S	18SV, E18NVR	09/88 ⇒ 10/90
VECTRA A 1.8 S 4x4	E18NVR	01/89 ⇒ 07/89
VECTRA A 2.0 i	20NE, 20SEH	09/88 ⇒ 09/92
VECTRA A 2.0 i 4x4	20NE, 20SEH	01/89 ⇒ 07/92
VECTRA A 2.0 i Cat	C20NE	09/88 ⇒ 11/95
VECTRA A 2.0 i Cat 4x4	C20NE	01/89 ⇒ 11/95
VECTRA A 2.0 i GT	20SEH	09/88 ⇒ 11/95

VAUXHALL

OMEGA B 2.0	20SE	09/95 ⇒ 09/96
-------------	------	---------------

EPS 1.306.241



05

DISTRIBUTOR CAPS

Adatt./Suitable: BOSCH

BOSCH

1 235 522 401
1 237 000 065 *A

CITROËN

95 619 491
95 659 654 *A

PEUGEOT

5940 52
5941 44

*A Available distributor cap only not screen

- Fornita solo calotta, no copertura
- Disponible seulement la tete et non pas le couvrle
- Erhältlich nur die kappe, nicht die haube
- Disponibile solo la tapa, no la copertura



CITROËN

AX 1.3 Sport	M4A	04/87 ⇒ 12/88
AX 10	C1A	09/86 ⇒ 06/92
AX 10 E	C3A	12/86 ⇒ 12/88
AX 11	H1A, H1B, HDZ(TU1M)	09/86 ⇒ 12/97
AX 11 4x4	H1A	06/91 ⇒ 07/92
AX 11 Cat	HAZ(TU1CP)	09/88 ⇒ 12/89
AX 14	K1A(TU3), K1B, K1F, K1G, K1J, K2A, K2B, K2D, KAY(TU3CP), KDX(TU3M/Z), KDY(TU3FM), KDY(TU3M), KDZ(TU3M/Z)	09/86 ⇒ 04/97
AX 14 4x4	KD4, KDX(TU3M/Z), KDY(TU3FM), KDY(TU3M), KDZ(TU3M/Z)	06/91 ⇒ 12/96
AX 14 GT	KDZ(TU3M/Z)	01/89 ⇒ 12/91
BX 1.1	109LA, H1A	04/86 ⇒ 06/91
BX 1.4	150C, K1F, K2D	07/86 ⇒ 12/94
BX 1.4 E	150B(XY8), 150J, 150Y, K1F, KAZ	09/82 ⇒ 12/94
BX 1.6	182A, B2C, B6D, B6E	01/87 ⇒ 12/94
BX 1.9	159B, 159C, D6U, DKK	05/85 ⇒ 12/94
BX 1.9 GTi	D6D, D6K	01/87 ⇒ 01/92
BX 14	150C, KDY(TU3M), KDZ(TU3M/Z)	01/86 ⇒ 02/93
BX 14 E	150A, 150C, K1G	10/82 ⇒ 02/93
BX 16	171A, 171B, 171C, 171D, 180Z, BAY(XU5CP), BAZ(XU5CP)	10/82 ⇒ 12/94
BX 19	159A, D2A(XU92C), D2C(XU92C), D2E, D6A(XU9J2), DKZ(XU9JA)	09/84 ⇒ 12/94
BX 19 Cat	DFZ(XU9J1)	07/86 ⇒ 12/94
BX 19 E 4x4	D2F	04/89 ⇒ 02/93
BX 19 GTi	D6A(XU9J2), DKZ(XU9JA)	07/86 ⇒ 02/93
BX 19 GTi 4x4	DKZ(XU9JA)	06/88 ⇒ 02/93
C15 1.0	108C(XV8), C1A, C1A(TU9/K), C1B(TU9/W), TU9	10/84 ⇒ 12/97
C15 1.1	H1A, HDZ(TU1M), TU1	08/88 ⇒ 07/96
C15 1.1 i	HDZ(TU1M), TU1MZ	07/88 ⇒ 12/96
C15 1.4	K1A, K1G, K1H(TU3A), KDY(TU3M)	07/87 ⇒ 12/96

CITROËN

C15 1.4 E	K1F, K1J, K2D, K3A, KAZ	07/86 ⇒ 12/96
C15 1.4 i	KDY(TU3FM), KDY(TU3M)	05/91 ⇒ 12/96
ZX 1.1	H1A, H1B, HDZ(TU1M), TU1	03/91 ⇒ 06/97
ZX 1.4 i	KDY(TU3M)	10/93 ⇒ 10/97

PEUGEOT

106 I 1.0	TU9	09/91 ⇒ 03/01
106 I 1.1	H1B(TU1), HDZ(TU1M)	08/91 ⇒ 04/96
106 I 1.4	K5A(TU3), KDY(TU3M), TU3.2	08/91 ⇒ 04/96
205 I 1.4	TU3	01/83 ⇒ 12/90
205 I 1.9 GTI	D6B(XU9JA)	10/86 ⇒ 10/87
205 II 1.0	TU9	10/87 ⇒ 09/98
205 II 1.1	H1B(TU1), HDZ(TU1M)	10/87 ⇒ 09/98
205 II 1.1 CJ	HDZ(TU1M)	10/89 ⇒ 12/94
205 II 1.3	TU24	01/91 ⇒ 12/94
205 II 1.3 Rallye	TU24	10/87 ⇒ 10/90
205 II 1.4	K1D(TU3A), K2B(TU3S), KDY(TU3M), KDZ(TU3M)	06/87 ⇒ 09/98
205 II 1.4 Cat	KAY(TU3CP)	08/87 ⇒ 09/93
205 II 1.4 CJ	K1D(TU3A), KDY(TU3M), KDZ(TU3M)	03/89 ⇒ 12/94
205 II 1.4 CJ Cat	KAY(TU3CP)	01/89 ⇒ 09/93
205 II 1.6 GTI	XU5JA	01/91 ⇒ 12/94
205 II 1.9 GTI	D6B(XU9JA)	10/87 ⇒ 09/98
306 1.4	TU3	01/93 ⇒ 04/97
309 I 1.4	K1D(TU3A), KDY(TU3M), KDZ(TU3M)	03/89 ⇒ 07/89
309 I 1.9 GTI	D6B(XU9JA)	10/86 ⇒ 07/89
309 II 1.1	H1B(TU1), HDZ(TU1M)	09/89 ⇒ 12/93
309 II 1.4	KDZ(TU3M), TU3, TU3F2	07/89 ⇒ 12/93
309 II 1.6	XU5JA	07/89 ⇒ 12/93
309 II 1.6 GTi	--	09/89 ⇒ 10/93
405 I 1.4	K5A(TU3), TU3A, TU3F2	01/87 ⇒ 12/92
405 I 1.6	--	01/87 ⇒ 12/92
405 I 1.9	D2C(XU92C), D6A(XU9J2)	07/87 ⇒ 12/93
405 II 1.4	TU3F2	01/93 ⇒ 12/96
405 II 1.6	18EM	08/92 ⇒ 05/97
405 II 1.9	XU92C	01/93 ⇒ 12/96

EPS 1.306.244



05

DISTRIBUTOR CAPS

Adatt./Suitable: BOSCH

BOSCH

9 231 065 529

FORD AUSTRALIA

ADH-2

Motorcraft

ADH 2

03 Supplied until depletion

- Fornibile fino ad esaurimento delle scorte
- Fourni jusqu'à épuisement du stock
- Lieferbar solange vorrat reicht
- Suministrado hasta el stock termina



FORD AUSTRALIA

FAIRLANE 3.2i EFI	--	01/89 ⇒
FAIRLANE 3.9i EFI	--	01/89 ⇒
FAIRLANE 3.9i MPEFi	--	01/89 ⇒
FAIRLANE 4.0i MPEFi	--	01/89 ⇒
FAIRLANE ZL 4.1i	--	01/84 ⇒
FALCON 3.2 Efi	--	03/88 ⇒ 12/88
FALCON 3.3	--	10/84 ⇒ 12/87
FALCON 3.9 Efi	--	07/91 ⇒ 04/92
FALCON 3.9 MPFi	--	03/88 ⇒ 04/92
FALCON 3.9 SPFi	--	03/88 ⇒ 04/92
FALCON 4.1	--	10/84 ⇒ 02/86

EPS 1.306.247



07,5

DISTRIBUTOR CAPS

Adatt./Suitable: BOSCH

BMW

12 11 1 289 425
12 11 1 734 109 *A

BOSCH

1 235 522 396 *A
1 235 522 397

- *A Available distributor cap only not screen**
- Fornita solo calotta, no copertura
 - Disponible seulement la tete et non pas le couvrle
 - Erhältlich nur die kappe, nicht die haube
 - Disponible solo la tapa, no la cobertura

03 Supplied until depletion

- Fornibile fino ad esaurimento delle scorte
- Fourni jusqu'à épuisement du stock
- Lieferbar solange vorrat reicht
- Suministrado hasta el stock termina



BMW		
3 III 316 i	M40B16(164E1), M43B16(164E2)	09/90 ⇒ 09/93
3 III 318 i	M40B18(184E1)	09/90 ⇒ 08/93
3 II 316 i	M40B16(164E1)	09/87 ⇒ 06/94
3 II 318 i	M40B18(184E1)	06/87 ⇒ 06/94
5 III 518 i	M40B18(184E1)	09/89 ⇒ 04/94

EPS 1.306.248



07

DISTRIBUTOR CAPS

Adatt./Suitable: BOSCH

AUDI

077 905 205 *A
077 905 207 *A

BOSCH

1 235 522 419 *A
1 235 522 420 *A

VW

077 905 205 *A
077 905 207 *A

- *A Available distributor cap only not screen**
- Fornita solo calotta, no copertura
 - Disponible seulement la tete et non pas le couvrle
 - Erhältlich nur die kappe, nicht die haube
 - Disponible solo la tapa, no la cobertura

03 Supplied until depletion

- Fornibile fino ad esaurimento delle scorte
- Fourni jusqu'à épuisement du stock
- Lieferbar solange vorrat reicht
- Suministrado hasta el stock termina

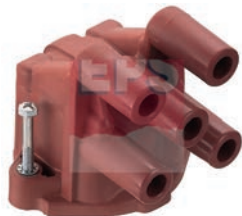

AUDI		
80 III 2.0 E 16V	6A	03/90 ⇒ 09/91
80 III 2.0 E 16V quattro	6A	03/90 ⇒ 08/91
80 IV 2.0 E 16V	6A, ACE	09/91 ⇒ 01/96
100 IV 2.0 E 16V	ACE	01/92 ⇒ 07/94
100 IV 2.0 E 16V quattro	ACE	07/92 ⇒ 07/94
A6 I 2.0 16V	ACE	06/94 ⇒ 12/97
A6 I 2.0 16V quattro	ACE	06/94 ⇒ 12/97
A6 I S6 4.2 quattro	AEC	06/94 ⇒ 12/97
CABRIOLET 2.0 16V	ACE	06/95 ⇒ 07/96
COUPE 2.0 16V	6A, ACE	01/92 ⇒ 12/96
V8 3.6 quattro	PT	10/88 ⇒ 02/94
V8 4.2 quattro	ABH	10/91 ⇒ 02/94

EPS 1.306.249



04

DISTRIBUTOR CAPS

Adatt./Suitable: BOSCH

BOSCH

1 235 522 436

GENERAL MOTORS
90 350 765

OPEL

12 11 000
12 11 268
90350765**03 Supplied until depletion**

- Fornibile fino ad esaurimento delle scorte
- Fourni jusqu'à épuisement du stock
- Lieferbar solange vorrat reicht
- Suministrado hasta el stock termina



OPEL		
ASTRA F 1.4 i	C14NZ	09/91 ⇒ 01/05
CORSA A 1.4 i	C14NZ	01/85 ⇒ 03/93
CORSA A 1.6 GSI	E16SE	05/88 ⇒ 03/92
KADETT E 1.4 i	C14NZ	01/90 ⇒ 07/94
KADETT E 1.6	16SV	09/86 ⇒ 12/91
KADETT E 1.6 i	16SV	07/89 ⇒ 02/93
KADETT E 1.6 S	16SV	09/86 ⇒ 08/91
VECTRA A 1.6	16SV	09/88 ⇒ 05/93
VECTRA A 1.6 S	16SV	09/88 ⇒ 05/93
VAUXHALL		
ASTRA III 1.4 i	C14NZ	09/91 ⇒ 09/98
ASTRAVAN I 1.4 i	C14NZ	09/91 ⇒ 08/95

EPS 1.306.251



07

DISTRIBUTOR CAPS

Adatt./Suitable: BOSCH

BOSCH

1 235 522 417 *A
1 235 522 418GENERAL MOTORS
90 297 426

OPEL

12 11 262
90297426

- *A Available distributor cap only not screen**
- Fornita solo calotta, no copertura
 - Disponible seulement la tete et non pas le couvrle
 - Erhältlich nur die kappe, nicht die haube
 - Disponible solo la tapa, no la cobertura

03 Supplied until depletion

- Fornibile fino ad esaurimento delle scorte
- Fourni jusqu'à épuisement du stock
- Lieferbar solange vorrat reicht
- Suministrado hasta el stock termina



OPEL		
CALIBRA A 2.0 i 16V	C20XE	06/90 ⇒ 02/94
CALIBRA A 2.0 i 16V 4x4	C20XE	06/90 ⇒ 02/94
KADETT E 2.0 GSI 16V	20XE	12/87 ⇒ 08/91
KADETT E 2.0 GSI 16V Cat	C20XE	03/88 ⇒ 08/91
VECTRA A 2.0 i 16V	20XEJ	02/89 ⇒ 10/90
VECTRA A 2.0 i 16V 4x4	C20XE	08/89 ⇒ 08/95
VECTRA A 2.0 i 16V Cat	C20XE	02/90 ⇒ 11/95
VECTRA A 2000 16V 4x4	20XEJ	01/89 ⇒ 10/90
VECTRA A 2000/GT 16V	20XEJ	01/89 ⇒ 06/94
VECTRA A 2000/GT 16V Cat	C20XE	02/90 ⇒ 11/95
VECTRA A 2000/GT 16V Cat 4x4	C20XE	02/90 ⇒ 11/95
VAUXHALL		
CALIBRA 2.0 i 16V	C20XE	06/90 ⇒ 02/94

VAUXHALL

CALIBRA 2.0 i 16V 4x4

C20XE

06/90 ⇒ 02/94

EPS 1.306.252



07,5

DISTRIBUTOR CAPS

Adatt./Suitable: BOSCH

BOSCH

1 235 522 442 *A

CITROËN

5941 47 *A
96 054 877

PEUGEOT

5941 47 *A

***A Available distributor cap only not screen**

- Fornita solo calotta, no copertura
- Disponible seulement la tete et non pas le couvrle
- Erhältlich nur die kappe, nicht die haube
- Disponible solo la tapa, no la cobertura

03 Supplied until depletion

- Fornibile fino ad esaurimento delle scorte
- Fourni jusqu'à épuisement du stock
- Lieferbar solange vorrat reicht
- Suministrado hasta el stock termina



CITROËN		
XM I 3.0	UFZ(ZPJ/Z)	05/89 ⇒ 05/94
XM I 3.0 V6	SFZ(ZPJ/Z), UFZ(ZPJ/Z)	05/89 ⇒ 06/94
XM I 3.0 V6 24V	SKZ(ZPJ4/Z), UKZ(ZPJ4/Z)	07/90 ⇒ 06/94
XM II 3.0 V6	SFZ(ZPJ/Z), UFZ(ZPJ/Z)	05/94 ⇒ 10/00
XM II 3.0 V6 24V	SKZ(ZPJ4/Z), UKZ(ZPJ4/Z)	05/94 ⇒ 10/00
PEUGEOT		
605 3.0	UFZ(ZPJ), UKZ(ZPJ4/Z)	08/89 ⇒ 09/99
605 3.0 SV 24	UKZ(ZPJ4/Z)	08/89 ⇒ 09/99

EPS 1.306.253



05

DISTRIBUTOR CAPS

Adatt./Suitable: BOSCH

BOSCH

1 235 522 423

FORD

6 182 127

Motorcraft

EDH 279

03 Supplied until depletion

- Fornibile fino ad esaurimento delle scorte
- Fourni jusqu'à épuisement du stock
- Lieferbar solange vorrat reicht
- Suministrado hasta el stock termina



FORD		
SCORPIO I 2.0 i	N9B, N9D, N9F, NRA, NRI	05/89 ⇒ 09/94
SIERRA II 2.0 i	N4A, N4I, N9B	01/87 ⇒ 02/93
TRANSIT II 2.0	NSF, NSG	06/94 ⇒ 03/00
TRANSIT II 2.0 CNG	NSH	06/94 ⇒ 03/00
TRANSIT TOURNEO 2.0	NSH	11/94 ⇒ 12/00

1.306.256

EPS 1.306.256



04

DISTRIBUTOR CAPS

Adatt./Suitable: **BOSCH****BOSCH**0 237 521 024 *B
1 235 522 437**GENERAL MOTORS**

90 350 988

HOLDEN

90350988

OPEL12 11 269
90350988**HOLDEN**

BARINA 1.4 i	C14NZ	04/94 ⇒ 07/97
BARINA_SB 1.2i	C12NZ	04/94 ⇒ 07/97
COMBO 1.4 i	C14NZ	03/96 ⇒ 07/97
COMBO_SB 1.4i	C14NZ	04/94 ⇒ 07/97

OPEL

ASTRA F 1.4	14NV	09/91 ⇒ 09/93
ASTRA F 1.4 i	C14NZ	09/91 ⇒ 01/05
COMBO B 1.2	C12NZ	07/94 ⇒ 10/01
COMBO B 1.4	C14NZ	07/94 ⇒ 10/01
CORSA A 1.2	12NC, E12GV	09/82 ⇒ 08/90
CORSA A 1.2 i	C12NZ	09/89 ⇒ 03/93
CORSA A 1.2 N	12NC, E12GV	01/85 ⇒ 10/87
CORSA A 1.4 S	14NV	09/89 ⇒ 03/93
CORSA A 1.6 GSI	E16SE	05/88 ⇒ 03/92
CORSA B 1.2 i	12NZ, C12NZ	03/93 ⇒ 09/00
CORSA B 1.4 i	C14NZ	03/93 ⇒ 09/00
FRONTERA A 2.4 i	C24NE	03/92 ⇒ 10/98
KADETT E 1.4 i	C14NZ	01/90 ⇒ 07/94
KADETT E 1.4 S	14NV	07/89 ⇒ 02/93
KADETT E 1.6	16SV	09/86 ⇒ 12/91
KADETT E 1.6 i	16SV	07/89 ⇒ 02/93
KADETT E 1.6 S	16SV	09/86 ⇒ 08/91
OMEGA A 2.4 i	C24NE	09/88 ⇒ 03/94
VECTRA A 1.4 S	14NV	04/88 ⇒ 06/92
VECTRA A 1.6	16SV	09/88 ⇒ 05/93
VECTRA A 1.6 S	16SV	09/88 ⇒ 05/93

VAUXHALL

ASTRA III 1.4	14NV	09/91 ⇒ 09/93
ASTRA III 1.4 i	C14NZ	09/91 ⇒ 09/98
ASTRA III 1.4 S	14NV	09/91 ⇒ 02/98
ASTRAVAN I 1.4 i	C14NZ	09/91 ⇒ 08/95
COMBO B 1.2	C12NZ	07/94 ⇒ 10/01
COMBO B 1.4	C14NZ	07/94 ⇒ 10/01
CORSA B 1.2 i	C12NZ	03/93 ⇒ 09/00
CORSA B 1.4 i	C14NZ	03/93 ⇒ 09/00
CORSAVAN I 1.4 i	C14NZ	01/94 ⇒ 09/00
FRONTERA A 2.4 i	C24NE	03/92 ⇒ 10/98

EPS 1.306.257



07

DISTRIBUTOR CAPS

Adatt./Suitable: **BOSCH****BOSCH**1 235 522 434
1 235 522 435 *A**GENERAL MOTORS**90 336 536 *A
90 442 358 *A**HOLDEN**

90336536

OPEL12 11 270 *A
12 11 276 *A
90336536

*A Available distributor cap only not screen

- Fornita solo calotta, no copertura
- Disponible seulement la tete et non pas le couvrle
- Erhältlich nur die kappe, nicht die haube
- Disponible solo la tapa, no la copertura

03 Supplied until depletion

- Fornita fino ad esaurimento delle scorte
- Fourni jusqu'à épuisement du stock
- Lieferbar solange vorrat reicht
- Suministrado hasta el stock termina

**HOLDEN**

CALIBRA_YE 2.0i	C20NE	09/91 ⇒ 07/95
CALIBRA_YE 2.0i 16V	C20XE	09/91 ⇒ 07/95
CALIBRA_YE 2.0i 16V Turbo	C20LET	06/94 ⇒ 10/97

OPEL

ASTRA F 1.8 i	C18NZ	09/91 ⇒ 09/98
ASTRA F 2.0 GSI 16V	C20XE	09/91 ⇒ 01/98
ASTRA F 2.0 i	C20NE	09/91 ⇒ 09/98
ASTRA F 2.0 i 16V	C20XE	03/93 ⇒ 01/98
CALIBRA A 2.0 i	C20NE	08/89 ⇒ 12/96
CALIBRA A 2.0 i 4x4	C20NE	06/90 ⇒ 07/97
CALIBRA A 2.0 i Turbo 4x4	C20LET	08/91 ⇒ 07/97
FRONTERA A 2.0 i	C20NE	03/92 ⇒ 10/98
KADETT E 1.8	18SE	01/86 ⇒ 08/91
KADETT E 1.8 i	C18NZ, S18NV	06/85 ⇒ 05/92
KADETT E 1.8 S	E18NV	09/87 ⇒ 08/91
KADETT E 2.0 GSI	20NE, 20SEH	09/86 ⇒ 08/91
KADETT E 2.0 GSI 16V	20XE	12/87 ⇒ 08/91
KADETT E 2.0 GSI 16V Cat	C20XE	03/88 ⇒ 08/91
KADETT E 2.0 GSI Cat	C20NE	09/86 ⇒ 08/91
KADETT E 2.0 i	20NE	10/86 ⇒ 02/93
KADETT E 2.0 i Cat	C20NE	10/86 ⇒ 02/93
OMEGA A 1.8	18SEH, E18NVR, S18NV	09/86 ⇒ 03/94
OMEGA A 1.8 N	18NV	09/86 ⇒ 08/87
OMEGA A 1.8 S	18SV	09/86 ⇒ 03/94
OMEGA A 2.0	20SE, C20NE	09/86 ⇒ 04/94
OMEGA A 2.0 i	C20NE	09/86 ⇒ 04/94
OMEGA B 2.0	20SE	03/94 ⇒ 12/00
VECTRA A 1.8 i	18SV	09/88 ⇒ 10/90
VECTRA A 1.8 i Cat	C18NZ	03/90 ⇒ 11/95
VECTRA A 1.8 S	18SV, E18NVR	09/88 ⇒ 10/90
VECTRA A 1.8 S 4x4	E18NVR	01/89 ⇒ 07/89
VECTRA A 2.0 i	20NE, 20SEH	09/88 ⇒ 09/92
VECTRA A 2.0 i 16V	20XEJ	02/89 ⇒ 10/90
VECTRA A 2.0 i 16V 4x4	C20XE	08/89 ⇒ 08/95
VECTRA A 2.0 i 16V Cat	C20XE	02/90 ⇒ 11/95
VECTRA A 2.0 i 4x4	20NE, 20SEH	01/89 ⇒ 07/92
VECTRA A 2.0 i Cat	C20NE	09/88 ⇒ 11/95
VECTRA A 2.0 i Cat 4x4	C20NE	01/89 ⇒ 11/95
VECTRA A 2.0 i GT	20SEH	09/88 ⇒ 11/95
VECTRA A 2.0 i Turbo 4x4	C20LET	06/94 ⇒ 11/95
VECTRA A 2000 16V 4x4	20XEJ	01/89 ⇒ 10/90
VECTRA A 2000/GT 16V	20XEJ	01/89 ⇒ 06/94
VECTRA A 2000/GT 16V Cat	C20XE	02/90 ⇒ 11/95
VECTRA A 2000/GT 16V Cat 4x4	C20XE	02/90 ⇒ 11/95

VAUXHALL

ASTRA III 1.8 i	C18NZ	09/91 ⇒ 09/98
ASTRA III 2.0 i	C20NE	09/91 ⇒ 09/98
ASTRA III 2.0 i 16V	C20XE	09/91 ⇒ 02/98
CALIBRA 2.0 i	C20NE	06/90 ⇒ 07/97
CALIBRA 2.0 i 4x4	C20NE	06/90 ⇒ 07/97
CALIBRA 2.0 i Turbo 4x4	C20LET	03/92 ⇒ 07/97
FRONTERA A 2.0	C20NE	04/95 ⇒ 08/98
FRONTERA A 2.0 i	C20NE	03/92 ⇒ 10/98
OMEGA B 2.0	20SE	09/95 ⇒ 09/96

EPS 1.306.258



07

DISTRIBUTOR CAPS

Adatt./Suitable: **BOSCH****BOSCH**1 235 522 438
1 235 522 439 *A**GENERAL MOTORS**

90 369 031

MAN

51.26310-0009

OPEL

12 11 273

00 Eliminated on 13-09-2021. Please verify the availability through our local distributors

- Eliminato il 13-09-2021. Verificare la disponibilità presso i nostri distributori
- Éliminé le 13-09-2021. Vérifier la disponibilité auprès de nos distributeurs sur place
- Am 13-09-2021 gestrichen. Evtl. Verfügbarkeit bitte bei unseren Händlern prüfen
- Eliminado en fecha 13-09-2021. Verificar la disponibilidad a través de nuestros distribuidores locales

*A Available distributor cap only not screen

- Fornita solo calotta, no copertura
- Disponible seulement la tete et non pas le couvrle
- Erhältlich nur die kappe, nicht die haube
- Disponible solo la tapa, no la copertura

03 Supplied until depletion

- Fornita fino ad esaurimento delle scorte
- Fourni jusqu'à épuisement du stock
- Lieferbar solange vorrat reicht
- Suministrado hasta el stock termina

**MAN**

NG	E2866DUH01	01/95 ⇒ 07/99
NL	E2866DUH01, E2866DUH02	05/93 ⇒ 07/99

OPEL

OMEGA A 2.6 i	C26NE	09/90 ⇒ 03/94
OMEGA A 3.0	30NE, C30LE, C30NE	03/87 ⇒ 03/94
OMEGA A 3.0 24V	C30SE	09/89 ⇒ 03/94
OMEGA A 3.0 24V Omega 3000	C30SE	09/88 ⇒ 04/94
OMEGA A 3.0 Cat	C30NE	03/87 ⇒ 03/94
SENATOR B 2.5 i	25NE	09/90 ⇒ 09/93
SENATOR B 3.0	30NE, C30LE	09/87 ⇒ 09/93
SENATOR B 3.0 24V	C30SE	09/89 ⇒ 09/93
SENATOR B 3.0 i Cat	C30NE	01/88 ⇒ 09/93

EPS 1.306.260



07

DISTRIBUTOR CAPS

Adatt./Suitable: BOSCH

BOSCH
1 235 522 408 *A
1 235 522 447

RENAULT
74 33 501 944

VOLVO
3501944 *A
35019447 *A

- *A Available distributor cap only not screen
- Fornita solo calotta, no copertura
 - Disponible seulement la tete et non pas le couvercle
 - Erhältlich nur die kappe, nicht die haube
 - Disponible solo la tapa, no la cobertura



RENAULT		
SAFRANE II 2.5 20V	N7U700, N7U701	07/96 ⇒ 12/00
VOLVO		
850 2.0	B5202S, B5204F, B5204FS	06/91 ⇒ 12/96
850 2.0 10V	B5202FS	08/94 ⇒ 12/97
850 2.0 Turbo	B5204FT, B5204T, B5204T2	02/93 ⇒ 10/97
850 2.3	B5234FS	01/96 ⇒ 10/96
850 2.3 T5	9M9T872	02/93 ⇒ 12/96
850 2.3 T5-R	B5234T4	08/95 ⇒ 12/96
850 2.3 Turbo R	B5234T5	06/95 ⇒ 10/97
850 2.4	B5252, B5252FS, B5254S	06/91 ⇒ 12/96
850 2.4 AWD	B5254T	04/96 ⇒ 12/96
850 2.4 GLE	B5254T	09/93 ⇒ 10/97
850 2.5 10V	B5252FS	06/91 ⇒ 12/97
850 2.5 20V	B5254FS	08/91 ⇒ 12/97
C70 I 2.0	B5204T2	03/97 ⇒ 10/05
C70 I 2.0 T	B5204T3	03/97 ⇒ 10/05
C70 I 2.3 T5	B5234T3	03/98 ⇒ 10/05
C70 I 2.3 T-5	B5234T3	03/97 ⇒ 09/02
C70 I 2.4 T	B5254T	03/97 ⇒ 10/05
S70 2.0	B5202FS, B5202S, B5204T2	01/97 ⇒ 11/00
S70 2.0 Turbo	B5204T3	01/97 ⇒ 11/00
S70 2.3	B5234FS, B5234T7	01/97 ⇒ 07/99
S70 2.3 AWD	B5234T7	04/99 ⇒ 09/00
S70 2.3 T-5	B5234T3	01/97 ⇒ 11/00
S70 2.3 T5 AWD	B5234T4	07/97 ⇒ 09/00
S70 2.3 T5-R AWD	B5234T2	11/96 ⇒ 09/98
S70 2.3 Turbo	B5234FT+	01/97 ⇒ 11/00
S70 2.4	B5254S	06/98 ⇒ 11/00
S70 2.4 AWD	B5252FS	11/96 ⇒ 05/99
S70 2.4 Bifuel	GB5252S	10/98 ⇒ 11/00
S70 2.4 T5 AWD	B5254T	11/96 ⇒ 04/99
S70 2.4 Turbo	B5254T	01/97 ⇒ 11/00
S70 2.5 20V	B5254FS	01/97 ⇒ 12/98
S70 2.5 Bifuel	GB5252S2	01/99 ⇒ 12/99
V70 I 2.0	B5202FS, B5202S, B5204T2	12/95 ⇒ 03/00
V70 I 2.0 Turbo	B5204T3	11/96 ⇒ 12/00
V70 I 2.0 Turbo AWD	B5204T3	11/96 ⇒ 12/00
V70 I 2.3	B5234FS	01/97 ⇒ 07/99
V70 I 2.3 AWD	B5234T3, B5234T7	04/97 ⇒ 09/98
V70 I 2.3 T AWD	B5234FT+, B5234T4, B5234T6	04/97 ⇒ 12/98
V70 I 2.3 T-5	B5234T3	11/96 ⇒ 12/00
V70 I 2.3 T-5 AWD	B5234T3	01/97 ⇒ 12/00
V70 I 2.3 Turbo	B5234FT+, B5234T2, B5234T4	12/95 ⇒ 12/98
V70 I 2.4	B5252FS, B5254S	12/95 ⇒ 12/99
V70 I 2.4 Bifuel	GB5252S	05/98 ⇒ 12/99
V70 I 2.4 Turbo AWD	B5254T	04/96 ⇒ 12/00
V70 I 2.5	B5252FS	01/97 ⇒ 03/00
V70 I 2.5 20V	B5254FS	01/97 ⇒ 12/99
V70 I 2.5 Bifuel	GB5252S2	01/99 ⇒ 12/99

EPS 1.306.261



04

DISTRIBUTOR CAPS

Adatt./Suitable: BOSCH

BOSCH
1 235 522 372

- 00 Eliminated on 14-04-2020. Please verify the availability through our local distributors
- Eliminato il 14-04-2020. Verificare la disponibilità presso i nostri distributori
 - Éliminé le 14-04-2020. Vérifier la disponibilité auprès de nos distributeurs sur place
 - Am 14-04-2020 gestrichen. Evtl. Verfügbarkeit bitte bei unseren Händlern prüfen
 - Eliminado en fecha 14-04-2020. Verificar la disponibilidad a través de nuestros distribuidores locales



EPS 1.306.263



05

DISTRIBUTOR CAPS

Adatt./Suitable: BOSCH

BOSCH
1 235 522 453 *A
1 235 522 454 *A

SEAT
037 905 207

VW
037 905 207 *A

- *A Available distributor cap only not screen
- Fornita solo calotta, no copertura
 - Disponible seulement la tete et non pas le couvercle
 - Erhältlich nur die kappe, nicht die haube
 - Disponible solo la tapa, no la cobertura



SEAT		
CORDOBA I 2.0 i 16V	ABF	08/96 ⇒ 06/99
IBIZA II 2.0 i 16V	ABF	08/96 ⇒ 08/99
TOLEDO I 2.0 i 16V	ABF	11/93 ⇒ 03/99
VW		
GOLF III 2.0 GTI 16V	ABF	08/92 ⇒ 08/97
PASSAT III 2.0 16V	ABF	01/94 ⇒ 05/97

DISTRIBUTOR CAPS

Adatt./Suitable: BOSCH

AUDI
027 905 207 A
051 905 207

BOSCH
0 290 004 019
1 230 591 040
1 235 522 375
1 235 522 444

SEAT
027 905 207 A
051 905 207

VW
027 905 207 A
051 905 207



AUDI		
80 II 1.6	SA	02/86 ⇒ 07/86
80 II 1.8	SF	02/86 ⇒ 07/86
80 II 1.8 GTE	DZ, MU, PV	06/84 ⇒ 03/87
80 III 1.4	SE	08/86 ⇒ 07/88
80 III 1.6	ABB, PP, RN, RNA	09/86 ⇒ 10/91
80 III 1.8	RU, SD	09/86 ⇒ 01/90
80 III 1.8 E	DZ	06/86 ⇒ 08/91
80 III 1.8 S	JN, JV, NE, PM, SF	08/86 ⇒ 10/91
80 III 2.0	AAD	10/90 ⇒ 08/91
80 III 2.0 E	3A	08/88 ⇒ 10/90
80 IV 1.6	ABB, ABM	09/91 ⇒ 12/94
80 IV 1.6 E	ADA	06/93 ⇒ 01/96
80 IV 2.0	ABT	09/91 ⇒ 01/96
80 IV 2.0 E	ABK	09/91 ⇒ 01/96
80 IV 2.0 quattro	ADW	11/93 ⇒ 01/96
100 III 1.8	NP, SH	02/86 ⇒ 12/90
100 III 1.8 Cat	4B, PH	03/85 ⇒ 11/90
100 IV 1.6	ABB	03/92 ⇒ 07/93
100 IV 2.0	AAE	12/90 ⇒ 07/94
100 IV 2.0 E	AAD, AAE, ABK	12/90 ⇒ 07/94
A6 I 2.0	AAE, ABK, ADW	06/94 ⇒ 12/97
A4 I 1.6	ADP	11/94 ⇒ 09/01
CABRIOLET 2.0 E	ABK	01/93 ⇒ 07/98
COUPE 1.8	DZ	08/89 ⇒ 07/91
COUPE 2.0	3A, AAD, ABK	05/89 ⇒ 12/96
SEAT		
CORDOBA I 1.0 16V	AST, AVZ	05/00 ⇒ 10/02
CORDOBA I 1.0 CL	AAU	02/93 ⇒ 06/96
CORDOBA I 1.3	AAV	02/93 ⇒ 08/94
CORDOBA I 2.0 i	AGG	02/93 ⇒ 06/99
IBIZA II 1.0 16V	AST, AVZ	10/99 ⇒ 02/02
IBIZA II 1.3 i	8C20H00D	03/93 ⇒ 08/99
INCA 1.4 i	AEX, AKV, APQ	11/95 ⇒ 06/03
INCA 1.6 i	1F, AEE	11/95 ⇒ 05/98
ALHAMBRA I / II 2.0 i	ADY	04/96 ⇒ 03/10
TOLEDO I 1.6 i	1F, AFT	05/91 ⇒ 03/99
TOLEDO I 1.8 i	ADZ, RP	05/91 ⇒ 12/96
TOLEDO I 2.0 i	AGG	05/91 ⇒ 03/99
VW		
PASSAT IV 1.6	ADP	10/96 ⇒ 11/00
POLO II 1.0	AAU, HZ	01/85 ⇒ 09/94
POLO II 1.0 Cat	AAU, ACM	08/89 ⇒ 09/94
POLO II 1.3	3F	10/90 ⇒ 09/94
POLO II 1.3 Cat	2G, 3F, AAV	07/87 ⇒ 09/94
POLO II 1.3 G40	PY	08/90 ⇒ 09/94
JETTA II 1.0	HZ	08/85 ⇒ 10/91
JETTA II 1.3 Cat	2G, NZ	06/87 ⇒ 12/91
JETTA II 1.6	ABN, EZ, EZA, HM, PN, RF	12/83 ⇒ 07/92
JETTA II 1.8	EV, GU, GX, PB, RD, RV	01/84 ⇒ 10/91
JETTA II 1.8 16V	KR, PL	08/86 ⇒ 10/91
JETTA II 1.8 Cat	GX, PF, RP	01/87 ⇒ 10/91
JETTA II 1.8 G60	PG	04/90 ⇒ 07/91
JETTA II 1.8 Syncro	GU, RP	08/87 ⇒ 12/88
JETTA II 1.8i GT	GZ	12/83 ⇒ 07/88
CADDY I 1.8	JH	08/85 ⇒ 07/92
CADDY II 1.6	1F	11/95 ⇒ 05/97
CADDY II 75 1.6	1F	11/95 ⇒ 05/97
CORRADO 1.8 16V	KR	04/89 ⇒ 07/92

VW			
CORRADO 1.8 G60	PG	09/88	⇒ 09/93
CORRADO 2.0 i	2E, ADY	04/93	⇒ 12/95
CORRADO 2.0 i 16V	7TZ220XS560	08/91	⇒ 12/95
GOLF I 1.6	EW, HN	08/83	⇒ 04/92
GOLF I 1.8	2H, DX, EX, JH, KT	08/82	⇒ 04/93
GOLF II 1.0	HZ	08/85	⇒ 10/91
GOLF II 1.3 Cat	2G, NZ	06/86	⇒ 12/92
GOLF II 1.6	ABN, EZ, PN, RF	08/83	⇒ 12/92
GOLF II 1.6 [CHE] [SWE]	HM	08/86	⇒ 07/88
GOLF II 1.6 G	EZA, PN	08/86	⇒ 07/91
GOLF II 1.8	GU, GX, RV	08/84	⇒ 10/91
GOLF II 1.8 [CHE] [SWE]	HV	08/86	⇒ 07/87
GOLF II 1.8 GTI	EV, PB, RD	08/83	⇒ 10/91
GOLF II 1.8 GTI 16V	KR, PL	02/86	⇒ 10/91
GOLF II 1.8 GTI Cat	PF	01/87	⇒ 10/91
GOLF II 1.8 GTI G60	PG	04/90	⇒ 07/91
GOLF II 1.8 GTI G60 Syncro	PG	08/88	⇒ 12/91
GOLF II 1.8 i	RP	08/87	⇒ 07/91
GOLF II 1.8 i Cat	GX, RP	08/87	⇒ 10/91
GOLF II 1.8 i Cat Syncro	RP	08/87	⇒ 10/91
GOLF II 1.8 Syncro	3E82, GU	02/86	⇒ 07/91
GOLF II 1.8i GTI [CHE] [SWE]	GZ	08/86	⇒ 07/87
GOLF II 1.8i GTI [SWE]	GZ	08/87	⇒ 07/88
PASSAT III 1.6	1F, ABN, AEK, AFT, EZ	04/88	⇒ 08/96
PASSAT III 1.8	AAM, ABS, ADZ, KR, PB, PF, RP	02/88	⇒ 05/97
PASSAT III 1.8 16V	KR	04/88	⇒ 12/89
PASSAT III 1.8 GL	KR	08/91	⇒ 09/93
PASSAT III 2.0	2E, ADY, AEP, AGG	02/90	⇒ 05/97
PASSAT III 2.0 16V	7TZ220XS560	08/88	⇒ 09/93
PASSAT III 2.0 Syncro	2E, ADY, AGG	03/90	⇒ 12/96
PASSAT III 2.0i	ACX	08/92	⇒ 12/96
GOLF III 1.4	ABD	10/91	⇒ 04/99
GOLF III 1.6	ABU, AEK, AFT, AKS	09/92	⇒ 04/99
GOLF III 1.8	AAM, ABS, ADZ	08/91	⇒ 04/99
GOLF III 1.8 Syncro	ABS, ADZ	01/93	⇒ 04/99
GOLF III 2.0	2E, ADY, AEP, AGG, AKR	11/91	⇒ 04/99
GOLF III 2.0 GL	AEP	08/95	⇒ 09/97
GOLF III 2.0 Syncro	AGG	08/95	⇒ 04/99
GOLF IV 1.6	AFT, AKS	06/98	⇒ 06/02
GOLF IV 1.8	AAM, ADZ, ANN, ANP	06/98	⇒ 06/02
GOLF IV 2.0	AGG, AKR, ATU, AWF, AWG	06/98	⇒ 06/02
POLO III 1.6	AFT	05/97	⇒ 09/01
POLO III 100 1.6	AFT	12/95	⇒ 09/01
POLO III 2.0	ADC	08/99	⇒ 09/01
POLO III 75 1.6	1F	11/95	⇒ 09/97
POLO III 90 1.8	ADD	01/97	⇒ 09/01
SCIROCCO II 1.6	EW, EWA, HN, RE	01/83	⇒ 07/90
SCIROCCO II 1.8	DX, EX, JH, KT	08/82	⇒ 07/92
SCIROCCO II 1.8 16V	KR, PL	10/85	⇒ 07/92
SHARAN I 2.0	ADY	09/95	⇒ 03/10
TRANSPORTER IV 1.8	5K7M710	12/90	⇒ 07/92
TRANSPORTER IV 2.0	AAC	07/90	⇒ 04/03
VENTO 1.6	AEK, AFT, AKS	10/94	⇒ 02/99

EPS 1.307.701



04

DISTRIBUTOR CAPS

Adatt./Suitable: CAJAVEC

YUGO

4660870

ZASTAVA

4660870



ZASTAVA

101 1.1	128A.000	06/73	⇒ 01/90
YUGO 0.9	9A	04/80	⇒ 06/92

EPS 1.312.066



04

DISTRIBUTOR CAPS

Adatt./Suitable: DELCO REMY

OPEL

12 12 140

VOLVO

3277854

32778540

03 Supplied until depletion

- Fornibile fino ad esaurimento delle scorte
- Fourni jusqu'à épuisement du stock
- Lieferbar solange vorrat reicht
- Suministrado hasta el stock termina



OPEL

CORSA A 1.0	10S	09/82	⇒ 03/93
KADETT B 1.1	11N	08/71	⇒ 08/73
KADETT D 1.0	10N	09/79	⇒ 08/82
KADETT E 1.2	12SC	09/84	⇒ 07/86

EPS 1.312.073



07

DISTRIBUTOR CAPS

Adatt./Suitable: DELCO REMY

DELCO REMY

1 972 927

D-340

GENERAL MOTORS

01 972 927

1 972 927

OPEL

01972927

12 11 258

03 Supplied until depletion

- Fornibile fino ad esaurimento delle scorte
- Fourni jusqu'à épuisement du stock
- Lieferbar solange vorrat reicht
- Suministrado hasta el stock termina



OPEL

ASCONA C 1.3 N	13N	09/81	⇒ 08/86
ASCONA C 1.6	16SV	09/86	⇒ 08/88
ASCONA C 1.6 i Cat	C16LZ, C16NZ	09/86	⇒ 08/88
ASTRA F 1.6 i	C16NZ	09/91	⇒ 09/98
CORSA A 1.2	12S, 12ST	09/82	⇒ 08/90
CORSA A 1.2 N	12NV	01/90	⇒ 03/93
CORSA A 1.2 S	12S, 12ST	09/82	⇒ 03/93
CORSA A 1.3	13NB, 13SB	09/85	⇒ 10/89
CORSA A 1.3 GL	13S	09/82	⇒ 03/93
CORSA A 1.3 S	13SB	09/82	⇒ 10/89
KADETT D 1.2	12ST	08/82	⇒ 08/84
KADETT E 1.3 i Cat	C13N	09/85	⇒ 08/91
KADETT E 1.3 N	13N, 13NB	09/84	⇒ 08/91
KADETT E 1.3 S	13S	09/84	⇒ 02/93
KADETT E 1.6	16SV	09/86	⇒ 12/91
KADETT E 1.6 i	16SV, C16NZ, E16NZ	09/86	⇒ 07/94
KADETT E 1.6 i Cat	C16LZ, C16NZ	09/86	⇒ 02/93
KADETT E 1.6 S	16SV	09/86	⇒ 08/91
MANTA B 1.3 S	13S	08/81	⇒ 08/86
VECTRA A 1.6 i	C16NZ, E16NZ, X16SZ	09/88	⇒ 11/95
VECTRA A 1.6 i Cat	C16NZ	09/88	⇒ 11/95

VAUXHALL

ASTRA III 1.6 i	C16NZ	09/91	⇒ 12/98
ASTRAVAN I 1.6 i	C16NZ	10/91	⇒ 08/98

EPS 1.312.074



07

DISTRIBUTOR CAPS

Adatt./Suitable: DELCO REMY

DELCO REMY

1 985 771

GENERAL MOTORS

01 985 771

1 985 771

OPEL

01985771

12 11 260

00 Eliminated on 22-02-2022. Please verify the availability through our local distributors

- Eliminato il 22-02-2022. Verificare la disponibilità presso i nostri distributori
- Éliminé le 22-02-2022. Vérifier la disponibilité auprès de nos distributeurs sur place
- Am 22-02-2022 gestrichen. Evtl. Verfügbarkeit bitte bei unseren Händlern prüfen
- Eliminado en fecha 22-02-2022. Verificar la disponibilidad a través de nuestros distribuidores locales



OPEL

ASCONA C 1.6	16SV	09/86	⇒ 08/88
CORSA A 1.2	12S	09/82	⇒ 08/90
CORSA A 1.2 S	12S	09/82	⇒ 10/87
CORSA A 1.3	13NB	09/85	⇒ 10/89
KADETT E 1.3 N	13N, 13NB	09/84	⇒ 08/91
KADETT E 1.3 S	13S	09/84	⇒ 02/93
KADETT E 1.6	16SV	09/86	⇒ 12/91
KADETT E 1.6 i	16SV	07/89	⇒ 02/93
KADETT E 1.6 S	16SV	09/86	⇒ 08/91

EPS 1.312.075



07

DISTRIBUTOR CAPS

Adatt./Suitable: DELCO REMY

BOSCH

F 005 X04 443

F 005 X04 444

DAEWOO

10467543

10496278

HOLDEN

10457153

10496278

ISUZU

8-10496278-0

03 Supplied until depletion

- Fornibile fino ad esaurimento delle scorte
- Fourni jusqu'à épuisement du stock
- Lieferbar solange vorrat reicht
- Suministrado hasta el stock termina



DAEWOO

ARANOS 1.5	V15L	01/95	⇒ 11/97
ARANOS 1.8	Y18L	01/95	⇒ 11/97
ARANOS 2.0	Y20L	01/95	⇒ 11/97
ESPERO 1.5 16V	A15MF	02/95	⇒ 06/99
ESPERO 1.8	C18LE	02/95	⇒ 06/99
ESPERO 2.0	C20LE	02/95	⇒ 06/99
NEXIA 1.5	G15MF	02/95	⇒ 08/97
NEXIA 1.5 16V	A15MF	02/95	⇒ 08/97

HOLDEN

ASTRA_LD 1.6i	16LE	07/87	⇒ 07/89
ASTRA_LD 1.8i Hatchback	18LE	07/87	⇒ 07/89
ASTRA_LD 1.8i Sedan	18LE	07/87	⇒ 07/89
CAMIRA 1.8 SPFi	6T2204XS85K01	02/86	⇒ 03/87

HOLDEN		
CAMIRA 2.0 i	C20JE	04/87 ⇒ 07/89
ISUZU		
IMPULSE 1.6i [USA]	RLK	01/90 ⇒
IMPULSE 1.8i [USA]	RLX	01/91 ⇒
STYLUS 1.6i DOHC [USA]	RLK	01/90 ⇒ 12/91
STYLUS 1.6i SOHC [USA]	RLR	01/90 ⇒
STYLUS 1.8i DOHC [USA]	RLX	01/91 ⇒

EPS 1.313.092



04

DISTRIBUTOR CAPS

Adatt./Suitable: DENSO

GENERAL MOTORS

94 216 730

HOLDEN

8942167300

TOYOTA

19101-15010

⁰³ Supplied until depletion

- Fornibile fino ad esaurimento delle scorte
- Fourni jusqu'à épuisement du stock
- Lieferbar solange vorrat reicht
- Suministrado hasta el stock termina



HOLDEN		
GEMINI_RB 1.5	4XC1	04/85 ⇒ 06/87

EPS 1.313.093



04

DISTRIBUTOR CAPS

Adatt./Suitable: DENSO

BOSCH

F 005 X04 427

DAIHATSU

19101-2507

19101-25070-000

HOLDEN

3332160A10

3332175110

SUZUKI

8-94129202-0

8-94219202-0

OPEL

42 94 009

SUZUKI

33321-60A10

33321-60A10-000

33321-75110

33321-75110-000

TOYOTA

19101-25070

19101-38011



HOLDEN		
DROVER QB 1.3	G13A	02/85 ⇒ 12/87
JACKAROO_UBS 2.2 4x4	4ZD1	03/87 ⇒ 10/88
RODEO_KB 2.3	2.25	03/87 ⇒ 07/88
RODEO_KB 2.3 4x4	2.25	03/87 ⇒ 07/88
SCURRY_NB 1.0	F10A	10/85 ⇒ 05/86
SHUTTLE_WFR 2.0	4ZC1	06/86 ⇒ 06/89

OPEL		
MIDI 2.0 i	20PET	09/92 ⇒ 08/94
MIDI 2.0 i 4x4	20PET	09/92 ⇒ 08/94

SUZUKI		
SAMURAI 1.3 Trazione integrale	G13A	11/88 ⇒ 12/04
SIDEKICK 1.6i [USA]	--	01/89 ⇒ 12/91
SJ410 1.0	F10A	09/81 ⇒ 07/91
SJ413 1.3	G13A	09/84 ⇒ 08/90
SUPER CARRY 1.0	F10A	10/85 ⇒ 03/99
VITARA 1.6 8V	--	01/90 ⇒ 12/98

TOYOTA		
STARLET 1.3 [USA]	4KE	01/82 ⇒ 12/84

EPS 1.313.094



05

DISTRIBUTOR CAPS

Adatt./Suitable: DENSO

BOSCH

F 005 X04 426

DAIHATSU

19101-87703

19101-87703-000

FIAT

553221201

6553221201

INNOCENTI

6553221201

⁰³ Supplied until depletion

- Fornibile fino ad esaurimento delle scorte
- Fourni jusqu'à épuisement du stock
- Lieferbar solange vorrat reicht
- Suministrado hasta el stock termina



DAIHATSU		
CHARADE III 1.0	CB23, CB22	03/87 ⇒ 02/93
INNOCENTI		
500 L; LS	--	⇒ 12/86
SMALL 990	--	07/90 ⇒ 12/92

EPS 1.313.099



07

DISTRIBUTOR CAPS

Adatt./Suitable: DENSO

BOSCH

F 005 X04 496

TOYOTA

19101-35020

19101-35120

19101-35140

19101-35180

19101-35190

19101-38210

VW

J19 101 351 80

⁰³ Supplied until depletion

- Fornibile fino ad esaurimento delle scorte
- Fourni jusqu'à épuisement du stock
- Lieferbar solange vorrat reicht
- Suministrado hasta el stock termina



TOYOTA		
4 RUNNER 2.4 i [USA]	22RE	01/88 ⇒ 12/93
HILUX IV 2.4 4WD	22R	10/88 ⇒ 12/97
HILUX V 2.4 4WD	22R	10/88 ⇒ 08/97
HILUX V 2.4 i 4WD	22RE	01/89 ⇒ 07/97
LAND CRUISER 70 2.4	22R, 22RE	11/84 ⇒ 12/96
TRUCK 2.4 i [USA]	22R, 22RE	01/88 ⇒ 12/92
VW		
TARO 2.4 i 4x4	22R	06/89 ⇒ 03/97

EPS 1.313.102



04

DISTRIBUTOR CAPS

Adatt./Suitable: DENSO

SUZUKI

33321-79210

33321-79210-000

⁰³ Supplied until depletion

- Fornibile fino ad esaurimento delle scorte
- Fourni jusqu'à épuisement du stock
- Lieferbar solange vorrat reicht
- Suministrado hasta el stock termina



EPS 1.313.107



04

DISTRIBUTOR CAPS

Adatt./Suitable: DENSO

SUZUKI

33321-78110

33321-78110-000

33321-79611

33321-79611-000

33321-82010

33321-82010-000

⁰³ Supplied until depletion

- Fornibile fino ad esaurimento delle scorte
- Fourni jusqu'à épuisement du stock
- Lieferbar solange vorrat reicht
- Suministrado hasta el stock termina



MARUTI		
800 0.8	F8B	01/91 ⇒ 12/06
SUZUKI		
ALTO I 0.8	F8A, F8B	06/82 ⇒ 08/84

EPS 1.313.113



07

DISTRIBUTOR CAPS

Adatt./Suitable: DENSO

BOSCH

F 005 X04 503

TOYOTA

19101-71010

VW

J19 101 710 10

⁰³ Supplied until depletion

- Fornibile fino ad esaurimento delle scorte
- Fourni jusqu'à épuisement du stock
- Lieferbar solange vorrat reicht
- Suministrado hasta el stock termina

²¹¹ Resistance [kOhm] 15

- Resistenza [kOhm] 15
- Résistance [kOhm] 15
- Widerstand [kOhm] 15
- Resistencia [kOhm] 15



TOYOTA		
DYNA 1.8	2Y	05/95 ⇒ 08/01
DYNA 2.0	3Y	05/95 ⇒ 10/01
DYNA 100 1.8	2Y	08/85 ⇒ 04/95
HILUX IV 1.8	2Y	08/83 ⇒ 03/89
HILUX IV 2.2	4Y	08/83 ⇒ 12/89
HILUX IV 2.2 4WD	4Y	11/85 ⇒ 12/89

1.313.114

TOYOTA			
HILUX V 1.8	2Y	09/88 ⇒	06/98
LITEACE 2.2	4Y-EC	01/92 ⇒	01/95
MODEL F 2.0	3Y	08/88 ⇒	01/90
MODEL F 2.2	4Y-EC	08/85 ⇒	01/90
VAN 2.0 [USA]	3YEC	01/83 ⇒	12/90
VAN 2.2 [USA]	4YEC	01/83 ⇒	12/90
VW			
TARO 1.8	2Y	04/89 ⇒	09/94
TARO 2.2	4Y	06/89 ⇒	07/94
TARO 2.2 4x4	4Y	06/89 ⇒	07/94

EPS 1.313.114



04

DISTRIBUTOR CAPS

Adatt./Suitable: DENSO

TOYOTA

19101-71020

VW

J19 101 710 20

⁰³ Supplied until depletion

- Fornibile fino ad esaurimento delle scorte
- Fourni jusqu'à épuisement du stock
- Lieferbar solange vorrat reicht
- Suministrado hasta el stock termina



TOYOTA

DYNA 1.6	1Y	05/85 ⇒	08/87
DYNA 1.8	2Y	05/95 ⇒	08/01
DYNA 100 1.8	2Y	08/85 ⇒	04/95
DYNA 150 2.0	3Y	08/85 ⇒	08/88
HIACE III 2.0	3Y	12/82 ⇒	08/89
HIACE III 2.0 4WD	3Y	08/87 ⇒	07/89
HIACE III 2.2	4Y	09/87 ⇒	08/89
HIACE III 2.2 4WD	4Y	08/87 ⇒	08/89
HILUX IV 1.8	2Y	08/83 ⇒	03/89
HILUX IV 2.2	4Y	08/83 ⇒	12/89
HILUX IV 2.2 4WD	4Y	11/85 ⇒	12/89
HILUX V 1.8	2Y	09/88 ⇒	06/98
LITEACE 1.5	5K	10/85 ⇒	01/92
STOUT 2.2	4Y	04/88 ⇒	02/00

VW

TARO 1.8	2Y	04/89 ⇒	09/94
TARO 2.2	4Y	06/89 ⇒	07/94
TARO 2.2 4x4	4Y	06/89 ⇒	07/94

EPS 1.313.117



04

DISTRIBUTOR CAPS

Adatt./Suitable: DENSO

BOSCH

1 987 233 120

MITSUBISHI

MD604411

⁰³ Supplied until depletion

- Fornibile fino ad esaurimento delle scorte
- Fourni jusqu'à épuisement du stock
- Lieferbar solange vorrat reicht
- Suministrado hasta el stock termina



MITSUBISHI

VALLEY 2.0	4G63-T	09/92 ⇒	10/94
------------	--------	---------	-------

EPS 1.313.119



05

DISTRIBUTOR CAPS

Adatt./Suitable: DENSO

BOSCH

F 005 X04 492

F 005 X04 521

TOYOTA

19101-01030

19101-16080

19101-16220

⁰³ Supplied until depletion

- Fornibile fino ad esaurimento delle scorte
- Fourni jusqu'à épuisement du stock
- Lieferbar solange vorrat reicht
- Suministrado hasta el stock termina



TOYOTA

CELICA IV 1.6 GT	4A-GELC	08/87 ⇒	08/89
CELICA IV 1.6 GT 16V	4A-GEL	09/85 ⇒	08/89
CELICA IV 1.6 GTi 16V	4A-GEL	01/88 ⇒	12/89
COROLLA V 1.6	4A-GELC	05/85 ⇒	04/87
MR 2 I 1.6 16V	4A-GELC	11/84 ⇒	06/90
MR 2 I 1.6 Supercharged	4A-GZE	08/86 ⇒	12/89

EPS 1.313.122



07

DISTRIBUTOR CAPS

Adatt./Suitable: DENSO

GENERAL MOTORS

94 404 560

ISUZU

8-94404560-0

TOYOTA

19101-11010

⁰³ Supplied until depletion

- Fornibile fino ad esaurimento delle scorte
- Fourni jusqu'à épuisement du stock
- Lieferbar solange vorrat reicht
- Suministrado hasta el stock termina

²¹¹ Resistance [kOhm] 15

- Resistenza [kOhm] 15
- Résistance [kOhm] 15
- Widerstand [kOhm] 15
- Resistencia [kOhm] 15



TOYOTA

CELICA IV 1.6	4A-L	04/86 ⇒	08/89
COROLLA VI 1.3	2E	05/87 ⇒	06/92
COROLLA VI 1.3 i	2E, 2E-E	08/87 ⇒	06/92
STARLET 1.3 12V	2E, 2E-E	12/89 ⇒	12/92
STARLET 1.3 12V Cat	2E-E	12/89 ⇒	03/96
STARLET 1.3 XL	2E	12/89 ⇒	12/91
TERCEL 1.5	--	01/86 ⇒	

EPS 1.313.123



04

DISTRIBUTOR CAPS

Adatt./Suitable: DENSO

GENERAL MOTORS

96 066 464

SUBARU

33321-63B10

SUZUKI

33321-63B10

33321-63B10-000

33321-86510

33321-86510-000



SUBARU

JUSTY II 1.3i	G13BA	05/96 ⇒	09/00
---------------	-------	---------	-------

SUZUKI

ALTO IV 1.0	G10BB	09/94 ⇒	06/02
ALTO V 1.0	G10BB	01/00 ⇒	06/02
SWIFT I / II / III 1.3	G13A, G13B, G13BA	03/89 ⇒	10/96
SWIFT I / II / III 1.3 4WD	G13A	03/89 ⇒	12/91
SWIFT I / II / III 1.3 GTi SOHC	G13B	10/89 ⇒	12/95
SWIFT I / II / III 1.3 i	G13BA	09/91 ⇒	10/96
SWIFT I / II / III 1.3i SOHC [USA]	--	01/89 ⇒	12/94
SWIFT I / II / III 1.6 i 16V	G16BA	08/92 ⇒	10/96
SWIFT I / II / III 1.6 i 16V 4x4	G16BA	08/92 ⇒	10/96
SIDEKICK 1.6 JX 4x4	G16A(8V)	04/89 ⇒	04/96
SIDEKICK 1.6i 16V JX 4x4	G16B	04/89 ⇒	04/96
SWIFT III 1.3 [USA]	--	06/95 ⇒	05/01
SWIFT III 1.3 i	G13BA	06/96 ⇒	03/01
VITARA I 1.6	G16A(8V), G16B	07/88 ⇒	03/98
VITARA I 1.6 i 16V	G16B	07/90 ⇒	03/99
VITARA I 1.6 i 16V Trazione integrale	G16B	07/90 ⇒	03/98
VITARA I 1.6 Trazione integrale	G16A(8V)	07/88 ⇒	03/98

EPS 1.313.128



04

DISTRIBUTOR CAPS

Adatt./Suitable: DENSO

DAIHATSU

19101-87207-000

⁰⁰ Eliminated on 14-04-2021. Please verify the availability through our local distributors

- Eliminato il 14-04-2021. Verificare la disponibilità presso i nostri distributori
- Éliminé le 14-04-2021. Vérifier la disponibilité auprès de nos distributeurs sur place
- Am 14-04-2021 gestrichen. Evtl. Verfügbarkeit bitte bei unseren Händlern prüfen
- Eliminado en fecha 14-04-2021. Verificar la disponibilidad a través de nuestros distribuidores locales



DAIHATSU

CUORE II 0.8	ED10	09/85 ⇒	12/90
CUORE II 0.8 4WD	ED10	09/86 ⇒	10/88
DOMINO 0.8	ED	08/85 ⇒	07/90
MIRA 847	--	01/87 ⇒	

EPS 1.313.240



04

DISTRIBUTOR CAPS

Adatt./Suitable: DENSO

BOSCH
1 987 233 101
TOYOTA
19101-10020

⁰⁰Eliminated on 02-08-2021. Please verify the availability through our local distributors

- Eliminato il 02-08-2021. Verificare la disponibilità presso i nostri distributori
- Éliminé le 02-08-2021. Vérifier la disponibilité auprès de nos distributeurs sur place
- Am 02-08-2021 gestrichen. Evtl. Verfügbarkeit bitte bei unseren Händlern prüfen
- Eliminado en fecha 02-08-2021. Verificar la disponibilidad a través de nuestros distribuidores locales



TOYOTA

STARLET 1.0	1E	12/89 ⇨ 12/92
-------------	----	---------------

EPS 1.313.241



04

DISTRIBUTOR CAPS

Adatt./Suitable: DENSO

SUBARU
22162-KA010

⁰³Supplied until depletion

- Fornibile fino ad esaurimento delle scorte
- Fourni jusqu'à épuisement du stock
- Lieferbar solange vorrat reicht
- Suministrado hasta el stock termina



SUBARU

E-SERIES 1.0	--	01/87 ⇨ 12/92
E-SERIES 1.2	--	01/87 ⇨ 12/92

EPS 1.313.245



04

DISTRIBUTOR CAPS

Adatt./Suitable: DENSO

BOSCH
1 987 233 128
GENERAL MOTORS
96 061 557
SUZUKI
33321-85570
33321-85570-000



SUZUKI

SWIFT I / II / III 1.0 i	G10	03/89 ⇨ 12/05
WAGON R III 1.0	Z10XEP	06/04 ⇨ 08/05
WAGON R+ II 1.0	K10A	08/00 ⇨ 07/03

SUZUKI

WAGON R+ II 1.0 XT Plus	--	08/00 ⇨ 07/01
-------------------------	----	---------------

EPS 1.313.248



07

DISTRIBUTOR CAPS

Adatt./Suitable: DENSO

TOYOTA
19101-16250

⁰³Supplied until depletion

- Fornibile fino ad esaurimento delle scorte
- Fourni jusqu'à épuisement du stock
- Lieferbar solange vorrat reicht
- Suministrado hasta el stock termina



TOYOTA

COROLLA VI 1.6 GTi	4A-GE	08/87 ⇨ 10/94
--------------------	-------	---------------

EPS 1.313.251



07

DISTRIBUTOR CAPS

Adatt./Suitable: DENSO

BOSCH
F 005 X12 276
TOYOTA
19101-88363

⁰⁰Eliminated on 06-08-2020. Please verify the availability through our local distributors

- Eliminato il 06-08-2020. Verificare la disponibilità presso i nostri distributori
- Éliminé le 06-08-2020. Vérifier la disponibilité auprès de nos distributeurs sur place
- Am 06-08-2020 gestrichen. Evtl. Verfügbarkeit bitte bei unseren Händlern prüfen
- Eliminado en fecha 06-08-2020. Verificar la disponibilidad a través de nuestros distribuidores locales



TOYOTA

CELICA V 2.0	3S-GE	09/89 ⇨ 01/94
CELICA V 2.0 4WD	3S-GTE	10/89 ⇨ 01/94
CELICA V 2.0 GTi	3S-GE	10/89 ⇨ 11/93
MR 2 II 2.0 16V	3S-GE	12/89 ⇨ 09/99
MR 2 II 2.0 Turbo	3S-GTE	12/89 ⇨ 07/99

EPS

1.313.252



07

DISTRIBUTOR CAPS

Adatt./Suitable: DENSO

TOYOTA
19101-76010

⁰³Supplied until depletion

- Fornibile fino ad esaurimento delle scorte
- Fourni jusqu'à épuisement du stock
- Lieferbar solange vorrat reicht
- Suministrado hasta el stock termina



TOYOTA

PREVIA I 2.4	2TZ-FE	05/90 ⇨ 08/00
PREVIA I 2.4 4WD	2TZ-FE, 2TZ-FZE	01/90 ⇨ 12/99

EPS 1.313.254



05

DISTRIBUTOR CAPS

Adatt./Suitable: DENSO

BOSCH
F 005 X12 274
OPEL
43 00 976

⁰³Supplied until depletion

- Fornibile fino ad esaurimento delle scorte
- Fourni jusqu'à épuisement du stock
- Lieferbar solange vorrat reicht
- Suministrado hasta el stock termina



HOLDEN

RODEO TF 2.2	4ZD1	03/91 ⇨ 08/93
--------------	------	---------------

OPEL

CAMPO 2.3	23P	08/94 ⇨ 09/96
-----------	-----	---------------

EPS

1.313.256



07

DISTRIBUTOR CAPS

Adatt./Suitable: DENSO

BOSCH
F 005 X12 302
SUZUKI
33321-80C10
33321-80C10-000

⁰³Supplied until depletion

- Fornibile fino ad esaurimento delle scorte
- Fourni jusqu'à épuisement du stock
- Lieferbar solange vorrat reicht
- Suministrado hasta el stock termina



SUZUKI

ALTO IV 1.0	G10BB	09/94 ⇨ 06/02
ALTO V 1.0	G10BB	01/00 ⇨ 06/02
SAMURAI 1.3	G13BA	11/88 ⇨ 03/98
SAMURAI 1.3 Trazione integrale	G13A, G13BA	01/00 ⇨ 12/04

EPS 1.313.257



05

DISTRIBUTOR CAPS

Adatt./Suitable: DENSO

BOSCH

F 005 X12 272

DAIHATSU

19101-87601-000

⁰³ Supplied until depletion

- Fornibile fino ad esaurimento delle scorte
- Fourni jusqu'à épuisement du stock
- Lieferbar solange vorrat reicht
- Suministrado hasta el stock termina



DAIHATSU

FEROZA 1.6 16V	HD-C	10/88 ⇒ 12/99
FEROZA 1.6 16V 4x4	HD-C	10/88 ⇒ 12/99
FEROZA 1.6 i 16V	HD-E	10/88 ⇒ 12/99
FEROZA 1.6 i 16V 4x4	HD-E	10/88 ⇒ 12/99
FEROZA 1.6i	--	01/90 ⇒
ROCKY 2.0i [USA]	--	01/89 ⇒
SPORTACK 1.6 16v 4x4	HD-C	10/88 ⇒ 08/93

EPS 1.313.258



04

DISTRIBUTOR CAPS

Adatt./Suitable: DENSO

BOSCH

F 005 X04 522

DAIHATSU

19101-87103-000

19101-87105-000

⁰³ Supplied until depletion

- Fornibile fino ad esaurimento delle scorte
- Fourni jusqu'à épuisement du stock
- Lieferbar solange vorrat reicht
- Suministrado hasta el stock termina



DAIHATSU

APPLAUSE I 1.6 16V	HD, HD-E	06/89 ⇒ 07/97
APPLAUSE I 1.6 16V 4WD	HD-E	06/89 ⇒ 07/97
CHARADE III 1.3	HC-C	09/88 ⇒ 01/92
CHARADE III 1.3i [USA]	HC-E	01/89 ⇒

EPS 1.313.259



07

DISTRIBUTOR CAPS

Adatt./Suitable: DENSO

SUBARU

22162-KA100

⁰⁰ Eliminated on 03-02-2020. Please verify the availability through our local distributors

- Eliminato il 03-02-2020. Verificare la disponibilità presso i nostri distributori
- Éliminé le 03-02-2020. Vérifier la disponibilité auprès de nos distributeurs sur place
- Am 03-02-2020 gestrichen. Evtl. Verfügbarkeit bitte bei unseren Händlern prüfen
- Eliminado en fecha 03-02-2020. Verificar la disponibilidad a través de nuestros distribuidores locales



SUBARU

JUSTY 1.2i EMPI [USA] -- 01/91 ⇒

EPS 1.313.262



07

DISTRIBUTOR CAPS

Adatt./Suitable: DENSO

DAIHATSU

19101-1516

19101-15160-000

TOYOTA

19101-15140

19101-15160

⁰³ Supplied until depletion

- Fornibile fino ad esaurimento delle scorte
- Fourni jusqu'à épuisement du stock
- Lieferbar solange vorrat reicht
- Suministrado hasta el stock termina

²¹¹ Resistance [kOhm] 15

- Resistenza [kOhm] 15
- Résistance [kOhm] 15
- Widerstand [kOhm] 15
- Resistencia [kOhm] 15



TOYOTA

CARINA II 1.6	4A-FE	12/87 ⇒ 03/92
CELICA V 1.6	4A-FE	09/89 ⇒ 12/93
COROLLA VI 1.6	4A-FE	08/89 ⇒ 04/92
COROLLA VI 1.6 i	4A-FE	05/87 ⇒ 05/92
COROLLA VI 1.6 i 4WD	4A-FE	10/87 ⇒ 08/90
COROLLA VI 1.6 XLI	4A-FE	11/89 ⇒ 06/92
HIACE III 1.8	2Y	12/82 ⇒ 07/89

EPS 1.313.265



07

DISTRIBUTOR CAPS

Adatt./Suitable: DENSO

BOSCH

F 005 X04 526

HOLDEN

1910111060

TOYOTA

19101-11060

²¹¹ Resistance [kOhm] 15

- Resistenza [kOhm] 15
- Résistance [kOhm] 15
- Widerstand [kOhm] 15
- Resistencia [kOhm] 15



HOLDEN

NOVA_LF 1.8i Hatchback	7AFE	08/91 ⇒ 03/93
NOVA_LF 1.8i Sedan	7AFE	08/91 ⇒ 03/93
NOVA_LG 1.6i Hatchback	4AFE	09/94 ⇒ 09/96
NOVA_LG 1.6i Sedan	4AFE	09/94 ⇒ 09/96
NOVA_LG 1.8i Hatchback	7AFE	09/94 ⇒ 09/96
NOVA_LG 1.8i Sedan	7AFE	09/94 ⇒ 09/96

TOYOTA

AVENSIS I 1.6	4A-FE	09/97 ⇒ 10/00
CARINA E 1.6	4A-FE	04/92 ⇒ 09/97
CARINA E 1.6 16V	4A-FE	12/94 ⇒ 09/97
CARINA E 1.6 GLI	4A-FE	04/92 ⇒ 09/97
CARINA E 1.6 i	4A-FE	02/95 ⇒ 09/97
COROLLA VII 1.3 XLI	4E-FE	07/92 ⇒ 04/97
COROLLA VII 1.3 XLI 16V	4E-FE	07/92 ⇒ 09/95
COROLLA VII 1.6 GLI	4A-FE	07/92 ⇒ 04/97
COROLLA VII 1.6 Si	4A-FE	07/92 ⇒ 04/97
COROLLA VII 1.8 16V 4WD	7A-FE	09/95 ⇒ 04/97
COROLLA VII 1.8 GT	7A-FE	11/92 ⇒ 05/95
COROLLA VIII 1.6	4A-FE	04/97 ⇒ 02/00
COROLLA VIII 1.6 Aut.	4A-FE	04/97 ⇒ 02/00
COROLLA VIII 1.8 4WD	7A-FE	04/97 ⇒ 10/01
CELICA VI 1.8 i 16V	7A-FE	11/93 ⇒ 11/99
CELICA VI 1.8 i 16V [USA] [CAN]	7A-FE	09/93 ⇒ 08/99
PASEO 1.5	5E-FE	06/90 ⇒ 06/99
STARLET 1.3	4E-FE	01/96 ⇒ 07/99

EPS 1.313.267



07

DISTRIBUTOR CAPS

Adatt./Suitable: DENSO

BOSCH

1 987 233 106

HOLDEN

1910174180

TOYOTA

19101-74180

⁰³ Supplied until depletion

- Fornibile fino ad esaurimento delle scorte
- Fourni jusqu'à épuisement du stock
- Lieferbar solange vorrat reicht
- Suministrado hasta el stock termina

²¹¹ Resistance [kOhm] 15

- Resistenza [kOhm] 15
- Résistance [kOhm] 15
- Widerstand [kOhm] 15
- Resistencia [kOhm] 15



HOLDEN

APOLLO 2.2 i 08GR-FXS 03/93 ⇒ 05/97

TOYOTA

CAMRY 2.2 5S-FE 06/91 ⇒ 07/96

TOYOTA		
CARINA E 2.0	3S-FE	01/93 ⇒ 09/97
CARINA E 2.0 GLI	3S-FE	04/92 ⇒ 09/97
CARINA E 2.0 GTi	3S-GE	04/92 ⇒ 12/95
CARINA E 2.0 16V	3S-GE	03/94 ⇒ 09/97
CARINA E 2.0 i	3S-FE	12/92 ⇒ 09/97
CELICA V 2.2	5S-FE	10/89 ⇒ 12/94
FUNCRUISER 2.0 i 16V 4WD	3SFE	04/94 ⇒
MR 2 II 2.2 16V	5S-FE	01/90 ⇒ 06/95
CELICA VI 2.2 GT	5S-FE	11/93 ⇒ 08/99
RAV 4 I 2.0	3S-FE	06/97 ⇒ 09/99
RAV 4 I 2.0 4WD	3S-FE	01/94 ⇒ 06/00

EPS 1.313.272



07

DISTRIBUTOR CAPS

Adatt./Suitable: DENSO

BOSCH
F 005 X12 899

TOYOTA
19101-66010

⁰⁰ Eliminated on 22-02-2022. Please verify the availability through our local distributors

- Eliminato il 22-02-2022. Verificare la disponibilità presso i nostri distributori
- Éliminé le 22-02-2022. Vérifier la disponibilité auprès de nos distributeurs sur place
- Am 22-02-2022 gestrichen. Evtl. Verfügbarkeit bitte bei unseren Händlern prüfen
- Eliminado en fecha 22-02-2022. Verificar la disponibilidad a través de nuestros distribuidores locales



TOYOTA

4 RUNNER 3.0	3VZ-E	08/88 ⇒ 10/95
LAND CRUISER 80 4.5	1FZ-FE	08/92 ⇒ 01/98
LAND CRUISER 80 4.5 24V	1FZ-FE	08/92 ⇒ 12/97

EPS 1.313.273



07

DISTRIBUTOR CAPS

Adatt./Suitable: DENSO

BOSCH
F 005 X12 270

TOYOTA
19101-35010

VW
J19 101 350 10

⁰⁰ Eliminated on 06-09-2021. Please verify the availability through our local distributors

- Eliminato il 06-09-2021. Verificare la disponibilità presso i nostri distributori
- Éliminé le 06-09-2021. Vérifier la disponibilité auprès de nos distributeurs sur place
- Am 06-09-2021 gestrichen. Evtl. Verfügbarkeit bitte bei unseren Händlern prüfen
- Eliminado en fecha 06-09-2021. Verificar la disponibilidad a través de nuestros distribuidores locales

⁰³ Supplied until depletion

- Fornibile fino ad esaurimento delle scorte
- Fourni jusqu'à épuisement du stock
- Lieferbar solange vorrat reicht
- Suministrado hasta el stock termina



TOYOTA

4 RUNNER 2.4 i [USA]	22RE	01/89 ⇒ 12/93
HILUX IV 2.4 4WD	22R	10/88 ⇒ 12/97
HILUX V 2.4 4WD	22R	10/88 ⇒ 08/97
HILUX V 2.4 i 4WD	22RE	01/89 ⇒ 07/97
TRUCK 2.4 i [USA]	22RE	01/92 ⇒

VW

TARO 2.4 i 4x4	22R	06/89 ⇒ 03/97
----------------	-----	---------------

EPS 1.313.275



07

DISTRIBUTOR CAPS

Adatt./Suitable: DENSO

BOSCH
1 987 233 107

TOYOTA
19101-11300

²¹¹ Resistance [kOhm] 15

- Resistenza [kOhm] 15
- Résistance [kOhm] 15
- Widerstand [kOhm] 15
- Resistencia [kOhm] 15



TOYOTA

COROLLA VII 1.3 12V	2E	07/92 ⇒ 04/97
COROLLA VIII 1.3	2E	05/97 ⇒ 10/01
STARLET 1.0	1E	12/89 ⇒ 12/92
STARLET 1.3 12V	2E, 2E-E	12/89 ⇒ 12/92
STARLET 1.3 12V Cat	2E-E	12/89 ⇒ 03/96
TERCEL 1.5 i [USA]	3EE	01/93 ⇒

EPS 1.313.278



07

DISTRIBUTOR CAPS

Adatt./Suitable: DENSO

BOSCH
F 005 X04 527

HOLDEN
1910115120
1910174050

TOYOTA
19101-11032
19101-15120
19101-74050
19101-75040

²¹¹ Resistance [kOhm] 15

- Resistenza [kOhm] 15
- Résistance [kOhm] 15
- Widerstand [kOhm] 15
- Resistencia [kOhm] 15



HOLDEN

APOLLO 2.0	3S-FC	08/89 ⇒ 08/91
NOVA_LE 1.4 Hatchback	6AFC	07/89 ⇒ 07/91
NOVA_LE 1.6 Hatchback	4AFC	07/89 ⇒ 07/91
NOVA_LE 1.6 Sedan	4AFC	07/89 ⇒ 07/91

TOYOTA

CARINA II 1.6	4A-F	12/87 ⇒ 08/90
COROLLA VI 1.3	2E	05/87 ⇒ 06/92
COROLLA VI 1.3 i	2E, 2E-E	08/87 ⇒ 06/92
COROLLA VI 1.6	4A-F	05/87 ⇒ 12/92
COROLLA VI 1.6 4WD	4A-F	08/87 ⇒ 08/89
COROLLA VI 1.6 GL 4WD	4A-F	10/87 ⇒ 08/90
COROLLA VI 1.6 XL	4A-F	09/89 ⇒ 04/92
HIACE IV 2.0	1RZ	08/89 ⇒ 08/04
HIACE IV 2.4	5YTD050W07	08/89 ⇒ 08/03
HIACE IV 2.4 4WD	5YTD050W07	08/89 ⇒ 08/95

EPS 1.315.041



04

DISTRIBUTOR CAPS

Adatt./Suitable: DUCELLIER

DUCELLIER
72 196
662 434

GENERAL MOTORS
7 992 272

RENAULT
08 54 719 900
77 01 019 886
77 01 022 175

⁰⁰ Eliminated on 04-10-2021. Please verify the availability through our local distributors

- Eliminato il 04-10-2021. Verificare la disponibilità presso i nostri distributori
- Éliminé le 04-10-2021. Vérifier la disponibilité auprès de nos distributeurs sur place
- Am 04-10-2021 gestrichen. Evtl. Verfügbarkeit bitte bei unseren Händlern prüfen
- Eliminado en fecha 04-10-2021. Verificar la disponibilidad a través de nuestros distribuidores locales

⁰³ Supplied until depletion

- Fornibile fino ad esaurimento delle scorte
- Fourni jusqu'à épuisement du stock
- Lieferbar solange vorrat reicht
- Suministrado hasta el stock termina



RENAULT

4 0.8	800, 800705	10/62 ⇒ 09/83
-------	-------------	---------------

EPS 1.315.045



04

DISTRIBUTOR CAPS

Adatt./Suitable: **DUCELLIER**

BOSCH
1 235 522 805
1 235 522 806
1 235 525 806

CITROËN
54 524 19Z
DX 211-215A
GX 061 800 1A

⁰³ Supplied until depletion

- Fornibile fino ad esaurimento delle scorte
- Fourni jusqu'à épuisement du stock
- Lieferbar solange vorrat reicht
- Suministrado hasta el stock termina

FIAT
9920029
9921198
9934549
9935176

¹⁰⁰⁶ After depletion of stock this part is replaced by:

- Esaurite le scorte questo pezzo sarà sostituito da:
- Après épuisement du stock, cette pièce est remplacée par:
- Nach Vorraterschöpfung wird ersetzt durch:
- Después agotamiento stock, sera sustituido por:

1.315.058

RENAULT
77 01 012 957

TALBOT
3065 2H
3888 0
4613 6



FIAT		
242 1.6	124B3.000	10/75 ⇒ 07/82
FIORINO I 900	100GL.000	10/77 ⇒ 10/86

EPS 1.315.049



04

DISTRIBUTOR CAPS

Adatt./Suitable: **DUCELLIER**

ALFA ROMEO
700 291
60748373

BOSCH
1 235 522 803
1 235 525 803

CITROËN
DM 211-15

⁰³ Supplied until depletion

- Fornibile fino ad esaurimento delle scorte
- Fourni jusqu'à épuisement du stock
- Lieferbar solange vorrat reicht
- Suministrado hasta el stock termina

DUCELLIER
18 132
47 430
611 149

FIAT
9916116
9935177
9937592

LAND ROVER
RTC3295

PEUGEOT
5941 06
5941 08
5941 20

RENAULT
08 51 874 100
77 01 019 468
85 51 874 100

ROVER
GDC214

VOLVO
3100771
31007719
3277442
32774422
32774424

VW
028 905 207 C



ALFA ROMEO		
ALFASUD 1.2	AR30102	06/72 ⇒ 09/84
DACIA		
1210 1.2	--	01/69 ⇒

DACIA			
1310 1.3	810-02/-99	05/83 ⇒ 07/04	
1410 1.4	--	01/69 ⇒ 12/79	
ARO 10	--	01/72 ⇒ 12/80	
FIAT			
128 1.1	128A.000	03/69 ⇒ 12/84	
850 0.8	100G.000	07/64 ⇒ 10/72	
RITMO 1.1.3	149A3.000	11/83 ⇒ 08/85	
RITMO II 75 1.5	138A2.000	09/85 ⇒ 12/88	
PEUGEOT			
305 1.5	117(XR5S)	05/80 ⇒ 09/82	
ROVER			
MINI 1.0	--	01/85 ⇒	
MINI 1.3	--	01/85 ⇒	

EPS 1.315.054



04

DISTRIBUTOR CAPS

Adatt./Suitable: **DUCELLIER**

ALFA ROMEO
705 559
60749869

CHRYSLER
83 300 122

CITROËN
95 534 910

DUCELLIER
661 450
661 822
661 822 E
662 165

FIAT
9937716

PEUGEOT
5941 23

RENAULT
77 01 020 784

VOLVO
3277417
32774176



ALFA ROMEO			
3311.2	AR30585	06/83 ⇒ 12/89	
3311.3	AR30168, AR30586, AR30587	06/83 ⇒ 12/89	
3311.3 i.e.	AR30168	05/83 ⇒ 12/89	
3311.4	AR30587	01/84 ⇒ 12/88	
3311.5	AR30588	07/86 ⇒ 12/89	
3311.5 4x4	AR30508, AR30588	07/86 ⇒ 12/89	
3311.5 QV	AR30146, AR30508, AR30588	06/84 ⇒ 12/89	
3311.7	AR30550	01/86 ⇒ 06/90	
3311.7 QV	AR30550	03/88 ⇒ 12/89	
ALFASUD 1.5 ti	AR30128	05/80 ⇒ 06/84	

DACIA			
1410 1.4	--	01/80 ⇒	

FIAT			
DUCATO I 1.8	169B	01/82 ⇒ 12/88	
DUCATO I 2.0	170B, 170D, 170C(XN1T), XN1T	01/82 ⇒ 05/94	
DUCATO I 2.0 4x4	170D	06/90 ⇒ 05/94	
REGATA 1.1 60, 60 L	138B.000	10/83 ⇒ 08/86	
REGATA 1.6	149A.000	10/84 ⇒ 06/89	
REGATA 70 1.3	138B2.000, 149A3.000	09/83 ⇒ 07/89	
REGATA 85 1.6	149A.000	10/83 ⇒ 06/90	
RITMO I 1.1	146A4.048	04/85 ⇒ 12/87	
TALENTO 2.0	170B	03/89 ⇒ 03/94	

LAND ROVER			
90 2.5 4x4	17H	09/85 ⇒ 08/90	
110/127 2.5 4x4	17H	10/85 ⇒ 07/90	
DEFENDER 2.25	--	01/87 ⇒	

PEUGEOT			
504 1.8 Injection	KF5, KF6	07/68 ⇒ 02/71	
505 1.8	105(XM7), 105C(XM7A)	06/81 ⇒ 10/86	
505 2.0	106E(XN1A)	09/85 ⇒ 09/95	
J5 1.8	169B(XM7T)	01/83 ⇒ 11/88	
J9 1.6	XC7P	03/80 ⇒ 06/87	
J9 2.0	XN1P	03/80 ⇒ 06/87	

RENAULT			
40.8	800705	10/83 ⇒ 10/88	

RENAULT			
5 1.4 Alpine A5	840725	09/77 ⇒ 09/81	
9 1.1	C1E715	09/81 ⇒ 05/87	
11 1.1	C1E715, C1E720	03/83 ⇒ 06/86	
19 I 1.4	C1J	01/89 ⇒ 12/92	
20 2.0	829700, 829701, 829702, 829703, 829.01	10/77 ⇒ 12/83	
CLIO I 1.1	C1E700	01/91 ⇒ 09/98	
EXPRESS 1.1	C1E	01/85 ⇒ 10/90	
EXPRESS 955	C1C	01/85 ⇒ 10/90	
FUEGO 1.6 [USA] R1368	A7L752	01/82 ⇒ 12/84	
MASTER I 2.0	829731	07/80 ⇒ 06/85	
MASTER I 28-35 2.0	829731	08/80 ⇒ 10/86	
RAPID 1.0	C1C706	09/85 ⇒ 05/92	
RAPID 1.1	C1E750, C1E752, C1E754, C1E756, C1E760, C1E762, C1E764	07/85 ⇒ 10/97	
SUPER 5 1.1	C1E752, C1E754, C1E756, C1E760	10/84 ⇒ 12/96	
TRAFIC I 1.4	C1J700	03/80 ⇒ 06/91	

TALBOT			
1307-1510 Simca 1307 1.3	--	07/75 ⇒ 01/80	
SOLARA 1.3	2M102.979	02/80 ⇒ 07/86	
TAGORA 2.1	5N2	06/80 ⇒ 12/83	

EPS 1.315.058



04

DISTRIBUTOR CAPS

Adatt./Suitable: **DUCELLIER**

CITROËN
75 520 155
95 539 165

DUCELLIER
16 575
19 401
22 321
607 374
608 728
609 082
611 514
660 542
661 920
662 913

FEMSA
33829-7

FIAT
9936735

FORD
A700X-12276-AGA
A770-X12276-CA
A830-X12276-FA

GENERAL MOTORS
7 992 617
7 992 857
93 150 379

LANCIA
9936735

PEUGEOT
5941 26

SEAT
000 993 673 5
SE 141914.001D



CITROËN			
AXEL 11	--, G11/631	01/84 ⇒ 03/91	
BX 1.1	109LA, H1A	04/86 ⇒ 06/91	
BX 1.4	150C, K1F, K2D	07/86 ⇒ 12/94	
BX 1.4 E	150B(XY8), 150J, 150Y, K1F, KAZ	09/82 ⇒ 12/94	
BX 1.6	B2C	02/88 ⇒ 12/94	
BX 14	150C	01/86 ⇒ 02/93	
BX 14 E	150A, 150C, K1G	10/82 ⇒ 02/93	
BX 16	171A, 171B, 171C, 171D, BAY(XU5CP), BAZ(XU5CP)	10/82 ⇒ 12/94	
C15 1.0	108C	10/84 ⇒ 07/88	
C15 1.0 E	TU9K	11/92 ⇒ 07/96	
C15 1.1	109K, E1A, XW7	10/84 ⇒ 12/96	
C15 1.3	G1A	07/87 ⇒ 05/88	
CX I 2000	829A5	06/79 ⇒ 08/85	
CX II 20 RE	829A5	08/85 ⇒ 12/92	
CX II 22 TRS	J6TA500	07/85 ⇒ 12/92	
GS A 1.3	G13/625	07/78 ⇒ 07/86	
LNA 1.1	109/SE	07/82 ⇒ 04/85	

CITROËN		
VISA 11 E	109K	09/78 ⇒ 06/88
FIAT		
127 0.9	100GL.048	06/71 ⇒ 05/83
DUCATO I 2.0	170D	07/90 ⇒ 03/94
PANDA I 750	141B.000	01/86 ⇒ 01/95
PANDA I 800	100GL6.000	02/81 ⇒ 12/85
PANDA I 900	100GL3.000	10/80 ⇒ 06/94
PANDA I 900 CL	146A.048	01/86 ⇒ 04/91
UNO 45 0.9	146A.000, 146A1.000	03/83 ⇒ 07/96
UNO 45 0.9 Trend	146A.048	09/89 ⇒ 09/92
LANCIA		
A 112 0.9 Junior	A112A5.000	03/81 ⇒ 06/86
PEUGEOT		
104 0.9	108(XV5)	10/79 ⇒ 10/83
205 I 1.0	108C(XV8)	02/83 ⇒ 12/90
205 I 1.1	109F(XW7), 109N(XW7)	02/83 ⇒ 10/87
205 I 1.3	G1A	02/84 ⇒ 10/87
205 I 1.4	150(XY6B), 150B(XY8), 150D(XY7), 150G(XY7), 150H(XY8)	02/83 ⇒ 10/87
205 I 1.5	Y2/K	02/84 ⇒ 10/87
205 I 1.6	B1A(XU51C), B1E(XU51C), BAZ(XU5CP)	08/86 ⇒ 10/87
205 II 1.1	109N(XW7)	10/87 ⇒ 10/90
205 II 1.1 XA	E1	07/87 ⇒ 10/88
205 II 1.2	F1	01/87 ⇒ 12/90
205 II 1.3	G1A	08/90 ⇒ 07/92
205 II 1.4	150B(XY8), 150G(XY7), 150H(XY8)	10/87 ⇒ 05/89
205 II 1.4 CJ	150D(XY7), 150G(XY7)	03/88 ⇒ 05/89
205 II 1.4 CT	150B(XY8), 150H(XY8)	04/86 ⇒ 12/88
205 II 1.6	B1A(XU51C), B1E(XU51C), BAZ(XU5CP)	10/87 ⇒ 09/98
309 I 1.1	E1	10/85 ⇒ 07/89
309 I 1.3	G1A, G2S	10/85 ⇒ 08/89
309 I 1.3 XL	--	09/86 ⇒ 08/89
309 I 1.5	Y2/K	06/87 ⇒ 12/89
309 I 1.6	B1A(XU51C), B1D(XU51C), B1E(XU51C)	10/85 ⇒ 07/89
309 I 1.6 Cat	BAZ(XU5CP)	09/86 ⇒ 12/89
504 1.8	XM7	01/71 ⇒ 06/83
SEAT		
FURA 0.9	100GL3000	01/82 ⇒ 06/86
IBIZA I 0.9	146A000	08/86 ⇒ 05/93
PANDA 34 850	--	01/80 ⇒ 12/83
PANDA 35 850	--	01/80 ⇒ 12/83
TALBOT		
SAMBA 1.1	XW7	01/81 ⇒ 06/86

EPS 1.315.059



04

DISTRIBUTOR CAPS

Adatt./Suitable: **DUCELLIER**
CHRYSLER
83 300 121
T1407311

CITROËN
54 656 04
54 656 04P
75 524 767
95 610 822

DUCELLIER
22 946
660 588
662 471
663 205
664 813

FIAT
9919037
9934545

PEUGEOT
5941 28

RENAULT
77 01 027 411
77 01 027 491

VOLVO
3213392
32133928
3287598
32875981

CITROËN

CX I 2400	M23-623	08/76 ⇒ 06/80
CX I 2400 GTi	M23-622	06/77 ⇒ 06/83

FIAT		
124 1200	124A.000	07/66 ⇒ 10/73
124 1400 Special	124B2.000	12/68 ⇒ 12/72
124 1600 Special T	132AC.000	01/73 ⇒ 07/75
131 1.3 Mirafiori	131A6.000	10/74 ⇒ 09/81
132 1.6	132C.000	05/77 ⇒ 09/82
PEUGEOT		
505 2.0 TI, STI	829(ZEJ)	08/79 ⇒ 10/86
RENAULT		
5 1.4 Alpine Turbo	840726	10/81 ⇒ 01/85
9 1.2	C1G700, C1G710	09/85 ⇒ 12/88
11 1.2	C1G700, C1G710	10/84 ⇒ 12/88
11 1.4	C2J720, C2J766, C2J767, C2J768	03/83 ⇒ 12/88
18 1.4	847720, 847722	04/78 ⇒ 07/86
18 1.6 TS	A6M725, A6M726	05/82 ⇒ 07/86
18 2.0	J6R716	05/82 ⇒ 07/86
19 I 1.2	C1G730	01/88 ⇒ 12/92
19 I 1.4	C2J772, C2J776, C3J710	07/88 ⇒ 05/93
19 I 1.4 Cat	C3J710	01/89 ⇒ 04/92
19 II 1.4	C3J710	04/92 ⇒ 12/95
21 1.4	C2J770, C2L717	06/88 ⇒ 10/93
21 1.6	C2L	01/87 ⇒ 12/94
25 2.0	J6R706, J6R707	04/84 ⇒ 12/92
25 2.2	J7T706, J7T707	04/84 ⇒ 12/89
CLIO I 1.2	C3G720	06/94 ⇒ 02/98
ESPACE II 2.2	J7T772	01/91 ⇒ 10/96
ESPACE II 2.2 4x4	J7T772	03/91 ⇒ 12/96
EXPRESS 1.2	C1G	01/85 ⇒ 10/90
EXPRESS 1.4	C1J, C2J	01/85 ⇒ 10/90
EXPRESS 1.4i	C3G/C3J	01/85 ⇒ 10/90
FUEGO 1.6 [USA] R136A	A7L	01/82 ⇒ 12/86
FUEGO 1.6 [USA] R136B	A7L	01/84 ⇒ 12/86
SUPER 5 1.2	C1G702	01/87 ⇒ 12/96
SUPER 5 1.4	C2J798	10/84 ⇒ 07/89
SUPER 5 1.4 Turbo	C1J784	04/85 ⇒ 08/90
TWINGO I 1.2	C3G700, C3G702	03/93 ⇒ 10/96
VOLVO		
340-360 1.3	B13, B13.4E	08/88 ⇒ 12/90
340-360 1.4	B14.3E, B14.4E, B14.4ED, B14.40, B14.45	08/82 ⇒ 07/91

EPS 1.315.062



05

DISTRIBUTOR CAPS

Adatt./Suitable: **DUCELLIER**
DUCELLIER
666 592
⁰³ Supplied until depletion

- Fornibile fino ad esaurimento delle scorte
- Fourni jusqu'à épuisement du stock
- Lieferbar solange vorrat reicht
- Suministrado hasta el stock termina

¹²⁴⁶ Alternative Repair Kit

- Kit riparazione alternativo
- Kit de réparation alternative
- alternativer Reparatursatz
- Juego alternativo de reparación

1.315.073



RENAULT

91.7	F2N700, F2N704, F2N708, F2N710, F2N730, F2N798, F3N708, F3N718	09/84 ⇒ 12/89
11 1.7	F2N700, F2N704, F2N708, F2N710, F2N730, F2N732, F2N742, F2N798, F3N718	10/83 ⇒ 12/88

VOLVO

340-360 1.7	B172K	08/85 ⇒ 07/91
-------------	-------	---------------

EPS 1.315.063



05

DISTRIBUTOR CAPS

Adatt./Suitable: **DUCELLIER**
CHRYSLER
83 300 124
DUCELLIER
582 514
665 757

RENAULT
77 01 029 971
77 01 202 293

VOLVO
3342161
33421611
⁰³ Supplied until depletion

- Fornibile fino ad esaurimento delle scorte
- Fourni jusqu'à épuisement du stock
- Lieferbar solange vorrat reicht
- Suministrado hasta el stock termina

¹¹¹ Paired article numbers

- N° articolo appaiato
- Numéro d'article en paire
- paarige Artikelnummer
- Referencia artículo par

1.315.073



RENAULT

11 1.7	F2N700	10/83 ⇒ 12/87
--------	--------	---------------

VOLVO

340-360 1.7	B172K	08/85 ⇒ 07/91
-------------	-------	---------------

EPS 1.315.065



05

DISTRIBUTOR CAPS

Adatt./Suitable: **DUCELLIER**
CHRYSLER
83 300 123
DUCELLIER
664 369
⁰³ Supplied until depletion

- Fornibile fino ad esaurimento delle scorte
- Fourni jusqu'à épuisement du stock
- Lieferbar solange vorrat reicht
- Suministrado hasta el stock termina

¹¹¹ Paired article numbers

- N° articolo appaiato
- Numéro d'article en paire
- paarige Artikelnummer
- Referencia artículo par

1.315.066



RENAULT

21 2.0	14ZR, 8CPD, J6R758, J6R759, J6R793, J7R747, J7R750, J7R751	03/86 ⇒ 12/93
21 2.2	J7T754, J7T755	04/86 ⇒ 06/94
21 2.2 4x4	J7T754, J7T755	06/86 ⇒ 06/94
ESPACE II 2.0	J7R768	01/91 ⇒ 10/96
ESPACE II 2.2	J7T772, J7T773, J7T776	01/91 ⇒ 10/96
TRAFIC I 2.2	J7T600, J7T780	05/89 ⇒ 04/98
TRAFIC I 2.2 4x4	J7T600, J7T780	05/89 ⇒ 10/97

EPS 1.315.066



05

DISTRIBUTOR CAPS

Adatt./Suitable: **DUCELLIER**

RENAULT

77 00 730 116 *B
77 01 202 683 *M***B Available distributor cap and rotor, only not the distributor assy**

- Forniti solo calotta e distributore rotante, no lo spinterogeno completo
- Disponibles seulement la tete et le rotor, non pas l'allumeur complet
- Erhältlich nur kappe und rotor, nicht der komplette verteiler
- Disponibles solo la tapa y el rotor, no el distribuidor completo

***M Kit Distributor cap / Rotor**

- Kit Calotta / Distributore
- Kit Tête d'allumeur / Disrupteur
- Bausatz VerteilerKappe / -läufer
- Juego Tapa del distribuidor / Rotor

03 Supplied until depletion

- Fornibile fino ad esaurimento delle scorte
- Fourni jusqu'à épuisement du stock
- Lieferbar solange vorrat reicht
- Suministrado hasta el stock termina

216 contains article number

- contiene il numero articolo
- contient le numéro d'article
- beinhaltet Artikelnummer
- número de artículo incluido

1.315.065 1.415.094

RENAULT

21 2.0	14ZR, J6R758, J6R793, J7R747, J7R750, J7R751	03/86 ⇒ 12/93
21 2.0 4x4	14ZR, J7R747	03/89 ⇒ 12/93
21 2.2	J6T790, J6T791, J7T754, J7T755, J7T756	03/86 ⇒ 12/95
21 2.2 4x4	J7T754, J7T755	06/86 ⇒ 06/94
ESPACE II 2.0	J7R768	01/91 ⇒ 10/96
ESPACE II 2.2	J7T776	01/91 ⇒ 10/96
TRAFIC I 2.2	J7T600, J7T780	05/89 ⇒ 04/98
TRAFIC I 2.2 4x4	J7T600, J7T780	05/89 ⇒ 04/98

EPS 1.315.067



04

DISTRIBUTOR CAPS

Adatt./Suitable: **DUCELLIER**

CITROËN

95 618 396

DUCELLIER

667 287

PEUGEOT

5941 41



CITROËN

BX 1.4	150C, K1F, K2D	07/86 ⇒ 12/94
BX 1.4 E	150B(XY8), 150J, 150Y, K1F, KAZ	09/82 ⇒ 12/94
BX 1.6	B2C	02/88 ⇒ 12/94
BX 1.9	159B, 159C, D6U, DKK	05/85 ⇒ 12/94

CITROËN

BX 1.9 GTi	D6D, D6K	01/87 ⇒ 01/92
BX 14	150C	01/86 ⇒ 02/93
BX 14 E	150A, 150C, K1G	10/82 ⇒ 02/93
BX 15	B1E(XU51C)	01/87 ⇒ 05/92
BX 16	B1E, 171B, 171C, 171D, 23DH, B1E(XU51C), BAY(XU5CP), BAZ(XU5CP)	10/82 ⇒ 12/94
BX 19	159A, D2A(XU92C), D2C(XU92C), D2E, D6A(XU9J2), DKZ(XU9JA)	09/84 ⇒ 12/94
BX 19 Cat	DFZ(XU9J1)	07/86 ⇒ 12/94
BX 19 E 4x4	D2F	04/89 ⇒ 02/93
BX 19 GTi	D6A(XU9J2), DKZ(XU9JA)	07/86 ⇒ 02/93
BX 19 GTi 4x4	DKZ(XU9JA)	06/88 ⇒ 02/93
C15 1.4	150D(XY7)	05/87 ⇒ 10/92
C15 1.4 E	150D(XY7)	05/87 ⇒ 12/96

PEUGEOT

205 I 1.0	108C(XV8)	10/87 ⇒ 12/90
205 I 1.1	109F(XW7), 109N(XW7)	02/83 ⇒ 10/87
205 I 1.4	150(XY6B), 150D(XY7), 150G(XY7)	02/83 ⇒ 10/87
205 I 1.6	B1A(XU51C), B1E(XU51C), BAZ(XU5CP)	08/86 ⇒ 10/87
205 I 1.9 GTI	DFZ(XU9J1)	03/87 ⇒ 10/87
205 II 1.1	109N(XW7)	10/87 ⇒ 10/90
205 II 1.4	150(XY6B), 150B(XY8), 150D(XY7), 150G(XY7)	01/87 ⇒ 05/89
205 II 1.4 CJ	150D(XY7), 150G(XY7)	03/88 ⇒ 05/89
205 II 1.6	B1A(XU51C), B1E(XU51C), BAZ(XU5CP)	10/87 ⇒ 09/98
205 II 1.9 CTI	DFZ(XU9J1)	10/87 ⇒ 12/94
205 II 1.9 GTI Cat	DFZ(XU9J1)	10/87 ⇒ 07/94
309 I 1.6	B1A(XU51C), B1D(XU51C), B1E(XU51C)	10/85 ⇒ 07/89
309 I 1.6 Cat	BAZ(XU5CP)	09/86 ⇒ 12/89
309 I 1.9	D2B(XU9S), DFZ(XU9J1), XU92C	10/85 ⇒ 07/89
309 II 1.9	XU92C	07/89 ⇒ 12/93
405 I 1.9	DFZ(XU9J1)	05/88 ⇒ 08/92
405 I 1.9 Antipollution	XU92C	01/87 ⇒ 12/92
405 I 1.9 Injection	DFZ(XU9J1)	07/87 ⇒ 12/92
405 I 1.9 Trazione integrale	DFZ(XU9J1)	09/88 ⇒ 07/92

EPS 1.315.068



04

DISTRIBUTOR CAPS

Adatt./Suitable: **DUCELLIER**

AUDI

026 905 207 A

DUCELLIER

666 349

SEAT

026 905 207 A

VW

026 905 207 A



AUDI

80 II 1.6	DT	08/78 ⇒ 03/87
80 II 1.8	DS	01/83 ⇒ 08/86
80 III 1.4	SE	08/86 ⇒ 07/88
80 III 1.6	PP, RN, RNA	09/86 ⇒ 09/91
80 III 1.8	RU	10/86 ⇒ 01/90
80 III 1.8 S	NE	09/86 ⇒ 10/91
100 III 1.8	DS, NP	08/83 ⇒ 12/90
100 III 1.8 quattro	NP, SH	10/84 ⇒ 07/90
A4 I 1.6	ADP	11/94 ⇒ 09/01

SEAT

CORDOBA I 1.6 i	1F	05/94 ⇒ 06/99
CORDOBA I 1.8 i	ABS, ACC, ADZ	02/93 ⇒ 09/02
IBIZA II 1.6 i	1F	09/94 ⇒ 06/99
IBIZA II 1.8 i	ABS, ACC, ADZ	03/93 ⇒ 08/99
INCA 1.4 i	AEX, AKV, APQ	11/95 ⇒ 06/03
INCA 1.6 i	1F, AEE	11/95 ⇒ 05/98
TOLEDO I 1.8 i	ADZ	11/93 ⇒ 12/96

VW

PASSAT II 1.6	DT	08/80 ⇒ 03/88
PASSAT II 1.8	DS	01/83 ⇒ 03/88
PASSAT II 1.8 Syncro	DS	01/86 ⇒ 03/88

VW

PASSAT IV 1.6	ADP	10/96 ⇒ 11/00
JETTA II 1.6	ABN, EZ, EZA, PN, RF	01/84 ⇒ 07/92
JETTA II 1.8	GU	08/84 ⇒ 10/91
JETTA II 1.8 Syncro	GU	08/87 ⇒ 12/88
CADDY II 1.6	1F	11/95 ⇒ 05/97
CADDY II 75 1.6	1F	11/95 ⇒ 05/97
GOLF I 1.6	EW	08/83 ⇒ 04/92
GOLF I 1.8	EX	08/83 ⇒ 09/92
GOLF II 1.6	ABN, EZ, PN, RF	08/83 ⇒ 12/92
GOLF II 1.6 G	EZA, PN	08/86 ⇒ 07/91
GOLF II 1.8	GU	08/84 ⇒ 10/91
GOLF II 1.8 Syncro	GU	02/86 ⇒ 07/91
GOLF III 1.6	AEK	07/94 ⇒ 04/99
GOLF III 1.8	AAM, ABS, ADZ	08/91 ⇒ 04/99
GOLF III 1.8 Syncro	ABS, ADZ	01/93 ⇒ 04/99
GOLF III 2.0	ADY, AEP, AGG, AKR	11/91 ⇒ 04/99
GOLF III 2.0 GL	AEP	08/95 ⇒ 09/97
GOLF IV 2.0	AGG, AKR	06/98 ⇒ 06/02
PASSAT III 1.6	AEK	07/94 ⇒ 08/96
PASSAT III 1.8	AAM, ABS, ADZ	02/88 ⇒ 05/97
POLO III 75 1.6	1F	11/95 ⇒ 09/97
SCIROCCO II 1.6	EW, EWA, RE	01/83 ⇒ 07/90
SCIROCCO II 1.8	EX	08/83 ⇒ 07/92
VENTO 1.6	AEK	10/94 ⇒ 09/98
VENTO 1.8	AAM, ABS, ADZ	11/91 ⇒ 09/98

EPS 1.315.069



05

DISTRIBUTOR CAPS

Adatt./Suitable: **DUCELLIER**

DUCELLIER

525 536 F

2 524 086

RENAULT

77 00 726 736

VOLVO

3342442

33424425

3342862

33428624

1246 Alternative Repair Kit

- Kit riparazione alternativo
- Kit de réparation alternative
- alternativer Reparatursatz
- Juego alternativo de reparación

1.315.072

RENAULT

19 I 1.7	F2N720, F2N721, F2N722, F2N724, F3N740, F3N741, F3N742, F3N743, F3N746	07/88 ⇒ 12/92
19 II 1.7	F2N720, F2N721, F2N726, F2N727, F3N740, F3N741, F3N742, F3N743, F3N746	09/90 ⇒ 12/95
19 II 1.8	5F140FE, 8NA20S, F3P682, F3P704, F3P705, F3P706, F3P707, F3P708, F3P764, F3P765	04/92 ⇒ 06/96
21 1.7	F2N710, F2N711, F2N712, F2N722, F2N750, F2N752, F2N754, F2N758, F2N786, F3N722, F3N723, F3N726	03/86 ⇒ 12/95
21 1.7 Cat	F3N726	05/88 ⇒ 06/93
21 2.0	F2R702	09/89 ⇒ 12/91
CLIO I 1.7	F2N770	01/91 ⇒ 12/93
CLIO I 1.8	F3P710, F3P714, F3P754	01/91 ⇒ 09/98
CLIO I 1.8 Rsi	F3P712, F3P758	01/93 ⇒ 09/98
SUPER 5 1.7	F2N740, F2N742, F3N716, F3N717	10/86 ⇒ 03/95
SUPER 5 1.7 i	F3N702	10/86 ⇒ 08/91
TRAFIC I 1.7	F1N720	05/89 ⇒ 08/94

VOLVO

440 1.6	B16F	09/88 ⇒ 12/96
440 1.7	B18E, B18EP, B18F, B18FP, B18K, B18KD, B18KP, B18KPD	08/88 ⇒ 12/96
440 1.7 Turbo	B18FT	08/88 ⇒ 12/96
440 1.8	B18U	08/91 ⇒ 12/96
440 2.0	B20F	08/92 ⇒ 07/96
460 1.6	B16F	07/92 ⇒ 07/96
460 1.7	B18EP, B18FP, B18K, B18KD, B18KP	09/88 ⇒ 07/96
460 1.7 Turbo	B18FT	08/89 ⇒ 07/96
460 1.8	B18U	08/91 ⇒ 07/96
460 2.0	B20F	08/92 ⇒ 07/96

VOLVO		
480 1.7	B18E, B18ED, B18EP, B18F, B18FP	04/86 ⇒ 07/96
480 1.7 Turbo	B18FT	08/87 ⇒ 07/96
480 2.0	B20F	08/92 ⇒ 09/95

EPS **1.315.070**  **04**

DISTRIBUTOR CAPS

Adatt./Suitable: **DUCELLIER**

DUCELLIER

665 752
2 524 128

RENAULT

77 01 029 973

VOLVO

3342164
33421645
3342443
33424433
3342864
33428640

111 Paired article numbers

- N° articolo appaiato
- Numéro d'article en paire
- paarige Artikelnummer
- Referencia artículo par

1.315.072 1.315.073



RENAULT		
CLIO 1.8	F3P710, F3P714, F3P754	01/91 ⇒ 09/98

EPS **1.315.071**  **05**

DISTRIBUTOR CAPS

Adatt./Suitable: **DUCELLIER**

111 Paired article numbers

- N° articolo appaiato
- Numéro d'article en paire
- paarige Artikelnummer
- Referencia artículo par

1.315.072



VOLVO		
440 1.6	B16F	09/88 ⇒ 12/96
440 1.7	B18E, B18EP, B18F, B18FP, B18K, B18KD, B18KP, B18KPD	08/88 ⇒ 12/96
440 1.7 Turbo	B18FT	08/88 ⇒ 12/96
440 1.8	B18U	08/91 ⇒ 12/96
440 2.0	B20F	08/92 ⇒ 07/96
460 1.6	B16F	07/92 ⇒ 07/96
460 1.7	B18EP, B18FP, B18K, B18KD, B18KP	09/88 ⇒ 07/96
460 1.7 Turbo	B18FT	08/89 ⇒ 07/96
460 1.8	B18U	08/91 ⇒ 07/96
460 2.0	B20F	08/92 ⇒ 07/96
480 1.7	B18E, B18ED, B18EP, B18F, B18FP	04/86 ⇒ 07/96
480 1.7 Turbo	B18FT	08/87 ⇒ 07/96
480 2.0	B20F	08/92 ⇒ 09/95

EPS **1.315.072**  **05**

DISTRIBUTOR CAPS

Adatt./Suitable: **DUCELLIER**

DUCELLIER

525 536 *M
525 536 B *M

RENAULT

77 00 102 012 *M
77 00 736 209 *M
77 00 851 781 *M

VOLVO

3342440 *M
33424409 *M

***M Kit Distributor cap / Rotor**

- Kit Calotta / Distributore
- Kit Tête d'allumeur / Disrupteur
- Bausatz VerteilerKappe / -läufer
- Juego Tapa del distribuidor / Rotor

216 contains article number

- contiene il numero articolo
- contient le numéro d'article
- beinhaltet Artikelnummer
- número de artículo incluido

1.315.069



RENAULT		
19 I 1.7	F2N720, F2N721, F2N722, F2N724, F3N740, F3N741, F3N742, F3N743, F3N746	07/88 ⇒ 12/92
19 II 1.7	F2N720, F2N721, F2N726, F2N727, F3N740, F3N741, F3N742, F3N743, F3N746	09/90 ⇒ 12/95
19 II 1.8	5F140FE, 8NA20S, F3P682, F3P704, F3P705, F3P706, F3P707, F3P708, F3P764, F3P765	04/92 ⇒ 06/96
21 1.7	F2N710, F2N711, F2N712, F2N722, F2N750, F2N752, F2N754, F2N758, F2N786, F3N722, F3N723, F3N726	03/86 ⇒ 12/95
21 1.7 Cat	F3N726	05/88 ⇒ 06/93
21 2.0	F2R702	09/89 ⇒ 12/91
CLIO I 1.7	F2N770	01/91 ⇒ 12/93
CLIO I 1.8	F3P710, F3P714, F3P754	01/91 ⇒ 09/98
CLIO I 1.8 Rsi	F3P712, F3P758	01/93 ⇒ 09/98
SUPER 5 1.7	F2N740, F2N742, F3N716, F3N717	10/86 ⇒ 03/95
SUPER 5 1.7 i	F3N702	10/86 ⇒ 08/91
TRAFIC I 1.7	F1N720	05/89 ⇒ 08/94

EPS **1.315.073**  **05**

DISTRIBUTOR CAPS

Adatt./Suitable: **DUCELLIER**

DUCELLIER

525 409 D *M
666 203 *M
666 778 *M

RENAULT

77 00 733 982 *M

***M Kit Distributor cap / Rotor**

- Kit Calotta / Distributore
- Kit Tête d'allumeur / Disrupteur
- Bausatz VerteilerKappe / -läufer
- Juego Tapa del distribuidor / Rotor

03 Supplied until depletion

- Fornibile fino ad esaurimento delle scorte
- Fourni jusqu'à épuisement du stock
- Lieferbar solange vorrat reicht
- Suministrado hasta el stock termina



RENAULT		
11 1.7	F2N700	10/83 ⇒ 12/87

EPS **1.315.074**  **04**

DISTRIBUTOR CAPS

Adatt./Suitable: **DUCELLIER**

CITROËN

95 624 985

DUCELLIER

2 524 134

PEUGEOT

5941 46



CITROËN		
AX 1.3 Sport	M4A	04/87 ⇒ 12/88
AX 10	C1A	09/86 ⇒ 06/92
AX 10 E	C3A	12/86 ⇒ 12/88
AX 11	H1A, H1B, HDZ(TU1M)	09/86 ⇒ 12/97
AX 11 4x4	H1A	06/91 ⇒ 07/92
AX 11 Cat	HAZ(TU1CP)	09/88 ⇒ 12/89
AX 14	K1A(TU3), K1B, K1F, K1G, K1J, K2A, K2B, K2D, KAY(TU3CP), KDX(TU3M/Z), KDY(TU3FM), KDY(TU3M), KDZ(TU3M/Z)	09/86 ⇒ 04/97
AX 14 4x4	KD4, KDX(TU3M/Z), KDY(TU3FM), KDZ(TU3M/Z)	06/91 ⇒ 12/96
AX 14 GT	KDZ(TU3M/Z)	01/89 ⇒ 12/91
BX 1.1	109LA, H1A	04/86 ⇒ 06/91
BX 1.4	150C, K1F, K2D	07/86 ⇒ 12/94
BX 1.4 E	150B(XY8), 150J, 150Y, K1F, KAZ	09/82 ⇒ 12/94
BX 1.6	B2C	02/88 ⇒ 12/94
BX 1.9	159B, 159C, D6U, DKK	05/85 ⇒ 12/94
BX 1.9 GTi	D6D, D6K	01/87 ⇒ 01/92
BX 14	150C, KDY(TU3M), KDZ(TU3M/Z)	01/86 ⇒ 02/93
BX 14 E	150A, 150C, K1G	10/82 ⇒ 02/93
BX 15	B1E(XU51C)	01/87 ⇒ 05/92

CITROËN		
BX 16	171A, 171B, 171C, 171D, 23DH, B1E(XU51C), BAY(XU5CP), BAZ(XU5CP), BDY(XU5M), BDZ(XU5M)	10/82 ⇒ 12/94
BX 16 E	BDY(XU5M), BDZ(XU5M)	05/89 ⇒ 02/93
BX 19	159A, D2A(XU92C), D2C(XU92C), D2E, D6A(XU9J2), DDZ(XU9M), DKZ(XU9JA)	09/84 ⇒ 12/94
BX 19 4x4	DDZ(XU9M)	10/90 ⇒ 05/91
BX 19 Cat	DFZ(XU9J1)	07/86 ⇒ 12/94
BX 19 E	DDZ(XU9M)	06/88 ⇒ 02/93
BX 19 E 4x4	D2F	04/89 ⇒ 02/93
BX 19 GTi	D6A(XU9J2), DKZ(XU9JA)	07/86 ⇒ 02/93
BX 19 GTi 4x4	DKZ(XU9JA)	06/88 ⇒ 02/93
C15 1.0	108C(XV8), C1A, C1A(TU9/K), C1B(TU9/W), TU9	10/84 ⇒ 12/97
C15 1.1	H1A, HDZ(TU1M), TU1	08/88 ⇒ 07/96
C15 1.1 i	HDZ(TU1M), TU1MZ	07/88 ⇒ 12/96
C15 1.4	K1A, K1G, K1H(TU3A), KDY(TU3M)	07/87 ⇒ 12/96
C15 1.4 E	K1F, K1J, K2D, K3A, KAZ	07/86 ⇒ 12/96
C15 1.4 i	KDY(TU3FM), KDY(TU3M)	05/91 ⇒ 12/96
JUMPER I 2.0	XU102C	02/94 ⇒ 02/02
XM I 2.0	--	05/89 ⇒ 04/94
XM I 2.0 i	RDZ(XU10MZ), RFZ(XU10J2)	05/89 ⇒ 06/94
BERLINGO I 1.4	TU32	07/96 ⇒ 10/98
ZX 1.1	H1A, H1B, HDZ(TU1M), TU1	03/91 ⇒ 06/97
ZX 1.4 i	KDY(TU3M)	10/93 ⇒ 10/97
ZX 1.9	D6E(XU9JA)	03/91 ⇒ 06/97
ZX 1.9 i	DKZ(XU9JA), XU9JA	03/91 ⇒ 06/97
PEUGEOT		
106 I 1.0	TU9	09/91 ⇒ 03/01
106 I 1.1	H1B(TU1), HDZ(TU1M)	08/91 ⇒ 04/96
106 I 1.4	K5A(TU3), KDY(TU3M), TU3.2	08/91 ⇒ 04/96
106 II 1.1	H1B(TU1)	04/96 ⇒
205 I 1.4	TU3	01/83 ⇒ 12/90
205 I 1.6	B1A(XU51C), B1E(XU51C)	08/86 ⇒ 10/87
205 II 1.0	TU9	10/87 ⇒ 09/98
205 II 1.1	H1B(TU1), HDZ(TU1M)	10/87 ⇒ 09/98
205 II 1.1 CJ	HDZ(TU1M)	10/89 ⇒ 12/94
205 II 1.4	K1D(TU3A), K2B(TU3S), KDY(TU3M), KDZ(TU3M)	06/87 ⇒ 09/98
205 II 1.4 CJ	K1D(TU3A), KDY(TU3M)	03/89 ⇒ 12/94
205 II 1.6	B1A(XU51C), B1E(XU51C)	10/87 ⇒ 09/98
205 II 1.9 GTI	DKZ(XU9JAZ)	10/87 ⇒ 10/94
306 1.4	TU3	01/93 ⇒ 04/02
309 I 1.4	K1D(TU3A), K2B(TU3S), KDY(TU3M), KDZ(TU3M)	08/88 ⇒ 08/89
309 II 1.1	H1B(TU1), HDZ(TU1M)	09/89 ⇒ 12/93
309 II 1.4	KDZ(TU3M), TU3, TU3F2	07/89 ⇒ 12/93
309 II 1.6	18EM, BDZ(XU5M)	07/89 ⇒ 12/93
309 II 1.9	DDZ(XU9M), XU92C	07/89 ⇒ 12/93
309 II 1.9 GTI	DKZ(XU9JAZ)	07/89 ⇒ 12/93
405 I 1.4	K5A(TU3), TU3A, TU3F2	01/87 ⇒ 12/92
405 I 1.6	--, 18EM, B1E(XU51C), BDZ(XU5M)	01/87 ⇒ 12/92
405 I 1.6 4x4	BDZ(XU5M)	04/88 ⇒ 07/92
405 I 1.6 SRi 4x4	BDZ(XU5M)	04/88 ⇒ 07/92
405 I 1.9	D2C(XU92C), DDZ(XU9M), DKZ(XU9JAZ), XU9J2, XU9J2/D6D	01/87 ⇒ 12/92
405 I 1.9 4x4	DDZ(XU9M), DKZ(XU9JAZ)	06/87 ⇒ 12/92
405 II 1.4	TU3F2	01/93 ⇒ 12/96
405 II 1.6	18EM	08/92 ⇒ 05/97
405 II 1.9	XU92C	01/93 ⇒ 12/96
605 2.0	--, RSA(XU102C), XU10M	01/89 ⇒ 09/99

EPS 1.315.075



DISTRIBUTOR CAPS

Adatt./Suitable: **DUCELLIER****DUCELLIER**
2 537 268⁰³ Supplied until depletion

- Fornibile fino ad esaurimento delle scorte
- Fourni jusqu'à épuisement du stock
- Lieferbar solange vorrat reicht
- Suministrado hasta el stock termina



EPS 1.315.077



DISTRIBUTOR CAPS

Adatt./Suitable: **DUCELLIER****CITROËN**
91 538 999
96 074 954
DUCELLIER
2 590 935⁰⁴ Eliminated on 16-02-2022. Please verify the availability through our local distributors

- Eliminato il 16-02-2022. Verificare la disponibilità presso i nostri distributori
- Éliminé le 16-02-2022. Vérifier la disponibilité auprès de nos distributeurs sur place
- Am 16-02-2022 gestrichen. Evtl. Verfügbarkeit bitte bei unseren Händlern prüfen
- Eliminado en fecha 16-02-2022. Verificar la disponibilidad a través de nuestros distribuidores locales

**CITROËN**

BX 1.9 GTi 16V	159K, DFK	01/87 ⇒ 12/94
BX 19 GTi 16V	D6C(XU9J4), DFW(XU9J4)	09/87 ⇒ 02/93

PEUGEOT

309 II 1.9 GTi 16V	D6C(XU9J4)	08/89 ⇒ 07/90
405 I 1.9	D6C(XU9J4)	06/87 ⇒ 07/92
405 I 1.9 4x4	D6C(XU9J4)	06/87 ⇒ 07/92
405 I 1.9 Sport MI-16	D6C(XU9J4), DFW(XU9J4Z)	06/87 ⇒ 11/92
405 I 1.9 Sport MI-16 4x4	DFW(XU9J4Z)	06/87 ⇒ 07/92
405 I 1.9 Trazione integrale	D6C(XU9J4)	06/87 ⇒ 07/92

EPS 1.315.078



DISTRIBUTOR CAPS

Adatt./Suitable: **DUCELLIER****CITROËN**91 539 003 *M
91 541 615 *M
96 038 183 *M
96 038 185 *M**DUCELLIER**2 525 628 *M
2 525 628 B *M⁰⁰ Eliminated on 16-02-2022. Please verify the availability through our local distributors

- Eliminato il 16-02-2022. Verificare la disponibilità presso i nostri distributori
- Éliminé le 16-02-2022. Vérifier la disponibilité auprès de nos distributeurs sur place
- Am 16-02-2022 gestrichen. Evtl. Verfügbarkeit bitte bei unseren Händlern prüfen
- Eliminado en fecha 16-02-2022. Verificar la disponibilidad a través de nuestros distribuidores locales

TM Kit Distributor cap / Rotor

- Kit Calotta / Distributore
- Kit Tête d'allumeur / Disrupteur
- Bausatz VerteilerKappe / -läufer
- Juego Tapa del distribuidor / Rotor

²¹⁶ contains article number

- contiene il numero articolo
- contient le numéro d'article
- beinhaltet Artikelnummer
- número de artículo incluido

1.315.075

**CITROËN**

BX 1.9 GTi 16V	159K, DFK	01/87 ⇒ 12/94
BX 19 GTi 16V	D6C(XU9J4), DFW(XU9J4)	09/87 ⇒ 02/93

PEUGEOT

309 II 1.9 GTI 16V	D6C(XU9J4)	08/89 ⇒ 07/90
405 I 1.9	D6C(XU9J4)	06/87 ⇒ 07/92
405 I 1.9 4x4	D6C(XU9J4)	06/87 ⇒ 07/92
405 I 1.9 Sport MI-16	D6C(XU9J4), DFW(XU9J4Z)	06/87 ⇒ 11/92
405 I 1.9 Sport MI-16 4x4	DFW(XU9J4Z)	06/87 ⇒ 07/92
405 I 1.9 Trazione integrale	D6C(XU9J4)	06/87 ⇒ 07/92

EPS 1.315.079



04

DISTRIBUTOR CAPS

Adatt./Suitable: **DUCELLIER****DUCELLIER**
667 308⁰³ Supplied until depletion

- Fornibile fino ad esaurimento delle scorte
- Fourni jusqu'à épuisement du stock
- Lieferbar solange vorrat reicht
- Suministrado hasta el stock termina



PEUGEOT		
604 2.0 i	XN6	01/85 ⇒ 12/86
RENAULT		
18 2.0	J6R716	05/82 ⇒ 07/86
ESPACE I 2.0	53AZ-FXE, J6R234, J6R236	07/84 ⇒ 12/90
MASTER I 2.0	J5R718, J5R728	06/85 ⇒ 12/95
MASTER I 2.2	J7T788	08/93 ⇒ 02/98
MASTER I 28-35 2.0	J5R718	10/86 ⇒ 07/98
MASTER I 30 2.2	J7T782, J7T788	08/80 ⇒ 07/98
TRAFIC I 2.0	J5R716	05/89 ⇒ 08/90

EPS 1.315.080



04

DISTRIBUTOR CAPS

Adatt./Suitable: **DUCELLIER****DUCELLIER**
2 537 065**FIAT**

9941721

LANCIA

9941721



FIAT		
PANDA I 1000	156A2.000	12/93 ⇒
PANDA I 1000 CLX	156A2.000	05/91 ⇒ 12/94
PANDA I 1000 Fire	156A2.000	05/86 ⇒ 04/91
PANDA I 750	156A4.000	01/86 ⇒ 10/03
PANDA I 750 Cat	156A4.048	01/95 ⇒ 10/03
PANDA I 750 Fire	156A4.048	11/88 ⇒ 04/91
TIPO I 1.1	160A3.000	01/88 ⇒ 10/91
UNO 45 1.0	156A2.000	09/89 ⇒ 09/92
UNO 45 1.0 Fire	--	01/83 ⇒ 12/89
UNO 60 1.1	160A3.000	04/89 ⇒ 12/92
LANCIA		
Y10 1.0 Fire Trazione integrale	156A2.000, 156A2.100, 156A2.246	12/86 ⇒ 02/92
Y10 1.1 i.e Fire	156C.000	08/89 ⇒ 06/92
Y10 1.1 i.e Fire Trazione integrale	156C.000	08/89 ⇒ 06/92

EPS 1.315.081



04

DISTRIBUTOR CAPS

Adatt./Suitable: **DUCELLIER****RENAULT**

77 01 033 621



RENAULT		
19 I 1.2i	E7F	01/89 ⇒ 12/92
19 I 1.4	E6J700, E6J701, E7J700	01/88 ⇒ 12/92
19 I 1.8 16V	F7P700, F7P704	06/89 ⇒ 09/92
19 II 1.2	E7F730	05/92 ⇒ 09/94
19 II 1.4	E6J706, E7J706, E7J707, E7J742, E7J745	01/92 ⇒ 12/95
19 II 1.8 16V	F7P704	04/92 ⇒ 06/96
25 2.0 12V	74AR-FXE, 7CYQD80D-E3, J7R721	06/88 ⇒ 12/93
CLIO I 1.2	E5F710, E5F716, E7F700, E7F706, E7F708, E7F750	05/90 ⇒ 09/98
CLIO I 1.4	E6J712, E6J713, E6J718, E7J601, E7J710, E7J711, E7J716, E7J718, E7J719, E7J754, E7J756, E7J757	01/90 ⇒ 09/98
CLIO I 1.8 16V	F7P720, F7P722	01/91 ⇒ 03/96
CLIO I Williams	F7R700	01/94 ⇒ 09/98
MEGANE I 1.4	E7J764	09/96 ⇒ 08/03
MEGANE I 1.4 e	E7J764	01/96 ⇒ 08/03
MEGANE I 1.4 Eco	E7J624	01/96 ⇒ 03/99
MEGANE SCÉNIC I 1.4 i	E7J764	01/97 ⇒ 09/99
RAPID 1.4	E6J738, E7J720, E7J724, E7J726, E7J728, E7J770, E7J771, E7J773	09/91 ⇒ 03/98
RAPID 1.4 RN	E6J734	09/91 ⇒ 08/93
SAFRANE I 2.0	0LJY, J7R732, J7R738, J7R739	08/92 ⇒ 09/96
SAFRANE I 2.0 12V	J7R734, J7R735	04/92 ⇒ 07/96
SAFRANE I 2.2	1MR4790B, J7T761, J7T762	04/92 ⇒ 07/96
TRAFIC I 2.0	J5R726	05/89 ⇒ 08/90
TRAFIC I 2.0 RWD	J5R726	05/89 ⇒ 10/97

EPS 1.315.082



05

DISTRIBUTOR CAPS

Adatt./Suitable: **DUCELLIER****RENAULT**

77 01 203 118

¹¹¹ Paired article numbers

- N° articolo appaiato
- Numéro d'article en paire
- paarige Artikelnummer
- Referencia artículo par

1.315.083



RENAULT		
21 2.0	J7R740	02/90 ⇒ 06/94
21 2.0 4x4	J7R740	12/89 ⇒ 02/94
21 2.0 Turbo	J7R752, J7R756	04/87 ⇒ 10/92
21 2.0 Turbo 4x4	J7R752, J7R756	08/89 ⇒ 10/93
21 2.0 TXi	1SCRMP10U1, J7R740	07/89 ⇒ 05/93
CLIO I 1.8 16V	F7P720, F7P722	01/91 ⇒ 03/96
CLIO I Williams	F7R700	01/94 ⇒ 09/98
SAFRANE I 2.0	0LJY, J7R732, J7R738, J7R739	08/92 ⇒ 09/96
SAFRANE I 2.0 12V	J7R734, J7R735	04/92 ⇒ 07/96

RENAULT

SAFRANE I 2.2

1MR4790B, J7T761, J7T762

04/92 ⇒ 07/96

EPS 1.315.083



05

DISTRIBUTOR CAPS

Adatt./Suitable: **DUCELLIER****DUCELLIER**

2 525 645 A *B

RENAULT77 00 739 893 *B
77 00 742 853 *B
77 00 743 290 *M
77 00 743 602 *M
77 01 203 118 *M^{*B} Available distributor cap and rotor, only-not the distributor assy

- Forniti solo calotta e distributore rotante, no lo spinterogeno completo
- Disponibles seulement la tete et le rotor, non pas l'allumeur complet
- Erhältlich nur kappe und rotor, nicht der komplette verteiler
- Disponibles solo la tapa y el rotor, no el distribuidor completo

^{*M} Kit Distributor cap / Rotor

- Kit Calotta / Distributore
- Kit Tête d'allumeur / Disrupteur
- Bausatz VerteilerKappe / -läufer
- Juego Tapa del distribuidor / Rotor



RENAULT		
21 2.0	J7R740	02/90 ⇒ 06/94
21 2.0 4x4	J7R740	12/89 ⇒ 02/94
21 2.0 Turbo	J7R752, J7R756	04/87 ⇒ 10/92
21 2.0 Turbo 4x4	J7R752, J7R756	08/89 ⇒ 10/93
21 2.0 TXi	1SCRMP10U1, J7R740	07/89 ⇒ 05/93
25 2.0 12V	74AR-FXE, 7CYQD80D-E3, J7R721	06/88 ⇒ 12/93
CLIO I 1.8 16V	F7P720, F7P722	01/91 ⇒ 03/96
CLIO I Williams	F7R700	01/94 ⇒ 09/98
SAFRANE I 2.0	0LJY, J7R732, J7R738, J7R739	08/92 ⇒ 09/96
SAFRANE I 2.0 12V	J7R734, J7R735	04/92 ⇒ 07/96
SAFRANE I 2.2	1MR4790B, J7T761, J7T762	04/92 ⇒ 07/96

EPS 1.315.084



07

DISTRIBUTOR CAPS

Adatt./Suitable: **DUCELLIER****GENERAL MOTORS**

90 442 011

OPEL

12 11 275

⁰³ Supplied until depletion

- Fornibile fino ad esaurimento delle scorte
- Fourni jusqu'à épuisement du stock
- Lieferbar solange vorrat reicht
- Suministrado hasta el stock termina



OPEL		
ASTRA F 1.6	16LZ2, 16NZ2	09/94 ⇒ 09/98
ASTRA F 1.8 i	C18NZ	09/91 ⇒ 09/98
ASTRA F 2.0 i	C20NE	09/91 ⇒ 09/98
CALIBRA A 2.0 i	C20NE	08/89 ⇒ 12/96
CALIBRA A 2.0 i 4x4	C20NE	06/90 ⇒ 07/97
FRONTERA A 2.0 i	C20NE	03/92 ⇒ 10/98
KADETT E 1.8	18SE	01/86 ⇒ 08/91
KADETT E 1.8 i	C18NZ, S18NV	06/85 ⇒ 05/92

OPEL		
KADETT E 2.0 GSI	20NE, 20SEH	09/86 ⇒ 08/91
KADETT E 2.0 GSI Cat	C20NE	09/86 ⇒ 08/91
KADETT E 2.0 i	20NE	10/86 ⇒ 02/93
KADETT E 2.0 i Cat	C20NE	10/86 ⇒ 02/93
OMEGA A 1.8	18SEH, E18NVR, S18NV	09/86 ⇒ 03/94
OMEGA A 1.8 N	18NV	09/86 ⇒ 08/87
OMEGA A 1.8 S	18SV	09/86 ⇒ 03/94
OMEGA A 2.0	20SE, C20NE	09/86 ⇒ 04/94
OMEGA A 2.0 i	C20NE	09/86 ⇒ 04/94
OMEGA B 2.0	20SE	03/94 ⇒ 12/00
VECTRA 1.6	C16LZ2	08/92 ⇒ 07/93
VECTRA 1.6 i	C16NZ2	09/88 ⇒ 11/95
VECTRA 1.6 i Cat	C16NZ2	09/88 ⇒ 11/95
VECTRA A 1.8 i	18SV	09/88 ⇒ 10/90
VECTRA A 1.8 i Cat	C18NZ	03/90 ⇒ 11/95
VECTRA A 1.8 S	18SV, E18NVR	09/88 ⇒ 10/90
VECTRA A 1.8 S 4x4	E18NVR	01/89 ⇒ 07/89
VECTRA A 2.0 i	20NE, 20SEH	09/88 ⇒ 09/92
VECTRA A 2.0 i 4x4	20NE, 20SEH	01/89 ⇒ 07/92
VECTRA A 2.0 i Cat	C20NE	09/88 ⇒ 11/95
VECTRA A 2.0 i Cat 4x4	C20NE	01/89 ⇒ 11/95
VECTRA A 2.0 i GT	20SEH	09/88 ⇒ 11/95
VECTRA B 1.6 i	16LZ2	10/95 ⇒ 07/03
VAUXHALL		
ASTRA III 1.8 i	C18NZ	09/91 ⇒ 09/98
ASTRA III 2.0 i	C20NE	09/91 ⇒ 09/98
CALIBRA 2.0 i	C20NE	06/90 ⇒ 07/97
CALIBRA 2.0 i 4x4	C20NE	06/90 ⇒ 07/97
FRONTERA A 2.0	C20NE	04/95 ⇒ 08/98
FRONTERA A 2.0 i	C20NE	03/92 ⇒ 10/98
OMEGA B 2.0	20SE	09/95 ⇒ 09/96

EPS 1.315.086



DISTRIBUTOR CAPS

Adatt./Suitable: **DUCELLIER**
DUCELLIER
 2 525 623 D *M
RENAULT
 77 00 859 053 *M

- *M Kit Distributor cap / Rotor**
- Kit Calotta / Distributore
 - Kit Tête d'allumeur / Disrupteur
 - Bausatz VerteilerKappe / -läufer
 - Juego Tapa del distribuidor / Rotor



RENAULT

CLIO I 1.8	0HR10DE	08/90 ⇒ 09/98
LAGUNA I 1.8	F3P678, F3P720, F3P724	11/93 ⇒ 03/01
LAGUNA I 2.0	6Z7U730, F3R722	11/93 ⇒ 03/01

EPS 1.315.087



DISTRIBUTOR CAPS

Adatt./Suitable: **DUCELLIER**
CITROËN
 5940 57
FIAT
 9567469880

- *212 Resistance Rotor [Ohm] 1000**
- Rotore resistenza [Ohm] 1000
 - Résistance rotor [ohm] 1000
 - Widerstand-Rotor [Ohm] 1000
 - Resistencia rotor [ohm] 1000



CITROËN

AX 1.3 Sport	M4A	04/87 ⇒ 12/88
AX 10	C1A	09/86 ⇒ 06/92
AX 10 E	C3A	12/86 ⇒ 12/88
AX 11	H1A, H1B, HDZ(TU1M)	09/86 ⇒ 12/97
AX 11 4x4	H1A	06/91 ⇒ 07/92
AX 11 Cat	HAZ(TU1CP)	09/88 ⇒ 12/89
AX 14	K1A(TU3), K1B, K1F, K1G, K1J, K2A, K2B, K2D, KAY(TU3CP), KDX(TU3M/Z), KDY(TU3FM), KDZ(TU3M/Z)	09/86 ⇒ 04/97
AX 14 4x4	KD4, KDX(TU3M/Z), KDY(TU3FM), KDZ(TU3M/Z)	06/91 ⇒ 12/96
AX 14 GT	KDZ(TU3M/Z)	01/89 ⇒ 12/91
BX 1.1	109LA, H1A	04/86 ⇒ 06/91
BX 1.4	150C, K1F, K2D	07/86 ⇒ 12/94
BX 1.4 E	150B(XY8), 150J, 150Y, K1F, KAZ	09/82 ⇒ 12/94
BX 1.6	B2C	02/88 ⇒ 12/94
BX 1.9	159B, 159C, D6U, DKK	05/85 ⇒ 12/94
BX 1.9 GTi	D6D, D6K	01/87 ⇒ 01/92
BX 14	150C, KDY(TU3M), KDZ(TU3M/Z)	01/86 ⇒ 02/93
BX 14 E	150A, 150C, K1G	10/82 ⇒ 02/93
BX 15	B1E(XU51C)	01/87 ⇒ 05/92

EPS 1.315.085



DISTRIBUTOR CAPS

Adatt./Suitable: **DUCELLIER*****111 Paired article numbers**

- N° articolo appaiato
- Numéro d'article en paire
- paarige Artikelnummer
- Referencia artículo par

1.315.086

RENAULT

CLIO I 1.8	0HR10DE	08/90 ⇒ 09/98
LAGUNA I 1.8	F3P678, F3P720, F3P724	11/93 ⇒ 03/01
LAGUNA I 2.0	6Z7U730, F3R722	11/93 ⇒ 03/01

CITROËN

BX 16	171A, 171B, 171C, 171D, 23DH, B1E(XU51C), BAY(XU5CP), BAZ(XU5CP), BDY(XU5M), BDZ(XU5M)	10/82 ⇒ 12/94
BX 16 E	BDY(XU5M), BDZ(XU5M)	05/89 ⇒ 02/93
BX 19	159A, D2A(XU92C), D2C(XU92C), D2E, D6A(XU9J2), DDZ(XU9M), DKZ(XU9JA)	09/84 ⇒ 12/94
BX 19 4x4	DDZ(XU9M)	10/90 ⇒ 05/91
BX 19 Cat	DFZ(XU9J1)	07/86 ⇒ 12/94
BX 19 E	DDZ(XU9M)	06/88 ⇒ 02/93
BX 19 E 4x4	D2F	04/89 ⇒ 02/93
BX 19 GTi	D6A(XU9J2), DKZ(XU9JA)	07/86 ⇒ 02/93
BX 19 GTi 4x4	DKZ(XU9JA)	06/88 ⇒ 02/93
C15 1.0	108C(XV8), C1A, C1A(TU9/K), C1B(TU9/W), TU9	10/84 ⇒ 12/97
C15 1.1	H1A, HDZ(TU1M), TU1	08/88 ⇒ 07/96
C15 1.1 i	HDZ(TU1M), TU1MZ	07/88 ⇒ 12/96
C15 1.4	K1A, K1G, K1H(TU3A), KDY(TU3M)	07/87 ⇒ 12/96
C15 1.4 E	K1F, K1J, K2D, K3A, KAZ	07/86 ⇒ 12/96
C15 1.4 i	KDY(TU3FM), KDY(TU3M)	05/91 ⇒ 12/96
JUMPER I 2.0	XU102C	02/94 ⇒ 02/02
XMI 2.0	--	05/89 ⇒ 04/94
XMI 2.0 i	RDZ(XU10MZ), RFZ(XU10J2)	05/89 ⇒ 06/94
BERLINGO I 1.4	TU32	07/96 ⇒ 10/98
ZX 1.1	H1A, H1B, HDZ(TU1M), TU1	03/91 ⇒ 06/97
ZX 1.4 i	KDY(TU3M)	10/93 ⇒ 10/97
ZX 1.9	D6E(XU9JA)	03/91 ⇒ 06/97
ZX 1.9 i	DKZ(XU9JA), XU9JA	03/91 ⇒ 06/97
FIAT		
DUCATO II 2.0	--, R5B	03/94 ⇒ 12/95

EPS 1.315.088



DISTRIBUTOR CAPS

Adatt./Suitable: **DUCELLIER**
RENAULT
 77 01 202 755 *M

- *M Kit Distributor cap / Rotor**
- Kit Calotta / Distributore
 - Kit Tête d'allumeur / Disrupteur
 - Bausatz VerteilerKappe / -läufer
 - Juego Tapa del distribuidor / Rotor

***03 Supplied until depletion**

- Fornibile fino ad esaurimento delle scorte
- Fourni jusqu'à épuisement du stock
- Lieferbar solange vorrat reicht
- Suministrado hasta el stock termina

***216 contains article number**

- contiene il numero articolo
- contient le numéro d'article
- beinhaltet Artikelnummer
- número de artículo incluido

1.315.067 1.415.096R

RENAULT

ESPACE I 2.0 i	J7R760	01/89 ⇒ 12/90
ESPACE I 2.0 i Quadra	J7R760	03/88 ⇒ 12/92
ESPACE I 2.2	20G15DE	07/86 ⇒ 12/90
ESPACE I 2.2 Quadra	20G15DE	01/88 ⇒ 12/90

EPS 1.315.091



04

DISTRIBUTOR CAPS

Adatt./Suitable: **DUCELLIER****RENAULT**
77 00 729 838 *B

- *B Available distributor cap and rotor, only-not the distributor assy**
- Forniti solo calotta e distributore rotante, no lo spinterogeno completo
 - Disponibles seulement la tete et le rotor, non pas l'allumeur complet
 - Erhältlich nur kappe und rotor, nicht der komplette verteiler
 - Disponibles solo la tapa y el rotor, no el distribuidor completo

03 Supplied until depletion

- Fornibile fino ad esaurimento delle scorte
- Fourni jusqu'à épuisement du stock
- Lieferbar solange vorrat reicht
- Suministrado hasta el stock termina

216 contains article number

- contiene il numero articolo
- contient le numéro d'article
- beinhaltet Artikelnummer
- número de artículo incluido

1.315.059 1.415.088

RENAULT		
21 1.4	C2L714	06/88 ⇨ 12/95
25 2.0	08A, J6R763, J7R722, J7R723	04/84 ⇨ 12/93
25 2.0 12V	74AR-FXE, 7CYQD80D-E3, J7R721	06/88 ⇨ 12/93
25 2.2	04TNV88-C, 74G69-S4M, J7T708, J7T715, J7T730, J7T731, J7T732	04/84 ⇨ 12/92
RAPID 1.2	C1G726, C3G710, C3G712	09/91 ⇨ 03/98
RAPID 1.4	C1J768, C1J780, C2J784	07/85 ⇨ 08/91
RAPID 1.4 Cat	C3J700, C3J702, C3J760, C3J762	08/88 ⇨ 03/98
SUPER 5 1.2	C1G720, C1G722	01/87 ⇨ 08/90
SUPER 5 1.4	C1J768, C1J780, C1J788, C2J700, C2J780, C2J781, C2J782, C2J784, C2J788, C2J789, C3J700	10/84 ⇨ 08/90
SUPER 5 1.4 Cat	C3J700, C3J702, C3J760	10/85 ⇨ 12/96
SUPER 5 1.4 Turbo	C1J782, C1J788	04/85 ⇨ 08/90

EPS 1.317.014



07

DISTRIBUTOR CAPS

Adatt./Suitable: **FEMSA****GENERAL MOTORS**
93 150 093**SEAT**
000 389 978 9
186035.06
SE 141914.001C**00 Eliminated on 29-07-2020. Please verify the availability through our local distributors**

- Eliminato il 29-07-2020. Verificare la disponibilità presso i nostri distributori
- Éliminé le 29-07-2020. Vérifier la disponibilité auprès de nos distributeurs sur place
- Am 29-07-2020 gestrichen. Evtl. Verfügbarkeit bitte bei unseren Händlern prüfen
- Eliminado en fecha 29-07-2020. Verificar la disponibilidad a través de nuestros distribuidores locales

**SEAT**

IBIZA I 0.9	146A000	08/86 ⇨ 05/93
MARBELLA 0.9	09NCA	01/87 ⇨ 12/93
PANDA 0.9	100GL3000	10/80 ⇨ 12/86
PANDA 45	--	01/82 ⇨ 12/85
TERRA 0.9	09NCA	02/87 ⇨ 12/96

EPS 1.317.016



07

DISTRIBUTOR CAPS

Adatt./Suitable: **FEMSA****FIAT**
9936814**SEAT**
000 993 681 4
186036.06
NG1 860 360 6
SE 127914.001A**03 Supplied until depletion**

- Fornibile fino ad esaurimento delle scorte
- Fourni jusqu'à épuisement du stock
- Lieferbar solange vorrat reicht
- Suministrado hasta el stock termina

**FIAT**

127 0.9	100GL.048	06/71 ⇨ 05/83
---------	-----------	---------------

SEAT

FURA 0.9	100GL3000	01/82 ⇨ 06/86
MARBELLA 0.8	5K9K718	08/86 ⇨ 12/93
PANDA 34 850	--	01/80 ⇨ 12/83
PANDA 35 850	--	01/80 ⇨ 12/83

EPS 1.317.023



04

DISTRIBUTOR CAPS

Adatt./Suitable: **FEMSA****RENAULT**
77 02 124 325**RENAULT**

4 0.8	80001	09/71 ⇨ 12/88
4 1.1	688712	02/78 ⇨ 06/90
5 1.4	847725	01/82 ⇨ 12/85
11 1.4	C2J720, C2J766, C2J767, C2J768	03/83 ⇨ 12/88
11 1.7	F2N700	10/83 ⇨ 12/87
18 1.4	847720, 847722	04/78 ⇨ 07/86
19 I 1.2	C1G730	01/88 ⇨ 12/92
19 I 1.4	C2J772, C2J776, C3J710	07/88 ⇨ 05/93
19 I 1.4 Cat	C3J710	01/89 ⇨ 04/92
19 II 1.4	C3J710	04/92 ⇨ 12/95
EXPRESS 1.1	C1E	01/85 ⇨ 10/90
EXPRESS 955	C1C	01/85 ⇨ 10/90
RAPID 1.1	C1E750, C1E760	07/85 ⇨ 04/95
SUPER 5 1.0	C1C700	10/84 ⇨ 10/88

EPS 1.317.029



07

DISTRIBUTOR CAPS

Adatt./Suitable: **FEMSA****SEAT**
SE 028914.001B**03 Supplied until depletion**

- Fornibile fino ad esaurimento delle scorte
- Fourni jusqu'à épuisement du stock
- Lieferbar solange vorrat reicht
- Suministrado hasta el stock termina

**SEAT**

MARBELLA 0.8	5K9K718	08/86 ⇨ 12/93
--------------	---------	---------------

1.319.083

EPS 1.319.083



07

DISTRIBUTOR CAPS

Adatt./Suitable: FORD

FORD

0 267 2617
0 623 389
1 462 196
5 014 402
C6AH-12106-A
C7KH-12106-A

⁰³ Supplied until depletion

- Fornibile fino ad esaurimento delle scorte
- Fourni jusqu'à épuisement du stock
- Lieferbar solange vorrat reicht
- Suministrado hasta el stock termina

GENERAL MOTORS

7 992 207

Motorcraft

EDH 12
EDH 12 D
EDH 12 S
EDH 16



FORD		
CORTINA 1300	KL13H	10/70 ⇒ 03/72
FIESTA I 0.9	TKA, TKW, TLA	05/76 ⇒ 08/83
FIESTA I 1.3	J3E	08/77 ⇒ 08/83
TAUNUS 1.6	LCJ	07/79 ⇒ 07/82
TRANSIT I 1.6	4RB	11/77 ⇒ 10/86
TRANSIT I 2.0	4RC	11/77 ⇒ 07/82

EPS 1.319.092



07

DISTRIBUTOR CAPS

Adatt./Suitable: FORD

FORD

1 628 315
1 641 810
1 665 193
E3EE-12106-BA
E3EE-12106-BB
E5FZ-12106-B
E5FZ-12106-C
E9FZ-12106-A

⁰³ Supplied until depletion

- Fornibile fino ad esaurimento delle scorte
- Fourni jusqu'à épuisement du stock
- Lieferbar solange vorrat reicht
- Suministrado hasta el stock termina

Motorcraft

DH 390
DH 390B
DH 390E
DHE 411
EDH 390



FORD		
SIERRA I 2.0	NR2	03/85 ⇒ 12/86
SIERRA I 2.0 i	NR2	03/85 ⇒ 12/86
SCORPIO I 2.0 i	NRA, NRI	04/85 ⇒ 02/92

EPS 1.319.093



07

DISTRIBUTOR CAPS

Adatt./Suitable: FORD

FORD

1 643 632
E6AE-12106-CA
E6AZ-12106-A

JEEP

33004024
56026876

MAZDA

ZZM0-24-310
ZZM1-24-310
ZZM2-24-310

Motorcraft

DH 433
DH 434

RENAULT

89 33 004 024
89 56 026 876

⁰³ Supplied until depletion

- Fornibile fino ad esaurimento delle scorte
- Fourni jusqu'à épuisement du stock
- Lieferbar solange vorrat reicht
- Suministrado hasta el stock termina



JEEP		
CHEROKEE II 4.0 i	--, 1Z7K, ERH, MX	10/86 ⇒ 09/01
CHEROKEE II 4.0 i 4x4	ERH	01/95 ⇒ 09/01
COMANCHE 4.0 i	1Z7K	10/87 ⇒ 09/90
GRAND CHEROKEE 4.0 Laredo	ERH	10/96 ⇒ 09/98
GRAND WAGONEER 4.0 i	1Z7K	10/86 ⇒ 09/90
WAGONEER 4.0 i	1Z7K	10/86 ⇒ 09/90
WRANGLER 4.0	1Z7K, ERH	10/86 ⇒ 09/96

EPS 1.322.003



04

DISTRIBUTOR CAPS

Adatt./Suitable: HITACHI

BOSCH

F 005 X04 549

DAIHATSU

19101-87301

GENERAL MOTORS

7 992 396
94 021 067

HITACHI

44612700
82311214

HOLDEN

GH506

ISUZU

94021G67

MAZDA

3710-24-310

NISSAN

15501-208
22162-21007
22162-71300
22162-71312
22162-N8801
22162-N8801MP

⁰³ Supplied until depletion

- Fornibile fino ad esaurimento delle scorte
- Fourni jusqu'à épuisement du stock
- Lieferbar solange vorrat reicht
- Suministrado hasta el stock termina



HOLDEN		
ASTRA_LB 1.5	E15	08/84 ⇒ 01/86
NISSAN		
VANETTE II 1.5	A15	04/87 ⇒ 11/94

EPS 1.322.011



04

DISTRIBUTOR CAPS

Adatt./Suitable: HITACHI

HONDA

30102-PA1-732
30102-PA6-924
30102-PC1-004

LEYLAND

GDC147
GDC307

⁰⁰ Eliminated on 15-01-2020. Please verify the availability through our local distributors

- Eliminato il 15-01-2020. Verificare la disponibilità presso i nostri distributori
- Éliminé le 15-01-2020. Vérifier la disponibilité auprès de nos distributeurs sur place
- Am 15-01-2020 gestrichen. Evtl. Verfügbarkeit bitte bei unseren Händlern prüfen
- Eliminado en fecha 15-01-2020. Verificar la disponibilidad a través de nuestros distribuidores locales



HONDA		
CIVIC II 1.3 [USA]	--	01/81 ⇒ 12/83

EPS 1.322.022



05

DISTRIBUTOR CAPS

Adatt./Suitable: HITACHI

HONDA

30102-PD2-006
30102-PD2-016

⁰³ Supplied until depletion

- Fornibile fino ad esaurimento delle scorte
- Fourni jusqu'à épuisement du stock
- Lieferbar solange vorrat reicht
- Suministrado hasta el stock termina



HONDA		
ACCORD III 1.6 L	A16A1	11/85 ⇒ 12/89
ACCORD III 2.0	A20A2	01/86 ⇒ 12/86
ACCORD III 2.0 16V EXS	B20A2	01/88 ⇒ 12/89
ACCORD III 2.0 EX	A20A2	11/85 ⇒ 05/89
ACCORD III 2.0 i 16V	B20A2, B20A8	01/87 ⇒ 12/89
ACCORD VI 1.6	A16A5	10/98 ⇒ 12/02
CIVIC III 1.5 i Si [USA]	--	01/84 ⇒ 12/87
ROVER		
200 I 213 S	EV2	09/85 ⇒ 09/89

EPS 1.322.040



07,5

DISTRIBUTOR CAPS

Adatt./Suitable: **HITACHI****BOSCH**F 005 X04 563
F 005 X04 581**03 Supplied until depletion**

- Fornibile fino ad esaurimento delle scorte
- Fourni jusqu'à épuisement du stock
- Lieferbar solange vorrat reicht
- Suministrado hasta el stock termina

NISSAN22162-06W00
22162-06W03
22162-06W03MP
22162-06W04
22162-06W04MP
22162-06W05
22162-06W06
22162-18F01
22162-W4502
B2162-06W05**NISSAN**

200 SX 1.8i Turbo	CA18ET	01/87 ⇒
PICK UP I 2.4 [USA]	Z24i	01/85 ⇒ 12/89
TERRANO I 2.4 i 4WD	Z24i	10/87 ⇒ 02/93
URVAN III 2.4 i	Z24i	05/89 ⇒ 09/93
VAN 2.4 [USA]	Z24i	01/86 ⇒ 12/89
VANETTE II 2.0	Z20S	07/87 ⇒ 08/94

EPS 1.322.041



04

DISTRIBUTOR CAPS

Adatt./Suitable: **HITACHI****BOSCH**

1 987 233 108

03 Supplied until depletion

- Fornibile fino ad esaurimento delle scorte
- Fourni jusqu'à épuisement du stock
- Lieferbar solange vorrat reicht
- Suministrado hasta el stock termina

NISSAN

22162-KA020

SUBARU22162-KA020
22162-KA050**SUBARU**

J-SERIES 1.0i EFC-SYS	--	01/89 ⇒
J-SERIES 1.2	--	01/87 ⇒ 12/91
J-SERIES 1.2 SDX	--	01/89 ⇒ 12/91
J-SERIES 1.2i EFC-SYS	--	01/89 ⇒
JUSTY 1.2 [USA]	--	01/87 ⇒ 12/92
TRENDY 1.0	EF10	08/86 ⇒ 05/95
TRENDY 1.2 12v	EF12	06/86 ⇒ 08/95

EPS 1.322.046



05

DISTRIBUTOR CAPS

Adatt./Suitable: **HITACHI****FORD**

1 953 281

NISSAN22162-01B01
22162-12E01
22162-17M00
22162-17M01
22162-17M02
22162-17M03
22162-17M04
22162-17M05
22162-21F03
22162-40F00
22162-78A00**SUBARU**

22162-AA040

SUZUKI33321-64B10
33321-64B10-000**03 Supplied until depletion**

- Fornibile fino ad esaurimento delle scorte
- Fourni jusqu'à épuisement du stock
- Lieferbar solange vorrat reicht
- Suministrado hasta el stock termina

**FORD**

MAVERICK 2.4 i KA24E 02/93 ⇒ 08/96

NISSAN

100NX 1.6	GA16DS	03/90 ⇒ 10/94
BLUEBIRD 1.8 Turbo	CA18T	04/84 ⇒ 11/92
BLUEBIRD 2.0 i	CA20E	04/84 ⇒ 12/90
NX1600 1.6i [USA]	GA16, GA16DE	01/88 ⇒ 12/92
PICK UP I 2.4 i [USA]	KA24E	01/89 ⇒
PICK UP I 2.4 i 12V	KA24E	04/92 ⇒ 02/98
PICK UP I 2.4 i 12V 4WD	KA24E	04/92 ⇒ 02/98
PRIMERA I 1.6 i	GA16DS	07/90 ⇒ 03/98
PULSAR NX 1.6 [USA]	GA16	01/88 ⇒
SENTRA III 1.6i [USA]	GA16DE	01/90 ⇒ 12/92
SILVIA 1.8	--	01/84 ⇒
SUNNY II 1.0 L	E10S	07/86 ⇒ 09/90
SUNNY II 1.6 i 12V	GA16i	06/86 ⇒ 06/91
SUNNY III 1.6 16V 4x4	GA16DS	11/90 ⇒ 05/95
SUNNY III 1.6 i	GA16DE, GA16DS	10/90 ⇒ 03/00
SUNNY III 1.6 i 16V 4WD	GA16DE, GA16DS	10/90 ⇒ 06/95
SUNNY III 1.6 i 16V 4x4	GA16DE	10/92 ⇒ 03/00
TERRANO II 2.4 4WD	KA24E	05/96 ⇒ 09/07
TERRANO II 2.4 i 12V 4WD	KA24E	02/93 ⇒ 12/97

SUBARU

LOYALE 1.8i SPi [USA]	--	01/90 ⇒
LOYALE 1.8i Turbo [USA]	--	01/90 ⇒
L-SERIES 1.8i	--	01/86 ⇒ 12/91
L-SERIES 1.8i TB	--	01/86 ⇒ 12/91
L-SERIES 1.8i TB 4x4	--	01/86 ⇒ 12/91
L-SERIES 1.8i Turbo	--	01/86 ⇒ 12/91
XT 1.8 [USA]	--	01/87 ⇒ 12/92

SUZUKI

SWIFT I / II / III 1.3 GTi	G13B	03/89 ⇒ 05/01
SWIFT I / II / III 1.3 GTi DOHC	G13B	10/89 ⇒ 12/95
SWIFT I / II 1.3 GTi/GXi	G13B	08/85 ⇒ 03/89

EPS 1.322.048



04

DISTRIBUTOR CAPS

Adatt./Suitable: **HITACHI****HITACHI**

43J83-17001

SUBARU

49100-5501

03 Supplied until depletion

- Fornibile fino ad esaurimento delle scorte
- Fourni jusqu'à épuisement du stock
- Lieferbar solange vorrat reicht
- Suministrado hasta el stock termina

**SUBARU**

J-SERIES 1.0	--	01/87 ⇒ 12/91
TRENDY 1.0	EF10	08/86 ⇒ 05/95

EPS 1.322.057



07

DISTRIBUTOR CAPS

Adatt./Suitable: **HITACHI****BOSCH**

F 005 X04 565

HOLDEN2216215M04
GH617**NISSAN**22162-15M00
22162-15M01
22162-15M01MP
22162-15M02
22162-15M02MP
22162-15M03
22162-15M03MP
22162-15M04
22162-52A01**03 Supplied until depletion**

- Fornibile fino ad esaurimento delle scorte
- Fourni jusqu'à épuisement du stock
- Lieferbar solange vorrat reicht
- Suministrado hasta el stock termina

SUBARU

49100-8711

**HOLDEN**

ASTRA_LB 1.5	E15	08/84 ⇒ 01/86
ASTRA_LC 1.6	E16S	02/86 ⇒ 06/87

NISSAN

LAUREL 2.0 GL	CA20S	11/84 ⇒ 12/85
PULSAR 1.6	E16	01/84 ⇒ 12/86
PULSAR 1.6 [USA]	E16	01/82 ⇒ 12/83
SUNNY II 1.0 L	E10S	07/86 ⇒ 09/90
SUNNY II 1.3	E13S	06/86 ⇒ 10/91
SUNNY II 1.5	E15S	06/86 ⇒ 10/88
SUNNY II 1.6	E16S	06/86 ⇒ 10/88

SUBARU

L-SERIES 1.3	--	01/79 ⇒ 12/91
L-SERIES 1.6	--	01/86 ⇒ 12/87

EPS 1.322.058



05

DISTRIBUTOR CAPS

Adatt./Suitable: **HITACHI****SUBARU**
22162-AA030

⁰⁰ Eliminated on 22-02-2022. Please verify the availability through our local distributors

- Eliminato il 22-02-2022. Verificare la disponibilità presso i nostri distributori
- Éliminé le 22-02-2022. Vérifier la disponibilité auprès de nos distributeurs sur place
- Am 22-02-2022 gestrichen. Evtl. Verfügbarkeit bitte bei unseren Händlern prüfen
- Eliminado en fecha 22-02-2022. Verificar la disponibilidad a través de nuestros distribuidores locales

**SUBARU**

L-SERIES 1.6 -- | 01/87 ⇒ 12/91

EPS 1.322.060



05

DISTRIBUTOR CAPS

Adatt./Suitable: **HITACHI****BOSCH**

F 005 X12 695

GENERAL MOTORS

94 322 990

HOLDEN

8943229900

HONDA

8-94322-990-0

ISUZU

8-94322990-0

OPEL

43 00 982

⁰³ Supplied until depletion

- Fornibile fino ad esaurimento delle scorte
- Fourni jusqu'à épuisement du stock
- Lieferbar solange vorrat reicht
- Suministrado hasta el stock termina

**HOLDEN**

RODEO_TF 2.6i 4ZE1 | 08/88 ⇒ 03/96

RODEO_TF 2.6i 4x4 4ZE1 | 08/88 ⇒ 03/96

HONDA

PASSPORT 2.6 i [USA] 4ZE1 | 01/94 ⇒

ISUZU

AMIGO 2.3i [USA] LW3 | 01/88 ⇒

AMIGO 2.6i [USA] RLJ | 01/88 ⇒

PICK-UP 2.3i [USA] LW3 | 01/88 ⇒

PICK-UP 2.6i [USA] RLJ | 01/88 ⇒

RODEO 2.6i [USA] RLJ | 01/90 ⇒

OPEL

CAMPO 2.3 23P | 08/94 ⇒ 09/96

EPS 1.322.063



05

DISTRIBUTOR CAPS

Adatt./Suitable: **HITACHI****NISSAN**
22162-11E07

⁰⁰ Eliminated on 14-04-2020. Please verify the availability through our local distributors

- Eliminato il 14-04-2020. Verificare la disponibilità presso i nostri distributori
- Éliminé le 14-04-2020. Vérifier la disponibilité auprès de nos distributeurs sur place
- Am 14-04-2020 gestrichen. Evtl. Verfügbarkeit bitte bei unseren Händlern prüfen
- Eliminado en fecha 14-04-2020. Verificar la disponibilidad a través de nuestros distribuidores locales

**NISSAN**

BLUEBIRD 1.6 CA16S | 12/85 ⇒ 06/90

BLUEBIRD 1.6 DX CA16S | 11/83 ⇒ 02/88

BLUEBIRD 2.0 CA20S | 12/85 ⇒ 09/90

EPS 1.322.068



07

DISTRIBUTOR CAPS

Adatt./Suitable: **HITACHI****ACURA**

30102-P54-006

30102-PT2-006

BOSCH

1 987 233 127

F 005 X12 891

HONDA

30102-P54-006

30102-PCB-004

30102-PEL-J01

30102-PT2-006

30102-PT2-016

30102-PT2-026

ROVER

GDC405

GDC406

NJD100150

**ACURA**

INTEGRA II 1.8 F18A2 | 10/90 ⇒ 09/93

INTEGRA III 1.8 LS F18C1 | 10/93 ⇒ 09/01

INTEGRA III 1.8 Sport F18C1 | 10/93 ⇒ 09/01

HONDA

ACCORD IV 2.0 16V F20A5 | 01/90 ⇒ 12/93

ACCORD IV 2.0 i 16V F20A4, F20A7, F20A8, F20Z3 | 01/90 ⇒ 12/93

ACCORD IV 2.2 F22A6 | 05/92 ⇒ 12/93

ACCORD IV 2.2 i 16V F22A3, F22A7, F22A8 | 01/90 ⇒ 12/93

ACCORD IV 2.2 i 16V F22A3 | 01/90 ⇒ 03/93

Automatik

ACCORD V 1.8 16V F18A3 | 01/94 ⇒ 12/95

ACCORD V 2.0 F20B3 | 09/93 ⇒ 12/97

ACCORD V 2.0 i F20Z2 | 03/93 ⇒ 01/96

ACCORD V 2.0 i LS 16V F20B3 | 09/93 ⇒ 02/98

ACCORD V 2.0 i S F20Z1 | 03/93 ⇒ 01/96

ACCORD V 2.2 i 16V F22B4 | 08/95 ⇒ 12/97

HONDA

ACCORD V 2.2 i ES	F22B5	09/93 ⇒ 02/98
ACCORD V 2.3 i SR	H23A3	03/93 ⇒ 01/96
ACCORD VI 2.2 Type-R	H22A7	02/99 ⇒ 12/02
CIVIC V 1.5	D15B7	08/93 ⇒ 12/95
CIVIC V 1.5 i 16V	D15B2, D15Z1	10/91 ⇒ 11/95
CIVIC V 1.5 i LSi	D15B7	08/93 ⇒ 11/95
CIVIC V 1.6 16V Vtec	D16Z6, D16Z7	10/91 ⇒ 11/95
CIVIC V 1.6 4x4	D16Z7	01/92 ⇒ 10/95
CIVIC V 1.6 EX	D16A7	08/93 ⇒ 10/95
CIVIC V 1.6 i	D16V7	01/94 ⇒ 11/95
CIVIC V 1.6 i Vtec	B16A2, D16Z9	01/94 ⇒ 03/96
CIVIC V 1.6 VTi	B16A2	10/91 ⇒ 11/95
CIVIC V 1.6 VTi 16V	B16A2	10/91 ⇒ 11/95
BALLADE 1.6i	B16A6	01/97 ⇒ 02/01
BALLADE 1.8 i	B18B4	01/96 ⇒ 02/01
CIVIC IV 1.6i	--	01/90 ⇒ 12/91
CIVIC VI 1.4 i	D14A2, D14A5, D14Z2	06/95 ⇒ 02/01
CIVIC VI 1.4 i S	D14Z2	11/95 ⇒ 02/01
CIVIC VI 1.4i 16V	D14Z1	11/98 ⇒ 03/01
CIVIC VI 1.5 i	D15Z6	11/95 ⇒ 02/01
CIVIC VI 1.5 i Vtec-E	D15Z3	09/94 ⇒ 01/97
CIVIC VI 1.6	--	05/96 ⇒ 04/99
CIVIC VI 1.6 i	D16Y3	09/94 ⇒ 03/00
CIVIC VI 1.6 i Vtec	B16A2, D16Y2, D16Y8	09/94 ⇒ 02/01
CIVIC VI 1.6 VTi	B16A2	11/95 ⇒ 02/01
CIVIC VI 1.6i 16V	D16V7	01/96 ⇒
CIVIC VI 1.6i 16V Vtec	D16V8	01/96 ⇒ 09/99
CR-V 1 2.0	B20Z1	04/99 ⇒ 02/02
CR-V i 2.0 16V 4WD	B20B, B20Z1	10/95 ⇒ 02/02
CR-V i 2.0 i 16V	B20B3, B20B4, B20B9, B20Z3	02/97 ⇒ 04/99
CRX III 1.6 ESi	D16Y8, D16Z6	03/92 ⇒ 12/98
CRX III 1.6 i VTi	B16A2	03/92 ⇒ 12/98
HR-V 1.6 16V	350Y	03/99 ⇒
HR-V 1.6 16V 4WD	350Y, D16W5	03/99 ⇒
HR-V 1.6i 16V	D16W2	04/99 ⇒
INTEGRA 1.8 i	B18B1	01/98 ⇒
LOGO 1.3	D13B7	03/99 ⇒ 03/02
PRELUDE IV 2.0 i 16V	F20A4	02/92 ⇒ 09/96
PRELUDE IV 2.2 i 16V Vtec	H22A2	02/93 ⇒ 09/96
PRELUDE IV 2.3 i 16V	H23A2	02/92 ⇒ 09/96
PRELUDE V 2.0 16V	F20A4	10/96 ⇒ 10/00
PRELUDE V 2.2 16V	H22A5	10/96 ⇒ 10/00
PRELUDE V 2.2 i 16V	F22A2	10/96 ⇒ 10/01
PRELUDE V 2.2 i 16V VTi-R	H22A8	10/98 ⇒ 12/01
PRELUDE V 2.2 Si	F22Z6	03/97 ⇒ 07/02
SHUTTLE 2.2 16V	F22B8	10/94 ⇒ 02/98

ROVER

400 II 416 Si	D16Y2	03/95 ⇒ 03/00
600 618 i/Si	F18A3	03/96 ⇒ 02/99
600 620 i	F20Z2	08/93 ⇒ 06/96
600 620 Si	F20Z1	08/93 ⇒ 02/99
600 623 Si	H23A3	08/93 ⇒ 06/99

EPS 1.322.069

 07,5**DISTRIBUTOR CAPS**Adatt./Suitable: **HITACHI****ACURA**30102-PM5-A02
BOSCH
1 987 233 125**03 Supplied until depletion**

- Fornibile fino ad esaurimento delle scorte
- Fourni jusqu'à épuisement du stock
- Lieferbar solange vorrat reicht
- Suministrado hasta el stock termina

HONDA30102-PM5-A02
30102-PM5-A03
30102-PM5-A04
30102-PM5-A05
30102-PM7-006
30102-PM7-016
30102-PM7-036
30102-PR3-003
30102-PR3-006
30102-PR3-026
30102-PR4-A02**211 Resistance [kOhm] 5**

- Resistenza [kOhm] 5
- Résistance [kOhm] 5
- Widerstand [kOhm] 5
- Resistencia [kOhm] 5

ROVERGDC346
GDC347
NJD10006
NJD10008
NJD10009**ACURA**

INTEGRA I 1.6	D16A1	01/85 ⇨ 12/90
INTEGRA I 1.6 i	D16A8	01/85 ⇨ 12/90

HONDA

CIVIC IV 1.5 i 16V	D15B2	10/87 ⇨ 09/91
CIVIC IV 1.6i	--	01/90 ⇨ 12/91
CIVIC IV SHUTTLE 1.5 i 16V	D15B2	01/88 ⇨ 11/91
CIVIC IV SHUTTLE 1.6i	--	01/88 ⇨ 12/91
CIVIC IV SHUTTLE 1.6i 16V 4WD	D16Z2	01/88 ⇨ 12/92
CONCERTO 1.5 i	--	01/90 ⇨ 12/91
CONCERTO 1.6i DOHC	--	01/90 ⇨ 12/91
CONCERTO 1.6i SOHC	--	01/90 ⇨ 12/91

ROVER

200 II 216 GSi	1GH5E-180, D16A7	10/89 ⇨ 12/95
200 II 216 GTi	D16A8, D16A9	01/90 ⇨ 10/95
400 I 416 GTi/GTE	D16A9	04/90 ⇨ 04/95

EPS 1.322.071

 07**DISTRIBUTOR CAPS**Adatt./Suitable: **HITACHI****BOSCH**

1 987 233 126

03 Supplied until depletion

- Fornibile fino ad esaurimento delle scorte
- Fourni jusqu'à épuisement du stock
- Lieferbar solange vorrat reicht
- Suministrado hasta el stock termina

HONDA30102-PM3-015
30102-PM3-025
30102-PM3-035
30102-PM3-045**HONDA**

ACCORD IV 1.8	--	01/90 ⇨ 12/91
ACCORD IV 2.0 16V	F20A2, F20A3, F20A6	01/90 ⇨ 03/93
CIVIC V 1.3	D13B2	01/92 ⇨ 12/92
CIVIC V 1.3 16V	D13B2	10/91 ⇨ 11/95
CIVIC IV 1.2	D12B1	01/88 ⇨ 12/91
CIVIC IV 1.3	D13B1	10/87 ⇨ 12/89
CIVIC IV 1.3 [USA]	--	09/87 ⇨ 12/89
CIVIC IV 1.3 16V Cat	D13B2	09/89 ⇨ 09/91

HONDA

CIVIC IV 1.4 L	D14A1	10/87 ⇨ 12/89
CIVIC IV 1.4i 16V	D14A1	01/90 ⇨ 12/91
CIVIC IV SHUTTLE 1.4 i 16V	D14A1	01/88 ⇨ 12/92
CONCERTO 1.4	D14A1	08/89 ⇨ 10/92
CONCERTO 1.6i	D16A	01/90 ⇨ 12/91

EPS 1.322.073

 05**DISTRIBUTOR CAPS**Adatt./Suitable: **HITACHI****INFINITI**

22162-53J00

NISSAN

22162-53J00

03 Supplied until depletion

- Fornibile fino ad esaurimento delle scorte
- Fourni jusqu'à épuisement du stock
- Lieferbar solange vorrat reicht
- Suministrado hasta el stock termina

**INFINITI**

G20 2.0	SR20DE	01/90 ⇨ 12/97
---------	--------	---------------

NISSAN

100NX 2.0	SR20DE	10/90 ⇨ 10/94
100NX 2.0 GTI	SR20DE	03/91 ⇨ 10/94
PRIMERA I 2.0 i	SR20DI	07/90 ⇨ 03/98
SENTRA III 2.0i [USA]	SR20DE	01/90 ⇨
SUNNY III 2.0 GTI 16V	SR20DE	10/90 ⇨ 05/95
SUNNY III 2.0 GTI-R 4x4	SR20DET	10/90 ⇨ 05/95

EPS 1.322.075

 05**DISTRIBUTOR CAPS**Adatt./Suitable: **HITACHI****SUBARU**

22162-AA060

03 Supplied until depletion

- Fornibile fino ad esaurimento delle scorte
- Fourni jusqu'à épuisement du stock
- Lieferbar solange vorrat reicht
- Suministrado hasta el stock termina

**SUBARU**

LEGACY I 1.8i Spi	--	01/89 ⇨
LEGACY I 1800	EJ18SPI	01/89 ⇨ 07/94
LEGACY I 1800 4WD	EJ18SPI	01/89 ⇨ 07/94

EPS

1.322.076

 07**DISTRIBUTOR CAPS**Adatt./Suitable: **HITACHI****HONDA**30102-P12-A01
30102-P12-A01
30102-PT3-A12**03 Supplied until depletion**

- Fornibile fino ad esaurimento delle scorte
- Fourni jusqu'à épuisement du stock
- Lieferbar solange vorrat reicht
- Suministrado hasta el stock termina

**HONDA**

ACCORD V 2.0	F20B3	09/93 ⇨ 12/97
ACCORD V 2.0 i LS 16V	F20B3	09/93 ⇨ 02/98
ACCORD V 2.2 i [USA]	--	01/94 ⇨ 12/95
ACCORD V 2.2 i 16V	F22B4	08/95 ⇨ 12/97
ACCORD V 2.2 i ES	F22B5	09/93 ⇨ 02/98
PRELUDE V 2.2 i 16V VTi-R	H22A4, H22Z1	10/96 ⇨ 12/98

EPS

1.322.077

 05**DISTRIBUTOR CAPS**Adatt./Suitable: **HITACHI****MAZDA**

FS05-18-V00

03 Supplied until depletion

- Fornibile fino ad esaurimento delle scorte
- Fourni jusqu'à épuisement du stock
- Lieferbar solange vorrat reicht
- Suministrado hasta el stock termina

**FORD AUSTRALIA**

TELSTAR 2.0 Efi	FS	10/94 ⇨ 11/96
-----------------	----	---------------

MAZDA

626 V 1.8	FP, FP01LP	08/91 ⇨ 04/97
626 V 1.8 i	--, FP	08/91 ⇨ 06/97
626 V 2.0 i	FS	08/91 ⇨ 04/97
626 V 2.0 i 4WD	FS	04/92 ⇨ 04/97
MX-6 2.0	FS	02/92 ⇨ 02/97

EPS 1.322.079



07

DISTRIBUTOR CAPS

Adatt./Suitable: **HITACHI****NISSAN**
22162-73C00⁰³ Supplied until depletion

- Fornibile fino ad esaurimento delle scorte
- Fourni jusqu'à épuisement du stock
- Lieferbar solange vorrat reicht
- Suministrado hasta el stock termina

**NISSAN**

PRIMERA I 1.6 i	GA16DE	02/91 ⇒ 03/98
SUNNY III 1.4 i	GA14DE	10/90 ⇒ 05/95
SUNNY III 1.4 i 16V	GA14DE	10/90 ⇒ 06/95
SUNNY III 1.6 i	GA16DE	10/90 ⇒ 05/95
SUNNY III 1.6 i 16V	GA16DE	10/92 ⇒ 05/95

EPS 1.322.082



07,5

DISTRIBUTOR CAPS

Adatt./Suitable: **HITACHI****HONDA**
30102-P0A-A01
30102-P0A-A02
30102-P2M-A01
30102-P45-G02⁰³ Supplied until depletion

- Fornibile fino ad esaurimento delle scorte
- Fourni jusqu'à épuisement du stock
- Lieferbar solange vorrat reicht
- Suministrado hasta el stock termina

ROVER
GDC407
NJD100190**HONDA**

ACCORD V 1.9 i	F18A3	02/96 ⇒ 10/98
ACCORD V 2.0 i LS	F20Z1	02/96 ⇒ 10/98
ACCORD V 2.2	F22B1, F22Z2	10/93 ⇒ 12/97
ACCORD V 2.2 16V	F22Z1	01/96 ⇒ 09/98
ACCORD V 2.2 i [USA]	--	01/94 ⇒ 12/95
ACCORD V 2.2 i VTEC	F22Z2	02/96 ⇒ 10/98
CIVIC VI 1.4 i	D14A2, D14A5	06/95 ⇒ 02/01
CIVIC VI 1.4i 16V	D14Z3, D14Z4	11/98 ⇒ 12/00
CIVIC VI 1.4i 16V Vtec	D14Z4	01/99 ⇒
CIVIC VI 1.5 16V	D15Z8	01/97 ⇒ 02/01
CIVIC VI 1.6	D16W4	11/98 ⇒ 03/01
CIVIC VI 1.6 i	D16Y3	09/94 ⇒ 02/01
CIVIC VI 1.6 i Vtec	D16Y6	11/95 ⇒ 02/01
CIVIC VI 1.6i 16V	D16W3	11/98 ⇒ 12/00
CIVIC V 1.6 i Vtec	D16Y6	01/94 ⇒ 03/96
ODYSSEY 2.2	F22B6	01/95 ⇒ 12/97

ROVER

400 II 416 Si	D16Y2	03/95 ⇒ 03/00
600 618 i/Si	F18A3	03/96 ⇒ 02/99
600 620 i	F20Z2	08/93 ⇒ 06/96
600 620 Si	F20Z1	08/93 ⇒ 02/99

EPS 1.322.084



07,5

DISTRIBUTOR CAPS

Adatt./Suitable: **HITACHI****ACURA**
30102-PV1-A05
HONDA
30102-PV1-A03
30102-PV1-A04
30102-PV1-A05⁰⁰ Eliminated on 22-02-2022. Please verify the availability through our local distributors

- Eliminato il 22-02-2022. Verificare la disponibilità presso i nostri distributori
- Éliminé le 22-02-2022. Vérifier la disponibilité auprès de nos distributeurs sur place
- Am 22-02-2022 gestrichen. Evtl. Verfügbarkeit bitte bei unseren Händlern prüfen
- Eliminado en fecha 22-02-2022. Verificar la disponibilidad a través de nuestros distribuidores locales

**ACURA**

VIGOR 2.5 | G25A | 09/91 ⇒

EPS 1.322.088



05

DISTRIBUTOR CAPS

Adatt./Suitable: **HITACHI****BOSCH**
F 005 X04 754
MAZDA
B3C7-18-V00⁰³ Supplied until depletion

- Fornibile fino ad esaurimento delle scorte
- Fourni jusqu'à épuisement du stock
- Lieferbar solange vorrat reicht
- Suministrado hasta el stock termina

²¹¹ Resistance [kOhm] 10

- Resistenza [kOhm] 10
- Résistance [kOhm] 10
- Widerstand [kOhm] 10
- Resistencia [kOhm] 10

**MAZDA**

121 II 1.3 16V	B3(16V)	11/90 ⇒ 03/96
121 II 1.3 i 16V	B3(16V)	11/90 ⇒ 03/96

EPS 1.322.089



07

DISTRIBUTOR CAPS

Adatt./Suitable: **HITACHI****BOSCH**
F 00E 140 211
F 00E 140 438
FORD
1 961 043
NISSAN
22162-03M00
22162-0M200
22162-0M300
22162-1S700
22162-3S500**FORD**

MAVERICK 2.4 i | KA24 | 09/96 ⇒ 04/98

NISSAN

ALMERA I 1.4	GA14DE	09/95 ⇒ 07/00
ALMERA I 1.4 GX, LX	GA14DE	09/95 ⇒ 07/00
ALMERA I 1.4 S, GX, LX	GA14DE	09/95 ⇒ 03/00
ALMERA I 1.6	GA16DE	07/95 ⇒ 07/00
ALMERA I 1.6 SLX	GA16DE	09/95 ⇒ 07/00
ALMERA I 1.6 SR, SLX	GA16DE	09/95 ⇒ 03/00
PICK UP I 2.4 i 12V	KA24E	04/92 ⇒ 02/98
PICK UP I 2.4 i 12V 4WD	KA24E	04/92 ⇒ 02/98
PICK UP II 2.4 i	KA24E	02/98 ⇒ 04/05
PICK UP II 2.4 i 4WD	KA24E	02/98 ⇒ 04/05
PRIMERA I 1.6 i	GA16DE	02/91 ⇒ 03/98
SENTRA IV 1.6i	GA16DE	01/95 ⇒ 12/97
SUNNY III 1.6 i	GA16DE	06/91 ⇒ 03/00
TERRANO II 2.4 4WD	KA24E	05/96 ⇒ 09/07
TERRANO II 2.4 i 12V 4WD	KA24E	02/93 ⇒ 12/97

EPS 1.322.092



07

DISTRIBUTOR CAPS

Adatt./Suitable: **HITACHI****BOSCH**
F 005 X12 884
FORD AUSTRALIA
F S90-18-V00
MAZDA
FS90-18-V00⁰⁰ Eliminated on 09-08-2021. Please verify the availability through our local distributors

- Eliminato il 09-08-2021. Verificare la disponibilità presso i nostri distributori
- Éliminé le 09-08-2021. Vérifier la disponibilité auprès de nos distributeurs sur place
- Am 09-08-2021 gestrichen. Evtl. Verfügbarkeit bitte bei unseren Händlern prüfen
- Eliminado en fecha 09-08-2021. Verificar la disponibilidad a través de nuestros distribuidores locales

⁰³ Supplied until depletion

- Fornibile fino ad esaurimento delle scorte
- Fourni jusqu'à épuisement du stock
- Lieferbar solange vorrat reicht
- Suministrado hasta el stock termina

**FORD AUSTRALIA**

TELSTAR 2.0 EFi | FS | 10/94 ⇒ 11/96

MAZDA

626 V 1.8 | FP, FP01LP | 08/91 ⇒ 04/97

MAZDA		
626 V 1.8 i	--, FP	08/91 ⇒ 06/97
626 V 2.0 i	FS	08/91 ⇒ 04/97
626 V 2.0 i 4WD	FS	04/92 ⇒ 04/97
MX-6 2.0	FS	02/92 ⇒ 02/97

EPS 1.322.093

07

DISTRIBUTOR CAPS

Adatt./Suitable: **HITACHI****HONDA**
30102-P2A-J01⁰³ Supplied until depletion

- Fornibile fino ad esaurimento delle scorte
- Fourni jusqu'à épuisement du stock
- Lieferbar solange vorrat reicht
- Suministrado hasta el stock termina



HONDA		
BALLADE 1.5	D1524	01/97 ⇒
BALLADE 1.6i	D16Y9	01/96 ⇒ 02/01
CIVICVI 1.4	D14A4	11/95 ⇒ 10/98
CIVICVI 1.4 i	D14A3, D14A4, D14Z1	11/95 ⇒ 02/01
CIVICVI 1.4 i S	D14A4	11/95 ⇒ 02/01

EPS 1.328.070

04

DISTRIBUTOR CAPS

Adatt./Suitable: **LUCAS****FORD**
1 00E-12116-A
1 00E-12116-B⁰³ Supplied until depletion

- Fornibile fino ad esaurimento delle scorte
- Fourni jusqu'à épuisement du stock
- Lieferbar solange vorrat reicht
- Suministrado hasta el stock termina



FORD		
CORSAIR 1.5	EV15LN, EV15N	10/63 ⇒ 09/65
CORSAIR 1.5 GT	EV15LH	10/63 ⇒ 09/65
CORTINA 1200	--	10/62 ⇒ 09/66
CORTINA 1500	--	10/62 ⇒ 09/66
CORTINA 1500 GT	--	10/62 ⇒ 09/66
CORTINA GT	--	10/62 ⇒ 09/66
ZEPHYR 1.7	--, EL17L	03/62 ⇒ 03/68

LAND ROVER		
88/109 2.3 4x4	10H, 11H	09/61 ⇒ 12/86

EPS 1.328.075

04

DISTRIBUTOR CAPS

Adatt./Suitable: **LUCAS****FORD**
1 13E-12116-A**Motorcraft**
EDH 10
EDH 10D⁰³ Supplied until depletion

- Fornibile fino ad esaurimento delle scorte
- Fourni jusqu'à épuisement du stock
- Lieferbar solange vorrat reicht
- Suministrado hasta el stock termina



AUSTIN		
1000-SERIES 1100	--	01/70 ⇒ 12/74
1000-SERIES 1300	--	01/70 ⇒ 12/74
1000-SERIES 1300 GT	--	01/70 ⇒ 12/74
ALLEGRO 1.1	10H	05/73 ⇒ 10/81
ALLEGRO 1.3	12H	05/73 ⇒ 03/82
ALLEGRO 1.5 Super	14H	05/73 ⇒ 03/82
APACHE 1300	--	11/71 ⇒ 10/74
APACHE 1300 TC	--	11/71 ⇒ 10/74
MAXI 1500	--, 14H	04/69 ⇒ 07/80
MAXI 1750	17H	04/69 ⇒ 10/80
MAXI 1750 HL	--, 17LA	10/72 ⇒ 10/80
MINI 1.3	12HC	09/69 ⇒ 09/80
MINI 1000	--, 99H	10/67 ⇒ 09/84
MINI 1275 GT	12H	10/69 ⇒ 08/80
MINI I 850	781Y	06/59 ⇒ 08/69
MINI I Cooper S	--	09/62 ⇒ 12/71

BOND		
EQUIPE 1300 GT	--	01/67 ⇒ 12/70

FORD		
CORTINA 1200	--	10/62 ⇒ 09/66
CORTINA 1500	--	10/62 ⇒ 09/66
CORTINA 1500 GT	--	10/62 ⇒ 09/66
CORTINA GT	--	10/62 ⇒ 09/66
ESCORT I RS 1600	--, BDA	01/70 ⇒ 10/74
ESCORT II 1.6 RS	LC	12/74 ⇒ 08/80
ESCORT II 1.8	--	12/74 ⇒ 08/80
ESCORT II RS 1800	KL18S	03/75 ⇒ 08/77

JENSEN		
GT 2.0	--	06/75 ⇒ 12/76
HEALEY 2.0	--	01/72 ⇒ 12/75

LAND ROVER		
88/109 2.3 4x4	10H, 11H	09/61 ⇒ 12/86

LOTUS		
ECLAT 2.0	907	10/75 ⇒ 05/80
ELITE 2.0	907	05/74 ⇒ 05/80
ESPRIT 2.0	907	10/75 ⇒ 05/80

MG		
1300 MK.II 1300	--	09/67 ⇒ 09/70
MAGNETTE 1.6	--	03/61 ⇒ 09/68
MGB 1.8	--	05/62 ⇒ 12/80
MGB GT 1.8	--, 18G	07/65 ⇒ 11/80

MORRIS		
MARINA 1.8	--	04/71 ⇒ 12/79
MARINA 1.8 TC	--	04/71 ⇒ 09/75
MARINA 1300	--	04/71 ⇒ 06/80
MARINA 1800	--	04/71 ⇒ 12/75
MARINA 1800 TC	--	04/71 ⇒ 12/75
MINOR 1.1	--	01/62 ⇒ 10/71
OXFORD 1.7	--	05/62 ⇒ 04/70

RELIANT		
REBEL 700	--	01/68 ⇒ 08/71
REBEL 750	--	08/71 ⇒ 12/73
ROBIN 850	--	11/73 ⇒ 10/02

RILEY		
4/72 1.7	--	03/61 ⇒ 10/68
ELF 1.0	--	03/63 ⇒ 10/68
KESTREL 1300	12H	03/67 ⇒ 12/69

ROVER		
2000-3500 2200	--	10/73 ⇒ 05/76
AG0 CAMBRIDGE 1.7	--	01/62 ⇒ 10/69

TALBOT		
AVENGER 1.3	--	02/70 ⇒ 07/81
AVENGER 1.6	--	02/70 ⇒ 07/81

TRIUMPH		
1300 1.3	--	01/65 ⇒ 12/70
1300 1.3 TC	--, GE1EH	01/67 ⇒ 12/70
1500 1.5	--, 1EH, 1EL	10/70 ⇒ 12/74
HERALD 1200	--, AJM	01/61 ⇒ 12/69
HERALD 13/60	--	01/67 ⇒ 12/71
TOLEDO 1300	--	10/70 ⇒ 12/77
TOLEDO 1500	--	10/70 ⇒ 12/77
TOLEDO 1500 TC	--	01/71 ⇒ 12/77

WOLSELEY		
16/60 1.6	--	01/61 ⇒ 12/71
18/85 1.8	--, 18HL	08/69 ⇒ 12/72
18/85 1.8 S	--, 18HH	01/70 ⇒ 12/72
1300 1.3	--, 12H	01/68 ⇒ 10/71
1300 1.3 TC	--, 12H	10/71 ⇒ 10/73

EPS 1.328.078

04

DISTRIBUTOR CAPS

Adatt./Suitable: **LUCAS****FIAT**
59321119
659321119**INNOCENTI**
659321119
LAND ROVER
RTC3278**ROVER**
GDC136⁰³ Supplied until depletion

- Fornibile fino ad esaurimento delle scorte
- Fourni jusqu'à épuisement du stock
- Lieferbar solange vorrat reicht
- Suministrado hasta el stock termina



INNOCENTI		
MINI 120	--	01/75 ⇒ 12/83

LAND ROVER		
90 2.5 4x4	17H	09/85 ⇒ 08/90
110/127 2.5 4x4	17H	10/85 ⇒ 07/90
DEFENDER 2.25	--	01/87 ⇒
DEFENDER 2.5 90, 110	--	08/90 ⇒ 09/01

ROVER		
MINI 1.0	--	01/85 ⇒

EPS 1.328.083

07

DISTRIBUTOR CAPS

Adatt./Suitable: **LUCAS****FORD**
6 077 487
815F-12106-DA**Motorcraft**
EDH 128⁰³ Supplied until depletion

- Fornibile fino ad esaurimento delle scorte
- Fourni jusqu'à épuisement du stock
- Lieferbar solange vorrat reicht
- Suministrado hasta el stock termina



FORD		
ESCORT III 1.3	JPA	09/80 ⇒ 02/86
ESCORT III 1.6	LP1, LPA	09/80 ⇒ 12/85
ORION 1.3	JPA	07/83 ⇒ 03/86
ORION 1.6	LP1, LPA	07/83 ⇒ 03/86

1.328.085

EPS 1.328.085



04

DISTRIBUTOR CAPS

Adatt./Suitable: LUCAS

JAGUAR

AEU 1502
JLM 9528⁰³ Supplied until depletion

- Fornibile fino ad esaurimento delle scorte
- Fourni jusqu'à épuisement du stock
- Lieferbar solange vorrat reicht
- Suministrado hasta el stock termina



JAGUAR

XJ 4.2i Series 3

--

01/86 ⇒ 12/94

EPS 1.328.091



07

DISTRIBUTOR CAPS

Adatt./Suitable: LUCAS

BOSCH

F 005 X04 656
F 005 X04 666

LAND ROVER

605190
RTC3197
STC8368

ROVER

STC8368



LAND ROVER

DEFENDER 3.5 4x4	15G, 21G, 22D	09/90 ⇒ 12/98
DISCOVERY I 3.5	--	09/89 ⇒ 06/94
DISCOVERY I 3.5 4x4	22D	06/89 ⇒ 06/94
DISCOVERY I 4.0 4x4	35D, 36D	09/93 ⇒ 10/98
RANGE ROVER I 3.5 4x4	31D	01/87 ⇒ 09/90
RANGE ROVER I 3.5 Vogue 4x4	11D, 24D, 25D	08/81 ⇒ 09/90
RANGE ROVER I 3.9 4x4	35D	11/88 ⇒ 12/92
RANGE ROVER I 3.9 Cat 4x4	37D, 38D	11/88 ⇒ 07/94
RANGE ROVER I 3.9 Vogue SEI 4x4	35D, 36D	11/88 ⇒ 07/94
RANGE ROVER I 4.3 Vogue LSE 4x4	40D	09/92 ⇒ 07/94

EPS 1.328.093



07

DISTRIBUTOR CAPS

Adatt./Suitable: LUCAS

BOSCH

F 005 X13 537

LAND ROVER

NJD10010

ROVER

AUU1186
GDC152
GDC160
GDC377
GDC384
NJD10010

AUSTIN

MONTEGO 1.6 LS	16HC37	10/84 ⇒ 08/88
MONTEGO 1.6 LS, HL	16HC37	04/84 ⇒ 08/88
MONTEGO 2.0	20HSC	04/84 ⇒ 08/88
MONTEGO 2.0 Turbo	20HC85	04/84 ⇒ 08/88

LAND ROVER

FREELANDER 1.8 16V 4x4	18K4F	04/98 ⇒ 10/06
FREELANDER 1.8i 16V 4x4	18K4F	02/98 ⇒ 10/06

MG

MGF 1.8 i 16V	18K4F	03/95 ⇒ 03/02
MG TF 115	16K4F	03/02 ⇒ 12/09
MG TF 120	18K4F	03/02 ⇒ 12/09
MG TF 135	18K4F	03/02 ⇒ 12/09
MG ZR 105	14K4F	06/01 ⇒ 04/05
MG ZR 120	18K4F	06/01 ⇒ 04/05

ROVER

25 1.4 16V	14K4F, 14K4M	10/99 ⇒ 05/05
25 1.6 16V	16K4F	10/99 ⇒ 05/05
25 1.8 16V	18K4F	10/99 ⇒ 05/05
100 / METRO 111 C/L/S	11K2D	03/90 ⇒ 12/98
100 / METRO 114 GSi	14K4F	10/94 ⇒ 10/95
100 / METRO 114 GTi 16V	14K4C, 14K4D, 14K4F	03/90 ⇒ 12/98
100 / METRO 114 GTi/GT 16V Cat	14K4C, 14K4D	03/90 ⇒ 12/98
100 / METRO 114 S/L/GTA	14K2D	03/90 ⇒ 12/98
100 111	11K2D	04/94 ⇒ 10/97
100 114	14K2D	04/94 ⇒ 10/97
200 II 214	14K2A, 14K2D	09/93 ⇒ 12/95
200 II 214 1.4	14K4C, 14K4D	01/92 ⇒ 11/99
200 II 214 1.4i 16V	14K4F	01/93 ⇒ 11/99
200 II 214 GSi/Si	14K4C, 14K4F	01/90 ⇒ 10/95
200 II 214 Si/Gsi	14K4C, 14K4D	10/89 ⇒ 10/95
200 II 216	16K4F	01/96 ⇒ 12/97
200 II 216 1.6i 16V	16K4F	01/96 ⇒ 11/99
200 II 220 16V	--	01/92 ⇒ 12/95
200 II 220 GSi	1CA4GA15-01	05/94 ⇒ 06/99
200 II 220 GTi	1CA4GA15-01, 20M4F	09/91 ⇒ 10/95
200 II 220 Turbo	20T4G	10/92 ⇒ 06/99
200 III 211	11K2D	01/98 ⇒ 03/00
200 III 214 i	14K2F	11/95 ⇒ 03/00
200 III 214 Si	14K4F	11/95 ⇒ 03/00
200 III 216 Si	16K4F	11/95 ⇒ 06/99
400 II 414 Si	14K4F	05/95 ⇒ 03/00
400 II 416 Si	16K4F, D16Y2	03/95 ⇒ 03/00
600 620 Ti Vitesse	20T4G	05/94 ⇒ 08/98
800 820	--	10/88 ⇒ 10/91
800 820 16V Turbo	T16	11/91 ⇒ 02/99
800 820 I/SI	1CA4GA15-01, 20HD	10/88 ⇒ 02/99
800 820 SI	20HDM16	10/88 ⇒ 12/91
800 820 Sport	20T4G	04/94 ⇒ 03/96
400 I 1.6 i	16K4F, D16A8	05/94 ⇒ 11/98
400 I 414	14K4C	01/93 ⇒ 04/95
400 I 414 GSi/SI	14K4C, 14K4D	04/90 ⇒ 04/95
400 I 414 GSi/SI Cat	14K4F	10/92 ⇒ 04/95
400 I 420 16V	--	01/91 ⇒ 12/92
400 I 420 GSi/SLI/GTi/Vite	1CA4GA15-01	01/93 ⇒ 04/95
400 I 420 GTi/GSi/Vitesse	20M4F	02/92 ⇒ 04/95
400 I 420 Turbo	20T4G	01/93 ⇒ 04/95
MAESTRO 1.6	16H	09/90 ⇒ 01/95
MAESTRO 2.0	--	01/86 ⇒
MONTEGO 2.0 GTi	20H	02/85 ⇒ 10/91

EPS 1.328.094



04

DISTRIBUTOR CAPS

Adatt./Suitable: LUCAS

Motorcraft

EDH 216

ROVER

GDC156

⁰⁰ Eliminated on 04-08-2020. Please verify the availability through our local distributors

- Eliminato il 04-08-2020. Verificare la disponibilità presso i nostri distributori
- Éliminé le 04-08-2020. Vérifier la disponibilité auprès de nos distributeurs sur place
- Am 04-08-2020 gestrichen. Evtl. Verfügbarkeit bitte bei unseren Händlern prüfen
- Eliminado en fecha 04-08-2020. Verificar la disponibilidad a través de nuestros distribuidores locales



AUSTIN

MONTEGO 1.3	--, 12HL	10/84 ⇒ 08/88
-------------	----------	---------------

ROVER

100 / METRO 111 C/L/S	11K2A	03/90 ⇒ 12/98
100 / METRO 114 S/L/GTA	14K2A	03/90 ⇒ 12/98
100 114	14K2A	04/94 ⇒ 10/97
2000-3500 2000	--	10/82 ⇒ 10/86
MAESTRO 1.3	12HE	09/90 ⇒ 01/95
MINI 1.3 Cooper	--	01/85 ⇒
MINI 1.3i Cooper	--	01/85 ⇒
MINI 1.3i Turbo	--	01/85 ⇒
MINI 1300	12A2A, 12A2B, 12A2D, 12A2E, 12A2L	01/91 ⇒ 04/95
MONTEGO 1.3	12HL	10/84 ⇒ 10/88

EPS 1.328.096



04

DISTRIBUTOR CAPS

Adatt./Suitable: LUCAS

FORD

6 153 386
845F-12106-AA

Motorcraft

EDH 199

⁰⁰ Eliminated on 01-09-2020. Please verify the availability through our local distributors

- Eliminato il 01-09-2020. Verificare la disponibilità presso i nostri distributori
- Éliminé le 01-09-2020. Vérifier la disponibilité auprès de nos distributeurs sur place
- Am 01-09-2020 gestrichen. Evtl. Verfügbarkeit bitte bei unseren Händlern prüfen
- Eliminado en fecha 01-09-2020. Verificar la disponibilidad a través de nuestros distribuidores locales



FORD

ESCORT IV 1.4	F6D, FUA, FUC	01/86 ⇒ 07/90
FIESTA II 1.6 XR2	LUB, LUD	03/84 ⇒ 02/89
FIESTA III 1.4	F6E	03/89 ⇒ 12/95
ESCORT III 1.4 i	F6D, FUC	02/86 ⇒ 07/90
ORION I 1.4	FUA, FUC	12/85 ⇒ 07/90
ORION I 1.4 Cat	F6D	02/87 ⇒ 07/90

EPS 1.328.098



07

DISTRIBUTOR CAPS

Adatt./Suitable: LUCAS

JAGUAR
JLM 150

JAGUAR

XJ 3.6	9DPALA, 9DPANA	10/86 ⇨ 05/91
XJ 4.0	9EPCNA, 9LPFRB	10/89 ⇨ 03/96
XJ 6 3.2 24V	9BPMNA	09/90 ⇨ 11/94
XJ 6 3.6	9DPANA, AJ6(3.6, 156KW)	10/86 ⇨ 08/89
XJ 6 4.0	9EPCNA	09/89 ⇨ 11/94
XJSC 3.6	9DPALA, 9DPANA	08/87 ⇨ 05/91
XJSC 4.0	9EPCNA, 9LPFRB	05/91 ⇨ 03/96

EPS 1.328.099



07

DISTRIBUTOR CAPS

Adatt./Suitable: LUCAS

GENERAL MOTORS
90 349 878OPEL
12 11 266

00 Eliminated on 14-04-2020. Please verify the availability through our local distributors

- Eliminato il 14-04-2020. Verificare la disponibilità presso i nostri distributori
- Éliminé le 14-04-2020. Vérifier la disponibilité auprès de nos distributeurs sur place
- Am 14-04-2020 gestrichen. Evtl. Verfügbarkeit bitte bei unseren Händlern prüfen
- Eliminado en fecha 14-04-2020. Verificar la disponibilidad a través de nuestros distribuidores locales



OPEL

KADETT E 1.6	16SV	09/86 ⇨ 12/91
KADETT E 1.6 i	16SV	07/89 ⇨ 02/93
KADETT E 1.6 S	16SV	09/86 ⇨ 08/91
VECTRA A 1.6	16SV	09/88 ⇨ 05/93
VECTRA A 1.6 S	16SV	09/88 ⇨ 05/93

EPS 1.328.100



07

DISTRIBUTOR CAPS

Adatt./Suitable: LUCAS

BOSCH

1 987 233 200
F 005 X13 536GENERAL MOTORS
90 350 997HOLDEN
90350997OPEL
12 11 271
90350997

03 Supplied until depletion

- Fornibile fino ad esaurimento delle scorte
- Fourni jusqu'à épuisement du stock
- Lieferbar solange vorrat reicht
- Suministrado hasta el stock termina



HOLDEN

BARINA 1.4 i	C14NZ	04/94 ⇨ 07/97
BARINA_SB 1.2i	C12NZ	04/94 ⇨ 07/97
COMBO 1.4 i	C14NZ	03/96 ⇨ 07/97
COMBO_SB 1.4i	C14NZ	04/94 ⇨ 07/97

OPEL

ASTRA F 1.4	14SE	09/92 ⇨ 09/98
ASTRA F 1.4 Si	C14SE	03/92 ⇨ 03/01
COMBO B 1.2	C12NZ	07/94 ⇨ 10/01
COMBO B 1.4	C14NZ	07/94 ⇨ 10/01
CORSA A 1.2 i	C12NZ	09/89 ⇨ 03/93
CORSA A 1.4 Si	C14SE	09/91 ⇨ 03/93
CORSA A 1.6 GSi	E16SE	05/88 ⇨ 03/92
CORSA B 1.2 i	12NZ, C12NZ	03/93 ⇨ 09/00
CORSA B 1.4 i	C14NZ	03/93 ⇨ 09/00
KADETT E 1.4 i	C14NZ	01/90 ⇨ 07/94
KADETT E 1.6	16SV	09/86 ⇨ 12/91
KADETT E 1.6 i	16SV	07/89 ⇨ 02/93
KADETT E 1.6 S	16SV	09/86 ⇨ 08/91
VECTRA A 1.6	16SV	09/88 ⇨ 05/93
VECTRA A 1.6 S	16SV	09/88 ⇨ 05/93

VAUXHALL

ASTRA III 1.4 i	C14SE	03/91 ⇨ 03/01
COMBO B 1.2	C12NZ	07/94 ⇨ 10/01
COMBO B 1.4	C14NZ	07/94 ⇨ 10/01
CORSA B 1.2 i	C12NZ	03/93 ⇨ 09/00
CORSA B 1.4 i	C14NZ	03/93 ⇨ 09/00
CORSAVAN I 1.4 i	C14NZ	01/94 ⇨ 09/00

EPS 1.328.101



05

DISTRIBUTOR CAPS

Adatt./Suitable: LUCAS

BOSCH

1 987 233 113

NISSAN
22162-71J10
22162-94M01

03 Supplied until depletion

- Fornibile fino ad esaurimento delle scorte
- Fourni jusqu'à épuisement du stock
- Lieferbar solange vorrat reicht
- Suministrado hasta el stock termina



NISSAN

100NX 1.6	GA16DS	03/90 ⇨ 10/94
PRIMERA I 1.6	GA16DS	06/90 ⇨ 01/96
PRIMERA I 1.6 i	GA16DS	07/90 ⇨ 03/98
SUNNY II 1.4 LX	GA14S	10/88 ⇨ 08/91
SUNNY III 1.4	GA14DS	10/90 ⇨ 06/95
SUNNY III 1.4 i	GA14DS	10/90 ⇨ 05/95
SUNNY III 1.6 16V 4x4	GA16DS	11/90 ⇨ 05/95

NISSAN

SUNNY III 1.6 i GA16DE, GA16DS 10/90 ⇨ 03/00

EPS 1.328.102



05

DISTRIBUTOR CAPS

Adatt./Suitable: LUCAS

BOSCH

1 987 233 111

NISSAN
22162-70J00

03 Supplied until depletion

- Fornibile fino ad esaurimento delle scorte
- Fourni jusqu'à épuisement du stock
- Lieferbar solange vorrat reicht
- Suministrado hasta el stock termina



NISSAN

PRIMERA I 2.0	SR20DE	06/90 ⇨ 04/93
PRIMERA I 2.0 16V	SR20DI	06/90 ⇨ 01/96
PRIMERA I 2.0 16V 4x4	SR20DI	04/91 ⇨ 06/96
PRIMERA I 2.0 GT	SR20DE	06/90 ⇨ 01/96
PRIMERA I 2.0 GT 4x4	SR20DE	03/91 ⇨ 04/93
PRIMERA I 2.0 i	SR20DE	01/95 ⇨ 06/96
PRIMERA II 2.0 16V	SR20DE	08/99 ⇨ 12/01

EPS 1.328.103



05

DISTRIBUTOR CAPS

Adatt./Suitable: LUCAS

NISSAN

22162-71J00

03 Supplied until depletion

- Fornibile fino ad esaurimento delle scorte
- Fourni jusqu'à épuisement du stock
- Lieferbar solange vorrat reicht
- Suministrado hasta el stock termina



NISSAN

PRIMERA I 1.6 GA16DS 06/90 ⇨ 01/96

EPS 1.328.104



05

DISTRIBUTOR CAPS

Adatt./Suitable: LUCAS

BOSCH

1 987 233 110

NISSAN
22162-99B00

NISSAN

MICRA II 1.0 i 16V	CG10DE	08/92 ⇨ 07/00
MICRA II 1.3 i 16V	CG13DE	08/92 ⇨ 09/00

EPS 1.328.105



05

DISTRIBUTOR CAPS

Adatt./Suitable: **LUCAS****BOSCH**

1 987 233 110

NISSAN22162-41B00
22162-82J00**NISSAN**

MICRA II 1.3 i 16V	CG13DE	08/92 ⇨ 09/00
PRIMERA II 1.6 16V	GA16DE	09/96 ⇨ 07/02
PRIMERA I 1.6	GA16DE	06/93 ⇨ 01/96

EPS 1.328.106



07

DISTRIBUTOR CAPS

Adatt./Suitable: **LUCAS****HONDA**

30102-P1J-E01

ROVER

NJD100200

⁰³ Supplied until depletion

- Fornibile fino ad esaurimento delle scorte
- Fourni jusqu'à épuisement du stock
- Lieferbar solange vorrat reicht
- Suministrado hasta el stock termina

²¹¹ Resistance [kOhm] 5

- Resistenza [kOhm] 5
- Résistance [kOhm] 5
- Widerstand [kOhm] 5
- Resistencia [kOhm] 5

**HONDA**

CIVICVI 1.4 16V	D14A7, D14A8	01/97 ⇨ 02/01
CIVICVI 1.4 i	D14A8	06/95 ⇨ 02/01
CIVICVI 1.4i	D14A6	01/99 ⇨
CIVICVI 1.6 16V	D16B2	01/97 ⇨ 02/01

ROVER

400 II 416 Si	D16Y2	03/95 ⇨ 03/00
---------------	-------	---------------

EPS 1.330.059



04

DISTRIBUTOR CAPS

Adatt./Suitable: **MARELLI****FIAT**

9908338

GENERAL MOTORS

7 992 274

MAGNETI MARELLI070005501010
700 055 01**FIAT**

500 0.5	110F.000, 120.000	01/60 ⇨ 12/75
---------	-------------------	---------------

EPS 1.330.069



07

DISTRIBUTOR CAPS

Adatt./Suitable: **MARELLI****FIAT**

9913860

FORDA760-X12276-CA
A760-X12276-EA
A800-X12276-RA**SEAT**102312.06
NG1 023 020 6⁰³ Supplied until depletion

- Fornibile fino ad esaurimento delle scorte
- Fourni jusqu'à épuisement du stock
- Lieferbar solange vorrat reicht
- Suministrado hasta el stock termina

**FIAT**

124 1200	124A.000	07/66 ⇨ 10/73
124 1400 Special	124B2.000	12/68 ⇨ 12/72
124 1600 Special T	132AC.000	01/73 ⇨ 07/75
850 0.8	100G.000	07/64 ⇨ 10/72

EPS 1.330.076



07

DISTRIBUTOR CAPS

Adatt./Suitable: **MARELLI****FIAT**

9915391

GENERAL MOTORS

93 150 385

MAGNETI MARELLI

710 851 01

⁰⁰ Eliminated on 21-07-2020. Please verify the availability through our local distributors

- Eliminato il 21-07-2020. Verificare la disponibilità presso i nostri distributori
- Éliminé le 21-07-2020. Vérifier la disponibilité auprès de nos distributeurs sur place
- Am 21-07-2020 gestrichen. Evtl. Verfügbarkeit bitte bei unseren Händlern prüfen
- Eliminado en fecha 21-07-2020. Verificar la disponibilidad a través de nuestros distribuidores locales

**SEAT**

IBIZA I 0.9	09NCA	08/90 ⇨ 05/93
MARBELLA 0.9	08NCB, 100GL7000	01/87 ⇨ 10/98
MARBELLA 0.9 Cat	08NCB, 09NCB, 100GL7000	01/87 ⇨ 10/98

EPS 1.330.081



04

DISTRIBUTOR CAPS

Adatt./Suitable: **MARELLI****FIAT**98080037
9919628
9920581**GENERAL MOTORS**

7 992 280

MAGNETI MARELLI710 613 03
711 275 01**ZASTAVA**

1335050

⁰³ Supplied until depletion

- Fornibile fino ad esaurimento delle scorte
- Fourni jusqu'à épuisement du stock
- Lieferbar solange vorrat reicht
- Suministrado hasta el stock termina

**FIAT**

128 1.1	128A.000	03/69 ⇨ 12/84
---------	----------	---------------

ZASTAVA

101 1.1	128A.000, 128A.064	05/75 ⇨ 12/93
101 1.1 Super	128AC5.000	07/79 ⇨ 09/81

EPS 1.330.082



07

DISTRIBUTOR CAPS

Adatt./Suitable: **MARELLI**

FIAT

9911509
9921509

MAGNETI MARELLI

711 290 01

⁰³ Supplied until depletion

- Fornibile fino ad esaurimento delle scorte
- Fourni jusqu'à épuisement du stock
- Lieferbar solange vorrat reicht
- Suministrado hasta el stock termina



FIAT

124 Spider, Sport [USA]	--	01/79 ⇒ 12/86
131 2.0 Brava [USA]	--	01/79 ⇒ 12/84
ARGENTA 2000	132D1.000	06/78 ⇒ 12/85

EPS 1.330.086



04

DISTRIBUTOR CAPS

Adatt./Suitable: **MARELLI**

FIAT

9924316
9925993

GENERAL MOTORS

7 992 978

MAGNETI MARELLI

071171101010
711 711 01

FIAT

126 600	126A.000	09/72 ⇒ 06/77
500 0.6	111A000	08/68 ⇒ 01/76

FSO

126P 0.6	--	09/72 ⇒ 07/77
----------	----	---------------

EPS 1.330.090



05

DISTRIBUTOR CAPS

Adatt./Suitable: **MARELLI**

CITROËN

54 862 24

FIAT

9928250

GENERAL MOTORS

93 150 091

MAGNETI MARELLI

711 743 01

⁰³ Supplied until depletion

- Fornibile fino ad esaurimento delle scorte
- Fourni jusqu'à épuisement du stock
- Lieferbar solange vorrat reicht
- Suministrado hasta el stock termina



FIAT

127 1.0	127A.000	01/77 ⇒ 12/86
132 1.6	132C.000	05/77 ⇒ 09/82
ARGENTA 1600	132D.000	04/81 ⇒ 12/85
ARGENTA 1600 i.e	132D.000	04/81 ⇒ 12/85
FIORINO I 1.0	127A.000	01/80 ⇒ 12/87
FIORINO I 1050	127A.000	01/80 ⇒ 12/87
FIORINO I 900	100GL.000	10/77 ⇒ 10/86

EPS 1.330.093



07

DISTRIBUTOR CAPS

Adatt./Suitable: **MARELLI**

FIAT

82368100
9934728

GENERAL MOTORS

93 150 907

LANCIA

9934728

MAGNETI MARELLI

712 155 01

SEAT

NG2 155 013 1

⁰³ Supplied until depletion

- Fornibile fino ad esaurimento delle scorte
- Fourni jusqu'à épuisement du stock
- Lieferbar solange vorrat reicht
- Suministrado hasta el stock termina



FIAT

132 2.0	132C2.000	01/76 ⇒ 06/81
ARGENTA 2000	132D1.000	06/78 ⇒ 12/85
ARGENTA 2000 i.e.	132C3.000	06/81 ⇒ 07/86

LANCIA

A 112 1.0 Abarth	A112A2.000	03/78 ⇒ 02/84
------------------	------------	---------------

EPS 1.330.098



04

DISTRIBUTOR CAPS

Adatt./Suitable: **MARELLI**

ALFA ROMEO

9950051

FIAT

9936027

9938272

9938359

9944630

FORD

1 641 610

LANCIA

9936027

MAGNETI MARELLI

071243702010

071366801010

712 437 01

712 437 02

712 437 04

712 437 05

713 668 01

713 668 02

71376201

Motorcraft

EDH 170

EDH 196

EDH 201

EDH 208

EDH 226

PEUGEOT

5941 43

RENAULT

77 01 025 240

SEAT

000 389 976 9

SE 141914.001B



FIAT

CROMA I 1600	154A.048	12/85 ⇒ 12/90
CROMA I 2000 CHT	154A1.000, 154C5.000	12/85 ⇒ 09/92
CROMA I 2000 i.e.	834B.048	03/86 ⇒ 09/90
CROMA I 2000 i.e. Turbo	154A2.000	12/85 ⇒ 06/90
PANDA I 750	141B.000	01/86 ⇒ 01/95
PANDA I 900	100GL3.000	10/80 ⇒ 06/94
PANDA I 900 CL	146A.048	01/86 ⇒ 12/92
REGATA 1.6	--	09/86 ⇒ 06/89
REGATA 90 i.e. 1.6	149C2.000	01/87 ⇒ 07/89
TIPO I 1.4 i.e.	159A2.000	05/89 ⇒ 04/95
UNO 1.3 Turbo i.e.	146A2.000	04/85 ⇒ 08/89
UNO 45 0.9	146A.000, 146A1.000	03/83 ⇒ 07/96
UNO 45 0.9 Trend	146A.048	09/89 ⇒ 09/92

FORD

ESCORT V RS Cosworth 4x4	N5F	10/91 ⇒ 01/95
--------------------------	-----	---------------

LANCIA

PRISMA 1.6	831B6.000	08/86 ⇒ 02/92
PRISMA 1.6 i.e.	831B7.000	05/86 ⇒ 12/89
PRISMA 2.0 i.e. Trazione integrale	831B4.000	04/86 ⇒ 12/89

PEUGEOT

505 2.0	106E(XN1A)	09/85 ⇒ 09/95
---------	------------	---------------

RENAULT

14 1.4	150	09/79 ⇒ 06/83
--------	-----	---------------

SEAT

IBIZA I 0.9	146A000	08/86 ⇒ 05/93
MARBELLA 0.9	09NCA	01/87 ⇒ 12/93
TERRA 0.9	09NCA	02/87 ⇒ 12/96

EPS 1.330.101



04

DISTRIBUTOR CAPS

Adatt./Suitable: **MARELLI**

FIAT

82361914
9938273
9939787
9940656
9944794

FORD

6 542 391
V90H-F12106-AA

INNOCENTI

9944794

LANCIA

9939787

MAGNETI MARELLI

071246105010
071366701010
071366702010
712 461 04
712 461 05
712 461 06
712 462 03
713 667 01
713 667 02

PEUGEOT

5941 30

RENAULT

77 01 030 505

SEAT

000 398 090 7
SE 021914.001B

FIAT

DUNA 60 1.1	146A6.000	01/87 ⇒ 12/91
DUNA 70 1.3	146A5.000	01/87 ⇒ 12/91
ELBA 1.3	146A5.000	04/91 ⇒ 02/95
FIORINO I 1.1 60	146A9.000	11/86 ⇒ 04/88
FIORINO I 1.3	146A5.000	12/87 ⇒ 08/93
FIORINO II 1.5 iE	146A5.000	01/88 ⇒ 12/94
FIORINO II 60 1.1	146A9.000	05/88 ⇒ 12/93
FIORINO II 70 1.3	146A5.000	01/88 ⇒ 12/94
REGATA 1.1 60, 60 L	138B.000	10/83 ⇒ 08/86
REGATA 1.6	149A.000	10/84 ⇒ 06/89
REGATA 70 1.3	138B2.000, 149A3.000	09/83 ⇒ 07/89
REGATA 85 1.5	149A5.000	05/85 ⇒ 12/87
REGATA 85 1.6	149A.000	10/83 ⇒ 06/90
RITMO I 1.1	146A4.048	04/85 ⇒ 12/87
RITMO I 1.3	149A3.000	11/83 ⇒ 08/85
TEMPRA 1.4 i.e.	159A2.000	04/90 ⇒ 08/96
TIPO I 1.4	160A1.000	07/87 ⇒ 12/89
TIPO I 1.4 i.e.	159A2.000	05/89 ⇒ 04/95
UNO 1.4 Turbo i.e.	146A8.000, 146A8.046	09/89 ⇒ 12/96
UNO 60 1.1	146A4.048, 146A6.000	05/85 ⇒ 02/92
UNO 60 1.1 SX	--	01/83 ⇒ 12/89
UNO CS 1.1	146A6.000	09/87 ⇒ 09/91

FIAT (BR)

UNO 1.4i Turbo	1.4Mpi	01/94 ⇒ 12/96
UNO CS 11116	--	01/88 ⇒

FORD

ESCORT V RS Cosworth 4x4	NSF	10/91 ⇒ 01/95
--------------------------	-----	---------------

INNOCENTI

ELBA 1.3	146A5.000	08/91 ⇒ 12/96
----------	-----------	---------------

LANCIA

DELTA I 1.1	831B8.000	01/86 ⇒ 12/90
DELTA I 1.3	1831B.000, 3831B.000, 831A2.000, 831B.000	09/79 ⇒ 10/92
PRISMA 1.3	831A2.000	01/83 ⇒ 12/89
Y10 1.3 i.e.	146A5.046, 156B.000	11/87 ⇒ 12/95

PEUGEOT

305 1.5	117(XR55)	05/80 ⇒ 09/82
---------	-----------	---------------

RENAULT

4 1.1	688712	02/78 ⇒ 06/90
9 1.1	C1E715	09/81 ⇒ 05/87
11 1.1	C1E715, C1E720	03/83 ⇒ 06/86
RAPID 1.1	C1E750, C1E760	07/85 ⇒ 04/95
SUPER 5 1.0	C1C700	10/84 ⇒ 10/88

SEAT

IBIZA I 1.2	021A1000	11/84 ⇒ 12/93
MALAGA 1.2	021A1000	05/85 ⇒ 12/93
MALAGA 1.5	021A2000	05/85 ⇒ 12/93

EPS 1.330.104



04

DISTRIBUTOR CAPS

Adatt./Suitable: **MARELLI**

FIAT

9938274
9938360

INNOCENTI

9938360

LANCIA

9938360

MAGNETI MARELLI

712 461 07



FIAT

CROMA I 1600	154A.048	12/85 ⇒ 12/90
ELBA 1.5	149C1.000	01/92 ⇒ 12/96
FIORINO I 1.5	149C1.000	01/88 ⇒ 08/93
FIORINO II 1.5 iE	149C1.000	01/88 ⇒ 10/92
FIORINO II 75 i.e. 1.5	149C1.000	05/88 ⇒ 12/93
REGATA 1.6	--	09/86 ⇒ 06/89
REGATA 100 Super 1.6	149A2.000	10/83 ⇒ 12/90
REGATA 85 1.5	149A5.000	05/85 ⇒ 12/87
RITMO I 1.5	138C2.048	10/85 ⇒ 05/87
RITMO I 1.6	149A4.000	01/83 ⇒ 12/87
RITMO II 75 1.5	138A2.000	09/85 ⇒ 12/88
TEMPRA 1.4 i.e.	160A1.046	04/90 ⇒ 08/96
TEMPRA 1.6	159A3.000, 159A3.048, 159A3.098	03/90 ⇒ 12/96
TEMPRA 1.6 i.e.	159A3.046, 159A3.048	06/90 ⇒ 08/96
TEMPRA 1.8 4x4	159A4.000	07/92 ⇒ 06/93
TEMPRA 1.8 i.e.	159A4.000, 159A4.046	03/90 ⇒ 08/96
TEMPRA 2.0	159A6.046	04/90 ⇒ 06/93
TEMPRA 2.0 i.e.	159A6.046	10/90 ⇒ 09/96
TEMPRA 2.0 i.e. 4x4	159A6.046	03/92 ⇒ 03/95
TIPO I 1.4	160A1.048	07/87 ⇒ 12/89
TIPO I 1.4 i.e.	160A1.046	05/89 ⇒ 04/95
TIPO I 1.6	159A3.048, 160A2.000, 835C1.000	01/88 ⇒ 10/95
TIPO I 1.6 i.e.	159A3.046, 159A3.048, 835C1.000	07/90 ⇒ 04/95
TIPO I 1.6 i.e. [BRA]	160E2.011	03/93 ⇒ 04/95
TIPO I 1.6 SX DGT	159A3.000	05/89 ⇒ 10/95
TIPO I 1.8 i.e.	159A4.000, 159A4.046	10/90 ⇒ 06/93
TIPO I 1.8 i.e. 16V Sport	160A5.000	11/89 ⇒ 06/92
TIPO I 2.0	159A5.046, 159A6.046	10/90 ⇒ 10/92
TIPO I 2.0 16V	160A8.046	07/91 ⇒ 04/95
TIPO I 2.0 i.e.	159A5.046, 159A6.046	03/90 ⇒ 04/95
TIPO I 2.0 i.e. [BRA]	159A6.011	03/93 ⇒ 10/95
UNO 1.4 Super	146C2.028	09/89 ⇒ 09/92
UNO 70 1.3i SX	--	01/83 ⇒ 12/89
UNO 70 i.e. 1.4	146C1.000, 160A1.046	09/89 ⇒ 07/96
UNO 70 S 1.4	160A1.048	10/88 ⇒ 06/06
UNO 75 i.e. 1.5	138C2.048, 149C1.000	10/85 ⇒ 12/93

INNOCENTI

ELBA 1.5 i.e.	149C1.000	08/92 ⇒ 09/94
---------------	-----------	---------------

LANCIA

DEDRA 1.6 i.e.	835A1.000, 835A1.046	08/89 ⇒ 06/94
DELTA I 1.3	831A2.000, 831B.000	09/79 ⇒ 08/92
DELTA I 1.5	831A1.000, 831B1.000	09/79 ⇒ 12/92
PRISMA 1.5	831A1.000, 831B1.000	01/83 ⇒ 07/89

EPS 1.330.109



04

DISTRIBUTOR CAPS

Adatt./Suitable: **MARELLI**

FIAT

9939789

LANCIA

9939789

MAGNETI MARELLI

071302701010
713 027 01

FIAT

FIORINO II 1.0 iE	156A2.246	11/92 ⇒ 04/96
PALIO 1.1	17889.033	07/97 ⇒ 10/03
PANDA I 1.1	156C.046	05/91 ⇒ 03/95
PANDA I 1000	156A2.000, 156A2.100, 156A3.000	01/85 ⇒
PANDA I 1000 4x4	156A2.100, 156A2.246, 156A3.000	01/86 ⇒ 12/94
PANDA I 1000 CLX	156A2.000	05/91 ⇒ 12/94
PANDA I 1000 Fire	156A2.000	05/86 ⇒ 04/91
PANDA I 1000 Fire [CHE]	156A2.146	11/87 ⇒ 04/91
PANDA I 1000 Fire [DEU]	156A2.048	01/86 ⇒ 07/89
PANDA I 1000 i.e.	156A2.246	08/92 ⇒ 02/04
PANDA I 1000 i.e. Cat	156A2.246	10/87 ⇒ 08/98
PANDA I 1100 i.e.	156C.046	01/86 ⇒ 04/91
PANDA I 1100 Trekking 4x4	156C.046	10/91 ⇒ 07/04
PANDA I 750	156A4.000	01/86 ⇒ 10/03
PANDA I 750 Cat	156A4.048	01/95 ⇒ 10/03
PANDA I 750 Fire	156A4.048	11/88 ⇒ 04/91
TIPO I 1.1	160A3.000	01/88 ⇒ 10/91
UNO 1.0	146A2.166	11/94 ⇒ 08/00
UNO 45 1.0	156A2.000, 156A2.100	06/86 ⇒ 12/93
UNO 45 1.0 Fire	--	01/83 ⇒ 12/89
UNO 45 i.e. 1.0	156A2.246	10/84 ⇒ 10/95
UNO 50 1.1	156C.046	01/90 ⇒ 12/93
UNO 50 i.e. 1.1	146C3.000	06/92 ⇒ 12/93
UNO 60 1.1	160A3.000	04/89 ⇒ 12/92
UNO Mondo 1.0	146A2.166	01/98 ⇒
UNO Mondo 1.0 [IND]	146A2.166	01/98 ⇒

LANCIA

Y10 1.0 Fire	156A2.100	06/85 ⇒ 06/91
Y10 1.0 Fire Catalytic-Conv	156A2.246	10/87 ⇒ 02/92
Y10 1.0 Fire Trazione integrale	156A2.000, 156A2.100, 156A2.246	12/86 ⇒ 02/92
Y10 1.1 i.e. Fire	156C.000	08/89 ⇒ 06/92
Y10 1.1 i.e. Fire Trazione integrale	156C.000	08/89 ⇒ 06/92
Y10 1.1 i.e. Fire	156C.046	07/89 ⇒ 09/95

EPS 1.330.110



08

DISTRIBUTOR CAPS

Adatt./Suitable: **MARELLI**

JAGUAR

JLM 1909

MAGNETI MARELLI

713 528 01

⁰³ Supplied until depletion

- Fornibile fino ad esaurimento delle scorte
- Fourni jusqu'à épuisement du stock
- Lieferbar solange vorrat reicht
- Suministrado hasta el stock termina



JAGUAR

XJ 5.3	85(92-93)	05/91 ⇒ 08/93
--------	-----------	---------------

JAGUAR		
XJ 6.0	8D	05/93 ⇒ 03/96
XJ V12 6.0	8C(92-94)	03/93 ⇒ 11/94
XJSC 5.3	8S(92-93)	05/91 ⇒ 08/93
XJSC 6.0	8D	05/93 ⇒ 03/96

EPS 1.330.111



04

DISTRIBUTOR CAPS

Adatt./Suitable: MARELLI

MAGNETI MARELLI
071358401010
713 584 01RENAULT
77 01 034 946

RENAULT		
19 I 1.2i	E7F	01/89 ⇒ 12/92
19 I 1.4	E6J700, E6J701, E7J700	01/88 ⇒ 12/92
19 II 1.2	E7F730	05/92 ⇒ 09/94
19 II 1.4	E6J706, E7J706, E7J707, E7J742, E7J745	01/92 ⇒ 12/95
CLIO I 1.2	E5F710, E5F716, E7F700, E7F706, E7F708, E7F750	05/90 ⇒ 09/98
CLIO I 1.4	E6J712, E6J713, E6J718, E7J601, E7J710, E7J711, E7J716, E7J718, E7J719, E7J754, E7J756, E7J757	01/90 ⇒ 09/98
EXPRESS 1.4	E6J/E7J	01/85 ⇒ 10/90
MEGANE I 1.4	E7J764	09/96 ⇒ 08/03
MEGANE I 1.4 e	E7J764	01/96 ⇒ 08/03
MEGANE I 1.4 Eco	E7J624	01/96 ⇒ 03/99
MEGANE SCÉNIC I 1.4 i	E7J764	01/97 ⇒ 09/99
RAPID 1.4	E6J738, E7J720, E7J724, E7J726, E7J728, E7J770, E7J771, E7J773	09/91 ⇒ 03/98
RAPID 1.4 RN	E6J734	09/91 ⇒ 08/93

EPS 1.330.114



04

DISTRIBUTOR CAPS

Adatt./Suitable: MARELLI

FIAT
9944576
9946355INNOCENTI
9946355LANCIA
9944576

FIAT		
COUPE 2.0 16V	836A3.000	11/93 ⇒ 08/96
COUPE 2.0 16V [BRA]	836A3.011	11/93 ⇒ 08/96
ELBA 1.5	149C1.000	01/92 ⇒ 12/96
FIORINO I 1.5	149C1.000	01/88 ⇒ 08/93
FIORINO II 1.5 iE	149C1.000	01/88 ⇒ 10/92
FIORINO II 70 i.e. 1.4	146C5.000	05/94 ⇒ 05/01
FIORINO II 75 i.e. 1.5	149C1.000	05/88 ⇒ 12/93
TEMPRA 1.6	159A3.000, 159A3.048, 159A3.098	03/90 ⇒ 12/96
TEMPRA 1.6 i.e.	159A3.046, 159A3.048	06/90 ⇒ 08/96
TEMPRA 1.8 4x4	159A4.000	07/92 ⇒ 06/93
TEMPRA 1.8 i.e.	159A4.000, 159A4.046	03/90 ⇒ 08/96
TEMPRA 2.0	159A6.046	04/90 ⇒ 06/93

FIAT		
TEMPRA 2.0 i.e.	159A6.046	10/90 ⇒ 09/96
TEMPRA 2.0 i.e. [BRA]	159A6.011	04/93 ⇒ 12/96
TEMPRA 2.0 i.e. 4x4	159A6.046	03/92 ⇒ 03/95
TIPO I 1.6	159A3.048, 835C1.000	03/93 ⇒ 10/95
TIPO I 1.6 i.e.	159A3.046, 159A3.048, 835C1.000	07/90 ⇒ 04/95
TIPO I 1.6 i.e. [BRA]	160E2.011	03/93 ⇒ 04/95
TIPO I 1.8 i.e.	159A4.000, 159A4.046	10/90 ⇒ 06/93
TIPO I 2.0	159A5.046, 159A6.046, 836A3.011	10/90 ⇒ 04/95
TIPO I 2.0 16V	160A8.046	07/91 ⇒ 04/95
TIPO I 2.0 i.e.	159A5.046, 159A6.046	03/90 ⇒ 04/95
TIPO I 2.0 i.e. [BRA]	159A6.011	03/93 ⇒ 10/95
TIPO I 2.0 i.e. 16V Sport	836A3.000	03/93 ⇒ 04/95
UNO 1.4 Super	146C2.028	09/89 ⇒ 09/92
UNO 70 i.e. 1.4	146C1.000, 160A1.046	09/89 ⇒ 07/96
UNO 70 S 1.4	160A1.048	10/88 ⇒ 06/06
UNO 75 i.e. 1.5	149C1.000	10/85 ⇒ 12/93
UNO Mondo 1.4 Super	146C2.028	01/96 ⇒

FIAT (BR)		
COUPE 2.0i 16V	2.0Mpi	01/95 ⇒ 12/97
TIPO 2.0i 16V	2.0Mpi	01/94 ⇒ 12/95

INNOCENTI		
ELBA 1.4 i.e.	146C5.000	09/94 ⇒ 12/96
ELBA 1.5 i.e.	149C1.000	08/92 ⇒ 09/94
MILLE 1.4	160A1046	07/95 ⇒ 05/97

LANCIA		
DEDRA 1.6	835A1000	07/94 ⇒ 02/97
DEDRA 2.0 16V	836A3.000	07/94 ⇒ 07/99
DEDRA 2.0 i.e.	835A5.046	09/89 ⇒ 07/99
DEDRA 2.0 Integrale	836A3.000	07/94 ⇒ 07/99
DELTA II 2.0 16V	836A3.000	06/93 ⇒ 08/99

EPS 1.330.115



04

DISTRIBUTOR CAPS

Adatt./Suitable: MARELLI

ALFA ROMEO
9950519FIAT
9944668
9947326
9950519INNOCENTI
9944668LANCIA
9944668

ALFA ROMEO		
164 2.0 Turbo	AR06476	10/87 ⇒ 09/98

FIAT		
CROMA I 2000 i.e.	154C3.000, 154C3.046, 834B.000, 834B.146	03/87 ⇒ 12/96
CROMA I 2000 i.e. Turbo	154C4.000, 154C4.046, 834C.146	11/86 ⇒ 08/96
FIORINO II 1.6	146C6.000	01/94 ⇒ 05/01
FIORINO II 75 i.e. 1.6	146C6.000	10/93 ⇒ 05/01
TEMPRA 1.4 i.e.	160A1.046	04/90 ⇒ 08/96
TEMPRA 1.6	159A3.000, 159A3.048, 159A3.098	03/90 ⇒ 12/96
TEMPRA 1.6 i.e.	159A3.046, 159A3.048	06/90 ⇒ 08/96
TEMPRA 1.8 4x4	159A4.000	07/92 ⇒ 06/93
TEMPRA 1.8 i.e.	159A4.000, 159A4.046	03/90 ⇒ 08/96
TEMPRA 2.0	159A6.046	04/90 ⇒ 06/93
TEMPRA 2.0 i.e.	159A6.046	10/90 ⇒ 09/96
TEMPRA 2.0 i.e. [BRA]	159A6.011	04/93 ⇒ 12/96
TEMPRA 2.0 i.e. 4x4	159A6.046	03/92 ⇒ 03/95
TIPO I 1.4 i.e.	160A1.046	05/89 ⇒ 04/95
TIPO I 1.6	159A3.048, 835C1.000	03/93 ⇒ 10/95
TIPO I 1.6 i.e.	159A3.046, 159A3.048, 835C1.000	07/90 ⇒ 04/95
TIPO I 1.6 i.e. [BRA]	160E2.011	03/93 ⇒ 04/95
TIPO I 1.6 SX DGT	159A3.000	05/89 ⇒ 10/95
TIPO I 1.8 i.e.	159A4.000, 159A4.046	10/90 ⇒ 06/93
TIPO I 2.0	159A5.046, 159A6.046	10/90 ⇒ 10/92
TIPO I 2.0 i.e.	159A5.046, 159A6.046	03/90 ⇒ 04/95
TIPO I 2.0 i.e. [BRA]	159A6.011	03/93 ⇒ 10/95
UNO 1.3 Turbo i.e.	146A2.246	09/89 ⇒ 03/91

FIAT (BR)		
TIPO 2.0i 8v	2.0Mpi	01/94 ⇒ 12/95
UNO 1.4i Turbo	1.4Mpi	01/94 ⇒ 12/96

INNOCENTI		
ELBA 1.6 i.e.	146C6.000	09/94 ⇒ 12/96

LANCIA		
DEDRA 1.6 i.e.	835A1.046	08/89 ⇒ 03/93
DEDRA 1.8 i.e.	835A2.000, 835A2.046, 835C5.000	09/89 ⇒ 07/99
DEDRA 2.0 HF Integrale	835A7.046	11/90 ⇒ 07/94
DEDRA 2.0 i.e.	835A5.000	09/89 ⇒ 07/92
DEDRA 2.0 i.e. Turbo	835A8.046	04/91 ⇒ 07/99
DEDRA 2.0 i.e. Turbo Integrale	835A7.000	04/90 ⇒ 08/91
DEDRA 2.0 Turbo	835A8.000	11/90 ⇒ 06/94
DELTA I 1.6 GT i.e.	149C2.000, 831B7.000	08/86 ⇒ 08/92
DELTA I 1.6 HF Turbo	831B3.000, 831B7.046	08/86 ⇒ 03/89
DELTA I 2.0 16V HF Evo Integrale	831E5.000	06/93 ⇒ 01/94
DELTA I 2.0 16V HF Integrale	831D5.000	03/89 ⇒ 09/91
DELTA I 2.0 HF Integrale	831B5.000, 831C5.000, 831C5.046	11/86 ⇒ 12/92
DELTA II 1.4 i.e.	160A1.046	10/94 ⇒ 08/99
THEMA 2000 i.e.	834B1.000	09/88 ⇒ 05/92
THEMA 2000 i.e.	834B.146	09/87 ⇒ 05/92
THEMA 2000 i.e. Turbo	834C.146	07/86 ⇒ 05/90
THEMA 2000 Turbo	834C.146	12/88 ⇒ 03/92

EPS 1.330.116



04

DISTRIBUTOR CAPS

Adatt./Suitable: MARELLI

MAGNETI MARELLI
0.71374201.010
713 756 01
71374201SEAT
030 905 207 ASKODA
030 905 207 AVW
030 905 207 A

SEAT		
AROSA 1.0	AER, ALL	05/97 ⇒ 06/04
AROSA 1.4	AER, AKV, APQ	05/97 ⇒ 06/04
CORDOBA I 1.0 i	AER	09/96 ⇒ 10/02
CORDOBA I 1.4	ANX	12/97 ⇒ 04/99
CORDOBA I 1.4 i	AKV, APQ	06/94 ⇒ 12/02
CORDOBA I 1.4 i 16V	AFH	09/96 ⇒ 10/02
CORDOBA I 1.6 i	AEE, ALM	02/93 ⇒ 12/02
IBIZA II 1.0 i	AER	09/96 ⇒ 02/02
IBIZA II 1.4	ANX	12/97 ⇒ 04/99
IBIZA II 1.4 i	ABD, AEX, AKV, APQ	09/93 ⇒ 02/02
IBIZA II 1.4 i 16V	AFH	06/97 ⇒ 02/02
IBIZA II 1.6 i	AEE, ALM	03/93 ⇒ 02/02
INCA 1.4 i	AEX, AKV, APQ	11/95 ⇒ 06/03
INCA 1.6 i	1F, AEE	11/95 ⇒ 05/98

SKODA		
FELICIA 1.6	6A16XHT	06/97 ⇒ 04/02
FELICIA 1.6 GLX	6A16XHT	08/95 ⇒ 03/98
FELICIA 1.6 LX	6A16XHT	08/95 ⇒ 03/98
OCTAVIA I 1.6	6A16XHT	09/96 ⇒ 09/04

VW		
CADDY II 1.4	AEX, AKV, APQ	11/95 ⇒ 06/03
CADDY III 1.6	AEE	06/96 ⇒ 12/00
CADDY II 60 1.4	AEX, APQ	11/95 ⇒ 01/04
CADDY II 75 1.6	AEE	11/95 ⇒ 09/00
GOLF III 1.4	AEX	10/91 ⇒ 04/99
GOLF III 1.6	AEE	09/92 ⇒ 08/97
LUPO 1.0	AER, ALL	09/98 ⇒ 07/05
POLO III 1.4	AEX, AKV, ANX, APQ	05/97 ⇒ 09/01
POLO III 1.6	AEA, AEE, ALM	09/94 ⇒ 09/01
POLO III 100 1.4 16V	AFH	04/96 ⇒ 10/99
POLO III 50 1.0	AER, ALL	09/96 ⇒ 10/99
POLO III 54 1.4	ANX	01/98 ⇒ 08/99
POLO III 55 1.3	ADX	10/94 ⇒ 04/97
POLO III 55 1.4	AEX	08/95 ⇒ 10/99

1.331.003/00

VW			
POLO III 60 1.4	AEX, AKV, APQ	07/95 →	09/01
POLO III 75 1.6	AEA, AEE, AHS, ALM	10/94 →	09/01
POLO III 75 1.6 4motion	AEA	08/95 →	10/99
POLO IV 1.0	AER	08/96 →	12/01

EPS 1.331.003/00



04

DISTRIBUTOR CAPS

Adatt./Suitable: **MITSUBISHI****BOSCH**

F 005 X04 726

HYUNDAI27110-21020
27110-21021
27110-21060
27110-32810
27120-11000**MAZDA**0324-24-310
AM15-18-V00
H612-24-310**MITSUBISHI**08605
27110-21060
27110-32810
MD602756
MD602949
MD607597
MD611604
MD611686
MD618210
T42271**NISSAN**22162-R9006
22162-R9007

FORD AUSTRALIA

COURIER 1.8	--	01/79 →	12/84
COURIER 2.0	--	01/79 →	
LASER 1.3	E3	03/81 →	02/83
LASER 1.5	E5	03/81 →	02/83
LASER 1.5 Sport	E5	03/81 →	02/83
METEOR 1.3	--	04/82 →	09/85

HYUNDAI

ELANTRA I 1.5	--	10/90 →	04/95
ELANTRA I 1.5 i GL	G4DJ	12/90 →	08/94
EXCEL 1.3	G4AN	07/85 →	07/91
EXCEL 1.5	G4AJ	07/85 →	08/89
H-1 1.2.4	G4CS	06/97 →	04/04
H-1 1.2.4 4WD	G4CS	02/98 →	04/04
H100 2.4	G4CS	07/93 →	12/04
LANTRA I 1.5	G4DJ	10/90 →	04/95
LANTRA I 1.5 i.e.	G4DJ	10/90 →	11/95
PONY 1.3	G13B	10/85 →	01/95
PONY 1.5	G15B, G4DJ	10/85 →	01/95
PONY 1.5 i	G15B, G4DJ	10/89 →	01/95
PONY / EXCEL 1.3	G4DG	01/90 →	01/95
PONY / EXCEL 1.5	G15B, G4DJ	01/90 →	01/95
PONY / EXCEL 1.5 i	G15B, G4DJ	01/90 →	01/95
PORTER I 2.4	G4CS	03/96 →	04/04
PRECIS 1.5 i [USA]	G4DJ	01/89 →	
SANTAMO 2.0 16V	G4JP	05/99 →	12/02
SANTAMO 2.0 16V 4x4	G4CP-D	05/99 →	12/02
S COUPE 1.5	G4DJA	03/90 →	12/92
S COUPE 1.5 i	G4DJ	02/90 →	05/96
SONATA II 2.4 i	G4CS	09/88 →	08/91
SONATA III 1.8 GLS	G4DM	07/96 →	05/98
SONATA III 1.8 i	G4CM	05/93 →	06/98
SONATA III 2.0 i	G4CP, G4EP	06/94 →	06/98
STELLAR 1.4	4G33	10/83 →	08/86
STELLAR 1.6	G32B	10/83 →	12/91
STELLAR 2.0	--	01/87 →	12/91

MAZDA

929 I 2.0 MA 05/79 → 07/86

MITSUBISHI

COLT I 1.2 GL	4G11	12/78 →	01/84
COLT III 1.3 GL	4G13(8V), G13B	04/88 →	12/90
COLT III 1.5 GLXi	4G15(8V)	04/88 →	05/92
COLT II 1.3 EL, GL	G13B	06/86 →	04/88
CORDIA 1.8 [USA]	G62B	01/82 →	12/88
CORDIA 1.8 Turbo [USA]	G62B	01/82 →	12/88

MITSUBISHI

LANCER V 1.2 GL	4G16	05/88 →	08/92
LANCER V 1.3	4G13(8V), G13B	04/88 →	05/92
LANCER V 1.3 GL	G13B	05/88 →	06/90
LANCER V 1.5	4G15(12V), 4G15(8V)	04/88 →	05/92
LANCER V 1.5 12V	4G15(12V)	05/89 →	05/92
LANCER V 1.5 GLS	4G15(12V)	08/89 →	08/92
LANCER V 1.8 4WD	4G37	03/89 →	06/92
LANCER III/IV 1.2	4G16	08/86 →	04/88
GALANT VI 1.6	4G32	01/88 →	10/92
GALANT VI 1.8	4G37	11/87 →	10/92
GALANT VI 2.0	4G63(SOHC8V)	11/87 →	12/92
GALANT VI 2.0 4WD	4G63(SOHC8V)	12/88 →	10/92
L200 II 1.6	4G32	04/87 →	10/96
L200 II 2.4	4G64(12V)	06/90 →	10/96
L200 II 2.6 4WD	G54B	11/89 →	05/95
MONTERO 2.4 16V	4G64(12V)	04/91 →	
MONTERO 2.6i [USA]	4G54	01/83 →	12/90
PAJERO I 2.6	4G54	01/83 →	11/90
PAJERO I 2.6 4WD	4G54	01/83 →	05/91
PAJERO II 2.4	4G64(12V)	04/91 →	04/00
PAJERO II 2.6 4WD	4G54	03/91 →	10/97
PAJERO III 2.4	4G64(12V)	10/01 →	08/06
PAJERO III 2.4 4x4	4G64(12V)	10/01 →	12/06
PAJERO SPORT II 2.4	4G64(16V)	07/08 →	
PRECIS 1.5 i [USA]	G4DJ	01/89 →	12/94
SHOGUN I 2.6 4x4	4G54	01/84 →	02/91
STARION 2.0 Turbo Eci	4G63-T(ECI), 4G63-T/C	06/82 →	08/87
TRUCK 2.4i [USA]	4G64	01/89 →	
TRUCK 2.6 [USA]	G54B	01/86 →	
VALLEY 2.4 i	4G64	09/92 →	10/94

NISSAN

URVAN III 2.0 Z20 05/87 → 05/97

EPS 1.331.109



07

DISTRIBUTOR CAPS

Adatt./Suitable: **MITSUBISHI****MAZDA**E594-24-310
FE01-24-310
FE01-24-310A**Motorcraft**

EDH 189

03 Supplied until depletion

- Fornibile fino ad esaurimento delle scorte
- Fourni jusqu'à épuisement du stock
- Lieferbar solange vorrat reicht
- Suministrado hasta el stock termina



FORD AUSTRALIA

LASER 1.3	E3	03/83 →	09/85
LASER 1.5	E5	03/83 →	09/85
METEOR 1.3	--	04/82 →	09/85
METEOR 1.5	E5	04/82 →	09/85
TELSTAR 2.0 TXS	FE	05/83 →	10/87

MAZDA

323 IV 1.1	E1	11/80 →	10/85
626 III 1.6	F6	11/82 →	09/87
626 III 2.0	FE(8V)	03/83 →	01/90
929 II 2.0	FE(8V)	03/84 →	07/87

EPS 1.331.114



05

DISTRIBUTOR CAPS

Adatt./Suitable: **MITSUBISHI****BOSCH**1 987 233 112
F 005 X12 906**NISSAN**22162-23G15
22162-40F10
22162-78A10
22162-G5710
22162-G5711**NISSAN**

NAVARA I 2.4	Z24i	06/92 →	02/97
NX1600 1.6 [USA]	E16	01/87 →	12/90
PICK UP I 2.4 i [USA]	KA24E	01/89 →	
PICK UP I 2.4 i 12V	KA24E	04/92 →	02/98
PICK UP I 2.4 i 12V 4WD	KA24E	04/92 →	02/98
PULSAR NX 1.6 [USA]	E16	01/86 →	
SUNNY II 1.6 i	E16i	06/86 →	10/90
SUNNY II 1.6 i 12V	GA16i	06/86 →	06/91
SUNNY II 1.6 i 4x4	E16i	06/86 →	10/90
SUNNY III 1.4	GA14DS	10/90 →	06/95
SUNNY III 1.4 i	GA14DS	10/90 →	05/95
VANETTE II 2.0	Z20S	07/87 →	08/94

EPS 1.331.116



07

DISTRIBUTOR CAPS

Adatt./Suitable: **MITSUBISHI****CHRYSLER**

MD611 526

HYUNDAI

27110-36010

MITSUBISHI

MD611526

03 Supplied until depletion

- Fornibile fino ad esaurimento delle scorte
- Fourni jusqu'à épuisement du stock
- Lieferbar solange vorrat reicht
- Suministrado hasta el stock termina

**CHRYSLER**

LE BARON 3.0 i V6	6G72	01/90 →	12/96
VOYAGER I 3.0 i [USA]	EFA	10/84 →	07/90
VOYAGER 3.0 i	300, 6G72	01/91 →	09/95
VOYAGER 3.3	EGA	10/89 →	09/90

HYUNDAI

GALLOPER 3.0 V6	G6AT	08/98 →	12/03
INNOVATION 3.0 V6	G6AT	05/00 →	

MITSUBISHI

PAJERO I 3.0 i 4WD	6G72(SOHC12V)	05/88 →	05/91
PAJERO I 3.0 V6	6G72(SOHC12V)	11/88 →	11/90
PAJERO II 3.0 V6	6G72(SOHC12V)	12/90 →	12/95
PAJERO II 3.0 V6 4WD	6G72(SOHC12V)	12/90 →	12/95

EPS 1.331.117



04

DISTRIBUTOR CAPS

Adatt./Suitable: **MITSUBISHI****MAZDA**FE1H-18-V00
FE1H-18-V00A
FEH1-18-V00A**03 Supplied until depletion**

- Fornibile fino ad esaurimento delle scorte
- Fourni jusqu'à épuisement du stock
- Lieferbar solange vorrat reicht
- Suministrado hasta el stock termina

**FORD AUSTRALIA**

SPECTRON 2.0	OHC	01/84 ⇨
MAZDA		
929 III 2.2	--	01/86 ⇨ 12/91
929 III 2.2 12V	F2, F21, F267, F2E	02/87 ⇨ 05/89
929 III 2.2 i	F2-EGL	05/87 ⇨ 12/88

EPS 1.331.118



07

DISTRIBUTOR CAPS

Adatt./Suitable: **MITSUBISHI****MAZDA**ESD5-18-V00A
MITSUBISHI
T45071**03 Supplied until depletion**

- Fornibile fino ad esaurimento delle scorte
- Fourni jusqu'à épuisement du stock
- Lieferbar solange vorrat reicht
- Suministrado hasta el stock termina

**FORD AUSTRALIA**

LASER 1.3	E3	10/85 ⇨ 09/87
METEOR 1.3	--	10/85 ⇨ 09/87
MAZDA		
323 V 1.1	E1	09/85 ⇨ 10/89
323 V 1.3	E3, E391, E393	08/85 ⇨ 05/89
323 V 1.3 i	B3E	09/85 ⇨ 08/89
323 V 1.5	B5, B50, B53, E5	08/85 ⇨ 10/89

EPS 1.331.120



04

DISTRIBUTOR CAPS

Adatt./Suitable: **MITSUBISHI****NISSAN**22162-25G10
22162-25G11
22162-A3514**NISSAN**

VANETTE II 1.5	A15	04/87 ⇨ 11/94
----------------	-----	---------------

EPS 1.331.121



04

DISTRIBUTOR CAPS

Adatt./Suitable: **MITSUBISHI****BOSCH**

F 005 X04 740

FORD4 132 265
F220 18V00 A
XM34-12106-BA**HYUNDAI**

27110-02503

KIAKK137-18V00
MF220-18-V00A**MAZDA**BP05-18-V00
F220-18-V00A
F2G8-18-V00
G609-18-V00**Motorcraft**DH 444
DHE 441**FORD**

ENDEAVOUR 2.6	--	10/06 ⇨
ENDEAVOUR 2.6 EFI	--	08/03 ⇨
EVEREST 2.6	--	10/06 ⇨
EVEREST 2.6 EFI	--	08/03 ⇨
RANGER IV 2.2	--	03/02 ⇨ 09/05
RANGER IV 2.2 EFI	--	03/99 ⇨
RANGER IV 2.6	--	10/02 ⇨ 09/04
RANGER IV 2.6 EFI	--	10/06 ⇨

HYUNDAI

ATOS 1.0 i	G4HC	02/98 ⇨ 03/02
ATOS PRIME 1.0 i	G4HC	08/99 ⇨

KIA

AVELLA 1.3	B3	11/95 ⇨ 12/01
AVELLA 1.5	--	02/97 ⇨ 12/01
CLARUS 2.0 i 16V	FE(16V)	07/96 ⇨
CREDOS 2.0 [AUS]	--	06/95 ⇨ 10/00
PRIDE 1.3	B3, B3A5	01/90 ⇨ 09/01
PRIDE 1.3 i [GBR]	--	01/90 ⇨
SEPHIA I 1.6 i	B6	09/93 ⇨ 10/97

MAZDA

323 VI C 1.6	B6E	09/89 ⇨ 06/91
323 VI C 1.6 16V	B6	03/91 ⇨ 10/94
323 VI F 1.6	B6E	09/89 ⇨ 06/91
323 VI F 1.6 16V	B6	03/91 ⇨ 10/94
323 VI F 1.8 16V	BP	08/89 ⇨ 07/94
323 VI F 1.8 16V GT	BP(DOHC)	08/89 ⇨ 07/94
323 VI F 1.8i 16v GRSi	BP31	06/89 ⇨ 03/91
323 VI S 1.3 16V	B3(16V)	04/91 ⇨ 07/94
323 VI S 1.6	B6E	09/89 ⇨ 06/91
323 VI S 1.6 16V	B6	08/89 ⇨ 10/96
323 VI S 1.8 16V	BP52	08/89 ⇨ 07/94
323 VI S 1.8 16V 4WD	BP52	09/91 ⇨ 07/94
323 VI S 1.8 16V Turbo 4WD	BPTurbo	01/91 ⇨ 07/94
626 IV 2.0 16V	FE(16V)	06/87 ⇨ 05/92
626 IV 2.2 12V	F2	11/87 ⇨ 04/92
626 IV 2.2 12V 4WD	F2	11/87 ⇨ 07/90
B2600 2.6i 12v 4x4	R585	02/99 ⇨
B-SERIE 2.2 4WD	R5A2	02/99 ⇨ 11/06
323 VI 1.8i 16v 4x4	BP51	06/89 ⇨ 03/91
323 VI 1.8i 16v GRSi	BP22	06/89 ⇨ 03/91
323 VI 1.8i 16v GT Formula 4	BP55	04/91 ⇨ 04/94
323 VI 1.8i 16v GT-R Formula 4	BP5J	04/91 ⇨ 04/94
323 VI 1.8i 16v Turbo 4x4	BP55	06/89 ⇨ 03/91
E2000 2.0i 12v	FERW, FEY9	04/97 ⇨
E2000 2.0i 12v 4x4	FEJM, FEY9	09/90 ⇨ 08/99
BT-50 2.2	--, F2E	09/06 ⇨
BT-50 2.6	G6, G6Y1	09/06 ⇨
MPV I [USA] 2.6 12V	--	01/89 ⇨ 12/94
MPV I [USA] 2.6 12V 4WD	--	01/89 ⇨ 12/94
MX-3 1.6	B69	05/91 ⇨ 10/93
PROTEGE 1.8i DOHC [USA]	--	01/90 ⇨
PROTEGE 1.8i OHC [USA]	--	01/90 ⇨

EPS 1.331.122



05

DISTRIBUTOR CAPS

Adatt./Suitable: **MITSUBISHI****BOSCH**

F 005 X12 889

FORD

KK 150 18 V00

HYUNDAI

KK150-18V00A

KIAKK150-18V00
KK150-18-V00A**MAZDA**B303-18-V00
B3B1-18-V00
G602-18-V00**Motorcraft**

DHE 439

03 Supplied until depletion

- Fornibile fino ad esaurimento delle scorte
- Fourni jusqu'à épuisement du stock
- Lieferbar solange vorrat reicht
- Suministrado hasta el stock termina

**FORD AUSTRALIA**

FESTIVA 1.3	--	01/91 ⇨
KIA		
PRIDE 1.1 i	B1	01/91 ⇨ 10/00
PRIDE 1.3 [GBR]	--	01/90 ⇨
PRIDE 1.3 i	--	01/90 ⇨ 05/97
MAZDA		
121 I 1.1	B115, B116	10/87 ⇨ 01/91
121 I 1.3	B3	10/87 ⇨ 06/91
323 V 1.6	93AF1006, B6E	09/86 ⇨ 10/95
323 V 1.6 4x4	B65M, B6E	05/90 ⇨ 03/93
323 V 1.6 GT	93AF1006	01/86 ⇨ 10/89
323 V 1.6i 16v Formula 4	B6F2	08/87 ⇨ 05/89
MPV I [USA] 2.6 12V	--	01/89 ⇨ 12/94
MPV I [USA] 2.6 12V AWD	--	01/89 ⇨ 12/94

EPS 1.331.125



07

DISTRIBUTOR CAPS

Adatt./Suitable: **MITSUBISHI****BOSCH**

1 987 233 117

MAZDAB616-18-V00
F201-18-V00**Motorcraft**

DHE 440

03 Supplied until depletion

- Fornibile fino ad esaurimento delle scorte
- Fourni jusqu'à épuisement du stock
- Lieferbar solange vorrat reicht
- Suministrado hasta el stock termina

**MAZDA**

323 V 1.6 GT	93AF1006	01/86 ⇨ 10/89
323 V 1.6i	B681, B682	06/86 ⇨ 07/87
323 V 1.6i 16v 4x4	B595	06/86 ⇨ 07/87
323 V 1.6i 16v Formula 4	B6F2	08/87 ⇨ 05/89
626 IV 1.8	F8(12V)	09/87 ⇨ 05/92
626 IV 2.0	FE(12V)	09/87 ⇨ 10/90
626 IV 2.0 12V	FE(12V), FEFJ, FEFK	09/87 ⇨ 05/92
626 IV 2.2 12V	F2	11/87 ⇨ 04/92
626 IV 2.2 12V 4WD	F2	11/87 ⇨ 07/90

EPS 1.331.126



07

DISTRIBUTOR CAPS

Adatt./Suitable: **MITSUBISHI****BOSCH**

F 005 X12 620
NISSAN
 22162-41L11
 22162-42L10
 22162-42L11
 22162-52H20

⁰³ Supplied until depletion

- Fornibile fino ad esaurimento delle scorte
- Fourni jusqu'à épuisement du stock
- Lieferbar solange vorrat reicht
- Suministrado hasta el stock termina

**NISSAN**

PATROL GR I 4.2 Cat	TB42E	11/88 ⇒ 02/98
---------------------	-------	---------------

EPS 1.331.131



04

DISTRIBUTOR CAPS

Adatt./Suitable: **MITSUBISHI****BOSCH**

1 987 233 129

HOLDEN

3332162E10

MAZDA

B541-18-V00

MITSUBISHI

MD618364

Motorcraft

ADH 5071

SUZUKI

33321-62E10
 33321-62E10-000

⁰³ Supplied until depletion

- Fornibile fino ad esaurimento delle scorte
- Fourni jusqu'à épuisement du stock
- Lieferbar solange vorrat reicht
- Suministrado hasta el stock termina

**FORD AUSTRALIA**

LASER 1.6	B6(SOHC16V)	03/90 ⇒ 09/91
-----------	-------------	---------------

HOLDEN

BARINA 1.3 GL	410UF015G02	02/89 ⇒ 05/94
---------------	-------------	---------------

MAZDA

121 I 1.1	B115, B116	10/87 ⇒ 01/91
121 I 1.1 Unleaded Fuel	--	01/87 ⇒ 12/91
121 I 1.3	B3	04/89 ⇒ 10/90
121 I 1.3 Leaded Fuel	--	01/87 ⇒ 12/91
121 II 1.1	B1	11/90 ⇒ 10/93
323 III 1.5	B505, B535, B536	09/89 ⇒ 09/93
323 VI S 1.3	B383, B3E	09/89 ⇒ 06/91
323 VI S 1.3 16V	B3(16V)	04/91 ⇒ 07/94
323 VI S 1.6 16V	B6	08/89 ⇒ 10/96
323 VI 1.3 16V	B384, B386, B387	06/89 ⇒ 03/91

MITSUBISHI

EXPO 2.4 i [USA]	4G64	01/91 ⇒ 12/92
GALANT VI 2.0	4G63(SOHC8V)	11/87 ⇒ 12/92
GALANT VI 2.0 4WD	4G63(SOHC8V)	12/88 ⇒ 10/92
LANCER V 1.8 4WD	4G37	03/89 ⇒ 06/92
LANCER V 1.8 GTi	4G37	06/92 ⇒ 07/93
LANCER VI 1.8 GTi	4G37	06/92 ⇒ 07/93

FORD

RANGER IV 2.2	--	10/99 ⇒
---------------	----	---------

HOLDEN

BARINA 1.3 GL	410UF015G02	02/89 ⇒ 05/94
---------------	-------------	---------------

MAZDA

121 I 1.1	B1, B116	10/87 ⇒ 10/90
121 I 1.3	B3	10/87 ⇒ 06/91
323 III 1.5	B505, B535, B536	09/89 ⇒ 09/93
323 IV 1.3	E3	09/81 ⇒ 10/85
323 V 1.3	B333, E3, E391, E393	08/85 ⇒ 05/89
323 V 1.3 i	B335	09/85 ⇒ 08/89
323 V 1.5	B5, B50, B53, E5	08/85 ⇒ 10/89
323 V 1.6	93AF1006, B6E	09/86 ⇒ 10/95
626 IV 1.8	F8(12V)	09/87 ⇒ 05/92
626 IV 2.0	FE(12V)	09/87 ⇒ 10/90
626 IV 2.0 12V	FE(12V), FEF1, FEFK	09/87 ⇒ 05/92
929 III 2.0	FE(8V), FEFA	06/87 ⇒ 05/89
929 III 2.2	--	01/86 ⇒ 12/91
929 III 2.2 12V	F2, F21, F267, F2E	02/87 ⇒ 05/89
929 III 2.2 i	F2-Egl	05/87 ⇒ 12/88
929 III 2.2i 12v	F2E6, F2E7	06/89 ⇒ 09/92
E2000 2.0	FEFN, FECK, FEY7	11/87 ⇒ 05/95
E2000 2.0 4x4	FECK, FEY7	11/87 ⇒ 07/91
E E2000 4WD	FEFN	10/88 ⇒ 09/89

SUZUKI

SWIFT I / II / III 1.3 GTi SOHC	G13B	10/89 ⇒ 12/95
SWIFT I / II / III 1.6	G16B	11/89 ⇒ 12/91
SWIFT I / II / III 1.6 4WD	G16B	11/89 ⇒ 12/91

MITSUBISHI

COLT III 1.5 Cat	4G15(12V)	07/90 ⇒ 05/92
COLT IV 1.3 GLi 12V	4G13(12V)	04/92 ⇒ 04/96
LANCER V 1.3 12V	4G13(12V)	07/90 ⇒ 05/94
LANCER V 1.3 GL	4G13(12V)	07/90 ⇒ 08/92
LANCER V 1.5	4G15(12V)	09/88 ⇒ 09/92

NISSAN

CABSTAR II 2.0	--	07/92 ⇒ 05/94
SUNNY II 1.4 LX	GA14S	10/88 ⇒ 08/91

MITSUBISHI

LANCER V 1.5 12V	4G15(12V)	05/89 ⇒ 05/92
LANCER V 1.5 GLS	4G15(12V)	08/89 ⇒ 08/92
MIRAGE III 1.5	4G15(12V)	05/88 ⇒ 06/90
MIRAGE III 1.5 12V	4G15(12V)	05/88 ⇒ 06/90

MITSUBISHI

Adatt./Suitable: **MITSUBISHI**
MITSUBISHI
 MD618374
 MD626374

⁰⁰ Eliminated on 14-04-2020. Please verify the availability through our local distributors

- Eliminato il 14-04-2020. Verificare la disponibilità presso i nostri distributori
- Éliminé le 14-04-2020. Vérifier la disponibilité auprès de nos distributeurs sur place
- Am 14-04-2020 gestrichen. Evtl. Verfügbarkeit bitte bei unseren Händlern prüfen
- Eliminado en fecha 14-04-2020. Verificar la disponibilidad a través de nuestros distribuidores locales

MITSUBISHI

Adatt./Suitable: **MITSUBISHI**

MITSUBISHI

Adatt./Suitable: **MITSUBISHI**

MITSUBISHI

Adatt./Suitable: **MITSUBISHI**

MITSUBISHI

Adatt./Suitable: **MITSUBISHI**

MITSUBISHI

Adatt./Suitable: **MITSUBISHI**

MITSUBISHI

Adatt./Suitable: **MITSUBISHI**

EPS 1.331.132



04

DISTRIBUTOR CAPS

Adatt./Suitable: **MITSUBISHI****BOSCH**

1 987 233 118
 F 005 X04 730

FORD

4 006 232
 XM34-12106-AA

HOLDEN

3332163B40

MAZDA

F829-18-V00
 FE25-18-V00
 FE25-18-V00A
 FEEN-18-V00

SUZUKI

33321-63B40
 33321-63B40-000

⁰³ Supplied until depletion

- Fornibile fino ad esaurimento delle scorte
- Fourni jusqu'à épuisement du stock
- Lieferbar solange vorrat reicht
- Suministrado hasta el stock termina

**FORD**

RANGER IV 2.2	--	10/99 ⇒
---------------	----	---------

HOLDEN

BARINA 1.3 GL	410UF015G02	02/89 ⇒ 05/94
---------------	-------------	---------------

MAZDA

121 I 1.1	B1, B116	10/87 ⇒ 10/90
121 I 1.3	B3	10/87 ⇒ 06/91
323 III 1.5	B505, B535, B536	09/89 ⇒ 09/93
323 IV 1.3	E3	09/81 ⇒ 10/85
323 V 1.3	B333, E3, E391, E393	08/85 ⇒ 05/89
323 V 1.3 i	B335	09/85 ⇒ 08/89
323 V 1.5	B5, B50, B53, E5	08/85 ⇒ 10/89
323 V 1.6	93AF1006, B6E	09/86 ⇒ 10/95
626 IV 1.8	F8(12V)	09/87 ⇒ 05/92
626 IV 2.0	FE(12V)	09/87 ⇒ 10/90
626 IV 2.0 12V	FE(12V), FEF1, FEFK	09/87 ⇒ 05/92
929 III 2.0	FE(8V), FEFA	06/87 ⇒ 05/89
929 III 2.2	--	01/86 ⇒ 12/91
929 III 2.2 12V	F2, F21, F267, F2E	02/87 ⇒ 05/89
929 III 2.2 i	F2-Egl	05/87 ⇒ 12/88
929 III 2.2i 12v	F2E6, F2E7	06/89 ⇒ 09/92
E2000 2.0	FEFN, FECK, FEY7	11/87 ⇒ 05/95
E2000 2.0 4x4	FECK, FEY7	11/87 ⇒ 07/91
E E2000 4WD	FEFN	10/88 ⇒ 09/89

SUZUKI

SWIFT I / II / III 1.3 GTi SOHC	G13B	10/89 ⇒ 12/95
SWIFT I / II / III 1.6	G16B	11/89 ⇒ 12/91
SWIFT I / II / III 1.6 4WD	G16B	11/89 ⇒ 12/91

MITSUBISHI

ECLIPSE I 1.8	4G37	12/89 ⇒ 03/94
GALANT VI 1.8	4G37	11/87 ⇒ 10/92

MITSUBISHI

Adatt./Suitable: **MITSUBISHI**

MITSUBISHI

Adatt./Suitable: **MITSUBISHI**

MITSUBISHI

Adatt./Suitable: **MITSUBISHI**

MITSUBISHI

Adatt./Suitable: **MITSUBISHI**

MITSUBISHI

Adatt./Suitable: **MITSUBISHI**

MITSUBISHI

Adatt./Suitable: **MITSUBISHI**

MITSUBISHI

Adatt./Suitable: **MITSUBISHI**

MITSUBISHI

Adatt./Suitable: **MITSUBISHI**

MITSUBISHI

Adatt./Suitable: **MITSUBISHI**

MITSUBISHI

Adatt./Suitable: **MITSUBISHI**

MITSUBISHI

Adatt./Suitable: **MITSUBISHI**

MITSUBISHI

Adatt./Suitable: **MITSUBISHI**

MITSUBISHI

Adatt./Suitable: **MITSUBISHI**

MITSUBISHI

Adatt./Suitable: **MITSUBISHI**

MITSUBISHI

Adatt./Suitable: **MITSUBISHI**

MITSUBISHI

Adatt./Suitable: **MITSUBISHI**

MITSUBISHI

Adatt./Suitable: **MITSUBISHI**

MITSUBISHI

Adatt./Suitable: **MITSUBISHI**

MITSUBISHI

Adatt./Suitable: **MITSUBISHI**

MITSUBISHI

Adatt./Suitable: **MITSUBISHI**

MITSUBISHI

Adatt./Suitable: **MITSUBISHI**

MITSUBISHI

Adatt./Suitable: **MITSUBISHI**

MITSUBISHI

Adatt./Suitable: **MITSUBISHI**

MITSUBISHI

Adatt./Suitable: **MITSUBISHI**

MITSUBISHI

Adatt./Suitable: **MITSUBISHI**

MITSUBISHI

Adatt./Suitable: **MITSUBISHI**

MITSUBISHI

Adatt./Suitable: **MITSUBISHI**

MITSUBISHI

Adatt./Suitable: **MITSUBISHI**

**MITSUBISHI**

LANCER V 1.5 12V	4G15(12V)	05/89 ⇒ 05/92
LANCER V 1.5 GLS	4G15(12V)	08/89 ⇒ 08/92
MIRAGE III 1.5	4G15(12V)	05/88 ⇒ 06/90
MIRAGE III 1.5 12V	4G15(12V)	05/88 ⇒ 06/90

MITSUBISHI

LANCER V 1.5 12V	4G15(12V)	05/89 ⇒ 05/92
LANCER V 1.5 GLS	4G15(12V)	08/89 ⇒ 08/92
MIRAGE III 1.5	4G15(12V)	05/88 ⇒ 06/90
MIRAGE III 1.5 12V	4G15(12V)	05/88 ⇒ 06/90

MITSUBISHI

LANCER V 1.5 12V	4G15(12V)	05/89 ⇒ 05/92
LANCER V 1.5 GLS	4G15(12V)	08/89 ⇒ 08/92
MIRAGE III 1.5	4G15(12V)	05/88 ⇒ 06/90
MIRAGE III 1.5 12V	4G15(12V)	05/88 ⇒ 06/90

MITSUBISHI

LANCER V 1.5 12V	4G15(12V)
------------------	-----------

EPS 1.331.137

07,5

DISTRIBUTOR CAPS

Adatt./Suitable: **MITSUBISHI****BOSCH**

F 005 X04 755

⁰³ Supplied until depletion

- Fornibile fino ad esaurimento delle scorte
- Fourni jusqu'à épuisement du stock
- Lieferbar solange vorrat reicht
- Suministrado hasta el stock termina

FORD3 898 173
F32Z-12106-C
KL01-18V00-A**FORD USA**

3 898 173

MAZDAKL01-18-V00
KL01-18-V00A**Motorcraft**

DHE 448

²¹¹ Resistance [kOhm] 5

- Resistenza [kOhm] 5
- Résistance [kOhm] 5
- Widerstand [kOhm] 5
- Resistencia [kOhm] 5

**FORD AUSTRALIA**

TELSTAR 2.5	KL-ZE	01/92 ⇨ 10/95
TELSTAR 2.5 TX5 EFI	KL-ZE	10/94 ⇨ 11/96

FORD USA

PROBE II 2.5 V6 24V	KL	10/93 ⇨ 03/98
---------------------	----	---------------

MAZDA

626 V 2.5 24V	KL	01/92 ⇨ 04/97
626 V 2.5i V6 [USA]	--	01/94 ⇨
MX-3 1.8 i V6	K819	01/92 ⇨ 01/94
MX-6 2.5 24V	KL	02/92 ⇨ 09/97

EPS 1.331.138

05

DISTRIBUTOR CAPS

Adatt./Suitable: **MITSUBISHI****BOSCH**

1 987 233 122

MITSUBISHIMD618555
MD618977⁰³ Supplied until depletion

- Fornibile fino ad esaurimento delle scorte
- Fourni jusqu'à épuisement du stock
- Lieferbar solange vorrat reicht
- Suministrado hasta el stock termina

**MITSUBISHI**

COLT IV 1.6 4WD	4G92(SOHC16V)	08/93 ⇨ 08/95
COLT IV 1.6 GLXi 16V	4G92(SOHC16V)	04/92 ⇨ 04/96
EXPOLRV 2.4i [USA]	4G64	01/92 ⇨
LANCER V 1.6 16V	4G92(SOHC16V)	06/92 ⇨ 05/94
LANCER V 1.6 4WD	4G92(SOHC16V)	06/92 ⇨ 11/93
LANCER VI 1.6 16V	4G92(SOHC16V)	06/92 ⇨ 10/03
LANCER VI 1.6 16V 4WD	4G92(SOHC16V)	06/92 ⇨ 10/03
SPACE RUNNER 1.8	4G93(SOHC16V)	10/91 ⇨ 08/99
SPACE RUNNER 1.8 4WD	4G93(SOHC16V)	10/91 ⇨ 08/99
SPACE WAGON 1.8	4G93(SOHC16V)	10/91 ⇨ 10/98
SPACE WAGON 1.8 4WD	4G93(SOHC16V)	10/91 ⇨ 10/98
SPACE WAGON 2.0	4G63(SOHC16V)	10/92 ⇨ 10/98
SPACE WAGON 2.0 4WD	4G63(SOHC16V)	10/92 ⇨ 10/98

EPS 1.331.139

04

DISTRIBUTOR CAPS

Adatt./Suitable: **MITSUBISHI****CHEVROLET**

93740920

DAEWOO33321-78B40-000
93740920
TS100C00601**GENERAL MOTORS**

93 740 920

SUZUKI33321-78B40
33321-78B40-000**CHEVROLET**

SPARK I 0.8	F8CV	09/00 ⇨ 12/06
-------------	------	---------------

DAEWOO

MATIZ 0.8	F8CV	08/98 ⇨
-----------	------	---------

EPS 1.331.140

04

DISTRIBUTOR CAPS

Adatt./Suitable: **MITSUBISHI****GENERAL MOTORS**

96 064 788

SUZUKI33321-56B10
33321-56B10-000⁰³ Supplied until depletion

- Fornibile fino ad esaurimento delle scorte
- Fourni jusqu'à épuisement du stock
- Lieferbar solange vorrat reicht
- Suministrado hasta el stock termina

**SUZUKI**

SIDEKICK 1.6i [USA]	--	01/91 ⇨
VITARA I 1.6 8V	--	01/90 ⇨ 12/98

EPS 1.331.143

07,5

DISTRIBUTOR CAPS

Adatt./Suitable: **MITSUBISHI****BOSCH**

F 005 X04 749

MITSUBISHIMD618431
MD619176⁰³ Supplied until depletion

- Fornibile fino ad esaurimento delle scorte
- Fourni jusqu'à épuisement du stock
- Lieferbar solange vorrat reicht
- Suministrado hasta el stock termina

**MITSUBISHI**

SIGMA 3.0	6G72(SOHC12V)	06/92 ⇨ 10/96
SIGMA 3.0 V6	6G72(SOHC12V)	12/90 ⇨ 07/96

EPS 1.331.144

04

DISTRIBUTOR CAPS

Adatt./Suitable: **MITSUBISHI****GENERAL MOTORS**

96 068 686

SUZUKI33321-58B10
33321-58B10-000⁰³ Supplied until depletion

- Fornibile fino ad esaurimento delle scorte
- Fourni jusqu'à épuisement du stock
- Lieferbar solange vorrat reicht
- Suministrado hasta el stock termina

**SUZUKI**

SIDEKICK 1.6i 16V J1X 4x4	G16B	04/89 ⇨ 04/96
---------------------------	------	---------------

EPS 1.331.145

05

DISTRIBUTOR CAPS

Adatt./Suitable: **MITSUBISHI****SUBARU**

22162-AA090

⁰³ Supplied until depletion

- Fornibile fino ad esaurimento delle scorte
- Fourni jusqu'à épuisement du stock
- Lieferbar solange vorrat reicht
- Suministrado hasta el stock termina

**SUBARU**

LEGACY I 1.6	--	01/89 ⇨
LEGACY I 1.8	--	01/89 ⇨

EPS 1.331.147

07

DISTRIBUTOR CAPS

Adatt./Suitable: **MITSUBISHI****MITSUBISHI**MD618760
MD618979⁰⁰ Eliminated on 08-06-2020. Please verify the availability through our local distributors

- Eliminato il 08-06-2020. Verificare la disponibilità presso i nostri distributori
- Éliminé le 08-06-2020. Vérifier la disponibilité auprès de nos distributeurs sur place
- Am 08-06-2020 gestrichen. Evtl. Verfügbarkeit bitte bei unseren Händlern prüfen
- Eliminado en fecha 08-06-2020. Verificar la disponibilidad a través de nuestros distribuidores locales

**MITSUBISHI**

GALANT VII 1.8 GLSi	4G93(SOHC16V)	11/92 ⇨ 08/96
GALANT VII 2.0 GLSi	4G63(SOHC16V)	11/92 ⇨ 08/96
GALANT VII 2.0 GLSi 4WD	4G63(SOHC16V)	11/92 ⇨ 08/96

EPS 1.331.149



07,5

DISTRIBUTOR CAPS

Adatt./Suitable: **MITSUBISHI****BOSCH**

F 005 X04 751

MAZDA

KF34-18-V00

⁰³ Supplied until depletion

- Fornibile fino ad esaurimento delle scorte
- Fourni jusqu'à épuisement du stock
- Lieferbar solange vorrat reicht
- Suministrado hasta el stock termina

²¹¹ Resistance [kOhm] 5

- Resistenza [kOhm] 5
- Résistance [kOhm] 5
- Widerstand [kOhm] 5
- Resistencia [kOhm] 5

**FORD AUSTRALIA**

TELSTAR 2.5	KL-ZE	01/92 ⇨ 10/95
TELSTAR 2.5 TX5 EFI	KL-ZE	10/94 ⇨ 11/96

MAZDA

323 VII 2.0 24V	KF	08/94 ⇨ 09/98
626 V 2.5 24V	KL	08/94 ⇨ 04/97
MILLENNIA 2.5i [USA]	--	05/99 ⇨
MX-3 1.8 i V6	K838, K8-ZE	01/94 ⇨ 10/97
MX-6 2.5 24V	KL	02/92 ⇨ 09/97
MX-6 2.5 i 24V	KL	08/94 ⇨ 02/97
XEDOS 9 2.0	KF	08/98 ⇨ 08/00
XEDOS 9 2.0 24V	KF	08/93 ⇨ 01/00
XEDOS 9 2.5 24V	KL	07/93 ⇨ 07/00
XEDOS 9 2.5 V6	KL	07/00 ⇨ 09/02

EPS 1.331.150



04

DISTRIBUTOR CAPS

Adatt./Suitable: **MITSUBISHI****BOSCH**

1 987 233 123

FORD

F4BZ-12106-A

FORD AUSTRALIA

B 593-18-V00 A

KIA

MB593-18V00

MB593-18-V00A

MAZDA

B3S5-18-V00

B593-18-V00

B593-18-V00A

²¹¹ Resistance [kOhm] 5

- Resistenza [kOhm] 5
- Résistance [kOhm] 5
- Widerstand [kOhm] 5
- Resistencia [kOhm] 5

**FORD AUSTRALIA**

LASER 1.6 i	B6(DOHC16V)	10/94 ⇨ 03/99
LASER 1.8 i	BP(DOHC)	10/94 ⇨ 03/99

MAZDA

323 VII C 1.5 16V	Z5-DE	08/94 ⇨ 09/98
323 VII C 1.8 16V	BP-ZE	08/94 ⇨ 09/98
323 VII 1.5 16V	Z5-DE	07/94 ⇨ 09/98
323 VII 1.8 16V	BP-ZE	08/94 ⇨ 09/98
323 VII P 1.5 16V	Z5-DE	10/96 ⇨ 09/98
323 VIII S 1.5 16V	Z5-DE	08/94 ⇨ 09/98
323 VIII S 1.8 16V	BP-ZE	08/94 ⇨ 09/98
DEMIO 1.3 16V	B3ME	08/98 ⇨ 07/03
DEMIO 1.5 16V	B5E	04/00 ⇨ 07/03
MX-3 1.6 i	B6D	11/93 ⇨ 09/98

EPS 1.331.151



07

DISTRIBUTOR CAPS

Adatt./Suitable: **MITSUBISHI****BOSCH**

F 005 X12 624

INFINITI

22162-0M811

NISSAN

22162-0M810

22162-0M811

⁰³ Supplied until depletion

- Fornibile fino ad esaurimento delle scorte
- Fourni jusqu'à épuisement du stock
- Lieferbar solange vorrat reicht
- Suministrado hasta el stock termina

²¹¹ Resistance [kOhm] 5

- Resistenza [kOhm] 5
- Résistance [kOhm] 5
- Widerstand [kOhm] 5
- Resistencia [kOhm] 5

**INFINITI**

G20 2.0	SR20DE	01/90 ⇨ 12/97
---------	--------	---------------

NISSAN

PRIMERA I 2.0	SR20DE	07/94 ⇨ 01/98
---------------	--------	---------------

EPS 1.331.152



07

DISTRIBUTOR CAPS

Adatt./Suitable: **MITSUBISHI****BOSCH**

F 00E 000 232

NISSAN

22162-70F10

22162-70F11

⁰³ Supplied until depletion

- Fornibile fino ad esaurimento delle scorte
- Fourni jusqu'à épuisement du stock
- Lieferbar solange vorrat reicht
- Suministrado hasta el stock termina

²¹¹ Resistance [kOhm] 5

- Resistenza [kOhm] 5
- Résistance [kOhm] 5
- Widerstand [kOhm] 5
- Resistencia [kOhm] 5

**NISSAN**

240SX 2.4	KA24DE	05/94 ⇨ 08/97
-----------	--------	---------------

EPS 1.331.154



07

DISTRIBUTOR CAPS

Adatt./Suitable: **MITSUBISHI****MAZDA**

B3M5-18-V00

⁰⁰ Eliminated on 06-07-2021. Please verify the availability through our local distributors

- Eliminato il 06-07-2021. Verificare la disponibilità presso i nostri distributori
- Éliminé le 06-07-2021. Vérifier la disponibilité auprès de nos distributeurs sur place
- Am 06-07-2021 gestrichen. Evtl. Verfügbarkeit bitte bei unseren Händlern prüfen
- Eliminado en fecha 06-07-2021. Verificar la disponibilidad a través de nuestros distribuidores locales

²¹¹ Resistance [kOhm] 5

- Resistenza [kOhm] 5
- Résistance [kOhm] 5
- Widerstand [kOhm] 5
- Resistencia [kOhm] 5

**MAZDA**

323 VII C 1.3 16V	B3(16V)	08/94 ⇨ 09/98
323 VII P 1.3 16V	B3(16V)	10/96 ⇨ 09/98
323 VIII F 1.4	B3(16V)	01/01 ⇨ 05/04
323 VIII F 1.4 16V	B3ME	09/98 ⇨ 01/01
323 VIII S 1.3	B3(16V)	01/01 ⇨ 05/04
323 VIII S 1.3 16V	B3(16V)	08/94 ⇨ 01/01

EPS 1.331.155



05

DISTRIBUTOR CAPS

Adatt./Suitable: **MITSUBISHI****BOSCH**

1 987 233 114

NISSAN

22162-72Y10

⁰³ Supplied until depletion

- Fornibile fino ad esaurimento delle scorte
- Fourni jusqu'à épuisement du stock
- Lieferbar solange vorrat reicht
- Suministrado hasta el stock termina

**NISSAN**

SUNNY III 1.4	GA14DS	10/90 ⇨ 06/95
SUNNY III 1.4 i	GA14DS	10/90 ⇨ 05/95
SUNNY III 1.6 i	GA16DE, GA16DS	10/90 ⇨ 03/00

EPS 1.331.158



07

DISTRIBUTOR CAPS

Adatt./Suitable: **MITSUBISHI**

BOSCH
1 987 233 124
MITSUBISHI
MD618283
MD619186

⁰³ Supplied until depletion

- Fornibile fino ad esaurimento delle scorte
- Fourni jusqu'à épuisement du stock
- Lieferbar solange vorrat reicht
- Suministrado hasta el stock termina

**MITSUBISHI**

COLT III 1.3 12V	4G13(12V)	04/88 ⇒ 05/92
COLT III 1.3 GL	4G13(8V)	04/88 ⇒ 12/90
COLT V 1.5	301353C	09/95 ⇒ 09/03
COLT V 1.5 16V	301353C	10/99 ⇒ 09/03
LANCER V 1.3	4G13(8V), G13B	04/88 ⇒ 05/92
LANCER V 1.3 12V	4G13(12V)	07/90 ⇒ 07/93
LANCER V 1.5	4G15(12V), 4G15(8V)	04/88 ⇒ 05/92
LANCER VI 1.5	4G15(12V)	09/92 ⇒ 07/96
LANCER VII 1.5	301353C	06/00 ⇒ 08/03
LANCER VII 1.5 16V	301353C	10/99 ⇒ 08/03

EPS 1.331.161



07,5

DISTRIBUTOR CAPS

Adatt./Suitable: **MITSUBISHI**

CHRYSLER
MD61 9050
MITSUBISHI
MD619050

⁰³ Supplied until depletion

- Fornibile fino ad esaurimento delle scorte
- Fourni jusqu'à épuisement du stock
- Lieferbar solange vorrat reicht
- Suministrado hasta el stock termina

²¹¹ Resistance [kOhm] 5

- Resistenza [kOhm] 5
- Résistance [kOhm] 5
- Widerstand [kOhm] 5
- Resistencia [kOhm] 5

**CHRYSLER**

CIRRUS 2.5 LX	EEB	10/94 ⇒ 09/00
SEBRING I 2.5 LE	EEB	05/95 ⇒ 12/96
STRATUS 2.5 LX	625H	04/96 ⇒ 04/01
STRATUS 2.5 LX V6	5RG225	12/95 ⇒ 04/01
STRATUS 2.5 V6	5RG225	12/95 ⇒ 04/01

EPS 1.331.168



05

DISTRIBUTOR CAPS

Adatt./Suitable: **MITSUBISHI**

MITSUBISHI
MD619363
MD619388
MD619468

²¹¹ Resistance [kOhm] 5

- Resistenza [kOhm] 5
- Résistance [kOhm] 5
- Widerstand [kOhm] 5
- Resistencia [kOhm] 5

**MITSUBISHI**

COLT V 1300 GL, GLX	4G13(12V)	05/96 ⇒ 06/00
LANCER VI 1.6 16V	4G92(SOHC16V)	12/92 ⇒ 10/03
LANCER VI 1.6 16V 4WD	4G92(SOHC16V)	12/92 ⇒ 10/03
LANCER VII 1.3 12V	4G13(12V)	12/95 ⇒ 08/03
SPACE STAR 1.3 16V	4G13(16V)	09/00 ⇒ 12/04

EPS 1.331.169



07

DISTRIBUTOR CAPS

Adatt./Suitable: **MITSUBISHI**

MITSUBISHI
MD619092
MD619387

⁰⁰ Eliminated on 18-11-2019. Please verify the availability through our local distributors

- Eliminato il 18-11-2019. Verificare la disponibilità presso i nostri distributori
- Éliminé le 18-11-2019. Vérifier la disponibilité auprès de nos distributeurs sur place
- Am 18-11-2019 gestrichen. Evtl. Verfügbarkeit bitte bei unseren Händlern prüfen
- Eliminado en fecha 18-11-2019. Verificar la disponibilidad a través de nuestros distribuidores locales

²¹¹ Resistance [kOhm] 5

- Resistenza [kOhm] 5
- Résistance [kOhm] 5
- Widerstand [kOhm] 5
- Resistencia [kOhm] 5

**MITSUBISHI**

CARISMA 1.6	4G92(SOHC16V)	07/95 ⇒ 06/06
CARISMA 1.8	4G93(SOHC16V)	07/95 ⇒ 07/97

EPS 1.331.170



04

DISTRIBUTOR CAPS

Adatt./Suitable: **MITSUBISHI**

HYUNDAI
27110-02750

**HYUNDAI**

ATOS 1.0 i	G4HC	02/98 ⇒ 03/02
ATOS PRIME 1.0 i	G4HC	08/99 ⇒

EPS 1.331.172



04

DISTRIBUTOR CAPS

Adatt./Suitable: **DAC**

CHEVROLET
93740943

DAEWOO
329010
93740943

GENERAL MOTORS
93 740 943

**CHEVROLET**

SPARK 1.0.8	F8CV	09/00 ⇒ 12/06
-------------	------	---------------

DAEWOO

MATIZ 0.8	F8CV	08/98 ⇒
-----------	------	---------

EPS 1.338.242



04

DISTRIBUTOR CAPS

Adatt./Suitable: **PAL**

SKODA
113 911 051
113 911 052

**SKODA**

105,120 1.0	33*	08/76 ⇒ 12/89
105,120 1.0 105 S, L	742.10	08/76 ⇒ 12/90
105,120 1.0 105 S, L, GL	742.10	08/76 ⇒ 08/83
105,120 1.0 105 S, L, LS	742.10	10/83 ⇒ 12/90
105,120 1.2	37*, 55*	08/76 ⇒ 12/89
105,120 1.2 120 GLS	742.12X	02/83 ⇒ 12/90
105,120 1.2 120 L	742.12, 742.12X	08/76 ⇒ 12/90
105,120 1.2 120 LS	742.12X	08/76 ⇒ 12/90
130 1.3	43*	01/84 ⇒ 12/88
135 1.3	43*	01/87 ⇒ 12/89
136 1.3	46*	01/87 ⇒ 12/89

1.338.243

SKODA		
FAVORIT 1.3	135B, 136B, 781.135, 781.135E, OHC	08/91 ⇒ 06/97
FAVORIT 1.3 135	781.135	10/90 ⇒ 09/94
FAVORIT 1.3 135 X, LX, GLX	781.135E	01/90 ⇒ 09/94
FAVORIT 1.3 135L	781.135	05/89 ⇒ 09/94
FAVORIT 1.3 136	136L	10/90 ⇒ 09/94

EPS 1.338.243



04

DISTRIBUTOR CAPS

Adatt./Suitable: **PAL**

SKODA
004 026 254 A



SKODA

FELICIA 1.3	061GW4G15K, 135, 135L, 136l	10/94 ⇒ 03/98
-------------	-----------------------------	---------------

EPS 1.342.043



04

DISTRIBUTOR CAPS

Adatt./Suitable: **SEV**

GENERAL MOTORS
7 992 279

RENAULT
08 54 913 400
77 01 020 378

SEV-MARCHAL
S 4010

- ⁰³ Supplied until depletion
- Fornibile fino ad esaurimento delle scorte
 - Fourni jusqu'à épuisement du stock
 - Lieferbar solange vorrat reicht
 - Suministrado hasta el stock termina



RENAULT

40.8	800705	10/83 ⇒ 10/88
------	--------	---------------

EPS 1.347.025



05

DISTRIBUTOR CAPS

Adatt./Suitable: **U.D.S.S.R.**

FIAT
9918275

GENERAL MOTORS
7 992 618

LADA
21010-3706500-00
2101-3706500
2107-3706500
38-37065-00



LADA

LADA 1.2	--	01/80 ⇒
LADA 1.3	--	01/80 ⇒
LADA 1.5	--	01/80 ⇒
NIVA I 1600	BA32121, BA32121	12/76 ⇒ 12/93
RIVA 1.5	--	01/85 ⇒
RIVA 1.6	--	01/85 ⇒

EPS 1.347.027



05

DISTRIBUTOR CAPS

Adatt./Suitable: **U.D.S.S.R.**

LADA
2108-3706500
2108-3706500-10

- ⁰³ Supplied until depletion
- Fornibile fino ad esaurimento delle scorte
 - Fourni jusqu'à épuisement du stock
 - Lieferbar solange vorrat reicht
 - Suministrado hasta el stock termina



LADA

SAMARA 1.5	--	01/97 ⇒
SAMARA 1100	BA321081	02/88 ⇒ 12/94
SAMARA 1300	BA32108	01/86 ⇒ 12/94
SAMARA 1500	BA321083	09/87 ⇒ 12/96



ROTORS

-DISTRIBUTORI -DISRUPTEURS -VERTEILERLÄUFER -ROTORES DEL DISTRIBUIDOR

(A) P/NRS. - NOTES

- CODICI - NOTE
- RÉFS. - NOTES
- ARTIKEL-NR. - ANMERKUNGEN
- CODIGOS - NOTAS

(B) PICTURE + TECHNICAL INFO

- FOTO + INFORMAZIONE TECNICA
- ILLUSTRATION + INFORMATION TECHNIQUE
- BILD + TECHNISCHE INFO
- FOTO + INFORMACIÓN TÉCNICA

(C) APPLICATION LIST

- GUIDA APPLICAZIONI
- LISTE D'APPLICATIONS
- ANWENDUNGSTABELLE
- LISTA DE APLICACIONES

1.430.055R  **1**

ROTORS
Adatt./Suitable: **MARELLI**

ALFA ROMEO **2**
993 817 3
995 004 7

FIAT
9938173

LANCIA
9938173

MAGNETI MARELLI
712 753 01

4 **Resistance Rotor [Ohm] : 1000**
• Rotore resistenza [Ohm] : 1000
• Résistance rotor [ohm] : 1000
• Widerstand-Rotor [Ohm] : 1000
• Resistencia rotor [ohm] : 1000



ALFA ROMEO		
164 2.0 Turbo	AR06476	10/87 ⇨ 09/98
FIAT		
CROMA I 1600	154A.048	12/85 ⇨ 12/90
CROMA I 2000 CHT	154A1.000, 154C5.000	12/85 ⇨ 09/92
CROMA I 2000 i.e. Turbo	154A2.000	12/85 ⇨ 06/90
FIORINO I 1.5	149C1.000	01/88 ⇨ 08/93
FIORINO II 1.5 iE	149C1.000	01/88 ⇨ 10/92
FIORINO II 75 i.e. 1.5	149C1.000	05/88 ⇨ 12/93
REGATA 1.6	--	09/86 ⇨ 06/89
REGATA 100 Super 1.6	149A2.000	10/83 ⇨ 12/90
REGATA 85 1.5	149A5.000	05/85 ⇨ 12/87
RITMO I 1.5	138C2.048	10/85 ⇨ 05/87
RITMO I 1.6	149A4.000	01/83 ⇨ 12/87
RITMO II 75 1.5	138A2.000	09/85 ⇨ 12/88
TEMPRA 1.6	159A3.000, 159A3.048, 159A3.098	03/90 ⇨ 12/96
TEMPRA 1.6 i.e.	159A3.046, 159A3.048	06/90 ⇨ 08/96
TIPO I 1.4	160A1.048	07/87 ⇨ 12/89
TIPO I 1.4 i.e.	160A1.046	05/89 ⇨ 04/95
TIPO I 1.6	160A2.000	01/88 ⇨ 10/92
TIPO I 1.6 SX DGT	159A3.000	05/89 ⇨ 10/95
UNO 1.3 Turbo i.e.	146A2.000	04/85 ⇨ 08/89
UNO 1.4 Super	146C2.028	09/89 ⇨ 09/92
UNO 1.4 Turbo i.e.	146A8.000, 146A8.046	09/89 ⇨ 12/96

(A)

- 1** # EPS
- 2** **OEM P/NRS.**
• CODICI ORIGINALI
• RÉFS. D'ORIGINE
• ORIGINALTEILE-NR.
• CODIGOS ORIGINALES
- 3** **PACKAGING SIZE**
• FORMATO CONFEZIONE
• FORMAT DU CONDITIONNEMENT
• ABPACKENSGROESSE
• TAMAÑO DEL ENVASE
- 4** **NOTE**
• NOTE
• NOTES
• BERMERKUNGEN
• NOTAS



1 **PICTURE**
• FOTO
• PHOTO
• BILD
• FOTO

(B)

1.406.012R

EPS 1.406.012R



1

ROTORS

Adatt./Suitable: BOSCH

ALFA ROMEO

700 218
105 48 05 011 00/01
140 20 05 011 00/03
60739128

²¹² Resistance Rotor [Ohm] 5000

- Rotore resistenza [Ohm] 5000
- Résistance rotor [ohm] 5000
- Widerstand-Rotor [Ohm] 5000
- Resistencia rotor [ohm] 5000

BMW

12 11 1 351 447
12 11 1 354 503
12 11 8 630 144

BOSCH

1 234 332 033
1 234 332 074
1 234 332 902

DAF

163792

FORD

0 425 981
1 142 596 1
1 142 598 1
1 451 676
71HM-12200-AA
DIFZ-12200-A

GENERAL MOTORS

06 682 671
7 992 284
7 992 285

Motorcraft

EDR 12
EDR 12 D
EDR 12 S
EDR 40
EDR 40 D

OPEL

17 84 226
17 84 235

PORSCHE

901 602 928 00

RENAULT

77 01 012 535
77 02 037 713

SAAB

78 63 236

VOLVO

240247
2402477
240305
2403053

VW

181 905 225



FORD

CAPRI III 1.3	J1E	01/78 ⇒ 06/85
TRANSIT I 1.6	4RB	11/77 ⇒ 10/86
TRANSIT I 2.0	4RC	11/77 ⇒ 07/82

FORD AUSTRALIA

CORTINA 2.0	--	06/77 ⇒ 08/82
ESCORT 2.0	--	01/77 ⇒ 12/81
ESCORT 2.0 RS	--	01/77 ⇒ 12/81

OPEL

CORSA A 1.0	10S	09/82 ⇒ 03/93
CORSA A 1.2	12N, 12NC	09/82 ⇒ 08/90
CORSA A 1.2 N	12NC	01/85 ⇒ 10/87
KADETT B 1.1	11N	08/71 ⇒ 08/73
KADETT D 1.0	10N	09/79 ⇒ 08/82
KADETT E 1.2	12SC	09/84 ⇒ 07/86
MANTA B 1.3 N	13N	03/79 ⇒ 12/80
MANTA B 1.6 S	16S	09/75 ⇒ 12/81
MANTA B 1.9 N	19N	08/76 ⇒ 12/81
MANTA B 2.0	20N	08/77 ⇒ 12/80

RENAULT

FUEGO 1.6 [USA] R1368	A7L752	01/82 ⇒ 12/84
-----------------------	--------	---------------

EPS 1.406.014R



1

ROTORS

Adatt./Suitable: BOSCH

BOSCH

1 234 332 076
1 234 332 082
1 234 332 089

²¹² Resistance Rotor [Ohm] 5000

- Rotore resistenza [Ohm] 5000
- Résistance rotor [ohm] 5000
- Widerstand-Rotor [Ohm] 5000
- Resistencia rotor [ohm] 5000

FORD

0 425 469
1 142 546 9

GENERAL MOTORS

7 992 286
7 992 640
7 992 887

VW

111 905 225 F
111 905 225 G



PEUGEOT

204 1.1	XK, XK4, XK5	10/65 ⇒ 07/77
204 1.1 Grand Luxe	XK4	05/69 ⇒ 10/77
304 1.1	XK5	10/76 ⇒ 10/80
304 1.3	XL3, XL3S, XL5	03/70 ⇒ 10/80
304 1.3 GL	XL5	09/72 ⇒ 10/79
304 1.3 GT	XL3	10/69 ⇒ 09/75
404 1.6	XC6	04/63 ⇒ 12/71
404 1.6 GT	XC6	07/71 ⇒ 12/71
504 1.8	XM7	01/71 ⇒ 07/86
504 2.0	106(XN1)	03/71 ⇒ 07/86
505 1.8	105(XM7)	06/81 ⇒ 10/85
505 2.0	106(XN1)	11/80 ⇒ 12/85

RENAULT

12 1.3	810.02, 810-02/97	10/69 ⇒ 08/80
--------	-------------------	---------------

TOYOTA

STARLET 1.0	6A25BFXS	02/78 ⇒ 09/84
STARLET 1.2 S	3K-H	10/78 ⇒ 08/82

VW

1500,1600 1.5	K	04/61 ⇒ 07/73
1500,1600 1.5 S	--	08/63 ⇒ 07/65
1500,1600 1.6	T, U	08/65 ⇒ 07/73
1500,1600 1.6 L	T, U	08/65 ⇒ 07/73
1500,1600 1.6 TL	T, U	08/65 ⇒ 07/73
KAEFER 1300 1.3	E	08/65 ⇒ 07/70
KAEFER 1500 1.5	4SC20M1500G	08/66 ⇒ 11/73

ROTORS

Adatt./Suitable: BOSCH

BOSCH

1 234 332 024
1 234 332 029
1 234 332 030
1 234 332 062
1 234 332 072
1 234 332 087
1 234 332 088

²¹² Resistance Rotor [Ohm] 5000

- Rotore resistenza [Ohm] 5000
- Résistance rotor [ohm] 5000
- Widerstand-Rotor [Ohm] 5000
- Resistencia rotor [ohm] 5000

DAF

52 84 20

GENERAL MOTORS

7 992 289
7 992 878
7 992 883

INTERNATIONAL HARV.

883092R91

MERCEDES-BENZ

A 000 158 15 31
A 000 158 20 31

PORSCHE

616 602 221 00

VW

111 905 225 B
111 905 225 C
892 031 520



BMW

1500-2000 2000	18F209	09/68 ⇒ 07/72
1502-2002 2002	M10B20A	02/68 ⇒ 07/75

BORGHARD

ISABELLA 1.5	--	06/54 ⇒ 02/62
--------------	----	---------------

FORD

TAUNUS 17M 1.7	--	08/57 ⇒ 11/60
----------------	----	---------------

MERCEDES-BENZ

/8 230.6	M180.954	01/68 ⇒ 11/76
/8 250	M114.920	01/68 ⇒ 08/72
/8 250 2.8	M130.923	06/72 ⇒ 11/76
/8 250 C	M114.920	04/69 ⇒ 06/72
/8 250 C 2.8	M130.923	06/72 ⇒ 11/76
CLASSE S I 250 S	M108.920	01/66 ⇒ 12/69
CLASSE S I 250 SE	M129.980	01/66 ⇒ 12/67
CLASSE S I 280 S	M130.920	10/67 ⇒ 07/72
CLASSE S I 280 SE, SEL	M130.980	01/68 ⇒ 08/72
CLASSE SL I 190 SL	M121.921, M121.928	01/55 ⇒ 12/63
COUPE 220 SEB	M127.984	01/61 ⇒ 12/65
COUPE 250 SE	M129.980, M129.981	01/65 ⇒ 12/67
HECKFLOSSE 190 C	M121.924	04/61 ⇒ 08/65
HECKFLOSSE 200	M115.926, M121.940	07/65 ⇒ 02/68
HECKFLOSSE 220 B	M180.940	08/59 ⇒ 08/65
HECKFLOSSE 220 SB	M180.941	08/59 ⇒ 08/65
HECKFLOSSE 220 SEB	M127.982	08/59 ⇒ 08/65
HECKFLOSSE 230	M180.945, M180.949, M180.950	07/65 ⇒ 02/68
HECKFLOSSE 230 S	M180.947, M180.950	07/65 ⇒ 01/68
PAGODE 230 SL	M127.981	01/63 ⇒ 01/67
PAGODE 250 SL	M129.982	01/66 ⇒ 01/68
PAGODE 280 SL	M130.983	01/68 ⇒ 03/71
PONTON 220	M180.921	01/54 ⇒ 12/56
PONTON 220 S	M180.924	01/56 ⇒ 12/59

PORSCHE

356 C 1600 SC	--	01/63 ⇒ 12/65
---------------	----	---------------

VW

KAEFER 1.2	M51	01/54 ⇒ 07/65
------------	-----	---------------

EPS 1.406.021R



ROTORS

Adatt./Suitable: **BOSCH****BOSCH**

1 234 332 106
1 234 332 107
1 234 332 109

⁰³ Supplied until depletion

- Fornibile fino ad esaurimento delle scorte
- Fourni jusqu'à épuisement du stock
- Lieferbar solange vorrat reicht
- Suministrado hasta el stock termina

DAF

22 45 66

GENERAL MOTORS7 992 290
7 992 888**MERCEDES-BENZ**

A 000 158 21 31

PORSCHE

616 602 221 05

VOLVO076978
0769786**VW**059 905 225
113 905 225 E

AUDI			
100 III 1.8	DR, DS, JW, NP, RS	08/82 ⇨	07/89
100 III 1.8 quattro	JW, NP	10/84 ⇨	07/88
MERCEDES-BENZ			
/8 200	M115.923, M115.926	01/68 ⇨	01/77
COUPE 280 SE	M130.980, M130.984	01/67 ⇨	12/71
NSU			
1000 C	--	08/63 ⇨	12/72
PORSCHE			
356 A 1600	--	01/55 ⇨	12/59
356 A 1600 S	616.15	01/55 ⇨	12/59
356 A 1600 Super	616.15	01/55 ⇨	12/59
356 B 1600	--	09/59 ⇨	08/63
356 B 1600 Super 75	616.15	01/59 ⇨	12/63
356 B 1600 Super 90	--	01/59 ⇨	12/63
356 C 1600 SC	--	01/63 ⇨	12/65
SAAB			
900 I 2.0 Turbo	B201XL	01/86 ⇨	12/91
VW			
KAEFER 1200 1.2	D	01/60 ⇨	12/85
KAEFER 1300 1.3	AB	01/70 ⇨	01/73
KAEFER 1302 1.3	AB	08/70 ⇨	08/72
KAEFER 1302 1.6	AD	01/70 ⇨	01/73
KAEFER 1500 1.5	45C20M150Q6	01/66 ⇨	12/70
KARMANN GHIA 1500	45C20M150Q6	01/66 ⇨	12/69
KARMANN GHIA 1600	AD	01/70 ⇨	12/73

EPS 1.406.023R



ROTORS

Adatt./Suitable: **BOSCH****BOSCH**

1 234 332 177

FIAT
9939707**GENERAL MOTORS**

7 992 985

LANCIA

9939707

MERCEDES-BENZ

A 000 158 23 31

PEUGEOT

5937 21

PORSCHE

928 602 904 03

RENAULT

77 01 021 905

VOLVO243922
2439222²¹² Resistance Rotor [0hm] 5000

- Rotore resistenza [0hm] 5000
- Résistance rotor [ohm] 5000
- Widerstand-Rotor [0hm] 5000
- Resistencia rotor [ohm] 5000



ALPINE			
V6 GT	Z6W	01/85 ⇨	12/90
LANCIA			
THEMA 2850 V6 i.e.	834E.000	11/84 ⇨	09/88
MERCEDES-BENZ			
CLASSE S II 380 SE, SEL	M116.961	09/80 ⇨	10/81
CLASSE S II 500 SE, SEL	M117.961	12/79 ⇨	08/85
CLASSE SL III 380 SL	M116.960	09/80 ⇨	08/81
RENAULT			
25 2.7 V6 Injection	Z7V708, Z7V709, Z7V711	04/84 ⇨	08/89
25 2.8 V6 Injection	Z7W702	06/86 ⇨	02/88
VOLVO			
240 2.8	B28E	10/80 ⇨	09/84
260 2.8	B28E	08/80 ⇨	07/85
760 2.8	B28A, B28E, B28F	08/81 ⇨	07/88

EPS 1.406.024R



ROTORS

Adatt./Suitable: **BOSCH****ALFA ROMEO**119 11 05 011 00/02
60735860**BMW**12 11 1 267 464
12 11 1 360 306**BOSCH**1 234 332 173
1 234 332 197
1 234 332 236
1 234 332 237
1 234 332 332**FORD**1 604 959
6002 610
72TF-12200-AA
73TF-12200-AA
82TF-12200-AA**GENERAL MOTORS**

7 992 630

MAN

51.26310-0002

MERCEDES-BENZ

A 000 158 22 31

MotorcraftEDR 23
EDR 49
EDR 113**OPEL**

1 46 015

PORSCHE

930 602 902 00

VOLVO243657
2436574**VW**

073 905 225



ALFA ROMEO		
6 2.0	AR01932	07/81 ⇨ 12/86
MERCEDES-BENZ		
CLASSE G I 280 GE	M110.994	11/79 ⇨ 08/89
CLASSE G II 280 GE	M110.994	04/92 ⇨
TRE VOLUMI I 280 E	M110.984	02/76 ⇨ 11/85
PUCH		
G-MODELL 280 GE	M110.994	01/86 ⇨ 12/91

EPS 1.406.025R



ROTORS

Adatt./Suitable: BOSCH

ALFA ROMEO

116 36 05 011 01/01
9927967
9950021

212 Resistance Rotor [Ohm] 5000

- Rotore resistenza [Ohm] 5000
- Résistance rotor [ohm] 5000
- Widerstand-Rotor [Ohm] 5000
- Resistencia rotor [ohm] 5000

BOSCH

1 234 332 213
1 234 332 215
1 234 332 261

DAF

744625

FIAT

38326383
638326383
82288614
82316498
9927962
9927967
AXE2056

FORD

1 606 399
3 240 335
5 027 532
78MU-12200-A
82HF-12200-AA

GENERAL MOTORS

9 977 034
90 114 107

INNOCENTI

638326383

LANCIA

9927962

MERCEDES-BENZ

A 000 158 27 31
A 000 158 31 31

Motorcraft

DR 22
EDR 109

PEUGEOT

5937 32

PORSCHE

923 602 929 00

RENAULT

77 02 038 439

SAAB

83 55 950
93 06 697

SEAT

NG9 810 462 9

TALBOT

0013 52 9900
1352 99 00
1832 20 01

VOLVO

243796
243903
2439032

VW

027 905 225
043 905 225
181 905 225 C
ZBA 905 225 B

ALFA ROMEO

ALFETTA 1.8 AR01608X 07/74 ⇒ 04/82
GIULIETTA I 1.3 AR01644 10/77 ⇒ 06/83

FIAT

132 2.0 132C2.000 01/76 ⇒ 06/81
DUCATO I 1.8 169B 01/82 ⇒ 12/88
ARGENTA 2000 132D1.000 06/78 ⇒ 12/85

FIAT (BR)

147 1.1 -- 01/82 ⇒ 12/84

FORD

CORTINA 1300 KL13H 10/70 ⇒ 03/72
ESCORT III 1.1 GSE 08/83 ⇒ 12/85
FIESTA I 0.9 TKA, TKW, TLA 05/76 ⇒ 08/83
FIESTA I 1.1 GLA, GLW 05/76 ⇒ 08/83
FIESTA I 1.6 XR2 L3E 08/81 ⇒ 08/83
FIESTA II 1.1 GLC, GSF 09/83 ⇒ 02/89
FIESTA II 1.3 JPC 09/83 ⇒ 09/89
SIERRA I 1.3 JCT 08/82 ⇒ 12/86
SIERRA I 2.0 NET, NYT 08/82 ⇒ 12/86
P 100 2.0 NAE 10/87 ⇒ 12/92
TRANSIT II 1.6 LAC, LAT 09/85 ⇒ 09/92
TRANSIT II 2.0 NAT, NAV, NAW, NBA, NCA 09/85 ⇒ 09/94
TRANSIT II 2.0 i NCA 09/91 ⇒ 07/94
TRANSIT II 2.0 L NAW, NAX 10/85 ⇒ 03/91

INNOCENTI

MINI 120 -- 01/75 ⇒ 12/83

LANCIA

BETA 1600 8288.000 08/73 ⇒ 07/82

MERCEDES-BENZ

0 309 M115.952 01/68 ⇒ 02/89

PEUGEOT

205 I 1.5 Y2/K 02/84 ⇒ 10/87
309 I 1.5 Y2/K 06/87 ⇒ 12/89

PORSCHE

924 2.0 Turbo M31.03 06/80 ⇒ 10/86

TALBOT

1307-1510 Simca 1307 1.3 -- 07/75 ⇒ 01/80

SIMCA 1309 -- 01/78 ⇒ 12/86

SOLARA 1.3 2M102.979 02/80 ⇒ 07/86

VOLVO

240 1.8 B17A 11/78 ⇒ 07/85

240 2.0 OJX4G20A6L, B19ET 08/74 ⇒ 08/84

240 2.1 Turbo B21ET, B21FT 08/80 ⇒ 07/85

VW

JETTA II 1.6 EZ 01/84 ⇒ 07/92

CADDY I 1.6 EW, HN 01/83 ⇒ 07/92

GOLF II 1.6 EZ 08/83 ⇒ 07/92

GOLF II 1.6 (CHE) [SWE] HM 08/83 ⇒ 07/85

EPS 1.406.026R



ROTORS

Adatt./Suitable: BOSCH

BOSCH

1 234 332 216
1 234 332 285

212 Resistance Rotor [Ohm] 5000

- Rotore resistenza [Ohm] 5000
- Résistance rotor [ohm] 5000
- Widerstand-Rotor [Ohm] 5000
- Resistencia rotor [ohm] 5000

FIAT

9935782

GENERAL MOTORS

7 992 986
90 087 360
94 632 557

OPEL

12 12 213

PEUGEOT

5937 51
5940 52

SAAB

93 50 323
93 55 488

VW

052 905 225



OPEL

ASCONA C 1.3 N 13N 09/81 ⇒ 08/86

KADETT D 1.3 S 13S 08/79 ⇒ 08/84

PEUGEOT

106 I 1.1 HDZ(TU1M) 09/91 ⇒ 04/96

106 I 1.4 K5A(TU3), TU3.2 08/91 ⇒ 03/96

205 II 1.1 HDZ(TU1M) 07/89 ⇒ 09/98

205 II 1.4 KDY(TU3M), KDZ(TU3M) 07/88 ⇒ 09/98

205 II 1.4 CJ KDY(TU3M), KDZ(TU3M) 05/91 ⇒ 12/94

306 1.4 TU3 01/93 ⇒ 04/97

309 I 1.4 KDY(TU3M), KDZ(TU3M) 03/89 ⇒ 07/89

309 II 1.1 HDZ(TU1M) 08/90 ⇒ 12/93

309 II 1.4 KDZ(TU3M), TU3F2 07/89 ⇒ 12/93

309 II 1.6 XUSJA 07/89 ⇒ 12/93

309 II 1.6 GTi -- 09/89 ⇒ 10/93

405 I 1.4 TU3F2 01/87 ⇒ 12/92

405 I 1.9 D2C(XU92C) 07/87 ⇒ 12/92

405 II 1.4 TU3F2 01/93 ⇒ 12/96

405 II 1.9 XU92C 01/93 ⇒ 12/96

SAAB

90 2.0 B20I 08/84 ⇒ 08/87

900 I 2.0 c B201XC 09/79 ⇒ 12/88

900 I 2.0 i OTL4G15, B201XI 11/80 ⇒ 08/90

900 I 2.0 Turbo B201XL 01/86 ⇒ 12/91

VW

DERBY 1.1 HB 02/77 ⇒ 09/81

DERBY 1.3 HH 02/77 ⇒ 09/81

POLO II 1.1 HB 10/81 ⇒ 09/89

POLO II 1.3 GT, HH, HJ 10/81 ⇒ 07/88

EPS

1.406.027R



ROTORS

Adatt./Suitable: BOSCH

BMW

12 11 1 355 211
12 11 1 360 305
12 11 1 362 221
12 12 1 355 211

03 Supplied until depletion

- Fornibile fino ad esaurimento delle scorte
- Fourni jusqu'à épuisement du stock
- Lieferbar solange vorrat reicht
- Suministrado hasta el stock termina

BOSCH

1 234 332 208
1 234 332 280
1 234 335 280

GENERAL MOTORS

7 992 638

VW

055 905 225

212 Resistance Rotor [Ohm] 5000

- Rotore resistenza [Ohm] 5000
- Résistance rotor [ohm] 5000
- Widerstand-Rotor [Ohm] 5000
- Resistencia rotor [ohm] 5000

310 RPM to [1/min] 6600

- N° giri fino a [1/min.] 6600
- Régime mot. jusqu'à [1/min] 6600
- Drehzahl bis [1/min] 6600
- vel. giro hasta [1/min] 6600



VW

SCIROCCO II 1.6 1HyFAD 08/80 ⇒ 04/84

EPS

1.406.034R



ROTORS

Adatt./Suitable: BOSCH

BOSCH

1 234 332 204

GENERAL MOTORS

93 150 102

MERCEDES-BENZ

A 000 158 26 31

00 Eliminated on 05-10-2021. Please verify the availability through our local distributors

- Eliminato il 05-10-2021. Verificare la disponibilità presso i nostri distributori
- Éliminé le 05-10-2021. Vérifier la disponibilité auprès de nos distributeurs sur place
- Am 05-10-2021 gestrichen. Evtl. Verfügbarkeit bitte bei unseren Händlern prüfen
- Eliminado en fecha 05-10-2021. Verificar la disponibilidad a través de nuestros distribuidores locales

03 Supplied until depletion

- Fornibile fino ad esaurimento delle scorte
- Fourni jusqu'à épuisement du stock
- Lieferbar solange vorrat reicht
- Suministrado hasta el stock termina

212 Resistance Rotor [Ohm] 5000

- Rotore resistenza [Ohm] 5000
- Résistance rotor [ohm] 5000
- Widerstand-Rotor [Ohm] 5000
- Resistencia rotor [ohm] 5000

310 RPM to [1/min] 6650

- N° giri fino a [1/min.] 6650
- Régime mot. jusqu'à [1/min] 6650
- Drehzahl bis [1/min] 6650
- vel. giro hasta [1/min] 6650



MERCEDES-BENZ

CLASSE G I 280 GE M110.994 11/79 ⇒ 08/89

CLASSE G II 280 GE M110.994 04/92 ⇒

MERCEDES-BENZ

CLASSE S II 280 S	M110.924	12/79 ⇒ 07/85
CLASSE SL III 280 SL	M110.986	06/76 ⇒ 09/81
CLASSE SL III 280 SLC	M110.986	06/76 ⇒ 09/81
TRE VOLUMI I 280 E	M110.984	02/76 ⇒ 11/85

PUCH

G-MODELL 280 GE	M110.994	01/86 ⇒ 12/91
-----------------	----------	---------------

EPS 1.406.045R



ROTORS

Adatt./Suitable: BOSCH

BOSCH

9 231 081 628

FIAT

7073054

GENERAL MOTORS

9 300 152

VW

040 905 225

71 314 347

Eliminated on 22-02-2022. Please verify the availability through our local distributors

• Eliminato il 22-02-2022. Verificare la disponibilità presso i nostri distributori

• Eliminé le 22-02-2022. Vérifier la disponibilité auprès de nos distributeurs sur place

• Am 22-02-2022 gestrichen. Evtl. Verfügbarkeit bitte bei unseren Händlern prüfen

• Eliminado en fecha 22-02-2022. Verificar la disponibilidad a través de nuestros distribuidores locales

212 Resistance Rotor [Ohm] 5000

- Rotore resistenza [Ohm] 5000
- Résistance rotor [ohm] 5000
- Widerstand-Rotor [Ohm] 5000
- Resistencia rotor [ohm] 5000



FIAT (BR)

147 1.1	--	01/76 ⇒ 12/81
PREMIO	--	01/85 ⇒ 12/88
UNO 1.05	1.05	01/85 ⇒ 12/87
UNO 1.3	1.3	01/85 ⇒ 12/91
UNO 1.3 Furgoneta	1.3	01/85 ⇒ 12/91
UNO CS 1.3	1.3	01/85 ⇒ 12/91

VOLKSWAGEN (BR)

VWB 1.5	--	01/75 ⇒ 12/82
---------	----	---------------

EPS 1.406.049R



ROTORS

Adatt./Suitable: BOSCH

BOSCH

1 234 332 282

1 234 332 337

MERCEDES-BENZ

A 000 158 36 31

PEUGEOT

5937 26

212 Resistance Rotor [Ohm] 1000

- Rotore resistenza [Ohm] 1000
- Résistance rotor [ohm] 1000
- Widerstand-Rotor [Ohm] 1000
- Resistencia rotor [ohm] 1000



MERCEDES-BENZ

CLASSE S II 380 SE, SEL	M116.963	10/81 ⇒ 08/85
CLASSE S II 380 SEC	M116.963	10/81 ⇒ 07/85
CLASSE S II 500 SE, SEL	M117.963	12/79 ⇒ 08/85
CLASSE S II 500 SEC	M117.963	08/80 ⇒ 08/85
CLASSE SL III 380 SL	M116.962	09/80 ⇒ 08/85

PEUGEOT

604 2.7 SL	112(ZM)	08/77 ⇒ 05/83
604 2.7 TI, STI	140(ZMJ)	08/77 ⇒ 05/83

TALBOT

TAGORA 2.6	9L6	08/81 ⇒ 10/83
------------	-----	---------------

EPS 1.406.055R



ROTORS

Adatt./Suitable: BOSCH

ALFA ROMEO

115 44 05 011 00/02
60723008
60752000

AUDI

035 905 225 B
055 905 225 B

BMW

12 111 1 272 144

BOSCH

1 234 332 300
1 234 332 301
1 234 332 309
1 234 332 359

GENERAL MOTORS

90 141 495

MERCEDES-BENZ

A 000 158 34 31

OPEL

12 12 216

PEUGEOT

5937 31

PORSCHE

931 602 906 00

SAAB

75 19 309

SEAT

055 905 225 B

SKODA

115 911 400

VOLVO

1336240

13362405

1336241

13362413

VW

026 905 225 1

035 905 225 B

055 905 225 B



ALFA ROMEO

75 1.6	AR06100	05/85 ⇒ 09/89
75 1.8	AR06168	09/88 ⇒ 02/92
SPIDER I 1600	AR00526, AR01563	03/76 ⇒ 12/93
SPIDER I 2000	AR01544	08/86 ⇒ 12/90

AUDI

80 II 1.3	EP	09/78 ⇒ 07/86
80 II 1.6	DT, JU, SA, WV	08/78 ⇒ 03/87
80 II 1.8	DS, JN, SF	01/83 ⇒ 08/86
80 II 1.8 CC quattro	JN, JV	08/84 ⇒ 08/86
80 II 1.8 GTE	DZ, MU	06/84 ⇒ 03/87
80 II 2.0	HP, JS	10/83 ⇒ 09/84
80 II 2.0 quattro	JS	10/83 ⇒ 09/84
80 III 1.4	SE	08/86 ⇒ 07/88
80 III 1.6	ABB, PP, RN, RNA	09/86 ⇒ 10/91
80 III 1.8	RU	10/86 ⇒ 01/90
80 III 1.8 E	DZ	06/86 ⇒ 08/91
80 III 1.8 S	JN, JV, NE, PM, SF	08/86 ⇒ 10/91
80 III 1.8 S quattro	JN	09/86 ⇒ 09/91
80 IV 1.6	ABB	03/92 ⇒ 05/93
90 I 1.8	JN	06/84 ⇒ 03/87
90 I 2.0	HP, JL, JS	10/84 ⇒ 03/87
90 I 2.0 quattro	JS	08/84 ⇒ 08/86
90 I 2.2	KX	01/85 ⇒ 03/87
90 II 2.0	PS	07/88 ⇒ 09/91
90 II 2.2 E	9CS4	04/87 ⇒ 07/91
90 II 2.2 E quattro	9CS4	04/87 ⇒ 09/91
100 III 1.8	DR, DS, JW, NP, SH	08/82 ⇒ 12/90
100 III 1.8 Cat	4B, PH	03/85 ⇒ 11/90
100 III 1.8 Cat quattro	4B	08/85 ⇒ 11/90
100 III 1.8 quattro	NP, SH	10/84 ⇒ 07/90
100 III 2.0	KP	08/84 ⇒ 12/87
100 III 2.0 Cat	RT	01/88 ⇒ 11/90
100 III 2.0 E	KP	01/85 ⇒ 12/87
100 III 2.0 E Cat	RT	01/88 ⇒ 11/90
100 III 2.2 Cat	KU	06/89 ⇒ 11/90
100 III 2.2 Cat quattro	KU	06/89 ⇒ 11/90
100 IV 1.6	ABB	03/92 ⇒ 07/93
200 II 2.2 Turbo quattro	MC	01/85 ⇒ 12/91
COUPE 1.8	DZ	08/89 ⇒ 07/91
COUPE 2.2	9CS4	11/88 ⇒ 07/91
COUPE 2.2 GT	9CS4	09/84 ⇒ 10/88
COUPE 2.2 quattro	9CS4, JT	10/84 ⇒ 07/91

BMW

3 I 316 i	M10B18(184KA)	08/87 ⇒ 08/88
3 I 318 i	M10B18(184EA), M10B18(184KA)	09/82 ⇒ 08/88
5 I 518 i	M10B18(184EB)	05/81 ⇒ 12/87

MERCEDES-BENZ

124 200 CE	M102.963	09/89 ⇒ 06/93
124 230 CE	M102.982	03/87 ⇒ 12/92
124 230 CE Cat	M102.982	06/89 ⇒ 12/92
190 2.0	M102.921, M102.924	10/82 ⇒ 05/90
190 2.3	M102.985	09/87 ⇒ 09/88
190 2.3 E	M102.985	10/82 ⇒ 09/88
190 E 2.0	M102.962	10/82 ⇒ 08/93
190 E 2.3	M102.985	09/86 ⇒ 08/93
CLASSE G I 200 GE	M102.964	02/80 ⇒ 08/92
CLASSE G I 230 GE	M102.981, M102.987	04/82 ⇒ 08/92
CLASSE G II 230 G	M102.958	04/92 ⇒
CLASSE G II 230 GE	M102.981, M102.996, M102.997	04/92 ⇒

KOMBI I 200 T	M102.920, M102.939	11/80 ⇒ 11/85
KOMBI II 200 T	M102.922	09/85 ⇒ 05/90
KOMBI II 200 TE	M102.962, M102.963	09/88 ⇒ 08/92
KOMBI II 230 E Chassis	M102.982	09/86 ⇒ 06/93
KOMBI II 230 TE	M102.982	09/85 ⇒ 08/92
KOMBI II 230 TE Cat	M102.982	06/89 ⇒ 08/92
O 309	M102.943	01/68 ⇒ 02/89
T1 210 2.3	M102.942, M102.945	04/77 ⇒ 02/96
T1 310 2.3	M102.942, M102.945	08/82 ⇒ 02/96
T1 410 2.3	M102.942, M102.945	08/82 ⇒ 06/95
T2/LN1 510	M102.946	04/86 ⇒ 12/94
TRE VOLUMI II 200	M102.922	12/85 ⇒ 10/92
TRE VOLUMI II 200 E	M102.963	09/88 ⇒ 08/93
TRE VOLUMI II 230 E	M102.982	12/84 ⇒ 06/93
TRE VOLUMI II 230 E Cat	M102.982	06/89 ⇒ 06/93

OPEL

MANTA B 1.3 S	13S	08/81 ⇒ 08/86
---------------	-----	---------------

PEUGEOT

505 2.0	106E(XN1A)	09/85 ⇒ 09/95
505 2.1 i	XN9T	01/83 ⇒ 12/88
505 2.2	851(ZDJ), 851X(ZDJL)	05/81 ⇒ 12/93
505 2.2 GTI	851B(ZDJL)	08/83 ⇒ 12/93

PUCH

G-MODELL 230 GE	M102.981, M102.987, M102.996	03/79 ⇒ 07/00
-----------------	---------------------------------	---------------

SAAB

9000 2.0 -16 Turbo	B202XL	09/84 ⇒ 08/93
9000 2.0 -16 Turbo CD	B202XL	09/88 ⇒ 08/93

SEAT

TOLEDO I 1.6 i	1F, ABN, EZ	05/91 ⇒ 03/99
TOLEDO I 1.8 i	RP	05/91 ⇒ 12/96

SKODA

FELICIA 1.3	061GW4G15K	10/94 ⇒ 07/96
-------------	------------	---------------

VOLKSWAGEN (BR)

GOL 1.6	504, 505	09/94 ⇒ 01/97
GOL 1.8	521, 522	04/94 ⇒ 01/97
GOL 2.0i	528, 529	09/94 ⇒ 01/97
LOGUS 1.6	504, 505	10/94 ⇒ 12/96
LOGUS 1.8	524, 525, 599	12/92 ⇒ 12/96
LOGUS 2.0	653	11/93 ⇒ 05/94
LOGUS 2.0i	526, 527	05/94 ⇒ 12/96
PARATI 1.6	504, 505	08/95 ⇒ 01/97
PARATI 1.8	521	08/95 ⇒ 01/97
PARATI 2.0i	528, 529	08/95 ⇒ 01/97
POINTER 1.8	524, 525, 599	11/93 ⇒ 12/96
POINTER 2.0	653	12/92 ⇒ 05/94
POINTER 2.0i	526, 527	05/94 ⇒ 12/96

VOLVO

240 2.3	B230F	08/86 ⇒ 07/87
240 2.3 i Cat	B230F	08/86 ⇒ 07/93
760 2.3 Turbo	B23ET, B23FT	08/82 ⇒ 07/84

VW

PASSAT II 1.6	DT	08/80 ⇒ 03/88
PASSAT II 1.8	DS	01/83 ⇒ 03/88
PASSAT II 1.8 Syncro	DS	01/86 ⇒ 03/88
PASSAT II 2.0	JS	08/83 ⇒ 03/88
PASSAT II 2.0 Syncro	JS	05/84 ⇒ 03/88
PASSAT II 2.2	KX	01/85 ⇒ 03/88
JETTA II 1.6	ABN, EZ, EZA, HM, PN, RF	12/83 ⇒ 07/92
JETTA II 1.8	EV, GU, GX, RH	01/84 ⇒ 10/91
JETTA II 1.8 Cat	GX, RP	08/87 ⇒ 10/91
JETTA II 1.8 Syncro	GU, RP	08/87 ⇒ 12/88
JETTA II 1.8i GT	GZ	12/83 ⇒ 07/88
CADDY I 1.5	JB	08/82 ⇒ 07/83
CADDY I 1.6	EW, HN	01/83 ⇒ 07/92
CADDY I 1.8	JH	08/85 ⇒ 07/92
GOLF I 1.6	EW, HN	08/83 ⇒ 04/92
GOLF I 1.8	DX, EX, JH, KT	08/82 ⇒ 04/93
GOLF II 1.6	ABN, EZ, PN, RF	08/83 ⇒ 12/92
GOLF II 1.6 [CHE] [SWE]	HM	08/83 ⇒ 07/88
GOLF II 1.6 G	EZA, PN	08/86 ⇒ 07/91

VW			
GOLF II 1.8	GU, GX, RH	08/84 ⇒ 10/91	
GOLF II 1.8 [CHE] [SWE]	HV	08/86 ⇒ 07/87	
GOLF II 1.8 GTI	EV	08/83 ⇒ 10/91	
GOLF II 1.8 i	RP	08/87 ⇒ 07/91	
GOLF II 1.8 i Cat	GX, RP	08/87 ⇒ 10/91	
GOLF II 1.8 i Cat Syncro	RP	08/87 ⇒ 10/91	
GOLF II 1.8 Syncro	GU, GX	02/86 ⇒ 07/91	
GOLF II 1.8i GTI [CHE] [SWE]	GZ	08/85 ⇒ 07/87	
GOLF II 1.8i GTI [SWE]	GZ	08/87 ⇒ 07/88	
PASSAT III 1.6	1F, ABN, EZ	04/88 ⇒ 07/92	
PASSAT III 1.8	RP	02/88 ⇒ 05/97	
QUANTUM 1.7	--	01/85 ⇒ 12/87	
QUANTUM 2.1	--	01/81 ⇒ 12/89	
SANTANA 1.6	DT	08/81 ⇒ 12/84	
SANTANA 1.8	DS	01/83 ⇒ 12/84	
SCIROCCO I 1.5	JB	08/77 ⇒ 07/80	
SCIROCCO II 1.6	EW, EWA, HN, RE	01/83 ⇒ 07/90	
SCIROCCO II 1.8	DX, EX, JH, KT	08/82 ⇒ 07/92	
TRANSPORTER IV 1.8	5K7M710	12/90 ⇒ 07/92	
ZASTAVA			
YUGO 45 [USA]	--	01/86 ⇒	

EPS 1.406.056R



ROTORS

Adatt./Suitable: BOSCH

BOSCH

1 234 332 273

CITROËN

95 602 185

GENERAL MOTORS

90 006 547

90 141 911

HOLDEN

GB838

OPEL

12 12 217

12 12 220

PEUGEOT

5937 25

SEAT

000 398 066 6

036 905 225 H

SE 021914.004A

VW

036 905 225 H

212 Resistance Rotor [Ohm] 1000

- Rotore resistenza [Ohm] 1000
- Résistance rotor [ohm] 1000
- Widerstand-Rotor [Ohm] 1000
- Resistencia rotor [ohm] 1000



CITROËN

AX 1.3 Sport	M4A	04/87 ⇒ 12/88
AX 10	C1A	09/86 ⇒ 06/92
AX 10 E	C3A	12/86 ⇒ 12/88
AX 11	H1A, H1B, HDZ(TU1M)	09/86 ⇒ 12/97
AX 11 4x4	H1A	06/91 ⇒ 07/92
AX 11 Cat	HAZ(TU1CP)	09/88 ⇒ 12/89
AX 14	K1A(TU3), K1B, K1F, K1G, K1J, K2A, K2B, K2D, KAY(TU3CP), KDX(TU3M/Z), KDY(TU3FM), KDY(TU3M), KDZ(TU3M/Z)	09/86 ⇒ 04/97
AX 14 4x4	KD4, KDX(TU3M/Z), KDY(TU3FM), KDY(TU3M), KDZ(TU3M/Z)	06/91 ⇒ 12/96
AX 14 GT	KDZ(TU3M/Z)	01/89 ⇒ 12/91
BX 1.1	109LA, H1A	04/86 ⇒ 06/91
BX 1.4	150C, K1F, K2D	07/86 ⇒ 12/94
BX 1.4 E	150B(XY8), 150J, 150Y, K1F, KAZ	09/82 ⇒ 12/94
BX 1.6	182A, B2C, B6D, B6E	01/87 ⇒ 12/94
BX 1.9	159B, 159C, D6U, DKK	05/85 ⇒ 12/94
BX 1.9 GTi	D6D, D6K	01/87 ⇒ 01/92
BX 14	150C, KDY(TU3M), KDZ(TU3M/Z)	01/86 ⇒ 02/93
BX 14 E	150A, 150C, K1G	10/82 ⇒ 02/93
BX 15	B1E(XU51C)	01/87 ⇒ 05/92
BX 16	171A, 171B, 171C, 171D, 180Z, 23DH, B1E(XU51C), BAY(XU5CP), BAZ(XU5CP)	10/82 ⇒ 12/94
BX 19	159A, D2A(XU92C), D2C(XU92C), D2E, D6A(XU9J2), DKZ(XU9JA)	09/84 ⇒ 12/94
BX 19 Cat	DFZ(XU9J1)	07/86 ⇒ 12/94
BX 19 E 4x4	D2F	04/89 ⇒ 02/93
BX 19 GTi	D6A(XU9J2), DKZ(XU9JA)	07/86 ⇒ 02/93

CITROËN

BX 19 GTi 4x4	DKZ(XU9JA)	06/88 ⇒ 02/93
C15 1.0	108C, 108C(XV8), C1A, C1A(TU9/K), C1B(TU9/W), TU9	10/84 ⇒ 12/97
C15 1.0 E	TU9K	11/92 ⇒ 07/96
C15 1.1	109K, H1A, HDZ(TU1M), TU1, XW7	10/84 ⇒ 12/96
C15 1.1 i	HDZ(TU1M), TU1MZ	07/88 ⇒ 12/96
C15 1.4	150D(XY7), K1A, K1G, K1H(TU3A), KDY(TU3M)	05/87 ⇒ 12/96
C15 1.4 E	150D(XY7), K1F, K1J, K2D, K3A, KAZ	07/86 ⇒ 12/96
C15 1.4 i	KDY(TU3FM), KDY(TU3M)	05/91 ⇒ 12/96
LNA 1.1	109/5E	07/82 ⇒ 04/85
VISA 11 E	109K	09/78 ⇒ 06/88
ZX 1.1	H1A, H1B, HDZ(TU1M), TU1	03/91 ⇒ 06/97
ZX 1.4 i	KDY(TU3M)	10/93 ⇒ 10/97

HOLDEN

CAMIRA 1.6	161H	08/82 ⇒ 02/86
CAMIRA 1.8 MPFi	6T2Z04XS85K01	11/84 ⇒ 01/86
CAMIRA 1.8 SPFi	6T2Z04XS85K01	02/86 ⇒ 03/87

OPEL

ASCONA C 1.6	16N	09/81 ⇒ 08/88
ASCONA C 1.6 S	16SH	09/81 ⇒ 08/86
ASCONA C 1.8 E	C18NE	01/85 ⇒ 08/86
ASCONA C 1.8 i	18E	09/82 ⇒ 08/86
ASTRA F 1.4	14NV	09/91 ⇒ 09/93
CORSA A 1.4 S	14NV	09/89 ⇒ 03/93
CORSA A 1.6 GSi	E16SE	05/88 ⇒ 03/92
KADETT E 1.4 S	14NV	07/89 ⇒ 02/93
KADETT E 1.6 S	16S	09/84 ⇒ 08/86
KADETT E 1.8 E	C18NE	10/85 ⇒ 08/86
KADETT E 1.8 GSi	18E	09/84 ⇒ 08/86
KADETT E 1.8 i	18E, C18NE, C18NT	08/84 ⇒ 09/92
OMEGA A 2.6 i	C26NE	09/90 ⇒ 03/94
OMEGA A 3.0	30NE, C30LE, C30NE	03/87 ⇒ 03/94
OMEGA A 3.0 24V	C30SE	09/89 ⇒ 03/94
OMEGA A 3.0 24V Omega 3000	C30SE	09/88 ⇒ 04/94
OMEGA A 3.0 Cat	C30NE	03/87 ⇒ 03/94
SENATOR B 2.5 i	25NE	09/90 ⇒ 09/93
SENATOR B 3.0	30NE, C30LE	09/87 ⇒ 09/93
SENATOR B 3.0 24V	C30SE	09/89 ⇒ 09/93
SENATOR B 3.0 i Cat	C30NE	01/88 ⇒ 09/93
VECTRA A 1.4 S	14NV	04/88 ⇒ 06/92

PEUGEOT

104 1.0	108C(XV8)	09/83 ⇒ 06/88
106 I 1.0	TU9	09/91 ⇒ 03/01
106 I 1.1	H1B(TU1)	08/91 ⇒ 03/96
106 I 1.4	KDY(TU3M)	09/91 ⇒ 04/96
205 I 1.0	108C(XV8)	02/83 ⇒ 12/90
205 I 1.4	150B(XY8), 150G(XY7), 150H(XY8), TU3	01/83 ⇒ 12/90
205 I 1.6	B1A(XU51C), B1E(XU51C), BAZ(XU5CP)	08/86 ⇒ 10/87
205 I 1.6 GTI	180A(XU5J), B6D(XU5JA), XU5J1	01/83 ⇒ 12/90
205 I 1.9 GTI	D6B(XU9JA), DFZ(XU9J1)	10/86 ⇒ 10/87
205 II 1.0	TU9	10/87 ⇒ 09/98
205 II 1.1	H1B(TU1)	10/87 ⇒ 12/94
205 II 1.1 CJ	HDZ(TU1M)	10/89 ⇒ 12/94
205 II 1.4	150B(XY8), 150G(XY7), 150H(XY8), K1D(TU3A), K2B(TU3S)	06/87 ⇒ 10/90
205 II 1.4 Cat	KAY(TU3CP)	08/87 ⇒ 09/93
205 II 1.4 CJ	150G(XY7), K1D(TU3A)	03/88 ⇒ 12/94
205 II 1.4 CJ Cat	KAY(TU3CP)	01/89 ⇒ 09/93
205 II 1.4 CT	150B(XY8), 150H(XY8)	04/86 ⇒ 12/88
205 II 1.6	B1A(XU51C), B1E(XU51C), BAZ(XU5CP)	10/87 ⇒ 09/98
205 II 1.6 CTi	180A(XU5J), 180Z(XU5J)	03/86 ⇒ 10/90
205 II 1.6 GTI	180A(XU5J), 180Z(XU5J), XU5JA	10/87 ⇒ 12/94
205 II 1.9 CTi	DFZ(XU9J1)	10/87 ⇒ 12/94
205 II 1.9 GTI	D6B(XU9JA)	10/87 ⇒ 09/98
205 II 1.9 GTI Cat	DFZ(XU9J1)	10/87 ⇒ 07/94
309 I 1.4	K1D(TU3A)	03/89 ⇒ 07/89
309 I 1.6	--, 180Z(XU5J), B1A(XU51C), B1D(XU51C), B1E(XU51C), B6B(XU5J), XU5JA	10/85 ⇒ 07/89
309 I 1.6 Cat	BAZ(XU5CP)	09/86 ⇒ 12/89
309 I 1.9	D2B(XU9S), DFZ(XU9J1), XU92C	10/85 ⇒ 07/89
309 I 1.9 GTI	D6B(XU9JA)	10/86 ⇒ 07/89
309 II 1.1	H1B(TU1)	09/89 ⇒ 10/93
309 II 1.4	TU3	07/89 ⇒ 12/93
309 II 1.6	XU5JA	07/89 ⇒ 12/93
309 II 1.6 GTi	--	09/89 ⇒ 10/93
309 II 1.9	XU92C	07/89 ⇒ 12/93
405 I 1.4	K5A(TU3), TU3A	01/87 ⇒ 12/92
405 I 1.6	--	01/87 ⇒ 12/92
405 I 1.9	D6A(XU9J2), DFZ(XU9J1)	07/87 ⇒ 12/93

PEUGEOT

405 I 1.9 Antipollution	XU92C	01/87 ⇒ 12/92
405 I 1.9 Injection	DFZ(XU9J1)	07/87 ⇒ 12/92
405 I 1.9 Trazione integrale	DFZ(XU9J1)	09/88 ⇒ 07/92
405 II 1.6	18EM	08/92 ⇒ 05/97
505 2.0 Ti, STI	829(ZEJ)	08/79 ⇒ 10/86

SEAT

IBIZA I 1.2	021A1000	11/84 ⇒ 12/93
IBIZA II 1.3 i	8C20HD0D	03/93 ⇒ 08/99
MALAGA 1.2	021A1000	05/85 ⇒ 12/93
MALAGA 1.5	021A2000	05/85 ⇒ 12/93

VAUXHALL

ASTRA III 1.4	14NV	09/91 ⇒ 09/93
ASTRA III 1.4 S	14NV	09/91 ⇒ 02/98

VW

POLO II 1.0	AAK, GL, HZ	10/81 ⇒ 09/94
POLO II 1.0 Cat	AAK, ACM	08/89 ⇒ 09/94
POLO II 1.3	GK, MH	09/82 ⇒ 09/89
POLO II 1.3 Cat	2G, MH, NZ	07/87 ⇒ 09/94
JETTA II 1.0	HZ	08/85 ⇒ 10/91
JETTA II 1.3	GT, MH, NU	01/84 ⇒ 12/87
JETTA II 1.3 Cat	2G, MH, NZ	06/87 ⇒ 12/91
DERBY 1.3	HK	08/83 ⇒ 12/84
GOLF II 1.0	HZ	08/85 ⇒ 10/91
GOLF II 1.3	GT, MH, NU	08/83 ⇒ 12/87
GOLF II 1.3 Cat	2G, NZ	06/86 ⇒ 12/92
PASSAT II 1.3	79SU16	08/80 ⇒ 07/86
SCIROCCO II 1.3	GF	08/80 ⇒ 12/83

EPS 1.406.059R



ROTORS

Adatt./Suitable: BOSCH

AUDI

035 905 225 C

035 905 225 C

1 234 332 305

1 234 335 305

VW

035 905 225 C

03 Supplied until depletion

- Fornibile fino ad esaurimento delle scorte
- Fourni jusqu'à épuisement du stock
- Lieferbar solange vorrat reicht
- Suministrado hasta el stock termina

212 Resistance Rotor [Ohm] 1000

- Rotore resistenza [Ohm] 1000
- Résistance rotor [ohm] 1000
- Widerstand-Rotor [Ohm] 1000
- Resistencia rotor [ohm] 1000

310 RPM to [1/min] 6700

- N° giri fino a [1/min.] 6700
- Régime mot. jusqu'à [1/min] 6700
- Drehzahl bis [1/min] 6700
- vel. giro hasta [1/min] 6700



AUDI

100 III 1.9	WH	08/82 ⇒ 07/84
100 III 2.2	KZ	10/84 ⇒ 09/86
200 II 2.2	KU	08/84 ⇒ 07/85
200 II 2.2 Turbo quattro	MC	01/85 ⇒ 12/91

VW

PASSAT II 1.9	WN	01/81 ⇒ 07/83
---------------	----	---------------

EPS 1.406.060R



ROTORS

Adatt./Suitable: BOSCH

BMW
12 11 1 707 263BOSCH
1 234 332 279
1 234 332 296DAF
698595FORD
6 075 742
815F-12200-FAMAN
51.26310-0005MERCEDES-BENZ
A 000 158 35 31Motorcraft
EDR 98ROVER
GRA2236
GRA2264²¹² Resistance Rotor [Ohm] 1000

- Rotore resistenza [Ohm] 1000
- Résistance rotor [ohm] 1000
- Widerstand-Rotor [Ohm] 1000
- Resistencia rotor [ohm] 1000

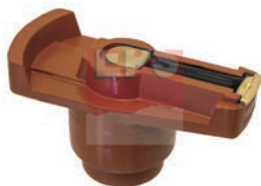

BMW		
3 II 323 i	M20B23(236EC)	09/82 ⇒ 09/86
5 II 520 i	M20B20(206EA)	06/81 ⇒ 12/87
5 II 525 i	M30B25(256EA)	06/81 ⇒ 12/87
5 II 528 i	M30B28(286EA)	06/81 ⇒ 12/87
FORD		
ESCORT III 1.3	JPA	09/80 ⇒ 02/86
ESCORT III 1.6	LP1, LPA	09/80 ⇒ 12/85
ORION I 1.3	JPA	07/83 ⇒ 03/86
ORION I 1.6	LP1, LPA	07/83 ⇒ 03/86
MERCEDES-BENZ		
123 280 CE	M110.988	03/77 ⇒ 11/85
CLASSE G I 280 GE	M110.994	11/79 ⇒ 08/89
CLASSE G II 280 GE	M110.994	04/92 ⇒
CLASSE S II 280 SE, SEL	M110.989	10/79 ⇒ 07/85
TRE VOLUMI I 280 E	M110.988	02/76 ⇒ 11/85
PUCH		
G-MODELL 280 GE	M110.994	01/86 ⇒ 12/91

EPS 1.406.061R



ROTORS

Adatt./Suitable: BOSCH

ALFA ROMEO
116 97 05 011 00/04
60755007
9940437BMW
12 11 1 272 300BOSCH
1 234 332 271
1 234 332 275
1 234 332 401FIAT
7080449
9940437FORD
5 021 112
6 124 108
6 182 579
80SX-12200-AA
845F-12200-AA
88SX-12200-AA
895F-12200-AAGENERAL MOTORS
91 103 092MERCEDES-BENZ
0001582731
A 000 158 33 31Motorcraft
EDR 151
EDR 157
EDR 187OPEL
12 12 219PEUGEOT
5937 40TALBOT
0043 23 7300VW
039 905 225
053 905 225 1²¹² Resistance Rotor [Ohm] 1000

- Rotore resistenza [Ohm] 1000
- Résistance rotor [ohm] 1000
- Widerstand-Rotor [Ohm] 1000
- Resistencia rotor [ohm] 1000



ALFA ROMEO		
33 I 1.2	AR30585	06/83 ⇒ 12/89
33 I 1.3	AR30168, AR30586, AR30587	06/83 ⇒ 12/89
33 I 1.3 i.e.	AR30168	05/83 ⇒ 12/89
33 I 1.4	AR30587	01/84 ⇒ 12/88
33 I 1.5	AR30588	07/86 ⇒ 12/89
33 I 1.5 4x4	AR30508, AR30588	07/86 ⇒ 12/89
33 I 1.5 QV	AR30146, AR30508, AR30588	06/84 ⇒ 12/89
33 I 1.7	AR30550	01/86 ⇒ 06/90
33 I 1.7 i.e.	AR30558	09/88 ⇒ 12/89
33 I 1.7 i.e. 4x4	AR30558	09/88 ⇒ 12/89
33 I 1.7 QV	AR30550	03/88 ⇒ 12/89
33 II 1.2	AR30743	01/90 ⇒ 08/91
33 II 1.3	AR30732	09/91 ⇒ 10/94
33 II 1.5	AR30734	01/90 ⇒ 04/93
75 1.8	AR06202	09/85 ⇒ 06/89
90 1.8	AR06202	10/84 ⇒ 07/87
90 2.0 i.e.	AR06210	10/84 ⇒ 07/87
ALFETTA 1.6	AR01600	01/75 ⇒ 12/84
ALFETTA 1.8	AR01608	10/79 ⇒ 12/84
GIULIETTA I 1.6	AR01600	10/77 ⇒ 04/85
GIULIETTA I 1.8	AR01678	04/79 ⇒ 04/85
GIULIETTA I 2.0	AR01655	06/80 ⇒ 04/85
CITROËN		
C15 1.1	E1A	10/84 ⇒ 12/96
C15 1.3	G1A	07/87 ⇒ 05/88
FIAT		
UNO 70 1.3i SX	--	01/83 ⇒ 12/89
UNO 75 i.e. 1.5	138C2.048	10/85 ⇒ 12/93
FIAT (BR)		
PREMIO	--	01/85 ⇒ 12/88
PREMIO 1.3	--	01/85 ⇒
PREMIO 1.5	--	01/85 ⇒
UNO 1.3	1.3	01/85 ⇒ 12/91
UNO 1.5	1.5	01/91 ⇒ 12/93
UNO 1.5R	1.5	01/87 ⇒ 12/89
UNO 1.6R	1.6	01/90 ⇒ 12/93
UNO CS 1.3	1.3	01/85 ⇒ 12/91
UNO CS 1.5	1.5	01/89 ⇒ 12/93
UNO CS 1.5 Furgoneta	1.5	01/91 ⇒ 12/93
UNO CSL 1.6	1.6	01/91 ⇒ 12/93
UNO MILLE 1.0	1.0	01/91 ⇒ 04/93

FORD		
ESCORT IV 1.4	F6D, FUA, FUC	01/86 ⇒ 07/90
FIESTA II 1.1	G5H	05/86 ⇒ 02/89
FIESTA II 1.4	FUB, FUD	10/85 ⇒ 11/89
ESCORT III 1.4 i	F6D, FUC	02/86 ⇒ 07/90
ORION I 1.3	JPA	11/86 ⇒ 07/88
ORION I 1.4	FUA, FUC	12/85 ⇒ 07/90
ORION I 1.4 Cat	F6D	02/87 ⇒ 07/90
OPEL		
CORSA A 1.2	E12GV	09/82 ⇒ 08/90
CORSA A 1.2 N	E12GV	01/85 ⇒ 10/87
PEUGEOT		
205 11.3	G1A	02/84 ⇒ 10/87
205 11.4	J2	01/83 ⇒ 12/90
205 II 1.1 XA	E1	07/87 ⇒ 10/88
205 II 1.2	F1	01/87 ⇒ 12/90
205 II 1.3	G1A	08/90 ⇒ 07/92
205 II 1.4	J2	01/91 ⇒ 12/94
309 11.1	E1	10/85 ⇒ 07/89
309 11.3	G1A, G2S	10/85 ⇒ 08/89
309 11.6	--, J2	01/86 ⇒ 07/89
309 II 1.6	18EM, J2	07/89 ⇒ 12/93
TALBOT		
TAGORA 2.1	5N2	06/80 ⇒ 12/83
VOLKSWAGEN (BR)		
APOLLO 1.8		06/90 ⇒ 11/92

EPS 1.406.067R



ROTORS

Adatt./Suitable: BOSCH

BOSCH
1 234 332 144
1 234 332 158
1 234 332 162
1 234 332 209
1 234 332 291
1 234 332 303GENERAL MOTORS
93 150 099VW
021 905 225
071 905 225
071 905 225 A⁰³ Supplied until depletion

- Fornibile fino ad esaurimento delle scorte
- Fourni jusqu'à épuisement du stock
- Lieferbar solange vorrat reicht
- Suministrado hasta el stock termina

²¹² Resistance Rotor [Ohm] 1000

- Rotore resistenza [Ohm] 1000
- Résistance rotor [ohm] 1000
- Widerstand-Rotor [Ohm] 1000
- Resistencia rotor [ohm] 1000

³¹⁰ RPM to [1/min] 5400

- N° giri fino a [1/min.] 5400
- Régime mot. jusqu'à [1/min] 5400
- Drehzahl bis [1/min] 5400
- vel. giro hasta [1/min] 5400



OPEL		
REKORD E 1.7	17N	09/77 ⇒ 10/82
REKORD E 1.9	19N	09/77 ⇒ 10/82
REKORD E 2.0	20N	09/77 ⇒ 10/82
VOLVO		
240 2.3	B23A	08/80 ⇒ 07/84
VW		
TRANSPORTER II 2.0	CJ, GD, GE	08/75 ⇒ 04/79
TRANSPORTER III 1.9	DF, DG	08/82 ⇒ 07/92
TRANSPORTER III 1.9 Syncro	DG	11/84 ⇒ 07/92

EPS 1.406.070R



3

ROTORS

Adatt./Suitable: BOSCH

BOSCH

1 234 332 333

PORSCHE

944 602 901 00

944 602 906 01

ROLLS-ROYCE

UE 46152

²¹² Resistance Rotor [Ohm] 1000

- Rotore resistenza [Ohm] 1000
- Résistance rotor [ohm] 1000
- Widerstand-Rotor [Ohm] 1000
- Resistencia rotor [ohm] 1000

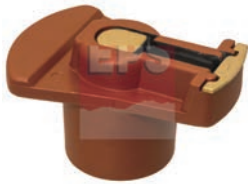

PORSCHE

924 2.5 S	M44.07	09/85 ⇒ 07/87
928 4.7 S	M28.11, M28.12	09/79 ⇒ 07/83

EPS 1.406.112R



3

ROTORS

Adatt./Suitable: BOSCH

BMW

12 11 1 276 277

12 11 1 286 111

BOSCH

1 234 332 276

1 234 332 313

1 234 332 344

1 234 332 351

FORD

1 612 099

1 617 277

V835-F12200-AA

V835-F12200-AB

MERCEDES-BENZ

A 000 158 37 31

Motorcraft

EDR 123

EDR 135

⁰³ Supplied until depletion

- Fornibile fino ad esaurimento delle scorte
- Fourni jusqu'à épuisement du stock
- Lieferbar solange vorrat reicht
- Suministrado hasta el stock termina

²¹² Resistance Rotor [Ohm] 1000

- Rotore resistenza [Ohm] 1000
- Résistance rotor [ohm] 1000
- Widerstand-Rotor [Ohm] 1000
- Resistencia rotor [ohm] 1000

³¹⁰ RPM to [1/min] 6500

- N° giri fino a [1/min.] 6500
- Régime mot. jusqu'à [1/min] 6500
- Drehzahl bis [1/min] 6500
- vel. giro hasta [1/min] 6500



BMW

3 II 323 i	M20B23(236EC)	09/82 ⇒ 09/86
5 II 520 i	M20B20(206EA)	06/81 ⇒ 12/87
5 II 525 i	M30B25(256EA)	06/81 ⇒ 12/87
5 II 528 i	M30B28(286EA)	06/81 ⇒ 12/87
6 I 628 CSI	M30B28	09/79 ⇒ 08/87

FORD

ESCORT III 1.6 i	LR1	09/83 ⇒ 12/85
ESCORT III 1.6 XR3i	LR1, LRA	10/82 ⇒ 12/85
ORION I 1.6 i	LR1, LRA	07/83 ⇒ 03/86

EPS 1.406.113R



1

ROTORS

Adatt./Suitable: BOSCH

ALFA ROMEO

116 69 05 011 00/02

60732287

BOSCH

1 234 332 200

1 234 332 346

JAGUAR

JLM 839

MERCEDES-BENZ

0001583531

PORSCHE

930 602 902 01

930 602 902 02

⁰⁰ Eliminated on 09-03-2022. Please verify the availability through our local distributors

- Eliminato il 09-03-2022. Verificare la disponibilità presso i nostri distributori
- Éliminé le 09-03-2022. Vérifier la disponibilité auprès de nos distributeurs sur place
- Am 09-03-2022 gestrichen. Evtl. Verfügbarkeit bitte bei unseren Händlern prüfen
- Eliminado en fecha 09-03-2022. Verificar la disponibilidad a través de nuestros distribuidores locales

²¹² Resistance Rotor [Ohm] 1000

- Rotore resistenza [Ohm] 1000
- Résistance rotor [ohm] 1000
- Widerstand-Rotor [Ohm] 1000
- Resistencia rotor [ohm] 1000



ALFA ROMEO

75 2.5 V6	AR01911	05/85 ⇒ 08/86
75 3.0 V6	AR06120, AR61503	01/87 ⇒ 02/92
75 3.0 V6 Cat	AR06124	01/87 ⇒ 02/92

PORSCHE

911 II 3.3 Turbo	M30.69	08/90 ⇒ 09/93
911 II 3.3 Turbo S	M30.69S	06/91 ⇒ 12/92
911 II 3.6 Carrera	M64.01, M64.02	12/88 ⇒ 05/94
911 II 3.6 Carrera 4	M64.01	12/88 ⇒ 05/94
911 II 3.6 Carrera RS	M64.03	06/91 ⇒ 09/93
911 II 3.6 Turbo	M64.50	01/93 ⇒ 09/93
911 I 3.2 SC Carrera	930.20	08/83 ⇒ 08/89
911 III 3.6 Carrera	M64.05, M64.06, M64.07, M64.08, M64.21, M64.22, M64.23, M64.24	10/93 ⇒ 09/97
911 III 3.6 Carrera 4	M64.05, M64.07, M64.21, M64.23	07/94 ⇒ 09/97
911 III 3.6 Turbo 4	M64.60	03/95 ⇒ 09/97
911 III 3.6 Turbo GT2	M64.60R	03/95 ⇒ 09/97
911 III 3.6 Turbo GT2 4	M64.60R, M64.60RS	08/95 ⇒ 09/97
911 III 3.8 Carrera	M64.05S, M64.06S, M64.21S	06/95 ⇒ 09/97
911 III 3.8 Carrera 4	M64.05S, M64.06S, M64.21S	06/95 ⇒ 09/97
911 III 3.8 Carrera RS	M64.20	06/95 ⇒ 09/97

EPS 1.406.114R



3

ROTORS

Adatt./Suitable: BOSCH

BOSCH

1 234 332 340

VW

052 905 225 B

⁰³ Supplied until depletion

- Fornibile fino ad esaurimento delle scorte
- Fourni jusqu'à épuisement du stock
- Lieferbar solange vorrat reicht
- Suministrado hasta el stock termina

²¹² Resistance Rotor [Ohm] 5000

- Rotore resistenza [Ohm] 5000
- Résistance rotor [ohm] 5000
- Widerstand-Rotor [Ohm] 5000
- Resistencia rotor [ohm] 5000

³¹⁰ RPM to [1/min] 6500

- N° giri fino a [1/min.] 6500
- Régime mot. jusqu'à [1/min] 6500
- Drehzahl bis [1/min] 6500
- vel. giro hasta [1/min] 6500



VW

POLO II 1.0	GL	10/81 ⇒ 10/86
POLO II 1.3	HK, HW	08/83 ⇒ 07/88
JETTA II 1.3	HK	01/84 ⇒ 06/87
DERBY 1.0	GL	10/81 ⇒ 12/84
DERBY 1.3	HH	02/77 ⇒ 09/81
GOLF I 1.3	HK	08/83 ⇒ 07/86
GOLF II 1.0	GN	11/83 ⇒ 08/85
GOLF II 1.3	HK	08/83 ⇒ 06/87
SCIROCCO I 1.3	GF	08/79 ⇒ 07/80
SCIROCCO II 1.3	HK	08/83 ⇒ 07/84

EPS 1.406.115R



3

ROTORS

Adatt./Suitable: BOSCH

BMW

12 11 1 286 110

12 11 1 357 720

12 11 1 710 735

BOSCH

1 234 332 220

1 234 332 281

1 234 332 288

1 234 332 343

FIAT

82357741

VW

049 905 225 C

049 905 225 D

⁰³ Supplied until depletion

- Fornibile fino ad esaurimento delle scorte
- Fourni jusqu'à épuisement du stock
- Lieferbar solange vorrat reicht
- Suministrado hasta el stock termina

²¹² Resistance Rotor [Ohm] 1000

- Rotore resistenza [Ohm] 1000
- Résistance rotor [ohm] 1000
- Widerstand-Rotor [Ohm] 1000
- Resistencia rotor [ohm] 1000

³¹⁰ RPM to [1/min] 6400

- N° giri fino a [1/min.] 6400
- Régime mot. jusqu'à [1/min] 6400
- Drehzahl bis [1/min] 6400
- vel. giro hasta [1/min] 6400



BMW

3 II 316	M10B18(184VC), M10B18(184VD)	09/83 ⇒ 06/88
3 II 318 i	M10B18(184EA), M10B18(184KA)	09/82 ⇒ 08/88
3 I 315	M10B16(164VB)	03/81 ⇒ 03/84
5 II 518	M10B18(184VC), M10B18(184VD)	06/81 ⇒ 09/84
5 II 518 i	M10B18(184EB)	05/81 ⇒ 12/87

BMW		
51518	M10B18(184VB)	07/74 ⇒ 05/81

EPS **1.406.116R**



ROTORS

Adatt./Suitable: **BOSCH**

AUDI

026 905 225
035 905 225

BOSCH

1 234 332 242
1 234 332 348

GENERAL MOTORS

93 150 911

VW

026 905 225
035 905 225

03 Supplied until depletion

- Fornibile fino ad esaurimento delle scorte
- Fourni jusqu'à épuisement du stock
- Lieferbar solange vorrat reicht
- Suministrado hasta el stock termina

212 Resistance Rotor [Ohm] 1000

- Rotore resistenza [Ohm] 1000
- Résistance rotor [ohm] 1000
- Widerstand-Rotor [Ohm] 1000
- Resistencia rotor [ohm] 1000

310 RPM to [1/min] 6700

- N° giri fino a [1/min.] 6700
- Régime mot. jusqu'à [1/min] 6700
- Drehzahl bis [1/min] 6700
- vel. giro hasta [1/min] 6700



AUDI		
80 II 1.8 GTE	DZ	10/84 ⇒ 08/86
80 II 2.0	HP, JS	10/83 ⇒ 09/84
80 II 2.0 quattro	JS	10/83 ⇒ 09/84
90 I 2.0	HP, JS	10/84 ⇒ 03/87
90 I 2.0 quattro	JS	08/84 ⇒ 08/86
90 I 2.2	9C54, HY	10/84 ⇒ 03/87
90 I 2.2 E quattro	9C54	11/84 ⇒ 03/87
100 III 2.0	KP	08/84 ⇒ 12/87
100 III 2.0 E	KP	01/85 ⇒ 12/87
100 III 2.2	KZ	10/84 ⇒ 09/86
COUPE 2.2 GT	9C54	09/84 ⇒ 10/88
COUPE 2.2 quattro	9C54	10/84 ⇒ 07/91

VW		
PASSAT II 2.0	JS	08/83 ⇒ 03/88
PASSAT II 2.0 Syncro	JS	05/84 ⇒ 03/88
JETTA II 1.8	EV	01/84 ⇒ 10/91
JETTA II 1.8i GT	GZ	12/83 ⇒ 07/88
GOLF I 1.8	DX, KT	08/82 ⇒ 12/92
GOLF II 1.8 GTI	EV	08/83 ⇒ 10/91
GOLF II 1.8i GTI [CHE] [SWE]	GZ	01/84 ⇒ 07/85
SANTANA 1.9	WN	08/81 ⇒ 07/83
SANTANA 2.0	JS	08/83 ⇒ 12/84
SCIROCCO II 1.8	DX, KT	08/82 ⇒ 12/89

EPS **1.406.117R**



ROTORS

Adatt./Suitable: **BOSCH**

BMW

12 111 1 304 909
12 111 1 328 430

BOSCH

1 234 332 272
1 234 332 277
1 234 332 284
1 234 332 317
1 234 332 353

VW

073 905 225 A

00 Eliminated on 07-07-2021. Please verify the availability through our local distributors

- Eliminato il 07-07-2021. Verificare la disponibilità presso i nostri distributori
- Éliminé le 07-07-2021. Vérifier la disponibilité auprès de nos distributeurs sur place
- Am 07-07-2021 gestrichen. Evtl. Verfügbarkeit bitte bei unseren Händlern prüfen
- Eliminado en fecha 07-07-2021. Verificar la disponibilidad a través de nuestros distribuidores locales

212 Resistance Rotor [Ohm] 5000

- Rotore resistenza [Ohm] 5000
- Résistance rotor [ohm] 5000
- Widerstand-Rotor [Ohm] 5000
- Resistencia rotor [ohm] 5000

310 RPM to [1/min] 5900

- N° giri fino a [1/min.] 5900
- Régime mot. jusqu'à [1/min] 5900
- Drehzahl bis [1/min] 5900
- vel. giro hasta [1/min] 5900



VW		
LT I 2.4	DL	12/82 ⇒ 07/92
LT I 2.4 4WD	DL	12/82 ⇒ 07/92

EPS **1.406.118R**



ROTORS

Adatt./Suitable: **BOSCH**

BOSCH

1 234 332 349

VOLVO

1346787
13467873

212 Resistance Rotor [Ohm] 1000

- Rotore resistenza [Ohm] 1000
- Résistance rotor [ohm] 1000
- Widerstand-Rotor [Ohm] 1000
- Resistencia rotor [ohm] 1000

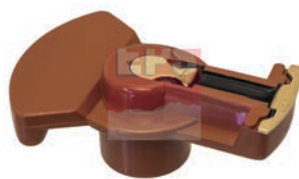

VOLVO		
960 I 2.0	B204FT	08/90 ⇒ 09/93
960 I 2.3	B230GT	08/90 ⇒ 07/94
960 I 2.3 Turbo	B230FT	09/90 ⇒ 08/93
740 2.0	B200E, B200ET, B200G, B200K	01/85 ⇒ 07/92
740 2.0 16V	B204E	09/87 ⇒ 08/90
740 2.0 16V Turbo	B204FT, B204GT	08/89 ⇒ 07/90
740 2.0 GLE	B204E	09/87 ⇒ 08/90
740 2.0 Turbo	B200ET, B200FT	09/87 ⇒ 08/91
740 2.3	B230E, B230F, B230FB, B230G, B230K, B234F	08/84 ⇒ 12/92
740 2.3 GL	B230E	08/84 ⇒ 08/87
740 2.3 Turbo	B230ET, B230FT, B230GT	08/85 ⇒ 08/91
760 2.3	B230ET, B230FT, B230K	08/84 ⇒ 07/92
760 2.3 Turbo	B230ET, B230FT, B230GT	08/84 ⇒ 08/90
780 2.0i	B204GT	01/87 ⇒ 12/90
780 2.0i Turbo	B200ET	01/87 ⇒ 12/90
940 I 2.0	B200E, B200F, B200G	08/90 ⇒ 07/94
940 I 2.0 GL	B204E	09/90 ⇒ 04/92
940 I 2.0 Turbo	B200FT	08/90 ⇒ 07/95

VOLVO		
940 I 2.3	B230E, B230F, B230FB, B230FD, B230G, B234F, B234G	08/90 ⇒ 07/95
940 I 2.3 16V	B234G	08/90 ⇒ 07/92
940 I 2.3 Turbo	B230FT, B230GT	08/90 ⇒ 07/94
940 II 2.0 GLT	B200GT	10/94 ⇒ 05/97
940 II 2.0 Turbo	B200FT	04/96 ⇒ 10/98
940 II 2.3	B230FD, B230GK	08/94 ⇒ 05/97
940 II 2.3 ti	B230FK	01/95 ⇒ 10/98
940 II 2.3 Turbo	B230FT, B230GK	08/94 ⇒ 12/98

EPS **1.406.119R**



ROTORS

Adatt./Suitable: **BOSCH**

ALFA ROMEO

195 32 05 023 00/00
60513052

BMW

12 111 1 284 446
12 111 1 734 110

BOSCH

1 234 332 347

CHRYSLER

T0267693

CITROËN

5937 42
77 002 676 93

FIAT

7700267693

LANCIA

7700267693

PEUGEOT

5937 42

RENAULT

77 00 267 693

VOLVO

1269921
12699211

03 Supplied until depletion

- Fornibile fino ad esaurimento delle scorte
- Fourni jusqu'à épuisement du stock
- Lieferbar solange vorrat reicht
- Suministrado hasta el stock termina

212 Resistance Rotor [Ohm] 1000

- Rotore resistenza [Ohm] 1000
- Résistance rotor [ohm] 1000
- Widerstand-Rotor [Ohm] 1000
- Resistencia rotor [ohm] 1000



ALFA ROMEO		
164 2.0 Turbo	AR64102	07/90 ⇒ 10/92
164 2.0 V6 Turbo	AR64101	03/91 ⇒ 09/92
164 3.0	AR06410	11/87 ⇒ 09/91
164 3.0 i.e. QV	AR64301	09/90 ⇒ 09/92
164 3.0 Lusso [USA] [CAN]	AR06412	10/91 ⇒ 03/93
164 3.0 Sport [CAN] [USA]	AR64301	11/90 ⇒ 03/92
164 3.0 Super	64303	06/87 ⇒ 09/92
164 3.0 V6	AR06410, AR06412	06/87 ⇒ 09/92
GTV 2.0 V6 Turbo	AR16202	06/95 ⇒ 09/98
SPIDER II 2.0 V6 Turbo	AR16202	05/98 ⇒ 04/05

ALPINE		
V6 TURBO	Z7U730, Z7U732, Z7U734	01/88 ⇒ 12/90

BMW		
3 III 316 i	M40B16(164E1), M43B16(164E2)	09/90 ⇒ 09/93
3 III 318 i	M40B18(184E1)	09/90 ⇒ 08/93
3 II 316 i	M40B16(164E1)	09/87 ⇒ 06/94
3 II 318 i	M40B18(184E1)	06/87 ⇒ 06/94
3 II 320 i	M20B20(206EB), M20B20(206KA)	09/82 ⇒ 11/93
3 II 325 e 2.7	M20B27(276KA), M20B27(276KB)	10/83 ⇒ 12/88
3 II 325 i	M20B25(256E1), M20B25(256E2), M20B25(256EX), M20B25(256K1)	09/83 ⇒ 11/93
3 II 325 i X	M20B25(256E1), M20B25(256E2), M20B25(256EX), M20B25(256K1)	03/86 ⇒ 10/93
5 II 520 i	M20B20(206KA)	08/85 ⇒ 12/87
5 II 525 e	M20B27(276EA), M20B27(276EB), M20B27(276KA), M20B27(276KB)	09/81 ⇒ 12/87
5 II 528 i [USA]	--	01/81 ⇒ 12/87
5 II 530 i	--	01/84 ⇒ 12/88
5 II 535 i	M30B34(346EC)	01/85 ⇒ 12/87
5 II 535 i, M 535 i	M30B34(346KA), M30B35(Motronic)	01/85 ⇒ 12/87
5 II M5	S38B35(356ED)	08/85 ⇒ 12/87
5 III 518 i.e.	M40B18(184E1)	09/89 ⇒ 04/94
5 III 520 i	M20B20(206KA)	06/87 ⇒ 09/90
5 III 525 i	M20B25(256K1)	02/88 ⇒ 08/90
5 III 530 i	M30B30(306KA)	01/88 ⇒ 04/90

BMW		
5 III 535 i	M30B34(346KB)	11/87 ⇒ 02/93
5 III M5	S38B36(366S1)	09/88 ⇒ 03/92
5 III M5 Cat	S38B36(366S1)	09/88 ⇒ 03/92
6 I 635 CSi	M30B35(Motronic, 9.3:1)	06/78 ⇒ 04/82
6 I M 635 CSi	M88B35(356ED), S38B35(356ED)	04/84 ⇒ 02/89
7 I 735 i	M30B35(Motronic)	04/85 ⇒ 08/86
7 II 730 i, iL	M30B30(306EA), M30B30(306KA)	03/85 ⇒ 03/94
7 II 735 i, iL	M30B34(346KB), M30B35(Motronic, 9.2:1)	06/86 ⇒ 07/92
7 II 750 i, iL V12	M70B50(S012A)	09/87 ⇒ 09/94
7 III 750 i, iL	M73B54(S4121), M73B54(S4122)	11/94 ⇒ 07/01
8 850 CSi	S70B56(S6121)	11/92 ⇒ 12/96
8 850 i, Ci	M70B50(S012A)	01/90 ⇒ 08/94
Z1 2.5	M20B25(S256K1)	06/88 ⇒ 06/91
CITROËN		
XM I 3.0	UFZ(ZPJ/Z)	05/89 ⇒ 05/94
XM I 3.0 V6	SFZ(ZPJ/Z), UFZ(ZPJ/Z)	05/89 ⇒ 06/94
XM I 3.0 V6 24V	SKZ(ZPJ4/Z), UKZ(ZPJ4/Z)	07/90 ⇒ 06/94
XM II 3.0 V6	SFZ(ZPJ/Z), UFZ(ZPJ/Z)	05/94 ⇒ 10/00
XM II 3.0 V6 24V	SKZ(ZPJ4/Z), UKZ(ZPJ4/Z)	05/94 ⇒ 10/00
LANCIA		
THEMA 2850 V6 i.e.	834E.146	06/88 ⇒ 05/92
PEUGEOT		
605 3.0	UFZ(ZPJ), UKZ(ZPJ4/Z)	08/89 ⇒ 09/99
605 3.0 SV 24	UKZ(ZPJ4/Z)	08/89 ⇒ 09/99
RENAULT		
25 2.4 V6 Turbo	Z7U702	10/84 ⇒ 05/90
25 2.5 V6 Turbo	Z7U700	01/90 ⇒ 12/92
25 2.8 V6	Z7W700, Z7W701	06/87 ⇒ 02/90
25 2.8 V6 Injection	Z7W706, Z7W707, Z7W709	06/87 ⇒ 12/92
ESPACE II 2.8 V6	Z7W712, Z7W713, Z7W717	01/91 ⇒ 10/96
SAFRANE I 3.0	Z7X723	02/93 ⇒ 06/96
SAFRANE I 3.0 Biturbo 4x4	Z7X726	02/93 ⇒ 07/96
SAFRANE I 3.0 V6	Z7X721, Z7X722, Z7X723, Z7X753	12/92 ⇒ 07/96
SAFRANE I 3.0 V6 4x4	Z7X721, Z7X722, Z7X723	12/92 ⇒ 07/96
SAFRANE II 2.9 24V	L7X713	03/99 ⇒ 12/00
SAFRANE II 3.0 V6	6216K4FU	10/96 ⇒ 12/00
VOLVO		
760 2.8	B280E, B280F	08/81 ⇒ 08/91
780 2.9	B280E, B280F	08/86 ⇒ 07/90
960 I 2.8 GL	B280E, B280F	09/90 ⇒ 05/92

EPS 1.406.121R



ROTORS

Adatt./Suitable: **BOSCH**

ALFA ROMEO

195 05 05 011 02/01
195 17 05 011 00/02
60743670
60743768

AUDI

051 905 225
052 905 225 C

BOSCH

0 237 521 024
1 234 332 350
1 234 332 360
1 234 332 366
1 234 332 374
1 234 332 387
1 234 332 393
1 234 332 399
1 234 332 402
1 234 332 414
9 231 087 677

FORD

1 660 332
6 134 771
845F-12200-BA
895F-12200-BA

GENERAL MOTORS

90 008 612

HOLDEN

90008612
VS21273

HYUNDAI

27131-22000

MERCEDES-BENZ

1583931
1584231
A 000 158 39 31
A 000 158 42 31

Motorcraft

EDR 130
EDR 182
EDR 183
EDR 248

OPEL

12 12 222

SAAB

88 22 686

SEAT

026 905 225 2
051 905 225
052 905 225 C
SE 021914.004B

SKODA

052 905 225 C

TOYOTA

19102-02020

VOLVO

1389425
13894258

VW

026 905 225 2
035 905 225 D
035 905 225 F
051 905 225
052 905 225 C



ALFA ROMEO

33 I 1.7 i.e.	AR30558	09/88 ⇒ 12/89
33 I 1.7 i.e. 4x4	AR30558	09/88 ⇒ 12/89
33 II 1.4 4x4	AR30755	07/90 ⇒ 12/92
33 II 1.4 i.e.	AR30755	06/91 ⇒ 09/94
33 II 1.4 i.e. 4x4	AR30755	07/90 ⇒ 09/94
33 II 1.5 i.e.	AR30751	01/90 ⇒ 09/94
33 II 1.5 i.e.	AR30750	07/90 ⇒ 08/91
33 II 1.7 i.e.	AR30736, AR30737	01/90 ⇒ 09/94
33 II 1.7 i.e. 4x4	AR30736, AR30737	01/90 ⇒ 09/94
75 1.8	AR06202	09/85 ⇒ 06/89
75 1.8 i.e. Turbo America	61203	02/86 ⇒ 01/90
75 1.8 Turbo	AR06134	09/86 ⇒ 02/92
90 1.8	AR06202	10/84 ⇒ 07/87
90 2.0 i.e.	AR06210	10/84 ⇒ 07/87

AUDI

80 II 1.8 GTE	PV	08/85 ⇒ 07/86
80 III 1.8	SD	09/86 ⇒ 07/88
80 III 1.8 quattro	SD	09/86 ⇒ 08/90
80 III 1.8 S	PM	09/86 ⇒ 10/91
80 III 2.0	AAD	10/90 ⇒ 08/91
80 III 2.0 E	3A	08/88 ⇒ 10/90
80 III 2.0 E quattro	3A	08/88 ⇒ 09/90
80 IV 1.6	ABM	09/91 ⇒ 12/94
80 IV 1.6 E	ADA	06/93 ⇒ 01/96

AUDI

80 IV 2.0	ABT	09/91 ⇒ 01/96
80 IV 2.0 E	ABK	09/91 ⇒ 01/96
80 IV 2.0 E quattro	ABK	09/91 ⇒ 12/94
80 IV 2.0 quattro	ADW	11/93 ⇒ 01/96
80 IV 2.3 E	NG	09/91 ⇒ 01/96
80 IV 2.3 E quattro	NG	09/91 ⇒ 11/94
90 I 2.0	SK	03/86 ⇒ 03/87
90 II 2.0	PS	07/88 ⇒ 09/91
90 II 2.3 E	NG	04/87 ⇒ 09/91
90 II 2.3 E 20V quattro	7A	06/88 ⇒ 09/91
90 II 2.3 E quattro	NG	04/87 ⇒ 09/91
100 III 2.0 Cat	RT	01/88 ⇒ 11/90
100 III 2.0 E Cat	RT	01/88 ⇒ 11/90
100 III 2.2 E Turbo quattro	MC	08/86 ⇒ 11/90
100 III 2.2 Turbo	MC	08/86 ⇒ 11/90
100 III 2.3	NF	08/86 ⇒ 11/90
100 III 2.3 E	NF	10/86 ⇒ 11/90
100 III 2.3 E quattro	NF	08/86 ⇒ 11/90
100 III 2.3 quattro	NF	01/90 ⇒ 11/90
100 IV 2.0	AAE	12/90 ⇒ 07/94
100 IV 2.0 E	AAE, AAE, ABK	12/90 ⇒ 07/94
100 IV 2.0 E quattro	AAD	12/90 ⇒ 07/92
100 IV 2.3 E	7M15A-FKS	12/90 ⇒ 07/94
100 IV 2.3 E quattro	7M15A-FKS	12/90 ⇒ 07/94
200 II 2.2 Turbo	1B, MC	08/85 ⇒ 09/91
200 II 2.2 Turbo quattro	1B	02/88 ⇒ 11/90
A6 I 2.0	AAE, ABK, ADW	06/94 ⇒ 12/97
A6 I 2.3	7M15A-FKS	06/94 ⇒ 12/95
A6 I 2.3 quattro	7M15A-FKS	06/94 ⇒ 12/95
A4 I 1.6	ADP	11/94 ⇒ 09/01
CABRIOLET 2.0 E	ABK	01/93 ⇒ 07/98
CABRIOLET 2.3 E	NG	05/91 ⇒ 07/94
COUPE 2.0	3A, AAD, ABK	05/89 ⇒ 12/96
COUPE 2.3	NG	10/88 ⇒ 12/96
COUPE 2.3 quattro	NG	01/87 ⇒ 12/96

FORD

ESCORT IV 1.4	F6B	01/86 ⇒ 07/90
ESCORT IV 1.6 Turbo RS	LNB	01/86 ⇒ 07/90
ESCORT IV 1.6 XR3i	LR2, LRB	01/86 ⇒ 07/90
FIESTA III 1.4	F6E	03/89 ⇒ 12/95
GRANADA 1.7	TV17LC	08/77 ⇒ 05/82
GRANADA 2.0	NEP	08/79 ⇒ 08/85
SIERRA I 1.8	REB	10/84 ⇒ 12/86
SIERRA I 2.0	NET, NR2, NRD	08/82 ⇒ 12/86
SIERRA I 2.0 i	NR2	03/85 ⇒ 12/86
ESCORT III 1.4 i	F6B	02/86 ⇒ 07/90
ORION I 1.4 Cat	F6B	02/87 ⇒ 07/90
ORION I 1.6 i	LRB	03/86 ⇒ 07/90
SCORPIO I 1.8	REC	04/85 ⇒ 02/92
SCORPIO I 2.0	TL20H-NE4, TL20H-NER	10/84 ⇒ 02/90
SCORPIO I 2.0 i	NRA, NRI	04/85 ⇒ 02/92
SIERRA II 2.0	N8C, NES	01/87 ⇒ 02/93
TRANSIT II 2.0	N6TS	10/85 ⇒ 03/91
TRANSIT II 2.0 Cat	N6T	11/85 ⇒ 09/92
TRANSIT II 2.0 EFI	--	08/91 ⇒ 08/94

HOLDEN

BARINA 1.4 i	C14NZ	04/94 ⇒ 07/97
BARINA_SB 1.2i	C12NZ	04/94 ⇒ 07/97
COMBO 1.4 i	C14NZ	03/96 ⇒ 07/97
COMBO_SB 1.4i	C14NZ	04/94 ⇒ 07/97

HYUNDAI

S COUPE 1.5 i	G4EK	04/92 ⇒ 05/96
S COUPE 1.5 i Turbo	G4EK-TC	04/91 ⇒ 05/96

MERCEDES-BENZ

124 200 CE	M102.963	09/89 ⇒ 06/93
124 230 CE	M102.982	03/87 ⇒ 12/92
124 230 CE Cat	M102.982	06/89 ⇒ 12/92
190 2.0	M102.924	08/83 ⇒ 05/90
190 2.3	M102.985	09/87 ⇒ 09/88
190 2.3 E	M102.985	10/82 ⇒ 09/88
190 E 1.8	M102.910, M102.919	04/90 ⇒ 12/93
190 E 2.0	M102.962	10/82 ⇒ 08/93
190 E 2.3	M102.985	09/86 ⇒ 08/93
190 E 2.3-16	M102.983	04/84 ⇒ 08/88
190 E 2.5-16	M102.990	09/88 ⇒ 08/93
190 E 2.5-16 Evolution	M102.991	03/89 ⇒ 08/93
CLASSE G II 200 GE	M102.965	01/90 ⇒ 07/93
CLASSE G II 230 GE	M102.979	09/89 ⇒ 07/96
KOMBI II 200 T	M102.922	09/85 ⇒ 05/90
KOMBI II 200 TE	M102.962, M102.963	09/88 ⇒ 08/92
KOMBI II 230 E Chassis	M102.982	09/86 ⇒ 06/93
KOMBI II 230 TE	M102.982	09/85 ⇒ 08/92
KOMBI II 230 TE Cat	M102.982	06/89 ⇒ 08/92
TRE VOLUMI II 200	M102.922	12/85 ⇒ 10/92
TRE VOLUMI II 200 E	M102.963	09/88 ⇒ 08/93
TRE VOLUMI II 230 E	M102.982	12/84 ⇒ 06/93
TRE VOLUMI II 230 E Cat	M102.982	06/89 ⇒ 06/93

OPEL		
ASTRA F 1.4i	C14NZ	09/91 ⇒ 01/05
ASTRA F 2.0 GSI 16V	C20XE	09/91 ⇒ 01/98
ASTRA F 2.0i 16V	C20XE	03/93 ⇒ 01/98
CALIBRA A 2.0i 16V	C20XE	06/90 ⇒ 02/94
CALIBRA A 2.0i 16V 4x4	C20XE	06/90 ⇒ 02/94
CALIBRA A 2.0i Turbo 4x4	C20LET	08/91 ⇒ 07/97
COMBO B 1.2	C12NZ	07/94 ⇒ 10/01
COMBO B 1.4	C14NZ	07/94 ⇒ 10/01
CORSA A 1.2i	C12NZ	09/89 ⇒ 03/93
CORSA A 1.4i	C14NZ	01/85 ⇒ 03/93
CORSA A 1.6 GSI	E16SE	05/88 ⇒ 03/92
CORSA B 1.2i	12NZ, C12NZ	03/93 ⇒ 09/00
CORSA B 1.4i	C14NZ	03/93 ⇒ 09/00
FRONTERA A 2.4i	C24NE	03/92 ⇒ 10/98
KADETT E 1.4i	C14NZ	01/90 ⇒ 07/94
KADETT E 1.6	16SV	09/86 ⇒ 12/91
KADETT E 1.6i	16SV	07/89 ⇒ 02/93
KADETT E 1.6 S	16SV	09/86 ⇒ 08/91
KADETT E 2.0 GSI 16V	20XE	12/87 ⇒ 08/91
KADETT E 2.0 GSI 16V Cat	C20XE	03/88 ⇒ 08/91
OMEGA A 2.4i	C24NE	09/88 ⇒ 03/94
VECTRA A 1.6	16SV	09/88 ⇒ 05/93
VECTRA A 1.6 S	16SV	09/88 ⇒ 05/93
VECTRA A 2.0i 16V	20XEJ	02/89 ⇒ 10/90
VECTRA A 2.0i 16V 4x4	C20XE	08/89 ⇒ 08/95
VECTRA A 2.0i 16V Cat	C20XE	02/90 ⇒ 11/95
VECTRA A 2.0i Turbo 4x4	C20LET	06/94 ⇒ 11/95
VECTRA A 2000 16V 4x4	20XEJ	01/89 ⇒ 10/90
VECTRA A 2000/GT 16V	20XEJ	01/89 ⇒ 06/94
VECTRA A 2000/GT 16V Cat	C20XE	02/90 ⇒ 11/95
VECTRA A 2000/GT 16V Cat 4x4	C20XE	02/90 ⇒ 11/95

PUCH		
G-MODELL 230 GE	M102.989	07/89 ⇒ 08/93

SAAB		
9-3 2.0i	B204I	02/98 ⇒ 08/03
9-3 2.3i	B234I	02/98 ⇒ 08/03
900 II 2.0i	B204I, B206I	07/93 ⇒ 02/98
900 II 2.3-16	B234I	07/93 ⇒ 02/98

SEAT		
AROSA 1.0	AER, ALL	05/97 ⇒ 06/04
AROSA 1.4	AEX, AKV, APQ	05/97 ⇒ 06/04
CORDOBA I 1.0 16V	AST, AVZ	05/00 ⇒ 10/02
CORDOBA I 1.0 CL	AAU	02/93 ⇒ 06/96
CORDOBA I 1.0i	AER	09/96 ⇒ 10/02
CORDOBA I 1.3	AAV	12/93 ⇒ 08/94
CORDOBA I 1.4	ANX	12/97 ⇒ 04/99
CORDOBA I 1.4i	ABD, AEX, AKV, APQ	06/94 ⇒ 12/02
CORDOBA I 1.4i 16V	AFH	09/96 ⇒ 10/02
CORDOBA I 1.6i	1F, ABU, AEE, AFT, ALM	02/93 ⇒ 06/99
CORDOBA I 1.8i	ABS, ACC, ADZ	02/93 ⇒ 09/02
CORDOBA I 1.8i 16V	148D	10/93 ⇒ 08/96
CORDOBA I 2.0i	2E, AGG	02/93 ⇒ 06/99
CORDOBA I 2.0i 16V	ABF	08/96 ⇒ 06/99
IBIZA I 1.2i	021C.1000	01/89 ⇒ 05/93
IBIZA I 1.5i	021B.2000	10/86 ⇒ 05/93
IBIZA II 1.0	AAU	03/93 ⇒ 09/96
IBIZA II 1.0 16V	AST, AVZ	10/99 ⇒ 02/02
IBIZA II 1.0i	AER	09/96 ⇒ 02/02
IBIZA II 1.3i	AAV	03/93 ⇒ 08/99
IBIZA II 1.4	ANX	12/97 ⇒ 04/99
IBIZA II 1.4i	ABD, AEX, AKV, APQ	09/93 ⇒ 02/02
IBIZA II 1.4i 16V	AFH	06/97 ⇒ 02/02
IBIZA II 1.6i	1F, ABU, AEE, AFT, ALM	03/93 ⇒ 06/99
IBIZA II 1.8i	ABS, ACC, ADZ	03/93 ⇒ 08/99
IBIZA II 1.8i 16V	148D	11/93 ⇒ 08/96
IBIZA II 2.0i	2E, AGG	03/93 ⇒ 08/99
IBIZA II 2.0i 16V	ABF	08/96 ⇒ 08/99
INCA 1.4i	AEX, AKV, APQ	11/95 ⇒ 06/03
INCA 1.6i	1F, AEE	11/95 ⇒ 05/98
ALHAMBRA I / II 2.0i	ADY	04/96 ⇒ 03/10
MALAGA 1.5i	021B.2000	01/87 ⇒ 12/93
TOLEDO I 1.6i	1F, AFT	05/91 ⇒ 03/99
TOLEDO I 1.8 16V	KR, PL	05/91 ⇒ 03/99
TOLEDO I 1.8 GT	KR	05/91 ⇒ 11/92
TOLEDO I 1.8i	ABS, ADZ, RP	05/91 ⇒ 12/96
TOLEDO I 2.0i	2E, AGG	05/91 ⇒ 03/99

SKODA		
FELICIA 1.6	6A16XHT	06/97 ⇒ 04/02
FELICIA 1.6 GLX	6A16XHT	08/95 ⇒ 03/98
FELICIA 1.6 LX	6A16XHT	08/95 ⇒ 03/98
OCTAVIA I 1.6	6A16XHT	09/96 ⇒ 09/04

TOYOTA		
AVENSIS I 1.6	4A-FE	09/97 ⇒ 10/00
CARINA E 1.6	4A-FE	04/92 ⇒ 09/97
CARINA E 1.6 16V	4A-FE	12/94 ⇒ 09/97
CARINA E 1.6 GLI	4A-FE	04/92 ⇒ 09/97
CARINA E 1.6i	4A-FE	02/95 ⇒ 09/97

VAUXHALL		
ASTRA III 1.4i	C14NZ	09/91 ⇒ 09/98
ASTRA III 2.0i 16V	C20XE	09/91 ⇒ 02/98
ASTRAVAN I 1.4i	C14NZ	09/91 ⇒ 08/95
CALIBRA 2.0i 16V	C20XE	06/90 ⇒ 02/94
CALIBRA 2.0i 16V 4x4	C20XE	06/90 ⇒ 02/94
CALIBRA 2.0i Turbo 4x4	C20LET	03/92 ⇒ 07/97
COMBO B 1.2	C12NZ	07/94 ⇒ 10/01
COMBO B 1.4	C14NZ	07/94 ⇒ 10/01
CORSA B 1.2i	C12NZ	03/93 ⇒ 09/00
CORSA B 1.4i	C14NZ	03/93 ⇒ 09/00
CORSAVAN I 1.4i	C14NZ	01/94 ⇒ 09/00
FRONTERA A 2.4i	C24NE	03/92 ⇒ 10/98

VOLKSWAGEN (BR)		
CADDY 1.6i	MY4	11/98 ⇒
GOL 1.0i	510	11/96 ⇒
GOL 1.0i 16v	511	09/97 ⇒
GOL 1.6i	540, 541	10/96 ⇒
GOL 1.8i	542, 543	10/96 ⇒
GOL 2.0i	546, 547	10/96 ⇒
LOGUS 2.0i	809	12/92 ⇒ 05/94
PARATI 1.0i 16v	511	09/97 ⇒
PARATI 1.6i	540, 541	10/96 ⇒
PARATI 1.8i	542	10/96 ⇒
PARATI 2.0i	546, 547	10/96 ⇒
POINTER 2.0i	809	11/93 ⇒ 05/94
POLO 1.6	MJ3, MY4	07/00 ⇒
POLO 1.8	MJ2, MY5, MY6	12/96 ⇒
SAVEIRO 1.6i	540, 541	10/96 ⇒
SAVEIRO 1.8i	542, 543	10/96 ⇒
SAVEIRO 2.0i	546, 547	10/96 ⇒

VOLVO		
240 2.0	B200F	09/88 ⇒ 12/93
240 2.3	B230F, B230FD, B230FX, B230K	08/86 ⇒ 08/93
240 2.3 Cat	B230F	08/91 ⇒ 07/92
240 2.3i Cat	B230F	08/86 ⇒ 07/93
340-360 2.0	B200E, B200EA, B200F, B200K	08/84 ⇒ 07/90

VW		
PASSAT IV 1.6	ADP	10/96 ⇒ 11/00
POLO II 1.0	AAU	01/85 ⇒ 09/94
POLO II 1.0 Cat	AAU	08/89 ⇒ 09/94
POLO II 1.3	3F, AAV, GK	09/82 ⇒ 09/94
POLO II 1.3 Cat	3F, AAV	07/87 ⇒ 09/94
POLO II 1.3 G40	PY	01/87 ⇒ 09/94
JETTA II 1.8	PB, RD, RV	01/84 ⇒ 10/91
JETTA II 1.8 16V	KR, PL	08/86 ⇒ 10/91
JETTA II 1.8 Cat	PF	01/87 ⇒ 10/91
JETTA II 1.8 G60	PG	04/90 ⇒ 07/91
CADDY II 1.4	AEX, AKV, APQ	11/95 ⇒ 06/03
CADDY II 1.6	1F, AEE	11/95 ⇒ 12/00
CADDY II 60 1.4	AEX, APQ	11/95 ⇒ 01/04
CADDY II 75 1.6	1F, AEE	11/95 ⇒ 05/97
CORRADO 1.8 16V	KR	04/89 ⇒ 07/92
CORRADO 1.8 G60	PG	09/88 ⇒ 09/93
CORRADO 2.0i	2E, ADY	04/93 ⇒ 12/95
CORRADO 2.0i 16V	7T2220XS560	08/91 ⇒ 12/95
DERBY 1.3	GK	09/82 ⇒ 12/84
GOLF I 1.8	2H	08/89 ⇒ 03/93
GOLF II 1.8	RV	08/87 ⇒ 10/91
GOLF II 1.8 GTI	PB, RD	08/83 ⇒ 10/91
GOLF II 1.8 GTI 16V	KR, PL	02/86 ⇒ 10/91
GOLF II 1.8 GTI Cat	PF	01/87 ⇒ 10/91
GOLF II 1.8 GTI G60	PG	04/90 ⇒ 07/91
GOLF II 1.8 GTI G60 Syncro	1H, PG	08/88 ⇒ 12/91
GOLF II 1.8 Syncro	3E82	08/88 ⇒ 07/91
PASSAT III 1.6	AEK, AFT	07/94 ⇒ 08/96
PASSAT III 1.8	AAM, ABS, ADZ, KR, PB, PF, RP	02/88 ⇒ 05/97
PASSAT III 1.8 16V	KR	04/88 ⇒ 12/89
PASSAT III 1.8 GL	KR	08/91 ⇒ 09/93
PASSAT III 2.0	2E, ADY, AEP, AGG	02/90 ⇒ 05/97
PASSAT III 2.0 16V	7T2220XS560, ABF	08/88 ⇒ 05/97
PASSAT III 2.0 Syncro	2E, ADY, AGG	03/90 ⇒ 12/96
PASSAT III 2.0i	ACX	08/92 ⇒ 12/96
GOLF III 1.4	ABD, AEX	10/91 ⇒ 04/99
GOLF III 1.6	ABU, AEA, AEE, AEK, AFT, AKS	09/92 ⇒ 04/99
GOLF III 1.8	AAM, ABS, ADZ	08/91 ⇒ 04/99
GOLF III 1.8 Syncro	ABS, ADZ	01/93 ⇒ 04/99
GOLF III 2.0	2E, ADY, AEP, AGG, AKR	11/91 ⇒ 04/99
GOLF III 2.0 GL	AEP	08/95 ⇒ 09/97
GOLF III 2.0 Syncro	AGG	08/95 ⇒ 04/99
GOLF IV 1.6	AFT, AKS	06/98 ⇒ 06/02
GOLF IV 1.8	AAM, ADZ, ANN, ANP	06/98 ⇒ 06/02
GOLF IV 2.0	AGG, AKR, ATU, AWF, AWG	06/98 ⇒ 06/02
LUPO 1.0	AER, ALL	09/98 ⇒ 07/05
POLO III 1.4	AEX, AKV, ANX, APQ	05/97 ⇒ 09/01
POLO III 1.6	AEA, AEE, AFT, ALM	09/94 ⇒ 09/01

VW		
POLO III 100 1.4 16V	AFH	04/96 ⇒ 10/99
POLO III 100 1.6	AFT	12/95 ⇒ 09/01
POLO III 2.0	ADC	08/99 ⇒ 09/01
POLO III 45 1.0	AEV	10/94 ⇒ 09/96
POLO III 50 1.0	AER, ALL	09/96 ⇒ 10/99
POLO III 54 1.4	ANX	01/98 ⇒ 08/99
POLO III 55 1.3	ADX	10/94 ⇒ 04/97
POLO III 55 1.4	AEX	08/95 ⇒ 10/99
POLO III 60 1.4	AEX, AKV, APQ	07/95 ⇒ 09/01
POLO III 75 1.6	1F, AEA, AEE, AHS, ALM	10/94 ⇒ 10/99
POLO III 75 1.6 4motion	AEA	08/95 ⇒ 10/99
POLO III 90 1.8	ADD	01/97 ⇒ 09/01
POLO IV 1.0	AER	08/96 ⇒ 12/01
SCIROCCO I 1.1	FA	04/74 ⇒ 07/79
SCIROCCO II 1.8 16V	KR, PL	10/85 ⇒ 07/92
SHARAN I 2.0	ADY	09/95 ⇒ 03/10
TRANSPORTER IV 2.0	AAC	07/90 ⇒ 04/03
TRANSPORTER IV 2.5	AAF, ACU, AET, AEU, APL, AVT	09/90 ⇒ 06/03
TRANSPORTER IV 2.5 Syncro	AAF, ACU, AET, AEU, APL, AVT	08/92 ⇒ 04/03
VENTO 1.4	ABD	11/91 ⇒ 09/98
VENTO 1.6	ABU, AEA, AEK, AFT, AKS	09/92 ⇒ 02/99
VENTO 1.8	AAM, ABS, ADZ	11/91 ⇒ 09/98
VENTO 2.0	2E, ADY	11/91 ⇒ 09/98

EPS	1.406.122R	3
-----	------------	---

ROTORS

Adatt./Suitable: BOSCH

BOSCH

1 234 332 341
1 234 332 364
1 234 332 371

VOLVO

1357418
13574181
1367052
13670526

⁰⁰ Eliminated on 16-03-2021. Please verify the availability through our local distributors

- Eliminato il 16-03-2021. Verificare la disponibilità presso i nostri distributori
- Éliminé le 16-03-2021. Vérifier la disponibilité auprès de nos distributeurs sur place
- Am 16-03-2021 gestrichen. Evtl. Verfügbarkeit bitte bei unseren Händlern prüfen
- Eliminado en fecha 16-03-2021. Verificar la disponibilidad a través de nuestros distribuidores locales

²¹² Resistance Rotor [Ohm] 1000

- Rotore resistenza [Ohm] 1000
- Résistance rotor [ohm] 1000
- Widerstand-Rotor [Ohm] 1000
- Resistencia rotor [ohm] 1000

³¹⁰ RPM to [1/min] 6200

- N° giri fino a [1/min.] 6200
- Régime mot. jusqu'à [1/min] 6200
- Drehzahl bis [1/min] 6200
- vel. giro hasta [1/min] 6200



VOLVO		
240 2.0	B200E, B200F, B200K	08/83 ⇒ 12/93
240 2.3	B230A, B230E, B230FD, B230FX	08/83 ⇒ 08/93
240 2.3 Cat	B230F	08/91 ⇒ 07/92
340-360 2.0	B200E, B200EA, B200F, B200K	08/84 ⇒ 07/90
740 2.3	B230A	08/84 ⇒ 07/86

EPS 1.406.123R



ROTORS

Adatt./Suitable: **BOSCH****ALFA ROMEO**

60755091

1 234 332 370

SAAB
75 64 420

- 212 Resistance Rotor [Ohm] 1000**
- Rotore resistenza [Ohm] 1000
 - Résistance rotor [ohm] 1000
 - Widerstand-Rotor [Ohm] 1000
 - Resistencia rotor [ohm] 1000

**ALFA ROMEO**

33 II 1.7 16V	AR30746, AR30747	01/90 ⇒ 09/94
33 II 1.7 16V 4x4	AR30746, AR30747	01/90 ⇒ 09/94
SPIDER I 2.0i [CAN]	AR01588	09/90 ⇒ 10/93
SPIDER I 2.0i [USA]	AR01588	09/90 ⇒ 10/93
SPIDER I 2.0i Veloce [CAN]	AR01588	09/90 ⇒ 10/93
SPIDER I 2.0i Veloce [USA]	AR01588	09/90 ⇒ 10/93

SAAB

900 I 2.0 -16	5B6304GS, B202XI	01/86 ⇒ 06/94
900 I 2.0 Turbo-16	B202XL	11/85 ⇒ 06/94
900 I 2.0 Turbo-16 S	B202XL	01/84 ⇒ 06/94
900 I 2.0 Turbo-16 S Cat	B202XL	01/89 ⇒ 12/93
900 I 2.1 -16	B212I	08/90 ⇒ 06/94
9000 2.0 -16	5B6304GS, B202XI	12/85 ⇒ 01/93
9000 2.0 -16 CS	5B6304GS	01/89 ⇒ 12/98
9000 2.0 -16 Turbo	B202XL	09/84 ⇒ 08/93
9000 2.0 -16 Turbo CD	B202XL	09/88 ⇒ 08/93
9000 2.3 -16 CD	B234I	08/89 ⇒ 12/98
9000 2.3 -16 CS	B234I	09/89 ⇒ 12/98

EPS 1.406.125R



ROTORS

Adatt./Suitable: **BOSCH****BOSCH**

1 234 332 365

1 234 332 417

MERCEDES-BENZ

A 103 158 02 31

A 103 158 03 31

- 03 Supplied until depletion**
- Fornibile fino ad esaurimento delle scorte
 - Fourni jusqu'à épuisement du stock
 - Lieferbar solange vorrat reicht
 - Suministrado hasta el stock termina

- 212 Resistance Rotor [Ohm] 1000**
- Rotore resistenza [Ohm] 1000
 - Résistance rotor [ohm] 1000
 - Widerstand-Rotor [Ohm] 1000
 - Resistencia rotor [ohm] 1000

**MERCEDES-BENZ**

CLASSE E I E 300 4-matic	M103.985	06/93 ⇒ 06/95
CLASSE E I E 300 T 4-matic	M103.985	06/93 ⇒ 06/96
124 300 CE	M103.983	03/87 ⇒ 05/93
190 2.6	M103.942	10/82 ⇒ 09/88
190 E 2.6	M103.942	09/86 ⇒ 08/93
190 E 3.2 AMG	M103.983	01/88 ⇒
CLASSE G II 300 GE	M103.987	09/89 ⇒ 09/97
CLASSE S II 260 SE	M103.941	09/85 ⇒ 06/91
CLASSE S II 300 SE, SEL	M103.981	09/85 ⇒ 06/91
CLASSE SL III 300 SL	M103.982	09/85 ⇒ 08/89
CLASSE SL IV 300 SL	M103.984	09/89 ⇒ 08/93
KOMBI II 260 TE FGST.	M103.940	09/89 ⇒ 08/92
KOMBI II 300 TE	M103.983	01/86 ⇒ 08/92
KOMBI II 300 TE 4-matic	M103.985	09/86 ⇒ 06/93
TRE VOLUMI II 260 E	M103.940	09/85 ⇒ 08/92
TRE VOLUMI II 260 E 4-matic	M103.943	09/86 ⇒ 08/92
TRE VOLUMI II 300 E	M103.983	06/85 ⇒ 08/92

MERCEDES-BENZ

TRE VOLUMI II 300 E 4-matic M103.943, M103.983, M103.985 01/86 ⇒ 12/93

PUCH

G-MODELL 300 GE M103.987 06/89 ⇒ 08/93

EPS 1.406.126R



ROTORS

Adatt./Suitable: **BOSCH****BOSCH**

1 234 332 382

MERCEDES-BENZ

A 000 158 40 31

- 212 Resistance Rotor [Ohm] 1000**
- Rotore resistenza [Ohm] 1000
 - Résistance rotor [ohm] 1000
 - Widerstand-Rotor [Ohm] 1000
 - Resistencia rotor [ohm] 1000

**MERCEDES-BENZ**

CLASSE G II 500 GE	M117.965	09/93 ⇒ 12/94
CLASSE S II 420 SE, SEL	M116.965	10/85 ⇒ 06/91
CLASSE S II 420 SEC	M116.965	10/85 ⇒ 06/91
CLASSE S II 500 SE, SEL	M117.965	09/85 ⇒ 06/91
CLASSE S II 500 SE, SEL Cat	M117.965	06/89 ⇒ 06/91
CLASSE S II 500 SEC	M117.965	09/85 ⇒ 06/91
CLASSE S II 500 SEC Cat	M117.965	06/89 ⇒ 06/91
CLASSE S II 560 SE, SEL	M117.968	10/85 ⇒ 06/91
CLASSE S II 560 SEC	M117.968	10/85 ⇒ 06/91
CLASSE SL III 420 SL	M116.964	01/86 ⇒ 08/89
CLASSE SL III 500 SL	M117.964	01/86 ⇒ 08/89
CLASSE SL III 560 SL	M117.967	09/85 ⇒ 12/89

EPS 1.406.127R



ROTORS

Adatt./Suitable: **BOSCH****BOSCH**

1 234 332 381

GENERAL MOTORS

90 230 573

90 442 356

HOLDEN

VS19424

OPEL

12 12 206

12 12 224

- 212 Resistance Rotor [Ohm] 1000**
- Rotore resistenza [Ohm] 1000
 - Résistance rotor [ohm] 1000
 - Widerstand-Rotor [Ohm] 1000
 - Resistencia rotor [ohm] 1000

**HOLDEN**

CALIBRA_YE 2.0i C20NE 09/91 ⇒ 07/95

OPEL

ASCONA C 1.8	18SE, E18NV	09/81 ⇒ 08/88
ASCONA C 1.8 E	S18NV	01/85 ⇒ 08/86
ASCONA C 2.0 i	20NE	09/86 ⇒ 08/88
ASCONA C 2.0 i Cat	C20NE	09/86 ⇒ 08/88
ASCONA C 2.0 i GT	20SEH	03/87 ⇒ 08/88
ASTRA F 1.8 i	C18NZ	09/91 ⇒ 09/98
ASTRA F 2.0 i	C20NE	09/91 ⇒ 09/98
CALIBRA A 2.0 i	C20NE	08/89 ⇒ 12/96
CALIBRA A 2.0 i 4x4	C20NE	06/90 ⇒ 07/97
FRONTERA A 2.0 i	C20NE	03/92 ⇒ 10/98
KADETT E 1.8	18SE	01/86 ⇒ 08/91
KADETT E 1.8 i	C18NZ, S18NV	06/85 ⇒ 05/92
KADETT E 1.8 S	E18NV	09/87 ⇒ 08/91
KADETT E 2.0 GSI	20NE, 20SEH	09/86 ⇒ 08/91
KADETT E 2.0 GSI Cat	C20NE	09/86 ⇒ 08/91
KADETT E 2.0 i	20NE	10/86 ⇒ 02/93
KADETT E 2.0 i Cat	C20NE	10/86 ⇒ 02/93
OMEGA A 1.8	18SEH, E18NVR, S18NV	09/86 ⇒ 03/94

OPEL

OMEGA A 1.8 N	18NV	09/86 ⇒ 08/87
OMEGA A 1.8 S	18SV	09/86 ⇒ 03/94
OMEGA A 2.0	20SE, C20NE	09/86 ⇒ 04/94
OMEGA A 2.0 i	C20NE	09/86 ⇒ 04/94
OMEGA B 2.0	20SE	03/94 ⇒ 12/00
VECTRA A 1.8 i	18SV	09/88 ⇒ 10/90
VECTRA A 1.8 i Cat	C18NZ	03/90 ⇒ 11/95
VECTRA A 1.8 S	18SV, E18NVR	09/88 ⇒ 10/90
VECTRA A 1.8 S 4x4	E18NVR	01/89 ⇒ 07/89
VECTRA A 2.0 i	20NE, 20SEH	09/88 ⇒ 09/92
VECTRA A 2.0 i 4x4	20NE, 20SEH	01/89 ⇒ 07/92
VECTRA A 2.0 i Cat	C20NE	09/88 ⇒ 11/95
VECTRA A 2.0 i Cat 4x4	C20NE	01/89 ⇒ 11/95
VECTRA A 2.0 i GT	20SEH	09/88 ⇒ 11/95

VAUXHALL

ASTRA III 1.8 i	C18NZ	09/91 ⇒ 09/98
ASTRA III 2.0 i	C20NE	09/91 ⇒ 09/98
CALIBRA 2.0 i	C20NE	06/90 ⇒ 07/97
CALIBRA 2.0 i 4x4	C20NE	06/90 ⇒ 07/97
FRONTERA A 2.0	C20NE	04/95 ⇒ 08/98
FRONTERA A 2.0 i	C20NE	03/92 ⇒ 10/98
OMEGA B 2.0	20SE	09/95 ⇒ 09/96

EPS 1.406.131



ROTORS

Adatt./Suitable: **BOSCH****BOSCH**

9 231 064 336

9 231 064 346

FORD AUSTRALIA

ADR-3

HOLDEN

GB901

Motorcraft

ADR 3

**FORD AUSTRALIA**

FAIRLANE 3.2i EFI	--	01/89 ⇒
FAIRLANE 3.9i EFI	--	01/89 ⇒
FAIRLANE 3.9i MPEFi	--	01/89 ⇒
FAIRLANE 4.0i MPEFi	--	01/89 ⇒
FAIRLANE ZL 4.1i	--	01/84 ⇒
FALCON 3.2 Efi	--	03/88 ⇒ 12/88
FALCON 3.9 Efi	--	07/91 ⇒ 04/92
FALCON 3.9 MPFi	--	03/88 ⇒ 04/92
FALCON 3.9 SPFi	--	03/88 ⇒ 04/92

HOLDEN

CALAIS_VN 5.0i	5.0V8EFI	08/88 ⇒ 09/91
CALAIS_VP 5.0i Sedan	5.0V8EFI	10/91 ⇒ 07/93
CALAIS_VR 5.0i Sedan	5.0PFIV8	07/93 ⇒ 04/95
CALAIS_VS 5.0i Sedan	5.0V8PFI	04/95 ⇒ 05/96
CALAIS_VS-II 5.0i Sedan	5.0V8PFI	06/96 ⇒ 08/97
CAPRICE_VQ 5.0i Sedan	5.0V8EFI	03/90 ⇒ 11/93
CAPRICE_VR 5.0i Sedan	5.0PFIV8	12/93 ⇒ 04/95
CAPRICE_VS 5.0i Sedan	5.0V8PFI	03/95 ⇒ 08/96
CAPRICE_VS-II 5.0i Sedan	5.0V8PFI	09/96 ⇒ 08/97
COMMODORE VR 5.0i	5.0PFIV8	07/93 ⇒ 04/95
COMMODORE VR 5.0i Wagon	5.0PFIV8	07/93 ⇒ 04/95
COMMODORE VS 5.0i	5.0V8PFI	04/95 ⇒ 05/96
COMMODORE VS-II 5.0i	5.0V8PFI	06/96 ⇒ 08/97
COMMODORE_VL 5.0i Group A SS	5.0V8EFI	02/87 ⇒ 07/88
COMMODORE_VN 5.0i	5.0V8EFI	08/88 ⇒ 09/91
COMMODORE_VN 5.0i Group A SS	5.0V8EFI	08/88 ⇒ 09/91
COMMODORE_VP 5.0i	5.0V8EFI	10/91 ⇒ 07/93
FORMULA_VR 5.0i	5.0PFIV8	07/93 ⇒ 04/95
STATESMAN_VQ 5.0i	5.0V8EFI	03/90 ⇒ 11/93
STATESMAN_VR 5.0i	5.0PFIV8	12/93 ⇒ 04/95
STATESMAN_VS 5.0i	5.0V8PFI	03/95 ⇒ 08/96
STATESMAN_VS-II 5.0i	5.0V8PFI	09/96 ⇒ 08/97
UTILITY_VG 5.0i	5.0V8EFI	08/88 ⇒ 09/91
UTILITY_VP 5.0i	5.0V8EFI	10/91 ⇒ 07/93
UTILITY_VR COUPÉ 5.0i	5.0PFIV8	07/93 ⇒ 04/95

EPS 1.406.140R



3,5

ROTORS

Adatt./Suitable: BOSCH

BOSCH

1 234 332 395

FORD

6 177 981

Motorcraft

EDR 240

²¹² Resistance Rotor [Ohm] 1000

- Rotore resistenza [Ohm] 1000
- Résistance rotor [ohm] 1000
- Widerstand-Rotor [Ohm] 1000
- Resistencia rotor [ohm] 1000

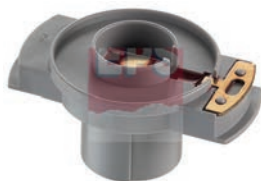

FORD

SCORPIO I 2.0 i	N9B, N9D, N9F, NRA, NRI	05/89 ⇒ 09/94
SIERRA II 2.0 i	N4A, N4I, N9B	01/87 ⇒ 02/93
TRANSIT II 2.0	NSF, NSG	06/94 ⇒ 03/00
TRANSIT II 2.0 CNG	NSH	06/94 ⇒ 03/00
TRANSIT TOURNEO 2.0	NSH	11/94 ⇒ 12/00

EPS 1.406.146R



3,5

ROTORS

Adatt./Suitable: BOSCH

BOSCH

1 234 332 408

1 234 332 422

MERCEDES-BENZ

A 119 158 01 31

A 119 158 02 31

A 119 158 03 31

²¹² Resistance Rotor [Ohm] 1000

- Rotore resistenza [Ohm] 1000
- Résistance rotor [ohm] 1000
- Widerstand-Rotor [Ohm] 1000
- Resistencia rotor [ohm] 1000



MERCEDES-BENZ

CLASSE E I E 420	M119.975	06/93 ⇒ 06/95
CLASSE E I E 500	M119.974	06/93 ⇒ 06/95
CLASSE E I E 60 AMG	M119.974(AMG6.0)	05/94 ⇒ 06/95
CLASSE S III 400 SE, SEL/S420	M119.971	02/91 ⇒ 10/98
CLASSE S III 500 SE, SEL	M119.970	02/91 ⇒ 10/98
CLASSE S III 500 SEC / CL 500	M119.970	10/92 ⇒ 12/99
CLASSE S III S 420	M119.971	01/93 ⇒ 10/98
CLASSE S III S 500	M119.970	01/93 ⇒ 10/98
CLASSE S III SEC/CL 420	M119.971	10/94 ⇒ 02/99
CLASSE SL IV 500	M119.972	09/92 ⇒ 10/01
CLASSE SL IV 500 SL	M119.960	09/89 ⇒ 08/92
TRE VOLUMI II 400 E 4.2	M119.975	10/92 ⇒ 06/93
TRE VOLUMI II 500 E	M119.974	01/91 ⇒ 06/93
TRE VOLUMI II 500 E AMG 6.0	M119.974(AMG6.0)	01/92 ⇒ 06/93

EPS 1.406.147R



3,5

ROTORS

Adatt./Suitable: BOSCH

BOSCH

1 234 332 390

RENAULT

74 31 367 783

VOLVO

1367783

13677836

²¹² Resistance Rotor [Ohm] 1000

- Rotore resistenza [Ohm] 1000
- Résistance rotor [ohm] 1000
- Widerstand-Rotor [Ohm] 1000
- Resistencia rotor [ohm] 1000



RENAULT

SAFRANE II 2.5 20V	N7U700, N7U701	07/96 ⇒ 12/00
--------------------	----------------	---------------

VOLVO

850 2.0	B5202S, B5204F, B5204FS	06/91 ⇒ 12/96
850 2.0 10V	B5202FS	08/94 ⇒ 12/97
850 2.0 Turbo	B5204FT, B5204T, B5204T2	02/93 ⇒ 10/97
850 2.3	B5234FS	01/96 ⇒ 10/96
850 2.3 T5	9M9T872	02/93 ⇒ 12/96
850 2.3 T5-R	B5234T4	08/95 ⇒ 12/96
850 2.3 Turbo R	B5234T5	06/95 ⇒ 10/97
850 2.4	B5252, B5252FS, B5254S	06/91 ⇒ 12/96
850 2.4 AWD	B5254T	04/96 ⇒ 12/96
850 2.4 GLE	B5254T	09/93 ⇒ 10/97
850 2.5 10V	B5252FS	06/91 ⇒ 12/97
850 2.5 20V	B5254FS	08/91 ⇒ 12/97
C70 I 2.0	B5204T2	03/97 ⇒ 10/05
C70 I 2.0 T	B5204T3	03/97 ⇒ 10/05
C70 I 2.3 T5	B5234T3	03/98 ⇒ 10/05
C70 I 2.3 T-5	B5234T3	03/97 ⇒ 09/02
C70 I 2.4 T	B5254T	03/97 ⇒ 10/05
S70 2.0	B5202FS, B5202S, B5204T2	01/97 ⇒ 11/00
S70 2.0 Turbo	B5204T3	01/97 ⇒ 11/00
S70 2.3	B5234FS, B5234T7	01/97 ⇒ 07/99
S70 2.3 AWD	B5234T7	04/99 ⇒ 09/00
S70 2.3 T-5	B5234T3	01/97 ⇒ 11/00
S70 2.3 T5 AWD	B5234T4	07/97 ⇒ 09/00
S70 2.3 T5-R AWD	B5234T2	11/96 ⇒ 09/98
S70 2.3 Turbo	B5234FT+	01/97 ⇒ 11/00
S70 2.4	B5254S	06/98 ⇒ 11/00
S70 2.4 AWD	B5252FS	11/96 ⇒ 05/99
S70 2.4 Bifuel	GB5252S	10/98 ⇒ 11/00
S70 2.4 T5 AWD	B5254T	11/96 ⇒ 04/99
S70 2.4 Turbo	B5254T	01/97 ⇒ 11/00
S70 2.5 20V	B5254FS	01/97 ⇒ 12/98
S70 2.5 Bifuel	GB5252S2	01/99 ⇒ 12/99
V70 I 2.0	B5202FS, B5202S, B5204T2	12/95 ⇒ 03/00
V70 I 2.0 Turbo	B5204T3	11/96 ⇒ 12/00
V70 I 2.0 Turbo AWD	B5204T3	11/96 ⇒ 12/00
V70 I 2.3	B5234FS	01/97 ⇒ 07/99
V70 I 2.3 AWD	B5234T3, B5234T7	04/97 ⇒ 09/98
V70 I 2.3 T AWD	B5234FT+, B5234T4, B5234T6	04/97 ⇒ 12/98
V70 I 2.3 T-5	B5234T3	11/96 ⇒ 12/00
V70 I 2.3 T-5 AWD	B5234T3	01/97 ⇒ 12/00
V70 I 2.3 Turbo	B5234FT+, B5234T2, B5234T4	12/95 ⇒ 12/98
V70 I 2.4	B5252FS, B5254S	12/95 ⇒ 12/99
V70 I 2.4 Bifuel	GB5252S	05/98 ⇒ 12/99
V70 I 2.4 Turbo AWD	B5254T	04/96 ⇒ 12/00
V70 I 2.5	B5252FS	01/97 ⇒ 03/00
V70 I 2.5 20V	B5254FS	01/97 ⇒ 12/99
V70 I 2.5 Bifuel	GB5252S2	01/99 ⇒ 12/99

EPS 1.406.148R



1

ROTORS

Adatt./Suitable: BOSCH

BOSCH

1 234 332 421

VW

021 905 225 B

⁰³ Supplied until depletion

- Fornibile fino ad esaurimento delle scorte
- Fourni jusqu'à épuisement du stock
- Lieferbar solange vorrat reicht
- Suministrado hasta el stock termina

²¹² Resistance Rotor [Ohm] 1000

- Rotore resistenza [Ohm] 1000
- Résistance rotor [ohm] 1000
- Widerstand-Rotor [Ohm] 1000
- Resistencia rotor [ohm] 1000



VW

CORRADO 2.9 VR6	ABV	08/91 ⇒ 12/95
GOLF III 2.8 VR6	AAA	01/92 ⇒ 09/97
PASSAT III 2.8 VR6	AAA	06/91 ⇒ 05/97
VENTO 2.8 VR6	AAA	01/92 ⇒ 09/98

EPS 1.406.149R



1

ROTORS

Adatt./Suitable: BOSCH

BOSCH

1 234 332 426

VW

021 905 225 C

²¹² Resistance Rotor [Ohm] 1000

- Rotore resistenza [Ohm] 1000
- Résistance rotor [ohm] 1000
- Widerstand-Rotor [Ohm] 1000
- Resistencia rotor [ohm] 1000



VW

CORRADO 2.9 VR6	ABV	08/91 ⇒ 12/95
GOLF III 2.8 VR6	AAA	01/92 ⇒ 09/97
PASSAT III 2.8 VR6	AAA	06/91 ⇒ 05/97
VENTO 2.8 VR6	AAA	01/92 ⇒ 09/98

EPS 1.407.701R



1

ROTORS

Adatt./Suitable: CAJAVEC

CAJAVEC
5247098YUGO
46600871ZASTAVA
46600871²¹² Resistance Rotor [Ohm] 5000

- Rotore resistenza [Ohm] 5000
- Résistance rotor [ohm] 5000
- Widerstand-Rotor [Ohm] 5000
- Resistencia rotor [ohm] 5000



ZASTAVA

101 1.1	128A.000	06/73 ⇨ 01/90
YUGO 0.9	9A	04/80 ⇨ 06/92

EPS 1.410.179



3

ROTORS

Adatt./Suitable: CHRYSLER

CHRYSLER
5226535⁰³ Supplied until depletion

- Fornibile fino ad esaurimento delle scorte
- Fourni jusqu'à épuisement du stock
- Lieferbar solange vorrat reicht
- Suministrado hasta el stock termina



CHRYSLER

LE BARON 2.2 i	--	10/83 ⇨ 12/94
LE BARON 2.2 i Turbo	--, EDG, EDR	10/83 ⇨ 01/91
LE BARON 2.5 i	EDM	09/86 ⇨ 12/94
LE BARON 2.5 i Turbo	EDT	01/89 ⇨ 12/94
VOYAGER 1.2.5 i [USA]	EDM	10/84 ⇨ 07/90
VOYAGER 2.5 i	K, K00	08/90 ⇨ 09/95

EPS 1.412.090



1

ROTORS

Adatt./Suitable: DELCO REMY

DELCO REMY

1 847 291
1 849 955
1 883 500
1 905 590
1 909 590
8 204 45GENERAL MOTORS
82 044 5Motorcraft
ADR 5004⁰³ Supplied until depletion

- Fornibile fino ad esaurimento delle scorte
- Fourni jusqu'à épuisement du stock
- Lieferbar solange vorrat reicht
- Suministrado hasta el stock termina



BEDFORD

CHEVANNE 1.3	13D, LW4	06/76 ⇨ 12/82
--------------	----------	---------------

BOND

EQUIPE 2.0 GT	--	01/68 ⇨ 12/71
---------------	----	---------------

TALBOT

AVENGER 1.3	--	02/70 ⇨ 07/81
AVENGER 1.6	--	02/70 ⇨ 07/81

TRIUMPH

GT6 MK I	KE1L	01/66 ⇨ 12/68
GT6 MK II	KE1L, KE2L	12/68 ⇨ 12/70
GT6 MK III	KE2L	12/71 ⇨ 12/73
SPITFIRE 1.2	AJM	12/64 ⇨ 01/67
SPITFIRE 1.2 MK I	AJM	10/62 ⇨ 12/65
SPITFIRE 1.3	--, FM3	02/67 ⇨ 12/72
SPITFIRE 1.5	--	12/72 ⇨ 11/74
VITESSE 1.6	--	01/62 ⇨ 12/67
VITESSE 2.0	--, HB1HE, HB1LE	12/65 ⇨ 12/71

VAUXHALL

CAVALIER 1.3	--, LW4	08/77 ⇨ 01/81
CAVALIER 1300	13N	08/77 ⇨ 08/81
CAVALIER CC 1.3	--, LW4	08/75 ⇨ 08/81
CHEVETTE 1.2	13N	09/76 ⇨ 12/85
CHEVETTE 1300	13N, 13S	09/74 ⇨ 12/85
CRESTA 2.7	--	01/64 ⇨ 10/72
CRESTA 3.3	--	01/64 ⇨ 10/72
FIRENZA 1300	--	01/71 ⇨ 10/73
VELOX 2.7	--	03/64 ⇨ 10/72
VELOX 3.3	--	09/64 ⇨ 07/65
VENTORA 3300	--	03/69 ⇨ 10/76
VICTOR 3000	--	03/68 ⇨ 09/72
VISCOUNT 3300	--	01/66 ⇨ 10/72
VIVA 1100	--	01/63 ⇨ 09/71
VIVA 1100 SL90	--	01/65 ⇨ 10/70
VIVA 1256	--	10/71 ⇨ 10/75
VIVA 1256 E	--	10/71 ⇨ 10/75
VIVA 1300	--	10/75 ⇨ 10/79

EPS 1.412.093



1

ROTORS

Adatt./Suitable: DELCO REMY

BOSCH

1 234 332 800

DELCO REMY

0 347 0056
1 212 208
3 470 056

GENERAL MOTORS

03 470 056
3 470 056

OPEL

12 12 208

⁰⁰ Eliminated on 26-10-2021. Please verify the availability through our local distributors

- Eliminato il 26-10-2021. Verificare la disponibilità presso i nostri distributori

- Éliminé le 26-10-2021. Vérifier la disponibilité auprès de nos distributeurs sur place

- Am 26-10-2021 gestrichen. Evtl. Verfügbarkeit bitte bei unseren Händlern prüfen

- Eliminado en fecha 26-10-2021. Verificar la disponibilidad a través de nuestros distribuidores locales



OPEL

KADETT B 1.1	11N	08/71 ⇨ 08/73
KADETT D 1.0	10N	09/79 ⇨ 08/82

EPS 1.412.093R



1

ROTORS

Adatt./Suitable: DELCO REMY

GENERAL MOTORS

3 470 093
3 470 391

OPEL

17 84 228
17 84 231⁰³ Supplied until depletion

- Fornibile fino ad esaurimento delle scorte
- Fourni jusqu'à épuisement du stock
- Lieferbar solange vorrat reicht
- Suministrado hasta el stock termina

²¹² Resistance Rotor [Ohm] 5000

- Rotore resistenza [Ohm] 5000
- Résistance rotor [ohm] 5000
- Widerstand-Rotor [Ohm] 5000
- Resistencia rotor [ohm] 5000



OPEL

ASCONA B 2.0 N	20N	08/77 ⇨ 08/81
CORSA A 1.0	10S	09/82 ⇨ 03/93
KADETT C 1.2	12N	05/75 ⇨ 07/79
KADETT C 1.2 S	12S	08/73 ⇨ 07/79
KADETT C 1.6 S	16S	09/76 ⇨ 07/79
KADETT E 1.2	12SC	09/84 ⇨ 07/86
MANTA B 1.2 S	12S	09/75 ⇨ 02/79
MANTA B 1.9 N	19N	08/76 ⇨ 12/81
REKORD D 1.7	17N	03/75 ⇨ 08/77

VOLVO

340-360 1.4	B14.3E, B14.4S	08/82 ⇨ 12/88
-------------	----------------	---------------

EPS 1.412.095R



1

ROTORS

Adatt./Suitable: DELCO REMY

DELCO REMY

0 348 6037
3 486 037

GENERAL MOTORS

90 010 695

OPEL

17 84 234

VOLVO

3277855
32778557⁰³ Supplied until depletion

- Fornibile fino ad esaurimento delle scorte
- Fourni jusqu'à épuisement du stock
- Lieferbar solange vorrat reicht
- Suministrado hasta el stock termina

²¹² Resistance Rotor [Ohm] 5000

- Rotore resistenza [Ohm] 5000
- Résistance rotor [ohm] 5000
- Widerstand-Rotor [Ohm] 5000
- Resistencia rotor [ohm] 5000



OPEL

CORSA A 1.0	10S	09/82 ⇨ 03/93
KADETT E 1.2	12SC	09/84 ⇨ 07/86

EPS 1.412.096



ROTORS

Adatt./Suitable: **DELCO REMY**

BOSCH

1 234 332 861

DELCO REMY

1 936 109

1 986 109

GENERAL MOTORS

01 986 109

1 986 109

OPEL

12 12 218



OPEL

ASCONA C 1.3 N	13N	09/81 ⇒ 08/86
CORSA A 1.2	12S, 12ST	09/82 ⇒ 08/90
CORSA A 1.2 N	12NV	01/90 ⇒ 03/93
CORSA A 1.2 S	12S, 12ST	09/82 ⇒ 03/93
CORSA A 1.3	13SB	02/86 ⇒ 04/89
CORSA A 1.3 GL	13S	09/82 ⇒ 03/93
CORSA A 1.3 S	13SB	09/82 ⇒ 10/89
KADETT D 1.2	12ST	08/82 ⇒ 08/84
KADETT E 1.3 N	13N, 13NB	09/84 ⇒ 08/91
KADETT E 1.3 S	13S	09/84 ⇒ 02/93
MANTA B 1.3 S	13S	08/81 ⇒ 08/86

EPS 1.412.097



ROTORS

Adatt./Suitable: **DELCO REMY**

DELCO REMY

1 988 515

D-436

GENERAL MOTORS

01 988 515

1 988 515

OPEL

12 12 221

⁰⁰ Eliminated on 17-05-2021. Please verify the availability through our local distributors

• Eliminato il 17-05-2021. Verificare la disponibilità presso i nostri distributori

• Éliminé le 17-05-2021. Vérifier la disponibilité auprès de nos distributeurs sur place

• Am 17-05-2021 gestrichen. Evtl. Verfügbarkeit bitte bei unseren Händlern prüfen

• Eliminado en fecha 17-05-2021. Verificar la disponibilidad a través de nuestros distribuidores locales



OPEL

ASCONA C 1.6	16SV	09/86 ⇒ 08/88
ASCONA C 1.6 i Cat	C16LZ, C16NZ	09/86 ⇒ 08/88

EPS 1.412.098



ROTORS

Adatt./Suitable: **DELCO REMY**

BOSCH

F 005 X04 443

F 005 X04 444

CHEVROLET

10495411

DAEWOO

10495411

DELCO REMY

1 046 7546

1 049 5408

1 049 5411

D-444

HOLDEN

10467546

10495411

ISUZU

8-10495411-0



DAEWOO

ARANOS 1.8	Y18L	01/95 ⇒ 11/97
ARANOS 2.0	Y20L	01/95 ⇒ 11/97
ESPERO 1.8	C18LE	02/95 ⇒ 06/99
ESPERO 2.0	C20LE	02/95 ⇒ 06/99
NEXIA 1.5	G15MF	02/95 ⇒ 08/97

HOLDEN

ASTRA_LD 1.6i	16LE	07/87 ⇒ 07/89
ASTRA_LD 1.8i Hatchback	18LE	07/87 ⇒ 07/89
ASTRA_LD 1.8i Sedan	18LE	07/87 ⇒ 07/89
CAMIRA 1.8 SPFi	6TZ204XS85K01	02/86 ⇒ 03/87
CAMIRA 2.0 i	C20JE	04/87 ⇒ 07/89

ISUZU

IMPULSE 1.6i [USA]	RLK	01/90 ⇒
IMPULSE 1.8i [USA]	RLX	01/91 ⇒
STYLUS 1.6i DOHC [USA]	RLK	01/90 ⇒ 12/91
STYLUS 1.6i SOHC [USA]	RLR	01/90 ⇒
STYLUS 1.8i DOHC [USA]	RLX	01/91 ⇒

EPS 1.412.100



ROTORS

Adatt./Suitable: **DELCO REMY**

GENERAL MOTORS

10 469 006

OPEL

12 12 203



OPEL

ASTRA F 1.6 i	C16NZ	09/91 ⇒ 09/98
CORSA A 1.2	12S, 12ST	09/82 ⇒ 08/90
CORSA A 1.2 N	12NV	01/90 ⇒ 03/93
CORSA A 1.2 S	12S, 12ST	09/82 ⇒ 03/93
CORSA A 1.3	13NB	09/85 ⇒ 10/89
KADETT E 1.3 i Cat	C13N	09/85 ⇒ 08/91
KADETT E 1.3 N	13N, 13NB	09/84 ⇒ 08/91
KADETT E 1.3 S	13S	09/84 ⇒ 02/93
KADETT E 1.6	16SV	09/86 ⇒ 12/91
KADETT E 1.6 i	16SV, C16NZ, E16NZ	09/86 ⇒ 07/94
KADETT E 1.6 i Cat	C16LZ, C16NZ	09/86 ⇒ 02/93
KADETT E 1.6 S	16SV	09/86 ⇒ 08/91
VECTRA A 1.6 i	C16NZ, E16NZ, X16SZ	09/88 ⇒ 11/95
VECTRA A 1.6 i Cat	C16NZ	09/88 ⇒ 11/95

VAUXHALL

ASTRA III 1.6 i	C16NZ	09/91 ⇒ 12/98
-----------------	-------	---------------

VAUXHALL

ASTRAVAN I 1.6 i	C16NZ	10/91 ⇒ 08/98
------------------	-------	---------------

EPS 1.413.014



ROTORS

Adatt./Suitable: **DENSO**

BOSCH

1 234 332 827

1 234 332 828

1 987 234 001

1 987 234 003

1 987 234 021

1 987 234 901

F 005 X04 414

DAIHATSU

19102-26150-000

19102-33012-000

19102-87204-000

19102-87701-000

DENSO

029180-0240

029180-0241

029180-0340

029180-0430

029180-0580

FIAT

553221400

6553221400

GENERAL MOTORS

7 992 988

9 977 032

94 206 140

94 216 729

94 221 206

HOLDEN

8942212060

INNOCENTI

6553221400

ISUZU

8-94206140-0

8-94216729-0

8-94221206-0

8-94221-206-00

894338910

896052016

8-96055178-0

9-42212-06

MITSUBISHI

MD604338

Motorcraft

ADR 5031

SUBARU

39101-4302

49101-3202

49101-7102

SUZUKI

33310-73010

33310-73010-000

33310-77090

33310-77090-000

TOYOTA

19102-10020

19102-26150

19102-26151

19102-33011

19102-33012

19102-38160

VW

J19 102 261 51



DAIHATSU

850 0.8	--	07/86 ⇒ 12/89
1000 1.0	CB10	07/86 ⇒ 12/89
CHARADE III 1.0	CB23, CB22	03/87 ⇒ 02/93
CUORE II 0.8	ED10	09/85 ⇒ 12/90
CUORE II 0.8 4WD	ED10	09/86 ⇒ 10/88
DOMINO 0.8	ED	08/85 ⇒ 07/90
FEROZA 1.6i	--	01/84 ⇒ 12/89
HIJET I 1.0	CB	06/86 ⇒ 12/89
MIRA 847	--	01/87 ⇒

FORD AUSTRALIA

HUSKY 1.8	ZA	01/85 ⇒
-----------	----	---------

HOLDEN

JACKAROO_UBS 2.2 4x4	4ZD1	03/87 ⇒ 10/88
RODEO_KB 2.3	2.25	03/87 ⇒ 07/88
RODEO_KB 2.3 4x4	2.25	03/87 ⇒ 07/88
RODEO_TF 2.2	4ZD1	03/91 ⇒ 08/93
SHUTTLE_WFR 2.0	4ZC1	06/86 ⇒ 06/89

INNOCENTI

500 L; LS	--	⇒ 12/86
SMALL 990	--	07/90 ⇒ 12/92

SUBARU

E-SERIES 1.0	--	01/87 ⇒ 12/88
--------------	----	---------------

1.413.027

SUBARU		
L-SERIES 1.3	--	01/87 ⇒ 12/91
L-SERIES 1.8i	--	01/86 ⇒ 12/91
SUZUKI		
ALTO I 0.8	F8A, F8B	06/82 ⇒ 08/84
SJ410 1.0	F10A	09/81 ⇒ 07/91
TOYOTA		
DYNA 1.6	1Y	05/85 ⇒ 08/87
DYNA 1.8	2Y	05/95 ⇒ 08/01
DYNA 100 1.8	2Y	08/85 ⇒ 04/95
DYNA 150 1.8	2Y	08/85 ⇒ 08/86
DYNA 150 2.0	3Y	08/85 ⇒ 08/88
HIACE III 2.0	3Y	12/82 ⇒ 08/89
HIACE III 2.0 4WD	3Y	08/87 ⇒ 07/89
HIACE III 2.2	4Y	09/87 ⇒ 08/89
HIACE III 2.2 4WD	4Y	08/87 ⇒ 08/89
HILUX IV 1.8	2Y	08/83 ⇒ 03/89
HILUX IV 2.2	4Y	08/83 ⇒ 12/89
HILUX IV 2.2 4WD	4Y	11/85 ⇒ 12/89
HILUX V 1.8	2Y	09/88 ⇒ 06/98
LITEACE 1.5	5K	10/85 ⇒ 01/95
STARLET 1.0	1E	12/89 ⇒ 12/92
STARLET 1.3 [USA]	4KE	01/82 ⇒ 12/84
STOUT 2.2	4Y	04/88 ⇒ 02/00
VW		
TARO 1.8	2Y	04/89 ⇒ 09/94
TARO 2.2	4Y	06/89 ⇒ 07/94
TARO 2.2 4x4	4Y	06/89 ⇒ 07/94

TOYOTA		
LAND CRUISER 70 2.4	22R	11/84 ⇒ 05/93
LITEACE 2.2	4Y-EC	01/92 ⇒ 01/95
MODEL F 2.0	3Y	08/88 ⇒ 01/90
MODEL F 2.2	4Y-EC	08/85 ⇒ 01/90
TRUCK 2.4i [USA]	22R	01/88 ⇒ 12/90
VAN 2.2 [USA]	4YEC	01/83 ⇒ 12/90
VW		
TARO 1.8	2Y	04/89 ⇒ 09/94
TARO 2.2	4Y	06/89 ⇒ 07/94
TARO 2.2 4x4	4Y	06/89 ⇒ 07/94

EPS 1.413.028



1

ROTORS

Adatt./Suitable: DENSO

BOSCH

1 987 234 041
F 005 X04 442

DAIHATSU

19102-87101-000
19102-87102-000

DENSO

029180-0920
029180-0921
029180-1310
029180-1391

GENERAL MOTORS

96 066 463

HOLDEN

3331082610
GD696

SUBARU

33310-71C30

SUZUKI

33310-63B10
33310-63B10-000
33310-71C30
33310-71C30-000
33310-82610
33310-82610-000

DAIHATSU

APPLAUSE I 1.6 16V	HD, HD-E	06/89 ⇒ 07/97
APPLAUSE I 1.6 16V 4WD	HD-E	06/89 ⇒ 07/97
CHARADE III 1.0i	G102	01/88 ⇒
CHARADE III 1.3	HC-C	09/88 ⇒ 02/93
CHARADE III 1.3 i	HC-E	06/88 ⇒ 12/92
CHARADE III 1.3 i 4WD	HC-E	06/88 ⇒ 01/93
CHARADE III 1.3i [USA]	HC-E	01/89 ⇒
FEROZA 1.6 16V	HD-C	10/88 ⇒ 12/99
FEROZA 1.6 16V 4x4	HD-C	10/88 ⇒ 12/99
FEROZA 1.6i 16V	HD-E	10/88 ⇒ 12/99
FEROZA 1.6i 16V 4x4	HD-E	10/88 ⇒ 12/99
FEROZA 1.6i	--	01/90 ⇒
ROCKY 2.0i [USA]	--	01/89 ⇒
SPORTTRACK 1.6 16v 4x4	HD-C	10/88 ⇒ 08/93

HOLDEN

BARINA 1.3	G13A	08/86 ⇒ 12/89
BARINA 1.3 GL	G13A	02/85 ⇒ 08/86

SUBARU

JUSTY II 1.3i	G13BA	05/96 ⇒ 09/00
---------------	-------	---------------

SUZUKI

ALTO IV 1.0	G10BB	09/94 ⇒ 06/02
ALTO V 1.0	G10BB	01/00 ⇒ 06/02
SWIFT I / II / III 1.3	G13A, G13B, G13BA	03/89 ⇒ 10/96
SWIFT I / II / III 1.3 4WD	G13A	03/89 ⇒ 12/91
SWIFT I / II / III 1.3 GTi SOHC	G13B	10/89 ⇒ 12/95
SWIFT I / II / III 1.3 i	G13BA	09/91 ⇒ 10/96
SWIFT I / II / III 1.3i SOHC [USA]	--	01/89 ⇒ 12/94
SWIFT I / II / III 1.6 i 16V	G16BA	08/92 ⇒ 10/96
SWIFT I / II / III 1.6 i 16V 4x4	G16BA	08/92 ⇒ 10/96
SA413 1.3	--	01/84 ⇒
SWIFT III 1.3 [USA]	--	06/95 ⇒ 05/01
SWIFT III 1.3 i	G13BA	06/96 ⇒ 03/01

EPS 1.413.027



1

ROTORS

Adatt./Suitable: DENSO

BOSCH

1 987 234 025
F 005 X04 493

DAIHATSU

19102-38210-000

DENSO

029180-0660

GENERAL MOTORS

12 338 891
94 844 585
94 845 144

HOLDEN

1910202010
8942389820

ISUZU

8-94238982-0

LUV CHEVROLET

94220291
94238982

TOYOTA

19102-02010
19102-15021
19102-16040
19102-16060
19102-35160
19102-38210

VW

J19 102 160 60

03 Supplied until depletion

- Fornibile fino ad esaurimento delle scorte
- Fourni jusqu'à épuisement du stock
- Lieferbar solange vorrat reicht
- Suministrado hasta el stock termina



HOLDEN

PIAZZA_YB 2.0i Turbo	2LH.C.	04/86 ⇒ 12/87
----------------------	--------	---------------

TOYOTA

CAMRY 1.8	1S	11/86 ⇒ 08/89
CARINA II 1.6	4A-LC	10/83 ⇒ 11/87
CELICA IV 1.6 GT	4A-GELC	08/87 ⇒ 08/89
CELICA IV 1.6 GT 16V	4A-GEL	09/85 ⇒ 08/89
CELICA IV 1.6 GTi 16V	4A-GEL	01/88 ⇒ 12/89
CELICA IV 2.0i [USA]	2SEL	01/85 ⇒ 12/86
COROLLA IV 1.8	3T-C	09/79 ⇒ 09/83
COROLLA V 1.6	4A-GELC	05/85 ⇒ 04/87
COROLLA V 1.6 16V	4A-GEC	12/85 ⇒ 04/87
COROLLA VI 1.6 GTi	4A-GE	08/87 ⇒ 10/94
DYNA 1.8	2Y	05/95 ⇒ 08/01
DYNA 2.0	3Y	05/95 ⇒ 10/01
DYNA 100 1.8	2Y	08/85 ⇒ 04/95
HILUX IV 1.8	2Y	08/83 ⇒ 03/89
HILUX IV 2.2	4Y	08/83 ⇒ 12/89
HILUX IV 2.2 4WD	4Y	11/85 ⇒ 12/89
HILUX V 1.8	2Y	09/88 ⇒ 06/98

EPS 1.413.029



3

ROTORS

Adatt./Suitable: DENSO

BOSCH

1 987 234 027
F 005 X04 495

DAIHATSU

19102-87703-000
19102-87705-000

DENSO

029180-0910
029180-0930
029180-1230

GENERAL MOTORS

94 404 559
94 847 241

HOLDEN

1910211010
1910211031
1910211370

ISUZU

8-94404559-0
8-94404559-9
8-94847241-0

SUBARU

22157-KA040

TOYOTA

19102-11010
19102-11030
19102-11031
19102-11050
19102-11370
19102-87705

DAIHATSU

CHARADE III 1.0	CB90	11/90 ⇒ 12/92
CHARADE III 1.0 GTi	CB80T	03/87 ⇒ 12/92
CHARADE III 1.0i [USA]	CB	01/89 ⇒
CHARADE III 1.0i 12v GTi	CB70	11/90 ⇒ 02/93

HOLDEN

APOLLO 2.0	3S-FC	08/89 ⇒ 08/91
APOLLO 2.0 i	3S-FE	08/89 ⇒ 02/93
APOLLO 2.2 i	08GR-FXS	03/93 ⇒ 05/97
NOVA_LE 1.4 Hatchback	6AFC	07/89 ⇒ 07/91
NOVA_LE 1.6 Hatchback	4AFC	07/89 ⇒ 07/91
NOVA_LE 1.6 Sedan	4AFC	07/89 ⇒ 07/91
NOVA_LF 1.6i Hatchback	4AFE	08/91 ⇒ 03/93
NOVA_LF 1.6i Sedan	4AFE	08/91 ⇒ 03/93
NOVA_LF 1.8i Hatchback	7AFE	08/91 ⇒ 03/93
NOVA_LF 1.8i Sedan	7AFE	08/91 ⇒ 03/93
NOVA_LG 1.6i Hatchback	4AFE	09/94 ⇒ 09/96
NOVA_LG 1.6i Sedan	4AFE	09/94 ⇒ 09/96
NOVA_LG 1.8i Hatchback	7AFE	09/94 ⇒ 09/96
NOVA_LG 1.8i Sedan	7AFE	09/94 ⇒ 09/96

SUBARU

JUSTY 1.2i EMPI [USA]	--	01/91 ⇒
TRENDY 1.0	EF10	08/86 ⇒ 05/95

TOYOTA

AVENSIS I 1.6	4A-FE	09/97 ⇒ 10/00
CAMRY 2.0	3S-FE	03/83 ⇒ 02/93
CAMRY 2.0 4WD	3S-FE	03/83 ⇒ 06/91
CAMRY 2.2	5S-FE	06/91 ⇒ 07/96
CARINA II 1.6	4A-F, 4A-FE	12/87 ⇒ 03/92
CARINA II 1.6 4WD	4A-FE	06/88 ⇒ 03/92
CARINA II 2.0	3S-FE	12/87 ⇒ 04/92
CARINA II 2.0 GLI	3S-FE	12/87 ⇒ 03/92
CARINA E 1.6	4A-FE	04/92 ⇒ 09/97
CARINA E 1.6 16V	4A-FE	12/94 ⇒ 09/97
CARINA E 1.6 GLI	4A-FE	04/92 ⇒ 09/97
CARINA E 1.6 i	4A-FE	02/95 ⇒ 09/97
CARINA E 2.0	3S-FE	01/93 ⇒ 09/97
CARINA E 2.0 GLI	3S-FE	04/92 ⇒ 09/97
CARINA E 2.0 GTi	3S-GE	04/92 ⇒ 12/95
CARINA E 2.0 GTi 16V	3S-GE	03/94 ⇒ 09/97
CARINA E 2.0 i	3S-FE	12/92 ⇒ 09/97
CELICA IV 1.6	4A-L	04/86 ⇒ 08/89
CELICA IV 2.0i [USA]	3S-FE	01/85 ⇒ 12/87
CELICA V 1.6	4A-FE	09/89 ⇒ 12/93
CELICA V 1.6 16V [USA] [CAN]	4A-FE	09/89 ⇒ 09/93
CELICA V 2.2	5S-FE	10/89 ⇒ 12/94
COROLLA VI 1.3	2E	05/87 ⇒ 06/92
COROLLA VI 1.3 i	2E, 2E-E	08/87 ⇒ 06/92
COROLLA VI 1.6	4A-F, 4A-FE	05/87 ⇒ 12/92
COROLLA VI 1.6 4WD	4A-F	08/87 ⇒ 08/89

TOYOTA			
COROLLA VI 1.6 GL 4WD	4A-F	10/87 ⇒ 08/90	
COROLLA VI 1.6 i	4A-FE	05/87 ⇒ 05/92	
COROLLA VI 1.6 i 4WD	4A-FE	10/87 ⇒ 08/90	
COROLLA VI 1.6 XL	4A-F	09/89 ⇒ 04/92	
COROLLA VI 1.6 XLI	4A-FE	11/89 ⇒ 06/92	
COROLLA VII 1.3 12V	2E	07/92 ⇒ 04/97	
COROLLA VII 1.3 XLI	4E-FE	07/92 ⇒ 04/97	
COROLLA VII 1.3 XLI 16V	4E-FE	07/92 ⇒ 09/95	
COROLLA VII 1.6 GLI	4A-FE	07/92 ⇒ 04/97	
COROLLA VII 1.6 Si	4A-FE	07/92 ⇒ 04/97	
COROLLA VIII 1.3	2E	05/97 ⇒ 10/01	
COROLLA VIII 1.6	4A-FE	04/97 ⇒ 02/00	
COROLLA VIII 1.6 Aut.	4A-FE	04/97 ⇒ 02/00	
FUNCRUISER 2.0 i 16V 4WD	3SFE	04/94 ⇒	
MR 2 II 2.2 16V	5S-FE	01/90 ⇒ 06/95	
HIACE IV 2.0	1RZ	08/89 ⇒ 08/04	
HIACE IV 2.4	5YTD050W07	08/89 ⇒ 08/03	
HIACE IV 2.4 4WD	5YTD050W07	08/89 ⇒ 08/95	
CELICA VI 2.2 GT	5S-FE	11/93 ⇒ 08/99	
MR 2 I 1.6 16V	4A-GELC	11/84 ⇒ 06/90	
MR 2 I 1.6 Supercharged	4A-GZE	08/86 ⇒ 12/89	
PASEO 1.5	5E-FE	06/90 ⇒ 08/95	
RAV 4 I 2.0	3S-FE	06/97 ⇒ 09/99	
RAV 4 I 2.0 4WD	3S-FE	01/94 ⇒ 06/00	
STARLET 1.3	4E-FE	01/96 ⇒ 07/99	
STARLET 1.3 12V	2E, 2E-E	12/89 ⇒ 12/92	
STARLET 1.3 12V Cat	2E-E	12/89 ⇒ 03/96	
STARLET 1.3 XL	2E	12/89 ⇒ 12/91	
TERCEL 1.5	--	01/86 ⇒	
TERCEL 1.5 [USA]	3E	01/86 ⇒ 12/90	
TERCEL 1.5 i [USA]	3EE	01/89 ⇒	

EPS 1.413.030



ROTORS

Adatt./Suitable: DENSO

DAIHATSU

19102-87206-000
19102-87704-000

DENSO

029180-0990
029180-1130
029180-1260

GENERAL MOTORS

91 125 557
94 338 910
96 052 016
96 055 178

HOLDEN

3331082010
8943389100

ISUZU

8-94338910-0

MARUTI

33310-82110

MITSUBISHI

MD620555

OPEL

42 91 891
43 13 484

PIAGGIO

19102-87704-000

SUBARU

22157-KA020

SUZUKI

33310-82010
33310-82010-000
33310-82110
33310-82110-000

TOYOTA

19102-73060
19102-75010

DAIHATSU

850 0.8	--	07/86 ⇒ 12/89
1000 1.0	CB10	07/86 ⇒ 12/89
CHARADE III 1.0	CB23, CB22	03/87 ⇒ 02/93
CUORE II 0.8	ED10	09/85 ⇒ 12/90
CUORE II 0.8 4WD	ED10	09/86 ⇒ 10/88
DOMINO 0.8	ED	08/85 ⇒ 07/90

HOLDEN

DROVER QB 1.3	G13A	02/85 ⇒ 12/87
GEMINI_RB 1.5	4XC1	04/85 ⇒ 06/87
SCURRY_NB 1.0	F10A	10/85 ⇒ 05/86

HOLDEN			
SHUTTLE_WFR 2.0	4ZC1	06/86 ⇒ 06/89	
MARUTI			
800 0.8	F8B	01/91 ⇒ 12/06	
MITSUBISHI			
VALLEY 2.0	4G63-T	09/92 ⇒ 10/94	
OPEL			
MIDI 2.0 i	20PET	09/92 ⇒ 08/94	
MIDI 2.0 i 4x4	20PET	09/92 ⇒ 08/94	
PIAGGIO			
PORTER 1.0	CB41	02/93 ⇒ 06/94	
SUBARU			
E-SERIES 1.0	--	01/88 ⇒ 12/92	
E-SERIES 1.2	--	01/87 ⇒ 12/92	
L-SERIES 1.8	--	01/86 ⇒ 12/91	
SUZUKI			
SWIFT I / II / III 1.0	G10A	03/89 ⇒ 05/01	
SWIFT I / II / III 1.0 i	G10A	03/89 ⇒ 12/91	
SWIFT I / II 1.0	G10, G10A	10/83 ⇒ 03/89	
SAMURAI 1.3 Trazione integrale	G13A	11/88 ⇒ 12/04	
SIDEKICK 1.6i [USA]	--	01/89 ⇒ 12/91	
SJ413 1.3	G13A	09/84 ⇒ 08/90	
SUPER CARRY 1.0	F10A	10/85 ⇒ 03/99	
VITARA I 1.6 8V	--	01/90 ⇒ 12/98	
TOYOTA			
DYNA 1.8	2Y	05/95 ⇒ 08/01	
DYNA 100 1.8	2Y	08/85 ⇒ 04/95	
HILUX IV 1.8	2Y	08/83 ⇒ 03/89	
HILUX IV 2.2	4Y	08/83 ⇒ 12/89	
HILUX IV 2.2 4WD	4Y	11/85 ⇒ 12/89	
HILUX V 1.8	2Y	09/88 ⇒ 06/98	
STOUT 2.2	4Y	04/88 ⇒ 02/00	

EPS 1.413.034



ROTORS

Adatt./Suitable: DENSO

DAIHATSU

19102-87207-000

DENSO

029180-1280
029180-1300

FIAT

6553206400

GENERAL MOTORS

96 061 556

INNOCENTI

6553206400

SUZUKI

33310-60B50
33310-60B50-000

* Supplied until depletion

- Fornibile fino ad esaurimento delle scorte
- Fourni jusqu'à épuisement du stock
- Lieferbar solange vorrat reicht
- Suministrado hasta el stock termina



INNOCENTI

SMALL 500	--	07/90 ⇒ 12/92
SMALL 500 Cat.	--	07/90 ⇒ 12/92

SUZUKI

SWIFT I / II / III 1.0 i	G10	03/89 ⇒ 12/05
WAGON R III 1.0	Z10XEP	06/04 ⇒ 08/05
WAGON R+ II 1.0	K10A	08/00 ⇒ 07/03
WAGON R+ II 1.0 XT Plus	--	08/00 ⇒ 07/01

EPS

1.413.036



ROTORS

Adatt./Suitable: DENSO

BOSCH

1 987 234 065

SUZUKI

33310-80C10
33310-80C10-000

TOYOTA

19102-02030
19102-74040

SUZUKI

ALTO IV 1.0	G10BB	09/94 ⇒ 06/02
ALTO V 1.0	G10BB	01/00 ⇒ 06/02
SAMURAI 1.3	G13BA	11/88 ⇒ 03/98
SAMURAI 1.3 Trazione integrale	G13A, G13BA	01/00 ⇒ 12/04

TOYOTA

CARINA E 1.6	4A-FE	04/92 ⇒ 09/97
CARINA E 1.6 16V	4A-FE	12/94 ⇒ 09/97
CARINA E 1.6 GLI	4A-FE	04/92 ⇒ 09/97
CARINA E 1.6 i	4A-FE	02/95 ⇒ 09/97
CARINA E 1.8	7A-FE	04/92 ⇒ 09/97
CARINA E 1.8 i	7A-FE	02/95 ⇒ 09/97
CARINA E 1.8 i 16V	7A-FE	01/95 ⇒ 09/97
CELICA V 2.0	3S-GE	09/89 ⇒ 01/94
CELICA V 2.0 4WD	3S-GTE	10/89 ⇒ 01/94
CELICA V 2.0 GTi	3S-GE	10/89 ⇒ 11/93
CELICA V 2.2	5S-FE	10/89 ⇒ 12/94
CELICA VI 2.0 GTi	3S-GE	08/94 ⇒ 08/99
CELICA VI 2.0 i 16V	3S-GE	11/93 ⇒ 11/99
CELICA VI 2.0 i Turbo 4WD	3S-GTE	02/94 ⇒ 11/99
CELICA VI 2.2 GT	5S-FE	11/93 ⇒ 08/99
MR 2 II 2.0	3S-FE	12/89 ⇒ 08/92
MR 2 II 2.0 16V	3S-GE	12/89 ⇒ 09/99
MR 2 II 2.0 Turbo	3S-GTE	12/89 ⇒ 07/99
PREVIA I 2.4	2TZ-FE	05/90 ⇒ 08/00
PREVIA I 2.4 4WD	2TZ-FE, 2TZ-FZE	01/90 ⇒ 12/99

EPS

1.415.080



ROTORS

Adatt./Suitable: DUCCELLIER

* Eliminated on 29-07-2019. Please verify the availability through our local distributors

- Eliminato il 29-07-2019. Verificare la disponibilità presso i nostri distributori
- Éliminé le 29-07-2019. Vérifier la disponibilité auprès de nos distributeurs sur place
- Am 29-07-2019 gestrichen. Evtl. Verfügbarkeit bitte bei unseren Händlern prüfen
- Eliminado en fecha 29-07-2019. Verificar la disponibilidad a través de nuestros distribuidores locales

*202 without resistance

- senza resistenza
- sans résistance
- ohne Widerstand
- sin resistencia



1.415.081

EPS 1.415.081  1

ROTORS

Adatt./Suitable: **DUCELLIER**

BOSCH
1 234 332 803
DUCELLIER
72 192

GENERAL MOTORS
7 992 292

RENAULT
08 54 720 000
77 01 019 885

⁰³ Supplied until depletion

- Fornibile fino ad esaurimento delle scorte
- Fourni jusqu'à épuisement du stock
- Lieferbar solange vorrat reicht
- Suministrado hasta el stock termina



RENAULT

4.0.8 | 80001 | 09/71 ⇨ 12/88

EPS 1.415.083R  3

ROTORS

Adatt./Suitable: **DUCELLIER**

ALFA ROMEO
116 55 05 011 03/01
9916117

CITROËN
54 283 90
54 283 90P
95 539 596

DUCELLIER
18 137
79 432
450 002
450 009
661 156

FIAT

9916117
9924733
9936866
9937480

GENERAL MOTORS
7 992 892

LANCIA
9924733

PEUGEOT
5937 17

RENAULT
08 55 054 100

SEAT
000 389 842 4
000 993 686 6
SE 127914.004B

TALBOT
9611 6

VOLVO
284509
2845097
3100770
31007701

²¹² Resistance Rotor [Ohm] 5000

- Rotore resistenza [Ohm] 5000
- Résistance rotor [ohm] 5000
- Widerstand-Rotor [Ohm] 5000
- Resistencia rotor [ohm] 5000



CITROËN

CX I 2400 GTi | M23-622 | 06/77 ⇨ 06/83

FIAT

124 1200	124A.000	07/66 ⇨ 10/73
124 1400 Special	124B2.000	12/68 ⇨ 12/72
124 1600 Special T	132AC.000	01/73 ⇨ 07/75
127 0.9	100GL.048	06/71 ⇨ 05/83
128 1.1	128A.000	03/69 ⇨ 12/84
131 1.3 Mirafiori	131A6.000	10/74 ⇨ 09/81
850 0.8	100G.000	07/64 ⇨ 10/72
FIORINO I 900	100GL.000	10/77 ⇨ 10/86
PANDA I 750	141B.000	01/86 ⇨ 01/95
PANDA I 800	100GL6.000	02/81 ⇨ 12/85
PANDA I 900	100GL3.000	10/80 ⇨ 06/94
PANDA I 900 CL	146A.048	01/86 ⇨ 04/91

FIAT

REGATA 1.1 60 , 60 L	1388.000	10/83 ⇨ 08/86
REGATA 1.6	149A.000	10/84 ⇨ 06/89
REGATA 70 1.3	138B2.000, 149A3.000	09/83 ⇨ 07/89
REGATA 85 1.6	149A.000	10/83 ⇨ 06/90
RITMO I 1.1	146A4.048	04/85 ⇨ 12/87
RITMO I 1.3	149A3.000	11/83 ⇨ 08/85
RITMO II 75 1.5	138A2.000	09/85 ⇨ 12/88
UNO 45 0.9	146A.000, 146A1.000	03/83 ⇨ 07/96
UNO 45 0.9 Trend	146A.048	09/89 ⇨ 09/92
UNO 60 1.1 SX	—	01/83 ⇨ 12/85

LANCIA

A 112 0.9 Junior | A112A5.000 | 03/81 ⇨ 06/86

SEAT

FURA 0.9	100GL3000	01/82 ⇨ 06/86
PANDA 34 850	—	01/80 ⇨ 12/83
PANDA 35 850	—	01/80 ⇨ 12/83

EPS 1.415.088  1

ROTORS

Adatt./Suitable: **DUCELLIER**

CHRYSLER
83 300 127
T1020357
T1407311

CITROËN
79 015 937 22

DUCELLIER
610 891
661 371
664 225

GENERAL MOTORS
93 150 104

PEUGEOT
5937 09
5937 22

RENAULT
77 01 020 357

TALBOT
9405 93 7228

⁰³ Supplied until depletion

- Fornibile fino ad esaurimento delle scorte
- Fourni jusqu'à épuisement du stock
- Lieferbar solange vorrat reicht
- Suministrado hasta el stock termina

²⁰² without resistance

- senza resistenza
- sans résistance
- ohne Widerstand
- sin resistencia



CITROËN

AXEL 11 | G11/631 | 01/84 ⇨ 03/91

PEUGEOT

104 0.9 | 108(XV5) | 10/79 ⇨ 10/83

RENAULT

5 1.4 Alpine Turbo	840726	10/81 ⇨ 01/85
11 1.4	C2J720, C2J766, C2J767, C2J768	03/83 ⇨ 12/88
14 1.4	150	09/79 ⇨ 06/83
18 1.4	847720, 847722	04/78 ⇨ 07/86
18 1.6 TS	A6M725, A6M726	05/82 ⇨ 07/86
19 I 1.2	C1G730	01/88 ⇨ 12/92
19 I 1.4	C2J772, C2J776, C3J710	07/88 ⇨ 05/93
19 I 1.4 Cat	C3J710	01/89 ⇨ 04/92
19 II 1.4	C3J710	04/92 ⇨ 12/95
21 1.4	C2J770, C2L717	06/88 ⇨ 10/93
21 1.6	C2L	01/87 ⇨ 12/94
CLIO I 1.2	C3G720	06/94 ⇨ 02/98
EXPRESS 1.2	C1G	01/85 ⇨ 10/90
EXPRESS 1.4	C1J, C2J	01/85 ⇨ 10/90
EXPRESS 1.4i	C3G/C3J	01/85 ⇨ 10/90
SUPER 5 1.2	C1G702	01/87 ⇨ 12/96
SUPER 5 1.4	C2J798	10/84 ⇨ 07/89
SUPER 5 1.4 Turbo	C1J784	04/85 ⇨ 08/90
TWINGO I 1.2	C3G700, C3G702	03/93 ⇨ 10/96

TALBOT

SAMBA 1.1 | XW7 | 01/81 ⇨ 06/86

EPS 1.415.088R  1

ROTORS

Adatt./Suitable: **DUCELLIER**

DUCELLIER
660 548

GENERAL MOTORS
7 992 639
93 150 134

PEUGEOT
5937 18

⁰⁰ Eliminated on 14-04-2020. Please verify the availability through our local distributors

- Eliminato il 14-04-2020. Verificare la disponibilità presso i nostri distributori
- Éliminé le 14-04-2020. Vérifier la disponibilité auprès de nos distributeurs sur place
- Am 14-04-2020 gestrichen. Evtl. Verfügbarkeit bitte bei unseren Händlern prüfen
- Eliminado en fecha 14-04-2020. Verificar la disponibilidad a través de nuestros distribuidores locales

¹¹¹ Paired article numbers

- N° articolo appaiato
- Numéro d'article en paire
- paargige Artikelnummer
- Referencia artículo par

1.415.088

²¹² Resistance Rotor [Ohm] 5000

- Rotore resistenza [Ohm] 5000
- Résistance rotor [ohm] 5000
- Widerstand-Rotor [Ohm] 5000
- Resistencia rotor [ohm] 5000

²¹⁸ with resistance

- con resistenza
- avec résistance
- mit Widerstand
- con resistencia

EPS 1.415.089R  3

ROTORS

Adatt./Suitable: **DUCELLIER**

DUCELLIER
660 740
662 899

GENERAL MOTORS
93 150 645

VW
052 905 225 A

⁰³ Supplied until depletion

- Fornibile fino ad esaurimento delle scorte
- Fourni jusqu'à épuisement du stock
- Lieferbar solange vorrat reicht
- Suministrado hasta el stock termina

²¹² Resistance Rotor [Ohm] 5000

- Rotore resistenza [Ohm] 5000
- Résistance rotor [ohm] 5000
- Widerstand-Rotor [Ohm] 5000
- Resistencia rotor [ohm] 5000

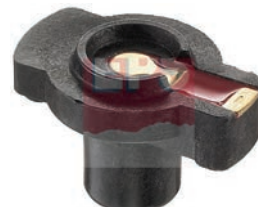

VW

DERBY 1.1	HB	02/77 ⇨ 09/81
DERBY 1.3	HH	02/77 ⇨ 09/81
POLO II 1.1	HB	10/81 ⇨ 09/89
POLO II 1.3	HH	10/81 ⇨ 07/83
SCIROCOCO I 1.1	FA	04/74 ⇨ 07/79

EPS 1.415.091



3

ROTORS

Adatt./Suitable: **DUCELLIER**

ALFA ROMEO

700 295
60748377

BOSCH

1 234 332 802
1 234 335 802

CHRYSLER

83 300 126

CITROËN

54 524 21
54 524 21W
55 081 70
95 610 822
DM 211-16

DAF

22 48 85

DUCELLIER

16 903
49 423
611 723
661 004
661 154
661 764
662 368
664 895

FEMSA

33830-1

FIAT

9934708

FORD

A790-X12200-DA

GENERAL MOTORS

7 992 291

LAND ROVER

RTC3341
RTC3616
RTC4933

Motorcraft

EDR 85

PEUGEOT

5937 05
5937 16
5937 34

RENAULT

08 54 120 600
77 01 021 981

ROVER

GRA2123

SEAT

000 993 470 8
SE 141914.004D

SEV-MARCHAL

D 4511
402 60003

TALBOT

0017 67 1100
1350 03 00
5135 00 300
7506 60 02

RENAULT

19 I 1.4	C1J	01/89 ⇒ 12/92
20 2.0	829700, 829701, 829702, 829703, 829.01	10/77 ⇒ 12/83
CLIO I 1.1	C1E700	01/91 ⇒ 09/98
EXPRESS 1.1	C1E	01/85 ⇒ 10/90
EXPRESS 955	C1C	01/85 ⇒ 10/90
FUEGO 1.6 [USA] R1368	A7L752	01/82 ⇒ 12/84
MASTER I 2.0	829731	07/80 ⇒ 06/85
MASTER I 28-35 2.0	829731	08/80 ⇒ 10/86
RAPID 1.0	C1C706	09/85 ⇒ 05/92
RAPID 1.1	C1E750, C1E752, C1E754, C1E756, C1E760, C1E762, C1E764	07/85 ⇒ 10/97
SUPER 5 1.1	C1E752, C1E754, C1E756, C1E760	10/84 ⇒ 12/96
TRAFICI 1.4	C1J700	03/80 ⇒ 06/91

ROVER

MINI 1.0	--	01/85 ⇒
MINI 1.3	--	01/85 ⇒

SEAT

IBIZA I 0.9	146A000	08/86 ⇒ 05/93
-------------	---------	---------------

TALBOT

1307-1510 Simca 1307 1.3	--	07/75 ⇒ 01/80
--------------------------	----	---------------

EPS 1.415.094



1

ROTORS

Adatt./Suitable: **DUCELLIER**

BOSCH

1 234 332 860

CHRYSLER

83 300 128

CITROËN

95 559 241

95 611 732

DUCELLIER

663 550
663 869
664 203

FIAT

9940302

LANCIA

9940302

PEUGEOT

5937 28
5937 43

RENAULT

77 01 026 824

77 01 027 870

TALBOT

0043 21 2900

111 Paired article numbers

- N° articolo appaiato
- Numéro d'article en paire
- paarige Artikelnummer
- Referencia artículo par

1.415.094R

202 without resistance

- senza resistenza
- sans résistance
- ohne Widerstand
- sin resistencia



CITROËN

AXEL 11	--	01/84 ⇒ 03/91
BX 1.1	109LA, H1A	04/86 ⇒ 06/91
BX 1.4	150C, K1F, K2D	07/86 ⇒ 12/94
BX 1.4 E	150B(XY8), 150J, 150Y, K1F, KAZ	09/82 ⇒ 12/94
BX 1.6	B2C	02/88 ⇒ 12/94
BX 1.9	159B, 159C, D6U, DKK	05/85 ⇒ 12/94
BX 1.9 GTi	D6D, D6K	01/87 ⇒ 01/92
BX 14	150C	01/86 ⇒ 02/93
BX 14 E	150A, 150C, K1G	10/82 ⇒ 02/93
BX 15	B1E(XU51C)	01/87 ⇒ 05/92
BX 16	171A, 171B, 171C, 171D, 23DH, B1E(XU51C), BAY(XU5CP), BAZ(XU5CP)	10/82 ⇒ 12/94
BX 19	159A, D2A(XU92C), D2C(XU92C), D2E, D6A(XU92J), DKZ(XU91A)	09/84 ⇒ 12/94
BX 19 Cat	DFZ(XU91J)	07/86 ⇒ 12/94
BX 19 E 4x4	D2F	04/89 ⇒ 02/93
BX 19 GTi	D6A(XU92J), DKZ(XU91A)	07/86 ⇒ 02/93
BX 19 GTi 4x4	DKZ(XU91A)	06/88 ⇒ 02/93
C15 1.0	108C	10/84 ⇒ 07/88
C15 1.0 E	TU9K	11/92 ⇒ 07/96
C15 1.1	109K, E1A, XW7	10/84 ⇒ 12/96
C15 1.3	G1A	07/87 ⇒ 05/88
C15 1.4	150D(XY7)	05/87 ⇒ 10/92
C15 1.4 E	150D(XY7)	05/87 ⇒ 12/96
CX I 2000	829A5	06/79 ⇒ 08/85
CX II 20 RE	829A5	08/85 ⇒ 12/92
CX II 22 TRS	J6TA500	07/85 ⇒ 12/92

CITROËN

GS A 1.3	G13/625	07/78 ⇒ 07/86
LNA 1.1	109/5E	07/82 ⇒ 04/85
VISA 11 E	109K	09/78 ⇒ 06/88

FIAT

DUCATO I 2.0	170B, 170D, 170C(XN1T), XN1T	01/82 ⇒ 05/94
DUCATO I 2.0 4x4	170D	06/90 ⇒ 05/94
PANDA I 1000	156A2.000	12/93 ⇒
PANDA I 1000 CLX	156A2.000	05/91 ⇒ 12/94
PANDA I 1000 Fire	156A2.000	05/86 ⇒ 04/91
PANDA I 750	156A4.000	01/86 ⇒ 10/03
PANDA I 750 Cat	156A4.048	01/95 ⇒ 10/03
PANDA I 750 Fire	156A4.048	11/88 ⇒ 04/91
TALENTO 2.0	170B	03/89 ⇒ 03/94
TIPO I 1.1	160A3.000	01/88 ⇒ 10/91
UNO 45 1.0	156A2.000	09/89 ⇒ 09/92
UNO 45 1.0 Fire	--	01/83 ⇒ 12/89
UNO 60 1.1	160A3.000	04/89 ⇒ 12/92

LANCIA

Y10 1.0 Fire Trazione integrale	156A2.000, 156A2.100, 156A2.246	12/86 ⇒ 02/92
Y10 1.1 i.e Fire	156C.000	08/89 ⇒ 06/92
Y10 1.1 i.e Fire Trazione integrale	156C.000	08/89 ⇒ 06/92

PEUGEOT

205 I 1.0	108C(XV8)	02/83 ⇒ 12/90
205 I 1.1	109F(XW7), 109N(XW7)	02/83 ⇒ 10/87
205 I 1.3	G1A	02/84 ⇒ 10/87
205 I 1.4	150(XY6B), 150B(XY8), 150D(XY7), 150G(XY7), 150H(XY8)	02/83 ⇒ 10/87
205 I 1.5	Y2/K	02/84 ⇒ 10/87
205 I 1.6	B1A(XU51C), B1E(XU51C), BAZ(XU5CP)	08/86 ⇒ 10/87
205 I 1.9 GTI	DFZ(XU91I)	03/87 ⇒ 10/87
205 II 1.1	109N(XW7)	10/87 ⇒ 10/90
205 II 1.1 XA	E1	07/87 ⇒ 10/88
205 II 1.2	F1	01/87 ⇒ 12/90
205 II 1.3	G1A	08/90 ⇒ 07/92
205 II 1.4	150(XY6B), 150B(XY8), 150D(XY7), 150G(XY7), 150H(XY8)	01/87 ⇒ 05/89
205 II 1.4 CJ	150D(XY7), 150G(XY7)	03/88 ⇒ 05/89
205 II 1.4 CT	150B(XY8), 150H(XY8)	04/86 ⇒ 12/88
205 II 1.6	B1A(XU51C), B1E(XU51C), BAZ(XU5CP)	10/87 ⇒ 09/98
205 II 1.9 CTI	DFZ(XU91I)	10/87 ⇒ 12/94
205 II 1.9 GTI Cat	DFZ(XU91I)	10/87 ⇒ 07/94
309 I 1.1	E1	10/85 ⇒ 07/89
309 I 1.3	G1A, G2S	10/85 ⇒ 08/89
309 I 1.3 XL	--	09/86 ⇒ 08/89
309 I 1.5	Y2/K	06/87 ⇒ 12/89
309 I 1.6	B1A(XU51C), B1D(XU51C), B1E(XU51C)	10/85 ⇒ 07/89
309 I 1.6 Cat	BAZ(XU5CP)	09/86 ⇒ 12/89
309 I 1.9	D2B(XU95), DFZ(XU91I), XU92C	10/85 ⇒ 07/89
309 II 1.9	XU92C	07/89 ⇒ 12/93
505 2.0	106E(XN1A)	09/85 ⇒ 09/95
604 2.0 i	XN6	01/85 ⇒ 12/86
J5 1.8	169B(XM7T)	01/83 ⇒ 11/88
J9 2.0	XN1P	03/80 ⇒ 06/87

RENAULT

5 1.4 Alpine Turbo	840726	10/81 ⇒ 01/85
9 1.2	C1G700, C1G710	09/85 ⇒ 12/88
11 1.2	C1G700, C1G710	10/84 ⇒ 12/88
11 1.4	C2J720, C2J766, C2J767, C2J768	03/83 ⇒ 12/88
18 1.4	847720, 847722	04/78 ⇒ 07/86
18 1.6 TS	AGM725, AGM726	05/82 ⇒ 07/86
18 2.0	J6R716	05/82 ⇒ 07/86
19 I 1.2	C1G730	01/88 ⇒ 12/92
19 I 1.4	C2J772, C2J776, C3J710	07/88 ⇒ 05/93
19 I 1.4 Cat	C3J710	01/89 ⇒ 04/92
19 II 1.4	C3J710	04/92 ⇒ 12/95
21 1.6	C2L	01/87 ⇒ 12/94
25 2.0	J6R706, J6R707	04/84 ⇒ 12/92
25 2.0 12V	74AR-FXE, 7CYQD80D-E3, J7R721	06/88 ⇒ 12/93
25 2.2	J7T706, J7T707	04/84 ⇒ 12/89
CLIO I 1.2	C3G720	06/94 ⇒ 02/98
ESPACE I 2.0	53AZ-FXE, J6R234, J6R236	07/84 ⇒ 12/90
ESPACE II 2.0	J7R768	01/91 ⇒ 10/96
ESPACE II 2.2	J7T772	01/91 ⇒ 10/96
ESPACE II 2.2 4x4	J7T772	03/91 ⇒ 12/96
EXPRESS 1.2	C1G	01/85 ⇒ 10/90
EXPRESS 1.4	C1J, C2J	01/85 ⇒ 10/90
EXPRESS 1.4i	C3G/C3J	01/85 ⇒ 10/90
FUEGO 1.6 [USA] R136A	A7L	01/82 ⇒ 12/86
FUEGO 1.6 [USA] R136B	A7L	01/84 ⇒ 12/86
MASTER I 2.0	J5R718, J5R728	06/85 ⇒ 12/95

CITROËN

CX I 2400	M23-623	08/76 ⇒ 06/80
-----------	---------	---------------

DACIA

1210 1.2	--	01/69 ⇒
1310 1.3	810-02/-99	05/83 ⇒ 07/04
1410 1.4	--	01/69 ⇒
ARO 10	--	01/72 ⇒ 12/80

FIAT

132 1.6	132C.000	05/77 ⇒ 09/82
DUCATO I 1.8	169B	01/82 ⇒ 12/88

LAND ROVER

90 2.5 4x4	17H	09/85 ⇒ 08/90
110/127 2.5 4x4	17H	10/85 ⇒ 07/90
DEFENDER 2.25	--	01/87 ⇒

PEUGEOT

305 1.5	117(XR55)	05/80 ⇒ 09/82
504 1.8	XM7	01/71 ⇒ 06/83
504 1.8 Injection	KF5, KF6	07/68 ⇒ 02/71
505 1.8	105(XM7), 105C(XM7A)	06/81 ⇒ 10/86
505 2.0 TI, STI	829(ZEJ)	08/79 ⇒ 10/86
J9 1.6	XC7P	03/80 ⇒ 06/87

RENAULT

4 0.8	800705	10/83 ⇒ 10/88
5 1.3	810726	09/76 ⇒ 09/79
5 1.4 Alpine A5	840725	09/77 ⇒ 09/81
9 1.1	C1E715	09/81 ⇒ 05/87
11 1.1	C1E715, C1E720	03/83 ⇒ 06/86

1.415.094R

RENAULT		
MASTER I 2.2	J7T788	08/93 ⇒ 02/98
MASTER I 28-35 2.0	J5R718	10/86 ⇒ 07/98
MASTER I 30 2.2	J7T782, J7T788	08/80 ⇒ 07/98
SUPER 5 1.2	C1G702	01/87 ⇒ 12/96
SUPER 5 1.4	C2J798	10/84 ⇒ 07/89
SUPER 5 1.4 Turbo	C1J784	04/85 ⇒ 08/90
TRAFIC I 1.4	C1J700	03/80 ⇒ 06/91
TRAFIC I 2.0	J5R716	05/89 ⇒ 08/90
TRAFIC I 2.2	J7T600, J7T780	05/89 ⇒ 04/98
TRAFIC I 2.2 4x4	J7T600, J7T780	05/89 ⇒ 04/98
TALBOT		
SOLARA 1.3	2M102.979	02/80 ⇒ 07/86
TAGORA 2.1	5N2	06/80 ⇒ 12/83

EPS 1.415.094R



ROTORS

Adatt./Suitable: **DUCELLIER**¹¹¹ Paired article numbers

- N° articolo appaiato
- Numéro d'article en paire
- paarige Artikelnummer
- Referencia artículo par

1.415.094

²¹² Resistance Rotor [Ohm] 5000

- Rotore resistenza [Ohm] 5000
- Résistance rotor [ohm] 5000
- Widerstand-Rotor [Ohm] 5000
- Resistencia rotor [ohm] 5000

²¹⁸ with resistance

- con resistenza
- avec résistance
- mit Widerstand
- con resistencia



EPS 1.415.096R



ROTORS

Adatt./Suitable: **DUCELLIER**

CITROËN

94 059 373 08

DUCELLIER

664 518
2 558 654

FIAT

9405937478

PEUGEOT

5937 30
5937 49

VOLVO

3213390
32133902
3287599
32875999⁰³ Supplied until depletion

- Fornibile fino ad esaurimento delle scorte
- Fourni jusqu'à épuisement du stock
- Lieferbar solange vorrat reicht
- Suministrado hasta el stock termina

²¹² Resistance Rotor [Ohm] 5000

- Rotore resistenza [Ohm] 5000
- Résistance rotor [ohm] 5000
- Widerstand-Rotor [Ohm] 5000
- Resistencia rotor [ohm] 5000



FIAT		
DUCATO I 2.0	170D	07/90 ⇒ 03/94
VOLVO		
340-360 1.3	B13, B13.4E	08/88 ⇒ 12/90
340-360 1.4	B14.3E, B14.4E, B14.4ED, B14.40, B14.45	08/82 ⇒ 07/91

EPS 1.415.097



ROTORS

Adatt./Suitable: **DUCELLIER**

CHRYSLER

83 300 129

DUCELLIER

665 852
666 777
2 524 132
2 559 115

RENAULT

77 00 727 261
77 01 029 972

VOLVO

3342163
33421637
3342441
3342863
33428632
3449620

RENAULT

11 1.7	F2N700	10/83 ⇒ 12/87
19 I 1.7	F2N720, F2N721, F2N722, F2N724, F3N740, F3N741, F3N742, F3N743, F3N746	07/88 ⇒ 12/92
19 II 1.7	F2N720, F2N721, F2N726, F2N727, F3N740, F3N741, F3N742, F3N743, F3N746	09/90 ⇒ 12/95
19 II 1.8	5F140FE, 8NA20S, F3P682, F3P704, F3P705, F3P706, F3P707, F3P708, F3P764, F3P765	04/92 ⇒ 06/96
21 1.7	F2N710, F2N711, F2N712, F2N722, F2N750, F2N752, F2N754, F2N758, F2N786, F3N722, F3N723, F3N726	03/86 ⇒ 12/95
21 1.7 Cat	F3N726	05/88 ⇒ 06/93
21 2.0	F2R702	09/89 ⇒ 12/91
CLIO I 1.7	F2N770	01/91 ⇒ 12/93
CLIO I 1.8	QHR10DE, F3P710, F3P714, F3P754	08/90 ⇒ 09/98
CLIO I 1.8 Rsi	F3P712, F3P758	01/93 ⇒ 09/98
LAGUNA I 1.8	F3P678, F3P720, F3P724	11/93 ⇒ 03/01
LAGUNA I 2.0	62U730, F3R722	11/93 ⇒ 03/01
SUPER 5 1.7	F2N740, F2N742, F3N716, F3N717	10/86 ⇒ 03/95
SUPER 5 1.7 i	F3N702	10/86 ⇒ 08/91
TRAFIC I 1.7	F1N720	05/89 ⇒ 08/94

VOLVO

340-360 1.7	B172K	08/85 ⇒ 07/91
440 1.6	B16F	09/88 ⇒ 12/96
440 1.7	B18E, B18EP, B18F, B18FP, B18K, B18KD, B18KP, B18KPD	08/88 ⇒ 12/96
440 1.7 Turbo	B18FT	08/88 ⇒ 12/96
440 1.8	B18U	08/91 ⇒ 12/96
440 2.0	B20F	08/92 ⇒ 07/96
460 1.6	B16F	07/92 ⇒ 07/96
460 1.7	B18EP, B18FP, B18K, B18KD, B18KP	09/88 ⇒ 07/96
460 1.7 Turbo	B18FT	08/89 ⇒ 07/96
460 1.8	B18U	08/91 ⇒ 07/96
460 2.0	B20F	08/92 ⇒ 07/96
480 1.7	B18E, B18ED, B18EP, B18F, B18FP	04/86 ⇒ 07/96
480 1.7 Turbo	B18FT	08/87 ⇒ 07/96
480 2.0	B20F	08/92 ⇒ 09/95

EPS 1.415.099R



ROTORS

Adatt./Suitable: **DUCELLIER**

AUDI

026 905 225 K

DUCELLIER

666 867

SEAT

026 905 225 K

VW

026 905 225 K

²¹² Resistance Rotor [Ohm] 1000

- Rotore resistenza [Ohm] 1000
- Résistance rotor [ohm] 1000
- Widerstand-Rotor [Ohm] 1000
- Resistencia rotor [ohm] 1000



AUDI

80 II 1.6	DT	08/78 ⇒ 03/87
80 II 1.8	DS	01/83 ⇒ 08/86
80 III 1.4	SE	08/86 ⇒ 07/88
80 III 1.6	PP, RN, RNA	09/86 ⇒ 09/91
80 III 1.8	RU	10/86 ⇒ 01/90
80 III 1.8 S	NE	09/86 ⇒ 10/91
100 III 1.8	DS, NP	08/83 ⇒ 12/90
100 III 1.8 quattro	NP, SH	10/84 ⇒ 07/90
A4 I 1.6	ADP	11/94 ⇒ 09/01

SEAT

CORDOBA I 1.6 i	1F	05/94 ⇒ 06/99
CORDOBA I 1.8 i	ABS, ACC, ADZ	02/93 ⇒ 09/02
IBIZA II 1.6 i	1F	09/94 ⇒ 06/99
IBIZA II 1.8 i	ABS, ACC, ADZ	03/93 ⇒ 08/99
INCA 1.4 i	AEX, AKV, APQ	11/95 ⇒ 06/03
INCA 1.6 i	1F, AEE	11/95 ⇒ 05/98
TOLEDO I 1.8 i	ADZ	11/93 ⇒ 12/96

VW

PASSAT II 1.6	DT	08/80 ⇒ 03/88
PASSAT II 1.8	DS	01/83 ⇒ 03/88
PASSAT II 1.8 Syncro	DS	01/86 ⇒ 03/88
PASSAT IV 1.6	ADP	10/96 ⇒ 11/00
JETTA II 1.6	ABN, EZ, EZA, PN, RF	01/84 ⇒ 07/92
JETTA II 1.8	GU	08/84 ⇒ 10/91
JETTA II 1.8 Syncro	GU	08/87 ⇒ 12/88
CADDY II 1.6	1F	11/95 ⇒ 05/97
CADDY II 75 1.6	1F	11/95 ⇒ 05/97
GOLF I 1.6	EW	08/83 ⇒ 04/92
GOLF I 1.8	EX	08/83 ⇒ 09/92
GOLF II 1.6	ABN, EZ, PN, RF	08/83 ⇒ 12/92
GOLF II 1.6 G	EZA, PN	08/86 ⇒ 07/91
GOLF II 1.8	GU	08/84 ⇒ 10/91
GOLF II 1.8 Syncro	GU	02/86 ⇒ 07/91
GOLF III 1.6	AEK	07/94 ⇒ 04/99
GOLF III 1.8	AAM, ABS, ADZ	08/91 ⇒ 04/99
GOLF III 1.8 Syncro	ABS, ADZ	01/93 ⇒ 04/99
GOLF III 2.0	ADY, AEP, AGG, AKR	11/91 ⇒ 04/99
GOLF III 2.0 GL	AEP	08/95 ⇒ 09/97
GOLF IV 2.0	AGG, AKR	06/98 ⇒ 06/02
PASSAT III 1.6	AEK	07/94 ⇒ 08/96
PASSAT III 1.8	AAM, ABS, ADZ	02/88 ⇒ 05/97
POLO III 75 1.6	1F	11/95 ⇒ 09/97
SCIROCCO II 1.6	EW, EWA, RE	01/83 ⇒ 07/90
SCIROCCO II 1.8	EX	08/83 ⇒ 07/92
VENTO 1.6	AEK	10/94 ⇒ 09/98
VENTO 1.8	AAM, ABS, ADZ	11/91 ⇒ 09/98

EPS 1.415.101



ROTORS

Adatt./Suitable: **DUCELLIER****DUCELLIER**

2 558 743

RENAULT

77 01 033 622



RENAULT

19 I 1.2i	E7F	01/89 ⇒ 12/92
19 I 1.4	E6J700, E6J701, E7J700	01/88 ⇒ 12/92
19 I 1.8 16V	F7P700, F7P704	06/89 ⇒ 09/92
19 II 1.2	E7F730	05/92 ⇒ 09/94
19 II 1.4	E6J706, E7J706, E7J707, E7J742, E7J745	01/92 ⇒ 12/95
19 II 1.8 16V	F7P704	04/92 ⇒ 06/96
21 2.0	J7R740	02/90 ⇒ 06/94
21 2.0 4x4	J7R740	12/89 ⇒ 02/94
21 2.0 Turbo	J7R752, J7R756	04/87 ⇒ 10/92
21 2.0 Turbo 4x4	J7R752, J7R756	08/89 ⇒ 10/93
21 2.0 TXi	15CRMP10U1, J7R740	07/89 ⇒ 05/93
25 2.0 12V	74AR-FXE, 7CYQD80D-E3, J7R721	06/88 ⇒ 12/93
CLIO I 1.2	E5F710, E5F716, E7F700, E7F706, E7F708, E7F750	05/90 ⇒ 09/98
CLIO I 1.4	E6J712, E6J713, E6J718, E7J601, E7J710, E7J711, E7J716, E7J718, E7J719, E7J754, E7J756, E7J757	01/90 ⇒ 09/98
CLIO I 1.8 16V	F7P720, F7P722	01/91 ⇒ 03/96
CLIO I Williams	F7R700	01/94 ⇒ 09/98
MEGANE I 1.4	E7J764	09/96 ⇒ 08/03
MEGANE I 1.4 e	E7J764	01/96 ⇒ 08/03
MEGANE I 1.4 Eco	E7J624	01/96 ⇒ 03/99
MEGANE SCÉNIC I 1.4 i	E7J764	01/97 ⇒ 09/99
RAPID 1.4	E6J738, E7J720, E7J724, E7J726, E7J728, E7J770, E7J771, E7J773	09/91 ⇒ 03/98
RAPID 1.4 RN	E6J734	09/91 ⇒ 08/93
SAFRANE I 2.0	0LJY, J7R732, J7R738, J7R739	08/92 ⇒ 09/96
SAFRANE I 2.0 12V	J7R734, J7R735	04/92 ⇒ 07/96
SAFRANE I 2.2	1MR479QB, J7T761, J7T762	04/92 ⇒ 07/96
TRAFIC I 2.0	J5R726	05/89 ⇒ 08/90
TRAFIC I 2.0 RWD	J5R726	05/89 ⇒ 10/97

EPS 1.415.102R



ROTORS

Adatt./Suitable: **DUCELLIER****CITROËN**

95 651 019

PEUGEOT

5937 47

²¹²Resistance Rotor [Ohm] 1000

- Rotore resistenza [Ohm] 1000
- Résistance rotor [ohm] 1000
- Widerstand-Rotor [Ohm] 1000
- Resistencia rotor [ohm] 1000



CITROËN

AX 1.3 Sport	M4A	04/87 ⇒ 12/88
AX 10	C1A	09/86 ⇒ 06/92
AX 10 E	C3A	12/86 ⇒ 12/88
AX 11	H1A, H1B, HDZ(TU1M)	09/86 ⇒ 12/97
AX 11 4x4	H1A	06/91 ⇒ 07/92
AX 11 Cat	HAZ(TU1CP)	09/88 ⇒ 12/89

CITROËN

AX 14	K1A(TU3), K1B, K1F, K1G, K1J, K2A, K2B, K2D, KAY(TU3CP), KDX(TU3M/Z), KDY(TU3FM), KDY(TU3M), KDZ(TU3M/Z)	09/86 ⇒ 04/97
AX 14 4x4	KD4, KDX(TU3M/Z), KDY(TU3FM), KDY(TU3M), KDZ(TU3M/Z)	06/91 ⇒ 12/96
AX 14 GT	KDZ(TU3M/Z)	01/89 ⇒ 12/91
BX 1.1	109LA, H1A	04/86 ⇒ 06/91
BX 1.4	150C, K1F, K2D	07/86 ⇒ 12/94
BX 1.4 E	150B(XY8), 150J, 150Y, K1F, KAZ	09/82 ⇒ 12/94
BX 1.6	B2C	02/88 ⇒ 12/94
BX 1.9	159B, 159C, D6U, DKK	05/85 ⇒ 12/94
BX 1.9 GTi	D6D, D6K	01/87 ⇒ 01/92
BX 14	150C, KDY(TU3M), KDZ(TU3M/Z)	01/86 ⇒ 02/93
BX 14 E	150A, 150C, K1G	10/82 ⇒ 02/93
BX 15	B1E(XU51C)	01/87 ⇒ 05/92
BX 16	171A, 171B, 171C, 171D, 23DH, B1E(XU51C), BAY(XU5CP), BAZ(XU5CP), BDY(XU5M), BDZ(XU5M)	10/82 ⇒ 12/94
BX 16 E	BDY(XU5M), BDZ(XU5M)	05/89 ⇒ 02/93
BX 19	159A, D2A(XU92C), D2C(XU92C), D2E, D6A(XU9J2), DDZ(XU9M), DKZ(XU9JA)	09/84 ⇒ 12/94
BX 19 4x4	DDZ(XU9M)	10/90 ⇒ 05/91
BX 19 Cat	DFZ(XU9J1)	07/86 ⇒ 12/94
BX 19 E	DDZ(XU9M)	06/88 ⇒ 02/93
BX 19 E 4x4	D2F	04/89 ⇒ 02/93
BX 19 GTi	D6A(XU9J2), DKZ(XU9JA)	07/86 ⇒ 02/93
BX 19 GTi 4x4	DKZ(XU9JA)	06/88 ⇒ 02/93
C15 1.0	108C(XV8), C1A, C1A(TU9/K), C1B(TU9/W), TU9	10/84 ⇒ 12/97
C15 1.1	H1A, HDZ(TU1M), TU1	08/88 ⇒ 07/96
C15 1.1 i	HDZ(TU1M), TU1MZ	07/88 ⇒ 12/96
C15 1.4	K1A, K1G, K1H(TU3A), KDY(TU3M)	07/87 ⇒ 12/96
C15 1.4 E	K1F, K1J, K2D, K3A, KAZ	07/86 ⇒ 12/96
C15 1.4 i	KDY(TU3FM), KDY(TU3M)	05/91 ⇒ 12/96
JUMPER I 2.0	XU102C	02/94 ⇒ 02/02
XM I 2.0	--	05/89 ⇒ 04/94
XM I 2.0 i	RDZ(XU10MZ), RFZ(XU10J2)	05/89 ⇒ 06/94
BERLINGO I 1.4	TU32	07/96 ⇒ 10/98
ZX 1.1	H1A, H1B, HDZ(TU1M), TU1	03/91 ⇒ 06/97
ZX 1.4 i	KDY(TU3M)	10/93 ⇒ 10/97
ZX 1.9	D6E(XU9JA)	03/91 ⇒ 06/97
ZX 1.9 i	DKZ(XU9JA), XU9JA	03/91 ⇒ 06/97

PEUGEOT

106 I 1.0	TU9	09/91 ⇒ 03/01
106 I 1.1	H1B(TU1), HDZ(TU1M)	08/91 ⇒ 04/96
106 I 1.4	K5A(TU3), KDY(TU3M), TU3.2	08/91 ⇒ 04/96
106 II 1.1	H1B(TU1)	04/96 ⇒
205 I 1.4	TU3	01/83 ⇒ 12/90
205 I 1.6	B1A(XU51C), B1E(XU51C)	08/86 ⇒ 10/87
205 II 1.0	TU9	10/87 ⇒ 09/98
205 II 1.1	H1B(TU1), HDZ(TU1M)	10/87 ⇒ 09/98
205 II 1.1 CJ	HDZ(TU1M)	10/89 ⇒ 12/94
205 II 1.4	K1D(TU3A), K2B(TU3S), KDY(TU3M), KDZ(TU3M)	06/87 ⇒ 09/98
205 II 1.4 CJ	K1D(TU3A), KDY(TU3M)	03/89 ⇒ 12/94
205 II 1.6	B1A(XU51C), B1E(XU51C)	10/87 ⇒ 09/98
205 II 1.9 GTI	DKZ(XU9JAZ)	10/87 ⇒ 10/94
306 1.4	TU3	01/93 ⇒ 04/02
309 I 1.4	K1D(TU3A), K2B(TU3S), KDY(TU3M), KDZ(TU3M)	08/88 ⇒ 08/89
309 II 1.1	H1B(TU1), HDZ(TU1M)	09/89 ⇒ 12/93
309 II 1.4	KDZ(TU3M), TU3, TU3F2	07/89 ⇒ 12/93
309 II 1.6	18EM, BDZ(XU5M)	07/89 ⇒ 12/93
309 II 1.9	DDZ(XU9M), XU92C	07/89 ⇒ 12/93
309 II 1.9 GTI	DKZ(XU9JAZ)	07/89 ⇒ 12/93
405 I 1.4	K5A(TU3), TU3A, TU3F2	01/87 ⇒ 12/92
405 I 1.6	--, 18EM, B1E(XU51C), BDZ(XU5M)	01/87 ⇒ 12/92
405 I 1.6 4x4	BDZ(XU5M)	04/88 ⇒ 07/92
405 I 1.6 SRI 4x4	BDZ(XU5M)	04/88 ⇒ 07/92
405 I 1.9	D2C(XU92C), DDZ(XU9M), DFZ(XU9J1), DKZ(XU9JAZ), XU9J2, XU9J2/D6D	01/87 ⇒ 12/92
405 I 1.9 4x4	DDZ(XU9M), DKZ(XU9JAZ)	06/87 ⇒ 12/92
405 I 1.9 Antipollution	XU92C	01/87 ⇒ 12/92
405 I 1.9 Injection	DFZ(XU9J1)	07/87 ⇒ 12/92
405 I 1.9 Trazione integrale	DFZ(XU9J1)	09/88 ⇒ 07/92
405 II 1.4	TU3F2	01/93 ⇒ 12/96
405 II 1.6	18EM	08/92 ⇒ 05/97
405 II 1.9	XU92C	01/93 ⇒ 12/96
605 2.0	--, R5A(XU102C), XU10M	01/89 ⇒ 09/99

EPS 1.415.103R



ROTORS

Adatt./Suitable: **DUCELLIER****GENERAL MOTORS**

90 376 979

90 540 398

OPEL

12 12 204

12 12 207

²¹²Resistance Rotor [Ohm] 1000

- Rotore resistenza [Ohm] 1000
- Résistance rotor [ohm] 1000
- Widerstand-Rotor [Ohm] 1000
- Resistencia rotor [ohm] 1000



OPEL

ASTRA F 1.6	16LZ2, 16N2Z	09/94 ⇒ 09/98
ASTRA F 1.8 i	C18NZ	09/91 ⇒ 09/98
ASTRA F 2.0 i	C20NE	09/91 ⇒ 09/98
CALIBRA A 2.0 i	C20NE	08/89 ⇒ 12/96
CALIBRA A 2.0 i 4x4	C20NE	06/90 ⇒ 07/97
FRONTERA A 2.0 i	C20NE	03/92 ⇒ 10/98
KADETT E 1.8	18SE	01/86 ⇒ 08/91
KADETT E 1.8 i	C18NZ, S18NV	06/85 ⇒ 05/92
KADETT E 2.0 GSI	20NE, 20SEH	09/86 ⇒ 08/91
KADETT E 2.0 GSI Cat	C20NE	09/86 ⇒ 08/91
KADETT E 2.0 i	20NE	10/86 ⇒ 02/93
KADETT E 2.0 i Cat	C20NE	10/86 ⇒ 02/93
OMEGA A 1.8	18SEH, E18NVR, S18NV	09/86 ⇒ 03/94
OMEGA A 1.8 N	18NV	09/86 ⇒ 08/87
OMEGA A 1.8 S	18SV	09/86 ⇒ 03/94
OMEGA A 2.0	20SE, C20NE	09/86 ⇒ 04/94
OMEGA A 2.0 i	C20NE	09/86 ⇒ 04/94
OMEGA B 2.0	20SE	03/94 ⇒ 12/00
VECTRA A 1.6	C16L2Z	08/92 ⇒ 07/93
VECTRA A 1.6 i	C16N2Z	09/88 ⇒ 11/95
VECTRA A 1.6 i Cat	C16N2Z	09/88 ⇒ 11/95
VECTRA A 1.8 i	18SV	09/88 ⇒ 10/90
VECTRA A 1.8 i Cat	C18NZ	03/90 ⇒ 11/95
VECTRA A 1.8 S	18SV, E18NVR	09/88 ⇒ 10/90
VECTRA A 1.8 S 4x4	E18NVR	01/89 ⇒ 07/89
VECTRA A 2.0 i	20NE, 20SEH	09/88 ⇒ 09/92
VECTRA A 2.0 i 4x4	20NE, 20SEH	01/89 ⇒ 07/92
VECTRA A 2.0 i Cat	C20NE	09/88 ⇒ 11/95
VECTRA A 2.0 i Cat 4x4	C20NE	01/89 ⇒ 11/95
VECTRA A 2.0 i GT	20SEH	09/88 ⇒ 11/95
VECTRA B 1.6 i	16L2Z	10/95 ⇒ 07/03

VAUXHALL

ASTRA III 1.8 i	C18NZ	09/91 ⇒ 09/98
ASTRA III 2.0 i	C20NE	09/91 ⇒ 09/98
CALIBRA 2.0 i	C20NE	06/90 ⇒ 07/97
CALIBRA 2.0 i 4x4	C20NE	06/90 ⇒ 07/97
FRONTERA A 2.0	C20NE	04/95 ⇒ 08/98
FRONTERA A 2.0 i	C20NE	03/92 ⇒ 10/98
OMEGA B 2.0	20SE	09/95 ⇒ 09/96

1.415.104

EPS 1.415.104



3

ROTORS

Adatt./Suitable: **DUCELLIER****DUCELLIER**2 537 260
PEUGEOT
5937 44⁰³ Supplied until depletion

- Fornibile fino ad esaurimento delle scorte
- Fourni jusqu'à épuisement du stock
- Lieferbar solange vorrat reicht
- Suministrado hasta el stock termina

**CITROËN**

BX 1.9 GTi 16V	159K, DFK	01/87 ⇨ 12/94
BX 19 GTi 16V	D6C(XU9J4), DFW(XU9J4)	09/87 ⇨ 02/93

PEUGEOT

309 II 1.9 GTi 16V	D6C(XU9J4)	08/89 ⇨ 07/90
405 I 1.9	D6C(XU9J4)	06/87 ⇨ 07/92
405 I 1.9 4x4	D6C(XU9J4)	06/87 ⇨ 07/92
405 I 1.9 Sport MI-16	D6C(XU9J4), DFW(XU9J4Z)	06/87 ⇨ 11/92
405 I 1.9 SPort MI-16 4x4	DFW(XU9J4Z)	06/87 ⇨ 07/92
405 I 1.9 Trazione integrale	D6C(XU9J4)	06/87 ⇨ 07/92

EPS 1.417.052



3,5

ROTORS

Adatt./Suitable: **FEMSA****FEMSA**12133- 1
12133- 4
22488- 1⁰³ Supplied until depletion

- Fornibile fino ad esaurimento delle scorte
- Fourni jusqu'à épuisement du stock
- Lieferbar solange vorrat reicht
- Suministrado hasta el stock termina

FIAT3892873
3895702
9936807**FIAT (YV)**

7073054/1

RENAULT

08 57 113 700

SEAT000 389 287 3
3892873
NG1 213 340 6¹¹¹ Paired article numbers

- N° articolo appaiato
- Numéro d'article en paire
- paarige Artikelnummer
- Referencia artículo par

1.417.052R²⁰² without resistance

- senza resistenza
- sans résistance
- ohne Widerstand
- sin resistencia

**FIAT**

131 1.3 Mirafiori	131A6.000	10/74 ⇨ 09/81
-------------------	-----------	---------------

SEAT

RONDA 1.2	021A1000	08/83 ⇨ 05/85
RONDA 1.6	138AR6.000	08/83 ⇨ 09/85

EPS 1.417.052R



3,5

ROTORS

Adatt./Suitable: **FEMSA****FEMSA**

32493

FIAT

9936831

SEAT

000 993 683 1

SE 141914.004C

¹¹¹ Paired article numbers

- N° articolo appaiato
- Numéro d'article en paire
- paarige Artikelnummer
- Referencia artículo par

1.417.052²¹² Resistance Rotor [Ohm] 5000

- Rotore resistenza [Ohm] 5000
- Résistance rotor [ohm] 5000
- Widerstand-Rotor [Ohm] 5000
- Resistencia rotor [ohm] 5000

²¹⁸ with resistance

- con resistenza
- avec résistance
- mit Widerstand
- con resistencia

**FIAT**

127 0.9	100GL.048	06/71 ⇨ 05/83
132 1.6	132C.000	05/77 ⇨ 09/82
PANDA I 800	100GL6.000	02/81 ⇨ 12/85

SEAT

FURA 0.9	100GL3000	01/82 ⇨ 06/86
IBIZA I 0.9	146A000	08/86 ⇨ 05/93
MARBELLA 0.8	5K9K718	08/86 ⇨ 12/93
MARBELLA 0.9	09NCA	01/87 ⇨ 12/93
PANDA 0.9	100GL3000	10/80 ⇨ 12/86
PANDA 34 850	--	01/80 ⇨ 12/83
PANDA 35 850	--	01/80 ⇨ 12/83
PANDA 45	--	01/82 ⇨ 12/85
TERRA 0.9	09NCA	02/87 ⇨ 12/96

EPS 1.417.058



1

ROTORS

Adatt./Suitable: **FEMSA****BOSCH**

9 231 334 371

FEMSA

28994- 1

28994- 1J

LAND ROVER

00000A00070

RENAULT

77 02 124 320

⁰³ Supplied until depletion

- Fornibile fino ad esaurimento delle scorte
- Fourni jusqu'à épuisement du stock
- Lieferbar solange vorrat reicht
- Suministrado hasta el stock termina

**RENAULT**

4 0.8	80001	09/71 ⇨ 12/88
4 1.1	688712	02/78 ⇨ 06/90
5 1.4	847725	01/82 ⇨ 12/85
9 1.2	C1G700, C1G710	09/85 ⇨ 12/88
11 1.2	C1G700, C1G710	10/84 ⇨ 12/88
11 1.4	C2J720, C2J766, C2J767, C2J768	03/83 ⇨ 12/88
11 1.7	F2N700	10/83 ⇨ 12/87
18 1.4	847720, 847722	04/78 ⇨ 07/86
19 I 1.2	C1G730	01/88 ⇨ 12/92
19 I 1.4	C2J772, C2J776, C3J710	07/88 ⇨ 05/93
19 I 1.4 Cat	C3J710	01/89 ⇨ 04/92
19 II 1.4	C3J710	04/92 ⇨ 12/95
EXPRESS 1.1	C1E	01/85 ⇨ 10/90
EXPRESS 955	C1C	01/85 ⇨ 10/90

RENAULT

RAPID 1.1	C1E750, C1E760	07/85 ⇨ 04/95
SUPER 5 1.0	C1C700	10/84 ⇨ 10/88

EPS 1.419.085



1

ROTORS

Adatt./Suitable: **FORD****FORD**0 267 26
1 444 043
5 014 405
C6AH-12200-A
C7AH-12200-A
D5FZ-12200-A
DORY-12200-A²⁰² without resistance

- senza resistenza
- sans résistance
- ohne Widerstand
- sin resistencia

GENERAL MOTORS

7 992 217

Motorcraft

DR 220A

DRE 90

EDR 3

EDR 3 D

EDR 3 S

**FORD**

CORTINA 1300	KL13H	10/70 ⇨ 03/72
FIESTA I 0.9	TKA, TKW, TLA	05/76 ⇨ 08/83
TAUNUS 1.6	LCJ	07/79 ⇨ 07/82
TRANSIT I 1.6	4RB	11/77 ⇨ 10/86
TRANSIT I 2.0	4RC	11/77 ⇨ 07/82

EPS 1.419.092



1

ROTORS

Adatt./Suitable: **FORD****CHRYSLER**

56 027 075

FORD1 643 692
E6EE-12200-AA
E6FZ-12200-A⁰³ Supplied until depletion

- Fornibile fino ad esaurimento delle scorte
- Fourni jusqu'à épuisement du stock
- Lieferbar solange vorrat reicht
- Suministrado hasta el stock termina

JEEP

33003389

56027075

MAZDA

ZZMO-24-312

Motorcraft

DR 375A

RENAULT

89 33 003 389

**FORD**

SCORPIO I 2.4 i	ARC	09/86 ⇨ 09/88
SCORPIO I 2.9 i	BRC, BRD, BRE, BRF	09/86 ⇨ 12/94
SCORPIO I 2.9 i 4x4	BRC, BRD, BRE, BRF	09/86 ⇨ 10/94
SCORPIO I 2.9 i Cat	BRE	10/87 ⇨ 08/94
SCORPIO II 2.9 i	BRG	02/95 ⇨ 08/98

JEEP

CHEROKEE II 4.0 i	--, 127K, ERH, MX	10/86 ⇨ 09/01
CHEROKEE II 4.0 i 4x4	ERH	01/95 ⇨ 09/01
COMANCHE 4.0 i	127K	10/87 ⇨ 09/90
GRAND WAGONEER 4.0 i	127K	10/86 ⇨ 09/90
WAGONEER 4.0 i	127K	10/86 ⇨ 09/90
WRANGLER 2.5	EPE	12/91 ⇨ 08/96
WRANGLER 4.0	127K, ERH	10/86 ⇨ 08/96

EPS 1.419.094R



ROTORS

Adatt./Suitable: FORD

FORD

1 649 200
E7EE-12200-DA**00 Eliminated on 04-08-2020. Please verify the availability through our local distributors**

- Eliminato il 04-08-2020. Verificare la disponibilità presso i nostri distributori
- Éliminé le 04-08-2020. Vérifier la disponibilité auprès de nos distributeurs sur place
- Am 04-08-2020 gestrichen. Evtl. Verfügbarkeit bitte bei unseren Händlern prüfen
- Eliminado en fecha 04-08-2020. Verificar la disponibilidad a través de nuestros distribuidores locales

212 Resistance Rotor [Ohm] 1000

- Rotore resistenza [Ohm] 1000
- Résistance rotor [ohm] 1000
- Widerstand-Rotor [Ohm] 1000
- Resistencia rotor [ohm] 1000



FORD

SIERRA II 1.8 | RZC, R6A | 05/88 ⇨ 02/93

EPS 1.422.052



ROTORS

Adatt./Suitable: HITACHI

BOSCH

1 987 234 015
F 005 X04 557

HITACHI

44A2-16001
44R84-16002

HOLDEN

22157H9560
GH605

HONDA

30103-657-005

NISSAN

22149-B8900
22149-N3602
22157-H3602
22157-H9560
22157-N3602
22157-U6001
22157-U6091
22157-U6091MP
22157-U6094
22157-U6094DY

SUBARU

22157-AA030
49101-8711

HOLDEN

ASTRA_LB 1.5 | E15 | 08/84 ⇨ 01/86
ASTRA_LC 1.6 | E16S | 02/86 ⇨ 06/87

NISSAN

PULSAR 1.6 | E16 | 01/84 ⇨ 12/86
PULSAR 1.6 [USA] | E16 | 01/82 ⇨ 12/83

SUBARU

L-SERIES 1.3 | -- | 01/79 ⇨ 12/87
L-SERIES 1.6 | -- | 01/86 ⇨ 12/87

EPS 1.422.056



ROTORS

Adatt./Suitable: HITACHI

ACURA

30103-PAI-732

BOSCH

1 987 234 042

HONDA

30103-PA1-732
30103-PA1-733
30103-PAI-732
30103-PC3-822
30103-PE9-006

ROVER

GRA2245

03 Supplied until depletion

- Fornibile fino ad esaurimento delle scorte
- Fourni jusqu'à épuisement du stock
- Lieferbar solange vorrat reicht
- Suministrado hasta el stock termina



ACURA

INTEGRA I 1.6 | D16A1 | 01/85 ⇨ 12/90
INTEGRA I 1.6 i | D16A8 | 01/85 ⇨ 12/90

HONDA

ACCORD III 1.6 L	A16A1	11/85 ⇨ 12/89
ACCORD III 2.0	A20A2	01/86 ⇨ 12/86
ACCORD III 2.0 12V	A20A1, A20A3	01/86 ⇨ 12/89
ACCORD III 2.0 16V EXS	B20A2	01/88 ⇨ 12/89
ACCORD III 2.0 EX	A20A1, A20A2	11/85 ⇨ 12/89
ACCORD III 2.0 EXi	A20A3, A20A4	11/85 ⇨ 12/89
ACCORD III 2.0 i 16V	B20A2, B20A8	01/87 ⇨ 12/89
ACCORD VI 1.6	A16A5	10/98 ⇨ 12/02
CIVIC II 1.3 [USA]	--	01/81 ⇨ 12/83
CIVIC III 1.5 i Si [USA]	--	01/84 ⇨ 12/87
JAZZ I 45 1.2	ER2	02/84 ⇨ 10/86

ROVER

200 I 213 S | EV2 | 09/85 ⇨ 09/89

EPS 1.422.066



ROTORS

Adatt./Suitable: HITACHI

NISSAN

22157-18F00
22157-20R00**03 Supplied until depletion**

- Fornibile fino ad esaurimento delle scorte
- Fourni jusqu'à épuisement du stock
- Lieferbar solange vorrat reicht
- Suministrado hasta el stock termina



NISSAN

200 SX 1.8i Turbo	CA18ET	01/87 ⇨
BLUEBIRD 2.0 i	CA20E	04/84 ⇨ 12/90
PICK UP I 2.4 [USA]	Z24i	01/85 ⇨ 12/89
STANZA 2.0 [USA]	CA20	01/82 ⇨ 12/87
TERRANO I 2.4 i 4WD	Z24i	10/87 ⇨ 02/93
URVAN III 2.4 i	Z24i	05/89 ⇨ 09/93
VAN 2.4 [USA]	Z24i	01/86 ⇨ 12/89
VANETTE II 2.0	Z20S	07/87 ⇨ 08/94

EPS 1.422.069



ROTORS

Adatt./Suitable: HITACHI

BOSCH

F 005 X04 502

GENERAL MOTORS

94 174 468

HOLDEN

8941744680

HONDA

8-94174-468-0

ISUZU

8-94174468-0

OPEL

43 12 974



HOLDEN

JACKAROO_UBS 2.6i 4x4	4ZE1	11/88 ⇨ 12/91
RODEO_TF 2.6i	4ZE1	08/88 ⇨ 03/96
RODEO_TF 2.6i 4x4	4ZE1	08/88 ⇨ 03/96

HONDA

PASSPORT 2.6 i [USA] | 4ZE1 | 01/94 ⇨

ISUZU

AMIGO 2.6i [USA]	RLJ	01/88 ⇨
PICK-UP 2.6i [USA]	RLJ	01/88 ⇨
RODEO 2.6i [USA]	RLJ	01/90 ⇨
TROOPER 2.6 4WD	4ZE1	11/86 ⇨ 07/91
TROOPER 2.6 i	4ZE1	10/87 ⇨ 12/91

OPEL

CAMPO 2.3 | 23P | 08/94 ⇨ 09/96

EPS 1.422.070



ROTORS

Adatt./Suitable: HITACHI

BOSCH

1 987 234 050
1 987 234 052

FORD

1 953 279

NISSAN

22157-17B00
22157-21E00
22157-21E01
22157-21F01
22157-27M02
22157-40F00
22157-55Y00
22157-71J00
22157-78A00**03 Supplied until depletion**

- Fornibile fino ad esaurimento delle scorte
- Fourni jusqu'à épuisement du stock
- Lieferbar solange vorrat reicht
- Suministrado hasta el stock termina



FORD

MAVERICK 2.4 i | KA24E | 02/93 ⇨ 08/96

NISSAN

100NX 1.6	GA16DS	03/90 ⇨ 10/94
BLUEBIRD 1.8 Turbo	CA18T	04/84 ⇨ 11/92
BLUEBIRD 2.0 i	CA20E	04/84 ⇨ 12/90
NX1600 1.6i [USA]	GA16, GA16DE	01/88 ⇨ 12/92
PICK UP I 2.4 i [USA]	KA24E	01/89 ⇨
PICK UP I 2.4 i 12V	KA24E	04/92 ⇨ 02/98
PICK UP I 2.4 i 12V 4WD	KA24E	04/92 ⇨ 02/98
PRIMERA I 1.6	GA16DS	06/90 ⇨ 01/96
PRIMERA I 1.6 i	GA16DS	07/90 ⇨ 03/98
PULSAR NX 1.6 [USA]	GA16	01/88 ⇨
SENTRA III 1.6i [USA]	GA16DE	01/90 ⇨ 12/92
SILVIA 1.8	--	01/84 ⇨
SUNNY II 1.6 i 12V	GA16i	06/86 ⇨ 06/91

1.422.073

NISSAN		
SUNNY III 1.6 16V 4x4	GA16DS	11/90 ⇒ 05/95
SUNNY III 1.6 i	GA16DE, GA16DS	10/90 ⇒ 03/00
SUNNY III 1.6 i 16V 4WD	GA16DE, GA16DS	10/90 ⇒ 06/95
SUNNY III 1.6 i 16V 4x4	GA16DE	10/92 ⇒ 03/00
TERRANO II 2.4 4WD	KA24E	05/96 ⇒ 09/07
TERRANO II 2.4 i 12V 4WD	KA24E	02/93 ⇒ 12/97

EPS 1.422.073



ROTORS

Adatt./Suitable: **HITACHI**

BOSCH

1 987 234 031

FORD

E7GZ-12200-A

HITACHI

43S85-16001

43S86-16001

44R86-16001

HONDA

30103-PE1-731

MAZDA

B601-18-V05

Motorcraft

DRE 381

NISSAN

22157-KA030

SUBARU

22157-AA040

22157-KA010

22157-KA030

SUZUKI

33310-75F00

33310-75F00-000



MAZDA		
323 V 1.6	93AF1006, B6E	09/86 ⇒ 10/95
323 V 1.6 GT	93AF1006	01/86 ⇒ 10/89
323 V 1.6i	B681, B682	06/86 ⇒ 07/87
323 V 1.6i 16v 4x4	B595	06/86 ⇒ 07/87

SUBARU

J-SERIES 1.0i EFC-SYS	--	01/89 ⇒
J-SERIES 1.2	--	01/87 ⇒ 12/91
J-SERIES 1.2 SDX	--	01/89 ⇒ 12/91
J-SERIES 1.2i EFC-SYS	--	01/89 ⇒
JUSTY 1.2 [USA]	--	01/87 ⇒ 12/92
L-SERIES 1.6	--	01/87 ⇒ 12/91
TRENDY 1.0	EF10	08/86 ⇒ 05/95
TRENDY 1.2 12v	EF12	06/86 ⇒ 08/95

SUZUKI

WAGON R II 1.0	K10A	02/98 ⇒ 05/00
WAGON R II 1.2	K12A	02/98 ⇒ 05/00
WAGON R II 1.2 4WD	K12A	02/98 ⇒ 05/00

EPS 1.422.081



ROTORS

Adatt./Suitable: **HITACHI**

HONDA

30103-P01-005

30103-PM0-B01

30103-PM3-015

30103-PM3-025

00 Eliminated on 12-01-2022. Please verify the availability through our local distributors

• Eliminato il 12-01-2022. Verificare la disponibilità presso i nostri distributori

• Éliminé le 12-01-2022. Vérifier la disponibilité auprès de nos distributeurs sur place

• Am 12-01-2022 gestrichen. Evtl. Verfügbarkeit bitte bei unseren Händlern prüfen

• Eliminado en fecha 12-01-2022. Verificar la disponibilidad a través de nuestros distribuidores locales



HONDA

ACCORD IV 1.8	--	01/90 ⇒ 12/91
ACCORD IV 2.0 16V	F20A2, F20A3, F20A6	01/90 ⇒ 03/93
CIVIC V 1.3	D13B2	01/92 ⇒ 12/92
CIVIC V 1.3 16V	D13B2	10/91 ⇒ 11/95
CIVIC IV 1.2	D12B1	01/88 ⇒ 12/91
CIVIC IV 1.3	D13B1	10/87 ⇒ 12/89
CIVIC IV 1.3 [USA]	--	09/87 ⇒ 12/89
CIVIC IV 1.3 16V Cat	D13B2	09/89 ⇒ 09/91
CIVIC IV 1.4 L	D14A1	10/87 ⇒ 12/89
CIVIC IV 1.4i 16V	D14A1	01/90 ⇒ 12/91
CIVIC IV SHUTTLE 1.4 i 16V	D14A1	01/88 ⇒ 12/92
CONCERTO 1.4	D14A1	08/89 ⇒ 10/92
CONCERTO 1.6i	D16A	01/90 ⇒ 12/91

EPS 1.422.082



ROTORS

Adatt./Suitable: **HITACHI**

ACURA

30103-PM5-A04

BOSCH

1 987 234 063

HONDA

30103-PM5-702

30103-PM5-703

30103-PM5-A02

30103-PM5-A04

30103-PR3-006

ROVER

GRA2287



ACURA

INTEGRA I 1.6	D16A1	01/85 ⇒ 12/90
INTEGRA I 1.6 i	D16A8	01/85 ⇒ 12/90

HONDA

CIVIC IV 1.5	D15B1	01/88 ⇒ 12/89
CIVIC IV 1.5 i 16V	D15B2	10/87 ⇒ 09/91
CIVIC IV 1.6 16V 4x4	D16A6	11/87 ⇒ 09/91
CIVIC IV 1.6 i 16V	D16A6, D16A9, D16Z2	09/87 ⇒ 09/91
CIVIC IV 1.6 i 16V 4x4	D16A6, D16Z2	01/89 ⇒ 12/91
CIVIC IV 1.6i 16V	D16A7, D16A8, D16A9	01/88 ⇒ 05/92
CIVIC IV 1.6i 16V 4WD	D16A1, D16Z2	01/88 ⇒ 12/91
CIVIC IV SHUTTLE 1.5 i 16V	D15B2	01/88 ⇒ 11/91
CIVIC IV SHUTTLE 1.6 4x4	D16A, D16A7	01/88 ⇒ 12/92
CIVIC IV SHUTTLE 1.6 i 16V 4WD	D16A6	01/88 ⇒ 02/95
CIVIC IV SHUTTLE 1.6i 16V 4WD	D16Z2	01/88 ⇒ 12/92
CIVIC V 1.5	D15B2	01/92 ⇒ 12/92

HONDA

CONCERTO 1.5 i	--	01/90 ⇒ 12/91
CONCERTO 1.6i DOHC	--	01/90 ⇒ 12/91
CONCERTO 1.6i SOHC	--	01/90 ⇒ 12/91
CRX II 1.6 i 16V	D16A9, D16Z5	10/87 ⇒ 02/92

ROVER

200 II 216 GSi	1GH5E-180, D16A7	10/89 ⇒ 12/95
200 II 216 GTi	D16A8, D16A9	01/90 ⇒ 10/95
400 I 416 GTI/GTE	D16A9	04/90 ⇒ 04/95

EPS 1.422.085



ROTORS

Adatt./Suitable: **HITACHI**

BOSCH

1 987 234 053

INFINITI

22157-70J00

Motorcraft

ADR 5050

NISSAN

22157-30R00

22157-54C01

22157-70J00

22157-70J01

03 Supplied until depletion

• Fornibile fino ad esaurimento delle scorte

• Fourni jusqu'à épuisement du stock

• Lieferbar solange vorrat reicht

• Suministrado hasta el stock termina



INFINITI

G20 2.0	SR20DE	01/90 ⇒ 12/97
---------	--------	---------------

NISSAN

100NX 2.0	SR20DE	10/90 ⇒ 10/94
100NX 2.0 GTi	SR20DE	03/91 ⇒ 10/94
PRAIRIE PRO 2.4 i	KA24E	01/90 ⇒ 07/94
PRAIRIE PRO 2.4 i 4x4	KA24E	04/92 ⇒ 07/94
PRIMERA I 2.0	SR20DE	06/90 ⇒ 04/93
PRIMERA I 2.0 16V	SR20D1	06/90 ⇒ 01/96
PRIMERA I 2.0 16V 4x4	SR20D1	04/91 ⇒ 06/96
PRIMERA I 2.0 GT	SR20DE	06/90 ⇒ 01/96
PRIMERA I 2.0 GT 4x4	SR20DE	03/91 ⇒ 04/93
PRIMERA I 2.0 i	SR20DE	07/90 ⇒ 03/98
PRIMERA II 2.0 16V	SR20DE	08/99 ⇒ 12/01
SENTRA III 2.0i [USA]	SR20DE	01/90 ⇒
SUNNY III 2.0 GTi 16V	SR20DE	10/90 ⇒ 05/95
SUNNY III 2.0 GTi-R 4x4	SR20DET	10/90 ⇒ 05/95

EPS 1.422.086



ROTORS

Adatt./Suitable: **HITACHI**

BOSCH

1 987 234 052

NISSAN

22157-03A00

22157-71J10

22157-77A01

03 Supplied until depletion

• Fornibile fino ad esaurimento delle scorte

• Fourni jusqu'à épuisement du stock

• Lieferbar solange vorrat reicht

• Suministrado hasta el stock termina



NISSAN

100NX 1.6	GA16DS	03/90 ⇒ 10/94
PRIMERA I 1.6	GA16DS	06/90 ⇒ 01/96
PRIMERA I 1.6 i	GA16DS	07/90 ⇒ 03/98
SUNNY II 1.0 L	E10S	07/86 ⇒ 09/90
SUNNY II 1.3	E13S	06/86 ⇒ 10/91
SUNNY II 1.4 LX	GA14S	10/88 ⇒ 08/91
SUNNY II 1.5	E15S	06/86 ⇒ 10/88
SUNNY II 1.6	E16S	06/86 ⇒ 10/88

NISSAN			
SUNNY III 1.4	GA14DS	10/90 ⇒	06/95
SUNNY III 1.4 i	GA14DS	10/90 ⇒	05/95
SUNNY III 1.6 16V 4x4	GA16DS	11/90 ⇒	05/95
SUNNY III 1.6 i	GA16DE, GA16DS	10/90 ⇒	03/00
SUNNY III 1.6 i 16V 4WD	GA16DE, GA16DS	10/90 ⇒	06/95
SUNNY III 1.6 i 16V 4x4	GA16DE	10/92 ⇒	03/00

EPS 1.422.092



ROTORS

Adatt./Suitable: **HITACHI****HONDA**
30103-PT2-016

HONDA			
ACCORD IV 2.0 16V	F20A5	01/92 ⇒	12/93
ACCORD IV 2.0 i 16V	F20A7	01/90 ⇒	12/93
ACCORD IV 2.2	F22A6	05/92 ⇒	12/93
ACCORD IV 2.2 i 16V	F22A3, F22A7, F22A8	01/90 ⇒	12/93
ACCORD IV 2.2 i 16V Automatik	F22A3	01/90 ⇒	03/93

EPS 1.422.093



ROTORS

Adatt./Suitable: **HITACHI****HITACHI**
44P88-16001**SUBARU**
22157-AA080⁰³ Supplied until depletion

- Fornibile fino ad esaurimento delle scorte
- Fourni jusqu'à épuisement du stock
- Lieferbar solange vorrat reicht
- Suministrado hasta el stock termina



SUBARU			
LEGACY I 1.8i SPi	--	01/89 ⇒	
LEGACY I 1800	EJ185PI	01/89 ⇒	07/94
LEGACY I 1800 4WD	EJ185PI	01/89 ⇒	07/94

EPS 1.422.094



ROTORS

Adatt./Suitable: **HITACHI****BOSCH**
F 005 X04 744
F 005 X04 757**MAZDA**
B3C7-18-V05
FS05-18-V05

FORD AUSTRALIA			
TELSTAR 2.0 Efi	FS	10/94 ⇒	11/96

MAZDA			
121 II 1.3 16V	B3(16V)	11/90 ⇒	03/96
121 II 1.3 i 16V	B3(16V)	11/90 ⇒	03/96
626 V 1.8	FP, FP01LP	08/91 ⇒	04/97
626 V 1.8 i	--, FP	08/91 ⇒	06/97
626 V 2.0 i	FS	08/91 ⇒	04/97
626 V 2.0 i 4WD	FS	04/92 ⇒	04/97
MX-6 2.0	FS	02/92 ⇒	02/97

EPS 1.422.095



ROTORS

Adatt./Suitable: **HITACHI****ACURA**
30103-P08-003**BOSCH**
1 987 234 064**HONDA**
30103-P08-003
30103-P72-003**ROVER**
GRA2324
NJE100060

ACURA			
INTEGRA II 1.8	F18A2	10/90 ⇒	09/93
INTEGRA III 1.8 GS-R	F18C2	10/93 ⇒	09/01
INTEGRA III 1.8 LS	F18C1	10/93 ⇒	09/01
INTEGRA III 1.8 Sport	F18C1	10/93 ⇒	09/01

HONDA			
ACCORD V 1.8 16V	F18A3	01/94 ⇒	12/95
ACCORD V 2.0	F20B3	09/93 ⇒	12/97
ACCORD V 2.0 i	F20Z2	03/93 ⇒	01/96
ACCORD V 2.0 i LS 16V	F20B3	09/93 ⇒	02/98
ACCORD V 2.0 i S	F20Z1	03/93 ⇒	01/96
ACCORD V 2.2 i [USA]	--	01/94 ⇒	12/95
ACCORD V 2.2 i 16V	F22B4	08/95 ⇒	12/97
ACCORD V 2.2 i ES	F22B5	09/93 ⇒	02/98
ACCORD V 2.3 i SR	H23A3	03/93 ⇒	01/96
ACCORD VI 2.2 Type-R	H22A7	02/99 ⇒	12/02
CIVIC V 1.5	D15B7	08/93 ⇒	12/95
CIVIC V 1.5 i 16V	D15B2, D15Z1	10/91 ⇒	11/95
CIVIC V 1.5 i LS i	D15B7	08/93 ⇒	11/95
CIVIC V 1.6 16V Vtec	D16Z6, D16Z7	10/91 ⇒	11/95
CIVIC V 1.6 4x4	D16Z7	01/92 ⇒	10/95
CIVIC V 1.6 EX	D16A7	08/93 ⇒	10/95
CIVIC V 1.6 i	D16Y7	01/94 ⇒	11/95
CIVIC V 1.6 i Vtec	B16A2, D16Z9	01/94 ⇒	03/96
CIVIC V 1.6 VTi	B16A2	10/91 ⇒	11/95
CIVIC V 1.6 VTi 16V	B16A2	10/91 ⇒	11/95
BALLADE 1.6i	B16A6	01/97 ⇒	02/01
BALLADE 1.8 i	B18B4	01/96 ⇒	02/01
CIVIC IV 1.6i	--	01/90 ⇒	12/91
CIVIC VI 1.4 i	D14A2, D14A5, D14Z2	06/95 ⇒	02/01

CIVIC VI 1.4 i S	D14Z2	11/95 ⇒	02/01
CIVIC VI 1.4i 16V	D14Z1	11/98 ⇒	03/01
CIVIC VI 1.5 i	D15Z6	11/95 ⇒	02/01
CIVIC VI 1.5 i Vtec-E	D15Z3	09/94 ⇒	01/97
CIVIC VI 1.6	--	05/96 ⇒	04/99
CIVIC VI 1.6 i	D16Y3	09/94 ⇒	03/00
CIVIC VI 1.6 i Vtec	B16A2, D16Y2, D16Y8	09/94 ⇒	02/01
CIVIC VI 1.6 VTi	B16A2	11/95 ⇒	02/01
CIVIC VI 1.6i 16V	D16Y7	01/96 ⇒	
CIVIC VI 1.6i 16V Vtec	D16Y8	01/96 ⇒	09/99
CR-V I 2.0	B20Z1	04/99 ⇒	02/02
CR-V I 2.0 16V 4WD	B20B, B20Z1	10/95 ⇒	02/02
CR-V I 2.0 i 16V	B20B3, B20B4, B20B9, B20Z3	02/97 ⇒	04/99
CRX III 1.6 ES i	D16Y8, D16Z6	03/92 ⇒	12/98
CRX III 1.6 i VTi	B16A2	03/92 ⇒	12/98
HR-V 1.6 16V	350Y	03/99 ⇒	
HR-V 1.6 16V 4WD	350Y, D16W5	03/99 ⇒	
HR-V 1.6i 16V	D16W2	04/99 ⇒	
INTEGRA 1.8 i	B18B1	01/98 ⇒	
LOGO 1.3	D13B7	03/99 ⇒	03/02
PRELUDE IV 2.0 i 16V	F20A4	02/92 ⇒	09/96
PRELUDE IV 2.2 i 16V Vtec	H22A2	02/93 ⇒	09/96
PRELUDE IV 2.3 i 16V	H23A2	02/92 ⇒	09/96
PRELUDE V 2.0 16V	F20A4	10/96 ⇒	10/00
PRELUDE V 2.2 16V	H22A5	10/96 ⇒	10/00
PRELUDE V 2.2 i 16V	F22A2	10/96 ⇒	10/01
PRELUDE V 2.2 i 16V VTi-R	H22A4, H22A8, H22Z1	10/96 ⇒	12/98
PRELUDE V 2.2 Si	F22Z6	03/97 ⇒	07/02
SHUTTLE 2.2 16V	F22B8	10/94 ⇒	02/98

ROVER

400 II 416 Si	D16Y2	03/95 ⇒	03/00
600 618 i/Si	F18A3	03/96 ⇒	02/99
600 620 i	F20Z2	08/93 ⇒	06/96
600 620 Si	F20Z1	08/93 ⇒	02/99
600 623 Si	H23A3	08/93 ⇒	06/99

EPS 1.422.097R



ROTORS

Adatt./Suitable: **HITACHI****ACURA**
30103-PW0-G02**HONDA**
30103-PW0-G02
30103-PW0-G03⁰⁰ Eliminated on 22-02-2022. Please verify the availability through our local distributors

- Eliminato il 22-02-2022. Verificare la disponibilità presso i nostri distributori
- Éliminé le 22-02-2022. Vérifier la disponibilité auprès de nos distributeurs sur place
- Am 22-02-2022 gestrichen. Evtl. Verfügbarkeit bitte bei unseren Händlern prüfen
- Eliminado en fecha 22-02-2022. Verificar la disponibilidad a través de nuestros distribuidores locales

²¹² Resistance Rotor [Ohm] 25

- Rotore resistenza [Ohm] 25
- Résistance rotor [ohm] 25
- Widerstand-Rotor [Ohm] 25
- Resistencia rotor [ohm] 25



ACURA			
INTEGRA II 1.8	F18A2	10/90 ⇒	09/93
INTEGRA III 1.8 LS	F18C1	10/93 ⇒	09/01
INTEGRA III 1.8 Sport	F18C1	10/93 ⇒	09/01

HONDA			
CIVIC IV 1.6i	--	01/90 ⇒	12/91

EPS 1.422.098



ROTORS

Adatt./Suitable: **HITACHI**

HONDA

30103-P0A-A01
30103-PAA-A01
30103-PDA-E01

ISUZU

5-86202573-0

ROVER

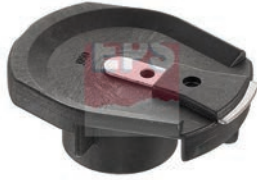
GRA2327
NUJ100030

HONDA			
ACCORD V 1.9 i	F18A3	02/96	⇒ 10/98
ACCORD V 2.0 i LS	F20Z1	02/96	⇒ 10/98
ACCORD V 2.2	F22B1, F22Z2	10/93	⇒ 12/97
ACCORD V 2.2 16V	F22Z1	01/96	⇒ 09/98
ACCORD V 2.2 i [USA]	--	01/94	⇒ 12/95
ACCORD V 2.2 i VTEC	F22Z2	02/96	⇒ 10/98
ACCORD VI 1.8 16V Vtec	3B630WM, F18B3	04/99	⇒
ACCORD VI 1.8 i	3B630WM	10/98	⇒ 12/02
ACCORD VI 1.8 i 16V Vtec	F18B4	11/98	⇒ 12/99
ACCORD VI 2.0	F20B6	11/99	⇒ 12/02
ACCORD VI 2.0 16V Vtec	F20B6	04/99	⇒
ACCORD VI 2.0 i	F20B6	10/98	⇒ 01/01
ACCORD VI 2.0 i 16V	F20B5, F20B7	02/98	⇒ 06/03
ACCORD VI 2.3	F23Z5	11/00	⇒ 06/03
ACCORD VI 2.3 i 16V Vtec	F23Z5	11/00	⇒
ACCORD VI 2.3 VTi	F23A3	02/98	⇒ 10/02
CIVIC VI 1.4 i	D14A2, D14A5	06/95	⇒ 02/01
CIVIC VI 1.4i 16V	D14Z3, D14Z4	11/98	⇒ 12/00
CIVIC VI 1.4i 16V Vtec	D14Z4	01/99	⇒
CIVIC VI 1.5 16V	D15Z8	01/97	⇒ 02/01
CIVIC VI 1.6	D16W4	11/98	⇒ 03/01
CIVIC VI 1.6 i	D16Y3	09/94	⇒ 02/01
CIVIC VI 1.6 i Vtec	D16Y6	11/95	⇒ 02/01
CIVIC VI 1.6i 16V	D16W3	11/98	⇒ 12/00
CIVIC V 1.6 i Vtec	D16Y6	01/94	⇒ 03/96
ODYSSEY 2.2	F22B6	01/95	⇒ 12/97
ODYSSEY 2.3	F23A	10/97	⇒ 09/03
ODYSSEY 2.3 4x4	F23A	10/97	⇒ 09/03
ODYSSEY 2.3 i 16V Vtec	F23A8	01/98	⇒
SHUTTLE 2.3 16V	F23A7, F23A8	10/97	⇒ 06/04
ROVER			
400 II 416 Si	D16Y2	03/95	⇒ 03/00
600 618 i/Si	F18A3	03/96	⇒ 02/99
600 620 i	F20Z2	08/93	⇒ 06/96
600 620 Si	F20Z1	08/93	⇒ 02/99

EPS 1.422.102



ROTORS

Adatt./Suitable: **HITACHI**

FORD

1 960 491 *C

FORD AUSTRALIA

F S90-18-V05

HONDA

30103-P2A-J01

MAZDA

F590-18-V05

NISSAN

22157-4B000

22157-72B00

ROVER

NJE100100

*C Available rotor only-not, the distributor assy

- Fornito solo distributore rotante, non lo spinterogeno completo
- Disponible seulement le rotor, non pas l'allumeur complet
- Erhältlich nur rotor, nicht der komplette verteiler
- Disponible solo el rotor, no el distribuidor completo



FORD			
MAVERICK 2.4 i	KA24	09/96	⇒ 04/98
FORD AUSTRALIA			
TELSTAR 2.0 EFI	FS	10/94	⇒ 11/96
HONDA			
BALLADE 1.5	D15Z4	01/97	⇒
BALLADE 1.6i	D16Y9	01/96	⇒ 02/01
CIVIC VI 1.4	D14A4	11/95	⇒ 10/98
CIVIC VI 1.4 16V	D14A7, D14A8	01/97	⇒ 02/01
CIVIC VI 1.4 i	D14A3, D14A4, D14A8, D14Z1	06/95	⇒ 02/01
CIVIC VI 1.4 i S	D14A4	11/95	⇒ 02/01
CIVIC VI 1.4i	D14A6	01/99	⇒
CIVIC VI 1.6 16V	D16B2	01/97	⇒ 02/01
MAZDA			
626 V 1.8	FP, FP01LP	08/91	⇒ 04/97
626 V 1.8 i	--, FP	08/91	⇒ 06/97
626 V 2.0 i	FS	08/91	⇒ 04/97
626 V 2.0 i 4WD	FS	04/92	⇒ 04/97
MX-6 2.0	FS	02/92	⇒ 02/97
NISSAN			
ALMERA I 1.4	GA14DE	09/95	⇒ 07/00
ALMERA I 1.4 GX, LX	GA14DE	09/95	⇒ 07/00
ALMERA I 1.4 S, GX, LX	GA14DE	09/95	⇒ 03/00
ALMERA I 1.6	GA16DE	07/95	⇒ 07/00
ALMERA I 1.6 SLX	GA16DE	09/95	⇒ 07/00
ALMERA I 1.6 SR, SLX	GA16DE	09/95	⇒ 03/00
MICRA II 1.0 i 16V	CG10DE	08/92	⇒ 07/00
MICRA II 1.3 i 16V	CG13DE	08/92	⇒ 09/00
TERRANO II 2.4 4WD	KA24E	05/96	⇒ 09/07
TERRANO II 2.4 i 12V 4WD	KA24E	02/93	⇒ 12/97
ROVER			
400 II 416 Si	D16Y2	03/95	⇒ 03/00

EPS 1.428.006



ROTORS

Adatt./Suitable: **LUCAS**

FIAT

31322322
631322322

GENERAL MOTORS

7 992 214

LAND ROVER

RTC3612

Motorcraft

ADR 71
EDR 2
EDR 2 D

AUSTIN			
1000-SERIES 1100	--	01/70	⇒ 12/74
1000-SERIES 1300	--	01/70	⇒ 12/74

AUSTIN			
1000-SERIES 1300 GT	--	01/70	⇒ 12/74
ALLEGRO 1.1	10H	05/73	⇒ 10/81
ALLEGRO 1.3	12H	05/73	⇒ 03/82
ALLEGRO 1.5 Super	14H	05/73	⇒ 03/82
APACHE 1300	--	11/71	⇒ 10/74
APACHE 1300 TC	--	11/71	⇒ 10/74
MAXI 1500	--, 14H	04/69	⇒ 07/80
MAXI 1750	17H	04/69	⇒ 10/80
MAXI 1750 HL	--, 17LA	10/72	⇒ 10/80
MINI 1.3	12HC	09/69	⇒ 09/80
MINI 1000	--, 99H	10/67	⇒ 09/84
MINI 1275 GT	12H	10/69	⇒ 08/80
MINI 850	--	01/60	⇒ 12/69
MINI I 1.0	--	09/62	⇒ 08/69
MINI I 1.1	--	11/62	⇒ 08/64
MINI I 1.3	--	09/62	⇒ 08/69
MINI I 850	781Y	06/59	⇒ 08/69
MINI I Cooper	99H	01/61	⇒ 12/67
MINI I Cooper S	--	09/62	⇒ 12/71

AUSTIN-HEALEY			
SPRITE MK.III 1.1	--	03/64	⇒ 09/66
SPRITE 1.3	--, 12CC	03/66	⇒ 10/71

BOND			
EQUIPE 1300 GT	--	01/67	⇒ 12/70

FORD			
CORSAIR 1.5	EV15LN, EV15N	10/63	⇒ 09/65
CORSAIR 1.5 GT	EV15LH	10/63	⇒ 09/65
CORTINA 1200	--	10/62	⇒ 09/66
CORTINA 1500	--	10/62	⇒ 09/66
CORTINA 1500 GT	--	10/62	⇒ 09/66
CORTINA GT	--	10/62	⇒ 09/66
CORTINA Lotus	--	10/62	⇒ 09/70
CORTINA Lotus Spezial	--	10/62	⇒ 09/66
ESCORT I RS 1600	--, BDA	01/70	⇒ 10/74
ESCORT I Twin Cam	K5	03/68	⇒ 08/71
ESCORT II 1.6 RS	LC	12/74	⇒ 08/80
ESCORT II 1.8	--	12/74	⇒ 08/80
ESCORT II RS 1800	KL18S	03/75	⇒ 08/77
ZEPHYR 1.7	--, EL17L	03/62	⇒ 03/68

GINETTA			
G15 0.9	--	01/67	⇒ 12/75

JENSEN			
GT 2.0	--	06/75	⇒ 12/76
HEALEY 2.0	--	01/72	⇒ 12/75

LAND ROVER			
88/109 2.3 4x4	10H, 11H	09/61	⇒ 12/86

MG			
1300 MK.II 1300	--	09/67	⇒ 09/70
MAGNETTE 1.5	--	01/53	⇒ 04/58
MAGNETTE 1.6	--	03/61	⇒ 09/68
MGA 1.5	--	05/55	⇒ 04/60
MGA 1.6	--	01/58	⇒ 07/62
MGB 1.8	--	05/62	⇒ 12/80
MGB GT 1.8	--, 18G	07/65	⇒ 11/80
MGY 1.3	--	01/50	⇒ 12/51
MIDGET 1.1	--	01/64	⇒ 12/66
MIDGET 1.3	--	01/67	⇒ 09/74

MORRIS			
MARINA 1.8	--	04/71	⇒ 12/79
MARINA 1.8 TC	--	04/71	⇒ 09/75
MARINA 1300	--	04/71	⇒ 06/80
MARINA 1800	--	04/71	⇒ 12/75
MARINA 1800 TC	--	04/71	⇒ 12/75
MINOR 0.9	--	11/55	⇒ 12/62
MINOR 1.1	--	01/62	⇒ 10/71
OXFORD 1.5	--	11/59	⇒ 09/62
OXFORD 1.7	--	05/62	⇒ 04/70

RELIANT			
REBEL 700	--	01/68	⇒ 08/71
REBEL 750	--	08/71	⇒ 12/73
ROBIN 850	--	11/73	⇒ 10/02

RILEY			
4/72 1.7	--	03/61	⇒ 10/68
ELF 1.0	--	03/63	⇒ 10/68
KESTREL 1100	--, 10H	03/65	⇒ 04/67
KESTREL 1300	12H	03/67	⇒ 12/69

ROVER			
A60 CAMBRIDGE 1.7	--	01/62	⇒ 10/69

TALBOT			
AVENGER 1.3	--	02/70	⇒ 07/81
AVENGER 1.6	--	02/70	⇒ 07/81

TRIUMPH			
1300 1.3	--	01/65	⇒ 12/70
1300 1.3 TC	--, GE1EH	01/67	⇒ 12/70
1500 1.5	--, 1EH, 1EL	10/70	⇒ 12/74
HERALD 1200	--, AJM	01/61	⇒ 12/69
HERALD 13/60	--	01/67	⇒ 12/71
TOLEDO 1300	--	10/70	⇒ 12/77

TRIUMPH		
TOLEDO 1500	--	10/70 ⇒ 12/77
TOLEDO 1500 TC	--	01/71 ⇒ 12/77
TR 2 2.0	--, HCL	01/53 ⇒ 12/55
TR 3 2.0	--, HCL	12/55 ⇒ 12/57
TR 4 2.0	--	01/61 ⇒ 12/65
TR 3A 2.0	--	12/57 ⇒ 12/61
TR 3A 2.2	--, HE0H	01/59 ⇒ 12/61
TR 4A 2.2	--, HE0H	12/65 ⇒ 12/67
TVR		
VIXEN 1800	--	01/68 ⇒ 12/68
WOLSELEY		
16/60 1.6	--	01/61 ⇒ 12/71
18/85 1.8	--, 18HL	08/69 ⇒ 12/72
18/85 1.8 S	--, 18HH	01/70 ⇒ 12/72
1300 1.3	--, 12H	01/68 ⇒ 10/71
1300 1.3 TC	--, 12H	10/71 ⇒ 10/73
HORNET 1.0	--, 99LFD	01/61 ⇒ 12/70

TRIUMPH		
2000 2.0	--, 20TC	01/68 ⇒ 12/75
2000 2.0 TC	--	03/72 ⇒ 12/75
TR 5 2.5 PI	--	01/67 ⇒ 12/68
TR 6 2.5	--, CF1, CR1H	03/69 ⇒ 12/76
TR 6 2.5 PI	--	01/69 ⇒ 12/76
VITESSE 1.6	--	01/62 ⇒ 12/67
VITESSE 2.0	--, HB1HE, HB1LE	12/65 ⇒ 12/71
TVR		
2500 2.5	--, CF1	01/72 ⇒ 12/77
WOLSELEY		
SIX 2.2	--	01/72 ⇒ 10/75

EPS 1.428.012



ROTORS
Adatt./Suitable: LUCAS

BOSCH
1 234 332 848

FIAT
59321324
659321324

GENERAL MOTORS
7 992 996

INNOCENTI
659321324

JAGUAR
AEU 1501
JLM 9623

LAND ROVER
RTC3339
RTC3614

LEYLAND
GRA114

RENAULT
77 01 025 237

ROVER
GRA114

TALBOT
7506 37 64

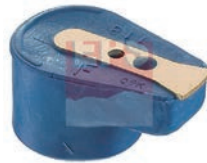

INNOCENTI		
MINI 120	--	01/75 ⇒ 12/83
JAGUAR		
XJ 4.2i Series 3	--	01/86 ⇒ 12/94
LAND ROVER		
90 2.5 4x4	17H	09/85 ⇒ 08/90
110/127 2.5 4x4	17H	10/85 ⇒ 07/90
DEFENDER 2.25	--	01/87 ⇒
DEFENDER 2.5 90, 110	--	08/90 ⇒ 09/01
ROVER		
MINI 1.0	--	01/85 ⇒

EPS 1.428.014



ROTORS
Adatt./Suitable: LUCAS

FORD
A790-X12200-RA

LAND ROVER
RTC3613

Motorcraft
EDR 92

⁰³ Supplied until depletion

- Fornibile fino ad esaurimento delle scorte
- Fourni jusqu'à épuisement du stock
- Lieferbar solange vorrat reicht
- Suministrado hasta el stock termina



EPS 1.428.007



ROTORS

Adatt./Suitable: LUCAS

FORD
EOTT-A1220-0A
EOTT-A1220-0B
EOTT-A1220-0C

GENERAL MOTORS
7 992 216

LAND ROVER
262704

Motorcraft
ADR 76

VAUXHALL
7079424
7101586



ASTON MARTIN		
DB6 4.0	--, AJ6	10/64 ⇒ 12/70
DBS 4.0	--, AJ6	01/66 ⇒ 12/72
AUSTIN-HEALEY		
3000 3.0 Sport	--	03/64 ⇒ 10/68
BOND		
EQUIPE 2.0 GT	--	01/68 ⇒ 12/71
DAIMLER		
2.8 - 5.3 Sovereign 2.8	--	10/69 ⇒ 05/75
2.8 - 5.3 Sovereign 4.2	--	10/69 ⇒ 03/79
FORD		
ZEPHYR 2.0	EV20A, EV20B	03/68 ⇒ 10/72
ZEPHYR 2.5	EL25L, EL25, EV25B, EV25L	03/62 ⇒ 10/72
ZEPHYR 3.0	EV30A, EV30B	03/68 ⇒ 10/72
ZODIAK 2.5	EL25HV, EL25LV	03/62 ⇒ 10/72
JAGUAR		
E-TYPE 3.8	--	04/61 ⇒ 07/64
E-TYPE 4.2	--, 8L(85-87), XK4.2(82-87)	05/64 ⇒ 04/75
E-TYPE 2+2 4.2	7L, 8LC	06/66 ⇒ 04/75
I 2.4	--	09/55 ⇒ 09/59
I 3.4	--	09/55 ⇒ 09/59
II 240	--	09/59 ⇒ 10/69
II 3.8 S	--	09/59 ⇒ 09/66
II 340	--	09/55 ⇒ 10/70
IX 3.8	--	10/58 ⇒ 07/61
X 3.4	--	10/61 ⇒ 10/64
X 4.2	--	09/61 ⇒ 07/68
X 420	--	09/67 ⇒ 10/69
X 420G	--	09/66 ⇒ 10/70
S-TYPE 3.4	--	05/63 ⇒ 08/68
S-TYPE 3.8	--	05/63 ⇒ 08/68
XJ 2.8	--	10/68 ⇒ 10/73
XJ 6 2.8	--	09/68 ⇒ 10/75
XJ 6 4.2	XK4.2(-79)	10/69 ⇒ 05/75
XK 120	--	01/50 ⇒ 10/54
XK 150	--	09/57 ⇒ 10/60
XK 150 S	--	09/57 ⇒ 10/60
MG		
MGC 3.0	--	01/67 ⇒ 09/69
MGC GT 3.0	--	01/67 ⇒ 09/69
TRIUMPH		
2.5 PI 2.5	--, 25PI	01/68 ⇒ 12/75

EPS 1.428.021



ROTORS

Adatt./Suitable: LUCAS

LAND ROVER
RTC3618

⁰³ Supplied until depletion

- Fornibile fino ad esaurimento delle scorte
- Fourni jusqu'à épuisement du stock
- Lieferbar solange vorrat reicht
- Suministrado hasta el stock termina



LAND ROVER

DEFENDER 3.5 4x4

15G, 21G, 22D

09/90 ⇒ 12/98

EPS 1.428.022



ROTORS

Adatt./Suitable: LUCAS

BOSCH
F 005 X04 636

LAND ROVER
RTC3199
RTC6629
STC1857



LAND ROVER

DEFENDER 3.5 4x4

15G, 21G, 22D

09/90 ⇒ 12/98

DISCOVERY I 3.5

--

09/89 ⇒ 06/94

DISCOVERY I 3.5 4x4

22D

06/89 ⇒ 06/94

DISCOVERY I 4.0 4x4

35D, 36D

09/93 ⇒ 10/98

RANGE ROVER I 3.5 4x4

31D

01/87 ⇒ 09/90

RANGE ROVER I 3.5 Vogue

24D, 25D

10/85 ⇒ 09/90

4x4

RANGE ROVER I 3.9 4x4

35D

11/88 ⇒ 12/92

RANGE ROVER I 3.9 Cat 4x4

37D, 38D

11/88 ⇒ 07/94

RANGE ROVER I 3.9 Vogue

35D, 36D

11/88 ⇒ 07/94

SEI 4x4

RANGE ROVER I 4.3 Vogue

40D

09/92 ⇒ 07/94

LSE 4x4

EPS 1.428.024R



ROTORS

Adatt./Suitable: LUCAS

ROVER

AUU1690
GRA138
GRA2138
GRA2274

⁰³ Supplied until depletion

- Fornibile fino ad esaurimento delle scorte
- Fourni jusqu'à épuisement du stock
- Lieferbar solange vorrat reicht
- Suministrado hasta el stock termina

²¹² Resistance Rotor [Ohm] 1000

- Rotore resistenza [Ohm] 1000
- Résistance rotor [ohm] 1000
- Widerstand-Rotor [Ohm] 1000
- Resistencia rotor [ohm] 1000



AUSTIN

MONTEGO 1.6 LS	16HC37	10/84 ⇒ 08/88
MONTEGO 1.6 LS, HL	16HC37	04/84 ⇒ 08/88
MONTEGO 2.0	20HSC	04/84 ⇒ 08/88
MONTEGO 2.0 Turbo	20HC85	04/84 ⇒ 08/88

ROVER

200 II 220 GTi	20M4F	09/91 ⇒ 10/95
800 820	--	10/88 ⇒ 10/91
800 820 i/Si	20HD	10/88 ⇒ 12/91
800 820 Si	20HDM16	10/88 ⇒ 12/91
400 I 420 16V	--	01/91 ⇒ 12/92
400 I 420 GTi/GSi/Vitesse	20M4F	02/92 ⇒ 04/95
MAESTRO 1.6	16H	09/90 ⇒ 01/95
MAESTRO 2.0	--	01/86 ⇒
MONTEGO 2.0 GTi	20H	02/85 ⇒ 10/91

EPS 1.428.025



ROTORS

Adatt./Suitable: LUCAS

ROVER

GRA143
GRA2143

⁰³ Supplied until depletion

- Fornibile fino ad esaurimento delle scorte
- Fourni jusqu'à épuisement du stock
- Lieferbar solange vorrat reicht
- Suministrado hasta el stock termina



AUSTIN

MONTEGO 1.3	--, 12HL	10/84 ⇒ 08/88
-------------	----------	---------------

ROVER

100 / METRO 111 C/L/S	11K2A	03/90 ⇒ 12/98
100 / METRO 114 S/L/GTA	14K2A	03/90 ⇒ 12/98
100 114	14K2A	04/94 ⇒ 10/97
MAESTRO 1.3	12HE	09/90 ⇒ 01/95
MINI 1.3 Cooper	--	01/85 ⇒
MINI 1.3i Cooper	--	01/85 ⇒
MINI 1.3i Turbo	--	01/85 ⇒
MINI 1300	12A2A, 12A2B, 12A2D, 12A2E, 12A2L	01/91 ⇒ 04/95
MONTEGO 1.3	12HL	10/84 ⇒ 10/88

EPS 1.428.026R



ROTORS

Adatt./Suitable: LUCAS

FORD

1 655 993
6 153 387
6 182 581
845F-12200-CA

Motorcraft

EDR 159
EDR 249

²¹² Resistance Rotor [Ohm] 1000

- Rotore resistenza [Ohm] 1000
- Résistance rotor [ohm] 1000
- Widerstand-Rotor [Ohm] 1000
- Resistencia rotor [ohm] 1000



FORD

ESCORT IV 1.4	F6D, FUA, FUC	01/86 ⇒ 07/90
FIESTA II 1.6 XR2	LUB, LUD	03/84 ⇒ 02/89
FIESTA III 1.4	F6E	03/89 ⇒ 12/95
ESCORT III 1.4 i	F6D, FUC	02/86 ⇒ 07/90
ORION I 1.4	FUA, FUC	12/85 ⇒ 07/90
ORION I 1.4 Cat	F6D	02/87 ⇒ 07/90

ROVER

2000-3500 2000	--	10/82 ⇒ 10/86
----------------	----	---------------

EPS 1.428.027R



ROTORS

Adatt./Suitable: LUCAS

JAGUAR

JLM 381

²¹² Resistance Rotor [Ohm] 1000

- Rotore resistenza [Ohm] 1000
- Résistance rotor [ohm] 1000
- Widerstand-Rotor [Ohm] 1000
- Resistencia rotor [ohm] 1000



JAGUAR

XJ 3.6	9DPALA, 9DPANA	10/86 ⇒ 05/91
XJ 4.0	9EPCNA, 9LPFRB	10/89 ⇒ 03/96
XJ 6 3.2 24V	9BPMNA	09/90 ⇒ 11/94
XJ 6 3.6	9DPANA, AJ6(3.6, 156KW)	10/86 ⇒ 08/89
XJ 6 4.0	9EPCNA	09/89 ⇒ 11/94
XJSC 3.6	9DPALA, 9DPANA	08/87 ⇒ 05/91
XJSC 4.0	9EPCNA, 9LPFRB	05/91 ⇒ 03/96

EPS 1.428.028R



ROTORS

Adatt./Suitable: LUCAS

BOSCH

F 005 X04 676

GENERAL MOTORS

90 349 877

HOLDEN

90349877

OPEL

12 12 200

²¹² Resistance Rotor [Ohm] 5000

- Rotore resistenza [Ohm] 5000
- Résistance rotor [ohm] 5000
- Widerstand-Rotor [Ohm] 5000
- Resistencia rotor [ohm] 5000



HOLDEN

BARINA 1.4 i	C14NZ	04/94 ⇒ 07/97
BARINA_SB 1.2i	C12NZ	04/94 ⇒ 07/97
COMBO 1.4 i	C14NZ	03/96 ⇒ 07/97
COMBO_SB 1.4i	C14NZ	04/94 ⇒ 07/97

OPEL

ASTRA F 1.4	14SE	09/92 ⇒ 09/98
ASTRA F 1.4 i	C14NZ	09/91 ⇒ 01/05
ASTRA F 1.4 Si	C14SE	03/92 ⇒ 03/01
COMBO B 1.2	C12NZ	07/94 ⇒ 10/01
COMBO B 1.4	C14NZ	07/94 ⇒ 10/01
CORSA A 1.2 i	C12NZ	09/89 ⇒ 03/93
CORSA A 1.4 Si	C14SE	09/91 ⇒ 03/93
CORSA A 1.6 GSI	E16SE	05/88 ⇒ 03/92
CORSA B 1.2 i	12NZ, C12NZ	03/93 ⇒ 09/00
CORSA B 1.4 i	C14NZ	03/93 ⇒ 09/00
KADETT E 1.4 i	C14NZ	01/90 ⇒ 07/94
KADETT E 1.6	16SV	09/86 ⇒ 12/91
KADETT E 1.6 i	16SV	07/89 ⇒ 02/93
KADETT E 1.6 S	16SV	09/86 ⇒ 08/91
VECTRA A 1.6	16SV	09/88 ⇒ 05/93
VECTRA A 1.6 S	16SV	09/88 ⇒ 05/93

VAUXHALL

ASTRA III 1.4 i	C14NZ, C14SE	03/91 ⇒ 09/98
ASTRAVAN I 1.4 i	C14NZ	09/91 ⇒ 08/95
COMBO B 1.2	C12NZ	07/94 ⇒ 10/01
COMBO B 1.4	C14NZ	07/94 ⇒ 10/01
CORSA B 1.2 i	C12NZ	03/93 ⇒ 09/00
CORSA B 1.4 i	C14NZ	03/93 ⇒ 09/00
CORSAVAN I 1.4 i	C14NZ	01/94 ⇒ 09/00

EPS 1.428.029R



ROTORS

Adatt./Suitable: LUCAS

BOSCH

F 005 X04 678

LAND ROVER

NJE10003

ROVER

AUU1641
GRA2285
GRA2310
NJE100070

²¹² Resistance Rotor [Ohm] 1000

- Rotore resistenza [Ohm] 1000
- Résistance rotor [ohm] 1000
- Widerstand-Rotor [Ohm] 1000
- Resistencia rotor [ohm] 1000



LAND ROVER

FREELANDER 1.8 16V 4x4	18K4F	04/98 ⇒ 10/06
FREELANDER 1.8 i 16V 4x4	18K4F	02/98 ⇒ 10/06

MG

MGF 1.8 i 16V	18K4F	03/95 ⇒ 03/02
MG TF 115	16K4F	03/02 ⇒ 12/09
MG TF 120	18K4F	03/02 ⇒ 12/09
MG TF 135	18K4F	03/02 ⇒ 12/09
MG ZR 105	14K4F	06/01 ⇒ 04/05

MG		
MG ZR 120	18K4F	06/01 ⇒ 04/05
ROVER		
25 1.4 16V	14K4F, 14K4M	10/99 ⇒ 05/05
25 1.6 16V	16K4F	10/99 ⇒ 05/05
25 1.8 16V	18K4F	10/99 ⇒ 05/05
100 / METRO 111 C/L/S	11K2D	03/90 ⇒ 12/98
100 / METRO 114 GSi	14K4F	10/94 ⇒ 10/95
100 / METRO 114 GTI 16V	14K4C, 14K4D, 14K4F	03/90 ⇒ 12/98
100 / METRO 114 GTI/GT 16V Cat	14K4C, 14K4D	03/90 ⇒ 12/98
100 / METRO 114 S/L/GTA	14K2D	03/90 ⇒ 12/98
100 111	11K2D	04/94 ⇒ 10/97
100 114	14K2D	04/94 ⇒ 10/97
200 II 214	14K2A, 14K2D	09/93 ⇒ 12/95
200 II 214 1.4	14K4C, 14K4D	01/92 ⇒ 11/99
200 II 214 1.4i 16V	14K4F	01/93 ⇒ 11/99
200 II 214 GSi/Si	14K4C, 14K4F	01/90 ⇒ 10/95
200 II 214 Si/Gsi	14K4C, 14K4D	10/89 ⇒ 10/95
200 II 216	16K4F	01/96 ⇒ 12/97
200 II 216 1.6i 16V	16K4F	01/96 ⇒ 11/99
200 II 220 16V	--	01/92 ⇒ 12/95
200 II 220 GSi	1CA4GA15-01	05/94 ⇒ 06/99
200 II 220 GTi	1CA4GA15-01, 20M4F	09/91 ⇒ 10/95
200 II 220 Turbo	20T4G	10/92 ⇒ 06/99
200 III 211	11K2D	01/98 ⇒ 03/00
200 III 214 i	14K2F	11/95 ⇒ 03/00
200 III 214 Si	14K4F	11/95 ⇒ 03/00
200 III 216 Si	16K4F	11/95 ⇒ 06/99
400 II 414 Si	14K4F	05/95 ⇒ 03/00
400 II 416 Si	16K4F, D16Y2	03/95 ⇒ 03/00
600 620 Ti Vitesse	20T4G	05/94 ⇒ 08/98
800 820 16V Turbo	T16	11/91 ⇒ 02/99
800 820 I/Si	1CA4GA15-01	01/91 ⇒ 02/99
800 820 Sport	20T4G	04/94 ⇒ 03/96
400 I 1.6 i	16K4F, D16A8	05/94 ⇒ 11/98
400 I 414	14K4C	01/93 ⇒ 04/95
400 I 414 GSi/Si	14K4C, 14K4D	04/90 ⇒ 04/95
400 I 414 GSi/Si Cat	14K4F	10/92 ⇒ 04/95
400 I 420 GSi/SLI/GTI/Vite	1CA4GA15-01	01/93 ⇒ 04/95
400 I 420 GTI/GSi/Vitesse	20M4F	02/92 ⇒ 04/95
400 I 420 Turbo	20T4G	01/93 ⇒ 04/95
COUPE 1.6 16V	16K4F	03/96 ⇒ 11/99

EPS 1.428.030



ROTORI

Adatt./Suitable: LUCAS

NISSAN

22157-73C00
22157-99B01
22157-99B03



NISSAN

MICRA II 1.0 i 16V	CG10DE	08/92 ⇒ 07/00
MICRA II 1.3 i 16V	CG13DE	08/92 ⇒ 09/00
PRIMERA II 1.6 16V	GA16DE	09/96 ⇒ 07/02

EPS 1.430.029



ROTORI

Adatt./Suitable: MARELLI

FEMSA

4765
8415

FIAT

9902725
9908418
9909418
9911960

GENERAL MOTORS

7 992 296
7 992 896

MAGNETI MARELLI

070189501010
701 895 01
S 57/45

SEAT

008415.06



FIAT

500 0.5	110F.000, 120.000	01/60 ⇒ 12/75
500 0.6	111A000	08/68 ⇒ 01/76
600 0.6	--	03/55 ⇒ 05/61

EPS 1.430.036R



ROTORI

Adatt./Suitable: MARELLI

FIAT

4210514
9808037
9919627
9920580
9922446
9934741

GENERAL MOTORS

7 992 304
93 150 396

MAGNETI MARELLI

710 615 01
711 195 01
711 195 02
711 195 04
711 299 01
711 424 01

ZASTAVA

1335055



FIAT

128 1.1	128A.000	03/69 ⇒ 12/84
X 1/9 1.3	128AS.000	10/75 ⇒ 06/78

ZASTAVA

101 1.1	128A.000, 128A.064	05/75 ⇒ 12/93
101 1.1 Super	128AC5.000	07/79 ⇒ 09/81
YUGO 0.9	9A	04/80 ⇒ 06/92

EPS 1.430.037



ROTORI

Adatt./Suitable: MARELLI

BOSCH

1 234 332 808
1 234 332 810
1 234 332 812

FIAT

9913856
9915910
9919348
9921508
9923115
9924654

GENERAL MOTORS

7 992 299
7 992 300
7 992 632

MAGNETI MARELLI

710 640 01
710 640 02
711 214 01
711 323 01

SEAT

121334.06
NG1 323 013 1



FIAT

125 1.6	125A.000	07/67 ⇒ 03/74
131 1.3 Mirafiori	131A6.000	10/74 ⇒ 09/81
131 1.3 Super Mirafiori	131B.000	03/78 ⇒ 12/80
131 1.4 Mirafiori	131C.000, 131C1.000	11/80 ⇒ 01/84
131 1.6	131A1.000	10/74 ⇒ 09/81
131 1.6 Super	131C3.000	03/78 ⇒ 01/84
131 2.0 Super	131C4.000	01/81 ⇒ 12/84
850 0.8	100G.000, 100G.002	07/64 ⇒ 10/72
850 0.8 Special	100GB.000	03/68 ⇒ 10/72
850 0.9 Sport	--, 100GL.040	02/68 ⇒ 12/72

SEAT

IBIZA I 0.9	09NCA, 146A000	08/90 ⇒ 05/93
MARBELLA 0.9	09NCA, 100GL7000	01/87 ⇒ 12/93

EPS 1.430.037R



ROTORI

Adatt./Suitable: MARELLI

FIAT

4157304
82301158
82345471
9913857
9916593
9917213
9921476
9934726
9934727
9937729

GENERAL MOTORS

7 992 633

MAGNETI MARELLI

710 861 01
710 930 01
710 930 02
711 215 01
711 215 02
711 539 01

SEAT

NGO 930 023 1
NG1 215 023 1
NG1 539 013 1



FIAT

127 0.9	100GL.000	09/71 ⇒ 12/84
131 1.3 Mirafiori	131A6.000	10/74 ⇒ 09/81
132 1.6	132C.000	05/77 ⇒ 09/82

1.430.040

FIAT		
850 0.8	100G.000	07/64 ⇒ 10/72
ARGENTA 2000	132D1.000	06/78 ⇒ 12/85

EPS 1.430.040



ROTORS

Adatt./Suitable: **MARELLI**

FIAT
9926748
MAGNETI MARELLI
071171301010
711 713 01



FIAT		
126 600	126A.000	09/72 ⇒ 06/77
FSO		
126P 0.6	--	09/72 ⇒ 07/77

EPS 1.430.041



ROTORS

Adatt./Suitable: **MARELLI**

FEMSA
2443- 1
22431- 1
24431- 1
FIAT
82309214
9924394
GENERAL MOTORS
93 150 398
MAGNETI MARELLI
703 880 03
SEAT
244311.06

⁰⁰Eliminated on 21-01-2020. Please verify the availability through our local distributors

- Eliminato il 21-01-2020. Verificare la disponibilità presso i nostri distributori
- Éliminé le 21-01-2020. Vérifier la disponibilité auprès de nos distributeurs sur place
- Am 21-01-2020 gestrichen. Evtl. Verfügbarkeit bitte bei unseren Händlern prüfen
- Eliminado en fecha 21-01-2020. Verificar la disponibilidad a través de nuestros distribuidores locales



FIAT		
132 1.6	132C.000	05/77 ⇒ 09/82
ARGENTA 1600	132D.000	04/81 ⇒ 12/85
ARGENTA 1600 i.e	132D.000	04/81 ⇒ 12/85

EPS 1.430.042R



ROTORS

Adatt./Suitable: **MARELLI**

ALFA ROMEO
116 55 05 011 01/01
60730437
CITROËN
2L 548 622 2Y
95 538 865

FIAT
9924187
9928247
9929187

GENERAL MOTORS
93 150 120
93 150 399

MAGNETI MARELLI
711 195 03
711 195 05
711 424 02
712 279 01

SEAT
000 389 806 5
000 993 623 8
NG1 195 053 1
NG1 424 023 1
SE 127914.004A

⁰³Supplied until depletion

- Fornibile fino ad esaurimento delle scorte
- Fourni jusqu'à épuisement du stock
- Lieferbar solange vorrat reicht
- Suministrado hasta el stock termina

²¹²Resistance Rotor [Ohm] 5000

- Rotore resistenza [Ohm] 5000
- Résistance rotor [ohm] 5000
- Widerstand-Rotor [Ohm] 5000
- Resistencia rotor [ohm] 5000

²¹⁸with resistance

- con resistenza
- avec résistance
- mit Widerstand
- con resistencia



ALFA ROMEO		
ALFETTA 1.8	AR01608X	07/74 ⇒ 04/82
GIULIETTA I 1.3	AR01644	10/77 ⇒ 06/83
FIAT		
127 0.9	100GL.048	06/71 ⇒ 05/83
127 1.0	127A.000	01/77 ⇒ 12/86
131 1.3 Mirafiori	131A6.000	10/74 ⇒ 09/81
132 1.6	132C.000	05/77 ⇒ 09/82
ARGENTA 1600	132D.000	04/81 ⇒ 12/85
ARGENTA 1600 i.e	132D.000	04/81 ⇒ 12/85
FIORINO I 1.0	127A.000	01/80 ⇒ 12/87
FIORINO I 1050	127A.000	01/80 ⇒ 12/87
FIORINO I 900	100GL.000	10/77 ⇒ 10/86
PANDA I 800	100GL6.000	02/81 ⇒ 12/85
PANDA I 950	A112B1.054	09/82 ⇒ 08/83
PANDA I 950 4x4	A112B1.054	09/83 ⇒ 12/86
SEAT		
FURA 0.9	100GL3000	01/82 ⇒ 06/86
MARBELLA 0.8	5K9K718	08/86 ⇒ 12/93
PANDA 34 850	--	01/80 ⇒ 12/83
PANDA 35 850	--	01/80 ⇒ 12/83

EPS 1.430.047R



ROTORS

Adatt./Suitable: **MARELLI**

FIAT
82361915
9936023
INNOCENTI
82361915

LANCIA
9936023

MAGNETI MARELLI
712 372 01
712 378 01

PEUGEOT
5937 29

RENAULT
77 01 025 241

SEAT
000 389 977 0
SE 141914.004B

²¹²Resistance Rotor [Ohm] 5000

- Rotore resistenza [Ohm] 5000
- Résistance rotor [ohm] 5000
- Widerstand-Rotor [Ohm] 5000
- Resistencia rotor [ohm] 5000



FIAT		
CROMA I 2000 CHT	154A1.000, 154C5.000	12/85 ⇒ 09/92
DUNA 60 1.1	146A6.000	01/87 ⇒ 12/91
DUNA 70 1.3	146A5.000	01/87 ⇒ 12/91
ELBA 1.3	146A5.000	04/91 ⇒ 02/95
FIORINO I 1.1 60	146A9.000	11/86 ⇒ 04/88
FIORINO I 1.3	146A5.000	12/87 ⇒ 08/93
FIORINO II 1.3	146A5.000	01/88 ⇒ 12/94
FIORINO II 60 1.1	146A9.000	05/88 ⇒ 12/93
FIORINO II 70 1.3	146A5.000	01/88 ⇒ 12/94
PANDA I 750	141B.000	01/86 ⇒ 01/95
PANDA I 900	100GL3.000	10/80 ⇒ 06/94
PANDA I 900 CL	146A.048	01/86 ⇒ 12/92
REGATA 1.1 60 , 60 L	138B.000	10/83 ⇒ 08/86
REGATA 1.6	--	10/84 ⇒ 06/89
REGATA 70 1.3	138B2.000, 149A3.000	09/83 ⇒ 07/89
REGATA 85 1.5	149A5.000	05/85 ⇒ 12/87
REGATA 85 1.6	149A.000	10/83 ⇒ 06/90
RITMO I 1.1	146A4.048	04/85 ⇒ 12/87
RITMO I 1.3	149A3.000	11/83 ⇒ 08/85
TIPO I 1.4	160A1.000	07/87 ⇒ 12/89
UNO 45 0.9	146A.000, 146A1.000	03/83 ⇒ 07/96
UNO 45 0.9 Trend	146A.048	09/89 ⇒ 09/92
UNO 60 1.1	146A4.048	05/85 ⇒ 02/92
UNO 60 1.1 SX	--	01/83 ⇒ 12/89
UNO CS 1.1	146A6.000	09/87 ⇒ 09/91
FIAT (BR)		
UNO CS 1116	--	01/88 ⇒
INNOCENTI		
ELBA 1.3	146A5.000	08/91 ⇒ 12/96
LANCIA		
DELTA I 1.1	831B8.000	01/86 ⇒ 12/90
DELTA I 1.3	1831B.000, 3831B.000, 831A2.000, 831B.000	09/79 ⇒ 10/92
PRISMA 1.3	831A2.000	01/83 ⇒ 12/89
PRISMA 1.5	831A1.000	01/83 ⇒ 04/86
PEUGEOT		
305 1.5	117(XR55)	05/80 ⇒ 09/82
505 2.0	106E(XN1A)	09/85 ⇒ 09/95
RENAULT		
4 1.1	688712	02/78 ⇒ 06/90
9 1.1	C1E715	09/81 ⇒ 05/87
11 1.1	C1E715, C1E720	03/83 ⇒ 06/86
11 1.7	F2N700	10/83 ⇒ 12/87
14 1.4	150	09/79 ⇒ 06/83
RAPID 1.1	C1E750, C1E760	07/85 ⇒ 04/95
SUPER 5 1.0	C1C700	10/84 ⇒ 10/88
SEAT		
IBIZA I 0.9	146A000	08/86 ⇒ 05/93
IBIZA I 1.2	021A1000	11/84 ⇒ 12/93
MALAGA 1.2	021A1000	05/85 ⇒ 12/93
MALAGA 1.5	021A2000	05/85 ⇒ 12/93
MARBELLA 0.9	09NCA	01/87 ⇒ 12/93
TERRA 0.9	09NCA	02/87 ⇒ 12/96

EPS 1.430.051R



ROTORS

Adatt./Suitable: MARELLI

ALFA ROMEO

705 390
60749769

MAGNETI MARELLI

711 016 07

⁰⁰ Eliminated on 22-02-2022. Please verify the availability through our local distributors

- Eliminato il 22-02-2022. Verificare la disponibilità presso i nostri distributori
- Éliminé le 22-02-2022. Vérifier la disponibilité auprès de nos distributeurs sur place
- Am 22-02-2022 gestrichen. Evtl. Verfügbarkeit bitte bei unseren Händlern prüfen
- Eliminado en fecha 22-02-2022. Verificar la disponibilidad a través de nuestros distribuidores locales

²¹² Resistance Rotor [Ohm] 5000

- Rotore resistenza [Ohm] 5000
- Résistance rotor [ohm] 5000
- Widerstand-Rotor [Ohm] 5000
- Resistencia rotor [ohm] 5000

³¹⁰ RPM to [1/min] 6800

- N° giri fino a [1/min.] 6800
- Régime mot. jusqu'à [1/min] 6800
- Drehzahl bis [1/min] 6800
- vel. giro hasta [1/min] 6800



ALFA ROMEO

33 I 1.3	AR30168	10/84 ⇨ 12/89
33 I 1.3 i.e.	AR30168	05/83 ⇨ 12/89
33 I 1.5 4x4	AR30508	12/86 ⇨ 03/89
ALFASUD 1.5 ti	AR30128	05/80 ⇨ 06/84

EPS 1.430.054R



ROTORS

Adatt./Suitable: MARELLI

ABARTH

9937767

ALFA ROMEO

116 58 05 011 00/02
60731801

FIAT

313220203
6313220203
9937767

GENERAL MOTORS

7 992 874

LANCIA

9937767

MAGNETI MARELLI

710 930 03

MASERATI

313220203
6313220203

SEAT

000 389 948 9
3899489

²¹² Resistance Rotor [Ohm] 5000

- Rotore resistenza [Ohm] 5000
- Résistance rotor [ohm] 5000
- Widerstand-Rotor [Ohm] 5000
- Resistencia rotor [ohm] 5000



ABARTH

RITMO 125 TC 2.0	138AR1.000	11/81 ⇨ 12/87
------------------	------------	---------------

ALFA ROMEO

75 1.8	AR06202	09/85 ⇨ 06/89
90 1.8	AR06202	10/84 ⇨ 07/87
90 2.0 i.e.	AR06210	10/84 ⇨ 07/87

ALFA ROMEO

ALFETTA 1.6	AR01600	01/75 ⇨ 12/84
ALFETTA 1.8	AR01608	10/79 ⇨ 12/84
GIULIETTA I 1.6	AR01600	10/77 ⇨ 04/85
GIULIETTA I 1.8	AR01678	04/79 ⇨ 04/85
GIULIETTA I 2.0	AR01655	06/80 ⇨ 04/85

FIAT

124 1200	124A.000	07/66 ⇨ 10/73
124 1400 Special	124B2.000	12/68 ⇨ 12/72
124 1600 Special T	132AC.000	01/73 ⇨ 07/75
124 Spider, Sport [USA]	--	01/79 ⇨ 12/86
131 2.0 Brava [USA]	--	01/79 ⇨ 12/84
132 2.0	132C2.000	01/76 ⇨ 06/81
ARGENTA 2000	132D1.000	06/78 ⇨ 12/85
ARGENTA 2000 i.e.	132C3.000	06/81 ⇨ 07/86
RITMO II 105 1.6	138AR.000	01/83 ⇨ 12/87

LANCIA

A 112 1.0 Abarth	A112A2.000	03/78 ⇨ 02/84
BETA 1600	828B.000	08/73 ⇨ 07/82

MASERATI

BITURBO i	AM452	07/85 ⇨ 04/87
-----------	-------	---------------

SEAT

RONDA 1.2	021A1000	08/83 ⇨ 05/85
-----------	----------	---------------

EPS 1.430.055R



ROTORS

Adatt./Suitable: MARELLI

ALFA ROMEO

9938173
9950047

FIAT

9938173

LANCIA

9938173

MAGNETI MARELLI

712 753 01

²¹² Resistance Rotor [Ohm] 1000

- Rotore resistenza [Ohm] 1000
- Résistance rotor [ohm] 1000
- Widerstand-Rotor [Ohm] 1000
- Resistencia rotor [ohm] 1000



ALFA ROMEO

164 2.0 Turbo	AR06476	10/87 ⇨ 09/98
---------------	---------	---------------

FIAT

CROMA I 1600	154A.048	12/85 ⇨ 12/90
CROMA I 2000 CHT	154A1.000, 154C5.000	12/85 ⇨ 09/92
CROMA I 2000 i.e. Turbo	154A2.000	12/85 ⇨ 06/90
FIORINO I 1.5	149C1.000	01/88 ⇨ 08/93
FIORINO II 1.5 iE	149C1.000	01/88 ⇨ 10/92
FIORINO II 75 i.e. 1.5	149C1.000	05/88 ⇨ 12/93
REGATA 1.6	--	09/86 ⇨ 06/89
REGATA 100 Super 1.6	149A2.000	10/83 ⇨ 12/90
REGATA 85 1.5	149A5.000	05/85 ⇨ 12/87
RITMO I 1.5	138C2.048	10/85 ⇨ 05/87
RITMO I 1.6	149A4.000	01/83 ⇨ 12/87
RITMO II 75 1.5	138A2.000	09/85 ⇨ 12/88
TEMPRA 1.6	159A3.000, 159A3.048, 159A3.098	03/90 ⇨ 12/96

TEMPRA 1.6 i.e.	159A3.046, 159A3.048	06/90 ⇨ 08/96
TIPO I 1.4	160A1.048	07/87 ⇨ 12/89
TIPO I 1.4 i.e.	160A1.046	05/89 ⇨ 04/95
TIPO I 1.6	160A2.000	01/88 ⇨ 10/92
TIPO I 1.6 SX DGT	159A3.000	05/89 ⇨ 10/95
UNO 1.3 Turbo i.e.	146A2.000	04/85 ⇨ 08/89
UNO 1.4 Super	146C2.028	09/89 ⇨ 09/92
UNO 1.4 Turbo i.e.	146A8.000, 146A8.046	09/89 ⇨ 12/96
UNO 70 1.3i SX	--	01/83 ⇨ 12/89
UNO 70 i.e. 1.4	146C1.000, 160A1.046	09/89 ⇨ 07/96
UNO 70 S 1.4	160A1.048	10/88 ⇨ 06/06
UNO 75 i.e. 1.5	138C2.048, 149C1.000	10/85 ⇨ 12/93

FIAT (BR)

UNO 1.4i Turbo	1.4Mpi	01/94 ⇨ 12/96
----------------	--------	---------------

LANCIA

DEDRA 1.6 i.e.	835A1.000, 835A1.046	08/89 ⇨ 06/94
DELTA I 1.5	831A1.000, 831B1.000	09/79 ⇨ 12/92
PRISMA 1.5	831B1.000	05/86 ⇨ 07/89
PRISMA 1.6	831B6.000	08/86 ⇨ 02/92
THEMA 2000 i.e	834B1.000	09/88 ⇨ 05/92
THEMA 2000 i.e.	834B.146	09/87 ⇨ 05/92
THEMA 2000 i.e. Turbo	834C.146	07/86 ⇨ 05/90
THEMA 2000 Turbo	834C.146	12/88 ⇨ 03/92

LANCIA

Y10 1.3 i.e.	146A5.046, 156B.000	11/87 ⇨ 12/95
--------------	---------------------	---------------

EPS 1.430.057R



ROTORS

Adatt./Suitable: MARELLI

FIAT

9940428

FORD

1 641 611
V83H-F12200-AA

LANCIA

9940428

MAGNETI MARELLI

712 372 02
713 774 02

Motorcraft

EDR 161
EDR 210

SEAT

030 905 225 C

SKODA

030 905 225 C

VW

030 905 225 C



FIAT

CROMA I 2000 i.e.	154C3.000, 834B.048, 834B.048	03/86 ⇨ 09/92
-------------------	-------------------------------	---------------

REGATA 90 i.e. 1.6	149C2.000	01/87 ⇨ 07/89
--------------------	-----------	---------------

FORD

ESCORT V RS Cosworth 4x4	N5F	10/91 ⇨ 01/95
--------------------------	-----	---------------

LANCIA

DELTA I 1.6 GT i.e.	149C2.000, 831B7.000	08/86 ⇨ 08/92
---------------------	----------------------	---------------

DELTA I 1.6 HF Turbo	831B3.000, 831B7.046	08/86 ⇨ 03/89
----------------------	----------------------	---------------

DELTA I 2.0 16V HF Integrale	831D5.000	03/89 ⇨ 09/91
------------------------------	-----------	---------------

DELTA I 2.0 HF Integrale	831B5.000, 831C5.000, 831C5.046	11/86 ⇨ 12/92
--------------------------	---------------------------------	---------------

PRISMA 1.6 i.e.	831B7.000	05/86 ⇨ 12/89
-----------------	-----------	---------------

PRISMA 2.0 i.e. Trazione integrale	831B4.000	04/86 ⇨ 12/89
------------------------------------	-----------	---------------

SEAT

AROSA 1.0	AER, ALL	05/97 ⇨ 06/04
-----------	----------	---------------

AROSA 1.4	AEX, AKV, APQ	05/97 ⇨ 06/04
-----------	---------------	---------------

CORDOBA I 1.0 i	AER	09/96 ⇨ 10/02
-----------------	-----	---------------

CORDOBA I 1.4	ANX	12/97 ⇨ 04/99
---------------	-----	---------------

CORDOBA I 1.4 i	AKV, APQ	06/94 ⇨ 12/02
-----------------	----------	---------------

CORDOBA I 1.4 i 16V	AFH	09/96 ⇨ 10/02
---------------------	-----	---------------

CORDOBA I 1.6 i	AEE, ALM	02/93 ⇨ 12/02
-----------------	----------	---------------

IBIZA II 1.0 i	AER	09/96 ⇨ 02/02
----------------	-----	---------------

IBIZA II 1.4	ANX	12/97 ⇨ 04/99
--------------	-----	---------------

IBIZA II 1.4 i	ABD, AEX, AKV, APQ	09/93 ⇨ 02/02
----------------	--------------------	---------------

IBIZA II 1.4 i 16V	AFH	06/97 ⇨ 02/02
--------------------	-----	---------------

IBIZA II 1.6 i	AEE, ALM	03/93 ⇨ 02/02
----------------	----------	---------------

INCA 1.4 i	AEX, AKV, APQ	11/95 ⇨ 06/03
------------	---------------	---------------

INCA 1.6 i	1F, AEE	11/95 ⇨ 05/98
------------	---------	---------------

SKODA

FELICIA 1.6	6A16XHT	06/97 ⇨ 04/02
-------------	---------	---------------

FELICIA 1.6 GLX	6A16XHT	08/95 ⇨ 03/98
-----------------	---------	---------------

FELICIA 1.6 LX	6A16XHT	08/95 ⇨ 03/98
----------------	---------	---------------

OCTAVIA I 1.6	6A16XHT	09/96 ⇨ 09/04
---------------	---------	---------------

VW

CADDY II 1.4	AEX, AKV, APQ	11/95 ⇨ 06/03
--------------	---------------	---------------

CADDY II 1.6	AEE	06/96 ⇨ 12/00
--------------	-----	---------------

CADDY II 60 1.4	AEX, APQ	11/95 ⇨ 01/04
-----------------	----------	---------------

CADDY II 75 1.6	AEE	11/95 ⇨ 09/00
-----------------	-----	---------------

GOLF III 1.4	AEX	10/91 ⇨ 04/99
--------------	-----	---------------

GOLF III 1.6	AEE	09/92 ⇨ 08/97
--------------	-----	---------------

LUPU 1.0	AER, ALL	09/98 ⇨ 07/05
----------	----------	---------------

POLO III 1.4	AEX, AKV, ANX, APQ	05/97 ⇨ 09/01
--------------	--------------------	---------------

POLO III 1.6	AEA, AEE, ALM	09/94 ⇨ 09/01
--------------	---------------	---------------

POLO III 100 1.4 16V	AFH	04/96 ⇨ 10/99
----------------------	-----	---------------

POLO III 50 1.0	AER, ALL	09
-----------------	----------	----

EPS 1.430.058



3

ROTORS

Adatt./Suitable: MARELLI

JAGUAR
JLM 1911MAGNETI MARELLI
713 524 01

Eliminated on 25-07-2019. Please verify the availability through our local distributors

- Eliminato il 25-07-2019. Verificare la disponibilità presso i nostri distributori
- Éliminé le 25-07-2019. Vérifier la disponibilité auprès de nos distributeurs sur place
- Am 25-07-2019 gestrichen. Evtl. Verfügbarkeit bitte bei unseren Händlern prüfen
- Eliminado en fecha 25-07-2019. Verificar la disponibilidad a través de nuestros distribuidores locales



JAGUAR

XJ 5.3	85(92-93)	05/91 ⇒ 08/93
XJ 6.0	8D	05/93 ⇒ 03/96
XJ V12 6.0	8C(92-94)	03/93 ⇒ 11/94
XJSC 5.3	85(92-93)	05/91 ⇒ 08/93
XJSC 6.0	8D	05/93 ⇒ 03/96

EPS 1.430.059



1

ROTORS

Adatt./Suitable: MARELLI

ALFA ROMEO
9950142FIAT
9943506INNOCENTI
9943506LANCIA
9943506MAGNETI MARELLI
071351702010
71351702RENAULT
77 01 034 947

ALFA ROMEO

164 2.0 Turbo	AR06476	10/87 ⇒ 09/98
---------------	---------	---------------

FIAT

CROMA I 2000 CHT	154A1.000, 154C5.000	12/85 ⇒ 09/92
CROMA I 2000 i.e.	154C3.000, 154C3.046, 834B.146	10/87 ⇒ 12/96
CROMA I 2000 i.e. Turbo	154A2.000, 154C4.000, 154C4.046, 834C.146	12/85 ⇒ 08/96
ELBA 1.5	149C1.000	01/92 ⇒ 12/96
FIORINO I 1.5	149C1.000	01/88 ⇒ 08/93
FIORINO II 1.5 iE	149C1.000	01/88 ⇒ 10/92
FIORINO II 1.6	146C6.000	01/94 ⇒ 05/01
FIORINO II 70 i.e. 1.4	146C5.000	05/94 ⇒ 05/01
FIORINO II 75 i.e. 1.5	149C1.000	05/88 ⇒ 12/93
FIORINO II 75 i.e. 1.6	146C6.000	10/93 ⇒ 05/01
TEMPRA 1.4 i.e.	159A2.000, 160A1.046	04/90 ⇒ 08/96
TEMPRA 1.6	159A3.000, 159A3.048, 159A3.098	03/90 ⇒ 12/96
TEMPRA 1.6 i.e.	159A3.046, 159A3.048	06/90 ⇒ 08/96
TIPO I 1.4	160A1.048	07/87 ⇒ 12/89
TIPO I 1.4 i.e.	160A1.046	05/89 ⇒ 04/95
TIPO I 1.6	159A3.048, 835C1.000	03/93 ⇒ 10/95
TIPO I 1.6 i.e.	159A3.046, 159A3.048, 835C1.000	07/90 ⇒ 04/95
TIPO I 1.6 i.e. [BRA]	160E2.011	03/93 ⇒ 04/95
TIPO I 1.6 SX DGT	159A3.000	05/89 ⇒ 10/95

FIAT

UNO 1.3 Turbo i.e.	146A2.246	09/89 ⇒ 03/91
UNO 1.4 Super	146C2.028	09/89 ⇒ 09/92
UNO 45 1.0 Fire	--	01/83 ⇒ 12/89
UNO 70 i.e. 1.4	146C1.000, 160A1.046	09/89 ⇒ 07/96
UNO 70 S 1.4	160A1.048	10/88 ⇒ 06/06
UNO 75 i.e. 1.5	149C1.000	10/85 ⇒ 12/93
UNO Mondo 1.4 Super	146C2.028	01/96 ⇒

FIAT (BR)

UNO 1.4i Turbo	1.4Mpi	01/94 ⇒ 12/96
----------------	--------	---------------

INNOCENTI

ELBA 1.5 i.e.	149C1.000	08/92 ⇒ 09/94
ELBA 1.6 i.e.	146C6.000	09/94 ⇒ 12/96
MILLE 1.4	160A1046	07/95 ⇒ 05/97

LANCIA

DEDRA 1.6	835A1000	07/94 ⇒ 02/97
DEDRA 1.6 i.e.	835A1.000, 835A1.046	08/89 ⇒ 06/94
DELTA II 1.4 i.e.	160A1.046	10/94 ⇒ 08/99
THEMA 2000 i.e	834B1.000	09/88 ⇒ 05/92
THEMA 2000 i.e.	834B.146	09/87 ⇒ 05/92
THEMA 2000 i.e. Turbo	834C.146	07/86 ⇒ 05/90
THEMA 2000 Turbo	834C.146	12/88 ⇒ 03/92

RENAULT

19 I 1.2i	E7F	01/89 ⇒ 12/92
19 I 1.4	E6J700, E6J701, E7J700	01/88 ⇒ 12/92
19 II 1.2	E7F730	05/92 ⇒ 09/94
19 II 1.4	E6J706, E7J706, E7J707, E7J742, E7J745	01/92 ⇒ 12/95
CLIO I 1.2	E5F710, E5F716, E7F700, E7F706, E7F708, E7F750	05/90 ⇒ 09/98
CLIO I 1.4	E6J712, E6J713, E6J718, E7J601, E7J710, E7J711, E7J716, E7J718, E7J719, E7J754, E7J756, E7J757	01/90 ⇒ 09/98
EXPRESS 1.4	E6J/E7J	01/85 ⇒ 10/90
MEGANE I 1.4	E7J764	09/96 ⇒ 08/03
MEGANE I 1.4 e	E7J764	01/96 ⇒ 08/03
MEGANE I 1.4 Eco	E7J624	01/96 ⇒ 03/99
MEGANE SCÉNIC I 1.4 i	E7J764	01/97 ⇒ 09/99
RAPID 1.4	E6J738, E7J720, E7J724, E7J726, E7J728, E7J770, E7J771, E7J773	09/91 ⇒ 03/98
RAPID 1.4 RN	E6J734	09/91 ⇒ 08/93

EPS 1.430.060



1

ROTORS

Adatt./Suitable: MARELLI

FIAT

9939790
9944407
9946356INNOCENTI
9946356LANCIA
9944407MAGNETI MARELLI
071371301010
713 053 01
713 713 01

CITROËN

AX 10	C1A	09/86 ⇒ 06/92
AX 10 E	C3A	12/86 ⇒ 12/88
AX 11	H1A, H1B	12/86 ⇒ 04/94
AX 11 4x4	H1A	06/91 ⇒ 07/92
AX 11 Cat	HAZ(TU1CP)	09/88 ⇒ 12/89
ZX 1.1	H1A, H1B, TU1	03/91 ⇒ 08/95

FIAT

COUPE 2.0 16V	836A3.000	11/93 ⇒ 08/96
COUPE 2.0 16V [BRA]	836A3.011	11/93 ⇒ 08/96
CROMA I 2000 i.e.	154C3.000, 834B.000, 834B.048	03/86 ⇒ 09/92

ELBA 1.3

FIORINO I 1.1 60	146A9.000	11/86 ⇒ 04/88
FIORINO I 1.3	146A5.000	12/87 ⇒ 08/93
FIORINO II 1.0 iE	156A2.246	11/92 ⇒ 04/96
FIORINO II 1.3	146A5.000	01/88 ⇒ 12/94
FIORINO II 60 1.1	146A9.000	05/88 ⇒ 12/93
FIORINO II 70 1.3	146A5.000	01/88 ⇒ 12/94
PALIO 1.1	178B9.033	07/97 ⇒ 10/03
PANDA I 1.1	156C.046	05/91 ⇒ 03/95

FIAT

PANDA I 1000	156A2.000, 156A2.100, 156A3.000	01/85 ⇒
PANDA I 1000 4x4	156A2.100, 156A2.246, 156A3.000	01/86 ⇒ 12/94
PANDA I 1000 CLX	156A2.000	05/91 ⇒ 12/94
PANDA I 1000 Fire	156A2.000	05/86 ⇒ 04/91
PANDA I 1000 Fire [CHE]	156A2.146	11/87 ⇒ 04/91
PANDA I 1000 Fire [DEU]	156A2.048	01/86 ⇒ 07/89
PANDA I 1000 i.e	156A2.246	08/92 ⇒ 02/04
PANDA I 1000 i.e. Cat	156A2.246	10/87 ⇒ 08/98
PANDA I 1100 i.e.	156C.046	01/86 ⇒ 04/91
PANDA I 1100 Trekking 4x4	156C.046	10/91 ⇒ 07/04
PANDA I 750	156A4.000	01/86 ⇒ 10/03
PANDA I 750 Cat	156A4.048	01/95 ⇒ 10/03
PANDA I 750 Fire	156A4.048	11/88 ⇒ 04/91
TEMPRA 1.4 i.e.	159A2.000, 160A1.046	04/90 ⇒ 08/96
TEMPRA 1.6	159A3.000, 159A3.048, 159A3.098	03/90 ⇒ 12/96
TEMPRA 1.6 i.e.	159A3.046, 159A3.048	06/90 ⇒ 08/96
TEMPRA 1.8 4x4	159A4.000	07/92 ⇒ 06/93
TEMPRA 1.8 i.e.	159A4.000, 159A4.046	03/90 ⇒ 08/96
TEMPRA 2.0	159A6.046	04/90 ⇒ 06/93
TEMPRA 2.0 i.e.	159A6.046	10/90 ⇒ 09/96
TEMPRA 2.0 i.e. [BRA]	159A6.011	04/93 ⇒ 12/96
TEMPRA 2.0 i.e. 4x4	159A6.046	03/92 ⇒ 03/95
TIPO I 1.1	160A3.000	01/88 ⇒ 10/91
TIPO I 1.4 i.e.	159A2.000	05/89 ⇒ 04/95
TIPO I 1.8 i.e.	159A4.000, 159A4.046	10/90 ⇒ 06/93
TIPO I 1.8 i.e. 16V Sport	160A5.000	11/89 ⇒ 06/92
TIPO I 2.0	159A5.046, 159A6.046, 836A3.011	10/90 ⇒ 04/95
TIPO I 2.0 16V	160A8.046	07/91 ⇒ 04/95
TIPO I 2.0 i.e.	159A5.046, 159A6.046	03/90 ⇒ 04/95
TIPO I 2.0 i.e. [BRA]	159A6.011	03/93 ⇒ 10/95
TIPO I 2.0 i.e. 16V Sport	836A3.000	03/93 ⇒ 04/95
UNO 1.0	146A2.166	11/94 ⇒ 08/00
UNO 45 1.0	156A2.000, 156A2.100	06/86 ⇒ 12/93
UNO 45 i.e. 1.0	156A2.246	10/84 ⇒ 10/95
UNO 50 1.1	156C.046	01/90 ⇒ 12/93
UNO 50 i.e. 1.1	146C3.000	06/92 ⇒ 12/93
UNO 60 1.1	146A4.048	02/88 ⇒ 12/92
UNO 60 1.1 SX	--	01/85 ⇒ 12/89
UNO Mondo 1.0	146A2.166	01/98 ⇒
UNO Mondo 1.0 [IND]	146A2.166	01/98 ⇒

FIAT (BR)

COUPE 2.0i 16V	2.0Mpi	01/95 ⇒ 12/97
TIPO 2.0i 16V	2.0Mpi	01/94 ⇒ 12/95
TIPO 2.0i 8v	2.0Mpi	01/94 ⇒ 12/95

INNOCENTI

ELBA 1.3	146A5.000	08/91 ⇒ 12/96
ELBA 1.4 i.e.	146C5.000	09/94 ⇒ 12/96

LANCIA

DEDRA 1.8 i.e.	835A2.000, 835A2.046, 835C5.000	09/89 ⇒ 07/99
DEDRA 2.0 16V	836A3.000	07/94 ⇒ 07/99
DEDRA 2.0 HF Integrale	835A7.046	11/90 ⇒ 07/94
DEDRA 2.0 i.e.	835A5.000, 835A5.046	09/89 ⇒ 07/99
DEDRA 2.0 i.e. Turbo	835A8.046	04/91 ⇒ 07/99
DEDRA 2.0 i.e. Turbo Integrale	835A7.000	04/90 ⇒ 08/91
DEDRA 2.0 Integrale	836A3.000	07/94 ⇒ 07/99
DEDRA 2.0 Turbo	835A8.000	11/90 ⇒ 06/94
DELTA I 1.3	1831B.000, 3831B.000, 831A2.000, 831B.000	09/79 ⇒ 10/92
DELTA I 1.6 GT i.e.	149C2.000, 831B7.000	08/86 ⇒ 08/92
DELTA I 1.6 HF Turbo	831B3.000, 831B7.046	08/86 ⇒ 03/89
DELTA I 2.0 16V HF Evo Integrale	831E5.000	06/93 ⇒ 01/94
DELTA I 2.0 HF Integrale	831C5.046	12/86 ⇒ 12/92
DELTA II 2.0 16V	836A3.000	06/93 ⇒ 08/99
PRISMA 1.3	831A2.000	01/83 ⇒ 12/89
Y10 1.0 Fire	156A2.100	06/85 ⇒ 06/91
Y10 1.0 Fire Catalytic-Conv	156A2.246	10/87 ⇒ 02/92
Y10 1.0 Fire Trazione integrale	156A2.000, 156A2.100, 156A2.246	12/86 ⇒ 02/92
Y10 1.1 i.e. Fire	156C.000	08/89 ⇒ 06/92
Y10 1.1 i.e. Fire Trazione integrale	156C.000	08/89 ⇒ 06/92
Y10 1.1 i.e. Fire	156C.046	07/89 ⇒ 09/95

PEUGEOT

106 I 1.0	TU9	09/91 ⇒ 03/01
106 I 1.1	H1B(TU1)	08/91 ⇒ 03/96
205 II 1.0	TU9	10/87 ⇒ 09/98
309 II 1.1	H1B(TU1)	09/89 ⇒ 10/93

EPS 1.431.023



ROTORS

Adatt./Suitable: **MITSUBISHI**

BOSCH

1 987 234 009
1 987 234 024
1 987 234 909

GENERAL MOTORS

7 992 636
7 992 994

HYUNDAI

27115-21020
27131-11000
27132-11000

MAZDA

0324-24-312
AM01-24-312
F855-24-312

MITSUBISHI

MD602758
MD611850
T12271
T880T12271

Motorcraft

EDR 80

NISSAN

22157-10B10
22157-R9006
22157-R9007⁰³ Supplied until depletion

- Fornibile fino ad esaurimento delle scorte
- Fourni jusqu'à épuisement du stock
- Lieferbar solange vorrat reicht
- Suministrado hasta el stock termina

²⁰² without resistance

- senza resistenza
- sans résistance
- ohne Widerstand
- sin resistencia



FORD AUSTRALIA

COURIER 1.8	--	01/79 ⇒ 12/84
COURIER 2.0	--	01/79 ⇒
LASER 1.3	E3	03/81 ⇒ 02/83
LASER 1.5	E5	03/81 ⇒ 02/83
LASER 1.5 Sport	E5	03/81 ⇒ 02/83
METEOR 1.3	--	04/82 ⇒ 09/85

HYUNDAI

ELANTRA I 1.5	--	10/90 ⇒ 04/95
EXCEL 1.3	G4AN	07/85 ⇒ 07/91
EXCEL 1.5	G4AJ	07/85 ⇒ 08/89
LANTRA I 1.5	G4DJ	10/90 ⇒ 04/95
PONY 1.3	G13B	10/85 ⇒ 01/95
PONY 1.5	G15B, G4DJ	10/85 ⇒ 01/95
PONY / EXCEL 1.3	G4DG	01/90 ⇒ 01/95
PONY / EXCEL 1.5	G15B, G4DJ	01/90 ⇒ 01/95
S COUPE 1.5	G4DJIA	03/90 ⇒ 12/92
STELLAR 1.4	G633	10/83 ⇒ 08/86
STELLAR 1.6	G32B	10/83 ⇒ 12/91
STELLAR 2.0	--	01/87 ⇒ 12/91

MAZDA

929 I 2.0	MA	05/79 ⇒ 07/86
929 II 2.0	FE(8V)	03/84 ⇒ 07/87

MITSUBISHI

COLT I 1.2 GL	4G11	12/78 ⇒ 01/84
COLT III 1.3 GL	4G13(8V)	04/88 ⇒ 12/90
COLT II 1.3 EL, GL	G13B	06/86 ⇒ 04/88
CORDIA 1.8 [USA]	G62B	01/82 ⇒ 12/88
CORDIA 1.8 Turbo [USA]	G62B	01/82 ⇒ 12/88
LANCER V 1.2 GL	4G16	05/88 ⇒ 08/92
LANCER V 1.3	4G13(8V), G13B	04/88 ⇒ 05/92
LANCER V 1.3 GL	G13B	05/88 ⇒ 06/90
LANCER V 1.5	4G15(12V), 4G15(8V)	04/88 ⇒ 05/92
LANCER V 1.8 4WD	4G37	03/89 ⇒ 12/90
LANCER III/IV 1.2	4G16	08/86 ⇒ 04/88
GALANT VI 1.6	4G32	01/88 ⇒ 10/92
GALANT VI 1.8	4G37	11/87 ⇒ 10/92
L200 II 1.6	4G32	04/87 ⇒ 10/96
L200 II 2.6 4WD	G54B	11/89 ⇒ 05/95
MONTERO 2.6i [USA]	4G54	01/83 ⇒ 12/90
PAJERO 1.2.6	4G54	01/83 ⇒ 11/90
PAJERO 1.2.6 4WD	4G54	01/83 ⇒ 05/91
PAJERO II 2.6 4WD	4G54	03/91 ⇒ 10/97
SHOGUN I 2.6 4x4	4G54	01/84 ⇒ 02/91
STARION 2.0 Turbo ECi	4G63-T(ECI), 4G63-T/C	06/82 ⇒ 08/87
TRUCK 2.6 [USA]	G54B	01/86 ⇒

NISSAN

URVAN III 2.0	Z20	05/87 ⇒ 05/97
VANETTE II 1.5	A15	04/87 ⇒ 11/94

EPS 1.431.030



ROTORS

Adatt./Suitable: **MITSUBISHI**

BOSCH

1 987 234 051

MITSUBISHI

T13371
T880T13371

NISSAN

22157-23G15
22157-M5610⁰³ Supplied until depletion

- Fornibile fino ad esaurimento delle scorte
- Fourni jusqu'à épuisement du stock
- Lieferbar solange vorrat reicht
- Suministrado hasta el stock termina



NISSAN

NAVARA I 2.4	Z24i	06/92 ⇒ 02/97
SUNNY II 1.4 LX	GA14S	10/88 ⇒ 08/91
VANETTE II 2.0	Z20S	07/87 ⇒ 08/94

EPS 1.431.107



ROTORS

Adatt./Suitable: **MITSUBISHI**

BOSCH

1 987 234 058

HYUNDAI

27115-32500
27131-32810

MITSUBISHI

27131-32810
MD611151
T16571⁰³ Supplied until depletion

- Fornibile fino ad esaurimento delle scorte
- Fourni jusqu'à épuisement du stock
- Lieferbar solange vorrat reicht
- Suministrado hasta el stock termina



HYUNDAI

ELANTRA I 1.5 i GL	G4DJ	12/90 ⇒ 08/94
H-1 I 2.4	G4CS	06/97 ⇒ 04/04
H-1 I 2.4 4WD	G4CS	02/98 ⇒ 04/04
H100 2.4	G4CS	07/93 ⇒ 12/04
LANTRA I 1.5 i.e.	G4DJ	10/90 ⇒ 11/95
PONY 1.5 i	G15B, G4DJ	10/89 ⇒ 01/95
PONY / EXCEL 1.5 i	G15B, G4DJ	01/90 ⇒ 01/95
PORTER I 2.4	G4CS	03/96 ⇒ 04/04
PRECIS 1.5 i [USA]	G4DJ	01/89 ⇒
SANTAMO 2.0 16V	G4JP	05/99 ⇒ 12/02
SANTAMO 2.0 16V 4x4	G4CP-D	05/99 ⇒ 12/02
S COUPE 1.5 i	G4DJ	02/90 ⇒ 05/96
SONATA II 2.4 i	G4CS	09/88 ⇒ 08/91
SONATA III 1.8 GLS	G4DM	07/96 ⇒ 05/98
SONATA III 1.8 i	G4CM	05/93 ⇒ 06/98
SONATA III 2.0 i	G4CP, G4EP	06/94 ⇒ 06/98

MITSUBISHI

COLT III 1.5 GLXi	4G15(8V)	04/88 ⇒ 05/92
LANCER V 1.5	4G15(12V)	09/88 ⇒ 08/90
LANCER V 1.5 12V	4G15(12V)	05/89 ⇒ 05/92
LANCER V 1.5 GLS	4G15(12V)	08/89 ⇒ 08/92
LANCER V 1.8 4WD	4G37	09/89 ⇒ 06/92
GALANT IV 1.6 GLX	4G32	09/80 ⇒ 05/84
GALANT VI 2.0	4G63(SOHC8V)	11/87 ⇒ 12/92
GALANT VI 2.0 4WD	4G63(SOHC8V)	12/88 ⇒ 10/92
L200 II 2.4	4G64(12V)	06/90 ⇒ 10/96
L200 II 2.4 4WD	4G64(12V)	06/94 ⇒ 10/96
MONTERO 2.4 16V	4G64(12V)	04/91 ⇒
PAJERO II 2.4	4G64(12V)	04/91 ⇒ 04/00
PAJERO III 2.4	4G64(12V)	10/01 ⇒ 08/06
PAJERO III 2.4 4x4	4G64(12V)	10/01 ⇒ 12/06
PAJERO SPORT II 2.4	4G64(16V)	07/08 ⇒
PRECIS 1.5 i [USA]	G4DJ	01/89 ⇒ 12/94
TRUCK 2.4i [USA]	4G64	01/89 ⇒

MITSUBISHI

VALLEY 2.4 i 4G64 09/92 ⇒ 10/94

EPS 1.431.108



ROTORS

Adatt./Suitable: **MITSUBISHI**

BOSCH

1 987 234 056
F 005 X04 731

FORD

4 046 843
E8BZ-12200-A
FOJY-12200-A
KK 150 18 V05
XM34-12200-BA

GENERAL MOTORS

96 056 629

HOLDEN

3331086240

KIA

KK150-18V05
KK150-18-V05A

MAZDA

B303-18-V05
F829-18-V05
FE25-18-V05
G601-18-V05

MITSUBISHI

T16871

Motorcraft

DRE 383
DRE 388

SUZUKI

33310-82032
33310-82032-000
33310-86240
33310-86240-000

FORD

RANGER IV 2.2	--	10/99 ⇒
---------------	----	---------

FORD AUSTRALIA

FESTIVA 1.3	--	01/91 ⇒
SPECTRON 2.0	OHC	01/84 ⇒

HOLDEN

BARINA 1.3 GL	410UF015G02	02/89 ⇒ 05/94
---------------	-------------	---------------

KIA

PRIDE 1.1 i	B1	01/91 ⇒ 10/00
PRIDE 1.3 [GBR]	--	01/90 ⇒
PRIDE 1.3 i	--	01/90 ⇒ 05/97

MAZDA

121 I 1.1	B1, B115, B116	10/87 ⇒ 01/91
121 I 1.3	B3	10/87 ⇒ 06/91
323 III 1.5	B505, B535, B536	09/89 ⇒ 09/93
323 IV 1.3	E3	09/81 ⇒ 10/85
323 V 1.3	B333, E3, E391, E393	08/85 ⇒ 05/89
323 V 1.3 i	B335	09/85 ⇒ 08/89
323 V 1.5	B5, B50, B53, E5	08/85 ⇒ 10/89
323 V 1.6	93AF1006, B6E	09/86 ⇒ 10/95
323 V 1.6 4x4	B65M, B6E	05/90 ⇒ 03/93
323 V 1.6 GT	93AF1006	01/86 ⇒ 10/89
323 V 1.6i 16v Formula 4	B6F2	08/87 ⇒ 05/89
626 IV 1.8	F8(12V)	09/87 ⇒ 05/92
626 IV 2.0	FE(12V)	09/87 ⇒ 10/90
626 IV 2.0 12V	FE(12V), FEEF, FEEK	09/87 ⇒ 05/92
626 IV 2.2 12V	F2	11/87 ⇒ 04/92
626 IV 2.2 12V 4WD	F2	11/87 ⇒ 07/90
929 III 2.0	FE(8V), FEFA	06/87 ⇒ 05/89
929 III 2.2	--	01/86 ⇒ 12/91
929 III 2.2 12V	F2, F21, F267, F2E	02/87 ⇒ 05/89
929 III 2.2 i	F2-EGI	05/87 ⇒ 12/88
929 III 2.2i 12v	F2E6, F2E7	06/89 ⇒ 09/92
E2000 2.0	FEBN, FECK, FEY7	11/87 ⇒ 05/95
E2000 2.0 4x4	FECK, FEY7	11/87 ⇒ 07/91
E2000 4WD	FEBN	10/88 ⇒ 09/89
MPV I [USA] 2.6 12V	--	01/89 ⇒ 12/94
MPV I [USA] 2.6 12V AWD	--	01/89 ⇒ 12/94

SUZUKI

SWIFT I / II / III 1.3 GTi SOHC	G13B	10/89 ⇒ 12/95
SWIFT I / II / III 1.6	G16B	11/89 ⇒ 12/91
SWIFT I / II / III 1.6 4WD	G16B	11/89 ⇒ 12/91

EPS **1.431.109** 

ROTORS

Adatt./Suitable: **MITSUBISHI****BOSCH**

F 005 X04 737

CHRYSLERMD611 459
MD611 757**HYUNDAI**27115-35000
27131-35010**MITSUBISHI**MD611459
MD611757
T15672
T15673**NISSAN**

22157-03P10

**CHRYSLER**

LE BARON 3.0 iV6	6G72	01/90 ⇨ 12/96
VOYAGER I 3.0 i [USA]	EFA	10/84 ⇨ 07/90
VOYAGER 3.0 i	300, 6G72	01/91 ⇨ 09/95
VOYAGER 3.3	EGA	10/89 ⇨ 09/90

HYUNDAI

GALLOPER 3.0 V6	G6AT	08/98 ⇨ 12/03
INNOVATION 3.0 V6	G6AT	05/00 ⇨
SONATA II 3.0 i V6 [USA]	G6AT	01/88 ⇨
SONATA III 3.0 i V6	G6AT	05/93 ⇨ 06/98

MITSUBISHI

PAJERO I 3.0 i 4WD	6G72(SOHC12V)	05/88 ⇨ 05/91
PAJERO I 3.0 V6	6G72(SOHC12V)	11/88 ⇨ 11/90
PAJERO II 3.0 V6	6G72(SOHC12V)	12/90 ⇨ 12/95
PAJERO II 3.0 V6 4WD	6G72(SOHC12V)	12/90 ⇨ 12/95

EPS **1.431.110** 

ROTORS

Adatt./Suitable: **MITSUBISHI****BOSCH**

1 987 234 038

MITSUBISHI

T17371

NISSAN22157-17B10
22157-27M15**NISSAN**

NX1600 1.6 [USA]	E16	01/87 ⇨ 12/90
PICK UP I 2.4 i [USA]	KA24E	01/89 ⇨
PICK UP I 2.4 i 12V	KA24E	04/92 ⇨ 02/98
PICK UP I 2.4 i 12V 4WD	KA24E	04/92 ⇨ 02/98
PULSAR NX 1.6 [USA]	E16	01/86 ⇨
SUNNY II 1.6 i	E16i	06/86 ⇨ 10/90
SUNNY II 1.6 i 12V	GA16i	06/86 ⇨ 06/91
SUNNY II 1.6 i 4x4	E16i	06/86 ⇨ 10/90
SUNNY III 1.4	GA14DS	10/90 ⇨ 06/95
SUNNY III 1.4 i	GA14DS	10/90 ⇨ 05/95

EPS **1.431.113** 

ROTORS

Adatt./Suitable: **MITSUBISHI****BOSCH**

1 987 234 033

MAZDA

F220-18-V05

Motorcraft

DRE 385

**MAZDA**

323 VI C 1.3	B3E	09/89 ⇨ 07/94
323 VI C 1.8 16V 4WD	BP	11/91 ⇨ 12/93
323 VI C 1.8 16V GT	BP(DOHC)	09/89 ⇨ 03/93
323 VI C 1.8 16V Turbo 4WD	BPTurbo	09/90 ⇨ 12/92

EPS **1.431.118** 

ROTORS

Adatt./Suitable: **MITSUBISHI****BOSCH**

1 987 234 060

NISSAN22157-1E410
22157-53F11**NISSAN**

240SX 2.4	KA24DE	04/93 ⇨ 09/94
SERENA 1.6	GA16DE	02/93 ⇨ 09/01
SERENA 2.0	SR20DE	11/92 ⇨ 09/01

EPS **1.431.119** 

ROTORS

Adatt./Suitable: **MITSUBISHI****BOSCH**1 987 234 060
1 987 234 062
F 005 X04 739**HOLDEN**

3331070B50

MAZDA

B61V-18-V05

MITSUBISHIMD618284
T880T21572**Motorcraft**

ADR 5052

NISSAN

22157-55K10

SUBARU

22157-KA060

SUZUKI33310-70B50
33310-70B50-000**FORD AUSTRALIA**

LASER 1.6	B6(SOHC16V)	03/90 ⇨ 09/91
-----------	-------------	---------------

HOLDEN

BARINA 1.3 GL	410UF015G02	02/89 ⇨ 05/94
---------------	-------------	---------------

MAZDA

121 I 1.1	B115, B116	10/87 ⇨ 01/91
121 I 1.1 Unleaded Fuel	--	01/87 ⇨ 12/91
121 I 1.3	B3	10/87 ⇨ 06/91
121 I 1.3 Leaded Fuel	--	01/87 ⇨ 12/91
121 II 1.1	B1	11/90 ⇨ 10/93
323 III 1.5	B505, B535, B536	09/89 ⇨ 09/93
323 VI C 1.6	B6E	09/89 ⇨ 06/91
323 VI F 1.6	B6E	09/89 ⇨ 06/91
323 VI S 1.3	B383, B3E	09/89 ⇨ 06/91
323 VI S 1.3 16V	B3(16V)	04/91 ⇨ 07/94
323 VI S 1.6	B6E	09/89 ⇨ 06/91
323 VI S 1.6 16V	B6	08/89 ⇨ 10/96
323 VI 1.3 16V	B384, B386, B387	06/89 ⇨ 03/91

MITSUBISHI

COLT III 1.3 12V	4G13(12V)	04/88 ⇨ 05/92
COLT III 1.3 GL	4G13(8V)	04/88 ⇨ 12/90
COLT V 1.5	301353C	09/95 ⇨ 09/03
COLT V 1.5 16V	301353C	10/99 ⇨ 09/03
LANCER V 1.3	4G13(8V), G13B	04/88 ⇨ 05/92
LANCER V 1.3 12V	4G13(12V)	07/90 ⇨ 07/93
LANCER V 1.5	4G15(12V), 4G15(8V)	04/88 ⇨ 05/92
L400 2.0	4G63(SOHC16V)	12/94 ⇨ 10/02
LANCER VI 1.5	4G15(12V)	09/92 ⇨ 07/96
LANCER VII 1.5	301353C	06/00 ⇨ 08/03
LANCER VII 1.5 16V	301353C	10/99 ⇨ 08/03
SPACE GEAR 2.0 16V	4G63(DOHC16V)	08/96 ⇨ 05/00

SUBARU

LEGACY I 1.6	--	01/89 ⇨
LEGACY I 1.8	--	01/89 ⇨
M80 800	--	01/90 ⇨

EPS **1.431.131** 

ROTORS

Adatt./Suitable: **MITSUBISHI****BOSCH**

1 987 234 060

CHEVROLET

93740921

DAEWOO93740921
TD200C01001**FORD**E32Z-12200-B
F32Z-12200-B
F52Z-12200-B**GENERAL MOTORS**96 064 787
96 067 826**MAZDA**FS07-18-V05
FS07-18-V05A**MITSUBISHI**MD618187
MD619272**Motorcraft**DRE 390
DRE 390 A**NISSAN**

22157-50Y10

SUZUKI33310-56B10
33310-56B10-000
33310-60C30
33310-60C30-000
33310-60C31
33310-60C31-000**CHEVROLET**

SPARK I 0.8	F8CV	09/00 ⇨ 12/06
-------------	------	---------------

DAEWOO

MATIZ 0.8	F8CV	08/98 ⇨
-----------	------	---------

MITSUBISHI

L200 IV 2.4 i	4G64(16V)	11/05 ⇨ 12/15
EXPO 2.4 i [USA]	4G64	01/91 ⇨ 12/92
GALANT VI 2.0	4G63(SOHC8V)	11/87 ⇨ 12/92
GALANT VI 2.0 4WD	4G63(SOHC8V)	12/88 ⇨ 10/92
L200 III 2.0	4G63(SOHC16V)	06/96 ⇨ 12/07
L200 III 2.4 4WD	4G64(16V)	06/96 ⇨ 12/07
L400 2.0	4G63(SOHC16V)	12/94 ⇨ 10/02
L400 2.4	4G64(16V)	05/95 ⇨ 02/06
L400 2.4 i 4WD	4G64(16V)	05/95 ⇨ 05/00

MITSUBISHI		
LANCER V 1.8 4WD	4G37	03/89 ⇒ 06/92
LANCER V 1.8 GTi	4G37	06/92 ⇒ 07/93
LANCER VI 1.8 GTi	4G37	06/92 ⇒ 07/93
SPACE GEAR 2.0 16V	4G63(DOHC16V)	08/96 ⇒ 05/00
SPACE GEAR 2.4 i	4G64(16V)	05/95 ⇒ 05/00
NISSAN		
SUNNY III 1.4	GA14DS	10/90 ⇒ 06/95
SUNNY III 1.4 i	GA14DS	10/90 ⇒ 05/95
SUNNY III 1.6 i	GA16DE, GA16DS	10/90 ⇒ 03/00
SUZUKI		
SIDEKICK 1.6i [USA]	--	01/91 ⇒
SIDEKICK 1.6i 16V J1X 4x4	G16B	04/89 ⇒ 04/96
VITARA I 1.6 8V	--	01/90 ⇒ 12/98

EPS 1.431.132



ROTORS

Adatt./Suitable: **MITSUBISHI****BOSCH**1 987 234 061
F 005 X12 697**FORD**3 993 623
F4BZ-12200-A
F52Z-12200-D**KIA**MB593-18V05
MB6BF-18V05**MAZDA**B593-18-V05
B6BF-18-V05**Motorcraft**

DRE 394



FORD		
PROBE 2.0 16V	A20LE-FS	01/93 ⇒ 09/97
FORD AUSTRALIA		
LASER 1.6 i	B6(DOHC16V)	10/94 ⇒ 03/99
LASER 1.8 i	BP(DOHC)	10/94 ⇒ 03/99
MAZDA		
323 VII C 1.3 16V	B3(16V)	08/94 ⇒ 09/98
323 VII C 1.5 16V	Z5-DE	08/94 ⇒ 09/98
323 VII C 1.8 16V	BP-ZE	08/94 ⇒ 09/98
323 VII 1.5 16V	Z5-DE	07/94 ⇒ 09/98
323 VII 1.8 16V	BP-ZE	08/94 ⇒ 09/98
323 VII P 1.3 16V	B3(16V)	10/96 ⇒ 09/98
323 VII P 1.5 16V	Z5-DE	10/96 ⇒ 09/98
323 VIII F 1.4	B3(16V)	01/01 ⇒ 05/04
323 VIII F 1.4 16V	B3ME	09/98 ⇒ 01/01
323 VIII S 1.3	B3(16V)	01/01 ⇒ 05/04
323 VIII S 1.3 16V	B3(16V)	08/94 ⇒ 01/01
323 VIII S 1.5 16V	Z5-DE	08/94 ⇒ 09/98
323 VIII S 1.8 16V	BP-ZE	08/94 ⇒ 09/98
626 V 1.8	FP, FP01LP	08/91 ⇒ 04/97
626 V 1.8 i	--, FP	08/91 ⇒ 06/97
626 V 2.0 i	FS	08/91 ⇒ 04/97
626 V 2.0 i 4WD	FS	04/92 ⇒ 04/97
DEMIO 1.3 16V	B3ME	08/98 ⇒ 07/03
DEMIO 1.5 16V	BSE	04/00 ⇒ 07/03
MX-3 1.6 i	B6D	11/93 ⇒ 09/98
MX-6 2.0	FS	02/92 ⇒ 02/97

EPS 1.431.133



ROTORS

Adatt./Suitable: **MITSUBISHI****BOSCH**F 005 X04 747
F 005 X12 881**FORD**3 395 566
3 880 181
F32Z-12200-C
KL01-18V05-A**FORD AUSTRALIA**

K L01-18-V05 A

FORD USA

3 880 181

MAZDAKL01-18-V05
KL01-18-V05A**Motorcraft**

DRE 391

03 Supplied until depletion

- Fornibile fino ad esaurimento delle scorte
- Fourni jusqu'à épuisement du stock
- Lieferbar solange vorrat reicht
- Suministrado hasta el stock termina

**FORD AUSTRALIA**

TELSTAR 2.5	KL-ZE	01/92 ⇒ 10/95
TELSTAR 2.5 TXS Efi	KL-ZE	10/94 ⇒ 11/96

FORD USA

PROBE II 2.5 V6 24V	KL	10/93 ⇒ 03/98
---------------------	----	---------------

MAZDA

626 V 2.5 24V	KL	01/92 ⇒ 04/97
626 V 2.5i V6 [USA]	--	01/94 ⇒
MX-3 1.8 i V6	K819	01/92 ⇒ 01/94
MX-6 2.5 24V	KL	02/92 ⇒ 09/97

EPS 1.431.134



ROTORS

Adatt./Suitable: **MITSUBISHI****BOSCH**F 005 X12 882
F 005 X12 883
F 005 X12 894**FORD**3 891 726
F52Z-12200-A
F52Z-12200-C**FORD USA**

3 891 726

MAZDAKF34-18-V05
KF34-18-V05A**MITSUBISHI**

MD619274

Motorcraft

DRE 395

**FORD AUSTRALIA**

TELSTAR 2.5	KL-ZE	01/92 ⇒ 10/95
TELSTAR 2.5 TXS Efi	KL-ZE	10/94 ⇒ 11/96

FORD USA

PROBE II 2.5 V6 24V	KL	10/93 ⇒ 03/98
---------------------	----	---------------

MAZDA

323 VII 2.0 24V	KF	08/94 ⇒ 09/98
626 V 2.5 24V	KL	08/94 ⇒ 04/97
MILLENIA 2.5i [USA]	--	05/99 ⇒
MPV I 3.0	JE94	09/88 ⇒ 12/91
MPV I 3.0 i V6	JE94	11/88 ⇒ 09/99
MX-3 1.8 i V6	K838, K8-ZE	01/94 ⇒ 10/97
MX-6 2.5 24V	KL	02/92 ⇒ 09/97
MX-6 2.5 i 24V	KL	08/94 ⇒ 02/97
XEDOS 9 2.0	KF	08/98 ⇒ 08/00
XEDOS 9 2.0 24V	KF	08/93 ⇒ 01/00
XEDOS 9 2.5 24V	KL	07/93 ⇒ 07/00
XEDOS 9 2.5 V6	KL	07/00 ⇒ 09/02

MITSUBISHI

GALANT VIII 2.5 V6 24V	6A13	09/00 ⇒ 10/04
------------------------	------	---------------

EPS 1.431.136



ROTORS

Adatt./Suitable: **MITSUBISHI****BOSCH**F 005 X12 629
F 00E 000 243
F 00E 140 440**GENERAL MOTORS**

91 172 825

INFINITI

22157-46N12

MITSUBISHIMD619000
MD619216
MD619354
MD619434
MD619637**NISSAN**22157-0M512
22157-0M810
22157-2J210
22157-46N11
22157-46N12**SUZUKI**33310-70E00
33310-70E00-000
33310-70E01
33310-70E01-000**INFINITI**

G20 2.0	SR20DE	01/90 ⇒ 12/97
---------	--------	---------------

MITSUBISHI

CARISMA 1.6	4G92(SOHC16V)	07/95 ⇒ 06/06
CARISMA 1.8	4G93(SOHC16V)	07/95 ⇒ 07/97
COLT IV 1.6 4WD	4G92(SOHC16V)	08/93 ⇒ 08/95
COLT IV 1.6 GLXi 16V	4G92(SOHC16V)	04/92 ⇒ 04/96
COLT V 1300 GL, GLX	4G13(12V)	05/96 ⇒ 06/00
LANCER VI 1.6 16V	4G92(SOHC16V)	06/92 ⇒ 10/03
LANCER VI 1.6 16V 4WD	4G92(SOHC16V)	06/92 ⇒ 10/03
LANCER VII 1.3 12V	4G13(12V)	12/95 ⇒ 08/03
SPACE RUNNER 1.8	4G93(SOHC16V)	10/91 ⇒ 08/99
SPACE RUNNER 1.8 4WD	4G93(SOHC16V)	10/91 ⇒ 08/99
SPACE STAR 1.3 16V	4G13(16V)	09/00 ⇒ 12/04

NISSAN

240SX 2.4	KA24DE	05/94 ⇒ 08/97
ALMERA I 2.0 GTi	SR20DE	07/96 ⇒ 03/00
ALMERA TINO 2.0	SR20DE	08/00 ⇒ 01/03
PRIMERA II 2.0	SR20DEL	10/97 ⇒ 06/99
PRIMERA II 2.0 16V	SR20DE	06/96 ⇒ 07/02
PRIMERA II 2.0 GT	SR20DEH	10/97 ⇒ 06/99
PRIMERA I 2.0	SR20DE	07/94 ⇒ 01/98

SUZUKI

SIDEKICK 1.6 JS [USA]	--	05/96 ⇒ 07/98
SIDEKICK 1.6 JX 4x4 [USA]	--	05/96 ⇒ 07/98
X-90 1.6 i 16V	G16B	09/95 ⇒ 12/97
X-90 1.6 i 16V 4x4	G16B	09/95 ⇒ 12/97

1.431.137

EPS 1.431.137



1

ROTORS

Adatt./Suitable: **MITSUBISHI**

BOSCH

1 987 234 055

⁰³ Supplied until depletion

- Fornibile fino ad esaurimento delle scorte
- Fourni jusqu'à épuisement du stock
- Lieferbar solange vorrat reicht
- Suministrado hasta el stock termina

FORD

3 857 542
F32Z-12200-A
F42Z-12200-A
FS01-18V05-A

MAZDA

FS01-18-V05
FS01-18-V05A

MITSUBISHI

MD618556
MD619273

Motorcraft

DRE 389
DRE 389 A



FORD

PROBE 2.0 16V	A20LE-FS	01/93 ⇒ 09/97
---------------	----------	---------------

MAZDA

626 V 1.8	FP, FP01LP	08/91 ⇒ 04/97
-----------	------------	---------------

626 V 1.8 i	--, FP	08/91 ⇒ 06/97
-------------	--------	---------------

626 V 2.0 i	FS	08/91 ⇒ 04/97
-------------	----	---------------

626 V 2.0 i 4WD	FS	04/92 ⇒ 04/97
-----------------	----	---------------

MITSUBISHI

COLT IV 1.6 4WD	4G92(SOHC16V)	08/93 ⇒ 08/95
-----------------	---------------	---------------

COLT IV 1.6 GLXi 16V	4G92(SOHC16V)	04/92 ⇒ 04/96
----------------------	---------------	---------------

EXPOLRV 2.4i [USA]	4G64	01/92 ⇒
--------------------	------	---------

GALANT VII 1.8 GLSi	4G93(SOHC16V)	11/92 ⇒ 08/96
---------------------	---------------	---------------

GALANT VII 2.0 GLSi	4G63(SOHC16V)	11/92 ⇒ 08/96
---------------------	---------------	---------------

GALANT VII 2.0 GLSi 4WD	4G63(SOHC16V)	11/92 ⇒ 08/96
-------------------------	---------------	---------------

LANCER V 1.6 16V	4G92(SOHC16V)	06/92 ⇒ 05/94
------------------	---------------	---------------

LANCER V 1.6 4WD	4G92(SOHC16V)	06/92 ⇒ 11/93
------------------	---------------	---------------

LANCER VI 1.6 16V	4G92(SOHC16V)	06/92 ⇒ 10/03
-------------------	---------------	---------------

LANCER VI 1.6 16V 4WD	4G92(SOHC16V)	06/92 ⇒ 10/03
-----------------------	---------------	---------------

SPACE RUNNER 1.8	4G93(SOHC16V)	10/91 ⇒ 08/99
------------------	---------------	---------------

SPACE RUNNER 1.8 4WD	4G93(SOHC16V)	10/91 ⇒ 08/99
----------------------	---------------	---------------

SPACE WAGON 1.8	4G93(SOHC16V)	10/91 ⇒ 10/98
-----------------	---------------	---------------

SPACE WAGON 1.8 4WD	4G93(SOHC16V)	10/91 ⇒ 10/98
---------------------	---------------	---------------

SPACE WAGON 2.0	4G63(SOHC16V)	10/92 ⇒ 10/98
-----------------	---------------	---------------

SPACE WAGON 2.0 4WD	4G63(SOHC16V)	10/92 ⇒ 10/98
---------------------	---------------	---------------

EPS 1.431.138



3

ROTORS

Adatt./Suitable: **MITSUBISHI**

HYUNDAI

27131-02750



HYUNDAI

ATOS 1.0 i	G4HC	02/98 ⇒ 03/02
------------	------	---------------

ATOS PRIME 1.0 i	G4HC	08/99 ⇒
------------------	------	---------

EPS 1.431.139



3

ROTORS

Adatt./Suitable: **DAC**

CHEVROLET

93740944

DAEWOO

329013
93740944

GENERAL MOTORS

93 740 944



CHEVROLET

SPARK 1.0.8	F8CV	09/00 ⇒ 12/06
-------------	------	---------------

DAEWOO

MATIZ 0.8	F8CV	08/98 ⇒
-----------	------	---------

EPS 1.438.262R



1

ROTORS

Adatt./Suitable: **PAL**

SKODA

113 911 400

²¹² Resistance Rotor [Ohm] 5000

- Rotore resistenza [Ohm] 5000
- Résistance rotateur [ohm] 5000
- Widerstand-Rotor [Ohm] 5000
- Resistencia rotor [ohm] 5000



SKODA

105,120 1.0	33*	08/76 ⇒ 12/89
-------------	-----	---------------

105,120 1.0 105 S, L	742.10	08/76 ⇒ 12/90
----------------------	--------	---------------

105,120 1.0 105 S, L, GL	742.10	08/76 ⇒ 08/83
--------------------------	--------	---------------

105,120 1.0 105 S, L, LS	742.10	10/83 ⇒ 12/90
--------------------------	--------	---------------

105,120 1.2	37*, 55*	08/76 ⇒ 12/89
-------------	----------	---------------

105,120 1.2 120 GLS	742.12X	02/83 ⇒ 12/90
---------------------	---------	---------------

105,120 1.2 120 L	742.12, 742.12X	08/76 ⇒ 12/90
-------------------	-----------------	---------------

105,120 1.2 120 LS	742.12X	08/76 ⇒ 12/90
--------------------	---------	---------------

130 1.3	43*	01/84 ⇒ 12/88
---------	-----	---------------

135 1.3	43*	01/87 ⇒ 12/89
---------	-----	---------------

136 1.3	46*	01/87 ⇒ 12/89
---------	-----	---------------

FAVORIT 1.3	781.135, OHC	08/91 ⇒ 06/97
-------------	--------------	---------------

FAVORIT 1.3 135	781.135	10/90 ⇒ 09/94
-----------------	---------	---------------

FAVORIT 1.3 135L	781.135	05/89 ⇒ 09/94
------------------	---------	---------------

FAVORIT 1.3 136	136L	10/90 ⇒ 09/94
-----------------	------	---------------

FELICIA 1.3	061GW4G15K, 135, 135L, 136L	10/94 ⇒ 03/98
-------------	-----------------------------	---------------

EPS 1.438.263R



1

ROTORS

Adatt./Suitable: **PAL**

SKODA

114 911 070
115 911 401

²¹² Resistance Rotor [Ohm] 1000

- Rotore resistenza [Ohm] 1000
- Résistance rotateur [ohm] 1000
- Widerstand-Rotor [Ohm] 1000
- Resistencia rotor [ohm] 1000



SKODA

FAVORIT 1.3	135B, 136B, 781.135, 781.135E, OHC	08/91 ⇒ 06/97
-------------	------------------------------------	---------------

FAVORIT 1.3 135	781.135	10/90 ⇒ 09/94
-----------------	---------	---------------

FAVORIT 1.3 135 X, LX, GLX	781.135E	01/90 ⇒ 09/94
----------------------------	----------	---------------

FAVORIT 1.3 135L	781.135	05/89 ⇒ 09/94
------------------	---------	---------------

FAVORIT 1.3 136	136L	10/90 ⇒ 09/94
-----------------	------	---------------

EPS 1.446.014R



3,5

ROTORS

Adatt./Suitable: **U.D.S.S.R.**

LADA

21010-3706020-10
21013-7060010-10 *C
2101-3706020
2101-3706020-10
2107-3706020-10
3037-06020
38-37060-20

^{*C} Available rotor only-not, the distributor assy

- Fornito solo distributore rotante, non lo spinterogeno completo
- Disponible seulement le rotor, non pas l'allumeur complet
- Erhältlich nur rotor, nicht der komplette verteiler
- Disponible solo el rotor, no el distribuidor completo

²¹² Resistance Rotor [Ohm] 5000

- Rotore resistenza [Ohm] 5000
- Résistance rotateur [ohm] 5000
- Widerstand-Rotor [Ohm] 5000
- Resistencia rotor [ohm] 5000



LADA

LADA 1.2	--	01/80 ⇒
----------	----	---------

LADA 1.3	--	01/80 ⇒
----------	----	---------

LADA 1.5	--	01/80 ⇒
----------	----	---------

NIVA I 1600	BA32121, BA32121	12/76 ⇒ 12/93
-------------	------------------	---------------

RIVA 1.5	--	01/85 ⇒
----------	----	---------

RIVA 1.6	--	01/85 ⇒
----------	----	---------



ROTORS

Adatt./Suitable: U.D.S.S.R.

LADA

2108-3706020

⁰³ Supplied until depletion

- Fornibile fino ad esaurimento delle scorte
- Fourni jusqu'à épuisement du stock
- Lieferbar solange vorrat reicht
- Suministrado hasta el stock termina

²¹² Resistance Rotor [Ohm] 1000

- Rotore resistenza [Ohm] 1000
- Résistance rotor [ohm] 1000
- Widerstand-Rotor [Ohm] 1000
- Resistencia rotor [ohm] 1000

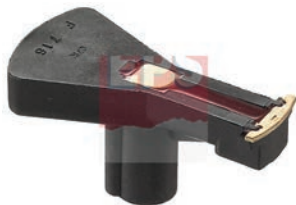

LADA

SAMARA 1.5	--	01/97 ⇨
SAMARA 1100	BA321081	02/88 ⇨ 12/94
SAMARA 1300	BA32108	01/86 ⇨ 12/94
SAMARA 1500	BA321083	09/87 ⇨ 12/96



IGNITION CABLE SETS

-SERIE CAVI ACCENSIONE COMPLETA -JEUX CABLES D'ALLUMAGE -ZÜNDKABELSÄTZE -JUEGOS DE CABLES DE ENCENDIDO

(A) P/NRS. - NOTES

- CODICI - NOTE
- RÉFS. - NOTES
- ARTIKEL-NR. - ANMERKUNGEN
- CODIGOS - NOTAS

1.501.904 07,5

IGNITION CABLE SETS

Adatt./Suitable:

GENERAL MOTORS ¹⁸⁰with marten protection

- con protezione contro roditori
- avec protection anti-mustélidés
- mit Marderschut
- con protección contra martas

OPEL

09 117 892
09 117 893
09 117 894
09 117 895
93 176 701

12 82 163
12 82 164
12 82 165
12 82 166
16 12 657

(A)

EPS

OEM P/NRS.

- Codici originali
- Réfs. d'origine
- Originalteile-Nr.
- Codigos originales

PACKAGING SIZE

- Formato confezione
- Format du conditionnement
- Abpackensgroesse
- Tamaño del envase

PRODUCT AVAILABILITY DATE

- Data di disponibilità del prodotto
- DATE Disponibilité du produit
- Produktverfügbarkeitsdatum
- FECHA Disponibilidad artículo

NOTE

- Note
- Notes
- Bemerkungen
- Notas

(B) PICTURE + TECHNICAL INFO

- FOTO + INFORMAZIONE TECNICA
- ILLUSTRATION + INFORMATION TECHNIQUE
- BILD + TECHNISCHE INFO
- FOTO + INFORMACIÓN TÉCNICA

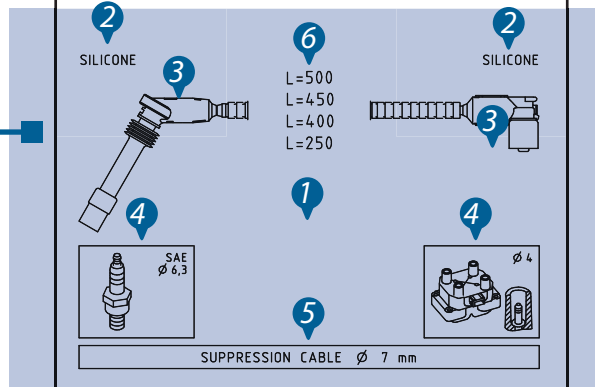

(C) APPLICATION LIST

- GUIDA APPLICAZIONI
- LISTE D'APPLICATIONS
- ANWENDUNGSTABELLE
- LISTA DE APLICACIONES

OPEL		
ASTRA G 1.6	X16SZR, Z16SE	09/00 ⇒ 04/05
COMBO B 1.4	C14SE, X14SZ	07/94 ⇒ 10/01
COMBO C 1.6	Z16SE	10/01 ⇒
CORSA B 1.4	C14SE	04/93 ⇒ 08/94
CORSA B 1.4 i	X14SZ	03/93 ⇒ 09/00
CORSA B 1.4 Si	C14SE	03/93 ⇒ 09/00

(B)

1

PICTURE

- Foto - Photo - Bild - Foto

2

MATERIAL OF BOOTS

- Materiale dei gommini
- Matériel des capuchons
- Material der steckerüllen
- Material de los capuchones

3

SUPPRESSOR

- Soppressore antidisturbo
- Suppresseur anti-parasite
- Entstörstecker
- Supresor antiparasito

4

CONNECTOR, SEE PAGE

- Innesto, VEDERE PAGINA
- Connexion, VOIR PAGE
- Anschluss, SIEHE SEITE
- Anchufe, VÉASE PAGINA

5

DIAMETER AND TYPE OF WIRE

- Diametro e tipo di cavo
- Diamètre et type de cable
- Durchmesser und Kabeltyp
- Diametro y tipo de cable

6

LENGTH IN mm OF SINGLE CABLE MEASURED

AS SHOWN:

- Lunghezza in mm del singolo cavo così misurato:
- Longueur en mm de chaque cable mesuré comme suit:
- Einzelkabelänge in mm gemessen wie gezeigt:
- Largo en mm de cada cable MEDIDO COMO SIGUE:

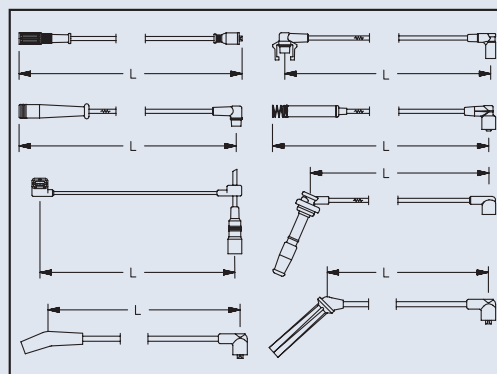



IGNITION CABLE SETS

-SERIE CAVI ACCENSIONE COMPLETA -JEUX CABLES D'ALLUMAGE -ZÜNDKABELSÄTZE -JUEGOS DE CABLES DE ENCENDIDO

ICON: CONNECTOR TYPES ON SPARK PLUGS - CAPS - COILS

- **ICONE:** INNESTI SU CANDELE - CALOTTE - BOBINE
- **ICONE:** CONNEXIONS SUR BOUGIES - TETES - BOBINES
- **BESTIMMUNG** DER STECKANSCHLÜSSE AUF ZÜNDKERZEN - VERTEILERKAPPEN - SPULEN
- **ICONAS:** ENCHUFES EN BUJIAS - TAPAS - BOBINAS

(B)

4

SPARK PLUG

- CANDELA
- BOUGIE
- KÜNDKERZE
- BUJIA

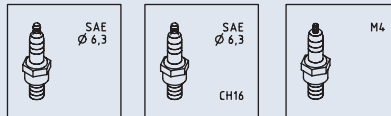

DISTRIBUTOR CAP

- CALOTTA
- TETE D'ALLUMEUR
- VERTEILERKAPPE
- TAPA DEL DISTRIBUIDOR

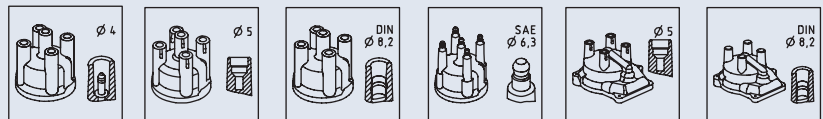

IGNITION COIL

- BOBINA
- BOBINE D'ALLUMAGE
- ZÜNDSPULE
- BOBINA DE ENCENDIDO

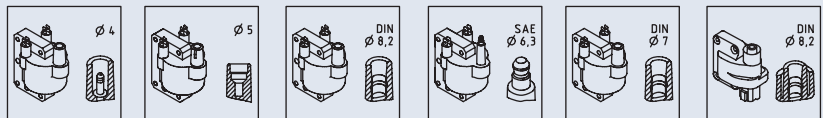

COIL FOR DISTRIBUTORLESS IGNITION

- BOBINA PER ACCENSIONE SENZA SPINTEROGENO
- BOBINE PUR ALLUMAGE SANS DISTRIBUTEUR
- SPULE FÜR VERTEILERLOSE ZÜNDSYSTEME
- BOBINA PARA ENCENDIDO SIN DISTRIBUIDOR

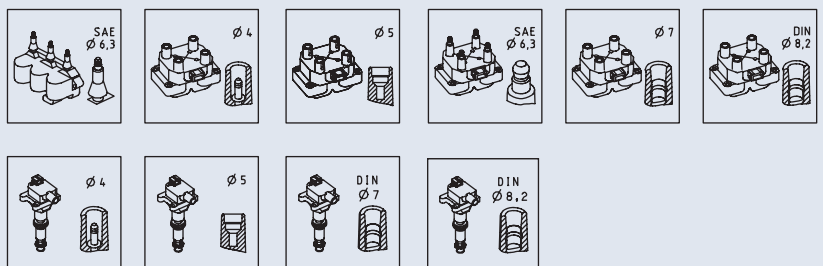

1.499.004

EPS 1.499.004

07,5

IGNITION CABLE SETS

Adatt./Suitable:

03 Supplied until depletion

- Fornibile fino ad esaurimento delle scorte
- Fourni jusqu'à épuisement du stock
- Lieferbar solange vorrat reicht
- Suministrado hasta el stock termina

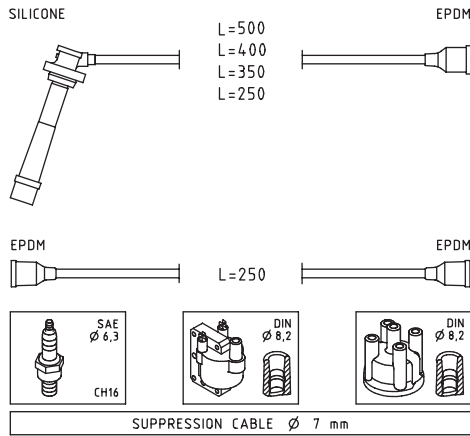

SUZUKI

SIDEKICK 1.6 JX 4x4	G16A(8V)	04/89 ⇒ 04/96
VITARA I 1.6	G16A(8V), G16B	07/88 ⇒ 03/98
VITARA I 1.6 i 16V	G16B	07/90 ⇒ 03/99
VITARA I 1.6 i 16V Trazione integrale	G16B	07/90 ⇒ 03/98
VITARA I 1.6 Trazione integrale	G16A(8V)	07/88 ⇒ 03/98

EPS 1.499.005

05

IGNITION CABLE SETS

Adatt./Suitable:

BOSCH
0 986 357 263HITACHI
134987

SUZUKI

33705-66D00
33705-66D00-000
33705M79F00
33705M79F00-000

00 Eliminated on 09-03-2022. Please verify the availability through our local distributors

- Eliminato il 09-03-2022. Verificare la disponibilità presso i nostri distributori
- Eliminé le 09-03-2022. Verifier la disponibilité auprès de nos distributeurs sur place
- Am 09-03-2022 gestrichen. Evtl. Verfügbarkeit bitte bei unseren Händlern prüfen
- Eliminado en fecha 09-03-2022. Verificar la disponibilidad a través de nuestros distribuidores locales

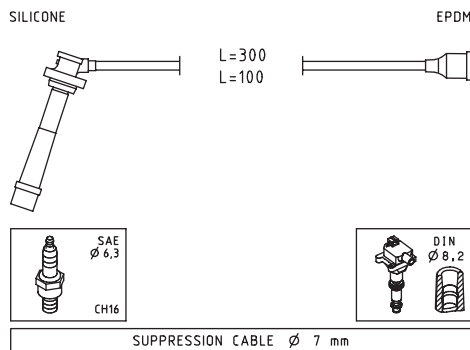

SUZUKI

ALTO VI 1.1	6AR02150, F10DN	09/04 ⇒ 12/08
BALENO 1.3 16V	G13BB	03/97 ⇒ 05/02
BALENO 1.3 i 16V	G13BB	07/95 ⇒ 05/02
BALENO 1.6 i 16V	G16B	07/95 ⇒ 05/02
BALENO 1.6 i 16V 4x4	G16B	07/95 ⇒ 05/02
CARRY 1.3	G13BB	03/99 ⇒
CARRY 1.3 16V	G13BB	03/00 ⇒
ESTEEM 1.6i [USA]	G16B	09/98 ⇒
GRAND VITARA I 1.6 4x4	G16B	02/00 ⇒ 09/02
JIMNY III 1.3 16V	G13BB	09/98 ⇒
JIMNY III 1.3 16V 4WD	G13BB	09/98 ⇒

SUZUKI

JIMNY III 1.3 4x4	G13BB	09/98 ⇒ 08/00
SWIFT III 1.3 [USA]	--	06/95 ⇒ 05/01
VITARA I 1.6 16V	G16B	10/99 ⇒ 10/02
VITARA II 1.6i [USA]	--	08/99 ⇒ 12/06
WAGON R+ II 1.3	G13BB, M13A	05/00 ⇒
WAGON R+ II 1.3 4WD	G13BB	10/01 ⇒

EPS 1.499.006

07

IGNITION CABLE SETS

Adatt./Suitable:

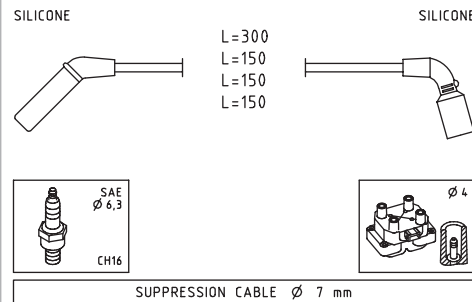
BOSCH
0 986 357 285CHEVROLET
96288956DAEWOO
96288956GENERAL MOTORS
96 288 956HITACHI
134260HITACHI
134260

CHEVROLET

AVEO I 1.2	B1251, F1253, LQ5, LY4	03/05 ⇒
KALOS 1.2	B1251	03/05 ⇒
MATIZ 1.0	B10S, B10S1, LQ4(61CUL4)	03/05 ⇒
MATIZ 1.0 LPG	B10S1	03/05 ⇒ 03/11
SPARK I 1.0	G10CV	11/02 ⇒ 12/04
SPARK II 1.0 LPG	B10S	05/05 ⇒
SPARK II 1.0 SX	B10S, B10S1, LA2	05/05 ⇒

DAEWOO

KALOS 1.2	B1251, F1253	04/03 ⇒
MATIZ 1.0	B10S	01/03 ⇒

EPS 1.499.007

05

IGNITION CABLE SETS

Adatt./Suitable:

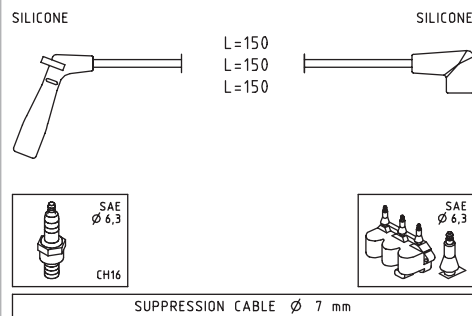
CHEVROLET
96291306DAEWOO
96291306GENERAL MOTORS
96 291 306HITACHI
134263HITACHI
134263

CHEVROLET

MATIZ 0.8	LB(49CUL3), LQ2(49CUL3)	03/05 ⇒ 12/13
MATIZ 0.8 LPG	F8CV	03/05 ⇒ 12/07
SPARK I 0.8	F8CV	09/00 ⇒ 12/06
SPARK II 0.8	F8CV	05/05 ⇒ 02/10

DAEWOO

MATIZ 0.8	F8CV	08/98 ⇒
-----------	------	---------

EPS 1.499.013

07

IGNITION CABLE SETS

Adatt./Suitable:

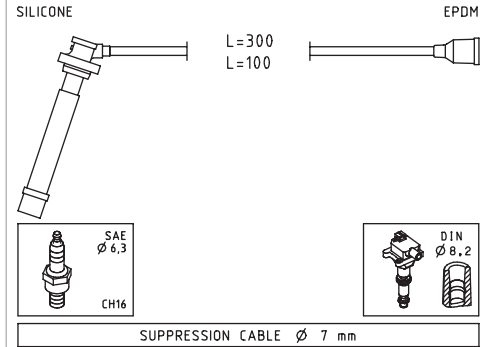
FIAT
71742423SUZUKI
33705-80G00-000
33705-86G00-000

FIAT

SEDCI 1.6 16V	M16A	06/06 ⇒ 10/14
SEDCI 1.6 16V 4x4	M16A	06/06 ⇒ 10/14

SUZUKI

GRAND VITARA II 1.6 4x4	M16A	09/05 ⇒ 02/15
GRAND VITARA II 1.6 Trazione integrale	M16A	04/05 ⇒ 02/15
SWIFT IV 1.3	M13A	02/05 ⇒
SWIFT IV 1.3 4x4	M13A	02/05 ⇒
SWIFT IV 1.5	M15A	02/05 ⇒
SWIFT IV 1.5 4x4	M15A	02/05 ⇒
SWIFT IV 1.6	M16A	05/06 ⇒
SWIFT IV 1.6 4x4	M16A	02/05 ⇒
IGNIS I 1.3	M13A	10/00 ⇒ 09/03
IGNIS I 1.3 4WD	M13A	10/00 ⇒ 09/03
IGNIS I 1.5 Sport	M15A	12/03 ⇒ 12/05
IGNIS II 1.3	M13A	09/03 ⇒
IGNIS II 1.3 4x4	M13A	09/03 ⇒
IGNIS II 1.5	M15A	09/03 ⇒
IGNIS II 1.5 4x4	M15A	09/03 ⇒
JIMNY III 1.3 16V	M13A	02/01 ⇒
JIMNY III 1.3 16V 4WD	M13A	02/01 ⇒
JIMNY III 1.3 16V 4x4	M13A	08/05 ⇒
JIMNY III 1.3 4WD	M13A	05/14 ⇒
LIANA 1.3	M13A	07/01 ⇒
LIANA 1.6	M16A	07/01 ⇒
LIANA 1.6 4WD	M16A	07/01 ⇒
LIANA 1.6 i	M16A	04/02 ⇒
LIANA 1.8 i	M18A	10/01 ⇒
SX4 I 1.5	M15A	06/06 ⇒ 07/10
SX4 I 1.5 VVT	M15A	07/10 ⇒
SX4 I 1.5 VVT 4x4	M15A	07/10 ⇒
SX4 I 1.6	M16A	06/06 ⇒
SX4 I 1.6 AWD	M16A	10/07 ⇒
SX4 I 1.6 VVT	M16A	06/06 ⇒
SX4 I 1.6 VVT 4x4	M16A	06/06 ⇒
WAGON R+ II 1.3	M13A	09/03 ⇒
WAGON R+ II 1.3 4WD	M13A	09/03 ⇒

EPS 1.499.020



IGNITION CABLE SETS

Adatt./Suitable:

- HOLDEN**
3370083010
- SUZUKI**
33700-80001
33700-80001-000
33700-80012
33700-80012-000
33700-82610
33700-82610-000
33700-83010
33700-83010-000
33705-80040
33705-80040-000
33710-80010
33710-80010-000

⁰³ Supplied until depletion

- Fornibile fino ad esaurimento delle scorte
- Fourni jusqu'à épuisement du stock
- Lieferbar solange vorrat reicht
- Suministrado hasta el stock termina

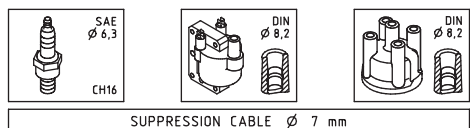
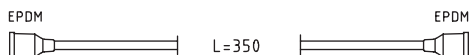
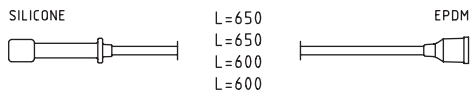

SUPPRESSION CABLE Ø 7 mm

HOLDEN		
DROVER QB 1.3	G13A	02/85 ⇒ 12/87
SUZUKI		
SA413 1.3	--	01/84 ⇒
SJ410 1.0	F10A	09/81 ⇒ 07/91
SJ413 1.3	G13A	09/84 ⇒ 08/90

EPS 1.499.028



IGNITION CABLE SETS

Adatt./Suitable:

⁰⁰ Eliminated on 22-02-2022. Please verify the availability through our local distributors

- Eliminato il 22-02-2022. Verificare la disponibilità presso i nostri distributori
- Éliminé le 22-02-2022. Vérifier la disponibilité auprès de nos distributeurs sur place
- Am 22-02-2022 gestrichen. Evtl. Verfügbarkeit bitte bei unseren Händlern prüfen
- Eliminado en fecha 22-02-2022. Verificar la disponibilidad a través de nuestros distribuidores locales

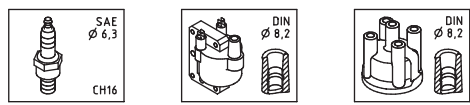
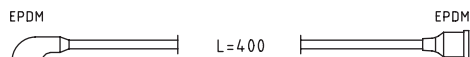
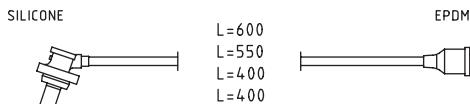

SUPPRESSION CABLE Ø 7 mm

SUZUKI		
WAGON R II 1.0	K10A	02/98 ⇒ 05/00
WAGON R II 1.2	K12A	02/98 ⇒ 05/00
WAGON R II 1.2 4WD	K12A	02/98 ⇒ 05/00

EPS 1.499.049



IGNITION CABLE SETS

Adatt./Suitable:

- RENAULT**
82 00 122 243

⁰³ Supplied until depletion

- Fornibile fino ad esaurimento delle scorte
- Fourni jusqu'à épuisement du stock
- Lieferbar solange vorrat reicht
- Suministrado hasta el stock termina

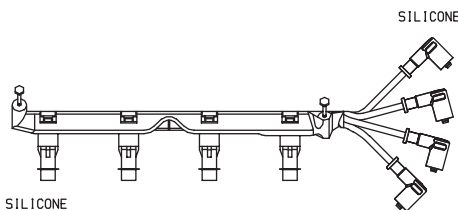

SUPPRESSION CABLE Ø 7 mm

RENAULT		
LAGUNA II 2.0 16V IDE	F5R700	04/01 ⇒ 09/07
MEGANE I 2.0 16V IDE	F5R740	11/99 ⇒ 08/03

EPS 1.499.059



IGNITION CABLE SETS

Adatt./Suitable:

- HITACHI**
134958
- MAGNETI MARELLI**
941215240807
- VOLVO**
1275603

⁰³ Supplied until depletion

- Fornibile fino ad esaurimento delle scorte
- Fourni jusqu'à épuisement du stock
- Lieferbar solange vorrat reicht
- Suministrado hasta el stock termina

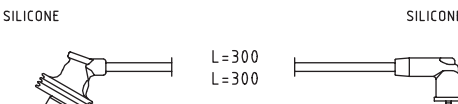

SUPPRESSION CABLE Ø 7 mm

VOLVO		
S40 I 1.6	B4164S2	03/99 ⇒ 12/03
S40 I 1.8	B4184S2, B4184S3, B4184S9	06/01 ⇒ 12/03
S40 I 1.8 16V	B4184S10	08/00 ⇒
S40 I 1.9T4	B4194T, B4194T2	05/97 ⇒ 07/00
S40 I 2.0	B4204S2	07/95 ⇒ 12/03
S40 I 2.0T	B4204T, B4204T2, B4204T3	06/01 ⇒ 12/03
S40 I 2.0T4	B4204T5	07/00 ⇒ 12/03
V40 I 1.6	B4164S2	03/99 ⇒ 06/04
V40 I 1.8	B4184S2, B4184S3, B4184S9	03/99 ⇒ 06/04
V40 I 1.8 16V	B4184S10	08/00 ⇒
V40 I 1.9T4	B4194T, B4194T2	05/97 ⇒ 07/00
V40 I 2.0	B4204S2	07/95 ⇒ 06/04
V40 I 2.0T	B4204T, B4204T2, B4204T3	06/01 ⇒ 06/04
V40 I 2.0T4	B4204T5	07/00 ⇒ 06/04

EPS 1.499.061



IGNITION CABLE SETS

Adatt./Suitable:

- BOSCH**
0 986 357 238
- HITACHI**
134560
- RENAULT**
74 31 275 284
- VOLVO**
1275284
12752846

⁰³ Supplied until depletion

- Fornibile fino ad esaurimento delle scorte
- Fourni jusqu'à épuisement du stock
- Lieferbar solange vorrat reicht
- Suministrado hasta el stock termina

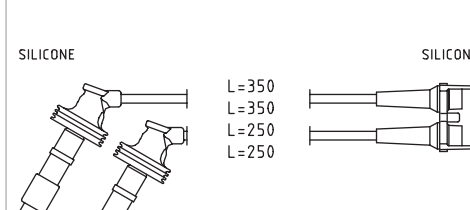

SUPPRESSION CABLE Ø 7 mm

RENAULT		
LAGUNA I 2.0	N7Q700, N7Q704	06/95 ⇒ 02/01
LAGUNA I 2.0 16V	N7Q700, N7Q704	06/95 ⇒ 03/01
SAFRANE II 2.0 16V	N7Q710, N7Q711	07/96 ⇒ 12/00

VOLVO		
S40 I 1.6	B4164S	09/95 ⇒ 08/99
S40 I 1.8	B4184S	07/95 ⇒ 08/99
S40 I 2.0	B4204S	07/95 ⇒ 08/99
V40 I 1.6	B4164S	12/95 ⇒ 08/99
V40 I 1.8	B4184S, B4184S3	07/95 ⇒ 08/99
V40 I 2.0	B4204S	07/95 ⇒ 08/99

EPS 1.499.064



IGNITION CABLE SETS

Adatt./Suitable:

⁰³ Supplied until depletion

- Fornibile fino ad esaurimento delle scorte
- Fourni jusqu'à épuisement du stock
- Lieferbar solange vorrat reicht
- Suministrado hasta el stock termina

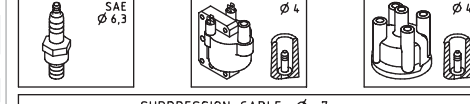
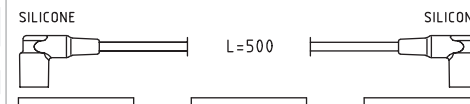
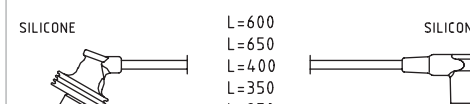

SUPPRESSION CABLE Ø 7 mm

RENAULT		
SAFRANE II 2.5 20V	N7U700, N7U701	07/96 ⇒ 12/00

VOLVO		
850 2.0	B5202S, B5204F, B5204FS	06/91 ⇒ 12/96
850 2.0 10V	B5202FS	08/94 ⇒ 12/97
850 2.0 Turbo	B5204FT, B5204T, B5204T2	02/93 ⇒ 10/97
850 2.3	B5234FS	01/96 ⇒ 10/96
850 2.3 T5	9M9T872	02/93 ⇒ 12/96
850 2.3 T5-R	B5234T4	08/95 ⇒ 12/96
850 2.3 Turbo R	B5234T5	06/95 ⇒ 10/97
850 2.4	B5252, B5252FS, B5254S	06/91 ⇒ 12/96
850 2.4 AWD	B5254T	04/96 ⇒ 12/96
850 2.4 GLE	B5254T	09/93 ⇒ 10/97

1.499.069

VOLVO		
850 2.5 10V	B5252FS	06/91 ⇒ 12/97
850 2.5 20V	B5254FS	08/91 ⇒ 12/97
C70 1.2.0	B5204T2	03/97 ⇒ 10/05
C70 1.2.0 T	B5204T3	03/97 ⇒ 10/05
C70 1.2.3 T5	B5234T3	03/98 ⇒ 10/05
C70 1.2.3 T-5	B5234T3	03/97 ⇒ 09/02
C70 1.2.4 T	B5254T	03/97 ⇒ 10/05
S70 2.0	B5202FS, B5202S, B5204T2	01/97 ⇒ 11/00
S70 2.0 Turbo	B5204T3	01/97 ⇒ 11/00
S70 2.3	B5234FS, B5234T7	01/97 ⇒ 07/99
S70 2.3 AWD	B5234T7	04/99 ⇒ 09/00
S70 2.3 T-5	B5234T3	01/97 ⇒ 11/00
S70 2.3 T5 AWD	B5234T4	07/97 ⇒ 09/00
S70 2.3 T5-R AWD	B5234T2	11/96 ⇒ 09/98
S70 2.3 Turbo	B5234FT+	01/97 ⇒ 11/00
S70 2.4	B5254S	06/98 ⇒ 11/00
S70 2.4 AWD	B5252FS	11/96 ⇒ 05/99
S70 2.4 Bifuel	GB5252S	10/98 ⇒ 11/00
S70 2.4 T5 AWD	B5254T	11/96 ⇒ 04/99
S70 2.4 Turbo	B5254T	01/97 ⇒ 11/00
S70 2.5 20V	B5254FS	01/97 ⇒ 12/98
S70 2.5 Bifuel	GB5252S2	01/99 ⇒ 12/99
V70 1.2.0	B5202FS, B5202S, B5204T2	12/95 ⇒ 03/00
V70 1.2.0 Turbo	B5204T3	11/96 ⇒ 12/00
V70 1.2.0 Turbo AWD	B5204T3	11/96 ⇒ 12/00
V70 1.2.3	B5234FS	01/97 ⇒ 07/99
V70 1.2.3 AWD	B5234T3, B5234T7	04/97 ⇒ 09/98
V70 1.2.3 T AWD	B5234FT+, B5234T4, B5234T6	04/97 ⇒ 12/98
V70 1.2.3 T-5	B5234T3	11/96 ⇒ 12/00
V70 1.2.3 T-5 AWD	B5234T3	01/97 ⇒ 12/00
V70 1.2.3 Turbo	B5234FT+, B5234T2, B5234T4	12/95 ⇒ 12/98
V70 1.2.4	B5254S	06/98 ⇒ 12/99
V70 1.2.4 Bifuel	GB5252S	05/98 ⇒ 12/99
V70 1.2.4 Turbo AWD	B5254T	04/96 ⇒ 12/00
V70 1.2.5	B5252FS	01/97 ⇒ 03/00
V70 1.2.5 20V	B5254FS	01/97 ⇒ 12/99
V70 1.2.5 Bifuel	GB5252S2	01/99 ⇒ 12/99

EPS 1.499.100

07,5

IGNITION CABLE SETS

Adatt./Suitable:

⁰⁰ Eliminated on 20-05-2019. Please verify the availability through our local distributors

- Eliminato il 20-05-2019. Verificare la disponibilità presso i nostri distributori
- Éliminé le 20-05-2019. Vérifier la disponibilité auprès de nos distributeurs sur place
- Am 20-05-2019 gestrichen. Evtl. Verfügbarkeit bitte bei unseren Händlern prüfen
- Eliminado en fecha 20-05-2019. Verificar la disponibilidad a través de nuestros distribuidores locales

SILICONE

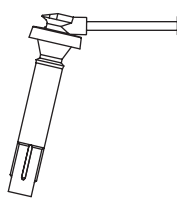

L=600
L=600
L=500
L=450

SILICONE

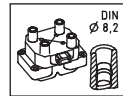
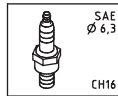
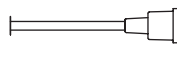

SUPPRESSION CABLE Ø 7 mm

SUBARU

LEGACY IV 2.0 AWD	EJ202	09/03 ⇒ 10/05
OUTBACK III 2.0	EJ202	09/03 ⇒ 10/05
OUTBACK III 2.0 AWD	EJ202	09/03 ⇒ 10/05

EPS 1.499.069

07

IGNITION CABLE SETS

Adatt./Suitable:

⁰⁰ Eliminated on 26-01-2021. Please verify the availability through our local distributors

- Eliminato il 26-01-2021. Verificare la disponibilità presso i nostri distributori
- Éliminé le 26-01-2021. Vérifier la disponibilité auprès de nos distributeurs sur place
- Am 26-01-2021 gestrichen. Evtl. Verfügbarkeit bitte bei unseren Händlern prüfen
- Eliminado en fecha 26-01-2021. Verificar la disponibilidad a través de nuestros distribuidores locales

SILICONE

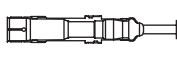

L=450
L=400
L=400
L=350

SILICONE

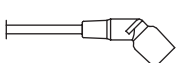

5 k.Ω

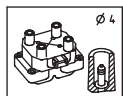
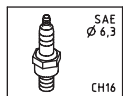

COPPER CORE CABLE Ø 7 mm

BMW

3 IV 316 Ci	M43B16(164E3)	04/00 ⇒ 07/06
3 IV 316 i	M43B16(164E3), M43B19(194E1)	04/00 ⇒ 02/05
3 IV 318 Ci	M43B19(194E1)	12/99 ⇒ 08/01
3 IV 318 i	M43B19(194E1)	12/97 ⇒ 09/01

EPS 1.499.106

07,5

IGNITION CABLE SETS

Adatt./Suitable:

SILICONE

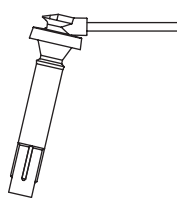

L=850
L=850
L=550
L=500

EPDM

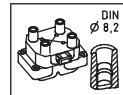
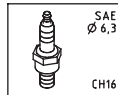
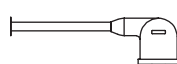

SUPPRESSION CABLE Ø 7 mm

SUBARU

FORESTER III 2.5	EJ253	01/08 ⇒
FORESTER II 2.5	EJ253	02/02 ⇒
LEGACY IV 2.5 AWD	EJ25	09/03 ⇒ 04/09
LEGACY IV 2.5 i	EJ252, EJ253	05/03 ⇒
LEGACY IV 2.5 i AWD	EJ25	09/07 ⇒ 12/09
OUTBACK III 2.5	EJ252, EJ253	09/08 ⇒ 09/09

EPS 1.499.107

07,5

IGNITION CABLE SETS

Adatt./Suitable:

⁰⁰ Eliminated on 22-02-2022. Please verify the availability through our local distributors

- Eliminato il 22-02-2022. Verificare la disponibilità presso i nostri distributori
- Éliminé le 22-02-2022. Vérifier la disponibilité auprès de nos distributeurs sur place
- Am 22-02-2022 gestrichen. Evtl. Verfügbarkeit bitte bei unseren Händlern prüfen
- Eliminado en fecha 22-02-2022. Verificar la disponibilidad a través de nuestros distribuidores locales

SILICONE

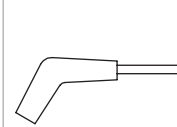

L=750
L=700
L=650
L=650
L=550
L=550
L=400
L=400

SILICONE

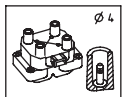
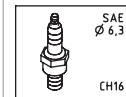
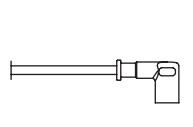

SUPPRESSION CABLE Ø 7 mm

LAND ROVER

DISCOVERY II 4.0 V8 4x4	35D, 56D, 94D	11/98 ⇒ 06/04
DISCOVERY II 4.6 V8 [USA]	--	01/03 ⇒ 06/04
RANGE ROVER II 3.9 4x4	42D	07/94 ⇒ 03/02
RANGE ROVER II 4.0 4x4	42D	01/95 ⇒ 03/02
RANGE ROVER II 4.6 4x4	46D	07/94 ⇒ 03/02

EPS 1.499.111

07,5

IGNITION CABLE SETS

Adatt./Suitable:

HYUNDAI

27501-26A00
27501-26C00
27501-26D00

KIA

27501-26D00

⁰³ Supplied until depletion

- Fornibile fino ad esaurimento delle scorte
- Fourni jusqu'à épuisement du stock
- Lieferbar solange vorrat reicht
- Suministrado hasta el stock termina

SILICONE

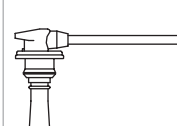

L=500
L=400
L=300
L=250

EPDM

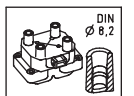
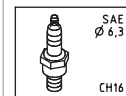
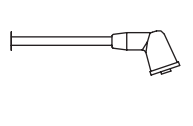

SUPPRESSION CABLE Ø 7 mm

HYUNDAI

ACCENT I 1.5 i 16V	G4ER	10/95 ⇒ 01/00
ACCENT II 1.5	G4EC-G	09/99 ⇒ 11/05
ACCENT II 1.6	G4ED-G	12/02 ⇒ 11/05
COUPE I 1.6 16V	G4GR	03/98 ⇒ 04/02
COUPE I 1.6i 16V	4G61	12/96 ⇒ 04/02
ELANTRA III 1.6	G4ED-G, G4GA, G4GR	06/00 ⇒ 07/06
EXCEL 1.5 i 16V GT	G4ER	10/96 ⇒ 08/99
GETZ 1.4 i	G4EE	08/05 ⇒ 12/10
GETZ 1.6	G4ED-G	09/02 ⇒ 06/09
LAVITA 1.6	--	01/07 ⇒
MATRIX 1.6	G4ED-G, G4ED-L	06/01 ⇒ 08/10
MATRIX 1.6 [TUR]	G4ED	04/08 ⇒
ACCENT III 1.4 GL	G4EE	11/05 ⇒ 11/10
ACCENT III 1.6 GLS	G4ED	11/05 ⇒ 11/10
COUPE II 1.6 16V	G4ED-G	03/02 ⇒ 08/09
VERNA I 1.5	G4EC-G	09/99 ⇒

HYUNDAI		
VERNA I 1.6	G4ED-G	12/02 ⇨
VERNA II 1.4 GL	--	11/05 ⇨
VERNA II 1.6 GLS	--	11/05 ⇨
KIA		
CERATO I 1.6	G4ED	04/04 ⇨ 12/09
RIO II 1.4 16V	G4EE	03/05 ⇨ 12/11
RIO II 1.6 16V	G4ED	03/05 ⇨ 12/11
RIO II 1.6 CVVT	G4ED	03/05 ⇨ 12/11

EPS 1.499.119

07

IGNITION CABLE SETS

Adatt./Suitable:

BOSCH
0 986 356 898
F 000 99C 609

HYUNDAI
27501-02H00
27501-22B00
27501-22B10

KIA
27501-02H00

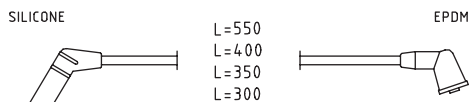

SUPPRESSION CABLE ø 7 mm

HYUNDAI

ACCENT I 1.3	G4EH	10/94 ⇨ 01/00
ACCENT I 1.3 i 12V	G4EH	10/94 ⇨ 01/00
ACCENT I 1.5	G4EK	10/94 ⇨ 07/99
ACCENT I 1.5 i 12V	G4EK	10/94 ⇨ 01/00
ACCENT II 1.3	G4EA, G4EH	01/00 ⇨ 11/05
ACCENT II 1.5	G4EB, G4EK	01/00 ⇨ 11/05
ATOS 1.0 i	G4HC-E	03/01 ⇨ 07/03
ATOS 1.1	G4HD, G4HG	06/03 ⇨ 12/10
ATOS PRIME 1.0 i	G4HC-E	03/01 ⇨ 07/03
ATOS PRIME 1.1	G4HD, G4HG	08/03 ⇨ 12/08
EXCEL 1.3 i 12V	G4EH	09/94 ⇨ 08/99
EXCEL 1.5 i 12V	G4EK	09/94 ⇨ 08/99
GETZ 1.1	G4HD	09/02 ⇨ 09/05
GETZ 1.3	G4EA	09/03 ⇨ 06/09
GETZ 1.3 i	G4EA	09/02 ⇨ 03/04
LANTRA II 1.5 12V	G4EK	12/96 ⇨ 10/00
SANTRO 1.1	G4HD	01/03 ⇨
S COUPE 1.5 i	G4EK	04/92 ⇨ 05/96
S COUPE 1.5 i Turbo	G4EK-TC	04/91 ⇨ 05/96
VERNA I 1.3	G4EA	09/99 ⇨
VERNA I 1.5	G4EB	09/99 ⇨

KIA

PICANTO I 1.0	--, G4HE	04/04 ⇨
PICANTO I 1.1	G4HG	04/04 ⇨ 09/11

EPS 1.499.120

07

IGNITION CABLE SETS

Adatt./Suitable:

BOSCH
0 986 356 990

HYUNDAI
27501-02A00

03 Supplied until depletion

- Fornibile fino ad esaurimento delle scorte
- Fourni jusqu'à épuisement du stock
- Lieferbar solange vorrat reicht
- Suministrado hasta el stock termina

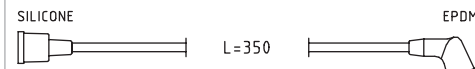
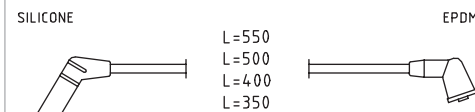

SUPPRESSION CABLE ø 7 mm

HYUNDAI

ATOS 1.0 i	G4HC	02/98 ⇨ 03/02
ATOS PRIME 1.0 i	G4HC	08/99 ⇨

EPS 1.499.159

07,5

IGNITION CABLE SETS

Adatt./Suitable:

00 Eliminated on 27-09-2021. Please verify the availability through our local distributors

- Eliminato il 27-09-2021. Verificare la disponibilità presso i nostri distributori
- Éliminé le 27-09-2021. Vérifier la disponibilité auprès de nos distributeurs sur place
- Am 27-09-2021 gestrichen. Evtl. Verfügbarkeit bitte bei unseren Händlern prüfen
- Eliminado en fecha 27-09-2021. Verificar la disponibilidad a través de nuestros distribuidores locales

03 Supplied until depletion

- Fornibile fino ad esaurimento delle scorte
- Fourni jusqu'à épuisement du stock
- Lieferbar solange vorrat reicht
- Suministrado hasta el stock termina

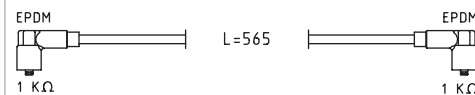
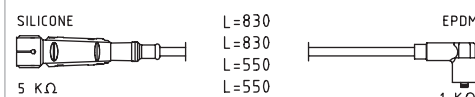

COPPER CORE CABLE ø 7 mm

VW

TRANSPORTER III 1.9	DF, DG	08/82 ⇨ 07/92
TRANSPORTER III 1.9 Syncro	DG	11/84 ⇨ 07/92
TRANSPORTER III 2.1	DJ	08/84 ⇨ 07/92
TRANSPORTER III 2.1 Syncro	DJ	01/86 ⇨ 07/92

EPS 1.499.170

07

IGNITION CABLE SETS

Adatt./Suitable:

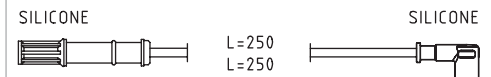
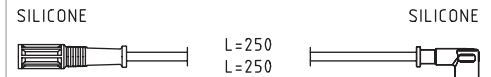

SUPPRESSION CABLE ø 7 mm

ALFA ROMEO

MITO 1.4	04Y, 350A1.000, 955A9.000	08/08 ⇨
----------	---------------------------	---------

FIAT

500 1.2	169A4.000	07/07 ⇨
500 C 1.2	169A4.000	09/09 ⇨
PUNTO III EVO 1.2	169A4.000, 199A4.000	10/09 ⇨ 02/12
PUNTO III EVO 1.4	350A1.000, 858Y1	03/09 ⇨
PUNTO III EVO 1.4 LPG	350A1.000	06/09 ⇨ 02/12
PUNTO III EVO 1.4 Natural Power	350A1.000	10/09 ⇨ 02/12
500 MY12 1.2	--	01/12 ⇨
PUNTO III 1.2	169A4.000, 199B9.000	03/12 ⇨
PUNTO III 1.4	350A1.000	03/12 ⇨
PUNTO III 1.4 LPG	350A1.000	03/12 ⇨
PUNTO III 1.4 Natural Power	350A1.000	03/09 ⇨
FIORINO III 1.4	350A1.000, KFT, KVF	11/07 ⇨
FIORINO III 1.4 Natural Power	350A1.000	06/08 ⇨
DOBLO I 1.4	350A1.000	10/05 ⇨
PANDA III 1.2	169A4.000	02/12 ⇨
PANDA III 1.2 LPG	169A4.000	06/12 ⇨
IDEA 1.4	350A1.000	10/05 ⇨
LINEA 1.4	350A1.000	06/07 ⇨
PALIO 1.4	834A1.000	06/03 ⇨
PANDA II 1.2	169A4.000	03/10 ⇨
PANDA II 1.2 4x4	169A4.000	04/10 ⇨
PANDA II 1.2 Euro 5	--	04/09 ⇨
PANDA II 1.4 16V	--	11/10 ⇨
PANDA II 1.4 Natural Power	350A1.000	10/09 ⇨
PUNTO III / GRANDE PUNTO 1.2	169A4.000, 199A4.000	10/05 ⇨
PUNTO III / GRANDE PUNTO 1.2 [IND]	--	01/08 ⇨
PUNTO III / GRANDE PUNTO 1.2 Actual	--	09/09 ⇨
PUNTO III / GRANDE PUNTO 1.2 LPG	199A4.000	06/08 ⇨ 12/12
PUNTO III / GRANDE PUNTO 1.4	350A1.000, 858Y1	06/05 ⇨ 12/15
PUNTO III / GRANDE PUNTO 1.4 Actual	--	09/09 ⇨
PUNTO III / GRANDE PUNTO 1.4 LPG	350A1.000	12/08 ⇨
PUNTO III / GRANDE PUNTO 1.4 Natural Power	350A1.000	07/08 ⇨
QUBO 1.4	350A1.000, KFT, KVF	02/08 ⇨
QUBO 1.4 Natural Power	350A1.000	10/09 ⇨
500 MY15 1.2	--	01/15 ⇨
500 MY15 1.2 LPG	--	01/15 ⇨
SIENA 1.4	--	01/02 ⇨

FORD

KA II 1.2	FP4	10/08 ⇨ 05/16
-----------	-----	---------------

LANCIA

MUSA 1.4	350A1.000	09/05 ⇨ 09/12
MUSA 1.4 8V	--	01/11 ⇨ 12/12
YPSILON II 1.4	350A1.000	02/06 ⇨ 12/11
YPSILON II 1.4 LPG	350A1.000	11/10 ⇨ 12/11
YPSILON III 1.2	169A4.000	05/11 ⇨
YPSILON III 1.2 Bi-fuel	169A4.000	05/11 ⇨

EPS 1.499.181

07,5

IGNITION CABLE SETS

Adatt./Suitable:

JEEP

4728190
4728190AC**00 Eliminated on 22-02-2022. Please verify the availability through our local distributors**

- Eliminato il 22-02-2022. Verificare la disponibilità presso i nostri distributori
- Éliminé le 22-02-2022. Vérifier la disponibilité auprès de nos distributeurs sur place
- Am 22-02-2022 gestrichen. Evtl. Verfügbarkeit bitte bei unseren Händlern prüfen
- Eliminado en fecha 22-02-2022. Verificar la disponibilidad a través de nuestros distribuidores locales

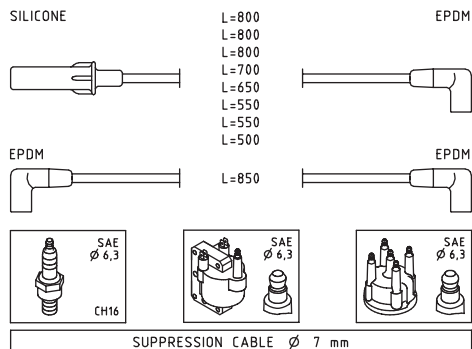

JEEP

GRAND CHEROKEE 5.2	ELF	10/96 ⇒ 09/98
GRAND CHEROKEE 5.2 4x4	ELF	10/96 ⇒ 09/98
GRAND CHEROKEE 5.2 i	EHY	10/90 ⇒ 09/96
GRAND CHEROKEE 5.9 i	EML	10/96 ⇒ 09/98

EPS 1.499.195

07

IGNITION CABLE SETS

Adatt./Suitable:

00 Eliminated on 04-05-2020. Please verify the availability through our local distributors

- Eliminato il 04-05-2020. Verificare la disponibilità presso i nostri distributori
- Éliminé le 04-05-2020. Vérifier la disponibilité auprès de nos distributeurs sur place
- Am 04-05-2020 gestrichen. Evtl. Verfügbarkeit bitte bei unseren Händlern prüfen
- Eliminado en fecha 04-05-2020. Verificar la disponibilidad a través de nuestros distribuidores locales

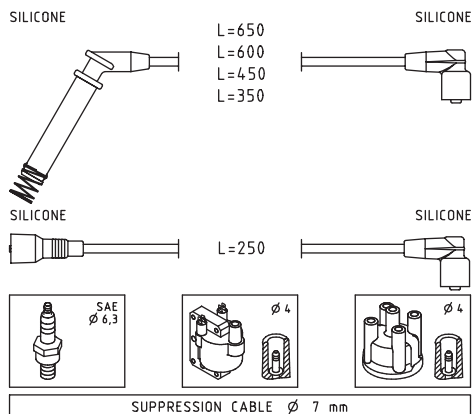

OPEL

COMBO B 1.2	C12NZ, X12SZ	07/94 ⇒ 10/01
COMBO B 1.4	C14NZ	07/94 ⇒ 10/01
CORSA B 1.2 i	12NZ, C12NZ, X12SZ	03/93 ⇒ 09/00
CORSA B 1.4 i	C14NZ	03/93 ⇒ 09/00

VAUXHALL

COMBO B 1.2	C12NZ, X12SZ	07/94 ⇒ 10/01
COMBO B 1.4	C14NZ	07/94 ⇒ 10/01

VAUXHALL

CORSA B 1.2 i	C12NZ, X12SZ	03/93 ⇒ 09/00
CORSA B 1.4 i	C14NZ	03/93 ⇒ 09/00
CORSAVAN I 1.4 i	C14NZ	01/94 ⇒ 09/00

EPS 1.499.199

07

IGNITION CABLE SETS

Adatt./Suitable:

00 Eliminated on 22-02-2022. Please verify the availability through our local distributors

- Eliminato il 22-02-2022. Verificare la disponibilità presso i nostri distributori
- Éliminé le 22-02-2022. Vérifier la disponibilité auprès de nos distributeurs sur place
- Am 22-02-2022 gestrichen. Evtl. Verfügbarkeit bitte bei unseren Händlern prüfen
- Eliminado en fecha 22-02-2022. Verificar la disponibilidad a través de nuestros distribuidores locales

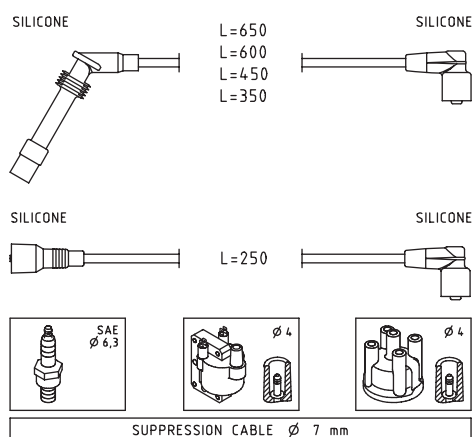

EPS 1.499.208

07

IGNITION CABLE SETS

Adatt./Suitable:

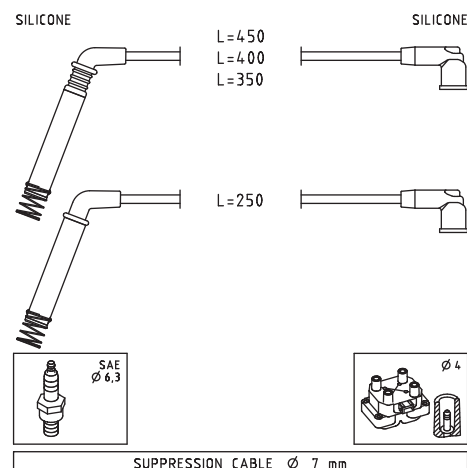

FORD

FIESTA V 1.3	A9JA, A9JB, BAJA	11/01 ⇒ 06/08
FOCUS I 1.6 16V Flexifuel	FYDH	01/02 ⇒ 11/04
FUSION 1.3	--, BAJA	08/02 ⇒
KA I 1.3 i	BAA	09/96 ⇒ 11/08
KA I 1.3 i ROCAM	A9A, A9B	08/02 ⇒ 11/08
KA I 1.6	CDB, CDC	09/00 ⇒ 11/08
KA I 1.6 i	CCA, CDB, CDC	02/01 ⇒ 11/08
STREET KA 1.6	CDRA, CDRB	05/03 ⇒ 07/05

EPS 1.499.214

07,5

IGNITION CABLE SETS

Adatt./Suitable:

03 Supplied until depletion

- Fornibile fino ad esaurimento delle scorte
- Fourni jusqu'à épuisement du stock
- Lieferbar solange vorrat reicht
- Suministrado hasta el stock termina

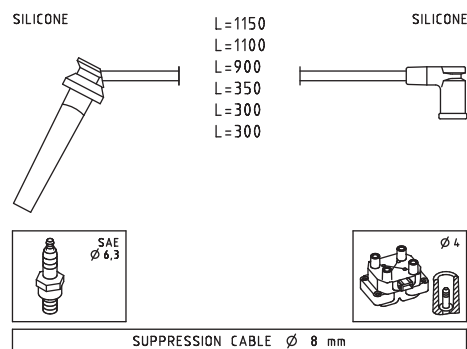

FORD

MONDEO II 3.0 V6 24V	REBA	09/04 ⇒ 03/07
MONDEO II ST220	MEBA	04/02 ⇒ 03/07

EPS **1.499.223** 07

IGNITION CABLE SETS

Adatt./Suitable:

VW
06A 905 409 N

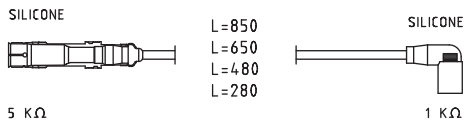

COPPER CORE CABLE Ø 7 mm

SKODA

OCTAVIA I 2.0	AZJ	04/99 ⇒ 05/07
OCTAVIA I 2.0 4x4	AZJ	08/00 ⇒ 09/04

VOLKSWAGEN (BR)

POLO 2.0	CFEA	01/09 ⇒
----------	------	---------

VW

BORA 2.0	AZJ	10/98 ⇒ 12/13
BORA 2.0 4motion	AZJ	04/00 ⇒ 05/05
CADDY III 2.0 EcoFuel	BSX	04/06 ⇒ 05/15
GOLF IV 2.0	AZG, AZJ	07/98 ⇒ 06/06
GOLF IV 2.0 4motion	AZJ	10/00 ⇒ 06/06
GOLF IV 2.0 Bi-Fuel	BEH	02/02 ⇒ 06/06
JETTA VI 2.0	CKJA	06/10 ⇒ 12/17
NEW BEETLE 2.0	AZG, AZJ, BDC, BEJ, BER, BEV, BGD, BHP	01/98 ⇒ 10/10
TOURAN I 2.0 EcoFuel	BSX	02/06 ⇒ 05/09

EPS **1.499.229** 07

IGNITION CABLE SETS

Adatt./Suitable:

RENAULT
82 00 575 895

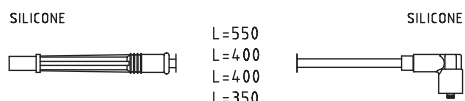

SUPPRESSION CABLE Ø 7 mm

RENAULT

CLIO III 1.2 16V	D4F784, D4F786	05/07 ⇒ 12/14
MODUS / GRAND MODUS 1.2	D4F786	04/11 ⇒
MODUS / GRAND MODUS 1.2 16V	D4F784	05/07 ⇒
TWINGO II 1.2 TcE 100	D4F780, D4F782	02/11 ⇒
TWINGO II 1.2 Turbo	D4F780, D4F782	03/07 ⇒ 09/14
WIND 1.2	D4F782	07/10 ⇒

EPS **1.499.230** 07

IGNITION CABLE SETS

Adatt./Suitable:

BOSCH
0 986 357 253
MAGNETI MARELLI
941318111315

NISSAN
22450-00Q0A
22450-00Q0C
22450-00QAA

RENAULT
82 00 486 877
82 00 805 133

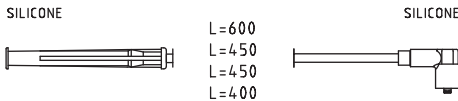

SUPPRESSION CABLE Ø 7 mm

NISSAN

KUBISTAR 1.2	D7F726, D7F744, D7F764	08/03 ⇒
--------------	------------------------	---------

RENAULT

TWINGO II 1.2	D7F800	03/07 ⇒ 09/14
---------------	--------	---------------

EPS **1.499.231** 07,5

IGNITION CABLE SETS

Adatt./Suitable:

SUZUKI
33700M70FA0
33700M70FA0-000
33710M70F30
33710M70F30-000

Eliminated on 22-02-2022. Please verify the availability through our local distributors

- Eliminato il 22-02-2022. Verificare la disponibilità presso i nostri distributori
- Éliminé le 22-02-2022. Vérifier la disponibilité auprès de nos distributeurs sur place
- Am 22-02-2022 gestrichen. Evtl. Verfügbarkeit bitte bei unseren Händlern prüfen
- Eliminado en fecha 22-02-2022. Verificar la disponibilidad a través de nuestros distribuidores locales

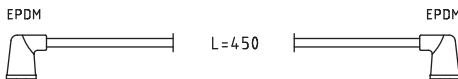
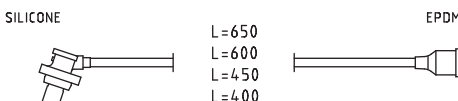

SUPPRESSION CABLE Ø 7 mm

SUZUKI

ALTO IV 1.0	G10BB	09/94 ⇒ 06/02
ALTO V 1.0	G10BB	01/00 ⇒ 06/02

EPS **1.499.232** 07

IGNITION CABLE SETS

Adatt./Suitable:

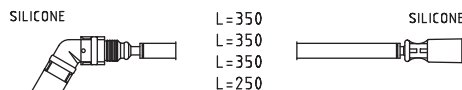

COPPER CORE CABLE Ø 7 mm

MERCEDES-BENZ

CLASSE A II A 200 TURBO	M266.980	09/05 ⇒ 06/12
CLASSE B I B 200 TURBO	M266.980	03/05 ⇒ 11/11

EPS **1.499.234** 07

IGNITION CABLE SETS

Adatt./Suitable:

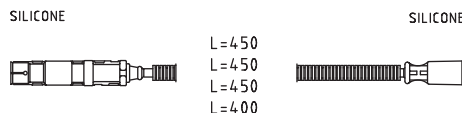

COPPER CORE CABLE Ø 7 mm

MERCEDES-BENZ

CLASSE A II A 150	M266.920	09/04 ⇒ 06/12
CLASSE A II A 160	M266.920	04/09 ⇒ 06/12
CLASSE A II A 170	M266.940	09/04 ⇒ 06/12
CLASSE A II A 180	M266.940	04/09 ⇒ 06/12
CLASSE A II A 200	M266.960	09/04 ⇒ 06/12
CLASSE B I B 150	M266.920	03/05 ⇒ 11/11
CLASSE B I B 160	M266.920	04/09 ⇒ 11/11
CLASSE B I B 170	M266.940	03/05 ⇒ 11/11
CLASSE B I B 170 NGT	M266.960	04/08 ⇒ 11/11
CLASSE B I B 180	M266.940	04/09 ⇒ 11/11
CLASSE B I B 180 NGT	M266.960	04/08 ⇒ 11/11
CLASSE B I B 200	M266.960	03/05 ⇒ 11/11

1.499.235

EPS 1.499.235



07

IGNITION CABLE SETS

Adatt./Suitable:

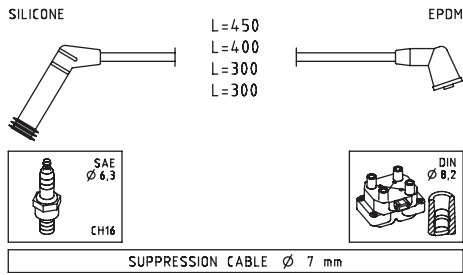
HYUNDAI
27501-02D00**HYUNDAI**

ATOS 1.0 i	G4HC, G4HC-E	03/01 ⇒ 07/03
ATOS PRIME 1.0 i	G4HC, G4HC-E	03/01 ⇒
GETZ 1.1	G4HD	09/02 ⇒ 06/09
I10 I 1.1	G4HG	12/07 ⇒ 12/13

KIA

PICANTO I 1.0	G4HE	09/07 ⇒ 04/11
PICANTO I 1.1	--	08/07 ⇒

EPS 1.499.236



07,5

IGNITION CABLE SETS

Adatt./Suitable:

HYUNDAI
27501-37B00

- ⁰³ Supplied until depletion
- Fornibile fino ad esaurimento delle scorte
 - Fourni jusqu'à épuisement du stock
 - Lieferbar solange vorrat reicht
 - Suministrado hasta el stock termina

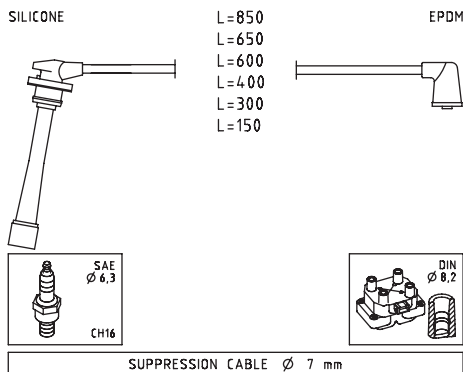
**HYUNDAI**

SANTA FE I 2.7 V6 4x4	G6BA-G	02/01 ⇒ 03/06
COUPE II 2.7 V6	G6BA-G	01/01 ⇒ 08/09
TUCSON 2.7 Trazione integrale	G6BA-G	08/04 ⇒ 11/10

KIA

SPORTAGE II 2.7 V6 4WD	G6BA	09/04 ⇒
------------------------	------	---------

EPS 1.499.239



07,5

IGNITION CABLE SETS

Adatt./Suitable:

HITACHI
134114**KIA**OK30E-18140
OK30F-18140
27400-2X140

- ⁰³ Supplied until depletion
- Fornibile fino ad esaurimento delle scorte
 - Fourni jusqu'à épuisement du stock
 - Lieferbar solange vorrat reicht
 - Suministrado hasta el stock termina

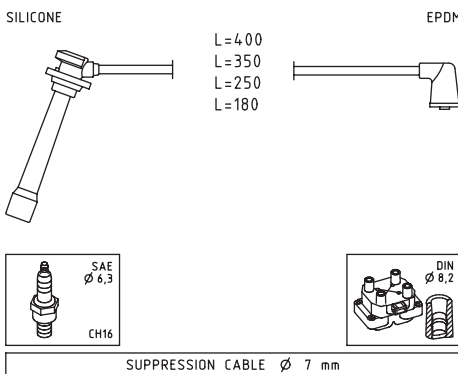
**KIA**

RIO I 1.5 16V	A5D	08/00 ⇒ 02/05
RIO I 1.6 [CAN] [USA]	--	06/00 ⇒ 02/05
CARENS I 1.6	GA6D	07/02 ⇒
SHUMA I 1.6	GA6D	01/01 ⇒ 12/01
SHUMA II 1.6	GA6D	05/01 ⇒ 08/04
SPECTRA 1.6 i 16V	--	07/00 ⇒
SEPHIA 1.6 i 16V	--	07/00 ⇒

EPS 1.499.241



07

IGNITION CABLE SETS

Adatt./Suitable:

BOSCH

0 986 356 991

HITACHI

134376

HYUNDAI

27501-38B00

KIA

27501-38B00

- ⁰³ Supplied until depletion
- Fornibile fino ad esaurimento delle scorte
 - Fourni jusqu'à épuisement du stock
 - Lieferbar solange vorrat reicht
 - Suministrado hasta el stock termina

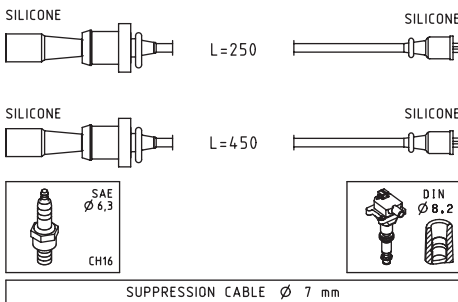
**HYUNDAI**

H-1 I 2.4	G4JS	11/01 ⇒ 04/04
HIGHWAY VAN 2.0 16V	G4JP	03/00 ⇒ 03/04
SANTA FE I 2.0	G4BP	08/01 ⇒ 03/06
SANTA FE I 2.4 16V	G4JS-G	02/01 ⇒ 03/06
SANTA FE I 2.4 16V 4x4	G4JS-G	02/01 ⇒ 03/06
SONATA IV 2.0 16V	G4JP-EG, G4JP-G	10/01 ⇒ 11/04
SONATA IV 2.4 16V	G4BS	03/98 ⇒ 10/01
SONATA V 2.0 [RUS]	--	01/05 ⇒ 04/06
TRAJET 2.0	G4GC, G4GC-G, G4JP-G	03/00 ⇒ 07/08
TRAJET 2.0 CRDi	D4EA	08/05 ⇒ 07/08

KIA

MAGENTIS I 2.0	G4JP	05/01 ⇒ 09/05
MAGENTIS I 2.4 [USA]	--	01/01 ⇒ 12/04

EPS 1.499.242



07

IGNITION CABLE SETS

Adatt./Suitable:

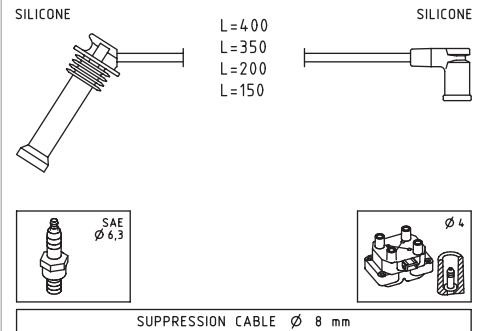
VOLVO
30731424**FORD**

B-MAX 1.4	SPJD	10/12 ⇒
B-MAX 1.4 LPG	RTJC	08/13 ⇒
B-MAX 1.6 Ti	IQJA	10/12 ⇒
C-MAX I 1.6	HWDA, HWDB, SHDA, SHDB, SHDC	02/07 ⇒ 09/10
C-MAX I 1.6 Ti-VCT	--	03/07 ⇒
C-MAX II 1.6	--	12/10 ⇒
C-MAX II 1.6 Ti	IQDA, IQDB, PNDA, XTDA	12/10 ⇒ 06/19
FIESTA V 1.25 16V	FUJA, FUJB, M7JA, M7JB	05/02 ⇒ 06/08
FIESTA V 1.4 16V	FXJA, FXJB	11/01 ⇒ 06/08
FIESTA V 1.6 16V	FYJA, FYJB	11/01 ⇒ 06/08
FIESTA VI 1.25	SNJA, SNJB, SNJC, SNJD, STJA, STJB	06/08 ⇒
FIESTA VI 1.4	--, 8MA1.77, SPJC	06/08 ⇒
FIESTA VI 1.4 LPG	RTJA, RTJB	01/09 ⇒ 04/17
FIESTA VI 1.6 Ti	--, 68GR-FKS, HXJB, IQJA, USJA	06/08 ⇒
FOCUS II 1.4	ASDA, ASDB	07/04 ⇒ 09/12
FOCUS II 1.6	HWDA, HWDB, SHDA, SHDB, SHDC	07/04 ⇒ 09/12
FOCUS II 1.6 Ti	HXDA, HXDB	07/04 ⇒ 09/12
FOCUS II 1.6 Ti-VCT	--	12/07 ⇒
FOCUS III 1.6 Flexifuel	MUDA	07/10 ⇒
FOCUS III 1.6 LPG	MUDA	02/12 ⇒
FOCUS III 1.6 Ti	IQDB, MUDA, PNDA, XTDA	07/10 ⇒
FOCUS III 1.6 Ti-VCT	--	07/10 ⇒
FOCUS C-MAX 1.6	HWDA, HWDB	10/03 ⇒ 03/07
FOCUS C-MAX 1.6 Ti	HXDA, SIDA	08/04 ⇒ 03/07
FUSION 1.25	--, FUJA, FUJB	10/02 ⇒
FUSION 1.4	--, FXJA, FXJB, FXJC	08/02 ⇒
FUSION 1.4 LPG	UTJA	01/10 ⇒ 12/12
FUSION 1.6	FYJA, FYJB, FYJC	08/02 ⇒ 11/09
GRAND C-MAX 1.6 Ti	IQDA, IQDB, PNDA	12/10 ⇒ 06/19
KA+ 1.2	B2KA	06/16 ⇒
KA+ 1.2 Ti-VCT	YSKD, YSKE	06/16 ⇒
MONDEO III 1.6 Ti	KGBA, PNBA, RHBA	03/07 ⇒ 01/15

MAZDA

2 I 1.2	FUJA	02/03 ⇒ 06/07
2 I 1.25	FUJA	04/03 ⇒ 06/07
2 I 1.3 L	ZJ-04	04/03 ⇒ 06/07
2 I 1.4	FXJA	02/03 ⇒ 06/07
2 I 1.5	ZY-VE	04/03 ⇒ 06/07
2 I 1.6	FYJA	02/03 ⇒ 06/07

VOLVO

C30 1.6	B416453	10/06 ⇒ 12/12
S40 II 1.6	B416453	01/05 ⇒ 12/12
V50 1.6	B416453	01/05 ⇒ 12/12

EPS 1.499.244



07

IGNITION CABLE SETS

Adatt./Suitable:

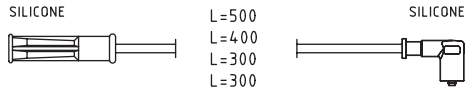
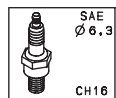
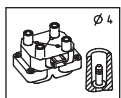
BOSCH
0 986 MG0 980**DACIA**
77 00 273 826
82 00 506 297**MAGNETI MARELLI**
941318111002**NISSAN**
22450-00Q0B
22450-00QAB**RENAULT**
77 00 273 826
82 00 506 297L=500
L=400
L=300
L=300SAE
ø 6,3
CH16

ø 4

SUPPRESSION CABLE ø 7 mm

DACIA

LOGAN I 1.4	K7J710	09/04 ⇒
LOGAN I 1.6	K7M710	09/04 ⇒
LOGAN I 1.6 Bifuel	K7M710	11/08 ⇒
SANDERO I 1.4	K7J710	06/08 ⇒

NISSAN

KUBISTAR 1.4	K7J700	08/03 ⇒ 10/09
--------------	--------	---------------

RENAULT

CLIO II 1.4	E7J634, E7J635, K7J700	09/98 ⇒
CLIO II 1.6	K7M746	10/99 ⇒
KANGOO I 1.4	E7J634, E7J635, K7J700, K7J701	08/97 ⇒
KANGOO I 1.6	K7M746	09/99 ⇒
LOGAN 1.4	K7J710	09/04 ⇒
LOGAN 1.6	K7M710	09/04 ⇒
MEGANE I 1.4	E7J626	09/96 ⇒ 08/03
MEGANE I 1.4 e	E7J626	01/96 ⇒ 08/03
MEGANE I 1.6	K7M704	02/00 ⇒ 09/00
MEGANE I 1.6 e	K7M702, K7M703	01/96 ⇒ 08/03
MEGANE I 1.6 i	K7M720	01/96 ⇒ 03/99
MEGANE SCÉNIC I 1.6 e	K7M702, K7M703	10/96 ⇒ 10/99
MEGANE SCÉNIC I 1.6 i	K7M720	01/97 ⇒ 09/99
SANDERO I 1.4	K7J710	02/09 ⇒
SANDERO I 1.6	K7M710	02/09 ⇒

EPS 1.499.245



07

IGNITION CABLE SETS

Adatt./Suitable:

HITACHI
134955**MAGNETI MARELLI**
941318111320**MAZDA**
L813-18-140B
L813-18-140C**03 Supplied until depletion**

- Fornibile fino ad esaurimento delle scorte
- Fourni jusqu'à épuisement du stock
- Lieferbar solange vorrat reicht
- Suministrado hasta el stock termina

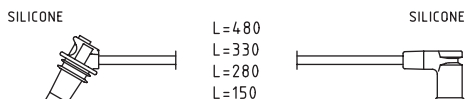
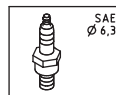
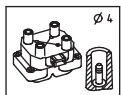
L=480
L=330
L=280
L=150SAE
ø 6,3

ø 4

SUPPRESSION CABLE ø 8 mm

MAZDA

611.8	L813, L823, L828	08/02 ⇒ 08/07
612.0	LF17, LF18	06/02 ⇒ 08/07
612.3	L3C1	01/02 ⇒ 02/08
612.3 AWD	L3C1	11/02 ⇒ 08/07

MAZDA

MPV II 2.3 L3 07/02 ⇒ 02/06

EPS 1.499.246



07

IGNITION CABLE SETS

Adatt./Suitable:

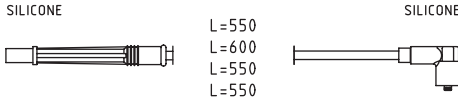
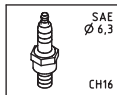
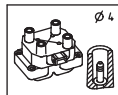
BOSCH
F 000 99C 602**DACIA**
82 00 713 680**NISSAN**
24488-00QAA**RENAULT**
82 00 713 680L=550
L=600
L=550
L=550SAE
ø 6,3
CH16

ø 4

SUPPRESSION CABLE ø 7 mm

DACIA

LOGAN I 1.0	D4D760	12/05 ⇒
LOGAN I 1.2 16V	D4F732	02/06 ⇒
SANDERO I 1.2 16V	D4F732	11/08 ⇒
SANDERO I 1.2 16V LPG	D4F732	11/08 ⇒

NISSAN

KUBISTAR 1.2 16V	D4F712, D4F730	04/06 ⇒
------------------	----------------	---------

RENAULT

CLIO II 1.2 16V	D4F722, D4F728	06/01 ⇒ 08/16
CLIO III 1.2	D4F764	10/05 ⇒ 12/12
CLIO III 1.2 16V	D4F740, D4F744, D4F764	06/05 ⇒
CLIO III 1.2 16V Hi-Flex	D4F740, D4F742	07/08 ⇒ 12/14
CLIO IV 1.2 16V	D4F744	11/12 ⇒
LOGAN 1.0	D4D760	12/05 ⇒
LOGAN 1.2 16V	D4F732	02/06 ⇒
MODUS / GRAND MODUS 1.2	D4F740, D4F742, D4F764	12/04 ⇒
MODUS / GRAND MODUS 1.2 16V Hi-Flex	D4F740	10/08 ⇒
SANDERO I 1.2 16V	D4F732	11/08 ⇒
THALIA I 1.2i 16V	D4F728	04/04 ⇒
TWINGO I 1.2 16V	D4F708	08/04 ⇒ 06/07
TWINGO II 1.2 16V	D4F764, D4F770, D4F772	03/07 ⇒

EPS 1.499.247



07

IGNITION CABLE SETS

Adatt./Suitable:

03 Supplied until depletion

- Fornibile fino ad esaurimento delle scorte
- Fourni jusqu'à épuisement du stock
- Lieferbar solange vorrat reicht
- Suministrado hasta el stock termina

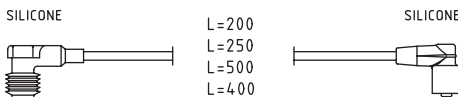
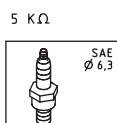
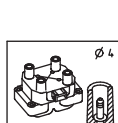
L=200
L=250
L=500
L=400SAE
ø 6,3

ø 4

COPPER CORE CABLE ø 7 mm

CHEVROLET

CAPTIVA 2.4	Z24SED	06/06 ⇒
CAPTIVA 2.4 4WD	Z24SED	06/06 ⇒ 02/11
CAPTIVA 2.4 LPG	Z24SED	01/07 ⇒
CAPTIVA 2.4 LPG 4WD	Z24SED	01/07 ⇒ 02/11

EPS 1.499.248



07

IGNITION CABLE SETS

Adatt./Suitable:

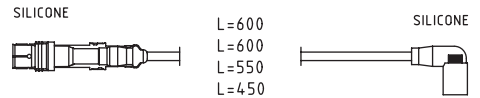
SKODA
03F 905 409 A
03F 905 409 B
03F 905 409 C**VW**
03F 905 409 BL=600
L=600
L=550
L=450

5 KΩ

1 KΩ

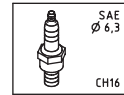
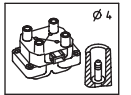
SAE
ø 6,3
CH16

ø 4

COPPER CORE CABLE ø 7 mm

AUDI

A1 1.2 TFSI	CBZA	05/10 ⇒ 04/15
A3 II 1.2 TFSI	CBZB	03/10 ⇒ 05/13
A3 II 1.2 TSI	CBZB	04/10 ⇒ 03/13

SEAT

ALTEA 1.2 TSI	CBZB	04/10 ⇒
ALTEA XL 1.2 TSI	CBZB	04/10 ⇒
IBIZA IV 1.2 TSI	CBZA, CBZB	09/10 ⇒ 05/15
LEON II 1.2 TSI	CBZB	02/10 ⇒ 12/12
TOLEDO IV 1.2 TSI	CBZA, CBZB	07/12 ⇒ 06/15

SKODA

OCTAVIA II 1.2 TSI	CBZB	02/10 ⇒ 06/13
FABIA II 1.2 TSI	CBZA, CBZB	03/10 ⇒ 12/14
YETI 1.2 TSI	CBZB	09/09 ⇒ 05/15

VW

GOLF VI 1.2 TSi	CBZA, CBZB	11/08 ⇒
BEETLE 1.2 TSI	CBZB	07/11 ⇒ 07/19
CADDY III 1.2 TSI	CBZA, CBZB	09/10 ⇒ 05/15
JETTA VI 1.2 TSI	CBZB	10/10 ⇒ 12/17
POLO V 1.2 TSI	CBZB, CBZC	11/09 ⇒
TOURAN I 1.2 TSI	CBZB	05/10 ⇒ 05/15

EPS 1.499.249



07

IGNITION CABLE SETS

Adatt./Suitable:

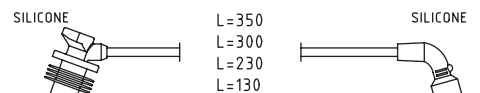
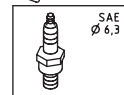
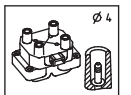
CHEVROLET
25183557
96651945
96984145**GENERAL MOTORS**
25 183 557
96 984 145**HITACHI**
134375L=350
L=300
L=230
L=130SAE
ø 6,3

ø 4

SUPPRESSION CABLE ø 7 mm

CHEVROLET

AVEO I 1.2	B12D1, LMU	01/08 ⇒
AVEO I 1.2 LPG	B12D1, LMU	04/08 ⇒
AVEO I 1.5	LX6	05/05 ⇒
SPARK III 1.0	B10D1	03/10 ⇒
SPARK III 1.0 LPG	B10D1, LMT	03/10 ⇒
SPARK III 1.2	B12D1, LMU, Z12XE	03/10 ⇒
SPARK III 1.2 LPG	B12D1, LMU	03/10 ⇒

EPS 1.499.251

05

IGNITION CABLE SETS

Adatt./Suitable:

HITACHI
134377MITSUBISHI
MD343245

03 Supplied until depletion

- Fornibile fino ad esaurimento delle scorte
- Fourni jusqu'à épuisement du stock
- Lieferbar solange vorrat reicht
- Suministrado hasta el stock termina

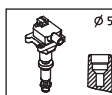
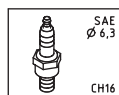
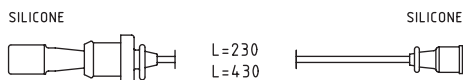
SUPPRESSION CABLE \varnothing 5 mm

MITSUBISHI

LANCER VII 2.0 16V EVO IV	4G63Turbo	08/96 \Rightarrow 06/97
LANCER VII EVO V	4G63Turbo	01/98 \Rightarrow 12/98
LANCER VII EVO VI	4G63Turbo	01/99 \Rightarrow 02/01
LANCER VIII 2.0	4G63(DOHC16V), 4G63-7	09/03 \Rightarrow
OUTLANDER I 2.0	4G63(DOHC16V)	05/03 \Rightarrow 10/06
OUTLANDER I 2.0 4WD	4G63(DOHC16V)	05/03 \Rightarrow 10/06
OUTLANDER I 2.0 Turbo 4WD	4G63-T(DOHC16V)	04/04 \Rightarrow 10/06
OUTLANDER I 2.0 Turbo-R 4WD	4G63Turbo	01/02 \Rightarrow 10/06

EPS 1.499.252

05

IGNITION CABLE SETS

Adatt./Suitable:

BOSCH

0 986 357 256

DACIA

22 44 042 52R
82 00 943 801

RENAULT

82 00 943 801

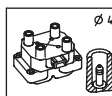
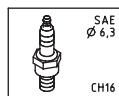
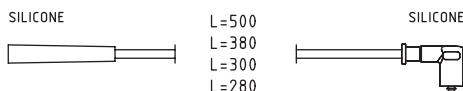
SUPPRESSION CABLE \varnothing 7 mm

DACIA

DOKKER 1.6	K7M812, K7M828	11/12 \Rightarrow
DOKKER 1.6 LPG	K7M812, K7M828	11/13 \Rightarrow
LODGY 1.6	K7M812, K7M828	03/12 \Rightarrow
LODGY 1.6 LPG	K7M812, K7M828	11/13 \Rightarrow
LOGAN I 1.4	K7J710	09/04 \Rightarrow
LOGAN I 1.4 MPI LPG	K7J710	02/06 \Rightarrow 12/12
LOGAN I 1.6	K7M710, K7M714	09/04 \Rightarrow
LOGAN I 1.6 Bifuel	K7M710	11/08 \Rightarrow
LOGAN I 1.6 MPI 85	K7M800	05/10 \Rightarrow
LOGAN II 1.6 16V	K7M764, K7M812	10/12 \Rightarrow
SANDERO I 1.4	K7J710	06/08 \Rightarrow
SANDERO I 1.6	K7M710, K7M718	06/08 \Rightarrow
SANDERO I 1.6 MPI 85	K7M800	05/10 \Rightarrow 06/13
SANDERO II 1.6	K7M812	11/12 \Rightarrow
SANDERO II 1.6 I	K7M764	10/12 \Rightarrow

RENAULT

KANGOO II 1.6	K7M750	02/08 \Rightarrow
LOGAN 1.4	K7J710	09/04 \Rightarrow
LOGAN 1.6	K7M710	09/04 \Rightarrow
LOGAN 1.6 MPI 85	K7M800	05/10 \Rightarrow
SANDERO I 1.4	K7J710	02/09 \Rightarrow

RENAULT

SANDERO I 1.6	K7M710	12/07 \Rightarrow
SANDERO I 1.6 MPI 85	K7M800	05/10 \Rightarrow
THALIA I 1.4	K7J700	05/00 \Rightarrow
THALIA I 1.6	K7M730, K7M734	01/01 \Rightarrow
THALIA II 1.4	K7J700	09/08 \Rightarrow 06/14

EPS 1.499.255

07

IGNITION CABLE SETS

Adatt./Suitable:

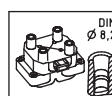
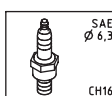
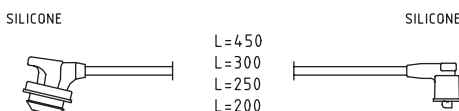
SUPPRESSION CABLE \varnothing 7 mm

HYUNDAI

I20 II 1.2	G4LA	11/14 \Rightarrow
I10 I 1.2	G4LA	11/08 \Rightarrow 12/13
I10 II 1.2	G4LA	12/13 \Rightarrow
I20 I 1.2	G4LA	09/08 \Rightarrow 12/15

EPS 1.500.347

05

IGNITION CABLE SETS

Adatt./Suitable:

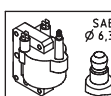
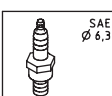
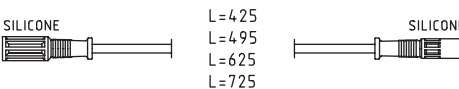
SUPPRESSION CABLE \varnothing 7 mm

FIAT

FIORINO II 1.0 iE	156A2.246	11/92 \Rightarrow 04/96
PALIO 1.1	178B9.033	07/97 \Rightarrow 10/03
PANDA I 1.1	156C.046	05/91 \Rightarrow 03/95
PANDA I 1000	156A2.100, 156A2.100, 156A3.000	01/85 \Rightarrow
PANDA I 1000 4x4	156A2.100, 156A2.246, 156A3.000	01/86 \Rightarrow 12/94
PANDA I 1000 CLX	156A2.000	05/91 \Rightarrow 12/94
PANDA I 1000 Fire	156A2.000	05/86 \Rightarrow 04/91
PANDA I 1000 Fire [CHE]	156A2.146	11/87 \Rightarrow 04/91
PANDA I 1000 Fire [DEU]	156A2.048	01/86 \Rightarrow 07/89
PANDA I 1000 i.e	156A2.246	08/92 \Rightarrow 02/04
PANDA I 1000 i.e. Cat	156A2.246	10/87 \Rightarrow 08/98
PANDA I 1100 Trekking 4x4	156C.046	10/91 \Rightarrow 07/04
PANDA I 750	156A4.000	01/86 \Rightarrow 10/03
PANDA I 750 Cat	156A4.048	01/95 \Rightarrow 10/03
PANDA I 750 Fire	156A4.048	11/88 \Rightarrow 04/91
TIPO I 1.1	160A3.000	01/88 \Rightarrow 10/91
UNO 45 1.0	156A2.000, 156A2.100	06/86 \Rightarrow 12/93
UNO 45 1.0 Fire	--	01/83 \Rightarrow 12/89
UNO 45 i.e. 1.0	156A2.246	10/84 \Rightarrow 10/95
UNO 50 1.1	156C.046	01/90 \Rightarrow 12/93

FIAT

UNO 50 i.e. 1.1	146C3.000	06/92 \Rightarrow 12/93
UNO 60 1.1	160A3.000	04/89 \Rightarrow 12/92
UNO Mondo 1.0	146A2.166	01/98 \Rightarrow
UNO Mondo 1.0 [IND]	146A2.166	01/98 \Rightarrow

LANCIA

Y10 1.0 Fire	156A2.100	06/85 \Rightarrow 06/91
Y10 1.0 Fire Catalytic-Conv	156A2.246	10/87 \Rightarrow 02/92
Y10 1.0 Fire Trazione integrale	156A2.000, 156A2.100	12/86 \Rightarrow 02/90
Y10 1.1 i.e Fire	156C.000	08/89 \Rightarrow 06/92
Y10 1.1 i.e. Fire	156C.046	07/89 \Rightarrow 09/95

EPS 1.500.351

05

IGNITION CABLE SETS

Adatt./Suitable:

FIAT

7619338

03 Supplied until depletion

- Fornibile fino ad esaurimento delle scorte
- Fourni jusqu'à épuisement du stock
- Lieferbar solange vorrat reicht
- Suministrado hasta el stock termina

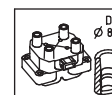
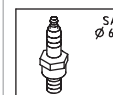
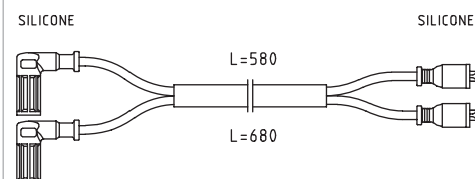
SUPPRESSION CABLE \varnothing 7 mm

FIAT

126 700	126A2.000, 126A2.048	09/87 \Rightarrow 06/96
---------	----------------------	---------------------------

EPS 1.500.354

07

IGNITION CABLE SETS

Adatt./Suitable:

03 Supplied until depletion

- Fornibile fino ad esaurimento delle scorte
- Fourni jusqu'à épuisement du stock
- Lieferbar solange vorrat reicht
- Suministrado hasta el stock termina

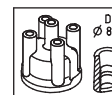
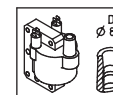
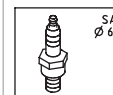
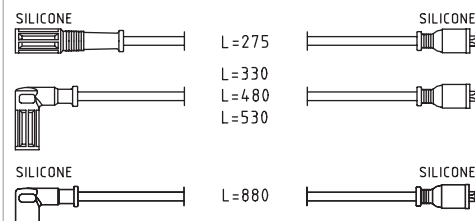
SUPPRESSION CABLE \varnothing 7 mm

FIAT

REGATA 1.1 60, 60 L	138B.000	10/83 \Rightarrow 08/86
REGATA 70 1.3	138B2.000, 149A3.000	09/83 \Rightarrow 07/89
TEMPRA 1.4 i.e.	159A2.000	04/90 \Rightarrow 08/96
TIPO I 1.4	160A1.000	07/87 \Rightarrow 12/89
TIPO I 1.4 i.e.	159A2.000	05/89 \Rightarrow 04/95
UNO 55 1.1	138B.000	01/83 \Rightarrow 08/89
UNO 60 1.1	146A4.048	02/88 \Rightarrow 02/92
UNO 60 1.1 SX	--	01/83 \Rightarrow 12/85
UNO 70 1.3	138B2.000	01/83 \Rightarrow 04/85

LANCIA

DELTA I 1.1	831B8.000	01/86 \Rightarrow 12/90
DELTA I 1.3	1831B.000, 3831B.000, 831A2.000, 831B.000	09/79 \Rightarrow 10/92
DELTA I 1.5	831A1.000, 831B1.000	09/79 \Rightarrow 12/92

LANCIA		
PRISMA 1.3	831A2.000	01/83 ⇒ 12/89

EPS	1.500.372	07,5
------------	------------------	-------------

IGNITION CABLE SETS

Adatt./Suitable:

- 03 Supplied until depletion**
- Fornibile fino ad esaurimento delle scorte
 - Fourni jusqu'à épuisement du stock
 - Lieferbar solange vorrat reicht
 - Suministrado hasta el stock termina

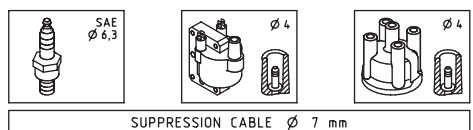
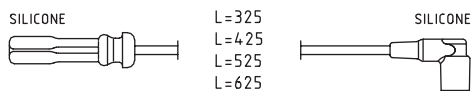

VOLVO		
960 I 2.3	B230GT	08/90 ⇒ 07/94
960 I 2.3 Turbo	B230FT	09/90 ⇒ 08/93
740 2.0	B200E, B200ET, B200G	01/85 ⇒ 07/92
740 2.0 Turbo	B200ET, B200FT	09/87 ⇒ 08/91
740 2.3	B230E, B230F, B230FB, B230G, B230K	08/84 ⇒ 12/92
740 2.3 GL	B230E	08/84 ⇒ 08/87
740 2.3 Turbo	B230ET, B230FT, B230GT	08/85 ⇒ 08/91
760 2.3	B230ET, B230FT, B230K	08/84 ⇒ 07/92
760 2.3 Turbo	B230ET, B230FT, B230GT	08/84 ⇒ 08/90
940 I 2.0	B200E, B200F, B200G	08/90 ⇒ 07/94
940 I 2.0 Turbo	B200FT	08/90 ⇒ 07/95
940 I 2.3	B230E, B230F, B230FB, B230FD, B230G	08/90 ⇒ 07/95
940 I 2.3 Turbo	B230FT	08/90 ⇒ 07/94
940 II 2.0 GLT	B200GT	10/94 ⇒ 05/97
940 II 2.0 Turbo	B200FT	04/96 ⇒ 10/98
940 II 2.3	B230FD, B230GK	08/94 ⇒ 05/97
940 II 2.3 ti	B230FK	01/95 ⇒ 10/98
940 II 2.3 Turbo	B230FT, B230GK	08/94 ⇒ 12/98

EPS	1.500.386	07
------------	------------------	-----------

IGNITION CABLE SETS

Adatt./Suitable:

- 03 Supplied until depletion**
- Fornibile fino ad esaurimento delle scorte
 - Fourni jusqu'à épuisement du stock
 - Lieferbar solange vorrat reicht
 - Suministrado hasta el stock termina

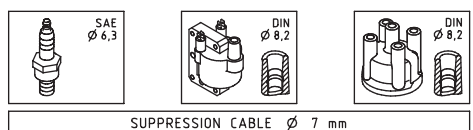
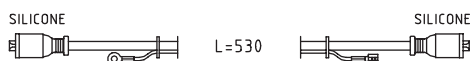
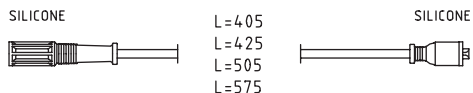

FIAT		
PANDA I 800	100GL6.000	02/81 ⇒ 12/85
PANDA I 950	A112B1.054	09/82 ⇒ 08/83
UNO 45 0.9 Trend	146A.048	09/89 ⇒ 09/92
PEUGEOT		
309 II 1.4	TU3F2	07/91 ⇒ 12/93

EPS	1.500.398	05
------------	------------------	-----------

IGNITION CABLE SETS

Adatt./Suitable:

- 03 Supplied until depletion**
- Fornibile fino ad esaurimento delle scorte
 - Fourni jusqu'à épuisement du stock
 - Lieferbar solange vorrat reicht
 - Suministrado hasta el stock termina

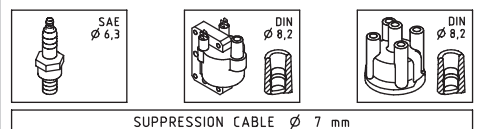
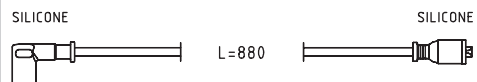
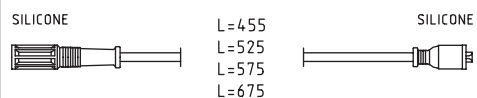

FIAT		
CROMA I 2000 CHT	154A1.000, 154C5.000	01/91 ⇒ 09/92
CROMA I 2000 i.e.	154C3.000, 154C3.046, 834B.048, 834B.146	03/86 ⇒ 12/96
CROMA I 2000 i.e. Turbo	154A2.000, 154C4.000, 154C4.046, 834C.146	12/85 ⇒ 08/96
TEMPRA 1.8 4x4	159A4.000	07/92 ⇒ 06/93
TEMPRA 1.8 i.e.	159A4.000, 159A4.046	03/90 ⇒ 08/96
LANCIA		
DELTA I 1.6 GT i.e.	831B7.000	08/86 ⇒ 08/88
PRISMA 1.6	831B6.000	08/86 ⇒ 02/92
THEMA 2000 i.e	834B1.000	09/88 ⇒ 05/92
THEMA 2000 i.e.	834B.146	09/87 ⇒ 05/92
THEMA 2000 i.e. Turbo	834C.146	07/86 ⇒ 05/90
THEMA 2000 Turbo	834C.146	12/88 ⇒ 03/92

EPS	1.500.415	07
------------	------------------	-----------

IGNITION CABLE SETS

Adatt./Suitable:

- 00 Eliminated on 22-02-2021. Please verify the availability through our local distributors**
- Eliminato il 22-02-2021. Verificare la disponibilità presso i nostri distributori
 - Éliminé le 22-02-2021. Vérifier la disponibilité auprès de nos distributeurs sur place
 - Am 22-02-2021 gestrichen. Evtl. Verfügbarkeit bitte bei unseren Händlern prüfen
 - Eliminado en fecha 22-02-2021. Verificar la disponibilidad a través de nuestros distribuidores locales

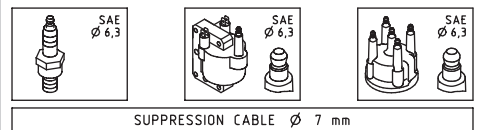
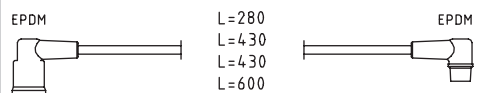

RENAULT		
19 I 1.7	F3N746	08/88 ⇒ 12/92
19 II 1.7	F3N743, F3N746	04/92 ⇒ 12/95
CLIO I 1.7	F2N770	01/91 ⇒ 12/93
VOLVO		
440 1.6	B16F	09/88 ⇒ 12/96
440 1.7	B18E, B18EP, B18F, B18FP, B18K, B18KD, B18KP, B18KPD	08/88 ⇒ 12/96

VOLVO		
440 1.8	B18U	08/91 ⇒ 12/96
440 2.0	B20F	08/92 ⇒ 07/96
460 1.6	B16F	07/92 ⇒ 07/96
460 1.7	B18EP, B18FP, B18K, B18KD, B18KP	09/88 ⇒ 07/96
460 1.8	B18U	08/91 ⇒ 07/96
460 2.0	B20F	08/92 ⇒ 07/96
480 1.7	B18E, B18ED, B18EP, B18F, B18FP	04/86 ⇒ 07/96
480 2.0	B20F	08/92 ⇒ 09/95

EPS	1.500.417	07
------------	------------------	-----------

IGNITION CABLE SETS

Adatt./Suitable:

- 00 Eliminated on 14-04-2020. Please verify the availability through our local distributors**
- Eliminato il 14-04-2020. Verificare la disponibilità presso i nostri distributori
 - Éliminé le 14-04-2020. Vérifier la disponibilité auprès de nos distributeurs sur place
 - Am 14-04-2020 gestrichen. Evtl. Verfügbarkeit bitte bei unseren Händlern prüfen
 - Eliminado en fecha 14-04-2020. Verificar la disponibilidad a través de nuestros distribuidores locales

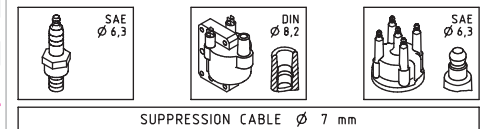
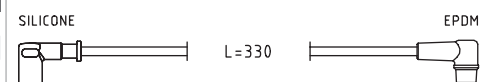
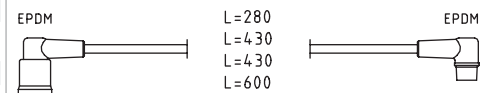

VOLVO		
440 1.7 Turbo	B18FT	08/88 ⇒ 12/96
460 1.7 Turbo	B18FT	08/89 ⇒ 07/96
480 1.7 Turbo	B18FT	08/87 ⇒ 07/96

1.500.429

EPS 1.500.429



IGNITION CABLE SETS

Adatt./Suitable:

FIAT
4261590

00 Eliminated on 18-11-2019. Please verify the availability through our local distributors

- Eliminato il 18-11-2019. Verificare la disponibilità presso i nostri distributori
- Éliminé le 18-11-2019. Vérifier la disponibilité auprès de nos distributeurs sur place
- Am 18-11-2019 gestrichen. Evtl. Verfügbarkeit bitte bei unseren Händlern prüfen
- Eliminado en fecha 18-11-2019. Verificar la disponibilidad a través de nuestros distribuidores locales

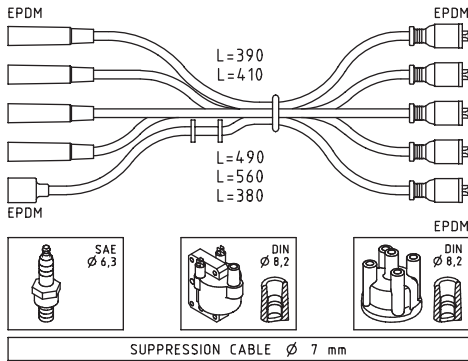

FIAT		
127 0.9	100GL.000, 100GL.048	06/71 \Rightarrow 12/84

EPS 1.500.432



IGNITION CABLE SETS

Adatt./Suitable:

FIAT
7540530
MAGNETI MARELLI
941094040575

03 Supplied until depletion

- Fornibile fino ad esaurimento delle scorte
- Fourni jusqu'à épuisement du stock
- Lieferbar solange vorrat reicht
- Suministrado hasta el stock termina

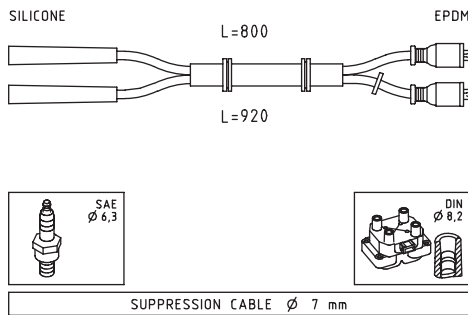

FIAT		
126 650	126A1.048	07/77 \Rightarrow 09/87

EPS 1.500.456



IGNITION CABLE SETS

Adatt./Suitable:

BOSCH
0 986 356 709

FIAT
7625943
7742689

LANCIA
7625943
7742689

00 Eliminated on 19-01-2021. Please verify the availability through our local distributors

- Eliminato il 19-01-2021. Verificare la disponibilità presso i nostri distributori
- Éliminé le 19-01-2021. Vérifier la disponibilité auprès de nos distributeurs sur place
- Am 19-01-2021 gestrichen. Evtl. Verfügbarkeit bitte bei unseren Händlern prüfen
- Eliminado en fecha 19-01-2021. Verificar la disponibilidad a través de nuestros distribuidores locales

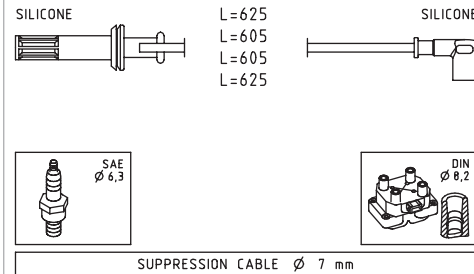

FIAT		
COUPE 2.0 16V Turbo	175A1.000	11/93 \Rightarrow 08/96

LANCIA		
DELTA II 2.0 16V Turbo	175A4.000, 836A2.000	06/93 \Rightarrow 08/99
THEMA 2000 16V Turbo	834C1.000	12/88 \Rightarrow 06/90
THEMA 2000 i.e. 16V	834B2.000, 834B2.246	05/88 \Rightarrow 08/92
THEMA 2000 i.e. 16V Turbo	834C1.000, 834C1.246	12/88 \Rightarrow 03/93

EPS 1.500.466



IGNITION CABLE SETS

Adatt./Suitable:

03 Supplied until depletion

- Fornibile fino ad esaurimento delle scorte
- Fourni jusqu'à épuisement du stock
- Lieferbar solange vorrat reicht
- Suministrado hasta el stock termina

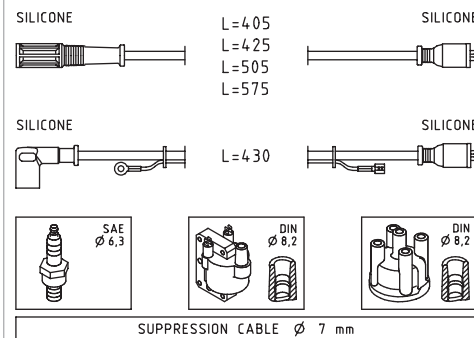

FIAT		
PANDA I 750	141B.000	01/86 \Rightarrow 01/95
PANDA I 900	100GL3.000	10/80 \Rightarrow 06/94
PANDA I 900 CL	146A.048	01/86 \Rightarrow 12/92

EPS 1.500.471



IGNITION CABLE SETS

Adatt./Suitable:

03 Supplied until depletion

- Fornibile fino ad esaurimento delle scorte
- Fourni jusqu'à épuisement du stock
- Lieferbar solange vorrat reicht
- Suministrado hasta el stock termina

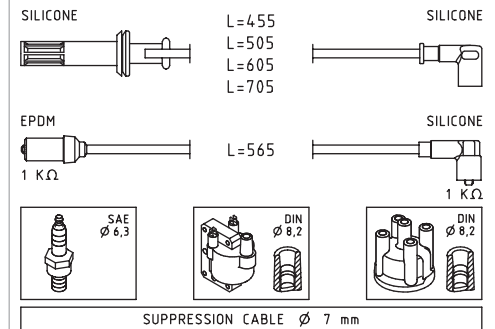

LANCIA		
DELTA I 2.0 16V HF Evo Integrale	831E5.000	06/93 \Rightarrow 01/94
DELTA I 2.0 16V HF Integrale	831D5.000	03/89 \Rightarrow 09/91
DELTA I 2.0 HF Integrale	831C5.046	12/86 \Rightarrow 12/92

EPS 1.500.491



IGNITION CABLE SETS

Adatt./Suitable:

BOSCH
0 986 356 820

CITROËN
5967 K9
96 070 995

MAGNETI MARELLI
941318111091

PEUGEOT
5967 K9

00 Eliminated on 06-09-2021. Please verify the availability through our local distributors

- Eliminato il 06-09-2021. Verificare la disponibilità presso i nostri distributori
- Éliminé le 06-09-2021. Vérifier la disponibilité auprès de nos distributeurs sur place
- Am 06-09-2021 gestrichen. Evtl. Verfügbarkeit bitte bei unseren Händlern prüfen
- Eliminado en fecha 06-09-2021. Verificar la disponibilidad a través de nuestros distribuidores locales

03 Supplied until depletion

- Fornibile fino ad esaurimento delle scorte
- Fourni jusqu'à épuisement du stock
- Lieferbar solange vorrat reicht
- Suministrado hasta el stock termina

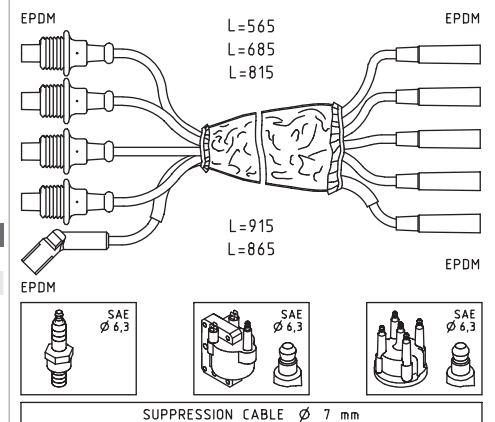

CITROËN		
BX 1.6	182A, B6D, B6E	01/87 \Rightarrow 12/94
BX 16	180Z	03/86 \Rightarrow 12/94
ZX 1.9	D6E(XU9JA)	03/91 \Rightarrow 06/97
ZX 1.9 i	DKZ(XU9JA), XU9JA	03/91 \Rightarrow 06/97

PEUGEOT		
205 I 1.6 GTI	B6D(XU5JA)	02/83 \Rightarrow 07/87
205 II 1.6 GTI	XU5JA	01/91 \Rightarrow 12/94

PEUGEOT		
205 II 1.9 GTI	D6B(XU9JA), DKZ(XU9JAZ)	10/87 ⇒ 09/98
309 II 1.6	XU5JA	07/89 ⇒ 12/93
309 II 1.6 GTi	--	09/89 ⇒ 10/93
309 II 1.9 GTI	DKZ(XU9JAZ)	07/89 ⇒ 12/93

EPS **1.500.493** 

IGNITION CABLE SETS

Adatt./Suitable:

- 03 Supplied until depletion**
- Fornibile fino ad esaurimento delle scorte
 - Fourni jusqu'à épuisement du stock
 - Lieferbar solange vorrat reicht
 - Suministrado hasta el stock termina

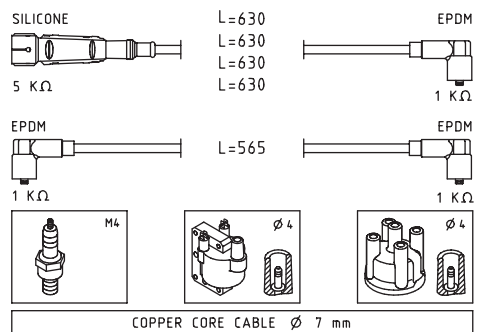

VW		
POLO II 1.0	AAK, GL, HZ	10/81 ⇒ 09/94
POLO II 1.0 Cat	AAK	08/89 ⇒ 09/94
POLO II 1.1	HB	10/81 ⇒ 09/89
POLO II 1.3	GK, GT, HH, HJ, HK, HW, MH	10/81 ⇒ 09/89
POLO II 1.3 Cat	ZG, MH, NZ	07/87 ⇒ 09/94
POLO II 1.3 G40	PY	01/87 ⇒ 08/90
JETTA II 1.0	HZ	08/85 ⇒ 10/91
JETTA II 1.3	GT, HK, MH	01/84 ⇒ 06/87
JETTA II 1.3 Cat	ZG, MH, NZ	06/87 ⇒ 12/91
GOLF II 1.0	HZ	08/85 ⇒ 10/91
GOLF II 1.3	GT, HK, MH	08/83 ⇒ 06/87
GOLF II 1.3 Cat	ZG, NZ	06/86 ⇒ 12/92
GOLF III 1.4	ABD	10/91 ⇒ 04/99
GOLF III 1.6	ABU	09/92 ⇒ 08/97
SCIROCCO II 1.3	HK	08/83 ⇒ 07/84
VENTO 1.4	ABD	11/91 ⇒ 09/98

EPS **1.500.494** 

IGNITION CABLE SETS

Adatt./Suitable:

- BOSCH**
0 986 356 727
0 986 357 098
- CITROËN**
5967 L1
5967 L6
5967 L8
5967 N1
96 088 851
96 099 749
96 161 266
- FIAT**
9617237080
- HITACHI**
134432
- MAGNETI MARELLI**
941085180570
- PEUGEOT**
5967 L1
5967 L6
5967 L8
5967 N1
- 03 Supplied until depletion**
- Fornibile fino ad esaurimento delle scorte
 - Fourni jusqu'à épuisement du stock
 - Lieferbar solange vorrat reicht
 - Suministrado hasta el stock termina

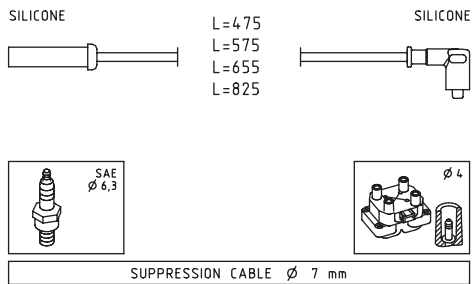

CITROËN		
XANTIA I 2.0	RFX(XU10J2C/ZL3)	03/93 ⇒ 05/95
XANTIA I 2.0 i	RFX(XU10J2C)	03/93 ⇒ 04/03
XANTIA I 2.0 Turbo	RGX(XU10J2TE)	06/95 ⇒ 04/03
EVASION 2.0	RFU(XU10J2/C)	06/94 ⇒ 07/02
EVASION 2.0 Turbo C.T.	RGX(XU10J2TE)	06/94 ⇒ 07/02
XM I 2.0 i	RDZ(XU10MZ), RFZ(XU10J2)	05/89 ⇒ 06/94
XM I 2.0 i Turbo	RGY(XU10J2TE/Z)	09/92 ⇒ 06/94
XM I 2.0 Turbo	RGY(XU10J2TE/Z)	09/92 ⇒ 04/94
XANTIA II 2.0 i	RFX(XU10J2C)	01/98 ⇒ 04/03
XANTIA II 2.0 Turbo	RGX(XU10J2TE)	01/98 ⇒ 04/03
XM II 2.0	XU10J2	08/94 ⇒ 07/99
XM II 2.0 Turbo	RGX(XU10J2TE), RGY(XU10J2TE/Z)	05/94 ⇒ 10/00
ZX 2.0	RFX(XU10J2C)	07/94 ⇒ 10/97
ZX 2.0 i	RFX(XU10J2C), XU10J2	07/92 ⇒ 10/97

FIAT		
ULYSSE I 2.0	RFU(XU10J2C)	06/94 ⇒ 08/02
ULYSSE I 2.0 Turbo	RGX(XU10J2CTE)	06/94 ⇒ 08/02

PEUGEOT		
306 2.0	RFX(XU10J2)	03/94 ⇒ 04/02
306 2.0 ST	RFX(XU10J2)	07/94 ⇒ 05/01
306 2.0 XSi	RFX(XU10J2)	05/93 ⇒ 05/01
405 II 2.0	RFX(XU10J2)	08/92 ⇒ 10/96
405 II 2.0 4x4	RFX(XU10J2)	08/92 ⇒ 10/96
405 II 2.0 X4	RFX(XU10J2)	08/92 ⇒ 10/95
406 2.0 Turbo	RGX(XU10J2TE)	04/96 ⇒ 10/04
605 2.0	RFZ(XU10J2Z)	06/89 ⇒ 09/99
605 2.0 Turbo	RGX(XU10J2TE), RGY(XU10J2TE)	07/91 ⇒ 09/99
806 2.0	RFU(XU10J2)	06/94 ⇒ 08/02
806 2.0 Turbo	RGX(XU10J2TE)	06/94 ⇒ 08/02

EPS **1.500.507** 

IGNITION CABLE SETS

Adatt./Suitable:

- FIAT**
4380722
4830772
5888330
- MAGNETI MARELLI**
941094060576
- 03 Supplied until depletion**
- Fornibile fino ad esaurimento delle scorte
 - Fourni jusqu'à épuisement du stock
 - Lieferbar solange vorrat reicht
 - Suministrado hasta el stock termina

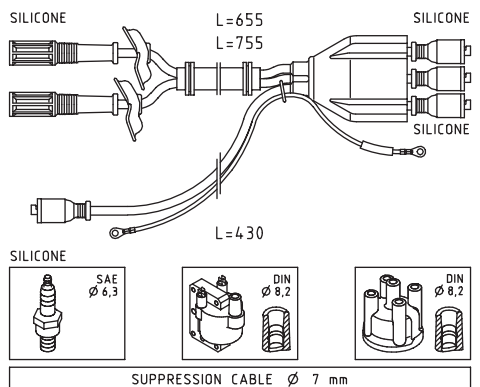

FIAT		
126 600	126A.000	09/72 ⇒ 06/77

EPS **1.500.509** 

IGNITION CABLE SETS

Adatt./Suitable:

- BOSCH**
0 986 356 862
- GENERAL MOTORS**
90 113 411
- MAGNETI MARELLI**
941125070664
- OPEL**
16 12 434
- 03 Supplied until depletion**
- Fornibile fino ad esaurimento delle scorte
 - Fourni jusqu'à épuisement du stock
 - Lieferbar solange vorrat reicht
 - Suministrado hasta el stock termina

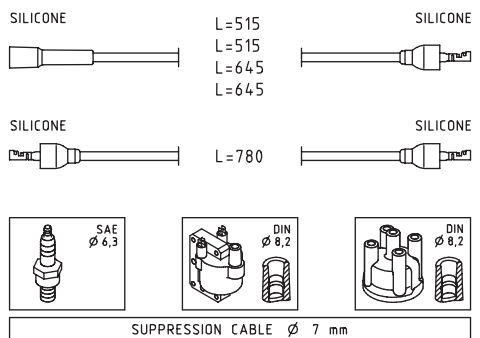

OPEL		
CORSA A 1.0	10S	09/82 ⇒ 03/93
CORSA A 1.2	12N, 12NC, E12GV	09/82 ⇒ 08/90
CORSA A 1.2 N	12NC, E12GV	01/85 ⇒ 10/87
KADETT E 1.2	12SC	09/84 ⇒ 07/86

EPS 1.500.511



07

IGNITION CABLE SETS

Adatt./Suitable:

00 Eliminated on 22-02-2022. Please verify the availability through our local distributors

- Eliminato il 22-02-2022. Verificare la disponibilità presso i nostri distributori
- Éliminé le 22-02-2022. Vérifier la disponibilité auprès de nos distributeurs sur place
- Am 22-02-2022 gestrichen. Evtl. Verfügbarkeit bitte bei unseren Händlern prüfen
- Eliminado en fecha 22-02-2022. Verificar la disponibilidad a través de nuestros distribuidores locales

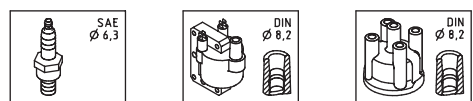
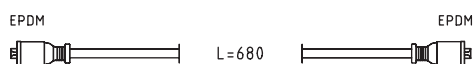
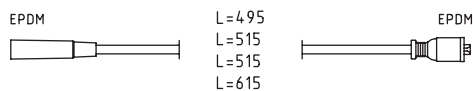

SUPPRESSION CABLE Ø 7 mm

DACIA		
ARO 10	--	01/72 ⇔ 12/80
LADA		
LADA 1.2	--	01/80 ⇔
LADA 1.3	--	01/80 ⇔
LADA 1.5	--	01/80 ⇔
NIVA I 1600	BA32121	12/76 ⇔ 12/93

EPS 1.500.513



07

IGNITION CABLE SETS

Adatt./Suitable:

BOSCH

0 986 356 723

GENERAL MOTORS

90 369 758

90 398 586

90 442 448

OPEL

16 12 523

16 12 527

16 12 532

16 12 545

00 Eliminated on 14-04-2020. Please verify the availability through our local distributors

- Eliminato il 14-04-2020. Verificare la disponibilità presso i nostri distributori
- Éliminé le 14-04-2020. Vérifier la disponibilité auprès de nos distributeurs sur place
- Am 14-04-2020 gestrichen. Evtl. Verfügbarkeit bitte bei unseren Händlern prüfen
- Eliminado en fecha 14-04-2020. Verificar la disponibilidad a través de nuestros distribuidores locales

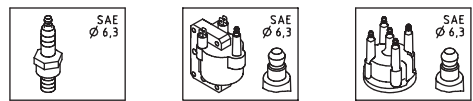
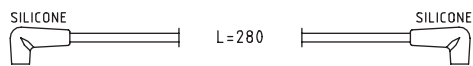
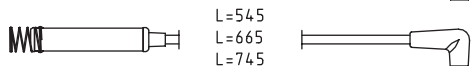
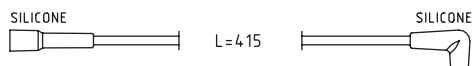

SUPPRESSION CABLE Ø 7 mm

OPEL		
VECTRA A 1.6 i	C16NZ, E16NZ	09/88 ⇔ 11/95
VECTRA A 1.6 i Cat	C16NZ	09/88 ⇔ 11/95

EPS 1.500.514



07

IGNITION CABLE SETS

Adatt./Suitable:

BOSCH

0 986 356 723

GENERAL MOTORS

90 008 241

90 297 570

90 398 282

90 442 051

90 442 405

HITACHI

134202

MAGNETI MARELLI

941 125 180672

OPEL

16 12 459

16 12 479

16 12 524

16 12 539

16 12 542

00 Supplied until depletion

- Fornibile fino ad esaurimento delle scorte
- Fourni jusqu'à épuisement du stock
- Lieferbar solange vorrat reicht
- Suministrado hasta el stock termina

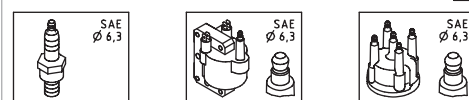
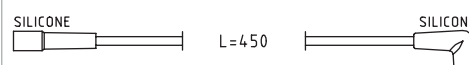
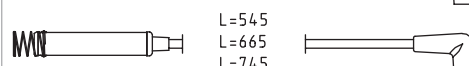
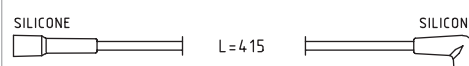

SUPPRESSION CABLE Ø 7 mm

OPEL		
ASCONA C 1.3 N	13N	09/81 ⇔ 08/86
ASCONA C 1.3 S	13S	09/81 ⇔ 08/88
ASCONA C 1.6	16SV	09/86 ⇔ 08/88
ASTRA F 1.6 i	C16NZ	09/91 ⇔ 09/98
CORSA A 1.6 GSI	C16NZ	08/88 ⇔ 09/92
KADETT D 1.2	12ST	08/82 ⇔ 08/84
KADETT E 1.2	12ST	09/84 ⇔ 08/88
KADETT E 1.3 i Cat	C13N	09/85 ⇔ 08/91
KADETT E 1.3 N	13N, 13NB	09/84 ⇔ 08/91
KADETT E 1.3 S	13S	09/84 ⇔ 02/93
KADETT E 1.6	16SV	09/86 ⇔ 12/91
KADETT E 1.6 i	16SV, C16NZ, E16NZ	09/86 ⇔ 07/94
KADETT E 1.6 i Cat	C16LZ, C16NZ	09/86 ⇔ 02/93
KADETT E 1.6 S	16SV	09/86 ⇔ 08/91
VECTRA A 1.6	16SV	09/88 ⇔ 05/93
VECTRA A 1.6 S	16SV	09/88 ⇔ 05/93
VAUXHALL		
ASTRA III 1.6 i	C16NZ	09/91 ⇔ 12/98
ASTRAVAN I 1.6 i	C16NZ	10/91 ⇔ 08/98

EPS 1.500.527



07

IGNITION CABLE SETS

Adatt./Suitable:

BOSCH

0 986 356 850

GENERAL MOTORS

90 350 555

90 442 064

OPEL

16 12 497

16 12 531

00 Eliminated on 22-02-2022. Please verify the availability through our local distributors

- Eliminato il 22-02-2022. Verificare la disponibilità presso i nostri distributori
- Éliminé le 22-02-2022. Vérifier la disponibilité auprès de nos distributeurs sur place
- Am 22-02-2022 gestrichen. Evtl. Verfügbarkeit bitte bei unseren Händlern prüfen
- Eliminado en fecha 22-02-2022. Verificar la disponibilidad a través de nuestros distribuidores locales

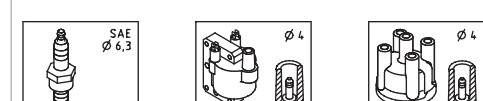
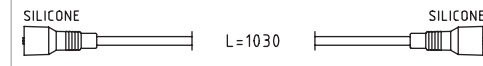
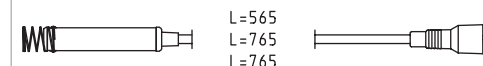
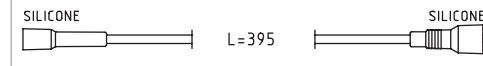

SUPPRESSION CABLE Ø 7 mm

OPEL		
FRONTERA A 2.0 i	C20NE	03/92 ⇔ 10/98
OMEGA A 1.8	18SEH, E18NVR, S18NV	09/86 ⇔ 03/94
OMEGA A 1.8 N	18NV	09/86 ⇔ 08/87
OMEGA A 1.8 S	18SV	09/86 ⇔ 03/94
OMEGA A 2.0	20SE, C20NE	09/86 ⇔ 04/94
OMEGA A 2.0 i	C20NE	09/86 ⇔ 04/94
OMEGA B 2.0	20SE	03/94 ⇔ 12/00
VAUXHALL		
FRONTERA A 2.0	C20NE	04/95 ⇔ 08/98
FRONTERA A 2.0 i	C20NE	03/92 ⇔ 10/98
OMEGA B 2.0	20SE	09/95 ⇔ 09/96

EPS 1.500.539



07

IGNITION CABLE SETS

Adatt./Suitable:

00 Eliminated on 14-02-2022. Please verify the availability through our local distributors

- Eliminato il 14-02-2022. Verificare la disponibilità presso i nostri distributori
- Éliminé le 14-02-2022. Vérifier la disponibilité auprès de nos distributeurs sur place
- Am 14-02-2022 gestrichen. Evtl. Verfügbarkeit bitte bei unseren Händlern prüfen
- Eliminado en fecha 14-02-2022. Verificar la disponibilidad a través de nuestros distribuidores locales

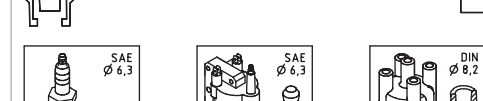
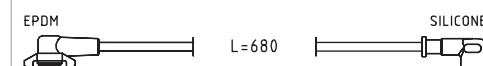
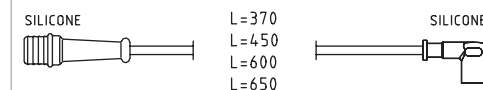

SUPPRESSION CABLE Ø 7 mm

RENAULT		
21 2.0	14ZR, J6R758, J6R793, J7R747, J7R750, J7R751	03/86 ⇔ 12/93
21 2.0 4x4	14ZR, J7R747	03/89 ⇔ 12/93

RENAULT		
21 2.0 Turbo	J7R752	04/87 ⇒ 03/90
21 2.0 Turbo 4x4	J7R752	08/89 ⇒ 10/93
21 2.2	J6T790, J6T791, J7T754, J7T755, J7T756	03/86 ⇒ 12/95
21 2.2 4x4	J7T754, J7T755	06/86 ⇒ 06/94
25 2.0	J7R722, J7R723	03/87 ⇒ 12/93
25 2.0 12V	7CYQD80D-E3, J7R721	06/88 ⇒ 12/93
25 2.2	04TNV88-C, 74G69-S4M, J7T706, J7T707, J7T708, J7T715, J7T730, J7T731, J7T732	04/84 ⇒ 12/92
ESPACE I 2.0 i	J7R760	01/89 ⇒ 12/90
ESPACE I 2.0 i Quadra	J7R760	03/88 ⇒ 12/92
ESPACE I 2.2	2QG15DE	07/86 ⇒ 12/90
ESPACE I 2.2 Quadra	2QG15DE	01/88 ⇒ 12/90
ESPACE II 2.0	J7R768	01/91 ⇒ 10/96
ESPACE II 2.2	J7T773, J7T776	01/91 ⇒ 10/96
ESPACE II 2.2 4x4	J7T773	03/91 ⇒ 12/96
TRAFIC I 2.2	J7T600, J7T780	05/89 ⇒ 04/98
TRAFIC I 2.2 4x4	J7T600, J7T780	05/89 ⇒ 04/98

EPS **1.500.543** **07**

IGNITION CABLE SETS

Adatt./Suitable:

00 Eliminated on 14-02-2022. Please verify the availability through our local distributors

- Eliminato il 14-02-2022. Verificare la disponibilità presso i nostri distributori
- Éliminé le 14-02-2022. Vérifier la disponibilité auprès de nos distributeurs sur place
- Am 14-02-2022 gestrichen. Evtl. Verfügbarkeit bitte bei unseren Händlern prüfen
- Eliminado en fecha 14-02-2022. Verificar la disponibilidad a través de nuestros distribuidores locales

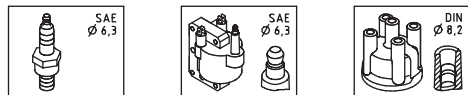
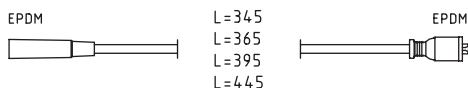

SUPPRESSION CABLE Ø 7 mm

RENAULT		
19 I 1.2	C1G730	01/88 ⇒ 12/92
EXPRESS 1.2	C1G	01/85 ⇒ 10/90
EXPRESS 1.4	C1J, C2J	01/85 ⇒ 10/90
EXPRESS 1.4i	C3G/C3J	01/85 ⇒ 10/90

EPS **1.500.572** **07,5**

IGNITION CABLE SETS

Adatt./Suitable:

BMW
12 12 1 705 697
BOSCH
0 356 901 808

00 Eliminated on 02-03-2020. Please verify the availability through our local distributors

- Eliminato il 02-03-2020. Verificare la disponibilità presso i nostri distributori
- Éliminé le 02-03-2020. Vérifier la disponibilité auprès de nos distributeurs sur place
- Am 02-03-2020 gestrichen. Evtl. Verfügbarkeit bitte bei unseren Händlern prüfen
- Eliminado en fecha 02-03-2020. Verificar la disponibilidad a través de nuestros distribuidores locales

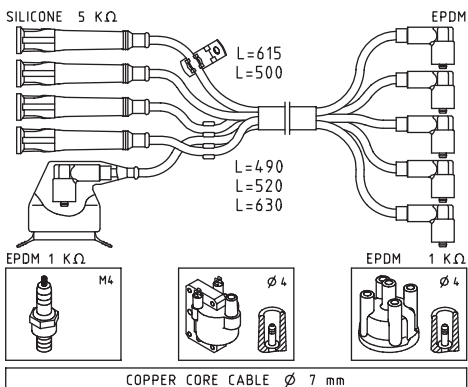

COPPER CORE CABLE Ø 7 mm

BMW		
3 II 316	M10B18(184VC), M10B18(184VD)	09/83 ⇒ 06/88
3 II 316 i	M10B18(184KA)	08/87 ⇒ 08/88
3 II 318 i	M10B18(184EA), M10B18(184KA)	09/82 ⇒ 08/88
5 II 518	M10B18(184VC), M10B18(184VD)	06/81 ⇒ 09/84
5 II 518 i	M10B18(184EB)	05/81 ⇒ 12/87
5 I 518	M10B18(184VB)	07/74 ⇒ 05/81

EPS **1.500.573**

IGNITION CABLE SETS

Adatt./Suitable:

BMW
12 12 1 717 646
12 12 1 727 686
BOSCH
0 986 356 325

00 Eliminated on 14-04-2020. Please verify the availability through our local distributors

- Eliminato il 14-04-2020. Verificare la disponibilità presso i nostri distributori
- Éliminé le 14-04-2020. Vérifier la disponibilité auprès de nos distributeurs sur place
- Am 14-04-2020 gestrichen. Evtl. Verfügbarkeit bitte bei unseren Händlern prüfen
- Eliminado en fecha 14-04-2020. Verificar la disponibilidad a través de nuestros distribuidores locales

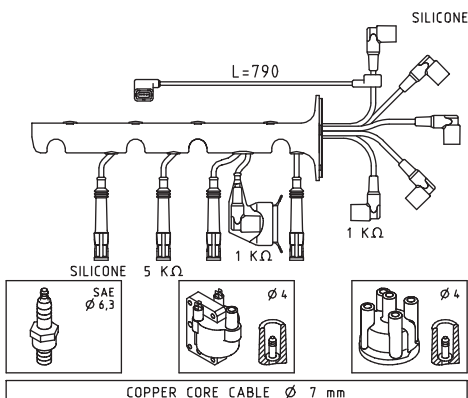

COPPER CORE CABLE Ø 7 mm

BMW		
3 II 316 i	M40B16(164E1)	09/87 ⇒ 06/94
3 II 318 i	M40B18(184E1)	06/87 ⇒ 06/94

EPS **1.500.578**

IGNITION CABLE SETS

Adatt./Suitable:

BMW
12 12 1 722 253
BOSCH
0 356 901 814

00 Eliminated on 22-02-2022. Please verify the availability through our local distributors

- Eliminato il 22-02-2022. Verificare la disponibilità presso i nostri distributori
- Éliminé le 22-02-2022. Vérifier la disponibilité auprès de nos distributeurs sur place
- Am 22-02-2022 gestrichen. Evtl. Verfügbarkeit bitte bei unseren Händlern prüfen
- Eliminado en fecha 22-02-2022. Verificar la disponibilidad a través de nuestros distribuidores locales

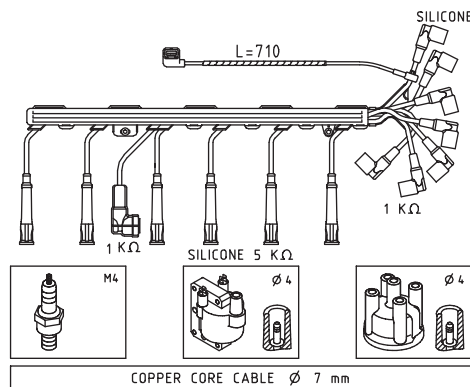

COPPER CORE CABLE Ø 7 mm

BMW		
5 II 530 i	--	01/84 ⇒ 12/88
5 III 530 i	M30B30(306KA)	01/88 ⇒ 04/90
5 III 535 i	M30B34(346KB)	11/87 ⇒ 02/93
7 II 730 i, iL	M30B30(306EA), M30B30(306KA)	03/85 ⇒ 03/94
7 II 735 i, iL	M30B34(346KB), M30B35(Motronic, 9.2:1)	06/86 ⇒ 07/92

EPS **1.500.587**

IGNITION CABLE SETS

Adatt./Suitable:

BMW
12 12 1 720 529
BOSCH
0 986 356 323

00 Eliminated on 14-04-2020. Please verify the availability through our local distributors

- Eliminato il 14-04-2020. Verificare la disponibilità presso i nostri distributori
- Éliminé le 14-04-2020. Vérifier la disponibilité auprès de nos distributeurs sur place
- Am 14-04-2020 gestrichen. Evtl. Verfügbarkeit bitte bei unseren Händlern prüfen
- Eliminado en fecha 14-04-2020. Verificar la disponibilidad a través de nuestros distribuidores locales

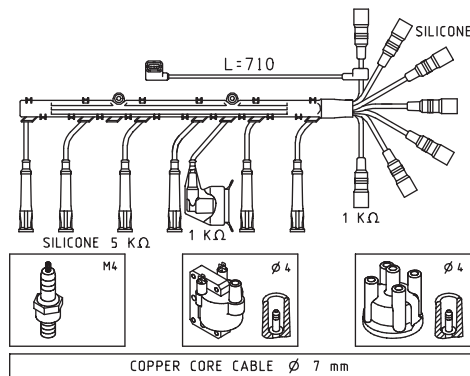

COPPER CORE CABLE Ø 7 mm

BMW		
3 II 320 i	M20B20(206EB), M20B20(206KA)	09/82 ⇒ 11/93
3 II 325 i	M20B25(256E1), M20B25(256E2), M20B25(256EX), M20B25(256K1)	09/83 ⇒ 11/93

1.500.597

EPS 1.500.597



IGNITION CABLE SETS

Adatt./Suitable:

BMW
12 12 1 726 037
BOSCH
0 356 901 819
0 986 356 362

⁰³ Supplied until depletion

- Fornibile fino ad esaurimento delle scorte
- Fourni jusqu'à épuisement du stock
- Lieferbar solange vorrat reicht
- Suministrado hasta el stock termina

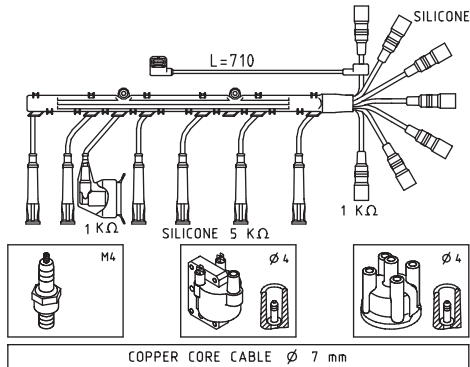
**BMW**

3 III 320 i	M20B20(206EB), M20B20(206KA)	09/82 \Rightarrow 11/93
3 III 325 i	M20B25(256E1), M20B25(256E2), M20B25(256EX), M20B25(256K1)	09/83 \Rightarrow 11/93
5 III 520 i	M20B20(206KA)	06/87 \Rightarrow 09/90
5 III 525 i	M20B25(256K1)	02/88 \Rightarrow 08/90

EPS 1.500.605



IGNITION CABLE SETS

Adatt./Suitable:

BMW
12 12 1 727 855
BOSCH
0 986 356 325

⁰³ Supplied until depletion

- Fornibile fino ad esaurimento delle scorte
- Fourni jusqu'à épuisement du stock
- Lieferbar solange vorrat reicht
- Suministrado hasta el stock termina

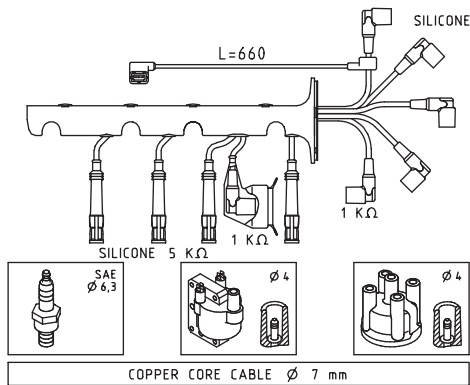
**BMW**

3 III 316 i	M40B16(164E1), M43B16(164E2)	09/90 \Rightarrow 09/93
3 III 318 i	M40B18(184E1)	09/90 \Rightarrow 08/93

EPS 1.500.608



07,5

IGNITION CABLE SETS

Adatt./Suitable:

BOSCH
0 986 356 705
HITACHI
134276
NISSAN
22440-99B00
22440-99B05
22440-99B06

⁰³ Supplied until depletion

- Fornibile fino ad esaurimento delle scorte
- Fourni jusqu'à épuisement du stock
- Lieferbar solange vorrat reicht
- Suministrado hasta el stock termina

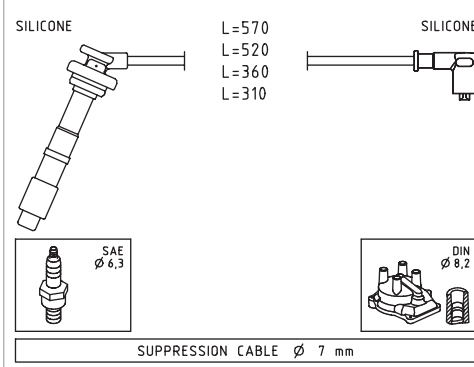
**NISSAN**

MICRA II 1.0 i 16V	CG10DE	08/92 \Rightarrow 07/00
MICRA II 1.3 i 16V	CG13DE	08/92 \Rightarrow 09/00

EPS 1.500.609



08

IGNITION CABLE SETS

Adatt./Suitable:

NISSAN
22450-71J25

⁰⁰ Eliminated on 14-04-2020. Please verify the availability through our local distributors

- Eliminato il 14-04-2020. Verificare la disponibilità presso i nostri distributori
- Éliminé le 14-04-2020. Vérifier la disponibilité auprès de nos distributeurs sur place
- Am 14-04-2020 gestrichen. Evtl. Verfügbarkeit bitte bei unseren Händlern prüfen
- Eliminado en fecha 14-04-2020. Verificar la disponibilidad a través de nuestros distribuidores locales

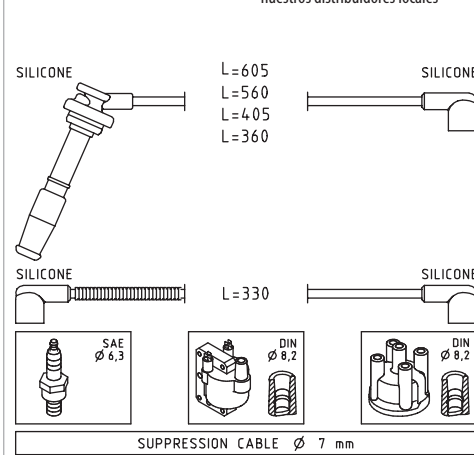
**NISSAN**

PRIMERA I 1.6	GA16DS	06/90 \Rightarrow 01/96
---------------	--------	---------------------------

EPS 1.500.612



07

IGNITION CABLE SETS

Adatt./Suitable:

⁰⁰ Eliminated on 22-02-2022. Please verify the availability through our local distributors

- Eliminato il 22-02-2022. Verificare la disponibilità presso i nostri distributori
- Éliminé le 22-02-2022. Vérifier la disponibilité auprès de nos distributeurs sur place
- Am 22-02-2022 gestrichen. Evtl. Verfügbarkeit bitte bei unseren Händlern prüfen
- Eliminado en fecha 22-02-2022. Verificar la disponibilidad a través de nuestros distribuidores locales

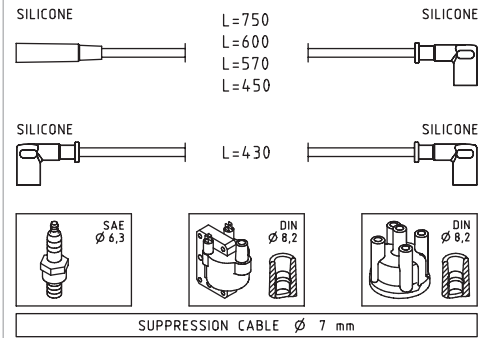
**SEAT**

IBIZA I 1.2	021A1000	11/84 \Rightarrow 12/93
IBIZA I 1.2 i	021C.1000	01/89 \Rightarrow 05/93
IBIZA I 1.5 i	021B.2000	10/86 \Rightarrow 05/93
MALAGA 1.2	021A1000	05/85 \Rightarrow 12/93
MALAGA 1.5	021A2000	05/85 \Rightarrow 12/93

EPS 1.500.613



07

IGNITION CABLE SETS

Adatt./Suitable:

FIAT
7735100

⁰⁰ Eliminated on 04-08-2020. Please verify the availability through our local distributors

- Eliminato il 04-08-2020. Verificare la disponibilità presso i nostri distributori
- Éliminé le 04-08-2020. Vérifier la disponibilité auprès de nos distributeurs sur place
- Am 04-08-2020 gestrichen. Evtl. Verfügbarkeit bitte bei unseren Händlern prüfen
- Eliminado en fecha 04-08-2020. Verificar la disponibilidad a través de nuestros distribuidores locales

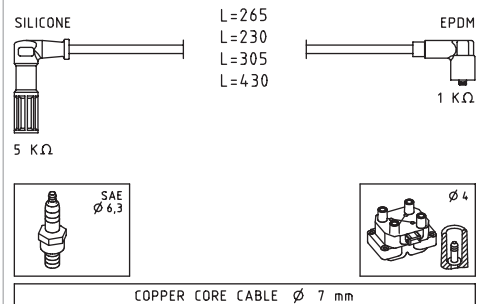
**FIAT**

PUNTO I 1.4 GT Turbo	176A4.000, 176B6.000	10/93 \Rightarrow 07/99
----------------------	----------------------	---------------------------

EPS 1.500.615



IGNITION CABLE SETS

Adatt./Suitable:

- FIAT 7694366
- HITACHI 134484
- MAGNETI MARELLI 941095680607

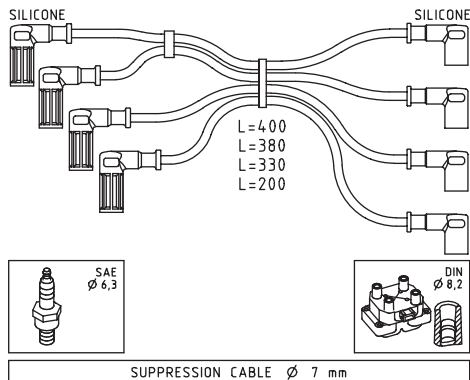

FIAT		
CINQUECENTO 0.9	170A1.000	07/91 \Rightarrow 12/93
CINQUECENTO 0.9 i.e.	170A1.046	07/91 \Rightarrow 09/94
CINQUECENTO 0.9 i.e. S	1170A1.000, 1170A1.046	07/91 \Rightarrow 07/99
PANDA I 900	1170A1.046	04/92 \Rightarrow 12/96
SEICENTO / 600 0.9	1170A1.046	11/97 \Rightarrow 01/10

EPS 1.500.616



IGNITION CABLE SETS

Adatt./Suitable:

- BOSCH 0 986 356 754
- FIAT 7776810
- HITACHI 134467
- LANCIA 7776810
- MAGNETI MARELLI 941095130583, 941095780616

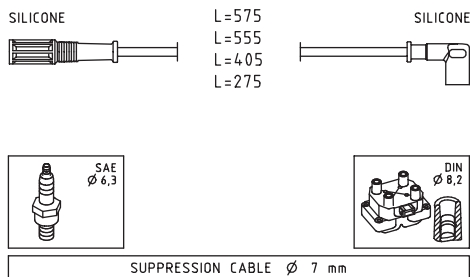

FIAT		
CINQUECENTO 1.1 Sporting	176B2.000	10/94 \Rightarrow 01/98
PUNTO I 1.1	176B2.000	04/96 \Rightarrow 02/00
PUNTO I 55 1.1	176A6.000, 176B2.000	09/93 \Rightarrow 09/99
PUNTO I 60 1.2	176A7.000, 176B1.000, 176B4.000	09/93 \Rightarrow 06/00
PUNTO I 75 1.2	176A8.000	10/93 \Rightarrow 09/99
PALIO 1.2	176A8.000, 178B5.000, 178B7.045, 178C4.066, 178E2.000, 188A4.000	04/96 \Rightarrow
PALIO 1.2 75	178B7.045	03/98 \Rightarrow
PALIO 1.2 MPI	178C4.066	01/02 \Rightarrow
PANDA I 1.1	156C.046	05/91 \Rightarrow 03/95
PANDA I 1000 4x4	141C2.000	05/86 \Rightarrow 12/94
PANDA I 1000 i.e	156A2.246	08/92 \Rightarrow 02/04
PANDA I 1000 i.e. Cat	141C2.000, 156A2.246	10/87 \Rightarrow 08/98
PANDA I 1100	156C.046, 176B2.000	05/91 \Rightarrow 12/99
PANDA I 1100 4x4	176B2.000	02/95 \Rightarrow 07/04
PANDA I 1100 Trekking 4x4	156C.046	10/91 \Rightarrow 07/04
SEICENTO / 600 1.1	176B2.000	01/98 \Rightarrow 01/10
SIENA 1.2	178B7.045	01/98 \Rightarrow
SIENA 1.3	178B5.000, 178C4.066, 188A4.000, 188A5.000	09/01 \Rightarrow 12/12
STRADA 1.2	178B5.000, 178B7.045, 188A4.000	04/03 \Rightarrow

FIAT		
STRADA 1.2 Trekking	--	11/05 \Rightarrow
UNO Mondo 1.2 i.e. [IND]	178D5.066	01/96 \Rightarrow

LANCIA		
YI 1.1	176B2.000	11/95 \Rightarrow 09/03
YI 1.2	840A3.000	03/96 \Rightarrow 09/03

EPS 1.500.623



IGNITION CABLE SETS

Adatt./Suitable:

- ⁰³ Supplied until depletion
- Fornibile fino ad esaurimento delle scorte
- Fourni jusqu'à épuisement du stock
- Lieferbar solange vorrat reicht
- Suministrado hasta el stock termina

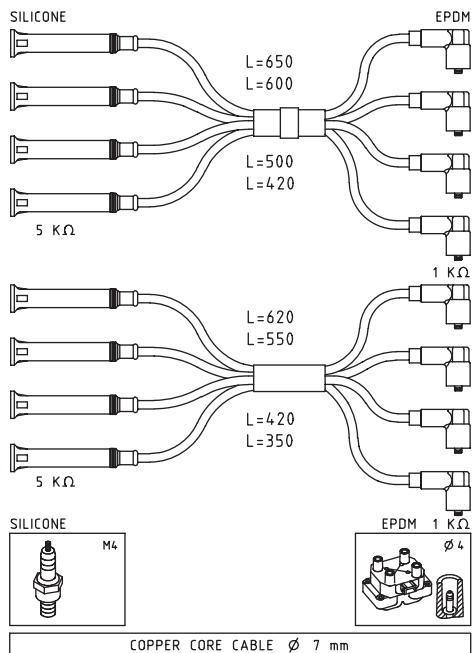

ALFA ROMEO		
155 1.7 T.S.	AR67103, AR67105	04/93 \Rightarrow 04/96
155 1.8 T.S.	AR67101	02/92 \Rightarrow 05/94
155 1.8 T.S. Sport	AR67101, AR67102	03/92 \Rightarrow 12/96
155 2.0 T.S.	AR67201, AR67202	02/92 \Rightarrow 05/95

EPS 1.500.634



IGNITION CABLE SETS

Adatt./Suitable:

- BOSCH 0 986 357 063, 0 986 357 124
- GENERAL MOTORS 90 442 404, 90 486 611, 90 486 612
- HITACHI 134258, 134871
- MAGNETI MARELLI 941125190673
- OPEL 16 12 543, 16 12 591, 16 12 592, 16 12 651

- ⁰³ Supplied until depletion
- Fornibile fino ad esaurimento delle scorte
- Fourni jusqu'à épuisement du stock
- Lieferbar solange vorrat reicht
- Suministrado hasta el stock termina

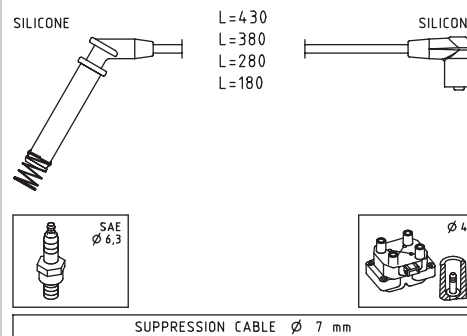

OPEL		
ASTRA F 1.4	14SE	09/92 \Rightarrow 09/98
ASTRA F 1.4 Si	C14SE	03/92 \Rightarrow 03/01
ASTRA F 1.6	16NZR	09/95 \Rightarrow 09/98
ASTRA F 1.6 i	X16SZ, X16SZR	09/91 \Rightarrow 01/05
ASTRA F 1.6 Si	C16SE	03/92 \Rightarrow 12/94
COMBO B 1.4	C14SE	07/94 \Rightarrow 10/01
CORSA A 1.4 Si	C14SE	09/91 \Rightarrow 03/93
CORSA B 1.4	C14SE	04/93 \Rightarrow 08/94
CORSA B 1.4 Si	C14SE	03/93 \Rightarrow 09/00
VECTRA A 1.6 i	X16SZ	09/93 \Rightarrow 11/95

VAUXHALL		
ASTRA III 1.4 i	C14SE	03/91 \Rightarrow 03/01
ASTRA III 1.6	C16SE	03/94 \Rightarrow 08/95
ASTRA III 1.6 i	C16SE, X16SZ, X16SZR	03/92 \Rightarrow 09/98
ASTRA III 1.6 Si	C16SE	03/91 \Rightarrow 12/94
ASTRAVAN I 1.6 i	X16SZ	09/94 \Rightarrow 08/96
COMBO B 1.4	C14SE	07/94 \Rightarrow 10/01
CORSA B 1.4 i S	C14SE	03/93 \Rightarrow 09/00



IGNITION CABLE SETS

Adatt./Suitable:

00 Eliminated on 26-10-2020. Please verify the availability through our local distributors

- Eliminato il 26-10-2020. Verificare la disponibilità presso i nostri distributori
- Éliminé le 26-10-2020. Vérifier la disponibilité auprès de nos distributeurs sur place
- Am 26-10-2020 gestrichen. Evtl. Verfügbarkeit bitte bei unseren Händlern prüfen
- Eliminado en fecha 26-10-2020. Verificar la disponibilidad a través de nuestros distribuidores locales

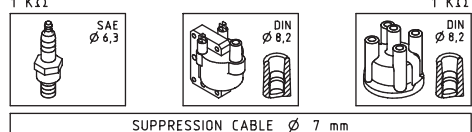
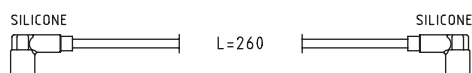
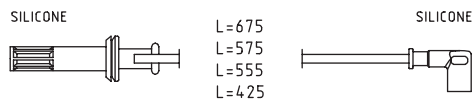
SUPPRESSION CABLE \varnothing 7 mm

FIAT		
COUPE 2.0 16V	836A3.000	11/93 \Rightarrow 08/96
COUPE 2.0 16V [BRA]	836A3.011	11/93 \Rightarrow 08/96
TIPO I 2.0	836A3.011	03/93 \Rightarrow 04/95
TIPO I 2.0 16V	160A8.046	07/91 \Rightarrow 04/95
TIPO I 2.0 i.e. 16V Sport	836A3.000	03/93 \Rightarrow 04/95

FIAT (BR)		
COUPE 2.0i 16V	2.0Mpi	01/95 \Rightarrow 12/97
TIPO 2.0i 16V	2.0Mpi	01/94 \Rightarrow 12/95

LANCIA		
DEDRA 2.0 16V	836A3.000	07/94 \Rightarrow 07/99
DEDRA 2.0 Integrale	836A3.000	07/94 \Rightarrow 07/99
DELTA II 2.0 16V	836A3.000	06/93 \Rightarrow 08/99



IGNITION CABLE SETS

Adatt./Suitable:

BOSCH
0 986 356 854

CITROËN
5967 N2

FIAT
7735397

INNOCENTI
7735397

LANCIA
7735397

MAGNETI MARELLI
941095770615

PEUGEOT
5967 N2

00 Eliminated on 04-05-2021. Please verify the availability through our local distributors

- Eliminato il 04-05-2021. Verificare la disponibilità presso i nostri distributori
- Éliminé le 04-05-2021. Vérifier la disponibilité auprès de nos distributeurs sur place
- Am 04-05-2021 gestrichen. Evtl. Verfügbarkeit bitte bei unseren Händlern prüfen
- Eliminado en fecha 04-05-2021. Verificar la disponibilidad a través de nuestros distribuidores locales

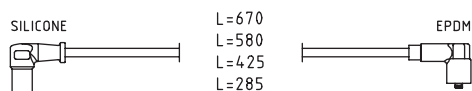
COPPER CORE CABLE \varnothing 7 mm

CITROËN		
JUMPY I 1.6	1580SPI, 220A2.000	10/95 \Rightarrow 08/00
JUMPY I 1.6 i	1580SPI, 220A2.000	10/95 \Rightarrow 08/00

FIAT		
ELBA 1.4	146D5.000	10/93 \Rightarrow 02/95

FIAT

FIORINO II 1.4	146C5.000	11/92 \Rightarrow 05/01
FIORINO II 1.6	146D6.000	01/94 \Rightarrow 05/01
FIORINO II 70 i.e. 1.4	146D5.000	05/94 \Rightarrow 05/01
FIORINO II 75 i.e. 1.6	146D6.000	10/93 \Rightarrow 05/01
SCUDO I 1.6	220A2.000	02/96 \Rightarrow 12/06
TEMPRA 1.4 i.e.	836A4.000	04/90 \Rightarrow 08/96
TEMPRA 1.6 i.e.	835C1.000	10/90 \Rightarrow 08/96
TIPO I 1.4 i.e.	836A4.000	05/89 \Rightarrow 04/95
TIPO I 1.6	835C1.000	03/93 \Rightarrow 10/95
TIPO I 1.6 i.e.	835C1.000	10/92 \Rightarrow 04/95
TIPO I 1.6 i.e. [BRA]	160E2.011	03/93 \Rightarrow 04/95

FIAT (BR)

TIPO 1.6i	1.65pi	01/93 \Rightarrow 12/95
-----------	--------	---------------------------

INNOCENTI

ELBA 1.4 i.e.	146D5.000	09/94 \Rightarrow 12/96
ELBA 1.6 i.e.	146D6.000	09/94 \Rightarrow 12/96

LANCIA

DEDRA 1.6 i.e.	835C1.000	04/93 \Rightarrow 07/99
DELTA II 1.4 i.e.	836A4.000	10/94 \Rightarrow 08/99
DELTA II 1.6 i.e.	835C1.000	06/93 \Rightarrow 08/99

PEUGEOT

EXPERT I 1.6	222A2(1580SPI)	02/96 \Rightarrow 09/00
--------------	----------------	---------------------------



IGNITION CABLE SETS

Adatt./Suitable:

ALFA ROMEO
60534855
60573030

00 Eliminated on 12-01-2021. Please verify the availability through our local distributors

- Eliminato il 12-01-2021. Verificare la disponibilità presso i nostri distributori
- Éliminé le 12-01-2021. Vérifier la disponibilité auprès de nos distributeurs sur place
- Am 12-01-2021 gestrichen. Evtl. Verfügbarkeit bitte bei unseren Händlern prüfen
- Eliminado en fecha 12-01-2021. Verificar la disponibilidad a través de nuestros distribuidores locales

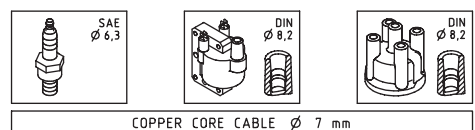
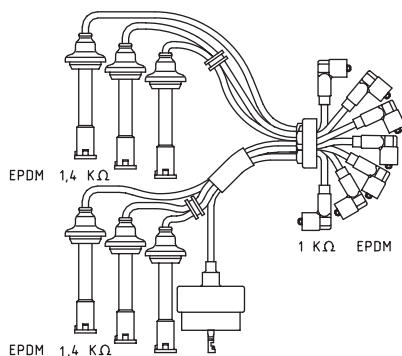
COPPER CORE CABLE \varnothing 7 mm

ALFA ROMEO

75 2.5 V6	AR01646, AR01648, AR01911	05/85 \Rightarrow 08/86
75 3.0 V6	AR06120, AR61503	01/87 \Rightarrow 02/92
75 3.0 V6 Cat	AR06124	01/87 \Rightarrow 02/92



IGNITION CABLE SETS

Adatt./Suitable:

00 Eliminated on 15-01-2020. Please verify the availability through our local distributors

- Eliminato il 15-01-2020. Verificare la disponibilità presso i nostri distributori
- Éliminé le 15-01-2020. Vérifier la disponibilité auprès de nos distributeurs sur place
- Am 15-01-2020 gestrichen. Evtl. Verfügbarkeit bitte bei unseren Händlern prüfen
- Eliminado en fecha 15-01-2020. Verificar la disponibilidad a través de nuestros distribuidores locales

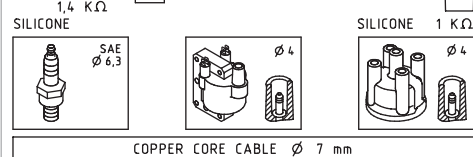
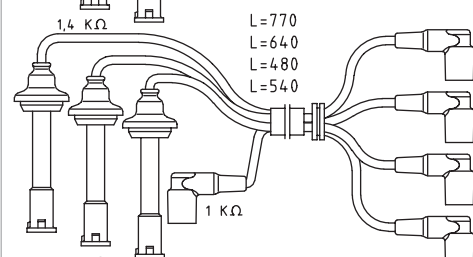
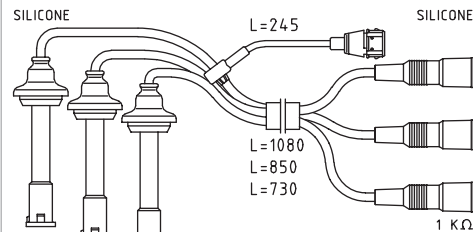
COPPER CORE CABLE \varnothing 7 mm

ALFA ROMEO

164 2.0 Turbo	AR64102	07/90 \Rightarrow 10/92
164 2.0 V6 Turbo	AR64101	03/91 \Rightarrow 09/92

EPS 1.500.674



07

IGNITION CABLE SETS

Adatt./Suitable:

BOSCH

0 986 356 767
0 986 356 854
F 000 99C 097

CITROËN

5967 L0
5967 L7
5967 N7
96 094 933
96 099 747

FIAT

9609493380
9619064880

HITACHI

134431

MAGNETI MARELLI

941135160703

PEUGEOT

5967 L0
5967 L7
5967 N7

03 Supplied until depletion

- Fornibile fino ad esaurimento delle scorte
- Fourni jusqu'à épuisement du stock
- Lieferbar solange vorrat reicht
- Suministrado hasta el stock termina

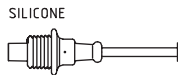
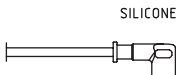
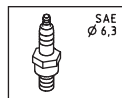
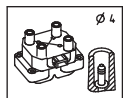
L = 4,00
L = 5,20
L = 6,20
L = 7,50L = 6,25
L = 5,85
L = 5,15
L = 3,75SAE
Ø 6,3

Ø 4

SUPPRESSION CABLE Ø 7 mm

CITROËN

XANTIA I 1.6 i	BFZ(XU5JP)	03/93 → 03/01
XANTIA I 1.8 i	LFZ(XU7JB), LFZ(XU7JP)	03/93 → 01/98
BX 16	BDY(XU5M), BDZ(XU5M)	05/89 → 12/94
BX 16 E	BDY(XU5M), BDZ(XU5M)	05/89 → 02/93
XSARA 1.8 i	LFZ(XU7JB), LFZ(XU7JP)	04/97 → 09/00
XSARA 1.8 i Aut.	LFZ(XU7JP)	04/97 → 09/00
EVASION 1.8	LFZ(XU7JP)	05/97 → 07/02
JUMPER I 2.0	RFW(XU10J2U)	02/94 → 04/02
JUMPER I 2.0 4x4	RFW(XU10J2U)	08/96 → 04/02
JUMPER II 2.0	XU10J2	04/02 →
JUMPER II 2.0 bivalent	XU10J2	02/03 →
BERLINGO I 1.8 i	LFZ(XU7JB)	05/97 → 10/02
BERLINGO I 1.8 i 4WD	LFZ(XU7JB)	04/97 → 10/01
XANTIA II 1.6 i SX	BFZ(XU5JP)	01/98 → 03/01
XANTIA II 1.8 i	LFZ(XU7JB)	01/98 → 04/03
ZX 1.6	BDY(XU5M), BFZ(XU5JP)	07/94 → 10/97
ZX 1.6 i	BDY(XU5M), BFZ(XU5JP)	03/91 → 10/97
ZX 1.8	LFZ(XU7JP)	03/91 → 10/97
ZX 1.8 i	LFZ(XU7JP)	07/92 → 10/97
ZX 1.9	D6E(XU9JA)	03/91 → 06/97
ZX 1.9 i	DKZ(XU9JA), XU9JA	03/91 → 06/97

FIAT

DUCATO II 2.0	RFL(XU10J2U)	03/94 →
DUCATO II 2.0 4x4	RFL(XU10J2U)	11/94 → 07/06
DUCATO II 2.0 Bipower	RFL(XU10J2U)	11/02 →
DUCATO II 2.0 Panorama/Combinato	RFW	03/94 → 04/02
ULYSSE I 1.8	LFW(XU7JP)	05/97 → 08/02

PEUGEOT

205 II 1.6 i	BDZ(XU5M)	01/91 → 12/94
306 1.8	--, LFZ(XU7JP)	05/93 → 04/02
306 1.8 ST	LFZ(XU7JP)	06/94 → 05/01
BOXER I 2.0	RFL(XU10J2U)	04/02 →
BOXER I 2.0 4x4	--	03/96 → 09/98
BOXER I 2.0 i	RFW(XU10J2)	03/94 → 04/02
BOXER I 2.0 i 4x4	RFW(XU10J2)	08/96 → 04/02
309 II 1.6	BDZ(XU5M)	07/89 → 12/93
405 I 1.6	BDY(XU5M2Z), BDY(XU5M3Z)	07/87 → 12/92
405 II 1.6	BDY(XU5M2Z), BDY(XU5M3Z), BDZ(XU5M), BFZ(XU5JP)	08/92 → 05/97
405 II 1.8	LFZ(XU7JP)	08/92 → 10/96
406 1.6	BFZ(XU5JP)	11/95 → 05/04
406 1.8	LFZ(XU7JB), LFZ(XU7JP)	10/96 → 03/99
EXPERT I 1.8	L6B(XU7JP), LFZ(XU7JP)	09/96 →
806 1.8	LFW(XU7JP)	07/95 → 08/02
PARTNER I 1.8	LFZ(XU7JB)	03/97 → 12/02
RANCH 1.8	LFZ(XU7JB)	05/97 →

EPS 1.500.688



07,5

IGNITION CABLE SETS

Adatt./Suitable:

BOSCH

0 986 356 778
0 986 357 237
F 005 X03 945
F 005 X04 028

GENERAL MOTORS

90 384 308
90 384 310
90 443 584
90 443 687

HOLDEN

90443584
90443687

MAGNETI MARELLI

941125310683

OPEL

12 82 077
12 82 078
12 82 079
12 82 080
16 12 552
16 12 561

03 Supplied until depletion

- Fornibile fino ad esaurimento delle scorte
- Fourni jusqu'à épuisement du stock
- Lieferbar solange vorrat reicht
- Suministrado hasta el stock termina

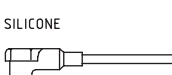
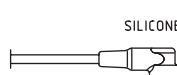
L = 6,25
L = 5,85
L = 5,15
L = 3,75

1 K.Ω

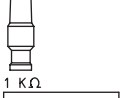
SAE
Ø 6,3

Ø 4

COPPER CORE CABLE Ø 7 mm

HOLDEN

BARINA 1.6	X16XE	05/97 → 08/00
BARINA_SB 1.6i	C16XE, X16XE	04/94 → 09/98
CALIBRA_YE 2.0i 16V	C20XE	09/91 → 07/95

OPEL

ASTRA F 1.6 i 16V	X16XEL	08/94 → 01/05
ASTRA F 2.0 GSI 16V	C20XE	09/91 → 01/98
ASTRA F 2.0 i 16V	C20XE	03/93 → 01/98
CALIBRA A 2.0 i 16V	C20XE	06/90 → 02/94
CALIBRA A 2.0 i 16V 4x4	C20XE	06/90 → 02/94
COMBO B 1.4 16V	X14XE	08/99 → 10/01
CORSA B 1.4 i 16V	C14SEL, X14XE	09/94 → 12/02
CORSA B 1.6 GSI 16V	C16XE	03/93 → 09/00
CORSA B 1.6 i 16V	C16SEL, X16XE	09/94 → 09/00
TIGRA A 1.4 16V	X14XE	07/94 → 12/00
TIGRA A 1.6 16V	C16SEL, X16XE	07/94 → 08/98
VECTRA A 2.0 i 16V	20XEJ	02/89 → 10/90
VECTRA A 2.0 i 16V 4x4	C20XE	08/89 → 08/95
VECTRA A 2.0 i 16V Cat	C20XE	02/90 → 11/95
VECTRA A 2000 16V 4x4	20XEJ	01/89 → 10/90
VECTRA A 2000/GT 16V	20XEJ	01/89 → 06/94
VECTRA A 2000/GT 16V Cat	C20XE	02/90 → 11/95
VECTRA A 2000/GT 16V Cat 4x4	C20XE	02/90 → 11/95
VECTRA B 1.6 i 16V	X16XEL	10/95 → 07/02

VAUXHALL

ASTRA III 1.6 i 16V	X16XEL	01/94 → 09/98
ASTRA III 2.0 i 16V	C20XE	09/91 → 02/98
CALIBRA 2.0 i 16V	C20XE	06/90 → 02/94
CALIBRA 2.0 i 16V 4x4	C20XE	06/90 → 02/94
COMBO B 1.4 16V	X14XE	08/99 → 10/01
CORSA B 1.4 i 16V	X14XE	09/94 → 09/00
CORSA B 1.6 GSI 16V	C16XE	03/93 → 09/00
CORSA B 1.6 i 16V	X16XE	09/94 → 09/00
TIGRA A 1.4 16V	X14XE	07/94 → 12/00
TIGRA A 1.6 16V	X16XE	07/94 → 12/00
VECTRA B 1.6 i 16V	X16XEL	08/95 → 03/02

EPS 1.500.689



07,5

IGNITION CABLE SETS

Adatt./Suitable:

BOSCH

0 986 357 125
0 986 357 127
F 005 X03 945

GENERAL MOTORS

90 443 692
90 443 693
90 443 694

HITACHI

134214

HOLDEN

90443692

OPEL

16 12 558
16 12 559
16 12 560

03 Supplied until depletion

- Fornibile fino ad esaurimento delle scorte
- Fourni jusqu'à épuisement du stock
- Lieferbar solange vorrat reicht
- Suministrado hasta el stock termina

SILICONE

L = 550
L = 330

SILICONE

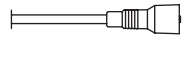
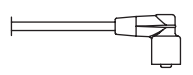
L = 550
L = 330

SILICONE



L = 1030

SILICONE

SAE
Ø 6,3

Ø 4

Ø 4

SUPPRESSION CABLE Ø 7 mm

HOLDEN

CALIBRA_YE 2.0i	C20NE	09/91 → 07/95
-----------------	-------	---------------

OPEL

ASTRA F 1.8 i	C18NZ	09/91 → 09/98
ASTRA F 2.0 i	C20NE	09/91 → 09/98
CALIBRA A 2.0 i	C20NE	08/89 → 12/96
CALIBRA A 2.0 i 4x4	C20NE	06/90 → 07/97
FRONTERA A 2.0 i	C20NE	03/92 → 10/98
KADETT E 1.8 i	S18NV	06/85 → 08/91
KADETT E 1.8 S	E18NV	09/87 → 08/91
KADETT E 2.0 GSI	20NE	09/86 → 08/91
KADETT E 2.0 GSI Cat	C20NE	09/86 → 08/91
KADETT E 2.0 i	20NE	10/86 → 02/93
KADETT E 2.0 i Cat	C20NE	10/86 → 02/93
OMEGA A 1.8	18SEH, E18NVR, S18NV	09/86 → 03/94
OMEGA A 1.8 N	18NV	09/86 → 08/87
OMEGA A 1.8 S	18SV	09/86 → 03/94
OMEGA A 2.0	20SE, C20NE	09/86 → 04/94
OMEGA A 2.0 i	C20NE	09/86 → 04/94
OMEGA B 2.0	20SE	03/94 → 12/00
VECTRA A 1.8 i	18SV	09/88 → 10/90
VECTRA A 1.8 i Cat	C18NZ	03/90 → 11/95
VECTRA A 1.8 S	18SV, E18NVR	09/88 → 10/90
VECTRA A 1.8 S 4x4	E18NVR	01/89 → 07/89
VECTRA A 2.0 i	20NE, 20SEH	09/88 → 09/92
VECTRA A 2.0 i 4x4	20NE, 20SEH	01/89 → 07/92
VECTRA A 2.0 i Cat	C20NE	09/88 → 11/95
VECTRA A 2.0 i Cat 4x4	C20NE	01/89 → 11/95
VECTRA A 2.0 i GT	20SEH	09/88 → 11/95

VAUXHALL

ASTRA III 1.8 i	C18NZ	09/91 → 09/98
ASTRA III 2.0 i	C20NE	09/91 → 09/98
CALIBRA 2.0 i	C20NE	06/90 → 07/97
CALIBRA 2.0 i 4x4	C20NE	06/90 → 07/97
FRONTERA A 2.0	C20NE	04/95 → 08/98
FRONTERA A 2.0 i	C20NE	03/92 → 10/98
OMEGA B 2.0	20SE	09/95 → 09/96



IGNITION CABLE SETS

Adatt./Suitable:

00 Eliminated on 16-09-2019. Please verify the availability through our local distributors

- Eliminato il 16-09-2019. Verificare la disponibilità presso i nostri distributori
- Éliminé le 16-09-2019. Vérifier la disponibilité auprès de nos distributeurs sur place
- Am 16-09-2019 gestrichen. Evtl. Verfügbarkeit bitte bei unseren Händlern prüfen
- Eliminado en fecha 16-09-2019. Verificar la disponibilidad a través de nuestros distribuidores locales

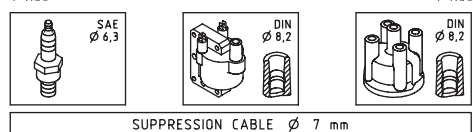
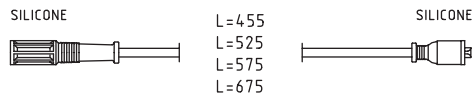
SUPPRESSION CABLE \varnothing 7 mm

FIAT		
TEMPRA 1.8 4x4	159A4.000	07/92 \Rightarrow 06/93
TEMPRA 1.8 i.e.	159A4.000, 159A4.046	03/90 \Rightarrow 08/96
TEMPRA 2.0	159A6.046	04/90 \Rightarrow 06/93
TEMPRA 2.0 i.e.	159A6.046	10/90 \Rightarrow 09/96
TEMPRA 2.0 i.e. [BRA]	159A6.011	04/93 \Rightarrow 12/96
TEMPRA 2.0 i.e. 4x4	159A6.046	03/92 \Rightarrow 03/95
TIPO I 1.8 i.e.	159A4.000, 159A4.046	10/90 \Rightarrow 06/93
TIPO I 2.0	159A5.046, 159A6.046	10/90 \Rightarrow 10/92
TIPO I 2.0 i.e.	159A5.046, 159A6.046	03/90 \Rightarrow 04/95
TIPO I 2.0 i.e. [BRA]	159A6.011	03/93 \Rightarrow 10/95

LANCIA		
DEDRA 1.8 i.e.	835A2.000, 835A2.046, 835C5.000	09/89 \Rightarrow 07/99
DEDRA 2.0 HF Integrale	835A7.046	11/90 \Rightarrow 07/94
DEDRA 2.0 i.e.	835A5.000, 835A5.046	09/89 \Rightarrow 07/99
DEDRA 2.0 i.e. Turbo	835A8.046	04/91 \Rightarrow 07/99
DEDRA 2.0 i.e. Turbo Integrale	835A7.000	04/90 \Rightarrow 08/91
DEDRA 2.0 Turbo	835A8.000	11/90 \Rightarrow 06/94



IGNITION CABLE SETS

Adatt./Suitable:

FIAT

7742005

LANCIA

7742005

MAGNETI MARELLI

941095700609

03 Supplied until depletion

- Fornibile fino ad esaurimento delle scorte
- Fourni jusqu'à épuisement du stock
- Lieferbar solange vorrat reicht
- Suministrado hasta el stock termina

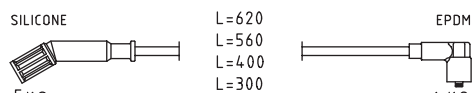
COPPER CORE CABLE \varnothing 7 mm

FIAT		
TIPO I 1.1 i.e.	156C.046	10/94 \Rightarrow 10/95
UNO Mondo 1.0 i.e.	146D8.000	01/96 \Rightarrow

LANCIA		
Y10 1.1 Fire	176B2.000	01/95 \Rightarrow 12/95

LANCIA

Y10 1.1 Fire Trazione integrale	176B2.000	01/95 \Rightarrow 12/95
Y10 1.1 i.e. Fire Trazione integrale	156C.046	09/92 \Rightarrow 12/95



IGNITION CABLE SETS

Adatt./Suitable:

BOSCH

0 986 356 892

FIAT

7703382

LANCIA

7703382

00 Eliminated on 06-07-2020. Please verify the availability through our local distributors

- Eliminato il 06-07-2020. Verificare la disponibilità presso i nostri distributori
- Éliminé le 06-07-2020. Vérifier la disponibilité auprès de nos distributeurs sur place
- Am 06-07-2020 gestrichen. Evtl. Verfügbarkeit bitte bei unseren Händlern prüfen
- Eliminado en fecha 06-07-2020. Verificar la disponibilidad a través de nuestros distribuidores locales

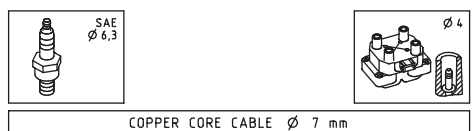
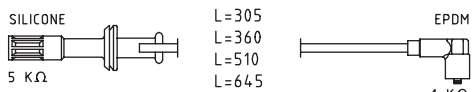
COPPER CORE CABLE \varnothing 7 mm

FIAT

CROMA I 2000 16V	154E1.000	08/92 \Rightarrow 08/96
CROMA I 2000 i.e. 16V	154E1.027	03/95 \Rightarrow 12/96

LANCIA

KAPPA 2.0 16V Turbo	834A4.000	02/95 \Rightarrow 10/01
THEMA 2000 16V	834F1.000	05/92 \Rightarrow 07/94
THEMA 2000 16V Turbo	834F2.000	10/92 \Rightarrow 07/94
THEMA 2000 Turbo 16V	834F2.000	11/92 \Rightarrow 07/94



IGNITION CABLE SETS

Adatt./Suitable:

ALFA ROMEO

115 48 05 089 00

60522981

60569567

MAGNETI MARELLI

941044110501

03 Supplied until depletion

- Fornibile fino ad esaurimento delle scorte
- Fourni jusqu'à épuisement du stock
- Lieferbar solange vorrat reicht
- Suministrado hasta el stock termina

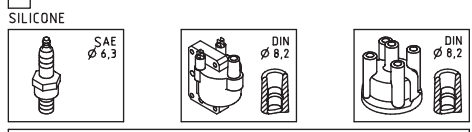
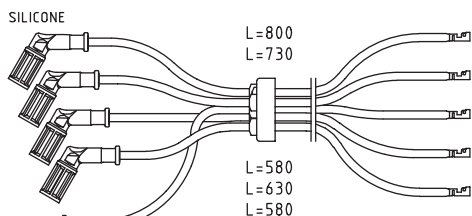
SUPPRESSION CABLE \varnothing 7 mm

ALFA ROMEO

75 1.6	AR06100	05/85 \Rightarrow 09/89
75 1.8	AR06202	09/85 \Rightarrow 06/89



IGNITION CABLE SETS

Adatt./Suitable:

03 Supplied until depletion

- Fornibile fino ad esaurimento delle scorte
- Fourni jusqu'à épuisement du stock
- Lieferbar solange vorrat reicht
- Suministrado hasta el stock termina

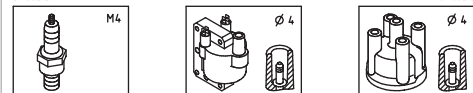
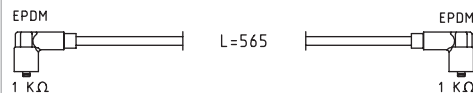
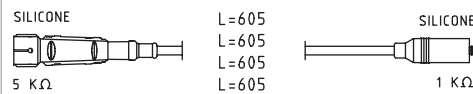
COPPER CORE CABLE \varnothing 7 mm

SEAT

IBIZA II 1.0	AAU	03/93 \Rightarrow 09/96
IBIZA II 1.3 i	AAV	03/93 \Rightarrow 08/99
TOLEDO I 1.6 i	ABN, EZ	05/91 \Rightarrow 03/99
TOLEDO I 1.8 16V	PL	05/91 \Rightarrow 03/99
TOLEDO I 1.8 i	ABS, ADZ, RP	05/91 \Rightarrow 12/96
TOLEDO I 2.0 i	2E	05/91 \Rightarrow 03/99

VW

JETTA II 1.6	ABN, EZ, EZA, HM, PN, RF	12/83 \Rightarrow 07/92
JETTA II 1.8	EV, GU, GX, PB, RD, RH, RV	01/84 \Rightarrow 10/91
JETTA II 1.8 Cat	GX, PF, RP	01/87 \Rightarrow 10/91
JETTA II 1.8 G60	PG	04/90 \Rightarrow 07/91
JETTA II 1.8 Syncro	3E82, GU, GX, RH, RP	08/85 \Rightarrow 07/91
JETTA II 1.8i GT	GZ	12/83 \Rightarrow 07/88
CADDY I 1.5	JB	08/82 \Rightarrow 07/83
CADDY I 1.6	EW, HN	01/83 \Rightarrow 07/92
CADDY I 1.8	JH	08/85 \Rightarrow 07/92
CORRADO 1.8 G60	PG	09/88 \Rightarrow 09/93
CORRADO 2.0 i	ADY	04/93 \Rightarrow 12/95
GOLF I 1.6	EW, HN	08/83 \Rightarrow 04/92
GOLF I 1.8	2H, DX, EX, JH, KT	08/82 \Rightarrow 04/93
GOLF II 1.0	GN	11/83 \Rightarrow 08/85
GOLF II 1.6	ABN, EZ, PN, RF	08/83 \Rightarrow 12/92
GOLF II 1.6 [CHE] [SWE]	HM	08/83 \Rightarrow 07/88
GOLF II 1.6 G	EZA, PN	08/86 \Rightarrow 07/91
GOLF II 1.8	GU, GX, RH, RV	08/84 \Rightarrow 10/91
GOLF II 1.8 [CHE] [SWE]	HV	04/84 \Rightarrow 07/87
GOLF II 1.8 GTI	EV, PB, RD	08/83 \Rightarrow 10/91
GOLF II 1.8 GTI Cat	PF	01/87 \Rightarrow 10/91
GOLF II 1.8 GTI G60	PG	04/90 \Rightarrow 07/91
GOLF II 1.8 GTI G60 Syncro	1H, PG	08/88 \Rightarrow 12/91
GOLF II 1.8 i	RP	08/87 \Rightarrow 07/91
GOLF II 1.8 i Cat	GX, RP	08/87 \Rightarrow 10/91
GOLF II 1.8 i Cat Syncro	RP	08/87 \Rightarrow 10/91
GOLF II 1.8 Rallye syncro	1H, PG	08/88 \Rightarrow 07/91
GOLF II 1.8 Syncro	3E82, GU, GX, RH	02/86 \Rightarrow 07/91
GOLF II 1.8i GTI [CHE] [SWE]	GZ	01/84 \Rightarrow 07/87
GOLF II 1.8i GTI [SWE]	GZ	08/87 \Rightarrow 07/88
PASSAT III 1.6	1F, ABN, EZ	04/88 \Rightarrow 07/92
PASSAT III 1.8	AAM, ABS, PB, PF, RP	02/88 \Rightarrow 05/97
PASSAT III 1.8 G60 Syncro	PG	08/88 \Rightarrow 05/97
PASSAT III 2.0	2E	02/90 \Rightarrow 05/97
PASSAT III 2.0 Syncro	2E	03/90 \Rightarrow 12/96
PASSAT III 2.0i	ACX	08/92 \Rightarrow 07/93
GOLF III 1.8	AAM, ABS, ADZ	08/91 \Rightarrow 04/99
GOLF III 1.8 Syncro	ABS	01/93 \Rightarrow 08/97
SCIROCCO II 1.6	EW, EWA, HN, RE	01/83 \Rightarrow 07/90
SCIROCCO II 1.8	DX, EX, JH, KT	08/82 \Rightarrow 07/92
VENTO 1.8	AAM, ABS	11/91 \Rightarrow 09/98
VENTO 2.0	AKR	11/91 \Rightarrow 09/98



IGNITION CABLE SETS

Adatt./Suitable:

00 Eliminated on 22-02-2022. Please verify the availability through our local distributors

- Eliminato il 22-02-2022. Verificare la disponibilità presso i nostri distributori
- Éliminé le 22-02-2022. Vérifier la disponibilité auprès de nos distributeurs sur place
- Am 22-02-2022 gestrichen. Evtl. Verfügbarkeit bitte bei unseren Händlern prüfen
- Eliminado en fecha 22-02-2022. Verificar la disponibilidad a través de nuestros distribuidores locales

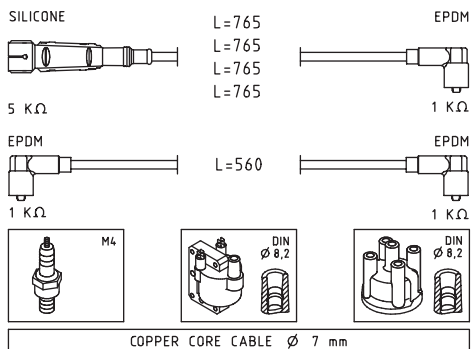

VW			
JETTA II 1.3	GT, HK	01/84 ⇒ 06/87	
JETTA II 1.6	EZ, HM	12/83 ⇒ 07/92	
JETTA II 1.8	EV, GU, GX	01/84 ⇒ 10/91	
JETTA II 1.8 Cat	GX	08/87 ⇒ 10/91	
JETTA II 1.8 Syncro	GU	08/87 ⇒ 12/88	
JETTA II 1.8i GT	GZ	12/83 ⇒ 07/88	
CADDY I 1.5	JB	08/82 ⇒ 07/83	
CADDY I 1.6	EW, HN	01/83 ⇒ 07/92	
CADDY I 1.8	JH	08/85 ⇒ 07/92	
GOLF I 1.3	HK	08/83 ⇒ 07/86	
GOLF I 1.6	EW, HN	08/83 ⇒ 04/92	
GOLF I 1.8	2H, DX, EX, JH, KT	08/82 ⇒ 04/93	
GOLF II 1.0	GN	11/83 ⇒ 08/85	
GOLF II 1.3	GT, HK	08/83 ⇒ 06/87	
GOLF II 1.6	EZ	08/83 ⇒ 07/92	
GOLF II 1.6 [CHE] [SWE]	HM	08/83 ⇒ 07/85	
GOLF II 1.8	GU, GX	08/84 ⇒ 10/91	
GOLF II 1.8 [CHE] [SWE]	HV	04/84 ⇒ 07/87	
GOLF II 1.8 GTI	EV	08/83 ⇒ 10/91	
GOLF II 1.8i Cat	GX	08/87 ⇒ 10/91	
GOLF II 1.8i GTI [CHE] [SWE]	GZ	01/84 ⇒ 07/87	
GOLF II 1.8i GTI [SWE]	GZ	08/87 ⇒ 07/88	
SCIROCCO I 1.1	FA	04/74 ⇒ 07/79	
SCIROCCO I 1.3	GF	08/79 ⇒ 07/80	
SCIROCCO I 1.5	JB	08/77 ⇒ 07/80	
SCIROCCO II 1.3	HK	08/83 ⇒ 07/84	
SCIROCCO II 1.6	EW, EWA, HN	01/83 ⇒ 12/89	
SCIROCCO II 1.8	DX, EX, JH, KT	08/82 ⇒ 07/92	



IGNITION CABLE SETS

Adatt./Suitable:

03 Supplied until depletion

- Fornibile fino ad esaurimento delle scorte
- Fourni jusqu'à épuisement du stock
- Lieferbar solange vorrat reicht
- Suministrado hasta el stock termina

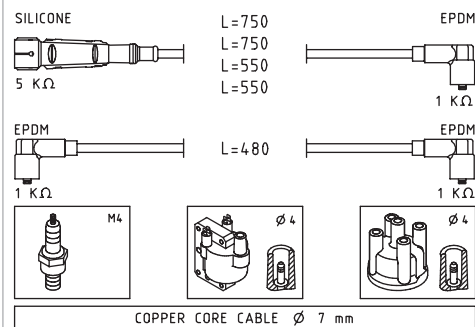

SEAT			
CORDOBA I 1.6 i	ABU	02/93 ⇒ 10/02	
VW			
VENTO 1.6	ABU	09/92 ⇒ 09/98	



IGNITION CABLE SETS

Adatt./Suitable:

03 Supplied until depletion

- Fornibile fino ad esaurimento delle scorte
- Fourni jusqu'à épuisement du stock
- Lieferbar solange vorrat reicht
- Suministrado hasta el stock termina

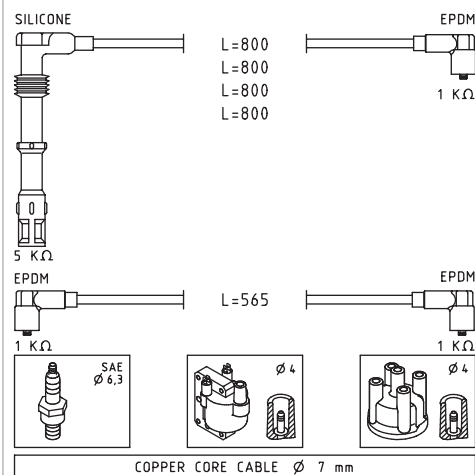

VW			
JETTA II 1.8 16V	KR, PL	08/86 ⇒ 10/91	
GOLF II 1.8 GTI 16V	KR, PL	02/86 ⇒ 10/91	
SCIROCCO II 1.8 16V	KR, PL	10/85 ⇒ 07/92	



IGNITION CABLE SETS

Adatt./Suitable:

00 Eliminated on 22-02-2022. Please verify the availability through our local distributors

- Eliminato il 22-02-2022. Verificare la disponibilità presso i nostri distributori
- Éliminé le 22-02-2022. Vérifier la disponibilité auprès de nos distributeurs sur place
- Am 22-02-2022 gestrichen. Evtl. Verfügbarkeit bitte bei unseren Händlern prüfen
- Eliminado en fecha 22-02-2022. Verificar la disponibilidad a través de nuestros distribuidores locales

BOSCH
0 986 357 128
CITROËN
95 659 596
97 534 955
PEUGEOT
5967 C3
5967 K7

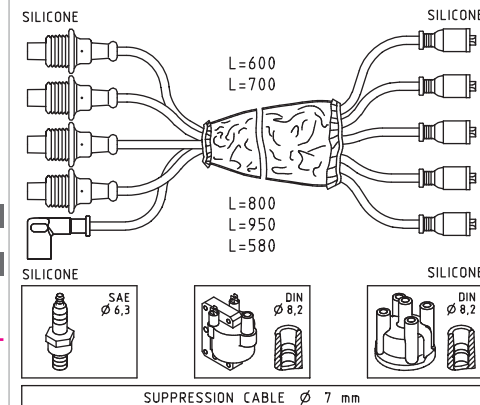

CITROËN			
BX 1.6	182A, B6D, B6E	01/87 ⇒ 12/94	
BX 1.9	159C, D6U, DKK	09/85 ⇒ 12/94	
BX 1.9 GTi	D6D, D6K	01/87 ⇒ 01/92	
BX 16	180Z	03/86 ⇒ 12/94	
BX 19	D6A(XU9J2), DKZ(XU9JA)	07/86 ⇒ 12/94	
BX 19 Cat	DFZ(XU9J1)	07/86 ⇒ 12/94	
BX 19 GTi	D6A(XU9J2), DKZ(XU9JA)	07/86 ⇒ 02/93	
BX 19 GTi 4x4	DKZ(XU9JA)	06/88 ⇒ 02/93	

PEUGEOT			
205 I 1.6	B1A(XU51C), B1E(XU51C), BAZ(XU5CP)	08/86 ⇒ 10/87	
205 I 1.6 GTI	180A(XU5J), B6D(XU5JA), XU5J1	01/83 ⇒ 12/90	
205 II 1.9 GTI	DFZ(XU9J1)	03/87 ⇒ 10/87	
205 II 1.6	B1A(XU51C), B1E(XU51C), BAZ(XU5CP)	10/87 ⇒ 09/98	
205 II 1.6 CTI	180A(XU5J), 180Z(XU5J)	03/86 ⇒ 10/90	
205 II 1.6 GTI	180A(XU5J), 180Z(XU5J)	10/87 ⇒ 12/89	
205 II 1.9 CTI	DFZ(XU9J1)	10/87 ⇒ 12/94	
205 II 1.9 GTI Cat	DFZ(XU9J1)	10/87 ⇒ 07/94	
309 I 1.6	--, 180Z(XU5J), B6B(XU5J), XU5JA	11/85 ⇒ 06/89	
309 I 1.6 Cat	BAZ(XU5CP)	09/86 ⇒ 12/89	
309 I 1.9	D2B(XU9S), DFZ(XU9J1), XU92C	10/85 ⇒ 07/89	
309 II 1.6	XU5JA	07/89 ⇒ 12/93	
309 II 1.6 GTi	--	09/89 ⇒ 10/93	
309 II 1.9	XU92C	07/89 ⇒ 12/93	
405 I 1.9	DFZ(XU9J1)	05/88 ⇒ 08/92	
405 I 1.9 Injection	DFZ(XU9J1)	07/87 ⇒ 12/92	
405 I 1.9 Trazione integrale	DFZ(XU9J1)	09/88 ⇒ 07/92	

EPS 1.500.748

07,5

IGNITION CABLE SETS

Adatt./Suitable:

PEUGEOT

5967 E5
5967 H5
5967 K4

Eliminated on 01-12-2020. Please verify the availability through our local distributors

- Eliminato il 01-12-2020. Verificare la disponibilità presso i nostri distributori
- Éliminé le 01-12-2020. Vérifier la disponibilité auprès de nos distributeurs sur place
- Am 01-12-2020 gestrichen. Evtl. Verfügbarkeit bitte bei unseren Händlern prüfen
- Eliminado en fecha 01-12-2020. Verificar la disponibilidad a través de nuestros distribuidores locales

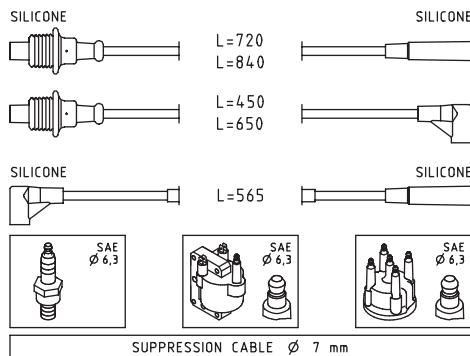

PEUGEOT

205 I 1.6	B1A(XU51C), B1E(XU51C)	08/86 ⇒ 10/87
205 II 1.6	B1A(XU51C), B1E(XU51C)	10/87 ⇒ 09/98
309 II 1.6	18EM, BDZ(XU5M)	07/89 ⇒ 12/93
309 II 1.9	XU92C	07/89 ⇒ 12/93
405 I 1.6	—, 18EM, B1E(XU51C), BDZ(XU5M)	01/87 ⇒ 12/92
405 I 1.6 4x4	BDZ(XU5M)	04/88 ⇒ 07/92
405 I 1.6 SRI 4x4	BDZ(XU5M)	04/88 ⇒ 07/92
405 I 1.9	D2C(XU92C)	07/87 ⇒ 12/92
405 II 1.6	18EM	08/92 ⇒ 05/97
405 II 1.9	XU92C	01/93 ⇒ 12/96

EPS 1.500.768

07

IGNITION CABLE SETS

Adatt./Suitable:

Eliminated on 21-01-2020. Please verify the availability through our local distributors

- Eliminato il 21-01-2020. Verificare la disponibilità presso i nostri distributori
- Éliminé le 21-01-2020. Vérifier la disponibilité auprès de nos distributeurs sur place
- Am 21-01-2020 gestrichen. Evtl. Verfügbarkeit bitte bei unseren Händlern prüfen
- Eliminado en fecha 21-01-2020. Verificar la disponibilidad a través de nuestros distribuidores locales

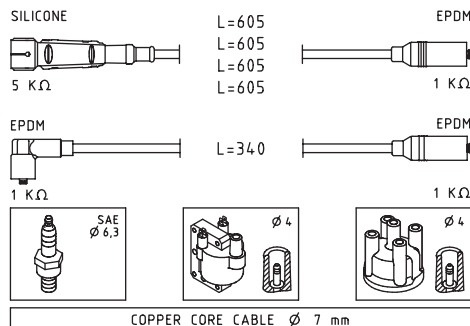

AUDI

80 II 1.3	EP	09/78 ⇒ 07/86
80 II 1.6	DT, JU, SA, WV	08/78 ⇒ 03/87
80 II 1.8	DS, JN, SF	01/83 ⇒ 08/86
80 II 1.8 CC quattro	JN, JV	08/84 ⇒ 08/86

AUDI

80 II 1.8 GTE	DZ, MU, PV	06/84 ⇒ 03/87
80 III 1.4	SE	08/86 ⇒ 07/88
80 III 1.6	ABB, PP, RN, RNA	09/86 ⇒ 10/91
80 III 1.8	RU, SD	09/86 ⇒ 01/90
80 III 1.8 E	DZ	06/86 ⇒ 08/91
80 III 1.8 E quattro	DZ	09/86 ⇒ 08/91
80 III 1.8 quattro	SD	09/86 ⇒ 08/90
80 III 1.8 S	JN, JV, NE, PM, SF	08/86 ⇒ 10/91
80 III 1.8 S quattro	JN, NE, PM, SF	09/86 ⇒ 09/91
80 III 2.0	AAD	10/90 ⇒ 08/91
80 III 2.0 E	3A	08/88 ⇒ 10/90
80 III 2.0 E quattro	3A	08/88 ⇒ 09/90
80 III 2.0 quattro	3A, AAD	08/88 ⇒ 08/91
80 IV 1.6	ABB, ABM	09/91 ⇒ 12/94
80 IV 1.6 E	ADA	06/93 ⇒ 01/96
80 IV 2.0	ABT	09/91 ⇒ 01/96
80 IV 2.0 E	ABK	09/91 ⇒ 01/96
80 IV 2.0 E quattro	ABK	09/91 ⇒ 12/94
80 IV 2.0 quattro	ADW	11/93 ⇒ 01/96
90 I 1.8	JN	06/84 ⇒ 03/87
100 III 1.8	DS, JW, NP, SH	08/83 ⇒ 12/90
100 III 1.8 Cat	4B, PH	03/85 ⇒ 11/90
100 III 1.8 Cat quattro	4B, PH	08/85 ⇒ 11/90
100 III 1.8 quattro	NP, SH	10/84 ⇒ 07/90
100 IV 1.6	ABB	03/92 ⇒ 07/93
100 IV 2.0	AAE	12/90 ⇒ 07/94
100 IV 2.0 E	AAD, AAE, ABK	12/90 ⇒ 07/94
100 IV 2.0 E quattro	AAD	12/90 ⇒ 07/92
A6 I 2.0	AAE, ABK, ADW	06/94 ⇒ 12/97
A4 I RS4 quattro	AZR	05/00 ⇒ 09/01
CABRIOLET 2.0 E	ABK	01/93 ⇒ 07/98
COUPE 1.8	DZ	08/89 ⇒ 07/91
COUPE 2.0	3A, AAD, ABK	05/89 ⇒ 12/96

EPS 1.500.780

07

IGNITION CABLE SETS

Adatt./Suitable:

BOSCH

0 986 356 889

HITACHI

134471

MAGNETI MARELLI

941135120700

PEUGEOT

5967 K6

Supplied until depletion

- Fornibile fino ad esaurimento delle scorte
- Fourni jusqu'à épuisement du stock
- Lieferbar solange vorrat reicht
- Suministrado hasta el stock termina

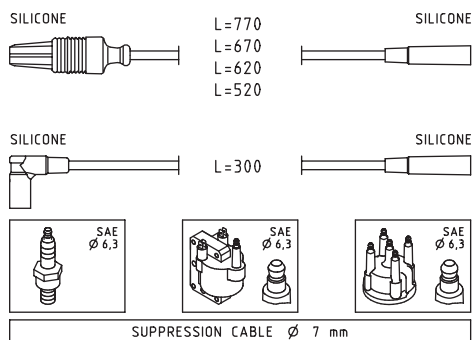

PEUGEOT

106 I 1.0	TU9	09/91 ⇒ 03/01
106 I 1.1	H1B(TU1), HDZ(TU1M)	08/91 ⇒ 04/96
106 I 1.4	K5A(TU3), KDY(TU3M), TU3, TU3.2	08/91 ⇒ 04/96
106 II 1.1	H1B(TU1)	04/96 ⇒
205 I 1.4	TU3	01/83 ⇒ 12/90
205 II 1.0	TU9	10/87 ⇒ 09/98
205 II 1.1	H1B(TU1), HDZ(TU1M)	10/87 ⇒ 09/98
205 II 1.1 CJ	HDZ(TU1M)	10/89 ⇒ 12/94
205 II 1.4	K1D(TU3A), K2B(TU3S), KDY(TU3M), KDZ(TU3M)	06/87 ⇒ 09/98
205 II 1.4 Cat	KAY(TU3CP)	08/87 ⇒ 09/93
205 II 1.4 CJ	K1D(TU3A), KDY(TU3M), KDZ(TU3M)	03/89 ⇒ 12/94
205 II 1.4 CJ Cat	KAY(TU3CP)	01/89 ⇒ 09/93
306 1.4	TU3	01/93 ⇒ 04/02
309 I 1.4	K1D(TU3A), K2B(TU3S), KDY(TU3M), KDZ(TU3M)	08/88 ⇒ 08/89
309 II 1.1	H1B(TU1), HDZ(TU1M)	09/89 ⇒ 12/93
309 II 1.4	KDZ(TU3M), TU3, TU3F2	07/89 ⇒ 12/93
405 I 1.4	K5A(TU3), TU3A, TU3F2	01/87 ⇒ 12/92
405 II 1.4	TU3F2	01/93 ⇒ 12/96
RANCH 1.4	K5A(TU3.2)	09/96 ⇒ 08/02

EPS 1.500.801

07,5

IGNITION CABLE SETS

Adatt./Suitable:

Supplied until depletion

- Fornibile fino ad esaurimento delle scorte
- Fourni jusqu'à épuisement du stock
- Lieferbar solange vorrat reicht
- Suministrado hasta el stock termina

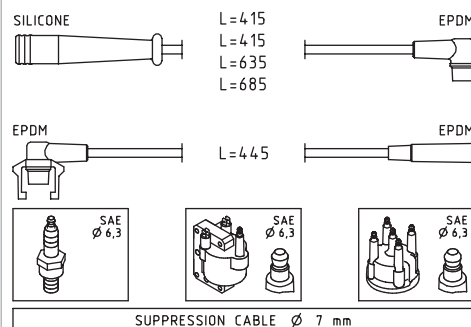

RENAULT

19 I 1.2i	E7F	01/89 ⇒ 12/92
19 I 1.4	E6J700, E6J701, E7J700	01/88 ⇒ 12/92
19 II 1.2	E7F730	05/92 ⇒ 09/94
19 II 1.4	E6J706, E7J706, E7J707, E7J742, E7J745	01/92 ⇒ 12/95
CLIO I 1.2	ESF710, ESF716, E7F700, E7F706, E7F708, E7F750	05/90 ⇒ 09/98
CLIO I 1.4	E6J712, E6J713, E6J718, E7J601, E7J710, E7J711, E7J716, E7J718, E7J719, E7J754, E7J756, E7J757	01/90 ⇒ 09/98
EXPRESS 1.4	E6J/E7J	01/85 ⇒ 10/90
MEGANE I 1.4	E7J764	09/96 ⇒ 08/03
MEGANE I 1.4 e	E7J764	01/96 ⇒ 08/03
MEGANE I 1.4 Eco	E7J624	01/96 ⇒ 03/99
MEGANE SCÉNIC I 1.4 i	E7J764	01/97 ⇒ 09/99
RAPID 1.4	E6J738, E7J720, E7J724, E7J726, E7J728, E7J770, E7J771, E7J773	09/91 ⇒ 03/98
RAPID 1.4 RN	E6J734	09/91 ⇒ 08/93

EPS 1.500.802

08

IGNITION CABLE SETS

Adatt./Suitable:

Supplied until depletion

- Fornibile fino ad esaurimento delle scorte
- Fourni jusqu'à épuisement du stock
- Lieferbar solange vorrat reicht
- Suministrado hasta el stock termina

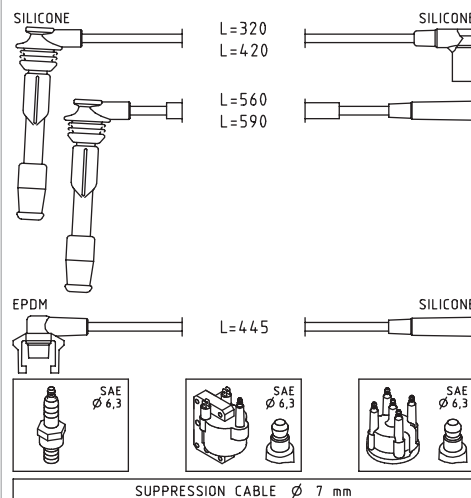

RENAULT

19 I 1.8 16V	F7P700, F7P704	06/89 ⇒ 09/92
19 II 1.8 16V	F7P704	04/92 ⇒ 06/96
CLIO I 1.8 16V	F7P720, F7P722	01/91 ⇒ 03/96
CLIO I Williams	F7R700	01/94 ⇒ 09/98

EPS 1.500.808



07

IGNITION CABLE SETS

Adatt./Suitable:

00 Eliminated on 28-06-2021. Please verify the availability through our local distributors

- Eliminato il 28-06-2021. Verificare la disponibilità presso i nostri distributori
- Éliminé le 28-06-2021. Vérifier la disponibilité auprès de nos distributeurs sur place
- Am 28-06-2021 gestrichen. Evtl. Verfügbarkeit bitte bei unseren Händlern prüfen
- Eliminado en fecha 28-06-2021. Verificar la disponibilidad a través de nuestros distribuidores locales

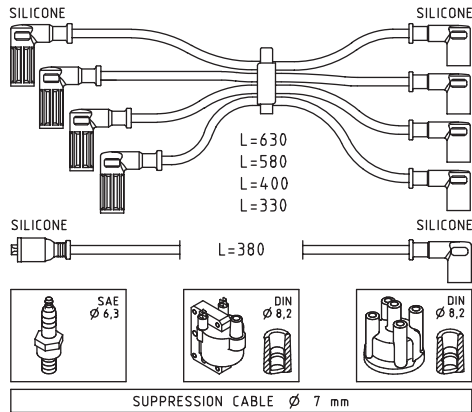

FIAT

TEMPRA 1.4 i.e.	160A1.046	04/90 ⇒ 08/96
TEMPRA 1.6	159A3.000, 159A3.048, 159A3.098	03/90 ⇒ 12/96
TEMPRA 1.6 i.e.	159A3.046, 159A3.048	06/90 ⇒ 08/96
TIPO I 1.4	160A1.048	07/87 ⇒ 12/89
TIPO I 1.4 i.e.	160A1.046	05/89 ⇒ 04/95
TIPO I 1.6	159A3.048, 160A2.000	01/88 ⇒ 10/95
TIPO I 1.6 i.e.	159A3.046, 159A3.048	07/90 ⇒ 04/95
TIPO I 1.6 SX DGT	159A3.000	05/89 ⇒ 10/95
UNO 1.4 Super	146C2.028	09/89 ⇒ 09/92
UNO 70 i.e. 1.4	146C1.000, 160A1.046	09/89 ⇒ 07/96
UNO 70 S 1.4	160A1.048	10/88 ⇒ 06/06
UNO 75 i.e. 1.5	149C1.000	10/85 ⇒ 12/93
UNO Mondo 1.4 Super	146C2.028	01/96 ⇒

EPS 1.500.815



07

IGNITION CABLE SETS

Adatt./Suitable:

00 Eliminated on 21-12-2020. Please verify the availability through our local distributors

- Eliminato il 21-12-2020. Verificare la disponibilità presso i nostri distributori
- Éliminé le 21-12-2020. Vérifier la disponibilité auprès de nos distributeurs sur place
- Am 21-12-2020 gestrichen. Evtl. Verfügbarkeit bitte bei unseren Händlern prüfen
- Eliminado en fecha 21-12-2020. Verificar la disponibilidad a través de nuestros distribuidores locales

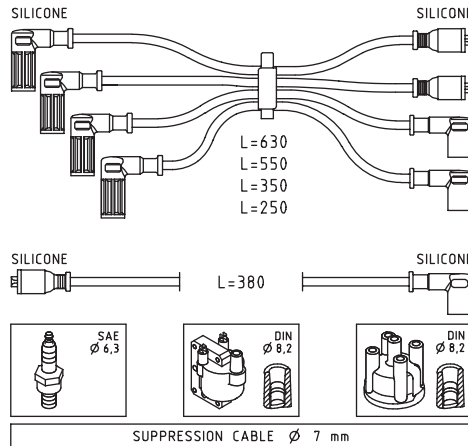

FIAT

TEMPRA 1.4 i.e.	160A1.046	04/90 ⇒ 08/96
TEMPRA 1.6	159A3.000, 159A3.048, 159A3.098	03/90 ⇒ 12/96
TEMPRA 1.6 i.e.	159A3.046, 159A3.048	06/90 ⇒ 08/96
TIPO I 1.4 i.e.	160A1.046	05/89 ⇒ 04/95
TIPO I 1.6	159A3.048	03/93 ⇒ 10/95
TIPO I 1.6 i.e.	159A3.046, 159A3.048	07/90 ⇒ 04/95
TIPO I 1.6 SX DGT	159A3.000	05/89 ⇒ 10/95

EPS 1.500.839



07

IGNITION CABLE SETS

Adatt./Suitable:

00 Eliminated on 29-07-2019. Please verify the availability through our local distributors

- Eliminato il 29-07-2019. Verificare la disponibilità presso i nostri distributori
- Éliminé le 29-07-2019. Vérifier la disponibilité auprès de nos distributeurs sur place
- Am 29-07-2019 gestrichen. Evtl. Verfügbarkeit bitte bei unseren Händlern prüfen
- Eliminado en fecha 29-07-2019. Verificar la disponibilidad a través de nuestros distribuidores locales

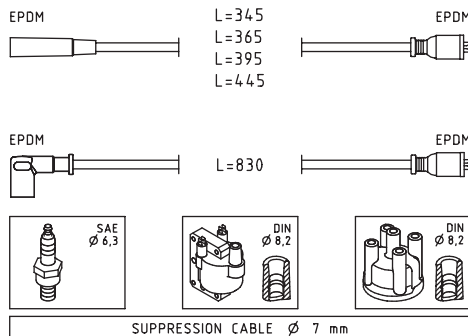

RENAULT

9 1.2	C1G700, C1G710	09/85 ⇒ 12/88
11 1.2	C1G700, C1G710	10/84 ⇒ 12/88

RENAULT

11 1.4	C2J720, C2J766, C2J767, C2J768	03/83 ⇒ 12/88
EXPRESS 1.1	C1E	01/85 ⇒ 10/90
EXPRESS 955	C1C	01/85 ⇒ 10/90
RAPID 1.0	C1C706	09/85 ⇒ 05/92
RAPID 1.1	C1E750, C1E752, C1E754, C1E756, C1E760, C1E762, C1E764, C1E792	07/85 ⇒ 10/97
SUPER 5 1.0	C1C700	10/84 ⇒ 10/88
SUPER 5 1.1	C1E750, C1E752, C1E754, C1E756, C1E760	10/84 ⇒ 12/96

EPS 1.500.846



08

IGNITION CABLE SETS

Adatt./Suitable:

PEUGEOT
5967 79
5967 84

03 Supplied until depletion

- Fornibile fino ad esaurimento delle scorte
- Fourni jusqu'à épuisement du stock
- Lieferbar solange vorrat reicht
- Suministrado hasta el stock termina

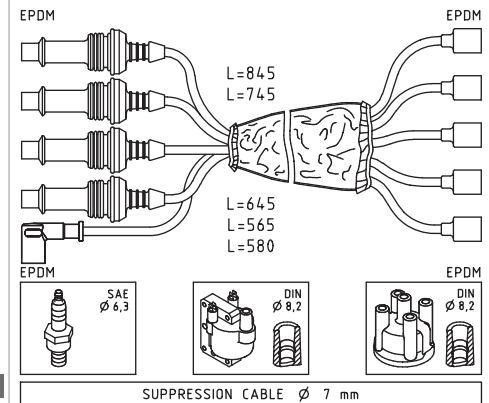

PEUGEOT

205 I 1.1	109F(XW7), 109N(XW7)	02/83 ⇒ 10/87
205 I 1.4	150(XY6B), 150B(XY8), 150D(XY7), 150G(XY7), 150H(XY8)	02/83 ⇒ 10/87
205 II 1.4	150C(XY7), 150H(XY8)	10/87 ⇒ 05/89
205 II 1.4 CJ	150D(XY7), 150G(XY7)	03/88 ⇒ 05/89
205 II 1.4 CT	150B(XY8), 150H(XY8)	04/86 ⇒ 12/88

EPS 1.500.864



07

IGNITION CABLE SETS

Adatt./Suitable:

00 Eliminated on 11-11-2019. Please verify the availability through our local distributors

- Eliminato il 11-11-2019. Verificare la disponibilità presso i nostri distributori
- Éliminé le 11-11-2019. Vérifier la disponibilité auprès de nos distributeurs sur place
- Am 11-11-2019 gestrichen. Evtl. Verfügbarkeit bitte bei unseren Händlern prüfen
- Eliminado en fecha 11-11-2019. Verificar la disponibilidad a través de nuestros distribuidores locales

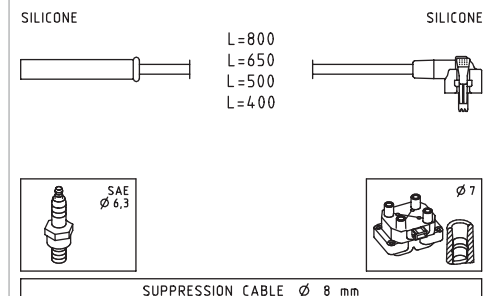

FORD

ESCORT IV 1.4	F4B, F6F, F6G	07/90 ⇒ 08/00
ESCORT V 1.4	F4B, F6F, F6G, FUH	07/90 ⇒ 01/95

FORD			
ESCORT V 1.4 i	F4B	07/93 ⇒ 01/95	
ESCORT V 1.6	LJF, LUJ, LUK	07/90 ⇒ 08/93	
ESCORT VI 1.4	F4B	01/95 ⇒ 12/99	
FIESTA III 1.4	FUG, FUJ	03/89 ⇒ 12/95	
FIESTA III 1.4 Cat	F4A	03/89 ⇒ 12/95	
FIESTA III 1.6	LUH	01/89 ⇒ 01/94	
ORION II 1.4	F6F, F6G, HL14L-FUH	07/90 ⇒ 12/93	
ORION II 1.6	LUJ, LUK	07/90 ⇒ 12/92	
ORION II 1.6 i	HL16EFI-LJE, LJF	07/90 ⇒ 09/92	

EPS 1.500.884

07

IGNITION CABLE SETS

Adatt./Suitable:

BOSCH

0 986 357 241

HITACHI

134242

MAZDA

FP13-18-140A

FP13-18-140B

FS01-18-140

00 Eliminated on 22-02-2022. Please verify the availability through our local distributors

- Eliminato il 22-02-2022. Verificare la disponibilità presso i nostri distributori

- Éliminé le 22-02-2022. Vérifier la disponibilité auprès de nos distributeurs sur place

- Am 22-02-2022 gestrichen. Evtl. Verfügbarkeit bitte bei unseren Händlern prüfen

- Eliminado en fecha 22-02-2022. Verificar la disponibilidad a través de nuestros distribuidores locales

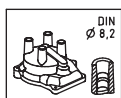
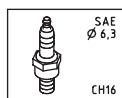
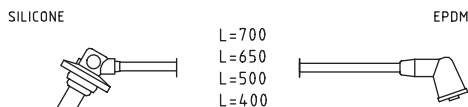

SUPPRESSION CABLE Ø 7 mm

MAZDA

626 V 1.8	FP, FP01LP	08/91 ⇒ 04/97
626 V 1.8 i	→, FP	08/91 ⇒ 06/97
626 V 2.0 i	FS	08/91 ⇒ 04/97
626 V 2.0 i 4WD	FS	04/92 ⇒ 04/97
MX-6 2.0	FS	02/92 ⇒ 02/97

EPS 1.500.887

07

IGNITION CABLE SETS

Adatt./Suitable:

BOSCH

0 986 356 733

FIAT

7745367

03 Supplied until depletion

- Fornibile fino ad esaurimento delle scorte

- Fourni jusqu'à épuisement du stock

- Lieferbar solange vorrat reicht

- Suministrado hasta el stock termina

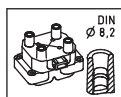
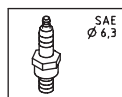
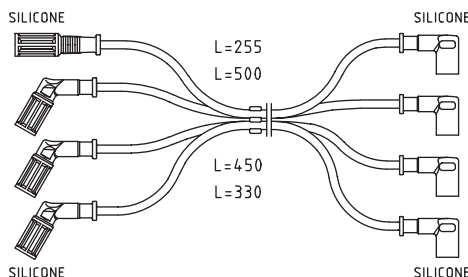

SUPPRESSION CABLE Ø 7 mm

FIAT

PANDA I 1.1	156C.046	05/91 ⇒ 03/95
-------------	----------	---------------

FIAT

PANDA I 1000 i.e	156A2.246	08/92 ⇒ 02/04
PANDA I 1000 i.e. Cat	156A2.246	10/87 ⇒ 08/98
PANDA I 1100	156C.046	05/91 ⇒ 12/99
PANDA I 1100 Trekking 4x4	156C.046	10/91 ⇒ 07/04

EPS 1.500.888

07

IGNITION CABLE SETS

Adatt./Suitable:

BOSCH

0 986 356 738

FIAT

7785350

LANCIA

7785350

MAGNETI MARELLI

941095870625

03 Supplied until depletion

- Fornibile fino ad esaurimento delle scorte

- Fourni jusqu'à épuisement du stock

- Lieferbar solange vorrat reicht

- Suministrado hasta el stock termina

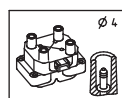
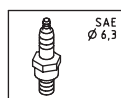
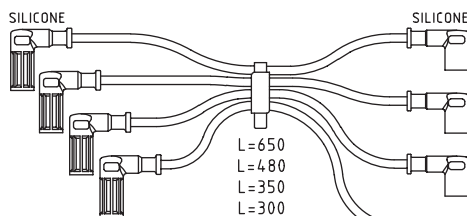

SUPPRESSION CABLE Ø 7 mm

FIAT

PUNTO I 1.6	176A9.000	01/94 ⇒ 04/97
PUNTO I 90 1.6	176A9.000	04/94 ⇒ 04/97
TEMPRA 1.6 i.e.	159B9.000	06/94 ⇒ 08/96

LANCIA

DEDRA 1.6	159B9.000	10/94 ⇒ 07/99
DEDRA 1.6 LE Cat	159B9.000	07/94 ⇒ 07/99

EPS 1.500.889

07

IGNITION CABLE SETS

Adatt./Suitable:

FIAT

7787458

LANCIA

7787458

00 Eliminated on 14-04-2020. Please verify the availability through our local distributors

- Eliminato il 14-04-2020. Verificare la disponibilità presso i nostri distributori

- Éliminé le 14-04-2020. Vérifier la disponibilité auprès de nos distributeurs sur place

- Am 14-04-2020 gestrichen. Evtl. Verfügbarkeit bitte bei unseren Händlern prüfen

- Eliminado en fecha 14-04-2020. Verificar la disponibilidad a través de nuestros distribuidores locales

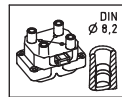
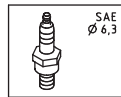
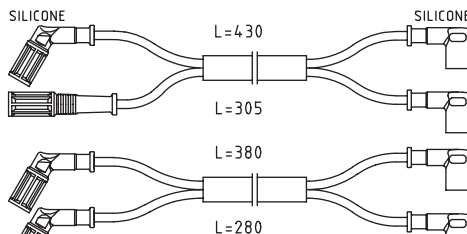

SUPPRESSION CABLE Ø 7 mm

FIAT

TEMPRA 1.8 i.e.	835C2.000, 835C4.000, 836A5.000	09/93 ⇒ 08/96
-----------------	---------------------------------	---------------

FIAT

TIPO I 1.8 i.e	836A5.000	03/93 ⇒ 04/95
TIPO I 1.8 i.e.	835C2.000, 835C4.000, 836A5.000, 836A6.000	03/93 ⇒ 10/95

LANCIA

DEDRA 1.8 i.e.	836A5.000	07/94 ⇒ 07/99
DELTA II 1.8 i.e.	835C2.000, 835C4.000, 836A5.000, 836A6.000, 836C4.000	06/93 ⇒ 08/99

EPS 1.500.900

07

IGNITION CABLE SETS

Adatt./Suitable:

00 Eliminated on 13-09-2021. Please verify the availability through our local distributors

- Eliminato il 13-09-2021. Verificare la disponibilità presso i nostri distributori

- Éliminé le 13-09-2021. Vérifier la disponibilité auprès de nos distributeurs sur place

- Am 13-09-2021 gestrichen. Evtl. Verfügbarkeit bitte bei unseren Händlern prüfen

- Eliminado en fecha 13-09-2021. Verificar la disponibilidad a través de nuestros distribuidores locales

03 Supplied until depletion

- Fornibile fino ad esaurimento delle scorte

- Fourni jusqu'à épuisement du stock

- Lieferbar solange vorrat reicht

- Suministrado hasta el stock termina

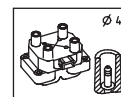
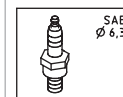
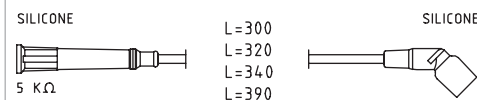

COPPER CORE CABLE Ø 7 mm

BMW

3 III 316 g	M43B16(164E2)	02/96 ⇒ 08/00
3 III 316 i	M43B16(164E2), M43B19(194E1)	09/93 ⇒ 08/00
3 III 318 i	M43B18(184E2)	09/93 ⇒ 11/99
Z3 1.8 i	M43B18(184E2)	10/95 ⇒ 10/98
Z3 1.9 i	M43B19(194E1)	07/98 ⇒ 01/03

EPS 1.500.920

07

IGNITION CABLE SETS

Adatt./Suitable:

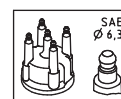
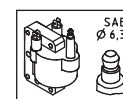
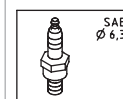
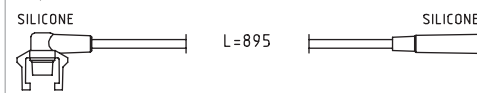
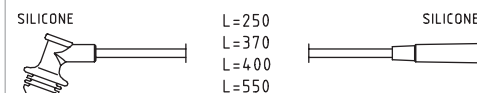

SUPPRESSION CABLE Ø 7 mm

RENAULT

LAGUNA I 1.8	F3P678, F3P720, F3P724	11/93 ⇒ 03/01
LAGUNA I 2.0	627U730, F3R722	11/93 ⇒ 03/01

EPS 1.500.956

07,5

IGNITION CABLE SETS

Adatt./Suitable:

GENERAL MOTORS
90 350 560
OPEL
16 12 512

00 Eliminated on 14-04-2020. Please verify the availability through our local distributors

- Eliminato il 14-04-2020. Verificare la disponibilità presso i nostri distributori
- Éliminé le 14-04-2020. Vérifier la disponibilité auprès de nos distributeurs sur place
- Am 14-04-2020 gestrichen. Evtl. Verfügbarkeit bitte bei unseren Händlern prüfen
- Eliminado en fecha 14-04-2020. Verificar la disponibilidad a través de nuestros distribuidores locales

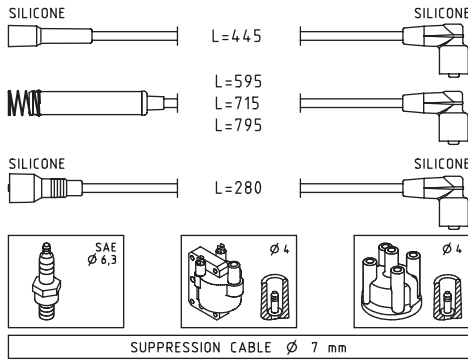

OPEL

VECTRA A 1.4 S | 14NV | 04/88 \Rightarrow 06/92

EPS 1.500.965

07

IGNITION CABLE SETS

Adatt./Suitable:

03 Supplied until depletion

- Fornibile fino ad esaurimento delle scorte
- Fourni jusqu'à épuisement du stock
- Lieferbar solange vorrat reicht
- Suministrado hasta el stock termina

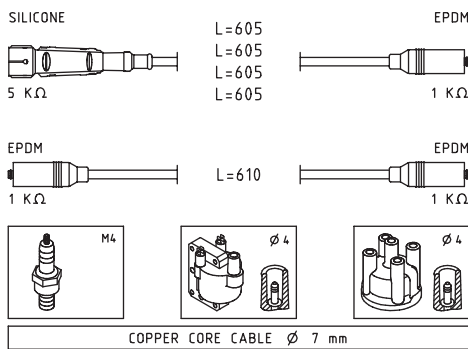

SEAT

CORDOBA I 1.6 i	1F	05/94 \Rightarrow 06/99
CORDOBA I 1.8 i	ABS, ACC, ADZ	02/93 \Rightarrow 09/02
CORDOBA I 2.0 i	2E, AGG	02/93 \Rightarrow 06/99
IBIZA II 1.6 i	1F	09/94 \Rightarrow 06/99
IBIZA II 1.8 i	ABS, ACC, ADZ	03/93 \Rightarrow 08/99
IBIZA II 2.0 i	2E, AGG	03/93 \Rightarrow 08/99
INCA 1.6 i	1F	11/95 \Rightarrow 05/98
TOLEDO I 1.6 i	1F, ABN, EZ	05/91 \Rightarrow 03/99
TOLEDO I 1.8 i	ABS, RP	05/91 \Rightarrow 12/96
TOLEDO I 2.0 i	2E, AGG	05/91 \Rightarrow 03/99

VW

CADDY II 1.6	1F	11/95 \Rightarrow 05/97
CADDY II 75 1.6	1F	11/95 \Rightarrow 05/97
CORRADO 2.0 i	2E	04/93 \Rightarrow 12/95
GOLF III 1.8	AAM	07/93 \Rightarrow 05/98
GOLF III 2.0	2E	11/91 \Rightarrow 04/99
PASSAT III 1.8	AAM, ABS, ADZ	02/88 \Rightarrow 05/97
PASSAT III 2.0	2E, ADY, AEP, AGG	02/90 \Rightarrow 05/97
PASSAT III 2.0 Syncro	2E, ADY, AGG	03/90 \Rightarrow 12/96
POLO III 75 1.6	1F	11/95 \Rightarrow 09/97

VW

VENTO 2.0 | 2E | 11/91 \Rightarrow 09/98

EPS 1.501.007

07,5

IGNITION CABLE SETS

Adatt./Suitable:

03 Supplied until depletion

- Fornibile fino ad esaurimento delle scorte
- Fourni jusqu'à épuisement du stock
- Lieferbar solange vorrat reicht
- Suministrado hasta el stock termina

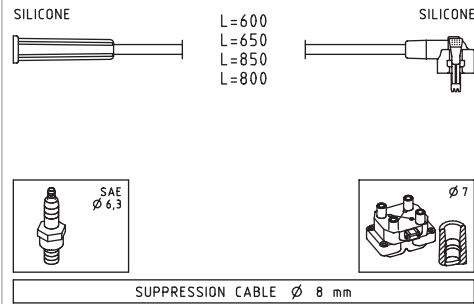

FORD

FIESTA III 1.0	TLB	03/89 \Rightarrow 12/95
FIESTA III 1.1	G6A, GUD, GUE	03/89 \Rightarrow 12/95
FIESTA III 1.3	J6B, JBB, JBC	03/89 \Rightarrow 02/96
FIESTA III 1.3 Cat	J6B	05/91 \Rightarrow 01/97
ESCORT IV 1.1	G5G	12/85 \Rightarrow 07/90
ESCORT V 1.3	J6A, JBE	07/90 \Rightarrow 01/95
ESCORT VI 1.3	BL13H-JBE, J6A	01/95 \Rightarrow 02/99
ESCORT III 1.1	G5G	05/86 \Rightarrow 07/90
ORION II 1.3	BL13H-JBE, J4B, J6A	07/90 \Rightarrow 12/94

EPS 1.501.025

07

IGNITION CABLE SETS

Adatt./Suitable:

BOSCH
0 986 357 240

CITROËN
5967 L9

MAGNETI MARELLI
941135130701

PEUGEOT
5967 L9

03 Supplied until depletion

- Fornibile fino ad esaurimento delle scorte
- Fourni jusqu'à épuisement du stock
- Lieferbar solange vorrat reicht
- Suministrado hasta el stock termina

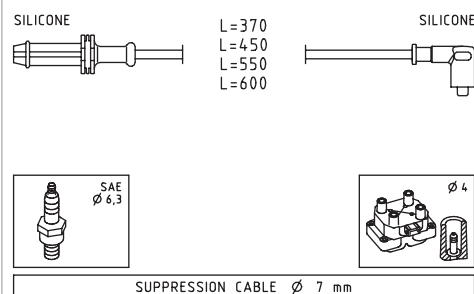

PEUGEOT

106 I 1.4 i	TU3FJ, TU3FMC	01/91 \Rightarrow 12/96
306 1.1	HDZ(TU1M)	05/93 \Rightarrow 05/01
306 1.4	KDX(TU3MC)	04/93 \Rightarrow 07/01
306 1.4 SL	KDX(TU3MC)	06/94 \Rightarrow 05/01
306 1.6	NFZ(TU5JP)	05/93 \Rightarrow 10/00
306 1.6 SR	NFZ(TU5JP)	06/94 \Rightarrow 10/00
405 II 1.4	TU3FM	01/93 \Rightarrow 12/96

EPS

1.501.078

07

IGNITION CABLE SETS

Adatt./Suitable:

03 Supplied until depletion

- Fornibile fino ad esaurimento delle scorte
- Fourni jusqu'à épuisement du stock
- Lieferbar solange vorrat reicht
- Suministrado hasta el stock termina

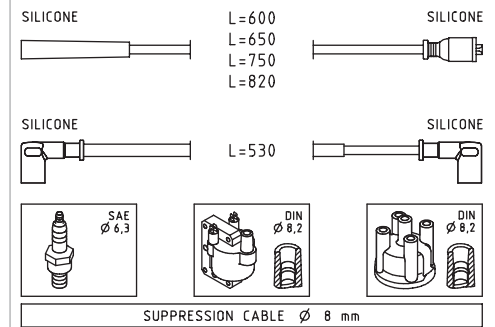

FORD

CORTINA 1300	KL13H	10/70 \Rightarrow 03/72
GRANADA 1.7	TV17LC	08/77 \Rightarrow 05/82
GRANADA 2.0	NEP	08/79 \Rightarrow 08/85
P 100 1.6	LCR	04/82 \Rightarrow 09/87
P 100 2.0	NAE	10/87 \Rightarrow 12/92
SCORPIO I 1.8	REC	04/85 \Rightarrow 02/92
SCORPIO I 2.0	TL20H-NE4, TL20H-NER	10/84 \Rightarrow 02/90
SCORPIO I 2.0 i	NRA, NRI	04/85 \Rightarrow 02/92
SIERRA I 1.3	JCT	08/82 \Rightarrow 12/86
TRANSIT II 1.6	LAC, LAT	09/85 \Rightarrow 09/92
TRANSIT II 2.0	N6T5, NAT, NAV, NAW	09/85 \Rightarrow 09/92
TRANSIT II 2.0 Cat	N6T	11/85 \Rightarrow 09/92
TRANSIT II 2.0 L	NAW, NAX	10/85 \Rightarrow 03/91

EPS

1.501.138

07

IGNITION CABLE SETS

Adatt./Suitable:

BOSCH
0 986 357 161

SAAB
88 17 520

00 Eliminated on 14-04-2020. Please verify the availability through our local distributors

- Eliminato il 14-04-2020. Verificare la disponibilità presso i nostri distributori
- Éliminé le 14-04-2020. Vérifier la disponibilité auprès de nos distributeurs sur place
- Am 14-04-2020 gestrichen. Evtl. Verfügbarkeit bitte bei unseren Händlern prüfen
- Eliminado en fecha 14-04-2020. Verificar la disponibilidad a través de nuestros distribuidores locales

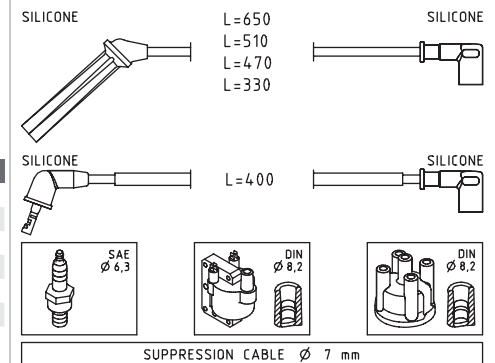

SAAB

900 I 2.0-16	5B6304GS, B202XI	01/86 \Rightarrow 12/93
900 I 2.0 Turbo-16	B202L, B202XL	11/85 \Rightarrow 06/94
900 I 2.0 Turbo-16 S	B202XL	02/84 \Rightarrow 12/88
900 I 2.0 Turbo-16 S Cat	B202XL	01/89 \Rightarrow 12/93
9000 2.0-16	5B6304GS, B202XI	12/85 \Rightarrow 01/93
9000 2.0-16 CS	5B6304GS	01/89 \Rightarrow 12/98
9000 2.0-16 Turbo	B202XL	09/84 \Rightarrow 08/93
9000 2.0-16 Turbo CD	B202XL	09/88 \Rightarrow 08/93

1.501.140

SAAB		
9000 2.3 -16 CD	B234I	08/89 ⇒ 12/98
9000 2.3 -16 CS	B234I	09/89 ⇒ 12/98

EPS 1.501.140 07

IGNITION CABLE SETS

Adatt./Suitable:

SAAB
93 37 346

⁰⁰ Eliminated on 22-02-2022. Please verify the availability through our local distributors

- Eliminato il 22-02-2022. Verificare la disponibilità presso i nostri distributori
- Éliminé le 22-02-2022. Vérifier la disponibilité auprès de nos distributeurs sur place
- Am 22-02-2022 gestrichen. Evtl. Verfügbarkeit bitte bei unseren Händlern prüfen
- Eliminado en fecha 22-02-2022. Verificar la disponibilidad a través de nuestros distribuidores locales

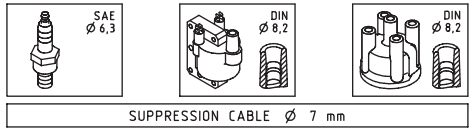
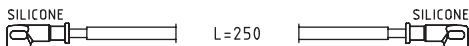
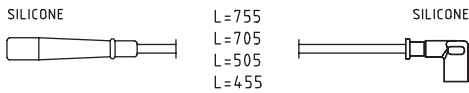

SAAB		
90 2.0	B20I	08/84 ⇒ 08/87
900 I 2.0 c	B201XC	09/79 ⇒ 12/88
900 I 2.0 i	0TLE4G15, B201XI	11/80 ⇒ 08/90
900 I 2.0 Turbo	B201XL	01/86 ⇒ 12/91

EPS 1.501.145 07

IGNITION CABLE SETS

Adatt./Suitable:

⁰³ Supplied until depletion

- Fornibile fino ad esaurimento delle scorte
- Fourni jusqu'à épuisement du stock
- Lieferbar solange vorrat reicht
- Suministrado hasta el stock termina

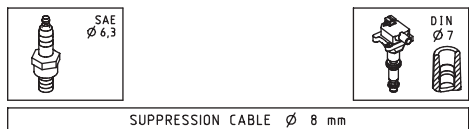
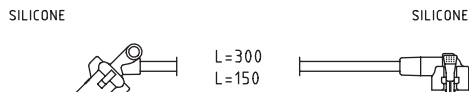

FORD		
ESCORT V RS 2000	N7A	05/91 ⇒ 01/95
ESCORT VI RS 2000	N7A	02/95 ⇒ 02/98
ESCORT VI RS 2000 4x4	N7A	02/95 ⇒ 10/98
GALAXY I 2.3 16V	YSB	01/97 ⇒ 05/06
SCORPIO II 2.0 i 16V	N3A	10/94 ⇒ 08/98
SCORPIO II 2.3 i 16V	YSA	06/96 ⇒ 08/98
TRANSIT III 2.3	ESFA, ESFC	08/00 ⇒ 03/06
TRANSIT III 2.3 16V	ESFA, ESFC	04/01 ⇒ 05/06
TRANSIT III 2.3 16V RWD	ESFA, ESFC	08/00 ⇒ 05/06

EPS 1.501.209 07

IGNITION CABLE SETS

Adatt./Suitable:

BOSCH
0 986 356 928
F 005 X03 926

HITACHI
134130

HOLDEN
9091922327

MAGNETI MARELLI
941318111274

TOYOTA
90919-22327

⁰³ Supplied until depletion

- Fornibile fino ad esaurimento delle scorte
- Fourni jusqu'à épuisement du stock
- Lieferbar solange vorrat reicht
- Suministrado hasta el stock termina

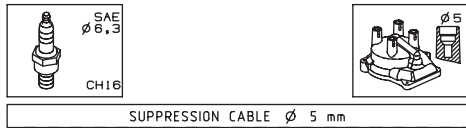
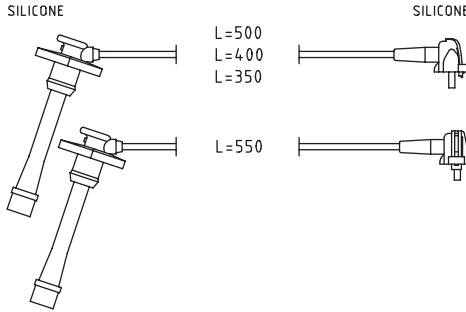

HOLDEN		
NOVA_LF 1.8i Hatchback	7AFE	08/91 ⇒ 03/93
NOVA_LF 1.8i Sedan	7AFE	08/91 ⇒ 03/93
NOVA_LG 1.6i Hatchback	4AFE	09/94 ⇒ 09/96
NOVA_LG 1.6i Sedan	4AFE	09/94 ⇒ 09/96
NOVA_LG 1.8i Hatchback	7AFE	09/94 ⇒ 09/96
NOVA_LG 1.8i Sedan	7AFE	09/94 ⇒ 09/96

TOYOTA		
AVENSIS I 1.6	4A-FE	09/97 ⇒ 10/00
CARINA E 1.6	4A-FE	04/92 ⇒ 09/97
CARINA E 1.6 16V	4A-FE	12/94 ⇒ 09/97
CARINA E 1.6 GLI	4A-FE	04/92 ⇒ 09/97
CARINA E 1.6 i	4A-FE	02/95 ⇒ 09/97
COROLLA VII 1.6 GLI	4A-FE	07/92 ⇒ 04/97
COROLLA VII 1.6 Si	4A-FE	07/92 ⇒ 04/97
COROLLA VII 1.8 16V 4WD	7A-FE	09/95 ⇒ 04/97
COROLLA VII 1.8 GT	7A-FE	11/92 ⇒ 05/95
COROLLA VIII 1.6	4A-FE	04/97 ⇒ 02/00
COROLLA VIII 1.6 Aut.	4A-FE	04/97 ⇒ 02/00
COROLLA VIII 1.8 4WD	7A-FE	04/97 ⇒ 10/01
CELICA VI 1.8 i 16V	7A-FE	11/93 ⇒ 11/99
CELICA VI 1.8 i 16V [USA] [CAN]	7A-FE	09/93 ⇒ 08/99

EPS 1.501.231 07

IGNITION CABLE SETS

Adatt./Suitable:

BOSCH
0 986 357 149

MAZDA

B69F-18-140A
B69F-18-140B
B6BF-18-140A
B6BF-18-140B

⁰⁰ Eliminated on 22-02-2021. Please verify the availability through our local distributors

- Eliminato il 22-02-2021. Verificare la disponibilità presso i nostri distributori
- Éliminé le 22-02-2021. Vérifier la disponibilité auprès de nos distributeurs sur place
- Am 22-02-2021 gestrichen. Evtl. Verfügbarkeit bitte bei unseren Händlern prüfen
- Eliminado en fecha 22-02-2021. Verificar la disponibilidad a través de nuestros distribuidores locales

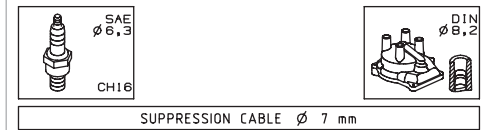
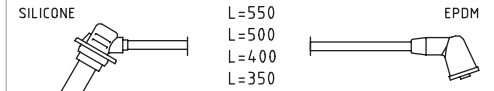

MAZDA		
323 VII C 1.8 16V	BP-ZE	08/94 ⇒ 09/98
323 VII 1.8 16V	BP-ZE	08/94 ⇒ 09/98
323 VIII S 1.8 16V	BP-ZE	08/94 ⇒ 09/98
MX-3 1.6i	B6D	11/93 ⇒ 09/98
XEDOS 6 1.6 16V	B6(DOHC), B69	01/92 ⇒ 10/99

EPS 1.501.237 07,5

IGNITION CABLE SETS

Adatt./Suitable:

BOSCH
0 986 356 747
0 986 357 127
0 986 357 148
0 986 357 156
F 005 X11 115

GENERAL MOTORS

90 442 406
90 442 410
90 443 690
90 443 691

HITACHI
134296

HOLDEN
90443690

MAGNETI MARELLI
941125120666

OPEL

16 12 533
16 12 541
16 12 544
16 12 556
16 12 557
16 12 610

⁰³ Supplied until depletion

- Fornibile fino ad esaurimento delle scorte
- Fourni jusqu'à épuisement du stock
- Lieferbar solange vorrat reicht
- Suministrado hasta el stock termina

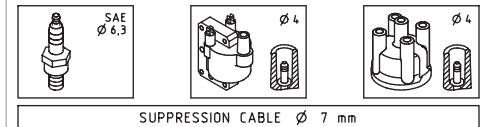
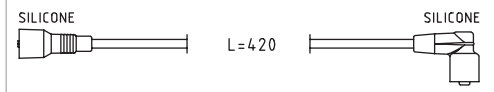
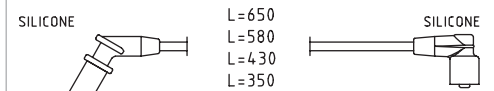

HOLDEN		
BARINA 1.4i	C14NZ	04/94 ⇒ 07/97

HOLDEN			
BARINA_SB 1.2i	C12NZ	04/94 ⇒	07/97
COMBO 1.4 i	C14NZ	03/96 ⇒	07/97
COMBO_SB 1.4i	C14NZ	04/94 ⇒	07/97
OPEL			
ASTRA F 1.4	14NV, 14SE	09/91 ⇒	09/98
ASTRA F 1.4 i	C14NZ	09/91 ⇒	01/05
ASTRA F 1.4 Si	C14SE	03/92 ⇒	03/01
COMBO B 1.2	C12NZ, X12SZ	07/94 ⇒	10/01
CORSA A 1.2 i	C12NZ	09/89 ⇒	03/93
CORSA A 1.4 i	C14NZ	01/85 ⇒	03/93
CORSA A 1.4 S	14NV	09/89 ⇒	03/93
CORSA A 1.4 Si	C14SE	09/91 ⇒	03/93
CORSA B 1.2 i	12NZ, C12NZ, X12SZ	03/93 ⇒	09/00
KADETT E 1.4 i	C14NZ	01/90 ⇒	07/94
KADETT E 1.4 S	14NV	07/89 ⇒	02/93
KADETT E 1.6	16SV	09/86 ⇒	12/91
KADETT E 1.6 i	16SV	07/89 ⇒	02/93
KADETT E 1.6 S	16SV	09/86 ⇒	08/91
VECTRA A 1.4 S	14NV	04/88 ⇒	06/92
VECTRA A 1.6	16SV	09/88 ⇒	05/93
VECTRA A 1.6 i	C16NZ, E16NZ	09/88 ⇒	11/95
VECTRA A 1.6 i Cat	C16NZ	09/88 ⇒	11/95
VECTRA A 1.6 S	16SV	09/88 ⇒	05/93
VAUXHALL			
ASTRA III 1.4	14NV	09/91 ⇒	09/93
ASTRA III 1.4 i	C14NZ, C14SE	03/91 ⇒	09/98
ASTRA III 1.4 S	14NV	09/91 ⇒	02/98
ASTRAVAN I 1.4 i	C14NZ	09/91 ⇒	08/95
COMBO B 1.2	C12NZ, X12SZ	07/94 ⇒	10/01
CORSA B 1.2 i	C12NZ, X12SZ	03/93 ⇒	09/00

EPS **1.501.278** **07,5**

IGNITION CABLE SETS

Adatt./Suitable:

BOSCH

0 986 357 147

HITACHI

134279

MAGNETI MARELLI

941285030866

MITSUBISHI

MD183124

MD193015

MD198216

MD310297

MD315902

MD334017

MD334021

MD334026

MD334039

03 Supplied until depletion

- Fornibile fino ad esaurimento delle scorte
- Fourni jusqu'à épuisement du stock
- Lieferbar solange vorrat reicht
- Suministrado hasta el stock termina

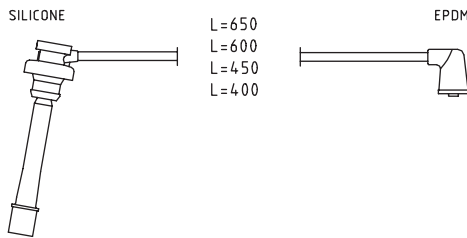

SUPPRESSION CABLE Ø 7 mm

MITSUBISHI

COLT IV 1.6 4WD	4G92(SOHC16V)	08/93 ⇒	08/95
COLT IV 1.6 GLXi 16V	4G92(SOHC16V)	04/92 ⇒	04/96
GALANT VII 1.8	4G93(SOHC16V)	02/94 ⇒	08/96
GALANT VII 1.8 GLSi	4G93(SOHC16V)	11/92 ⇒	08/96
GALANT VII 2.0 GLSi	4G63(SOHC16V)	11/92 ⇒	08/96
GALANT VII 2.0 GLSi 4WD	4G63(SOHC16V)	11/92 ⇒	08/96
LANCER V 1.6 16V	4G92(SOHC16V)	06/92 ⇒	05/94
LANCER V 1.6 4WD	4G92(SOHC16V)	06/92 ⇒	11/93
LANCER VI 1.6	4G92(SOHC16V)	02/94 ⇒	12/96
LANCER VI 1.6 16V	4G92(SOHC16V)	06/92 ⇒	10/03
LANCER VI 1.6 16V 4WD	4G92(SOHC16V)	06/92 ⇒	10/03
LANCER VI 1.6 i	4G92(SOHC16V)	09/92 ⇒	07/96
SPACE RUNNER 1.8	4G93(SOHC16V)	10/91 ⇒	08/99
SPACE RUNNER 1.8 4WD	4G93(SOHC16V)	10/91 ⇒	08/99
SPACE WAGON 1.8	4G93(SOHC16V)	10/91 ⇒	10/98
SPACE WAGON 1.8 4WD	4G93(SOHC16V)	10/91 ⇒	10/98
SPACE WAGON 2.0	4G63(SOHC16V)	10/92 ⇒	10/98
SPACE WAGON 2.0 4WD	4G63(SOHC16V)	10/92 ⇒	10/98

EPS **1.501.281** **07**

IGNITION CABLE SETS

Adatt./Suitable:

00 Eliminated on 02-12-2019. Please verify the availability through our local distributors

- Eliminato il 02-12-2019. Verificare la disponibilità presso i nostri distributori
- Éliminé le 02-12-2019. Vérifier la disponibilité auprès de nos distributeurs sur place
- Am 02-12-2019 gestrichen. Evtl. Verfügbarkeit bitte bei unseren Händlern prüfen
- Eliminado en fecha 02-12-2019. Verificar la disponibilidad a través de nuestros distribuidores locales

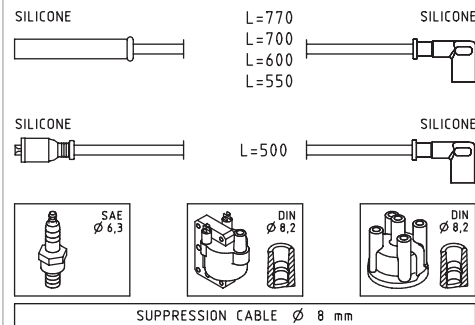

SUPPRESSION CABLE Ø 8 mm

FORD

ESCORT IV 1.4	F6D, FUC	01/86 ⇒	07/90
ESCORT IV 1.6 XR3i	LR2, LRB	01/86 ⇒	07/90
FIESTA II 1.4	FUB, FUD	10/85 ⇒	11/89
FIESTA II 1.6 XR2	LUB, LUD	03/84 ⇒	02/89
FIESTA III 1.4	F6E	03/89 ⇒	12/95
ESCORT III 1.4 i	F6D, FUC	02/86 ⇒	07/90
ORION I 1.4 Cat	F6D	02/87 ⇒	07/90
ORION I 1.6 i	LRB	03/86 ⇒	07/90

EPS **1.501.300** **07,5**

IGNITION CABLE SETS

Adatt./Suitable:

03 Supplied until depletion

- Fornibile fino ad esaurimento delle scorte
- Fourni jusqu'à épuisement du stock
- Lieferbar solange vorrat reicht
- Suministrado hasta el stock termina

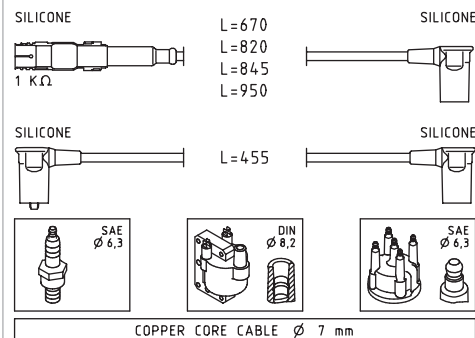

COPPER CORE CABLE Ø 7 mm

MERCEDES-BENZ

190 2.3	M102.985	09/87 ⇒	09/88
190 2.3 E	M102.985	10/82 ⇒	09/88
190 E 1.8	M102.910, M102.919	04/90 ⇒	12/93
190 E 2.0	M102.962	10/82 ⇒	08/93
190 E 2.3	M102.985	09/86 ⇒	08/93
KOMBI II 200 TE	M102.962	09/88 ⇒	12/89

EPS **1.501.305** **07,5**

IGNITION CABLE SETS

Adatt./Suitable:

03 Supplied until depletion

- Fornibile fino ad esaurimento delle scorte
- Fourni jusqu'à épuisement du stock
- Lieferbar solange vorrat reicht
- Suministrado hasta el stock termina

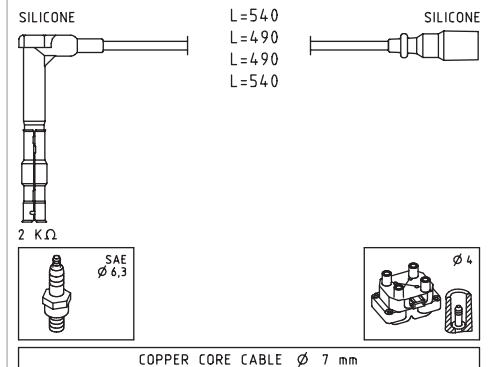

COPPER CORE CABLE Ø 7 mm

MERCEDES-BENZ

CLASSE C I C 180	M111.920	03/93 ⇒	05/00
CLASSE C I C 180 T	M111.920	06/96 ⇒	09/00
CLASSE C I C 200	M111.941	01/94 ⇒	05/00
CLASSE C I C 200 T	M111.941	06/96 ⇒	03/01

EPS **1.501.323** **09**

IGNITION CABLE SETS

Adatt./Suitable:

00 Eliminated on 22-02-2022. Please verify the availability through our local distributors

- Eliminato il 22-02-2022. Verificare la disponibilità presso i nostri distributori
- Éliminé le 22-02-2022. Vérifier la disponibilité auprès de nos distributeurs sur place
- Am 22-02-2022 gestrichen. Evtl. Verfügbarkeit bitte bei unseren Händlern prüfen
- Eliminado en fecha 22-02-2022. Verificar la disponibilidad a través de nuestros distribuidores locales

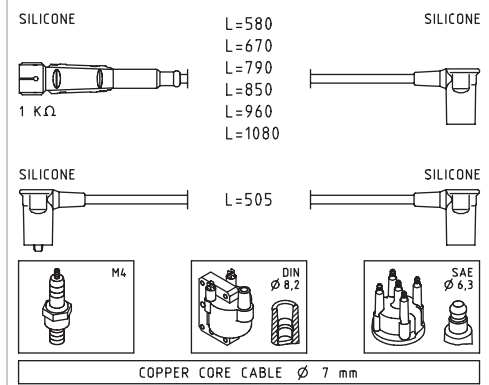

COPPER CORE CABLE Ø 7 mm

MERCEDES-BENZ

123 280 CE	M110.988	03/77 ⇒	11/85
CLASSE S II 280 SE, SEL	M110.989	10/79 ⇒	07/85
TRE VOLUMI I 280 E	M110.988	02/76 ⇒	11/85

1.501.332

EPS 1.501.332

07

IGNITION CABLE SETS

Adatt./Suitable:

⁰³ Supplied until depletion

- Fornibile fino ad esaurimento delle scorte
- Fourni jusqu'à épuisement du stock
- Lieferbar solange vorrat reicht
- Suministrado hasta el stock termina

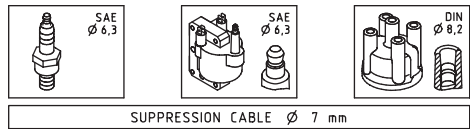
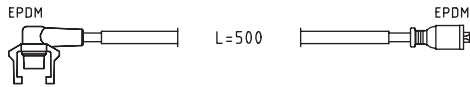
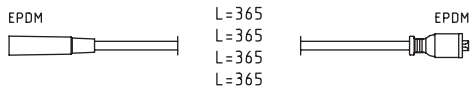
SUPPRESSION CABLE \varnothing 7 mm

RENAULT

TWINGO 1.2	C3G700, C3G702	03/93 \Rightarrow 10/96
------------	----------------	---------------------------

VOLVO

340-360 1.3	B13, B13.4E	08/88 \Rightarrow 12/90
340-360 1.4	B14.3E, B14.4E, B14.4ED, B14.40, B14.45	08/82 \Rightarrow 07/91

EPS 1.501.343

07,5

IGNITION CABLE SETS

Adatt./Suitable:

BOSCH
0 986 357 248

CHRYSLER
4797685
SPW07685AA

⁰⁰ Eliminated on 09-12-2019. Please verify the availability through our local distributors

- Eliminato il 09-12-2019. Verificare la disponibilità presso i nostri distributori
- Éliminé le 09-12-2019. Vérifier la disponibilité auprès de nos distributeurs sur place
- Am 09-12-2019 gestrichen. Evtl. Verfügbarkeit bitte bei unseren Händlern prüfen
- Eliminado en fecha 09-12-2019. Verificar la disponibilidad a través de nuestros distribuidores locales

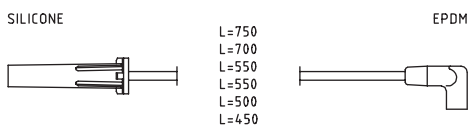
SUPPRESSION CABLE \varnothing 7 mm

CHRYSLER

VOYAGER II 3.3 i	R00	01/95 \Rightarrow 03/01
VOYAGER II 3.8 i AWD	EGH, L00	01/95 \Rightarrow 03/01

EPS 1.501.344

07,5

IGNITION CABLE SETS

Adatt./Suitable:

MITSUBISHI
MD338249
MD371794
MD371980

⁰⁰ Eliminated on 07-10-2019. Please verify the availability through our local distributors

- Eliminato il 07-10-2019. Verificare la disponibilità presso i nostri distributori
- Éliminé le 07-10-2019. Vérifier la disponibilité auprès de nos distributeurs sur place
- Am 07-10-2019 gestrichen. Evtl. Verfügbarkeit bitte bei unseren Händlern prüfen
- Eliminado en fecha 07-10-2019. Verificar la disponibilidad a través de nuestros distribuidores locales

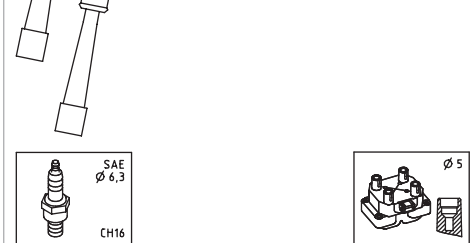
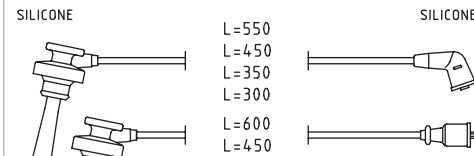
SUPPRESSION CABLE \varnothing 5 mm

MITSUBISHI

PAJERO III 3.0	6G72(SOHC24V)	10/01 \Rightarrow 12/06
PAJERO III 3.0 ZR	6G72(DOHC24V)	08/03 \Rightarrow
PAJERO III 3.5	6G74(DOHC24V)	04/00 \Rightarrow 01/07
PAJERO III 3.5 i	6G74(DOHC24V), 6G74(SOHC24V)	09/03 \Rightarrow 10/06
PAJERO III 3.5 V6 GDI	6G74(GDI)	04/00 \Rightarrow 12/06
PAJERO II 3.0 V6 24V	6G72(SOHC24V)	06/94 \Rightarrow 04/00
PAJERO II 3.5 V6 24V	6G74(DOHC24V), 6G74(SOHC24V)	06/94 \Rightarrow 10/99
PAJERO SPORT I 3.0 4WD	6G72(SOHC24V)	09/96 \Rightarrow 12/01
PAJERO SPORT I 3.0 V6	6G72(SOHC24V)	06/00 \Rightarrow
PAJERO SPORT I 3.0 V6 4WD	6G72(DOHC24V)	03/03 \Rightarrow

EPS 1.501.345

07,5

IGNITION CABLE SETS

Adatt./Suitable:

CHRYSLER
5019593AA

⁰³ Supplied until depletion

- Fornibile fino ad esaurimento delle scorte
- Fourni jusqu'à épuisement du stock
- Lieferbar solange vorrat reicht
- Suministrado hasta el stock termina

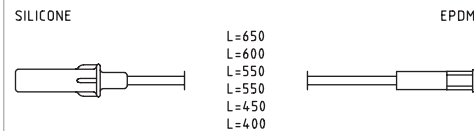
SUPPRESSION CABLE \varnothing 7 mm

CHRYSLER

VOYAGER III 3.3	EGA	02/00 \Rightarrow 12/08
VOYAGER III 3.3 AWD	EGA	02/00 \Rightarrow 12/08

EPS 1.501.353

07

IGNITION CABLE SETS

Adatt./Suitable:

⁰⁰ Eliminated on 22-02-2022. Please verify the availability through our local distributors

- Eliminato il 22-02-2022. Verificare la disponibilità presso i nostri distributori
- Éliminé le 22-02-2022. Vérifier la disponibilité auprès de nos distributeurs sur place
- Am 22-02-2022 gestrichen. Evtl. Verfügbarkeit bitte bei unseren Händlern prüfen
- Eliminado en fecha 22-02-2022. Verificar la disponibilidad a través de nuestros distribuidores locales

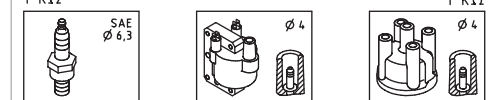
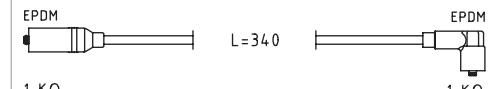
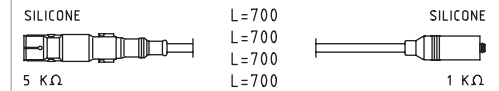
COPPER CORE CABLE \varnothing 7 mm

AUDI

A4 I 1.6	ADP	11/94 \Rightarrow 09/01
----------	-----	---------------------------

VW

PASSAT IV 1.6	ADP	10/96 \Rightarrow 11/00
---------------	-----	---------------------------

EPS 1.501.356

08

IGNITION CABLE SETS

Adatt./Suitable:

⁰⁰ Eliminated on 22-02-2021. Please verify the availability through our local distributors

- Eliminato il 22-02-2021. Verificare la disponibilità presso i nostri distributori
- Éliminé le 22-02-2021. Vérifier la disponibilité auprès de nos distributeurs sur place
- Am 22-02-2021 gestrichen. Evtl. Verfügbarkeit bitte bei unseren Händlern prüfen
- Eliminado en fecha 22-02-2021. Verificar la disponibilidad a través de nuestros distribuidores locales

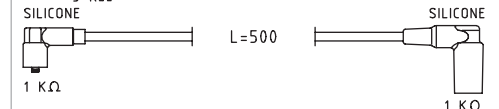
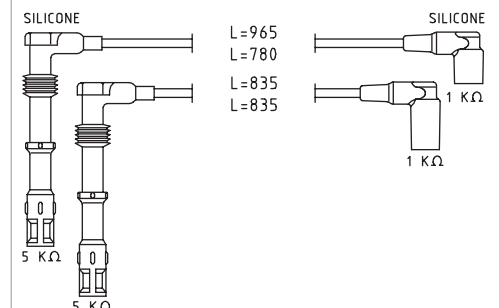
COPPER CORE CABLE \varnothing 7 mm

AUDI

100 IV 2.0 E 16V	ACE	01/92 \Rightarrow 07/94
100 IV 2.0 E 16V quattro	ACE	07/92 \Rightarrow 07/94
A6 I 2.0 16V	ACE	06/94 \Rightarrow 12/97
A6 I 2.0 16V quattro	ACE	06/94 \Rightarrow 12/97

EPS 1.501.363



07

IGNITION CABLE SETS

Adatt./Suitable:

BOSCH

0 356 912 881

FIAT

7760523

HITACHI

134534

134758

IVECO

7760523

LANCIA

7760523

MAGNETI MARELLI

941095790617

03 Supplied until depletion

- Fornibile fino ad esaurimento delle scorte
- Fourni jusqu'à épuisement du stock
- Lieferbar solange vorrat reicht
- Suministrado hasta el stock termina

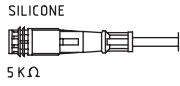

L = 580
L = 550
L = 480
L = 330

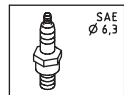
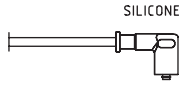
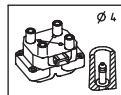
SAE
ø 6,3

ø 4

COPPER CORE CABLE ø 7 mm

FIAT

BRAVA 1.4	182A5.000	10/95 ⇒ 10/01
BRAVA 1.4 12V	182A3.000	10/95 ⇒ 08/98
BRAVO I 1.4	182A3.000, 182A5.000	10/95 ⇒ 10/01
MAREA 1.4 80 12V	182A3.000	09/96 ⇒ 05/02

LANCIA

YI 1.4 12V	840A2.000, 840A4.000	03/96 ⇒ 09/03
------------	----------------------	---------------

EPS 1.501.364



07

IGNITION CABLE SETS

Adatt./Suitable:

03 Supplied until depletion

- Fornibile fino ad esaurimento delle scorte
- Fourni jusqu'à épuisement du stock
- Lieferbar solange vorrat reicht
- Suministrado hasta el stock termina

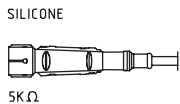

L = 630
L = 630
L = 630
L = 630

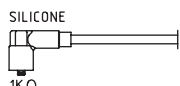
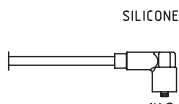

L = 495

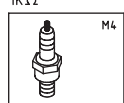
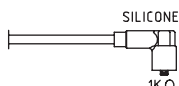

M4

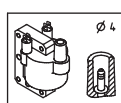

ø 4

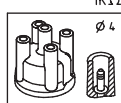

ø 4

COPPER CORE CABLE ø 7 mm

SEAT

CORDOBA I 1.4 i	ABD	06/94 ⇒ 10/02
CORDOBA I 1.6 i	ABU	02/93 ⇒ 10/02
IBIZA II 1.4 i	ABD	09/93 ⇒ 02/02
IBIZA II 1.6 i	ABU	03/93 ⇒ 02/02

VW

POLO II 1.0	AAU, HZ	01/85 ⇒ 09/94
POLO II 1.0 Cat	AAU, ACM	08/89 ⇒ 09/94
POLO II 1.3	3F	10/90 ⇒ 09/94
POLO II 1.3 Cat	2G, 3F, AAV, MH, NZ	07/87 ⇒ 09/94
POLO II 1.3 G40	PY	08/90 ⇒ 09/94
GOLF III 1.6	ABU, AEA	09/92 ⇒ 08/97
POLO III 45 1.0	AEV	10/94 ⇒ 09/96
POLO III 50 1.0	AER	09/96 ⇒ 10/99
POLO III 55 1.3	ADX	10/94 ⇒ 04/97
POLO IV 1.0	AER	08/96 ⇒ 12/01
VENTO 1.6	ABU	09/92 ⇒ 09/98

EPS 1.501.373



07

IGNITION CABLE SETS

Adatt./Suitable:

00 Eliminated on 22-02-2022. Please verify the availability through our local distributors

- Eliminato il 22-02-2022. Verificare la disponibilità presso i nostri distributori
- Éliminé le 22-02-2022. Vérifier la disponibilité auprès de nos distributeurs sur place
- Am 22-02-2022 gestrichen. Evtl. Verfügbarkeit bitte bei unseren Händlern prüfen
- Eliminado en fecha 22-02-2022. Verificar la disponibilidad a través de nuestros distribuidores locales

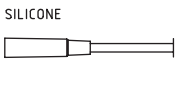

L = 300
L = 370
L = 400
L = 505

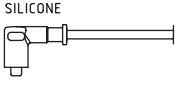
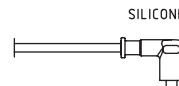

L = 380

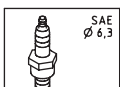
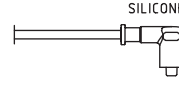

ø 4

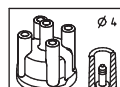
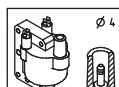

ø 4

SUPPRESSION CABLE ø 7 mm

SKODA

FELICIA 1.3	135, 135L, 136i	10/94 ⇒ 03/98
-------------	-----------------	---------------

EPS 1.501.374



07

IGNITION CABLE SETS

Adatt./Suitable:

BOSCH

0 986 357 240

CITROËN

5967 N6

5967 P1

PEUGEOT

5967 N6

5967 P1

00 Eliminated on 10-12-2021. Please verify the availability through our local distributors

- Eliminato il 10-12-2021. Verificare la disponibilità presso i nostri distributori
- Éliminé le 10-12-2021. Vérifier la disponibilité auprès de nos distributeurs sur place
- Am 10-12-2021 gestrichen. Evtl. Verfügbarkeit bitte bei unseren Händlern prüfen
- Eliminado en fecha 10-12-2021. Verificar la disponibilidad a través de nuestros distribuidores locales

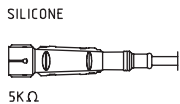

L = 280
L = 380
L = 500
L = 580

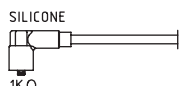
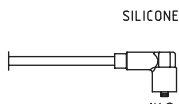
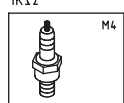
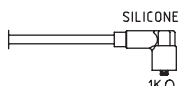
L = 280
L = 380
L = 500
L = 580

ø 6,3

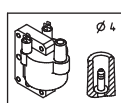

ø 4

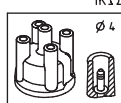

ø 4

SUPPRESSION CABLE ø 7 mm

CITROËN

AX 1.4 GTi	KFY(TU3FJ2), KFZ(TU3FJ2)	06/91 ⇒ 12/96
AX 10	CDY(TU9M), CDZ(TU9M)	07/86 ⇒ 12/98
AX 11	HDZ(TU1M)	09/86 ⇒ 12/97
AX 14	K6B(TU3FJ2), KDX(TU3M/Z), KDY(TU3FM)	04/87 ⇒ 04/97
AX 14 4x4	KDY(TU3FM)	08/91 ⇒ 12/96
XSARA 1.4 i	KFX(TU3JP)	04/97 ⇒ 08/05
XSARA 1.6 i	NFZ(TU5JP)	04/97 ⇒ 09/00
BERLINGO I 1.1 i	HDZ(TU1M)	07/96 ⇒ 05/08
BERLINGO I 1.4 i	KFW(TU3JP), KFX(TU3JP)	07/96 ⇒ 12/11
BERLINGO I 1.4 i bivalent	KFW(TU3JP)	04/03 ⇒ 10/05
SAXO 1.0 X	CDZ(TU9M)	05/96 ⇒ 11/98
SAXO 1.1 X, SX	HDZ(TU1M)	05/96 ⇒ 09/03
SAXO 1.4 VTS	KFX(TU3JP)	05/96 ⇒ 06/03
SAXO 1.6	NFT(TU5JP), NFZ(TU5JP)	02/01 ⇒ 04/04
SAXO 1.6 VTL, VTR	NFZ(TU5JP)	05/96 ⇒ 06/03

CITROËN

SAXO 1.6 VTS	NFT(TU5JP)	09/00 ⇒ 09/03
ZX 1.1	HDZ(TU1M)	03/91 ⇒ 06/97
ZX 1.4	KDZ(TU3M/Z)	03/91 ⇒ 06/97
ZX 1.4 i	KDX(TU3M/Z), KDZ(TU3M/Z), KFX(TU3JP)	03/91 ⇒ 10/97

PEUGEOT

106 I 1.0	CDY(TU9M), CDZ(TU9M)	09/91 ⇒ 03/01
106 I 1.1	HDZ(TU1M)	09/91 ⇒ 04/96
106 I 1.3	TU2J2	10/93 ⇒ 04/96
106 I 1.4	KDX(TU3MC)	09/91 ⇒ 04/96
106 I 1.4 i XSI	TU3J	09/91 ⇒ 03/96
106 I 1.4 Le Mans	KFZ(TU3J2/Z)	09/91 ⇒ 11/94
106 I 1.6	NFY(TU5J2), NFZ(TU5JP)	06/93 ⇒ 04/96
106 II 1.0 i	CDY(TU9M), CDZ(TU9M)	04/96 ⇒ 10/99
106 II 1.1 i	HDY(TU1M), HDZ(TU1M)	05/96 ⇒ 07/04
106 II 1.4 i	KFW(TU3JP), KFX(TU3JP)	05/96 ⇒ 07/04
106 II 1.6 i	NFW(TU5J2), NFY(TU5J2), NFZ(TU5JP)	05/96 ⇒ 10/99
306 1.4	KFW(TU3JP), KFX(TU3JP)	04/93 ⇒ 04/02
306 1.4 SL	KFW(TU3JP), KFX(TU3JP)	06/94 ⇒ 05/01
306 1.6	NFZ(TU5JP)	05/93 ⇒ 10/00
306 1.6 SR	NFZ(TU5JP)	06/94 ⇒ 10/00
PARTNER I 1.1	HDY(TU1M), HDZ(TU1M)	06/96 ⇒
PARTNER I 1.4	KFX(TU3JP), TU32	06/96 ⇒ 12/15
RANCH 1.1	HDY(TU1M), HDZ(TU1M)	06/96 ⇒
RANCH 1.4	KFX(TU3JP)	06/96 ⇒

EPS 1.501.376



07

IGNITION CABLE SETS

Adatt./Suitable:

CITROËN

5967 N9

00 Eliminated on 14-04-2020. Please verify the availability through our local distributors

- Eliminato il 14-04-2020. Verificare la disponibilità presso i nostri distributori
- Éliminé le 14-04-2020. Vérifier la disponibilité auprès de nos distributeurs sur place
- Am 14-04-2020 gestrichen. Evtl. Verfügbarkeit bitte bei unseren Händlern prüfen
- Eliminado en fecha 14-04-2020. Verificar la disponibilidad a través de nuestros distribuidores locales

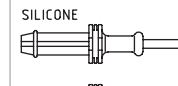

L = 485
L = 585
L = 640

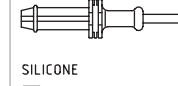
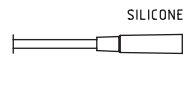

L = 740

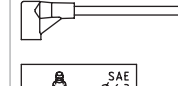
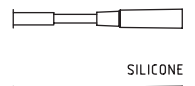

L = 300

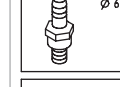
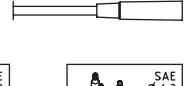

ø 6,3

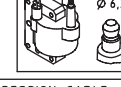

ø 6,3

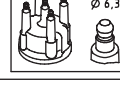

ø 6,3

SUPPRESSION CABLE ø 7 mm

CITROËN

AX 1.3 Sport	M4A	04/87 ⇒ 12/88
AX 10	C1A	09/86 ⇒ 06/92
AX 10 E	C3A	12/86 ⇒ 12/88
AX 11	H1A, H1B, HDZ(TU1M)	09/86 ⇒ 12/97
AX 11 4x4	H1A	06/91 ⇒ 07/92
AX 11 Cat	HAZ(TU1CP)	09/88 ⇒ 12/89
AX 14	K1A(TU3), K1B, K1F, K1G, K1J, K2A, K2B, K2D, KAY(TU3CP), KDX(TU3M/Z), KDY(TU3FM), KDY(TU3M), KDZ(TU3M/Z)	09/86 ⇒ 04/97
AX 14 4x4	KD4, KDX(TU3M/Z), KDY(TU3FM), KDY(TU3M), KDZ(TU3M/Z)	06/91 ⇒ 12/96
AX 14 GT	KDZ(TU3M/Z)	01/89 ⇒ 12/91
BX 1.1	109LA, H1A	04/86 ⇒ 06/91
BX 1.4	150C, K1F, K2D	07/86 ⇒ 12/94
BX 1.4 E	150B(XY8), 150J, 150Y, K1F, KAZ	09/82 ⇒ 12/94
BX 14	150C, KDY(TU3M), KDZ(TU3M/Z)	01/86 ⇒ 02/93
BX 14 E	150A, 150C, K1G	10/82 ⇒ 02/93
C15 1.0	108C(XV8), C1A, C1A(TU9/K), C1B(TU9/W), TU9	10/84 ⇒ 12/97
C15 1.1	H1A, HDZ(TU1M), TU1	08/88 ⇒ 07/96

CITROËN			
C15 1.1 i	HDZ(TU1M), TU1MZ	07/88 ⇒ 12/96	
C15 1.4	K1A, K1G, K1H(TU3A), KDY(TU3M)	07/87 ⇒ 12/96	
C15 1.4 E	K1F, K1J, K2D, K3A, KAZ	07/86 ⇒ 12/96	
C15 1.4 i	KDY(TU3FM), KDY(TU3M)	05/91 ⇒ 12/96	
BERLINGO I 1.4	TU32	07/96 ⇒ 10/98	
ZX 1.1	H1A, H1B, HDZ(TU1M), TU1	03/91 ⇒ 06/97	
ZX 1.4 i	KDY(TU3M)	10/93 ⇒ 10/97	

EPS 1.501.385

07,5

IGNITION CABLE SETS

Adatt./Suitable:

HYUNDAI

27501-23A00
27501-23B01
27501-23B70

KIA

27501-23B70

03 Supplied until depletion

- Fornibile fino ad esaurimento delle scorte
- Fourni jusqu'à épuisement du stock
- Lieferbar solange vorrat reicht
- Suministrado hasta el stock termina

SILICONE

L=550
L=400
L=350
L=250

EPDM

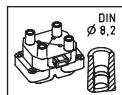
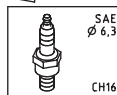
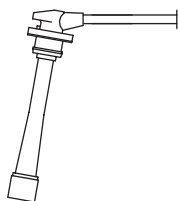

SUPPRESSION CABLE ø 7 mm

HYUNDAI

COUPE I 1.6 16V	G4GR	03/98 ⇒ 04/02
COUPE I 1.6 i 16V	4G61	12/96 ⇒ 04/02
COUPE I 2.0 16V	G4GF	08/96 ⇒ 04/02
ELANTRA II 1.6 i 16V	G4GR	06/95 ⇒ 05/00
ELANTRA II 1.8 i 16V	G4GM	05/95 ⇒ 05/00
ELANTRA II 2.0 i 16V	G4DF	06/97 ⇒ 05/00
ELANTRA III 1.8	G4BB, G4GB	06/00 ⇒ 07/06
ELANTRA III 2.0	G4GC, G4GC-G	06/00 ⇒ 07/06
ELANTRA IV 2.0 CVT	G4GC	06/06 ⇒ 06/11
I30 I 2.0	G4GC, G4GC-G	10/07 ⇒ 06/12
LANTRA 1.8	G4GB	06/00 ⇒
LANTRA 2.0	G4GC-G	06/00 ⇒
LANTRA II 1.6 16V	4G61	11/95 ⇒ 10/00
LANTRA II 1.6 i	G4GR	11/95 ⇒ 10/00
LANTRA II 1.8 16V	G4GM	11/95 ⇒ 10/00
LANTRA II 2.0 16V	G4GF	11/95 ⇒ 10/00
LAVITA 1.8	--	01/07 ⇒
MATRIX 1.8	G4GB-G	06/01 ⇒ 08/10
MATRIX 1.8 [TUR]	G4GB	04/08 ⇒
SONATA V 2.0 i [RUS]	--	04/06 ⇒ 12/10
COUPE II 2.0	G4GC-G	08/01 ⇒ 08/09
COUPE II 2.0 GLS	G4GC-G	02/03 ⇒ 08/09
TIBURON 1.6 i 16V	G4GL, G4GR	08/00 ⇒
TIBURON 2.0 i 16V	G4DF	08/99 ⇒
TRAJET 2.0	G4GC, G4GC-G, G4JP-G	03/00 ⇒ 07/08
TRAJET 2.0 CRDi	D4EA	08/05 ⇒ 07/08
TUCSON 2.0	G4GC	08/04 ⇒
TUCSON 2.0 Trazione integrale	G4GC	08/04 ⇒ 11/10

KIA

CARENS I 2.0 CVT	G4GC	08/04 ⇒
CEED I 2.0	G4GC	12/06 ⇒ 12/12
CERATO I 2.0	G4GC	03/04 ⇒ 05/07
PRO CEE'D I 2.0	G4GC	02/08 ⇒ 09/12
SPORTAGE II 2.0 16V 4WD	G4GC	09/04 ⇒
SPORTAGE II 2.0 i 16V	G4GC	09/04 ⇒
CERATO II 2.0 CVT	--	01/09 ⇒

EPS 1.501.393

05

IGNITION CABLE SETS

Adatt./Suitable:

BOSCH

0 986 357 171

TOYOTA

90919-22329

00 Eliminated on 04-05-2020. Please verify the availability through our local distributors

- Eliminato il 04-05-2020. Verificare la disponibilità presso i nostri distributori
- Éliminé le 04-05-2020. Vérifier la disponibilité auprès de nos distributeurs sur place
- Am 04-05-2020 gestrichen. Evtl. Verfügbarkeit bitte bei unseren Händlern prüfen
- Eliminado en fecha 04-05-2020. Verificar la disponibilidad a través de nuestros distribuidores locales

SILICONE

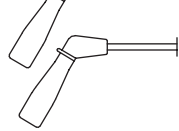
L=500
L=350

L=450

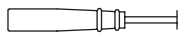

L=700

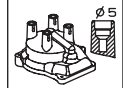

SILICONE

SAE ø 6,3
CH16

DIN ø 5

SUPPRESSION CABLE ø 5 mm

TOYOTA

COROLLA VII 1.3 12V	2E	07/92 ⇒ 04/97
COROLLA VIII 1.3	2E	05/97 ⇒ 10/01
STARLET 1.0	1E	12/89 ⇒ 12/92
TERCEL 1.5 i [USA]	3EE	01/93 ⇒

EPS 1.501.398

07

IGNITION CABLE SETS

Adatt./Suitable:

MAZDA

8BBG-18-140
8BBY-18-140

00 Eliminated on 14-06-2021. Please verify the availability through our local distributors

- Eliminato il 14-06-2021. Verificare la disponibilità presso i nostri distributori
- Éliminé le 14-06-2021. Vérifier la disponibilité auprès de nos distributeurs sur place
- Am 14-06-2021 gestrichen. Evtl. Verfügbarkeit bitte bei unseren Händlern prüfen
- Eliminado en fecha 14-06-2021. Verificar la disponibilidad a través de nuestros distribuidores locales

SILICONE

L=700
L=600
L=500
L=450

EPDM

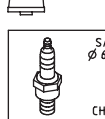
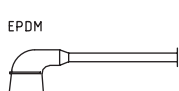
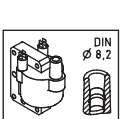
SAE ø 6,3
CH16

DIN ø 8,2

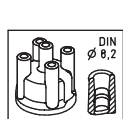

DIN ø 8,2

SUPPRESSION CABLE ø 7 mm

KIA

PRIDE 1.1 i	B1	01/91 ⇒ 10/00
PRIDE 1.3	B3, B3A5	01/90 ⇒ 09/01
PRIDE 1.3 [GBR]	--	01/90 ⇒
PRIDE 1.3 i	--	01/90 ⇒ 05/97
PRIDE 1.3 i [GBR]	--	01/90 ⇒
SEPHIA I 1.6 i	B6	09/93 ⇒ 10/97

MAZDA

323 VI C 1.6 16V	B6	03/91 ⇒ 10/94
323 VI F 1.6 16V	B6	03/91 ⇒ 10/94

MAZDA

323 VIF 1.8 16V	BP	08/89 ⇒ 07/94
323 VIF 1.8 16V GT	BP(DOHC)	08/89 ⇒ 07/94
323 VIF 1.8i 16v GRSi	BP31	06/89 ⇒ 03/91
323 VIS 1.3 16V	B3(16V)	04/91 ⇒ 07/94
323 VIS 1.6 16V	B6	08/89 ⇒ 10/96
323 VIS 1.8 16V	BP52	08/89 ⇒ 07/94
323 VIS 1.8 16V 4WD	BP52	09/91 ⇒ 07/94
PROTEGE 1.8i OHC [USA]	--	01/90 ⇒

EPS 1.501.399

07

IGNITION CABLE SETS

Adatt./Suitable:

BOSCH

0 986 357 239

NISSAN

22440-57Y10
22440-73C00
22440-73C10

00 Eliminated on 22-02-2021. Please verify the availability through our local distributors

- Eliminato il 22-02-2021. Verificare la disponibilità presso i nostri distributori
- Éliminé le 22-02-2021. Vérifier la disponibilité auprès de nos distributeurs sur place
- Am 22-02-2021 gestrichen. Evtl. Verfügbarkeit bitte bei unseren Händlern prüfen
- Eliminado en fecha 22-02-2021. Verificar la disponibilidad a través de nuestros distribuidores locales

SILICONE

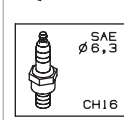
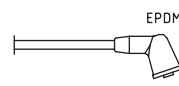
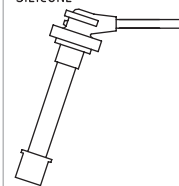
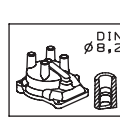
L=650
L=550
L=450
L=350SAE ø 6,3
CH16

DIN ø 8,2

SUPPRESSION CABLE ø 7 mm

NISSAN

100NX 1.6 SR	GA16DE	09/93 ⇒ 10/94
ALMERA I 1.4	GA14DE	09/95 ⇒ 07/00
ALMERA I 1.4 GX, LX	GA14DE	09/95 ⇒ 07/00
ALMERA I 1.4 S, GX, LX	GA14DE	09/95 ⇒ 03/00
ALMERA I 1.6	GA16DE	07/95 ⇒ 07/00
ALMERA I 1.6 SLX	GA16DE	09/95 ⇒ 07/00
ALMERA I 1.6 SR, SLX	GA16DE	09/95 ⇒ 03/00
PRIMERA I 1.6 i	GA16DE	02/91 ⇒ 03/98
SUNNY III 1.6 i	GA16DE	10/90 ⇒ 03/00
SUNNY III 1.6 i 16V	GA16DE	10/92 ⇒ 05/95

EPS 1.501.401



07

IGNITION CABLE SETS

Adatt./Suitable:

BOSCH
0 986 356 974
0 986 357 151

HYUNDAI
27501-33A00

KIA
27501-33A00

MITSUBISHI
MD134754
MD192995

00 Eliminated on 22-02-2022. Please verify the availability through our local distributors

• Eliminato il 22-02-2022. Verificare la disponibilità presso i nostri distributori

• Éliminé le 22-02-2022. Vérifier la disponibilité auprès de nos distributeurs sur place

• Am 22-02-2022 gestrichen. Evtl. Verfügbarkeit bitte bei unseren Händlern prüfen

• Eliminado en fecha 22-02-2022. Verificar la disponibilidad a través de nuestros distribuidores locales

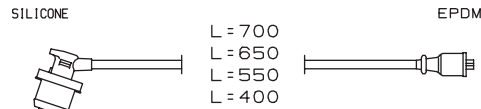
SUPPRESSION CABLE \varnothing 7 mm

HYUNDAI

ELANTRA I 1.5 i GL	G4DJ	12/90 \Rightarrow 08/94
ELANTRA I 1.6i 16V	G4CR	12/90 \Rightarrow 05/95
ELANTRA I 1.8i 16V	G4CN	06/92 \Rightarrow 12/95
LANTRA I 1.5 i.e.	G4DJ	10/90 \Rightarrow 11/95
LANTRA I 1.6 i.e. 16V	G4CR	10/90 \Rightarrow 11/95
LANTRA I 1.8 i.e. 16V	G4CN	10/90 \Rightarrow 11/95
SANTAMO 2.0 16V	G4JP	05/99 \Rightarrow 12/02
SANTAMO 2.0 16V 4x4	G4CP-D	05/99 \Rightarrow 12/02
SONATA II 2.0 i 16V	G4CP-D	01/91 \Rightarrow 10/93
SONATA III 2.0 i 16V	G4CP-D, G4CP-DM	05/93 \Rightarrow 06/98

KIA

JOICE 2.0	G4CP	02/00 \Rightarrow
-----------	------	---------------------

MITSUBISHI

COLT III 1.6 GTi 16V	4G61	04/88 \Rightarrow 05/90
COLT III 1.8 GTi 16V Cat	4G67	06/90 \Rightarrow 05/92
LANCERV 1.6 GTi	4G61	05/88 \Rightarrow 05/90
LANCERV 1.8 GTi 16V	4G67	11/89 \Rightarrow 05/92
ECLIPSE I 2.0 i 16V	4G63(DOHC16V)	04/91 \Rightarrow 11/95
ECLIPSE I 2.0 i 16V 4WD	4G63(DOHC16V)	04/91 \Rightarrow 11/95
ECLIPSE I 2.0 Turbo	4G63-T(DOHC16V)	12/89 \Rightarrow 03/94
ECLIPSE I 2.0 Turbo 4WD	4G63-T(DOHC16V)	12/89 \Rightarrow 03/94
GALANT VI 2.0 GTi 16V	4G63(DOHC16V)	11/87 \Rightarrow 10/92
GALANT VI 2.0 GTi 16V 4WD	4G63(DOHC16V)	06/88 \Rightarrow 10/92
GALANT VI 2.0 GTi 16V 4x4	4G63(DOHC16V)	07/89 \Rightarrow 12/92
GALANT VI 2.0 GTi 16V Cat 4WD	4G63(DOHC16V)	09/91 \Rightarrow 10/92

EPS 1.501.411



07,5

IGNITION CABLE SETS

Adatt./Suitable:

BOSCH
0 986 357 239

HITACHI
134280

NISSAN
22440-2F200
22440-2J210

03 Supplied until depletion

• Fornibile fino ad esaurimento delle scorte

• Fourni jusqu'à épuisement du stock

• Lieferbar solange vorrat reicht

• Suministrado hasta el stock termina

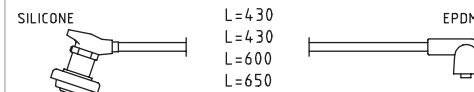
SUPPRESSION CABLE \varnothing 7 mm

NISSAN

ALMERA I 2.0 GTi	SR20DE	07/96 \Rightarrow 03/00
ALMERA TINO 2.0	SR20DE	08/00 \Rightarrow 01/03
PRIMERA II 2.0	SR20DEL	10/97 \Rightarrow 06/99
PRIMERA II 2.0 16V	SR20DE	06/96 \Rightarrow 07/02
PRIMERA II 2.0 GT	SR20DEH	10/97 \Rightarrow 06/99
PRIMERA I 2.0	SR20DE	07/94 \Rightarrow 01/98

EPS 1.501.413



05

IGNITION CABLE SETS

Adatt./Suitable:

03 Supplied until depletion

• Fornibile fino ad esaurimento delle scorte

• Fourni jusqu'à épuisement du stock

• Lieferbar solange vorrat reicht

• Suministrado hasta el stock termina

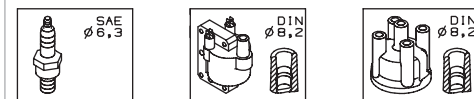
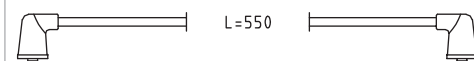
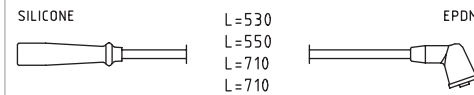
SUPPRESSION CABLE \varnothing 7 mm

SUZUKI

ALTO IV 1.0	G10BB	09/94 \Rightarrow 06/02
ALTO V 1.0	G10BB	01/00 \Rightarrow 06/02
SWIFT I / II / III 1.3	G13BA	03/89 \Rightarrow 10/96
SWIFT I / II / III 1.3 GTi SOHC	G13B	10/89 \Rightarrow 12/95
SWIFT I / II / III 1.3 i	G13BA	09/91 \Rightarrow 10/96
SJ410 1.0	F10A	09/81 \Rightarrow 07/91
SWIFT III 1.3 i	G13BA	06/96 \Rightarrow 03/01

EPS 1.501.415



07

IGNITION CABLE SETS

Adatt./Suitable:

GENERAL MOTORS
96 058 494

SUZUKI

33700-60A10
33700-60A10-000
33700-60A20
33700-60A20-000

03 Supplied until depletion

• Fornibile fino ad esaurimento delle scorte

• Fourni jusqu'à épuisement du stock

• Lieferbar solange vorrat reicht

• Suministrado hasta el stock termina

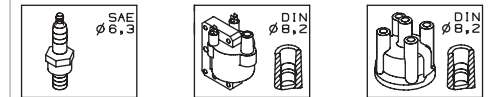
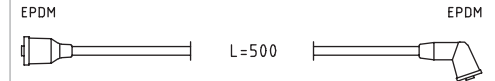
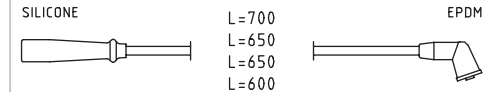
SUPPRESSION CABLE \varnothing 7 mm

SUZUKI

SIDEKICK 1.6i [USA]	--	01/89 \Rightarrow 12/91
VITARA I 1.6 8V	--	01/90 \Rightarrow 12/94

EPS 1.501.417



07

IGNITION CABLE SETS

Adatt./Suitable:

SUZUKI

33700-83020
33700-83020-000
33705-83020
33705-83020-000
33710-83020
33710-83020-000

00 Eliminated on 25-11-2020. Please verify the availability through our local distributors

• Eliminato il 25-11-2020. Verificare la disponibilità presso i nostri distributori

• Éliminé le 25-11-2020. Vérifier la disponibilité auprès de nos distributeurs sur place

• Am 25-11-2020 gestrichen. Evtl. Verfügbarkeit bitte bei unseren Händlern prüfen

• Eliminado en fecha 25-11-2020. Verificar la disponibilidad a través de nuestros distribuidores locales

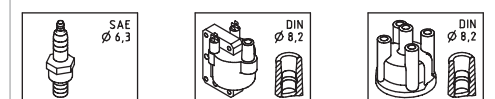
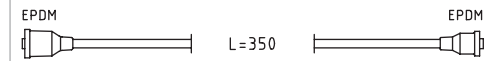
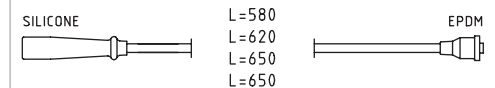
SUPPRESSION CABLE \varnothing 7 mm

SUZUKI

SIDEKICK 1.6i [USA]	--	01/91 \Rightarrow
---------------------	----	---------------------

EPS 1.501.433



07

IGNITION CABLE SETS

Adatt./Suitable:

BOSCH
0 986 356 975
DAEWOO
NP1149

00 Eliminated on 14-04-2020. Please verify the availability through our local distributors

- Eliminato il 14-04-2020. Verificare la disponibilità presso i nostri distributori
- Éliminé le 14-04-2020. Vérifier la disponibilité auprès de nos distributeurs sur place
- Am 14-04-2020 gestrichen. Evtl. Verfügbarkeit bitte bei unseren Händlern prüfen
- Eliminado en fecha 14-04-2020. Verificar la disponibilidad a través de nuestros distribuidores locales

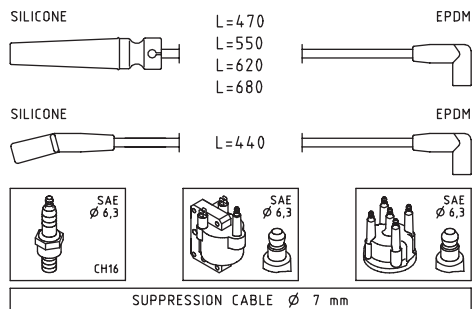

DAEWOO

ARANOS 1.5	V15L	01/95 ⇒ 11/97
ESPERO 1.5	G15MF	10/97 ⇒ 09/99
ESPERO 1.5 16V	A15MF	02/95 ⇒ 06/99
NEXIA 1.5 16V	A15MF	02/95 ⇒ 08/97

EPS 1.501.434



07

IGNITION CABLE SETS

Adatt./Suitable:

SUZUKI
33705-51G20
33705-51G20-000

00 Eliminated on 14-04-2020. Please verify the availability through our local distributors

- Eliminato il 14-04-2020. Verificare la disponibilità presso i nostri distributori
- Éliminé le 14-04-2020. Vérifier la disponibilité auprès de nos distributeurs sur place
- Am 14-04-2020 gestrichen. Evtl. Verfügbarkeit bitte bei unseren Händlern prüfen
- Eliminado en fecha 14-04-2020. Verificar la disponibilidad a través de nuestros distribuidores locales

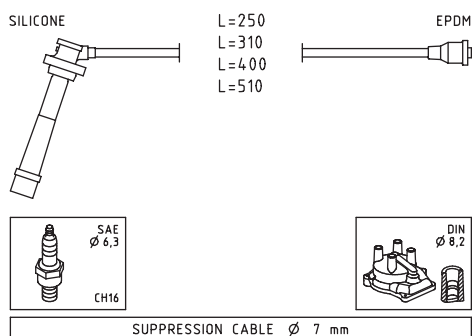

SUZUKI

BALENO 1.3 16V	G13BB	03/97 ⇒ 05/02
BALENO 1.3 i 16V	G13BB	07/95 ⇒ 05/02
BALENO 1.6 i 16V	G16B	07/95 ⇒ 05/02
BALENO 1.6 i 16V 4x4	G16B	07/95 ⇒ 05/02

EPS 1.501.435



07

IGNITION CABLE SETS

Adatt./Suitable:

BOSCH
0 986 356 957
MAGNETI MARELLI
941318111188
TOYOTA
90919-22373

00 Eliminated on 22-02-2022. Please verify the availability through our local distributors

- Eliminato il 22-02-2022. Verificare la disponibilità presso i nostri distributori
- Éliminé le 22-02-2022. Vérifier la disponibilité auprès de nos distributeurs sur place
- Am 22-02-2022 gestrichen. Evtl. Verfügbarkeit bitte bei unseren Händlern prüfen
- Eliminado en fecha 22-02-2022. Verificar la disponibilidad a través de nuestros distribuidores locales

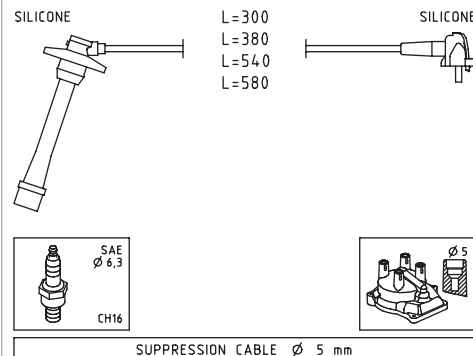

TOYOTA

COROLLA VII 1.3 XLI	4E-FE	07/92 ⇒ 04/97
COROLLA VII 1.3 XLI 16V	4E-FE	07/92 ⇒ 09/95
PASEO 1.5	5E-FE	06/90 ⇒ 06/99
STARLET 1.3	4E-FE	01/96 ⇒ 07/99

EPS 1.501.436



05

IGNITION CABLE SETS

Adatt./Suitable:

BOSCH
0 986 357 222
DAIHATSU
19901-87B87-000

03 Supplied until depletion

- Fornibile fino ad esaurimento delle scorte
- Fourni jusqu'à épuisement du stock
- Lieferbar solange vorrat reicht
- Suministrado hasta el stock termina

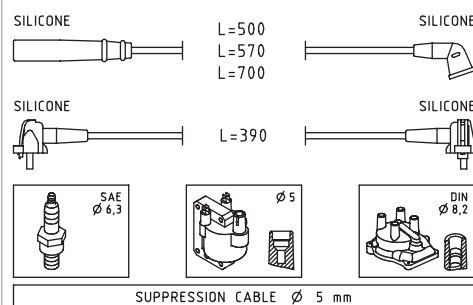

DAIHATSU

CUORE III 0.8	ED10K	10/90 ⇒ 12/94
CUORE IV 0.8	ED20	01/95 ⇒ 08/98
DOMINO 0.8i	ED20	08/90 ⇒ 10/98
DOMINO 850i	--	01/97 ⇒
MIRA 0.8i	ED20	12/94 ⇒ 02/97
MOVE 0.8	ED20	01/97 ⇒ 11/99

EPS 1.501.443



07

IGNITION CABLE SETS

Adatt./Suitable:

RENAULT
77 00 273 226

00 Eliminated on 07-01-2020. Please verify the availability through our local distributors

- Eliminato il 07-01-2020. Verificare la disponibilità presso i nostri distributori
- Éliminé le 07-01-2020. Vérifier la disponibilité auprès de nos distributeurs sur place
- Am 07-01-2020 gestrichen. Evtl. Verfügbarkeit bitte bei unseren Händlern prüfen
- Eliminado en fecha 07-01-2020. Verificar la disponibilidad a través de nuestros distribuidores locales

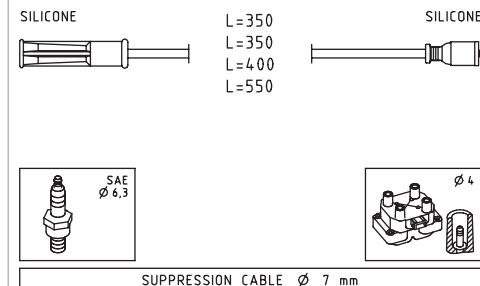

RENAULT

CLIO II 1.4	E7J780	09/98 ⇒ 05/05
CLIO II 1.6	K7M744, K7M745	09/98 ⇒ 05/05
KANGOO I 1.4	E7J780	08/97 ⇒
MEGANE I 1.6 e	K7M702, K7M703	01/96 ⇒ 08/03
MEGANE I 1.6 i	K7M720	01/96 ⇒ 03/99
MEGANE SCÉNIC I 1.6 e	K7M702, K7M703	10/96 ⇒ 10/99
MEGANE SCÉNIC I 1.6 i	K7M720	01/97 ⇒ 09/99

EPS 1.501.446



07

IGNITION CABLE SETS

Adatt./Suitable:

BOSCH
0 986 357 211
0 986 357 252

03 Supplied until depletion

- Fornibile fino ad esaurimento delle scorte
- Fourni jusqu'à épuisement du stock
- Lieferbar solange vorrat reicht
- Suministrado hasta el stock termina

HITACHI
134464

RENAULT
77 00 866 923

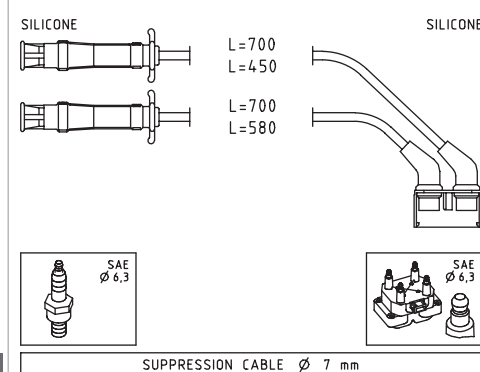

RENAULT

MEGANE I 1.6 e	K7M702, K7M703, K7M790	01/96 ⇒ 08/03
MEGANE I 1.6 i	K7M720	01/96 ⇒ 03/99
MEGANE SCÉNIC I 1.6 e	K7M702, K7M703	10/96 ⇒ 10/99
MEGANE SCÉNIC I 1.6 i	K7M720	01/97 ⇒ 09/99

EPS **1.501.447** **07****IGNITION CABLE SETS**

Adatt./Suitable:

RENAULT77 00 107 662
77 00 874 109**00 Eliminated on 26-01-2021. Please verify the availability through our local distributors**

- Eliminato il 26-01-2021. Verificare la disponibilità presso i nostri distributori
- Éliminé le 26-01-2021. Vérifier la disponibilité auprès de nos distributeurs sur place
- Am 26-01-2021 gestrichen. Evtl. Verfügbarkeit bitte bei unseren Händlern prüfen
- Eliminado en fecha 26-01-2021. Verificar la disponibilidad a través de nuestros distribuidores locales

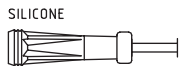
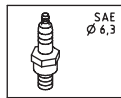
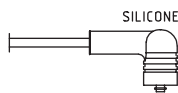
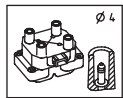
L=600
L=450
L=400
L=500SAE
ø 6,3

ø 4

SUPPRESSION CABLE ø 7 mm

RENAULT

CLIO I 1.2	D7F730	01/96 ⇨ 09/98
CLIO II 1.2	D7F710, D7F720, D7F722, D7F726, D7F766	09/98 ⇨
CLIO II 1.2 LPG	D7F722, D7F766	09/98 ⇨ 06/09
KANGOO I 1.2	D7F710, D7F720, D7F722, D7F726, D7F744, D7F746	08/97 ⇨
TWINGO I 1.2	D7F700, D7F701, D7F702, D7F703, D7F704, D7F706	05/96 ⇨

EPS **1.501.451** **07****IGNITION CABLE SETS**

Adatt./Suitable:

BOSCH

0 986 357 816

FIAT46749624
55202897
55203737**HITACHI**

134272

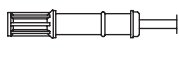
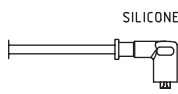
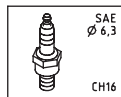
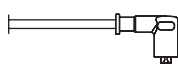
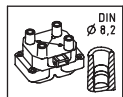
LANCIA46749624
55202897**MAGNETI MARELLI**941095100582
941318111161L=580
L=280L=600
L=450SAE
ø 6,3DIN
ø 8,2

SUPPRESSION CABLE ø 7 mm

FIAT

DOBLO I 1.2	223A5.000	03/01 ⇨
PALIO 1.0	178A1.000	04/96 ⇨ 10/03
PALIO 1.0 GLX	--	07/98 ⇨ 10/03
PALIO 1.1	187A1.000	06/06 ⇨
PALIO 1.2	176A8.000, 178B5.000, 178B7.045, 178C4.066, 178E2.000, 188A4.000	04/96 ⇨
PALIO 1.2 75	178B7.045	03/98 ⇨
PALIO 1.2 MPI	178C4.066	01/02 ⇨
PANDA I 1.1	187A1.000	09/00 ⇨ 02/04
PANDA I 1.1 AWD	187A1.000	09/00 ⇨ 02/04
PANDA I 1100	187A1.000	02/95 ⇨ 09/03
PANDA I 1100 i.e. 4x4	187A1.000	12/00 ⇨

FIAT

PANDA II 1.1	--	09/03 ⇨
PANDA II 1.2	188A4.000	09/03 ⇨
PANDA II 1.2 4x4	188A4.000	09/04 ⇨
PANDA II 1.2 Bi-Power / Natural Power	--	04/09 ⇨
PANDA II 1.2 Euro 4	--	04/09 ⇨
PANDA II 1.2 LPG	188A4.000	04/09 ⇨
PANDA II 1.2 Natural Power	188A4.000	01/07 ⇨ 12/11
PUNTO II 1.2 60	188A4.000	09/99 ⇨ 12/10
PUNTO II 1.2 Bifuel	188A4.000	08/07 ⇨ 03/12
PUNTO II 1.2 Natural Power	188A4.000	09/03 ⇨ 03/12
SEICENTO / 600 1.1	187A1.000	01/98 ⇨ 01/10
SIENA 1.2	178B7.045	01/98 ⇨
SIENA 1.3	178B5.000, 178C4.066, 188A4.000, 188A5.000	09/01 ⇨ 12/12
STRADA 1.2	178B5.000, 178B7.045, 188A4.000	04/03 ⇨
STRADA 1.2 Trekking	--	11/05 ⇨

LANCIA

YI 1.2	188A4.000	03/96 ⇨ 09/03
YPSILON II 1.2	169A4.000, 188A4.000	10/03 ⇨ 12/11

EPS **1.501.479** **07****IGNITION CABLE SETS**

Adatt./Suitable:

00 Eliminated on 19-01-2022. Please verify the availability through our local distributors

- Eliminato il 19-01-2022. Verificare la disponibilità presso i nostri distributori
- Éliminé le 19-01-2022. Vérifier la disponibilité auprès de nos distributeurs sur place
- Am 19-01-2022 gestrichen. Evtl. Verfügbarkeit bitte bei unseren Händlern prüfen
- Eliminado en fecha 19-01-2022. Verificar la disponibilidad a través de nuestros distribuidores locales

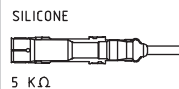
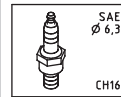
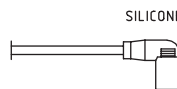
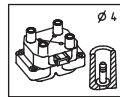
L=700
L=650
L=480
L=280SAE
ø 6,3

ø 4

COPPER CORE CABLE ø 7 mm

AUDI

A3 I 1.6	AEH, AKL	09/96 ⇨ 05/03
----------	----------	---------------

SKODA

OCTAVIA I 1.6	AEH, AKL	02/97 ⇨ 12/07
---------------	----------	---------------

VW

GOLF IV 1.6	AEH, AKL	05/01 ⇨ 05/04
-------------	----------	---------------

EPS

1.501.484 **07****IGNITION CABLE SETS**

Adatt./Suitable:

00 Eliminated on 18-11-2019. Please verify the availability through our local distributors

- Eliminato il 18-11-2019. Verificare la disponibilità presso i nostri distributori
- Éliminé le 18-11-2019. Vérifier la disponibilité auprès de nos distributeurs sur place
- Am 18-11-2019 gestrichen. Evtl. Verfügbarkeit bitte bei unseren Händlern prüfen
- Eliminado en fecha 18-11-2019. Verificar la disponibilidad a través de nuestros distribuidores locales

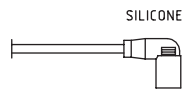
L=600
L=650
L=480
L=280

5 KΩ

1 KΩ

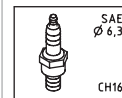
SAE
ø 6,3

CH16

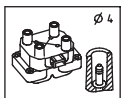

ø 4

COPPER CORE CABLE ø 7 mm

AUDI

A3 I 1.6	AEH, AKL, APF	09/96 ⇨ 05/03
----------	---------------	---------------

SEAT

CORDOBA I 1.6 i	AKL	07/96 ⇨ 10/02
-----------------	-----	---------------

IBIZA II 1.6 i	AKL	04/96 ⇨ 02/02
----------------	-----	---------------

LEON I 1.6	AEH, AKL	11/99 ⇨ 06/06
------------	----------	---------------

TOLEDO II 1.6	AEH, AKL, APF	10/98 ⇨ 07/04
---------------	---------------	---------------

SKODA

OCTAVIA I 1.6	AEH, AKL	02/97 ⇨ 12/07
---------------	----------	---------------

VOLKSWAGEN (BR)

GOLF A4 1.6i	AKL	10/99 ⇨
--------------	-----	---------

VW

BORA 1.6	AEH, AKL, APF	10/98 ⇨ 05/05
----------	---------------	---------------

GOLF IV 1.6	AEH, AKL, APF	05/01 ⇨ 05/04
-------------	---------------	---------------

POLO III 1.6	AEH, AKL	05/97 ⇨ 09/01
--------------	----------	---------------

POLO III 100 1.6	AEH, AKL	12/95 ⇨ 09/01
------------------	----------	---------------

EPS

1.501.489 **09****IGNITION CABLE SETS**

Adatt./Suitable:

03 Supplied until depletion

- Fornibile fino ad esaurimento delle scorte
- Fourni jusqu'à épuisement du stock
- Lieferbar solange vorrat reicht
- Suministrado hasta el stock termina

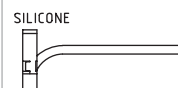
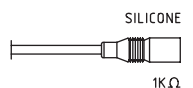
L=820
L=750
L=750
L=750

1KΩ

SAE
ø 6,3

CH16



ø 4

COPPER CORE CABLE ø 7 mm

AUDI

A3 I 1.8	AGN, APG	09/96 ⇨ 05/03
----------	----------	---------------

1.501.491

SEAT		
LEON I 1.8 20V	AGN, APG	11/99 ⇒ 06/06
TOLEDO II 1.8 20V	AGN, APG	10/98 ⇒ 07/04
SKODA		
OCTAVIA I 1.8	AGN	09/96 ⇒ 07/00
OCTAVIA I 1.8 20V	AGN	07/98 ⇒ 07/00
VW		
BORA 1.8	AGN	10/98 ⇒ 05/05
BORA 1.8 4motion	AGN	02/99 ⇒ 05/05
GOLF IV 1.8	AGN	08/97 ⇒ 06/05
GOLF IV 1.8 4motion	AGN	05/98 ⇒ 06/06

EPS 1.501.491



IGNITION CABLE SETS

Adatt./Suitable:

⁰³ Supplied until depletion

- Fornibile fino ad esaurimento delle scorte
- Fourni jusqu'à épuisement du stock
- Lieferbar solange vorrat reicht
- Suministrado hasta el stock termina

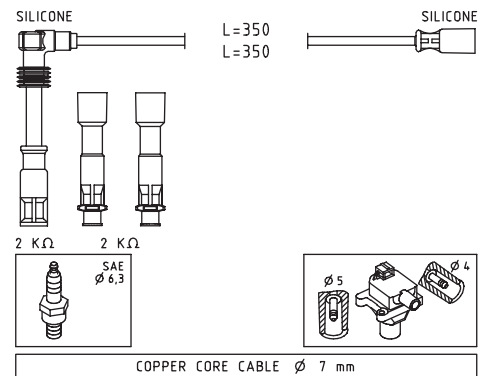

AUDI

A6 I 1.8 quattro	ADR	12/95 ⇒ 12/97
A4 I 1.8	ADR, AFY, APT, ARG, AVV	11/94 ⇒ 09/01
A4 I 1.8 quattro	ADR, AFY, APT, ARG	01/95 ⇒ 09/01
A6 II 1.8	AFY	05/97 ⇒ 01/05
CABRIOLET 1.8	ADR	01/97 ⇒ 08/00

VW

PASSAT IV 1.8	ADR, AFY, APT, ARG	10/96 ⇒ 03/05
PASSAT IV 1.8 Syncro/4motion	ADR, APT, ARG	12/96 ⇒ 11/00

EPS 1.501.492



IGNITION CABLE SETS

Adatt./Suitable:

BOSCH
0 986 356 967

RENAULT
77 00 106 221

⁰⁰ Eliminated on 10-06-2019. Please verify the availability through our local distributors

- Eliminato il 10-06-2019. Verificare la disponibilità presso i nostri distributori
- Éliminé le 10-06-2019. Vérifier la disponibilité auprès de nos distributeurs sur place
- Am 10-06-2019 gestrichen. Evtl. Verfügbarkeit bitte bei unseren Händlern prüfen
- Eliminado en fecha 10-06-2019. Verificar la disponibilidad a través de nuestros distribuidores locales

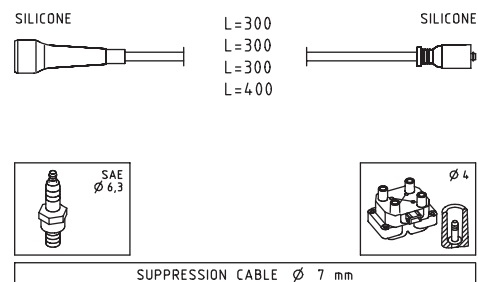

RENAULT

ESPACE III 2.0	F3R728, F3R729, F3R742, F3R768, F3R769	11/96 ⇒ 10/00
----------------	--	---------------

RENAULT

LAGUNA I 1.8	F3P670, F3P674, F3P676, F3P678	06/95 ⇒ 03/01
LAGUNA I 2.0	--, F3R611, F3R728, F3R729, F3R768, F3R769	11/93 ⇒ 03/01
MEGANE I 2.0	F3R750, F3R751, F3R752, F3R791, F3R796, F3R797, F3R798	04/97 ⇒ 08/03
MEGANE I 2.0 i	F3R750, F3R751, F3R752, F3R791, F3R796, F3R797, F3R798	01/96 ⇒ 08/03
MEGANE SCÉNIC I 2.0 i	F3R750, F3R751, F3R796	01/97 ⇒ 09/99
MEGANE SCÉNIC I 2.0 RXE 4x4	F3R750	05/97 ⇒ 10/99
SCÉNIC I 2.0	F3R791, F3R797, F3R798	09/99 ⇒ 08/03

EPS 1.501.497



IGNITION CABLE SETS

Adatt./Suitable:

⁰³ Supplied until depletion

- Fornibile fino ad esaurimento delle scorte
- Fourni jusqu'à épuisement du stock
- Lieferbar solange vorrat reicht
- Suministrado hasta el stock termina

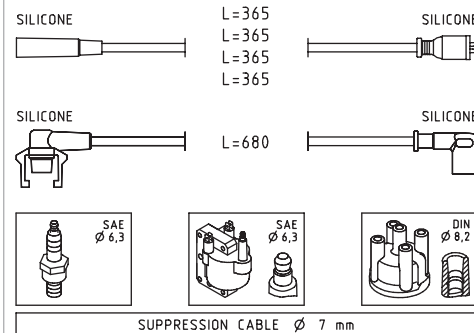

RENAULT

CLIO I 1.2	C3G720	06/94 ⇒ 02/98
------------	--------	---------------

EPS 1.501.499



IGNITION CABLE SETS

Adatt./Suitable:

⁰³ Supplied until depletion

- Fornibile fino ad esaurimento delle scorte
- Fourni jusqu'à épuisement du stock
- Lieferbar solange vorrat reicht
- Suministrado hasta el stock termina

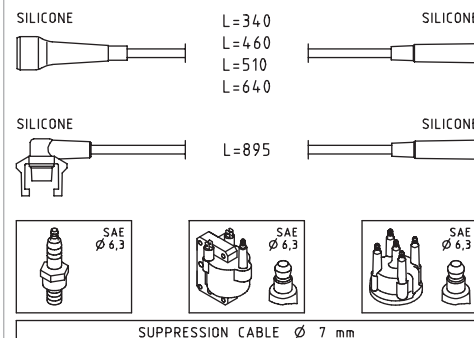

RENAULT

LAGUNA I 1.8	F3P678, F3P720, F3P724	11/93 ⇒ 03/01
LAGUNA I 2.0	6Z7U730, F3R722	11/93 ⇒ 03/01

EPS 1.501.501



IGNITION CABLE SETS

Adatt./Suitable:

BOSCH
0 986 357 210

RENAULT
77 00 874 564

⁰⁰ Eliminated on 16-06-2020. Please verify the availability through our local distributors

- Eliminato il 16-06-2020. Verificare la disponibilità presso i nostri distributori
- Éliminé le 16-06-2020. Vérifier la disponibilité auprès de nos distributeurs sur place
- Am 16-06-2020 gestrichen. Evtl. Verfügbarkeit bitte bei unseren Händlern prüfen
- Eliminado en fecha 16-06-2020. Verificar la disponibilidad a través de nuestros distribuidores locales

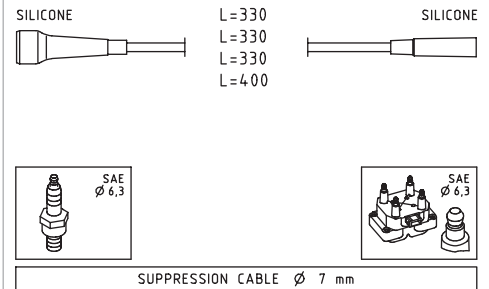

RENAULT

ESPACE III 2.0	F3R728, F3R768, F3R769	11/96 ⇒ 10/00
LAGUNA I 1.8	F3P670, F3P674, F3P676, F3P678	06/95 ⇒ 03/01
LAGUNA I 2.0	--, F3R728, F3R729, F3R768, F3R769	11/93 ⇒ 03/01
MEGANE I 2.0	F3R262, F3R264, F3R750, F3R751, F3R752, F3R791, F3R797, F3R798	01/97 ⇒ 08/03
MEGANE I 2.0 i	F3R750, F3R751, F3R752, F3R791, F3R797, F3R798	01/96 ⇒ 08/03
MEGANE SCÉNIC I 2.0 i	F3R750, F3R751	01/97 ⇒ 09/99
MEGANE SCÉNIC I 2.0 RXE 4x4	F3R750	05/97 ⇒ 10/99
SCÉNIC I 2.0	F3R791, F3R797, F3R798	09/99 ⇒ 08/03

EPS 1.501.503



IGNITION CABLE SETS

Adatt./Suitable:

BOSCH
0 986 357 261

FIAT
46413088

HITACHI
134518

LANCIA
46413088

MAGNETI MARELLI
941095800618

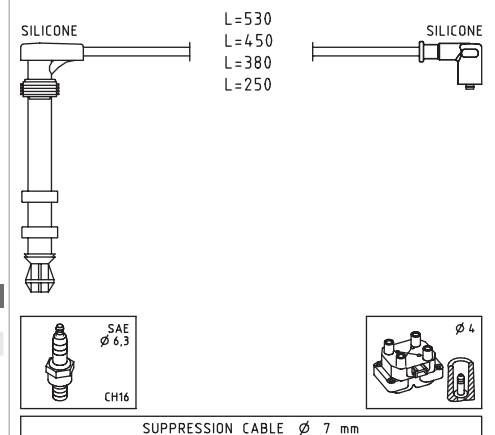

FIAT

BRAVA 1.6 16V	182A4.000, 182A4.027, 182A6.000, 182B6.000	10/95 ⇒ 12/02
BRAVO I 1.6	182B6.000	09/00 ⇒ 10/01
BRAVO I 1.6 16V	178A8.011, 182A4.000, 182A6.000	10/95 ⇒ 10/01
DOBLO I 1.6 Natural Power	182B6.000	09/02 ⇒

FIAT		
MAREA 1.6	182B6.000, 185A3.000	09/00 ⇒ 08/02
MAREA 1.6 100 16V	182A4.000	09/96 ⇒ 05/02
MAREA 1.6 100 16V Bipower	185A3.000	04/99 ⇒ 05/02
MAREA 1.6 16V	185A3.000	04/97 ⇒ 02/99
MAREA 1.6 SX	182B5.098	09/00 ⇒ 08/02
MULTIPLA 1.6	182B6.000	09/00 ⇒ 06/10
MULTIPLA 1.6 100 16V	182A4.000	04/99 ⇒ 06/10
MULTIPLA 1.6 16V	182B6.000	04/02 ⇒ 06/10
MULTIPLA 1.6 16V Bipower	182B6.000, 186A4.000	10/01 ⇒ 06/10
MULTIPLA 1.6 16V Blupower	186A3.000	04/99 ⇒ 06/10
MULTIPLA 1.6 16V GPL	182B6.000	10/01 ⇒ 06/10
PALIO 1.6	178D2.011	07/97 ⇒
PALIO 1.6 16V	178B3.000, 178C7.098, 178D2.011, 182B6.000	02/01 ⇒
SIENA 1.6	182B6.000	11/00 ⇒ 12/12
SIENA 1.6 16V	178B3.000	09/98 ⇒
STRADA 1.6 MPI	178D2.011	07/05 ⇒

FIAT (BR)		
BRAVA 1.6i 16v	1.6Mpi	01/00 ⇒
PALIO 1.6i	1.6Mpi	01/99 ⇒ 12/00
PALIO 1.6i 16v	1.6Mpi16v	01/96 ⇒
SIENA 1.6i 16v	1.6Mpi	01/98 ⇒ 12/99
STRADA 1.6i 16v	1.6Mpi	01/99 ⇒

LANCIA		
DEDRA 1.6 16V	182A4.000	01/96 ⇒ 07/99
DELTA II 1.6 i.e.	182A6.000	03/96 ⇒ 08/99
DELTA II 1.6 i.e. 16V	182A4.000	01/96 ⇒ 08/99
LYBRA 1.6	182B6.000	10/00 ⇒ 10/05
LYBRA 1.6 16V	182A4.000	07/99 ⇒ 10/05

EPS 1.501.504

07,5

IGNITION CABLE SETS

Adatt./Suitable:

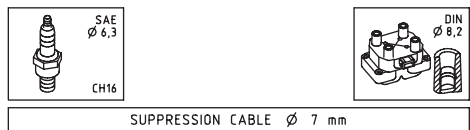
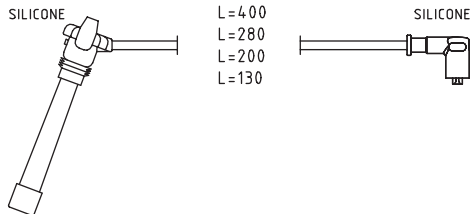
BOSCH
0 986 357 258**FIAT**
46425912**HITACHI**
134332**LANCIA**
46425912**MAGNETI MARELLI**
941095910629

FIAT		
PUNTO I 1.2 16V	176B9.000	04/97 ⇒ 09/99
PUNTO I 85 16V 1.2	176B9.000	04/97 ⇒ 06/00

LANCIA		
YI 1.2 16V	176B9.000	04/97 ⇒ 09/03

EPS 1.501.505

07,5

IGNITION CABLE SETS

Adatt./Suitable:

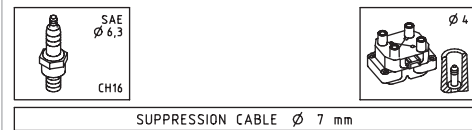
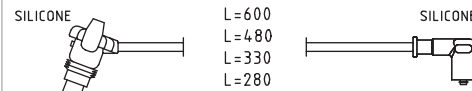
BOSCH
0 986 357 181
F 000 99C 122**FIAT**
46474814
46743086**HITACHI**
134333**LANCIA**
46474814**MAGNETI MARELLI**
941095980634

FIAT

BRAVA 1.2 16V	182B2.000	12/98 ⇒ 12/02
BRAVA 1.2 16V 80	182B2.000, 188A5.000	10/00 ⇒ 12/02
BRAVO I 1.2 16V 80	182B2.000, 188A5.000	10/00 ⇒ 10/01
MAREA 1.2 16V	182B2.000	10/98 ⇒ 05/02
PALIO 1.2	188A5.000	09/01 ⇒ 10/04
PALIO 1.2 16V	178D7.055	06/05 ⇒
PUNTO II 1.2 16V	188A5.000	06/03 ⇒
PUNTO II 1.2 16V 80	188A5.000	09/99 ⇒ 04/06
SIENA 1.2 16V	178D7.055	01/02 ⇒

FIAT (BR)

PALIO 1.0i 16v	1.0Mpi16vFire	01/01 ⇒
PALIO 1.3i 16v	1.3Mpi16vFire	01/00 ⇒
SIENA 1.3i 16v	1.3MpiFire	01/00 ⇒ 12/00

LANCIA

YI 1.2 16V	188A5.000	10/00 ⇒ 09/03
------------	-----------	---------------

EPS 1.501.506

07,5

IGNITION CABLE SETS

Adatt./Suitable:

GENERAL MOTORS
09 119 169
9 193 022

OPEL

16 12 001
16 12 013
16 12 646⁰⁰Eliminated on 22-02-2021. Please verify the availability through our local distributors

• Eliminato il 22-02-2021. Verificare la disponibilità presso i nostri distributori

• Éliminé le 22-02-2021. Vérifier la disponibilité auprès de nos distributeurs sur place

• Am 22-02-2021 gestrichen. Evtl. Verfügbarkeit bitte bei unseren Händlern prüfen

• Eliminado en fecha 22-02-2021. Verificar la disponibilidad a través de nuestros distribuidores locales

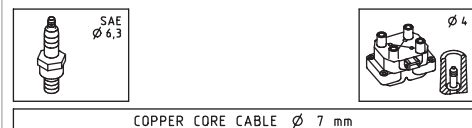
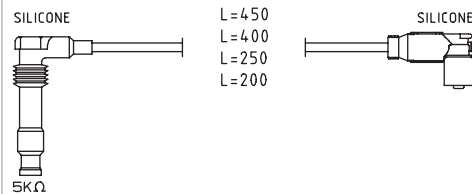

OPEL

ASTRA F 1.8 i 16V	C18SEL, C18XE, C18XEL, X18XE	06/93 ⇒ 03/01
-------------------	------------------------------	---------------

OPEL		
ASTRA F 2.0 i 16V	X20XE	02/95 ⇒ 08/00
CALIBRA A 2.0 i 16V	X20XE	02/94 ⇒ 07/97
CALIBRA A 2.0 i 16V 4x4	X20XE	02/94 ⇒ 07/97
VECTRA B 1.8 i 16V	X18XE	10/95 ⇒ 09/00
VECTRA B 2.0 i 16V	C20SEL, X20XE	09/95 ⇒ 06/00

VAUXHALL

ASTRA III 1.8	C18XE	09/94 ⇒ 08/96
ASTRA III 1.8 16V	C18XEL, X18XE	11/94 ⇒ 03/01
ASTRA III 1.8 i 16V	C18XE, C18XEL, X18XE	06/93 ⇒ 02/98
ASTRA III 2.0 i 16V	X20XE	01/94 ⇒ 09/98
CALIBRA 2.0 i 16V	X20XE	06/90 ⇒ 07/97
CALIBRA 2.0 i 16V 4x4	X20XE	02/94 ⇒ 07/97
VECTRA B 1.8 i 16V	X18XE	10/95 ⇒ 09/00
VECTRA B 2.0 i 16V	X20XE	10/95 ⇒ 01/01

EPS 1.501.507

07,5

IGNITION CABLE SETS

Adatt./Suitable:

BOSCH
0 986 357 270**CHRYSLER**
4883233
4883233AB⁰³Supplied until depletion

- Fornibile fino ad esaurimento delle scorte
- Fourni jusqu'à épuisement du stock
- Lieferbar solange vorrat reicht
- Suministrado hasta el stock termina

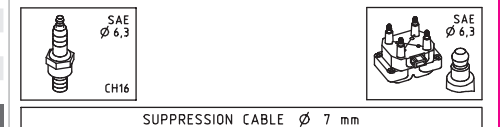
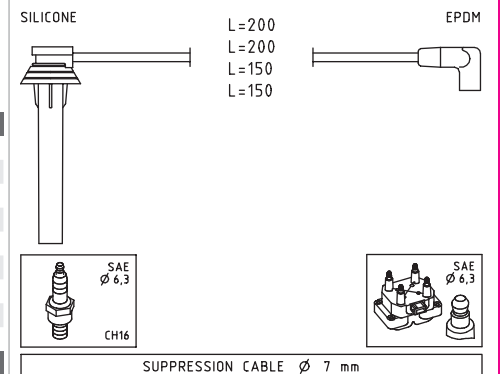

CHRYSLER

CIRRUS 2.0 LX	ECB	10/97 ⇒ 09/00
NEON I 1.8 16V	EBD	09/97 ⇒ 08/99
NEON I 2.0 16V	420H	05/94 ⇒ 08/99
NEON II 2.0 16V	420H	08/99 ⇒ 12/06
SEBRING I 2.0	ECB	05/95 ⇒ 09/00
SEBRING II 2.0	ECC	04/01 ⇒ 06/07
STRATUS 2.0 16V	ECB	12/95 ⇒ 04/01
STRATUS 2.0 LE	420X	12/95 ⇒ 04/01
VOYAGER II 2.0 i	C00	01/95 ⇒ 03/01

1.501.508

IGNITION CABLE SETS

EPS **1.501.508**  **07,5**

IGNITION CABLE SETS

Adatt./Suitable:

BOSCH
0 986 357 270
CHRYSLER
4773841

00 Eliminated on 14-04-2020. Please verify the availability through our local distributors

- Eliminato il 14-04-2020. Verificare la disponibilità presso i nostri distributori
- Éliminé le 14-04-2020. Vérifier la disponibilité auprès de nos distributeurs sur place
- Am 14-04-2020 gestrichen. Evtl. Verfügbarkeit bitte bei unseren Händlern prüfen
- Eliminado en fecha 14-04-2020. Verificar la disponibilidad a través de nuestros distribuidores locales

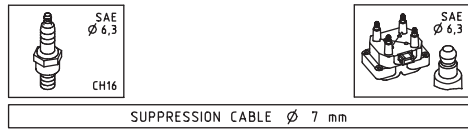
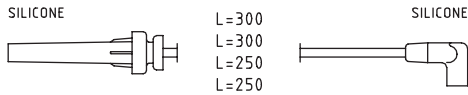

CHRYSLER

CIRRUS 2.4 LX	EDZ	05/94 ⇒ 09/00
NEON I 2.0	ECC	10/96 ⇒ 09/00
NEON I 2.0 16V	420T, ECC	06/94 ⇒ 08/99
SEBRING I 2.4	EDZ	03/96 ⇒ 09/00
STRATUS 2.4 16V	EDZ	12/95 ⇒ 04/01
STRATUS 2.4 16V	EDZ	12/95 ⇒ 04/01
VOYAGER II 2.4 i	B00	01/95 ⇒ 03/01

EPS **1.501.509**  **07,5**

IGNITION CABLE SETS

Adatt./Suitable:

CHEVROLET
96450249
DAEWOO
96450249
HITACHI
134119

03 Supplied until depletion

- Fornibile fino ad esaurimento delle scorte
- Fourni jusqu'à épuisement du stock
- Lieferbar solange vorrat reicht
- Suministrado hasta el stock termina

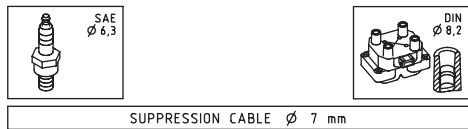
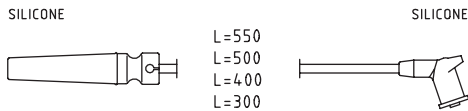

CHEVROLET

LACETTI 1.4	F14D3	03/05 ⇒
LACETTI 1.4 16V	F14D3	03/05 ⇒ 03/13
LACETTI 1.6	F16D3	03/05 ⇒
NUBIRA 1.4	F14D3	01/05 ⇒ 12/08
NUBIRA 1.6	F16D3, LXT	03/05 ⇒
OPTRA 1.4 16V	F14D3	03/05 ⇒
OPTRA 1.6	F16D3, LXT	08/03 ⇒ 12/08
OPTRA 1.6 SRV	F16D3	06/06 ⇒

DAEWOO

LACETTI 1.4	F14D3	02/04 ⇒
LACETTI 1.6	F16D3	02/04 ⇒
NUBIRA II 1.4	F14D3	10/03 ⇒ 12/04
NUBIRA II 1.6	F16D3	07/03 ⇒

EPS **1.501.511**  **07**

IGNITION CABLE SETS

Adatt./Suitable:

CHRYSLER
5018394AE

03 Supplied until depletion

- Fornibile fino ad esaurimento delle scorte
- Fourni jusqu'à épuisement du stock
- Lieferbar solange vorrat reicht
- Suministrado hasta el stock termina

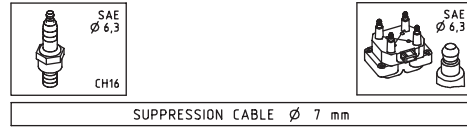
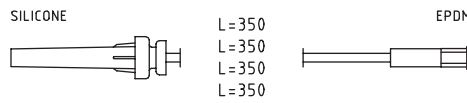

CHRYSLER

PT CRUISER 2.0	ECC	06/00 ⇒ 09/04
PT CRUISER 2.4	EDZ	03/04 ⇒ 03/08
SEBRING II 2.0	ECC	04/01 ⇒ 06/07
SEBRING II 2.4	EDZ	04/01 ⇒ 06/07
VOYAGER III 2.4	EDZ	02/00 ⇒ 12/08

EPS **1.501.518**  **07**

IGNITION CABLE SETS

Adatt./Suitable:

00 Eliminated on 22-02-2022. Please verify the availability through our local distributors

- Eliminato il 22-02-2022. Verificare la disponibilità presso i nostri distributori
- Éliminé le 22-02-2022. Vérifier la disponibilité auprès de nos distributeurs sur place
- Am 22-02-2022 gestrichen. Evtl. Verfügbarkeit bitte bei unseren Händlern prüfen
- Eliminado en fecha 22-02-2022. Verificar la disponibilidad a través de nuestros distribuidores locales

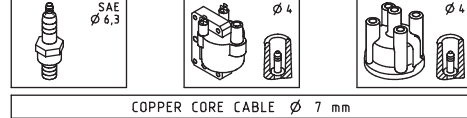
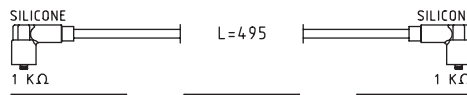
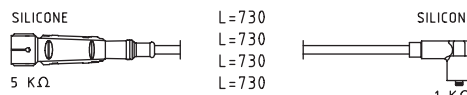

VW

POLO II 1.0	AAU, HZ	01/85 ⇒ 09/94
POLO II 1.0 Cat	AAU, ACM	08/89 ⇒ 09/94
POLO II 1.3	3F	10/90 ⇒ 09/94
POLO II 1.3 Cat	2G, 3F, AAV, MH, NZ	07/87 ⇒ 09/94
POLO II 1.3 G40	PY	08/90 ⇒ 09/94

EPS **1.501.527**  **07**

IGNITION CABLE SETS

Adatt./Suitable:

FIAT
46448661

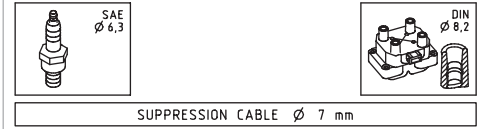
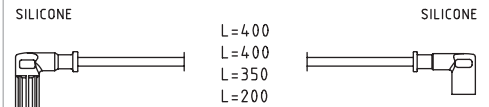

FIAT

PANDA I 900	1170A1.046	04/92 ⇒ 12/96
PANDA I 900 i.e.	1170A1.046	01/98 ⇒

EPS **1.501.529**  **07,5**

IGNITION CABLE SETS

Adatt./Suitable:

GENERAL MOTORS
90 510 857
90 510 858
90 542 968

03 Supplied until depletion

- Fornibile fino ad esaurimento delle scorte
- Fourni jusqu'à épuisement du stock
- Lieferbar solange vorrat reicht
- Suministrado hasta el stock termina

HITACHI

134246

MAGNETI MARELLI
941125380688
941318111140

OPEL

16 12 606
16 12 607
16 12 639

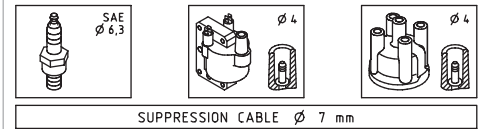
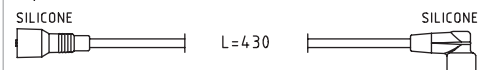
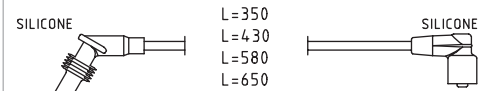

OPEL

ASTRA F 1.4	14NV	09/91 ⇒ 09/93
ASTRA F 1.4 i	C14NZ	09/91 ⇒ 01/05
COMBO B 1.4	C14NZ	07/94 ⇒ 10/01
CORSA B 1.4 i	C14NZ	03/93 ⇒ 09/00

VAUXHALL

ASTRA III 1.4	14NV	09/91 ⇒ 09/93
ASTRA III 1.4 i	C14NZ	09/91 ⇒ 09/98
ASTRA III 1.4 S	14NV	09/91 ⇒ 02/98
ASTRAVAN I 1.4 i	C14NZ	09/91 ⇒ 08/95
COMBO B 1.4	C14NZ	07/94 ⇒ 10/01
CORSA B 1.4 i	C14NZ	03/93 ⇒ 09/00
CORSAVAN I 1.4 i	C14NZ	01/94 ⇒ 09/00

EPS 1.501.531



07

IGNITION CABLE SETS

Adatt./Suitable:

BOSCH
0 986 357 226
GENERAL MOTORS
90 510 851

HITACHI
134234
134275

MAGNETI MARELLI
941125360686

OPEL
16 12 608

03 Supplied until depletion

- Fornibile fino ad esaurimento delle scorte
- Fourni jusqu'à épuisement du stock
- Lieferbar solange vorrat reicht
- Suministrado hasta el stock termina

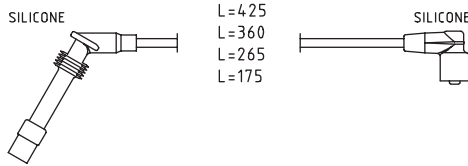

L = 425
L = 360
L = 265
L = 175

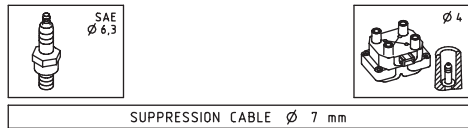
SUPPRESSION CABLE \varnothing 7 mm**OPEL**

ASTRA F 1.4	14SE	09/92 \Rightarrow 09/98
ASTRA F 1.4 Si	C14SE	03/92 \Rightarrow 03/01
ASTRA F 1.6	16NZR	09/95 \Rightarrow 09/98
ASTRA F 1.6 i	X16SZ, X16SZR	09/91 \Rightarrow 01/05
ASTRA F 1.6 Si	C16SE	03/92 \Rightarrow 12/94
VECTRA A 1.6 i	X16SZ	09/93 \Rightarrow 11/95
VECTRA B 1.6 i	X16SZR	10/95 \Rightarrow 07/03

VAUXHALL

ASTRA III 1.4 i	C14SE	03/91 \Rightarrow 03/01
ASTRA III 1.6	C16SE	03/94 \Rightarrow 08/95
ASTRA III 1.6 i	C16SE, X16SZ, X16SZR	03/92 \Rightarrow 09/98
ASTRA III 1.6 Si	C16SE	03/91 \Rightarrow 12/94
ASTRAVAN I 1.6 i	X16SZ	09/94 \Rightarrow 08/96
VECTRA B 1.6 i	X16SZR	08/95 \Rightarrow 03/02

EPS 1.501.549



07

IGNITION CABLE SETS

Adatt./Suitable:

00 Eliminated on 11-03-2021. Please verify the availability through our local distributors

- Eliminato il 11-03-2021. Verificare la disponibilità presso i nostri distributori
- Éliminé le 11-03-2021. Vérifier la disponibilité auprès de nos distributeurs sur place
- Am 11-03-2021 gestrichen. Evtl. Verfügbarkeit bitte bei unseren Händlern prüfen
- Eliminado en fecha 11-03-2021. Verificar la disponibilidad a través de nuestros distribuidores locales

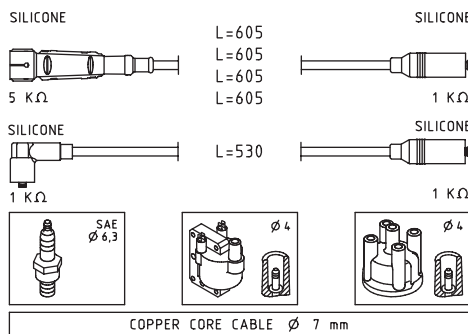

L = 605
L = 605
L = 605
L = 605

L = 530

COPPER CORE CABLE \varnothing 7 mm**SEAT**

CORDOBA I 1.8 i	ACC	02/93 \Rightarrow 09/02
-----------------	-----	---------------------------

VW

GOLF III 1.8	AAM, ADZ	08/91 \Rightarrow 04/99
GOLF III 1.8 Syncro	ADZ	01/93 \Rightarrow 04/99
GOLF III 2.0	ADY, AEP, AGG, AKR	11/91 \Rightarrow 04/99

VW

GOLF III 2.0 GL	AEP	08/95 \Rightarrow 09/97
GOLF III 2.0 Syncro	AGG	08/95 \Rightarrow 04/99
GOLF IV 1.8	AAM, ANN, ANP	06/98 \Rightarrow 06/02
POLO III 90 1.8	ADD	01/97 \Rightarrow 09/01
VENTO 1.6	AEA	09/92 \Rightarrow 09/98
VENTO 1.8	AAM, ADZ, ANP	11/91 \Rightarrow 02/99
VENTO 2.0	ADY, AGG	11/91 \Rightarrow 09/98
VENTO 2.0 GL	AEP	05/96 \Rightarrow 12/97

EPS 1.501.551



07

IGNITION CABLE SETS

Adatt./Suitable:

03 Supplied until depletion

- Fornibile fino ad esaurimento delle scorte
- Fourni jusqu'à épuisement du stock
- Lieferbar solange vorrat reicht
- Suministrado hasta el stock termina

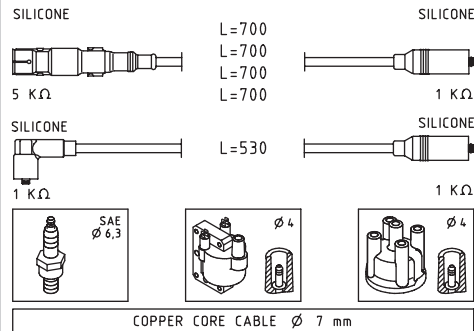

L = 700
L = 700
L = 700
L = 700

L = 530

COPPER CORE CABLE \varnothing 7 mm**VW**

GOLF III 1.6	AEK	07/94 \Rightarrow 04/99
PASSAT III 1.6	AEK	07/94 \Rightarrow 08/96
POLO III 2.0	ADC	08/99 \Rightarrow 09/01
VENTO 1.6	AEK	10/94 \Rightarrow 09/98

EPS 1.501.559



07,5

IGNITION CABLE SETS

Adatt./Suitable:

03 Supplied until depletion

- Fornibile fino ad esaurimento delle scorte
- Fourni jusqu'à épuisement du stock
- Lieferbar solange vorrat reicht
- Suministrado hasta el stock termina

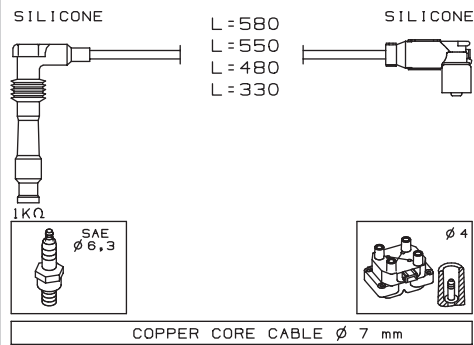

L = 580
L = 550
L = 480
L = 330

COPPER CORE CABLE \varnothing 7 mm**OPEL**

ASTRA F 1.4 i 16V	X14XE	01/96 \Rightarrow 03/01
ASTRA F 1.6 i 16V	X16XEL	08/94 \Rightarrow 01/05
COMBO B 1.4 16V	X14XE	08/99 \Rightarrow 10/01
CORSA B 1.4 i 16V	C14SEL, X14XE	09/94 \Rightarrow 12/02
CORSA B 1.6 GSI 16V	C16XE	03/93 \Rightarrow 09/00
CORSA B 1.6 i 16V	C16SEL, X16XE	09/94 \Rightarrow 09/00
TIGRA A 1.4 16V	X14XE	07/94 \Rightarrow 12/00
TIGRA A 1.6 16V	C16SEL, X16XE	07/94 \Rightarrow 08/98

VAUXHALL

ASTRA III 1.4 i 16V	X14XE	01/96 \Rightarrow 03/01
ASTRA III 1.6 i 16V	X16XEL	01/94 \Rightarrow 09/98
COMBO B 1.4 16V	X14XE	08/99 \Rightarrow 10/01
CORSA B 1.4 i 16V	X14XE	09/94 \Rightarrow 09/00
CORSA B 1.6 GSI 16V	C16XE	03/93 \Rightarrow 09/00

VAUXHALL

CORSA B 1.6 i 16V	X16XE	09/94 \Rightarrow 09/00
TIGRA A 1.4 16V	X14XE	07/94 \Rightarrow 12/00
TIGRA A 1.6 16V	X16XE	07/94 \Rightarrow 12/00

EPS 1.501.562



07

IGNITION CABLE SETS

Adatt./Suitable:

BOSCH
0 986 357 237
F 005 X04 029

GENERAL MOTORS
90 487 571

HOLDEN
90487571

OPEL
16 12 598

00 Eliminated on 22-02-2022. Please verify the availability through our local distributors

- Eliminato il 22-02-2022. Verificare la disponibilità presso i nostri distributori
- Éliminé le 22-02-2022. Vérifier la disponibilité auprès de nos distributeurs sur place
- Am 22-02-2022 gestrichen. Evtl. Verfügbarkeit bitte bei unseren Händlern prüfen
- Eliminado en fecha 22-02-2022. Verificar la disponibilidad a través de nuestros distribuidores locales

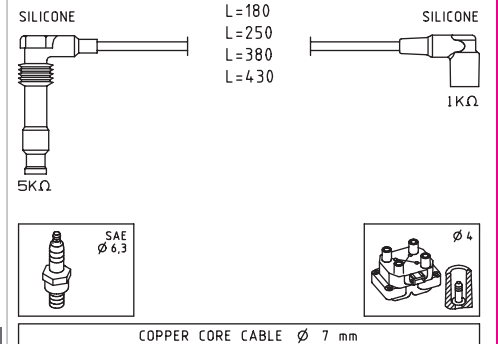

L = 180
L = 250
L = 380
L = 430

COPPER CORE CABLE \varnothing 7 mm**HOLDEN**

ASTRA_TR 1.8i 16v Hatchback	C18SEL	09/96 \Rightarrow 09/98
ASTRA_TR 1.8i 16v Sedan	C18SEL	09/96 \Rightarrow 09/98
ASTRA_TR 2.0i 16v Hatchback	X20XE	09/96 \Rightarrow 09/98
CALIBRA_YE 2.0i 16V	X20XE	08/95 \Rightarrow 10/97

OPEL

ASTRA F 1.8	Z18XEL	02/03 \Rightarrow 07/04
ASTRA F 1.8 i 16V	C18SEL, C18XE, C18XEL, X18XE	06/93 \Rightarrow 03/01
ASTRA F 2.0 i 16V	X20XER, X20XE	02/95 \Rightarrow 08/00
ASTRA G 2.0 16V	X20XE	02/98 \Rightarrow 01/05
ASTRA G 2.0 16V OPC	X20XER	11/99 \Rightarrow 09/02
CALIBRA A 2.0 i 16V	X20XE	02/94 \Rightarrow 07/97
CALIBRA A 2.0 i 16V 4x4	X20XE	02/94 \Rightarrow 07/97
OMEGA B 2.0 16V	X20XE	03/94 \Rightarrow 09/99
SINTRA 2.2 i 16V	X22XE	11/96 \Rightarrow 04/99
VECTRA A 2.0 i 16V	X20XE	08/92 \Rightarrow 08/95
VECTRA A 2.0 i 16V 4x4	X20XE	06/94 \Rightarrow 11/95
VECTRA B 1.8 i 16V	X18XE	10/95 \Rightarrow 09/00
VECTRA B 2.0 i 16V	C20SEL, X20XE	09/95 \Rightarrow 06/00

VAUXHALL

ASTRA III 1.8	C18XE	09/94 \Rightarrow 08/96
ASTRA III 1.8 16V	C18XEL, X18XE	11/94 \Rightarrow 03/01
ASTRA III 1.8 i 16V	C18XE, C18XEL, X18XE	06/93 \Rightarrow 02/98
ASTRA III 2.0 i 16V	X20XE	01/94 \Rightarrow 09/98
ASTRA IV 2.0	X20XER	10/99 \Rightarrow 08/00
ASTRA IV 2.0 16V	X20XE	02/98 \Rightarrow 05/05
CALIBRA 2.0 i 16V	X20XE	06/90 \Rightarrow 07/97
CALIBRA 2.0 i 16V 4x4	X20XE	02/94 \Rightarrow 07/97
OMEGA B 2.0 16V	X20XE	03/94 \Rightarrow 07/01
SINTRA 2.2 i 16V	X22XE	11/96 \Rightarrow 04/99
VECTRA B 1.8 i 16V	X18XE	10/95 \Rightarrow 09/00
VECTRA B 2.0 i 16V	X20XE	10/95 \Rightarrow 01/01

EPS 1.501.568



IGNITION CABLE SETS

Adatt./Suitable:

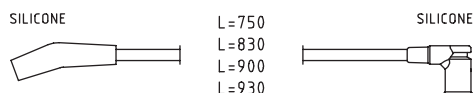

L=750
L=830
L=900
L=930

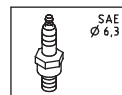
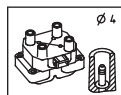
SAE
ø 6,3

ø 4

SUPPRESSION CABLE ø 8 mm

FORD

ESCORT VI 1.3	J4B	01/95 ⇒ 02/99
FIESTA IV 1.0 i	0EAL	04/96 ⇒ 09/99
FIESTA IV 1.3	J4C	02/96 ⇒ 08/03
FIESTA IV 1.3 i	J4C, J4J, J4L, J4Q, J4R, J4T, J4C, J4A, J4C, J4E, J4J, J4K, J4M	08/95 ⇒ 01/02
IKON 1.3 EFI	--	01/00 ⇒
KA I 1.3 i	J4D, J4K, J4M, J4N, J4P, J4S, J4B, J4D, J4F, J4G, J4H, J4L	09/96 ⇒ 11/08

EPS 1.501.569



IGNITION CABLE SETS

Adatt./Suitable:

⁰³ Supplied until depletion

- Fornibile fino ad esaurimento delle scorte
- Fourni jusqu'à épuisement du stock
- Lieferbar solange vorrat reicht
- Suministrado hasta el stock termina

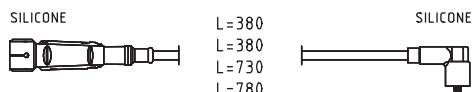

L=380
L=380
L=730
L=780

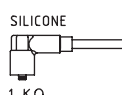
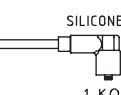
SAE
ø 6,3

ø 4

COPPER CORE CABLE ø 7 mm

SEAT

AROSA 1.0	ALL	05/97 ⇒ 06/04
-----------	-----	---------------

SKODA

FELICIA 1.6	6A16XHT	06/97 ⇒ 04/02
FELICIA 1.6 GLX	6A16XHT	08/95 ⇒ 03/98
FELICIA 1.6 LX	6A16XHT	08/95 ⇒ 03/98

EPS 1.501.575



IGNITION CABLE SETS

Adatt./Suitable:

VW

036 905 409 K

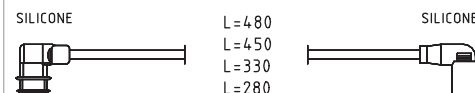

L=480
L=450
L=330
L=280

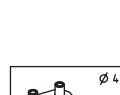
SAE
ø 6,3

ø 4

AUDI

A2 1.4	AUA	02/00 ⇒ 08/05
--------	-----	---------------

SEAT

AROSA 1.4 16V	0P11C-VF, AQQ, AUB	01/00 ⇒ 06/04
CORDOBA I 1.4 16V	2CJXE, AUA	06/99 ⇒ 12/02
IBIZA II 1.4 16V	2CJXE, AUA	05/00 ⇒ 02/02
IBIZA II 1.4 i 16V	AQQ	06/97 ⇒ 02/02
IBIZA III 1.4 16V	AUB	02/02 ⇒ 11/09
INCA 1.4 16V	AUA	04/00 ⇒ 06/03
LEON I 1.4 16V	2CJXE, AHW, AXP	11/99 ⇒ 06/06
LEON I 1.6 16V	AUS	09/00 ⇒ 06/06
TOLEDO II 1.4 16V	2CJXE, AHW, AXP	01/00 ⇒ 05/02
TOLEDO II 1.6 16V	AUS	06/00 ⇒ 05/06

SKODA

FABIA I 1.4 16V	AUA, AUB, BBY, BBZ	10/99 ⇒ 03/08
-----------------	--------------------	---------------

OCTAVIA I 1.4 16V	AXP, BCA	08/00 ⇒ 12/10
-------------------	----------	---------------

VOLKSWAGEN (BR)

POLO 1.0	ARA	07/02 ⇒ 01/04
----------	-----	---------------

VW

BORA 1.4 16V	AHW, AKQ, APE, AXP	03/00 ⇒ 05/05
BORA 1.6 16V	ATN, AUS	02/00 ⇒ 05/05
CADDY II 1.4	AUA	08/00 ⇒ 01/04
CADDY II 1.4 16V	AUA	08/00 ⇒ 01/04
GOLF IV 1.4 16V	AHW, AKQ, APE, AXP	10/97 ⇒ 06/06
GOLF IV 1.6 16V	ATN, AUS	02/00 ⇒ 06/06
POLO IV 1.0	ARA	02/03 ⇒ 10/03
POLO IV 1.4 16V	AUA	10/01 ⇒ 05/08
LUPO 1.4 16V	AFK, AHW, AKQ, APE, AQQ, AUA, AUB	09/98 ⇒ 07/05
LUPO 1.6 GTI	AVY	09/00 ⇒ 07/05
POLO III 1.4 16V	AFK, AHW, APE, AUA, AUB	10/99 ⇒ 09/01
POLO III 1.6 16V GTI	ARC, AVY	10/99 ⇒ 09/01
POLO III 120 1.6 16V GTI	AJV	09/98 ⇒ 10/99
POLO III 75 1.4 16V	APE, AUA	10/99 ⇒ 09/01

EPS 1.501.580



IGNITION CABLE SETS

Adatt./Suitable:

⁰³ Supplied until depletion

- Fornibile fino ad esaurimento delle scorte
- Fourni jusqu'à épuisement du stock
- Lieferbar solange vorrat reicht
- Suministrado hasta el stock termina

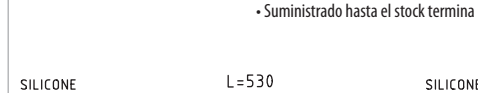

L=530
L=450
L=380
L=330

SAE
ø 6,3

ø 4

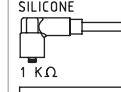
SAE
ø 6,3

ø 4

COPPER CORE CABLE ø 7 mm

VW

POLO III 100 1.4 16V	AFH	04/96 ⇒ 10/99
----------------------	-----	---------------

EPS 1.501.585



IGNITION CABLE SETS

Adatt./Suitable:

VW

06A 905 409 L

06A 905 409 P

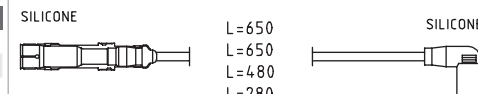

L=650
L=650
L=480
L=280

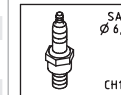
SAE
ø 6,3

ø 4

COPPER CORE CABLE ø 7 mm

AUDI

A3 I 1.6	AEH, AVU, BFQ	08/00 ⇒ 05/03
A3 II 1.6	BGU, BSE, BSF	05/03 ⇒ 03/13
A3 II 1.6 E-Power	CCSA, CMXA	01/11 ⇒ 03/13
A4 II 1.6	ALZ	11/00 ⇒ 12/04
A4 I 1.6	OD6-280I-A, AHL, ALZ, ANA	07/00 ⇒ 09/01
A4 III 1.6	ALZ	11/04 ⇒ 06/08

SEAT

ALTEA 1.6	BGU, BSE, BSF, CCSA, CMXA	03/04 ⇒
ALTEA 1.6 LPG	CHGA	09/09 ⇒
ALTEA XL 1.6	BSE, BSF, CCSA, CMXA	10/06 ⇒
ALTEA XL 1.6 LPG	CHGA	09/09 ⇒
ALTEA XL 1.6 Multifuel	CCSA	10/06 ⇒ 11/10
EXEO 1.6	ALZ	03/09 ⇒ 09/10
IBIZA III 2.0	AZL, BBX	04/02 ⇒ 11/09
CORDOBA II 2.0	AZL, BBX	09/02 ⇒ 11/09
IBIZA IV 2.0	CEKA	10/08 ⇒ 05/15
ALHAMBRA I / II 2.0 i	ATM	04/96 ⇒ 03/10
LEON I 1.6	BFQ	10/05 ⇒ 06/06
LEON II 1.6	BSE, BSF, CCSA, CMXA	07/05 ⇒ 12/12
LEON II 1.6 LPG	CHGA	12/09 ⇒ 12/12
LEON II 1.6 MultiFuel	BSE, CMXA	07/05 ⇒ 08/13
TOLEDO III 1.6	BGU, BSE, BSF	10/04 ⇒ 05/09

SKODA

FABIA I 2.0	AZL	12/99 ⇒ 03/08
SUPERB I 2.0	AZM	12/01 ⇒ 03/08
OCTAVIA I 1.6	AVU, BFQ	09/00 ⇒ 12/10
OCTAVIA I 2.0	AEG, APK, AQQ, AZH	04/99 ⇒ 05/07
OCTAVIA I 2.0 4x4	AZH	08/00 ⇒ 09/04

SKODA		
OCTAVIA II 1.6	BGU, BSE, BSF, CCSA, CMXA	06/04 ⇒ 06/13
OCTAVIA II 1.6 LPG	CHGA	08/09 ⇒ 11/12
OCTAVIA II 1.6 MultiFuel	CCSA, CMXA	01/08 ⇒ 06/13
OCTAVIA II 2.0 [CHN]	BXX., CGZA.	04/07 ⇒
VOLKSWAGEN (BR)		
GOLF A4 2.0i	APK	08/99 ⇒
POLO 2.0	BBX	05/02 ⇒
VW		
PASSAT IV 1.6	AHL, ALZ, ANA, ARM	10/96 ⇒ 05/05
PASSAT IV 2.0	AZM, BFF	11/00 ⇒ 05/05
PASSAT IV 2.0 [CHN]	BFF, BNL	06/03 ⇒
PASSAT IV 2.0 4motion	AZM	11/00 ⇒ 05/05
GOLF VI 1.6	BSE, BSF, CCSA, CMXA	10/08 ⇒
GOLF VI 1.6 BiFuel	CHGA	03/09 ⇒
GOLF VI 1.6 MultiFuel	CCSA, CHGA, CMXA	10/08 ⇒
BORA 1.6	AVU, BFQ	08/00 ⇒ 05/05
BORA 2.0	APK, AQY, AZH	10/98 ⇒ 12/13
BORA 2.0 4motion	AZH	04/00 ⇒ 05/05
GOLF V 1.6	BGU, BSE, BSF, CCSA, CHGA	01/04 ⇒
GOLF V 1.6 MultiFuel	CCSA	10/07 ⇒ 12/13
GOLF V 2.0	BHY	01/05 ⇒ 11/08
CADDY III 1.6	BGU, BRY, BSE, BSF	04/04 ⇒ 05/15
CADDY III 1.6 BiFuel	CHGA	05/11 ⇒ 05/15
JETTA V 1.6	BSE, BSF, CCSA	09/04 ⇒ 10/10
JETTA V 1.6 [CHN]	BJG	01/05 ⇒
JETTA V 1.6 MultiFuel	CCSA	01/08 ⇒ 10/10
PASSAT V 1.6	BSE, BSF	05/05 ⇒ 11/10
GOLF IV 1.6	AVU, BFQ	08/00 ⇒ 06/06
GOLF IV 2.0	APK, AQY	07/98 ⇒ 06/06
GOLF IV 2.0 4motion	AZH	10/00 ⇒ 06/06
JETTA VI 2.0	CBPA	06/10 ⇒ 12/17
POLO IV 2.0	BBX	09/02 ⇒
POLO III 1.6	APF, AUR	05/97 ⇒ 09/01
POLO III 100 1.6	APF, AUR	12/95 ⇒ 09/01
MULTIVAN 2.0	AXA	11/03 ⇒ 08/15
NEW BEETLE 1.6	AWH, AYD, BFS	06/00 ⇒ 09/10
NEW BEETLE 2.0	AEG, APK, AQY, BER, BHP, CBPA	01/98 ⇒ 10/10
SHARAN I 2.0	ATM	09/95 ⇒ 03/10
SHARAN I 2.0 LPG	ATM	04/06 ⇒ 03/10
TOURAN I 1.6	BGU, BSE, BSF	07/03 ⇒ 05/10
TOURAN I 2.0 FSI	BJZ	10/04 ⇒ 05/10
TOURAN I 2.0 TDI [CHN]	CGZA	04/09 ⇒
TRANSPORTER V 2.0	AXA	11/03 ⇒ 08/15

EPS 1.501.595



IGNITION CABLE SETS

Adatt./Suitable:

00 Eliminated on 13-09-2021. Please verify the availability through our local distributors

- Eliminato il 13-09-2021. Verificare la disponibilità presso i nostri distributori
- Éliminé le 13-09-2021. Vérifier la disponibilité auprès de nos distributeurs sur place
- Am 13-09-2021 gestrichen. Evtl. Verfügbarkeit bitte bei unseren Händlern prüfen
- Eliminado en fecha 13-09-2021. Verificar la disponibilidad a través de nuestros distribuidores locales

03 Supplied until depletion

- Fornibile fino ad esaurimento delle scorte
- Fourni jusqu'à épuisement du stock
- Lieferbar solange vorrat reicht
- Suministrado hasta el stock termina

SILICONE

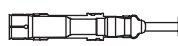

L=880
L=700
L=650
L=600

SILICONE

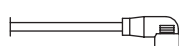

5 KΩ

1 KΩ

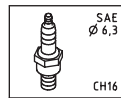

SAE
∅ 6,3
CH16

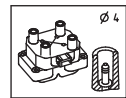

∅ 4

COPPER CORE CABLE ∅ 7 mm

SEAT

AROSA 1.0	ALD, ANV	05/97 ⇒ 06/04
AROSA 1.4	4A20NFT	05/97 ⇒ 06/04

VW

LUPO 1.0	ALD, ANV	09/98 ⇒ 07/05
----------	----------	---------------

EPS 1.501.601



IGNITION CABLE SETS

Adatt./Suitable:

SILICONE



L=850
L=700
L=630
L=600

SILICONE

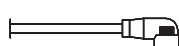

5 KΩ

1 KΩ

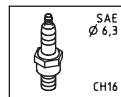

SAE
∅ 6,3
CH16

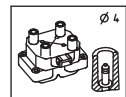

∅ 4

COPPER CORE CABLE ∅ 7 mm

SEAT

AROSA 1.0	AUC	05/97 ⇒ 06/04
AROSA 1.4	AUD	05/97 ⇒ 06/04
IBIZA II 1.0 i	AUC	09/96 ⇒ 02/02
IBIZA II 1.4 i	AUD	09/93 ⇒ 02/02
INCA 1.4 i	AUD	11/95 ⇒ 06/03

VW

CADDY II 1.4	AUD	11/95 ⇒ 06/03
CADDY II 60 1.4	AUD	11/95 ⇒ 01/04
LUPO 1.0	AUC	09/98 ⇒ 07/05
LUPO 1.4	AUD	10/00 ⇒ 07/05
POLO III 1.0	ALD, AUC	10/99 ⇒ 09/01
POLO III 1.4	AKK, AKP, ANW, AUD	05/97 ⇒ 09/01
POLO III 60 1.4	AKK, ANW, AUD	12/95 ⇒ 09/01

EPS 1.501.607



IGNITION CABLE SETS

Adatt./Suitable:

00 Eliminated on 31-08-2021. Please verify the availability through our local distributors

- Eliminato il 31-08-2021. Verificare la disponibilità presso i nostri distributori
- Éliminé le 31-08-2021. Vérifier la disponibilité auprès de nos distributeurs sur place
- Am 31-08-2021 gestrichen. Evtl. Verfügbarkeit bitte bei unseren Händlern prüfen
- Eliminado en fecha 31-08-2021. Verificar la disponibilidad a través de nuestros distribuidores locales

03 Supplied until depletion

- Fornibile fino ad esaurimento delle scorte
- Fourni jusqu'à épuisement du stock
- Lieferbar solange vorrat reicht
- Suministrado hasta el stock termina

SILICONE



L=120
L=120
L=120
L=120

SILICONE



2 KΩ

1 KΩ

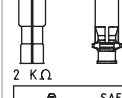

SAE
∅ 6,3



2 KΩ

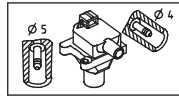

∅ 5
∅ 4

COPPER CORE CABLE ∅ 7 mm

ALFA ROMEO

147 1.6 16V T.SPARK	AR32104	01/01 ⇒ 03/10
147 1.6 16V T.SPARK ECO	AR37203	01/01 ⇒ 03/10
147 2.0 16V T.SPARK	AR32310	01/01 ⇒ 03/10
156 1.6 16V T.SPARK	AR32103, AR32104	09/97 ⇒ 09/05
156 1.6 16V T.SPARK.	AR32103, AR32104	05/00 ⇒ 05/06
156 2.0 16V T.SPARK	AR32310	05/00 ⇒ 06/02
166 2.0 T.SPARK	AR36301	10/00 ⇒ 06/07
GT 1.8 TS	AR32205	11/03 ⇒ 09/10
GTV 2.0 T.SPARK 16V	AR32310	06/95 ⇒ 10/05
SPIDER II 2.0 T.SPARK 16V	AR32310	06/95 ⇒ 04/05

EPS 1.501.608

07,5

IGNITION CABLE SETS

Adatt./Suitable:

00 Eliminated on 14-06-2021. Please verify the availability through our local distributors

- Eliminato il 14-06-2021. Verificare la disponibilità presso i nostri distributori
- Éliminé le 14-06-2021. Vérifier la disponibilité auprès de nos distributeurs sur place
- Am 14-06-2021 gestrichen. Evtl. Verfügbarkeit bitte bei unseren Händlern prüfen
- Eliminado en fecha 14-06-2021. Verificar la disponibilidad a través de nuestros distribuidores locales

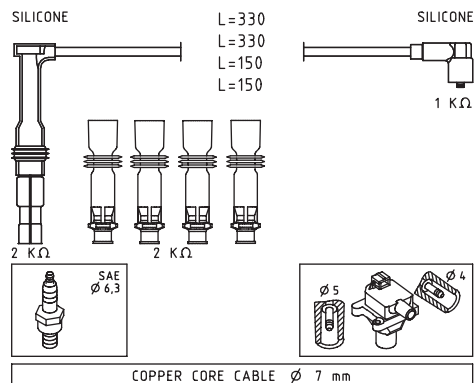

ALFA ROMEO

145 1.4 i.e. 16V T.S.	AR33503	12/96 ⇒ 01/01
145 1.6 16V T.S.	AR32102	09/97 ⇒ 12/00
145 1.8 i.e. 16V	AR32201	03/98 ⇒ 01/01
145 1.8 i.e. 16V T.S.	AR67106	12/96 ⇒ 12/98
145 1.8 i.e. 16V T.S. [BRA]	AR67199	10/96 ⇒ 02/99
145 2.0 16V	AR32301	03/98 ⇒ 01/01
145 2.0 16V T.S.	AR67204	10/95 ⇒ 01/01
145 2.0 16V T.SPARK [BRA]	AR67299	10/96 ⇒ 02/99
146 1.4 i.e. 16V T.S.	AR33503	11/96 ⇒ 01/01
146 1.6 16V T.S.	AR32102	09/97 ⇒ 12/00
146 1.6 i.e. 16V T.S.	AR67601	11/96 ⇒ 10/01
146 1.8 i.e. 16V T.S.	AR32201, AR67106	11/96 ⇒ 01/01
146 2.0 16V	AR32301	03/97 ⇒ 10/01
146 2.0 16V T.S.	AR67204	10/95 ⇒ 01/01
155 1.6 16V T.S.	AR67601	05/96 ⇒ 12/97
155 1.7 T.S. 16V	AR67106	05/96 ⇒ 12/97
155 2.0 T.S. 16V	AR67204, AR67299	03/95 ⇒ 12/97
156 1.6 16V T.SPARK	AR32102, AR67601	09/97 ⇒ 09/05
156 1.6 16V T.SPARK.	AR32102, AR67601	05/00 ⇒ 05/06
156 1.8 16V T.SPARK	AR32201	09/97 ⇒ 10/00
156 2.0 16V T.SPARK	AR32301	09/97 ⇒ 06/02
166 2.0 T.SPARK	AR34103	09/98 ⇒ 10/00
GTV 1.8 16V	AR32201	05/98 ⇒ 10/05
GTV 2.0 T.SPARK 16V	AR16201, AR32301	06/95 ⇒ 10/05
SPIDER II 1.8 16V	AR32201	05/98 ⇒ 04/05
SPIDER II 2.0 T.SPARK 16V	AR16201, AR32301	06/95 ⇒ 04/05

EPS 1.501.609

07

IGNITION CABLE SETS

Adatt./Suitable:

03 Supplied until depletion

- Fornibile fino ad esaurimento delle scorte
- Fourni jusqu'à épuisement du stock
- Lieferbar solange vorrat reicht
- Suministrado hasta el stock termina

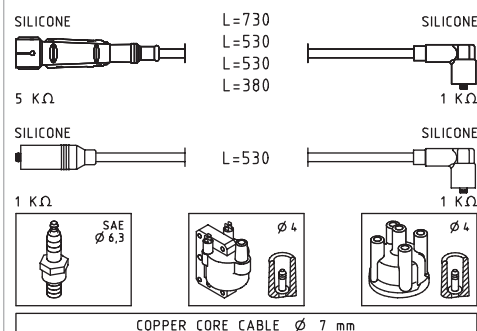

SKODA

OCTAVIA I 1.6 6A16XHT 09/96 ⇒ 09/04

VW

GOLF III 1.6 AEE 09/92 ⇒ 08/97

VENTO 1.6 AEE 09/92 ⇒ 09/98

EPS 1.501.614

07

IGNITION CABLE SETS

Adatt./Suitable:

03 Supplied until depletion

- Fornibile fino ad esaurimento delle scorte
- Fourni jusqu'à épuisement du stock
- Lieferbar solange vorrat reicht
- Suministrado hasta el stock termina

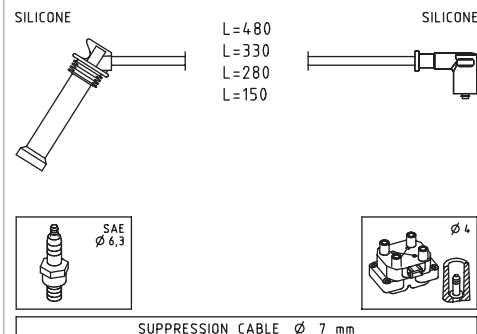

EPS 1.501.619

07

IGNITION CABLE SETS

Adatt./Suitable:

03 Supplied until depletion

- Fornibile fino ad esaurimento delle scorte
- Fourni jusqu'à épuisement du stock
- Lieferbar solange vorrat reicht
- Suministrado hasta el stock termina

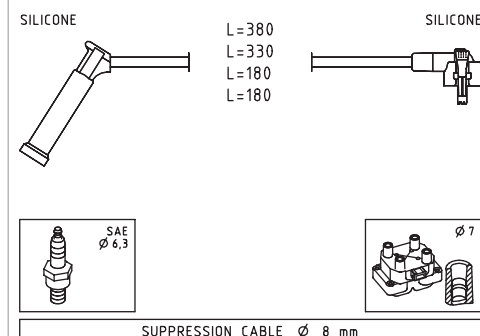

FORD

FIESTA IV 1.25 i 16V DHA, DHB, DHC, DHD, DHE, DHE, DHG 08/95 ⇒ 01/02

FIESTA IV 1.4 i 16V FHA, FHE 04/96 ⇒ 01/02

PUMA 1.4 16V FHD, FHF 11/97 ⇒ 10/00

PUMA 1.7 16V MHA, MHB 03/97 ⇒ 06/02

EPS 1.501.624

07

IGNITION CABLE SETS

Adatt./Suitable:

03 Supplied until depletion

- Fornibile fino ad esaurimento delle scorte
- Fourni jusqu'à épuisement du stock
- Lieferbar solange vorrat reicht
- Suministrado hasta el stock termina

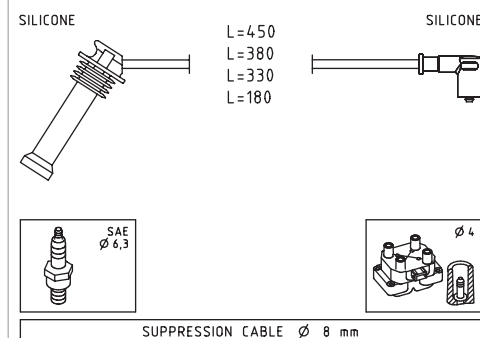

FORD

COUGAR 2.0 16V EDDB, EDDB, EDBC, EDBD 08/98 ⇒ 12/01

FOCUS I 1.6 16V -- 02/01 ⇒ 11/04

FOCUS I 1.8 16V EYDB, EYDC, EYDD, EYDE, EYDF, EYDG, EYDI, EYDJ, EYDL 10/98 ⇒ 11/04

FOCUS I 1.8 BiFuel EYDL 02/03 ⇒ 01/05

FOCUS I 2.0 16V EDDB, EDDC, EDDD, EDDF 10/98 ⇒ 11/04

FOCUS I RS HMDA 10/02 ⇒ 11/04

FOCUS I ST170 ALDA 03/02 ⇒ 11/04

MAVERICK 2.0 16V YF 02/01 ⇒

MONDEO I 1.6 i L1J 08/96 ⇒ 09/00

MONDEO I 1.6 i 16V L1L, L1N, L1Q 05/98 ⇒ 09/00

MONDEO I 1.8 i RKB, RKF, RKH, RKJ, RKK 08/96 ⇒ 09/00

MONDEO I 2.0 i NGA, NGB, NGC, NGD 08/96 ⇒ 09/00

TOURNEO CONNECT I 1.8 16V EYPA, EYPC, EYPD 06/02 ⇒ 12/13

TRANSIT CONNECT I 1.8 16V EYPA, EYPC, EYPD 06/02 ⇒ 12/13

TRANSIT CONNECT I 1.8 16V LPG EYPC 06/02 ⇒ 12/13

EPS 1.501.625



IGNITION CABLE SETS

Adatt./Suitable:

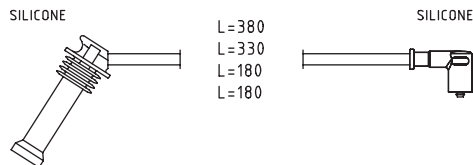

SUPPRESSION CABLE \varnothing 8 mm

FORD		
FIESTA V 1.25 16V	FUJA, FUJB, M7JA, M7JB	05/02 \Rightarrow 06/08
FIESTA V 1.4 16V	FXJA, FXJB	11/01 \Rightarrow 06/08
FIESTA V 1.6 16V	FYJA, FYJB	11/01 \Rightarrow 06/08
FIESTA IV 1.25 i 16V	DHA, DHB, DHC, DHD, DHE, DHF, DHG	08/95 \Rightarrow 01/02
FIESTA IV 1.4 i 16V	FHA, FHE	04/96 \Rightarrow 01/02
FIESTA IV 1.6 16V Sport	L1T, L1V	02/00 \Rightarrow 01/02
FOCUS I 1.4 16V	FXDA, FXDB, FXDC, FXDD	10/98 \Rightarrow 11/04
FOCUS I 1.6 16V	FYDA, FYDB, FYDC, FYDD, FYDH	10/98 \Rightarrow 11/04
FOCUS II 1.4	ASDA, ASDB	07/04 \Rightarrow 09/12
FOCUS II 1.6	HWDA, HWDB, SHDA, SHDB, SHDC	07/04 \Rightarrow 09/12
FOCUS II 1.6 Ti	HXDA, HXDB	07/04 \Rightarrow 09/12
FOCUS C-MAX 1.6	HWDA, HWDB	10/03 \Rightarrow 03/07
FOCUS C-MAX 1.6 Ti	HXDA, SIDA	08/04 \Rightarrow 03/07
FUSION 1.25	-, FUJA, FUJB	10/02 \Rightarrow
FUSION 1.4	-, FXJA, FXJB, FXJC	08/02 \Rightarrow
FUSION 1.6	FYJA, FYJB, FYJC	08/02 \Rightarrow 11/09
MONDEO III 1.6 Ti	KGBA, PNBA, RHBA	03/07 \Rightarrow 01/15
PUMA 1.4 16V	FHD, FHF	11/97 \Rightarrow 10/00
PUMA 1.6 16V	L1W	08/00 \Rightarrow 06/02
PUMA 1.7 16V	MHA, MHB	03/97 \Rightarrow 06/02

EPS 1.501.630



IGNITION CABLE SETS

Adatt./Suitable:

- 03 Supplied until depletion**
- Fornibile fino ad esaurimento delle scorte
 - Fourni jusqu'à épuisement du stock
 - Lieferbar solange vorrat reicht
 - Suministrado hasta el stock termina

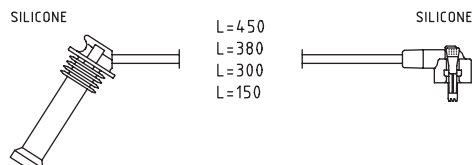

SUPPRESSION CABLE \varnothing 8 mm

FORD		
ESCORT IV 1.6 16V	L1E	10/98 \Rightarrow 07/00
ESCORT V 1.6 16V XR3i	L1E	12/92 \Rightarrow 01/95
ESCORT V 1.6 i 16V	L1E, L1H, L1K	09/92 \Rightarrow 01/95
ESCORT V 1.8 16V	RDA	02/92 \Rightarrow 01/95
ESCORT V 1.8 16V XR3i	99BFR1740, RDA	02/92 \Rightarrow 01/95
ESCORT V 1.8 i 16V	99BFR1740	09/92 \Rightarrow 01/95
ESCORT V 1.8 XR3i 16V 4x4	99BFR1740, RDA	08/93 \Rightarrow 01/95
ESCORT VI 1.6 16V	L1E	01/95 \Rightarrow 07/00
ESCORT VI 1.6 16V 4x4	L1E	01/95 \Rightarrow 10/98
ESCORT VI 1.6 16V XR3i	L1E, L1H	02/95 \Rightarrow 09/99

FORD			
ESCORT VI 1.6 i 16V	L1E, L1H, L1K	01/95 \Rightarrow 02/99	
ESCORT VI 1.8 16V	RDA, RKC	01/95 \Rightarrow 02/99	
ESCORT VI 1.8 16V XR3i	RDA, RKC	02/95 \Rightarrow 08/98	
FIESTA III 1.6 i 16V	L1G	01/94 \Rightarrow 12/95	
FIESTA III 1.8 16V	RDB	02/92 \Rightarrow 12/95	
FIESTA III 1.8 XR2i 16V	RQC	02/92 \Rightarrow 12/95	
MONDEO I 1.6 i	L1J	08/96 \Rightarrow 09/00	
MONDEO I 1.6 i 16V	L1F, L1J, L1L, L1N, L1Q	02/93 \Rightarrow 09/00	
MONDEO I 1.8 4x4	RKA	02/93 \Rightarrow 08/96	
MONDEO I 1.8 i	RKB, RKF, RKH, RKJ, RKK	08/96 \Rightarrow 09/00	
MONDEO I 1.8 i 16V	RKA, RKB	02/93 \Rightarrow 08/96	
MONDEO I 1.8 i 16V 4x4	RKA	02/93 \Rightarrow 08/96	
MONDEO I 2.0 i	NGA, NGB, NGC, NGD	08/96 \Rightarrow 09/00	
MONDEO I 2.0 i 16V	NGA	01/93 \Rightarrow 08/96	
MONDEO I 2.0 i 16V 4x4	NGA	02/93 \Rightarrow 08/96	
ORION II 1.6 i 16V	L1E, L1K	07/92 \Rightarrow 12/93	
ORION II 1.8 i 16V	99BFR1740, RDA	01/92 \Rightarrow 12/93	

EPS 1.501.634



IGNITION CABLE SETS

Adatt./Suitable:

- BOSCH**
0 986 356 988
- CHEVROLET**
96256433
96518123
- DAEWOO**
96256433
96518123
- GENERAL MOTORS**
96 518 123
- HITACHI**
134227
- 03 Supplied until depletion**
- Fornibile fino ad esaurimento delle scorte
 - Fourni jusqu'à épuisement du stock
 - Lieferbar solange vorrat reicht
 - Suministrado hasta el stock termina

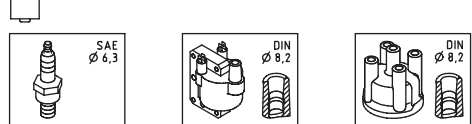
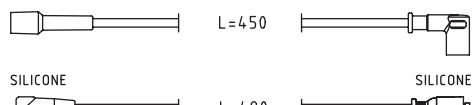
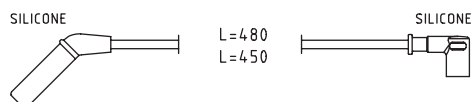

SUPPRESSION CABLE \varnothing 7 mm

CHEVROLET		
MATIZ 0.8	LBF(49CUL3), LQZ(49CUL3)	03/05 \Rightarrow 12/13
MATIZ 0.8 LPG	F8CV	03/05 \Rightarrow 12/07
SPARK I 0.8	F8CV	09/00 \Rightarrow 12/06
SPARK II 0.8	F8CV	05/05 \Rightarrow 02/10
DAEWOO		
MATIZ 0.8	F8CV	08/98 \Rightarrow

EPS 1.501.639



IGNITION CABLE SETS

Adatt./Suitable:

- 03 Supplied until depletion**
- Fornibile fino ad esaurimento delle scorte
 - Fourni jusqu'à épuisement du stock
 - Lieferbar solange vorrat reicht
 - Suministrado hasta el stock termina

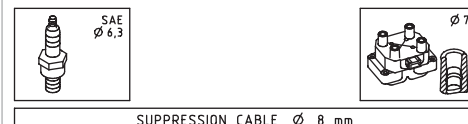
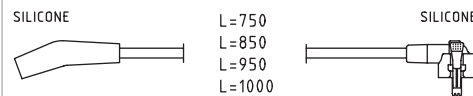

SUPPRESSION CABLE \varnothing 8 mm

FORD		
ESCORT VI 1.3	J4B	01/95 \Rightarrow 02/99
FIESTA IV 1.0 i	0EAL	04/96 \Rightarrow 09/99
FIESTA IV 1.3	J4C	02/96 \Rightarrow 08/03
FIESTA IV 1.3 i	J4C, J4J, J4L, J4Q, J4R, J4T, J4C, J4A, J4C, J4E, J4J, J4K, J4M	08/95 \Rightarrow 01/02
KAI 1.3 i	J4D, J4K, J4M, J4N, J4P, J4S, J4B, J4D, J4F, J4G, J4H, J4L	09/96 \Rightarrow 11/08

EPS 1.501.640



IGNITION CABLE SETS

Adatt./Suitable:

- 03 Supplied until depletion**
- Fornibile fino ad esaurimento delle scorte
 - Fourni jusqu'à épuisement du stock
 - Lieferbar solange vorrat reicht
 - Suministrado hasta el stock termina

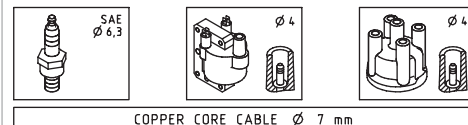
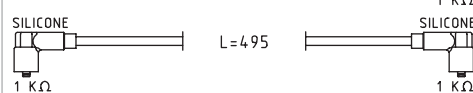
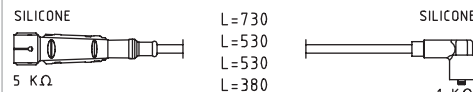

COPPER CORE CABLE \varnothing 7 mm

SEAT		
CORDOBA I 1.0 i	AER	09/96 \Rightarrow 10/02
CORDOBA I 1.4	ANX	12/97 \Rightarrow 04/99
CORDOBA I 1.4 i	AEX, AKV, APQ	06/94 \Rightarrow 12/02
CORDOBA I 1.6 i	AEE, ALM	02/93 \Rightarrow 12/02
IBIZA II 1.0 i	AER	09/96 \Rightarrow 02/02
IBIZA II 1.4	ANX	12/97 \Rightarrow 04/99
IBIZA II 1.4 i	AEX, AKV, APQ	09/93 \Rightarrow 02/02
IBIZA II 1.6 i	AEE, ALM	03/93 \Rightarrow 02/02

VW		
POLO III 1.4	AEX, AKV, ANX, APQ	05/97 \Rightarrow 09/01
POLO III 1.6	AEE, ALM	05/97 \Rightarrow 09/01
POLO III 54 1.4	ANX	01/98 \Rightarrow 08/99
POLO III 55 1.4	AEX	08/95 \Rightarrow 10/99
POLO III 60 1.4	AEX, AKV, APQ	07/95 \Rightarrow 09/01
POLO III 75 1.6	AEE, ALM	10/94 \Rightarrow 09/01
VENTO 1.4	AEX	11/91 \Rightarrow 09/98

EPS 1.501.641

07

IGNITION CABLE SETS

Adatt./Suitable:

03 Supplied until depletion

- Fornibile fino ad esaurimento delle scorte
- Fourni jusqu'à épuisement du stock
- Lieferbar solange vorrat reicht
- Suministrado hasta el stock termina

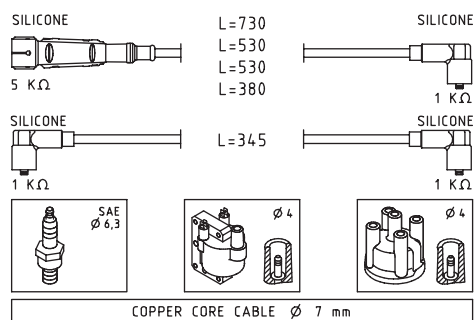

SEAT

AROSA 1.0	AER	05/97 ⇒ 06/04
AROSA 1.4	AEX, AKV, APQ	05/97 ⇒ 06/04

VW

CADDY II 1.6	AEE	06/96 ⇒ 12/00
LUPU 1.0	AER, ALL	09/98 ⇒ 07/05
POLO III 1.4	AEX	05/97 ⇒ 09/01
POLO III 50 1.0	AER, ALL	09/96 ⇒ 10/99
POLO III 55 1.4	AEX	08/95 ⇒ 10/99
POLO III 60 1.4	AEX, AKV	07/95 ⇒ 09/01
POLO III 75 1.6	AEE, AHS	10/94 ⇒ 09/01
POLO IV 1.0	AER	08/96 ⇒ 12/01

EPS 1.501.643

07

IGNITION CABLE SETS

Adatt./Suitable:

BOSCH
0 356 912 975HITACHI
134952SMART
Q 0002576V002000000

03 Supplied until depletion

- Fornibile fino ad esaurimento delle scorte
- Fourni jusqu'à épuisement du stock
- Lieferbar solange vorrat reicht
- Suministrado hasta el stock termina

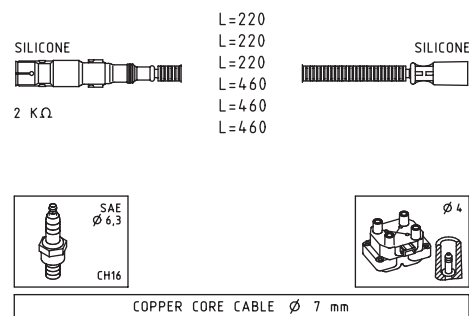

SMART

CABRIO 0.6	M160E6ALB03, M160E-6ALB05, M160.910, M160.920	03/00 ⇒ 01/04
CABRIO 0.7	M160.910	01/03 ⇒ 01/04
CITY-COUPÉ 0.6	M160E6ALB03, M160E-6ALB04, M160E6ALB05, M160.920	01/01 ⇒ 01/04
CITY-COUPÉ 0.7	M160.910	01/03 ⇒ 01/04
CROSSBLADE 0.6	M160.920	06/02 ⇒ 12/03
FORTWO I 0.7	M160.910	01/04 ⇒ 01/07
ROADSTER 0.7	M160.921, M160.922	04/03 ⇒ 11/05
ROADSTER 0.7 Brabus	M160.923	12/03 ⇒ 11/05

EPS 1.501.649

07,5

IGNITION CABLE SETS

Adatt./Suitable:

03 Supplied until depletion

- Fornibile fino ad esaurimento delle scorte
- Fourni jusqu'à épuisement du stock
- Lieferbar solange vorrat reicht
- Suministrado hasta el stock termina

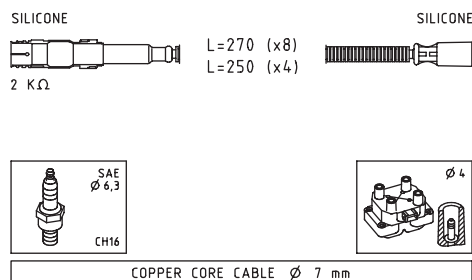

MERCEDES-BENZ

CLASSE C I C 240	M112.910	06/97 ⇒ 05/00
CLASSE C I C 240 T	M112.910, M112.915	09/00 ⇒ 03/01
CLASSE C I C 280	M112.920	06/97 ⇒ 05/00
CLASSE C I C 280 T	M112.920	06/97 ⇒ 03/01
CLASSE C II C 240	M112.912	05/00 ⇒ 08/07
CLASSE C II C 240 4-matic	M112.916	07/02 ⇒ 08/07
CLASSE C II C 32 AMG Kompressor	M112.961	02/01 ⇒ 08/07
CLASSE C II C 320	M112.946	05/00 ⇒ 05/08
CLASSE C II C 320 4-matic	M112.953	07/02 ⇒ 08/07
CLASSE CLK I 320	M112.940	06/97 ⇒ 06/02
CLASSE CLK II 240	M112.912	06/02 ⇒ 05/09
CLASSE CLK II 320	M112.955	06/02 ⇒ 05/09
CLASSE CLK II CLK 240	M112.912	02/03 ⇒ 03/10
CLASSE CLK II CLK 320	M112.955	02/03 ⇒ 03/10
CLASSE E II E 240	M112.911, M112.914	08/00 ⇒ 03/02
CLASSE E II E 240 T	M112.911, M112.914	08/00 ⇒ 03/03
CLASSE E II E 280	M112.921	12/96 ⇒ 03/02
CLASSE E II E 280 4-matic	M112.921	12/96 ⇒ 03/02
CLASSE E II E 280 T	M112.921	12/96 ⇒ 03/03
CLASSE E II E 280 T 4-matic	M112.921	12/96 ⇒ 03/03
CLASSE E II E 320	M112.941	06/97 ⇒ 03/02
CLASSE E II E 320 4-matic	M112.941	06/97 ⇒ 03/02
CLASSE E II E 320 T	M112.941	12/96 ⇒ 03/03
CLASSE E II E 320 T 4-matic	M112.941	12/96 ⇒ 03/03
CLASSE E III E 240	M112.913	03/02 ⇒ 12/08
CLASSE E III E 240 4-matic	M112.917	03/03 ⇒ 12/08
CLASSE E III E 240 T	M112.913	03/03 ⇒ 07/09
CLASSE E III E 240 T 4-matic	M112.917	07/03 ⇒ 07/09
CLASSE E III E 320	M112.949	03/02 ⇒ 12/08
CLASSE E III E 320 4-matic	M112.954	03/03 ⇒ 12/08
CLASSE E III E 320 T	M112.949	03/03 ⇒ 07/09
CLASSE E III E 320 T 4-matic	M112.954	07/03 ⇒ 07/09
CLASSE G II G 320	M112.945	06/97 ⇒ 11/97
CLASSE M I ML 320	M112.942	02/98 ⇒ 08/02
CLASSE M I ML 350	M112.970	08/02 ⇒ 06/05
CLASSE S IV S 280	M112.922	10/98 ⇒ 08/05
CLASSE S IV S 320	M112.944	10/98 ⇒ 08/05
CLASSE S IV S 350	M112.972	09/02 ⇒ 08/05
CLASSE S IV S 350 4-matic	M112.975	06/03 ⇒ 08/05
CLASSE SL IV 280	M112.923	05/98 ⇒ 10/01
CLASSE SL IV 320	M112.943	05/98 ⇒ 10/01
CLASSE SL V 350	M112.973	03/03 ⇒ 01/12
CLASSE SLK I 32 AMG Kompressor	M112.960	03/01 ⇒ 04/04
CLASSE SLK I 320	M112.947	03/00 ⇒ 04/04
VIANO 3.2	M112.951	09/03 ⇒
VIANO 3.7	M112.976	06/04 ⇒
VITO II 119	M112.951	09/03 ⇒
VITO II 122	M112.951	09/03 ⇒
VITO II 123	M112.976	06/04 ⇒ 07/08

EPS 1.501.654

07

IGNITION CABLE SETS

Adatt./Suitable:

00 Eliminated on 23-03-2021. Please verify the availability through our local distributors

- Eliminato il 23-03-2021. Verificare la disponibilità presso i nostri distributori
- Éliminé le 23-03-2021. Vérifier la disponibilité auprès de nos distributeurs sur place
- Am 23-03-2021 gestrichen. Evtl. Verfügbarkeit bitte bei unseren Händlern prüfen
- Eliminado en fecha 23-03-2021. Verificar la disponibilidad a través de nuestros distribuidores locales

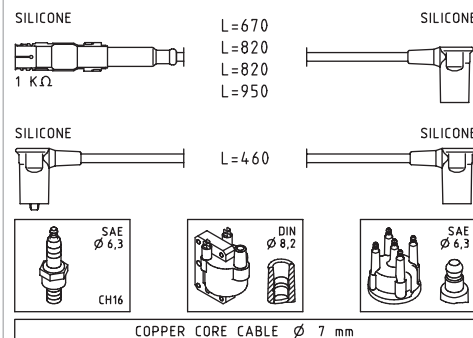

MERCEDES-BENZ

124 200 CE	M102.963	09/89 ⇒ 06/93
124 230 CE	M102.982	03/87 ⇒ 12/92
124 230 CE Cat	M102.982	06/89 ⇒ 12/92
190 2.0	M102.924	08/83 ⇒ 05/90
CLASSE G I 200 GE	M102.964	02/80 ⇒ 08/92
CLASSE G I 230 GE	M102.981, M102.987	04/82 ⇒ 08/92
CLASSE G II 230 GE	M102.981	04/92 ⇒
KOMBI II 200 T	M102.922	09/85 ⇒ 05/90
KOMBI II 200 TE	M102.963	09/88 ⇒ 08/92
KOMBI II 230 E Chassis	M102.982	09/86 ⇒ 06/93
KOMBI II 230 TE	M102.982	09/85 ⇒ 08/92
KOMBI II 230 TE Cat	M102.982	06/89 ⇒ 08/92
T1 210 2.3	M102.942, M102.945	04/77 ⇒ 02/96
T1 310 2.3	M102.942, M102.945	08/82 ⇒ 02/96
T1 410 2.3	M102.942, M102.945	08/82 ⇒ 06/95
T2/LN1 510	M102.946	04/86 ⇒ 12/94
TRE VOLUMI II 200	M102.922	12/85 ⇒ 10/92
TRE VOLUMI II 200 E	M102.963	09/88 ⇒ 08/93
TRE VOLUMI II 230 E	M102.982	12/84 ⇒ 06/93
TRE VOLUMI II 230 E Cat	M102.982	06/89 ⇒ 06/93

PUCH

G-MODELL 230 GE	M102.981, M102.987	03/79 ⇒ 12/91
-----------------	--------------------	---------------

EPS 1.501.657



07,5

IGNITION CABLE SETS

Adatt./Suitable:

00 Eliminated on 30-09-2019. Please verify the availability through our local distributors

- Eliminato il 30-09-2019. Verificare la disponibilità presso i nostri distributori
- Éliminé le 30-09-2019. Vérifier la disponibilité auprès de nos distributeurs sur place
- Am 30-09-2019 gestrichen. Evtl. Verfügbarkeit bitte bei unseren Händlern prüfen
- Eliminado en fecha 30-09-2019. Verificar la disponibilidad a través de nuestros distribuidores locales

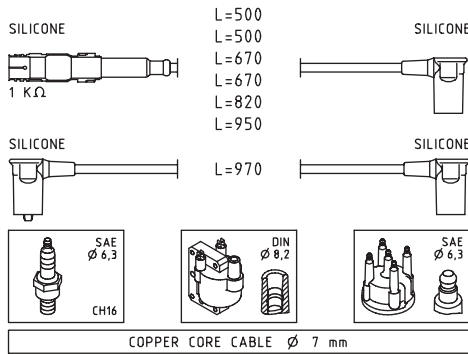

MERCEDES-BENZ

CLASSE E I E 300 4-matic	M103.985	06/93 ⇒ 06/95
CLASSE E I E 300 T 4-matic	M103.985	06/93 ⇒ 06/96
124 300 CE	M103.983	03/87 ⇒ 05/93
CLASSE G II 300 GE	M103.987	09/89 ⇒ 09/97
CLASSE SL III 300 SL	M103.982	09/85 ⇒ 08/89
CLASSE SL IV 300 SL	M103.984	03/89 ⇒ 08/93
KOMBI II 300 TE	M103.983	01/86 ⇒ 08/92
KOMBI II 300 TE 4-matic	M103.985	09/86 ⇒ 06/93
TRE VOLUMI II 260 E	M103.940	09/85 ⇒ 08/92
TRE VOLUMI II 260 E 4-matic	M103.943	09/86 ⇒ 08/92
TRE VOLUMI II 300 E	M103.983	08/85 ⇒ 08/92
TRE VOLUMI II 300 E 4-matic	M103.983, M103.985	09/86 ⇒ 06/93

PUCH

G-MODELL 300 GE	M103.987	06/89 ⇒ 08/93
-----------------	----------	---------------

EPS 1.501.658



08

IGNITION CABLE SETS

Adatt./Suitable:

BOSCH
0 986 357 239
NISSAN
22440-86J00
22440-86J10

00 Eliminated on 07-04-2021. Please verify the availability through our local distributors

- Eliminato il 07-04-2021. Verificare la disponibilità presso i nostri distributori
- Éliminé le 07-04-2021. Vérifier la disponibilité auprès de nos distributeurs sur place
- Am 07-04-2021 gestrichen. Evtl. Verfügbarkeit bitte bei unseren Händlern prüfen
- Eliminado en fecha 07-04-2021. Verificar la disponibilidad a través de nuestros distribuidores locales

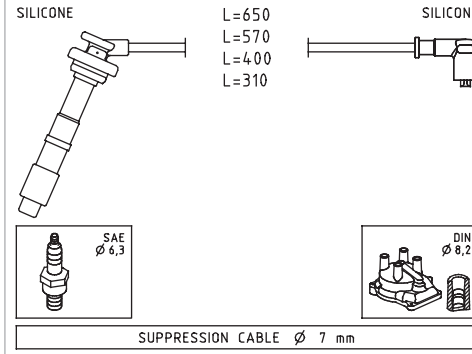

NISSAN

PRIMERA II 1.6 16V	GA16DE	09/96 ⇒ 07/02
PRIMERA I 1.6	GA16DE	06/93 ⇒ 01/96

EPS 1.501.660



07

IGNITION CABLE SETS

Adatt./Suitable:

03 Supplied until depletion

- Fornibile fino ad esaurimento delle scorte
- Fourni jusqu'à épuisement du stock
- Lieferbar solange vorrat reicht
- Suministrado hasta el stock termina

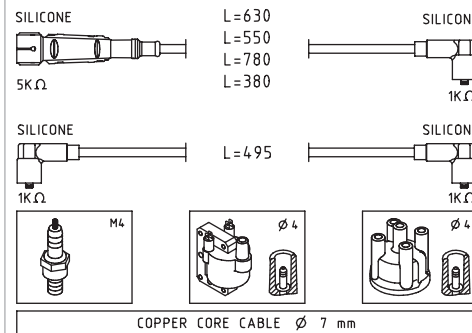

SEAT

INCA 1.4 i	AEX, AKV, APQ	11/95 ⇒ 06/03
INCA 1.6 i	AEE	06/97 ⇒ 09/00

VW

CADDY II 1.4	AEX, AKV, APQ	11/95 ⇒ 06/03
CADDY II 1.6	AEE	06/97 ⇒ 09/00
CADDY II 60 1.4	AEX, APQ	11/95 ⇒ 01/04
CADDY II 75 1.6	AEE	11/95 ⇒ 09/00
VENTO 1.4	APQ	12/97 ⇒ 05/98

EPS 1.501.667



07

IGNITION CABLE SETS

Adatt./Suitable:

00 Eliminated on 22-02-2022. Please verify the availability through our local distributors

- Eliminato il 22-02-2022. Verificare la disponibilità presso i nostri distributori
- Éliminé le 22-02-2022. Vérifier la disponibilité auprès de nos distributeurs sur place
- Am 22-02-2022 gestrichen. Evtl. Verfügbarkeit bitte bei unseren Händlern prüfen
- Eliminado en fecha 22-02-2022. Verificar la disponibilidad a través de nuestros distribuidores locales

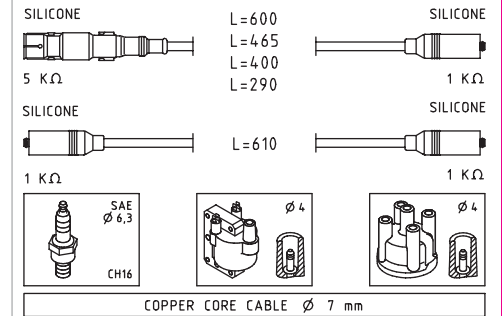

SEAT

ALHAMBRA I / II 2.0 i	ADY	04/96 ⇒ 03/10
-----------------------	-----	---------------

VW

SHARAN I 2.0	ADY	09/95 ⇒ 03/10
--------------	-----	---------------

EPS 1.501.671



07

IGNITION CABLE SETS

Adatt./Suitable:

00 Eliminated on 22-02-2022. Please verify the availability through our local distributors

- Eliminato il 22-02-2022. Verificare la disponibilità presso i nostri distributori
- Éliminé le 22-02-2022. Vérifier la disponibilité auprès de nos distributeurs sur place
- Am 22-02-2022 gestrichen. Evtl. Verfügbarkeit bitte bei unseren Händlern prüfen
- Eliminado en fecha 22-02-2022. Verificar la disponibilidad a través de nuestros distribuidores locales

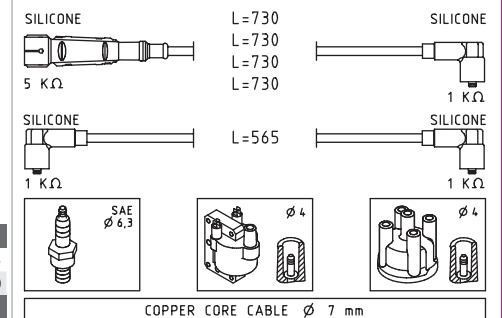

VW

JETTA II 1.3	MH, NU	01/84 ⇒ 12/87
JETTA II 1.3 Cat	MH, NZ	06/87 ⇒ 12/91
GOLF II 1.0	HZ	08/85 ⇒ 10/91
GOLF II 1.3	MH, NU	08/83 ⇒ 12/87
GOLF II 1.3 Cat	NZ	06/86 ⇒ 12/92
GOLF III 1.4	AEX	10/91 ⇒ 04/99
TRANSPORTER IV 1.8	5K7M710	12/90 ⇒ 07/92
TRANSPORTER IV 2.0	AAC	07/90 ⇒ 04/03

EPS 1.501.677



07,5

IGNITION CABLE SETS

Adatt./Suitable:

BOSCH
0 986 356 986

CHEVROLET
96190263
96460220

DAEWOO
96190263
96460220

GENERAL MOTORS
96 460 220

00 Eliminated on 22-02-2022. Please verify the availability through our local distributors

- Eliminato il 22-02-2022. Verificare la disponibilità presso i nostri distributori
- Éliminé le 22-02-2022. Vérifier la disponibilité auprès de nos distributeurs sur place
- Am 22-02-2022 gestrichen. Evtl. Verfügbarkeit bitte bei unseren Händlern prüfen
- Eliminado en fecha 22-02-2022. Verificar la disponibilidad a través de nuestros distribuidores locales

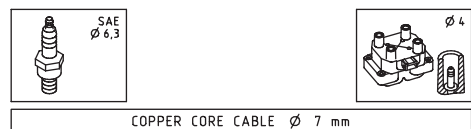
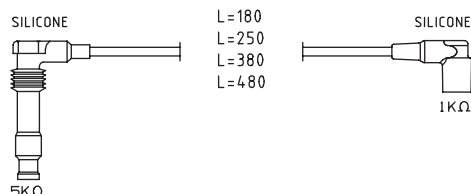

CHEVROLET

EPICA 2.0	T20SED	01/05 ⇒ 12/06
EVANDA 2.0	X20SED	03/05 ⇒ 12/06
LACETTI 1.8	T18SED	03/05 ⇒
LACETTI 2.0	U20SED	03/05 ⇒
LEGANZA 2.0	--	01/98 ⇒
LEGANZA 2.2	--	01/98 ⇒
NUBIRA 1.8	T18SED	03/05 ⇒ 12/09
OPTRA 1.8	T18SED	08/03 ⇒ 12/08
OPTRA 1.8 SRV	T18SED	06/06 ⇒
OPTRA 2.0	U20SED	06/99 ⇒
REZZO 2.0	T20SED	03/05 ⇒
TACUMA 2.0	X20SED	02/05 ⇒
VIVANT 2.0	X20SED	08/00 ⇒
VIVANT 2.0 CX	T20SED	01/05 ⇒

DAEWOO

EVANDA 2.0	L88, X20SED	08/02 ⇒
LACETTI 1.8	T18SED	02/04 ⇒
LEGANZA 2.0 16V	T20SED, X20SED	07/00 ⇒ 04/04
LEGANZA 2.2 16V	T22SED	04/99 ⇒ 12/02
NUBIRA I 2.0 16V	T20SED, X20SED, Z20L	12/00 ⇒
NUBIRA I 2.0 CDX	T20SED	08/02 ⇒ 07/03
NUBIRA II 1.8	T18SED	07/03 ⇒
REZZO 2.0	T20SED, X20SED	09/00 ⇒
TACUMA 2.0	X20SED	09/00 ⇒ 01/05

EPS 1.501.680



07

IGNITION CABLE SETS

Adatt./Suitable:

BOSCH
0 986 356 987

CHEVROLET
96211948
96497773

DAEWOO
96211948
96497773

GENERAL MOTORS
96 497 773

HITACHI
134236

MAGNETI MARELLI
941365030926

03 Supplied until depletion

- Fornibile fino ad esaurimento delle scorte
- Fourni jusqu'à épuisement du stock
- Lieferbar solange vorrat reicht
- Suministrado hasta el stock termina

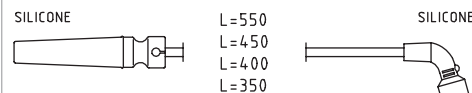

CHEVROLET

AVEO I 1.4	F14D3, L14	03/05 ⇒ 05/13
AVEO I 1.4 16V	F14D3	05/03 ⇒ 05/08
AVEO I 1.4 CNG	L95	01/10 ⇒
AVEO I 1.6	A16DMS, F16D3, LXT, LVX	09/03 ⇒
CRUZE 1.6	F16D3, LXT	05/09 ⇒
KALOS 1.4 16V	F14D3	03/05 ⇒
LANOS 1.6 16V	A16DMS	11/05 ⇒
REZZO 1.6	A16DMS	03/05 ⇒
TACUMA 1.6	A16DMS	02/05 ⇒
VIVANT 1.6	A16DMS	08/01 ⇒

DAEWOO

KALOS 1.4	F14D3	05/03 ⇒ 12/04
KALOS 1.4 16V	F14D3	04/03 ⇒
LANOS 1.6 16V	A16DMS	02/97 ⇒
NUBIRA I 1.6 16V	A16DMS	05/97 ⇒
REZZO 1.6	A16DMS	09/00 ⇒
TACUMA 1.6	A16DMS	09/00 ⇒ 01/05

EPS 1.501.681



07,5

IGNITION CABLE SETS

Adatt./Suitable:

MAGNETI MARELLI
941318111287

RENAULT
77 00 114 549

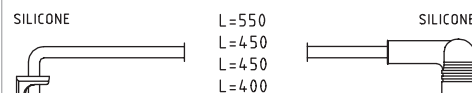

RENAULT

CLIO II 1.0	D7D760	02/00 ⇒ 05/01
CLIO II 1.2	D7F710, D7F720, D7F722, D7F726, D7F744, D7F746, D7F764, D7F766	03/98 ⇒

RENAULT

CLIO II 1.2 LPG	D7F722, D7F764, D7F766	09/98 ⇒ 06/09
KANGOO I 1.0	D7D700, D7D760	09/98 ⇒
KANGOO I 1.2	D7F710, D7F720, D7F722, D7F726, D7F744, D7F746	08/97 ⇒
TWINGO I 1.0	D7D740	01/00 ⇒
TWINGO I 1.2	D7F700, D7F701, D7F702, D7F703, D7F704, D7F706	05/96 ⇒

EPS 1.501.682



07

IGNITION CABLE SETS

Adatt./Suitable:

00 Eliminated on 22-02-2022. Please verify the availability through our local distributors

- Eliminato il 22-02-2022. Verificare la disponibilità presso i nostri distributori
- Éliminé le 22-02-2022. Vérifier la disponibilité auprès de nos distributeurs sur place
- Am 22-02-2022 gestrichen. Evtl. Verfügbarkeit bitte bei unseren Händlern prüfen
- Eliminado en fecha 22-02-2022. Verificar la disponibilidad a través de nuestros distribuidores locales

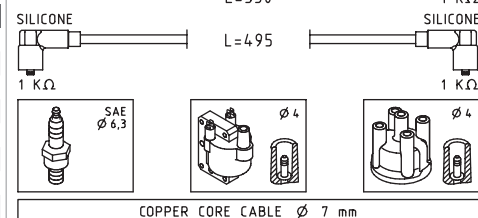
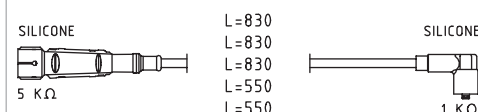

AUDI

80 II 2.0	HP, JS	10/83 ⇒ 09/84
80 II 2.0 quattro	JS	10/83 ⇒ 09/84
80 IV 2.3 E	NG	09/91 ⇒ 01/96
80 IV 2.3 E quattro	NG	09/91 ⇒ 12/94
90 I 2.0	HP, JL, JS, SK	10/84 ⇒ 03/87
90 I 2.0 quattro	JS	08/84 ⇒ 08/86
90 I 2.2	9C54, HY	10/84 ⇒ 03/87
90 I 2.2 E quattro	9C54	11/84 ⇒ 03/87
90 II 2.0	PS	07/88 ⇒ 09/91
90 II 2.2 E	9C54	04/87 ⇒ 07/91
90 II 2.2 E quattro	9C54	04/87 ⇒ 09/91
90 II 2.3 E	NG	04/87 ⇒ 09/91
90 II 2.3 E quattro	NG	04/87 ⇒ 09/91
100 III 2.0	KP	08/84 ⇒ 12/87
100 III 2.0 Cat	RT	01/88 ⇒ 11/90
100 III 2.0 E Cat	RT	01/88 ⇒ 11/90
100 III 2.2 Cat	KU	06/89 ⇒ 11/90
100 III 2.2 Cat quattro	KU	06/89 ⇒ 11/90
100 III 2.2 E Turbo quattro	MC	08/86 ⇒ 11/90
100 III 2.2 Turbo	MC	08/86 ⇒ 11/90
100 III 2.2 Turbo quattro	MC	08/86 ⇒ 11/90
100 III 2.3	NF	08/86 ⇒ 11/90
100 III 2.3 E	NF	10/86 ⇒ 11/90
100 III 2.3 E quattro	NF	08/86 ⇒ 11/90
100 III 2.3 quattro	NF	01/90 ⇒ 11/90
100 IV 2.3 E	7M15A-FKS	12/90 ⇒ 07/94
100 IV 2.3 E quattro	7M15A-FKS	12/90 ⇒ 07/94
A6 I 2.3	7M15A-FKS	06/94 ⇒ 12/95
CABRIOLET 2.3 E	NG	05/91 ⇒ 07/94
COUPE 2.2	9C54	11/88 ⇒ 07/91
COUPE 2.2 quattro	9C54	11/88 ⇒ 07/91
COUPE 2.3	NG	10/88 ⇒ 12/96
COUPE 2.3 quattro	NG	11/88 ⇒ 12/96

EPS 1.501.686



07

IGNITION CABLE SETS

Adatt./Suitable:

BOSCH
0 986 356 721
HONDA
32700-P1J-E01

00 Eliminated on 22-02-2022. Please verify the availability through our local distributors

- Eliminato il 22-02-2022. Verificare la disponibilità presso i nostri distributori
- Éliminé le 22-02-2022. Vérifier la disponibilité auprès de nos distributeurs sur place
- Am 22-02-2022 gestrichen. Evtl. Verfügbarkeit bitte bei unseren Händlern prüfen
- Eliminado en fecha 22-02-2022. Verificar la disponibilidad a través de nuestros distribuidores locales

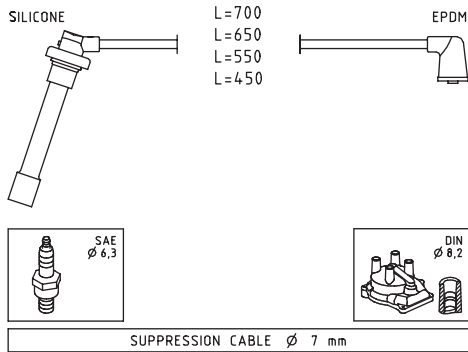

HONDA

CIVICVI 1.4 16V	D14A7, D14A8	01/97 ⇨ 02/01
CIVICVI 1.4 i	D14A8	06/95 ⇨ 02/01
CIVICVI 1.4i	D14A6	01/99 ⇨
CIVICVI 1.4i 16V	D14Z3, D14Z4	11/98 ⇨ 12/00
CIVICVI 1.4i 16V Vtec	D14Z4	01/99 ⇨
CIVICVI 1.5 16V	D15Z8	01/97 ⇨ 02/01
CIVICVI 1.6	D16W4	11/98 ⇨ 03/01
CIVICVI 1.6 16V	D16B2	01/97 ⇨ 02/01
CIVICVI 1.6i 16V	D16W3	11/98 ⇨ 12/00

EPS 1.501.691



07

IGNITION CABLE SETS

Adatt./Suitable:

03 Supplied until depletion

- Fornibile fino ad esaurimento delle scorte
- Fourni jusqu'à épuisement du stock
- Lieferbar solange vorrat reicht
- Suministrado hasta el stock termina

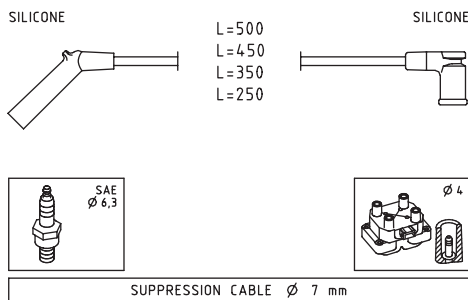

FORD

IKON 1.3 Rocam	--	10/00 ⇨
IKON 1.6 EFI Rocam	--	11/99 ⇨

FORD (BR)

FIESTA 1.0i	ZL10	07/99 ⇨
FIESTA 1.6i	ZL16	07/99 ⇨

EPS 1.501.699



07

IGNITION CABLE SETS

Adatt./Suitable:

BOSCH
0 986 356 721
HONDA
32700-PEL-004

03 Supplied until depletion

- Fornibile fino ad esaurimento delle scorte
- Fourni jusqu'à épuisement du stock
- Lieferbar solange vorrat reicht
- Suministrado hasta el stock termina

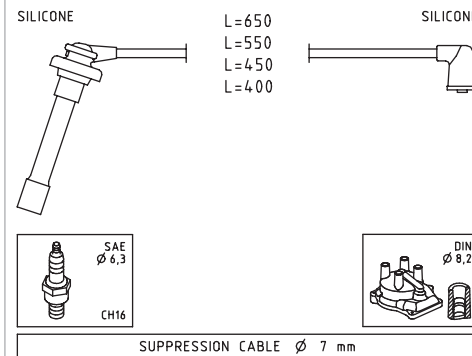

HONDA

HR-V 1.6 16V	350Y	03/99 ⇨
HR-V 1.6 16V 4WD	350Y, D16W5	03/99 ⇨
HR-V 1.6i 16V	D16W2	04/99 ⇨

EPS 1.501.702



07

IGNITION CABLE SETS

Adatt./Suitable:

BOSCH
0 986 356 721

03 Supplied until depletion

- Fornibile fino ad esaurimento delle scorte
- Fourni jusqu'à épuisement du stock
- Lieferbar solange vorrat reicht
- Suministrado hasta el stock termina

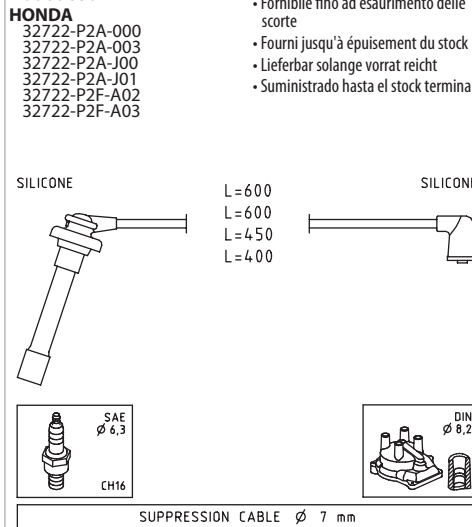

HONDA

BALLADE 1.5	D15Z4	01/97 ⇨
BALLADE 1.6i	D16Y9	01/96 ⇨ 02/01
CIVIC VI 1.4	D14A4	11/95 ⇨ 10/98
CIVIC VI 1.4 i	D14A3, D14A4, D14Z1, D14Z2	11/95 ⇨ 02/01
CIVIC VI 1.4 i S	D14A4, D14Z2	11/95 ⇨ 02/01
CIVIC VI 1.4i 16V	D14Z1	11/98 ⇨ 03/01
CIVIC VI 1.5 i	D15Z6	11/95 ⇨ 02/01
CIVIC VI 1.6	--	05/96 ⇨ 04/99
CIVIC VI 1.6 i	D16Y5	11/95 ⇨ 02/01
CIVIC VI 1.6 i Vtec	D16Y6, D16Y8	11/95 ⇨ 02/01
CIVIC VI 1.6 VTi	B16A2	11/95 ⇨ 02/01
CIVIC VI 1.6i 16V	D16Y7	01/96 ⇨
CIVIC VI 1.6i 16V Vtec	D16Y8	01/96 ⇨ 09/99
CIVIC V 1.6 i	D16Y7	01/94 ⇨ 11/95
CIVIC V 1.6i Vtec	D16Y6	01/94 ⇨ 03/96

EPS 1.501.709



07

IGNITION CABLE SETS

Adatt./Suitable:

BOSCH
0 986 357 150
HONDA
32700-PHK-003
32722-P75-A01

00 Eliminated on 24-05-2021. Please verify the availability through our local distributors

- Eliminato il 24-05-2021. Verificare la disponibilità presso i nostri distributori
- Éliminé le 24-05-2021. Vérifier la disponibilité auprès de nos distributeurs sur place
- Am 24-05-2021 gestrichen. Evtl. Verfügbarkeit bitte bei unseren Händlern prüfen
- Eliminado en fecha 24-05-2021. Verificar la disponibilidad a través de nuestros distribuidores locales

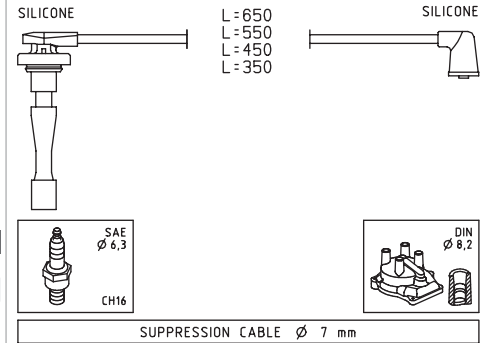

HONDA

BALLADE 1.8 i	B18B4	01/96 ⇨ 02/01
CR-V I 2.0	B20Z1	04/99 ⇨ 02/02
CR-V I 2.0 16V 4WD	B20B, B20Z1	10/95 ⇨ 02/02
CR-V I 2.0 i 16V	B20B3, B20B4, B20B9, B20Z3	02/97 ⇨ 04/99
INTEGRA 1.8 i	B18B1	01/98 ⇨

EPS 1.501.711



07,5

IGNITION CABLE SETS

Adatt./Suitable:

BOSCH
0 986 356 776
0 986 AM0 039

HONDA

32700-POD-000
32700-P0K-G00
32700-P5K-003
32700-P5N-G01
32700-PT0-000
32700-PT0-G00
32701-P14-A00
32701-PT0-000
32702-P14-A00
32702-PT0-000
32703-P14-A00
32703-PT0-000
32704-P14-A00
32704-PT0-000
32722-PT3-A00

MAGNETI MARELLI
941315020889

ROVER
GHT274

- 03 Supplied until depletion**
- Fornibile fino ad esaurimento delle scorte
 - Fourni jusqu'à épuisement du stock
 - Lieferbar solange vorrat reicht
 - Suministrado hasta el stock termina

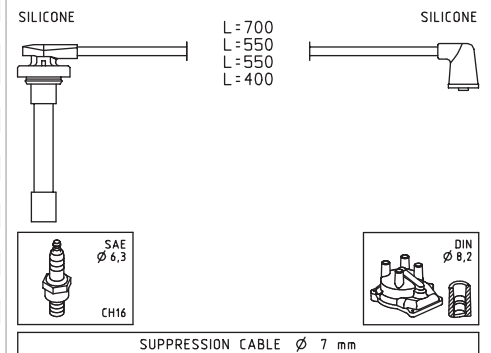

HONDA

ACCORD IV 1.8	--	01/90 ⇨ 12/91
ACCORD IV 2.0 16V	F20A2, F20A3, F20A5, F20A6	01/90 ⇨ 12/93
ACCORD IV 2.0 i 16V	F20A4, F20A7, F20A8, F20Z3	01/90 ⇨ 12/93

1.501.719

HONDA			
ACCORD IV 2.2	F22A6	05/92 ⇒ 12/93	
ACCORD IV 2.2 i 16V	F22A3, F22A7, F22A8	01/90 ⇒ 12/93	
ACCORD IV 2.2 i 16V Automatik	F22A3	01/90 ⇒ 03/93	
ACCORD V 1.8 16V	F18A3	01/94 ⇒ 12/95	
ACCORD V 1.9 i	F18A3	02/96 ⇒ 10/98	
ACCORD V 2.0	F20B3	09/93 ⇒ 12/97	
ACCORD V 2.0 i	F20Z2	03/93 ⇒ 01/96	
ACCORD V 2.0 i LS	F20Z1	02/96 ⇒ 10/98	
ACCORD V 2.0 i LS 16V	F20B3	09/93 ⇒ 02/98	
ACCORD V 2.0 i S	F20Z1	03/93 ⇒ 01/96	
ACCORD V 2.2 16V	F22Z1	01/96 ⇒ 09/98	
ACCORD V 2.2 i [USA]	--	01/94 ⇒ 12/95	
ACCORD V 2.2 i 16V	F22B4	08/95 ⇒ 12/97	
ACCORD V 2.2 i ES	F22B5	09/93 ⇒ 02/98	
ODYSSEY 2.2	F22B6	01/95 ⇒ 12/97	
PRELUDE IV 2.0 i 16V	F20A4	02/92 ⇒ 09/96	
PRELUDE V 2.0 16V	F20A4	10/96 ⇒ 10/00	
PRELUDE V 2.2 i 16V	F22A2	10/96 ⇒ 10/01	
SHUTTLE 2.2 16V	F22B8	10/94 ⇒ 02/98	
ROVER			
600 618 i/Si	F18A3	03/96 ⇒ 02/99	
600 620 i	F20Z2	08/93 ⇒ 06/96	
600 620 Si	F20Z1	08/93 ⇒ 02/99	

EPS 1.501.719

IGNITION CABLE SETS

Adatt./Suitable:

MINI
82 11 0 393 996
82 11 0 404 488

⁰³ Supplied until depletion

- Fornibile fino ad esaurimento delle scorte
- Fourni jusqu'à épuisement du stock
- Lieferbar solange vorrat reicht
- Suministrado hasta el stock termina

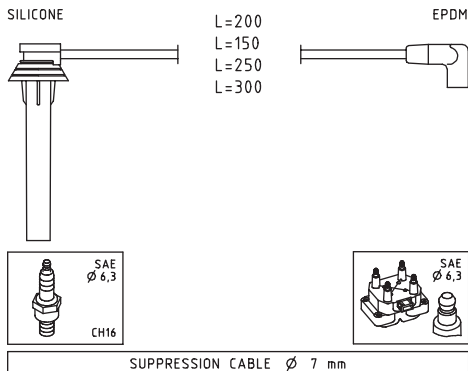

CHRYSLER

NEON II 1.6	EJD	11/01 ⇒ 12/06
PT CRUISER 1.6	EJD	11/01 ⇒ 12/10
MINI		
MINI I Cooper	W10B16A	06/01 ⇒ 07/08
MINI I Cooper S	W11B16A	03/02 ⇒ 11/07
MINI I John Cooper Works	W11B16A	07/04 ⇒ 11/07
MINI I One	W10B14A, W10B16A	06/01 ⇒ 11/07
MINI I Works	W11B16A	11/03 ⇒ 09/06

EPS 1.501.723

IGNITION CABLE SETS

Adatt./Suitable:

⁰³ Supplied until depletion

- Fornibile fino ad esaurimento delle scorte
- Fourni jusqu'à épuisement du stock
- Lieferbar solange vorrat reicht
- Suministrado hasta el stock termina

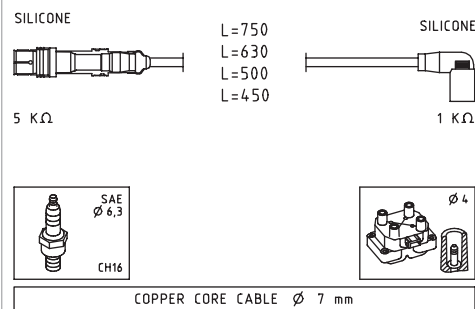

SEAT

IBIZA III 1.6	BAH	02/03 ⇒ 11/09
CORDOBA II 1.6	BAH	04/03 ⇒ 11/09

VOLKSWAGEN (BR)

POLO 1.6	BAH, BPA, CCRA	02/02 ⇒
----------	----------------	---------

VW

FOX 1.0	--, AQZ, BNX, CCNA	10/03 ⇒
FOX 1.0 Alcohol	BJE, BNX	10/03 ⇒
FOX 1.0 Total Flex	CCNA	03/08 ⇒
FOX 1.4	BKR	04/05 ⇒ 12/09
FOX 1.6	BAH, BLH, BPA, CCRA, CFZA	10/03 ⇒ 08/14
FOX 1.6 Alcohol	--	10/03 ⇒
FOX 1.6 Total Flex	BJA, BPA, CCRA	10/03 ⇒ 08/14
POLO IV 1.4	BLM	08/02 ⇒ 08/10
POLO IV 1.6	BAH, BPA	08/02 ⇒
POLO IV 1.6 Flex	BPA	12/04 ⇒ 10/14
POLO IV 1.6 Total Flex	BPA	10/04 ⇒ 06/06
SPACEFOX / SPACE CROSS 1.6	BAH, BLH	03/06 ⇒
SPACEFOX / SPACE CROSS 1.6 FSI	BPA, CCRA, CFZA	03/06 ⇒
SPACEFOX / SPACE CROSS 1.6 Total Flex	BPA, CCRA, CFZA	03/06 ⇒

EPS 1.501.729

IGNITION CABLE SETS

Adatt./Suitable:

BOSCH
0 986 357 266
HITACHI
134953
MAZDA
ZL01-18-140A

⁰⁰ Eliminated on 07-06-2021. Please verify the availability through our local distributors

- Eliminato il 07-06-2021. Verificare la disponibilità presso i nostri distributori
- Éliminé le 07-06-2021. Vérifier la disponibilité auprès de nos distributeurs sur place
- Am 07-06-2021 gestrichen. Evtl. Verfügbarkeit bitte bei unseren Händlern prüfen
- Eliminado en fecha 07-06-2021. Verificar la disponibilidad a través de nuestros distribuidores locales

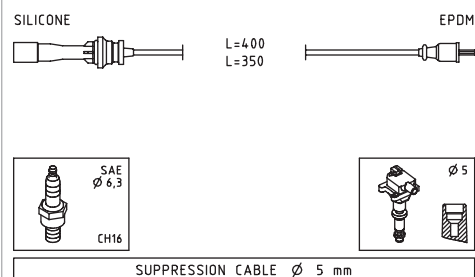

MAZDA

323 VIII F 1.5 16V	ZL05, ZL06	09/98 ⇒ 01/01
323 VIII F 1.6	ZM	01/01 ⇒ 05/04
323 VIII S 1.5 16V	ZL05, ZL06	09/98 ⇒ 01/01
323 VIII S 1.6	ZM	01/01 ⇒ 05/04
PROTEGE 1.6i [USA]	--	06/98 ⇒

EPS 1.501.730

IGNITION CABLE SETS

Adatt./Suitable:

CHEVROLET
96342284
DAEWOO
96342284
GENERAL MOTORS
96 342 284

⁰³ Supplied until depletion

- Fornibile fino ad esaurimento delle scorte
- Fourni jusqu'à épuisement du stock
- Lieferbar solange vorrat reicht
- Suministrado hasta el stock termina

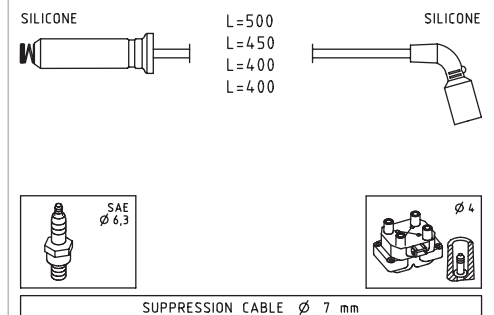

CHEVROLET

VIVANT 1.8	F18S2	05/00 ⇒
------------	-------	---------

DAEWOO

REZZO 1.8	--, A18DMS, F18D2	09/00 ⇒
TACUMA 1.8	F18S2	09/00 ⇒

EPS 1.501.731

IGNITION CABLE SETS

Adatt./Suitable:

BOSCH
0 986 356 980
CHEVROLET
96305387
DAEWOO
96305387
HITACHI
134239

⁰³ Supplied until depletion

- Fornibile fino ad esaurimento delle scorte
- Fourni jusqu'à épuisement du stock
- Lieferbar solange vorrat reicht
- Suministrado hasta el stock termina

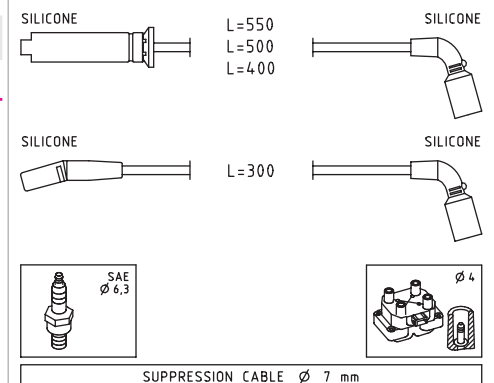

CHEVROLET

AVEO I 1.4	F14S3	03/05 ⇒
AVEO I 1.5	F15S3	01/05 ⇒
LANOS 1.3	--	01/97 ⇒
LANOS 1.5	A15SMS	11/05 ⇒

DAEWOO

KALOS 1.4	F14S3	09/02 ⇒
LANOS 1.3	A14SMS	05/97 ⇒
LANOS 1.5	A15SMS	05/97 ⇒

EPS 1.501.732



07,5

IGNITION CABLE SETS

Adatt./Suitable:

BOSCH
0 986 357 277**DAIHATSU**
19901-87186-000
19901-87196-000
90048-66019-000**03 Supplied until depletion**

- Fornibile fino ad esaurimento delle scorte
- Fourni jusqu'à épuisement du stock
- Lieferbar solange vorrat reicht
- Suministrado hasta el stock termina

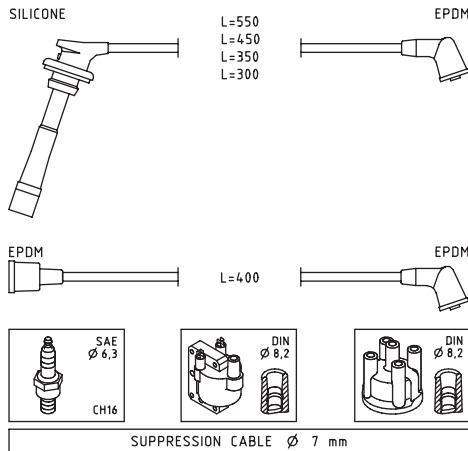
**DAIHATSU**

FEROZA 1.6 16V	HD-C	10/88 \Rightarrow 12/99
FEROZA 1.6 16V 4x4	HD-C	10/88 \Rightarrow 12/99
FEROZA 1.6 i 16V	HD-E	10/88 \Rightarrow 12/99
FEROZA 1.6 i 16V 4x4	HD-E	10/88 \Rightarrow 12/99
FEROZA 1.6i	--	01/90 \Rightarrow
ROCKY 2.0i [USA]	--	01/89 \Rightarrow
SPORTRACK 1.6 16v 4x4	HD-C	10/88 \Rightarrow 08/93

EPS 1.501.738



07,5

IGNITION CABLE SETS

Adatt./Suitable:

BOSCH
0 986 357 149**HITACHI**
134298**MAZDA**
Z501-18-140
Z501-18-140A**00 Eliminated on 22-02-2022. Please verify the availability through our local distributors**

- Eliminato il 22-02-2022. Verificare la disponibilità presso i nostri distributori
- Éliminé le 22-02-2022. Vérifier la disponibilité auprès de nos distributeurs sur place
- Am 22-02-2022 gestrichen. Evtl. Verfügbarkeit bitte bei unseren Händlern prüfen
- Eliminado en fecha 22-02-2022. Verificar la disponibilidad a través de nuestros distribuidores locales

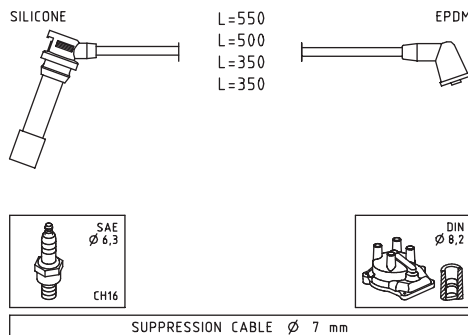
**MAZDA**

323 VII C 1.5 16V	Z5-DE	08/94 \Rightarrow 09/98
323 VII 1.5 16V	Z5-DE	07/94 \Rightarrow 09/98
323 VII P 1.5 16V	Z5-DE	10/96 \Rightarrow 09/98
323 VIII S 1.5 16V	Z5-DE	08/94 \Rightarrow 09/98

EPS 1.501.739



08

IGNITION CABLE SETS

Adatt./Suitable:

HITACHI
134273**MAZDA**
FSD7-18-140B**03 Supplied until depletion**

- Fornibile fino ad esaurimento delle scorte
- Fourni jusqu'à épuisement du stock
- Lieferbar solange vorrat reicht
- Suministrado hasta el stock termina

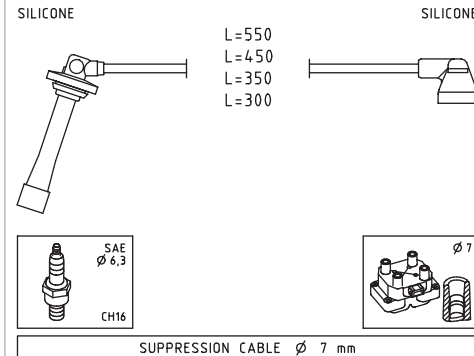
**MAZDA**

626 VI 1.8	FP, FP9A, FPY3	05/97 \Rightarrow 10/02
626 VI 2.0	FS, FS2C	05/97 \Rightarrow 10/02
626 VI 2.0 H.P.	FS2C	02/98 \Rightarrow 10/02

EPS 1.501.740



07,5

IGNITION CABLE SETS

Adatt./Suitable:

MAZDAFP39-18-140
FP39-18-140A**03 Supplied until depletion**

- Fornibile fino ad esaurimento delle scorte
- Fourni jusqu'à épuisement du stock
- Lieferbar solange vorrat reicht
- Suministrado hasta el stock termina

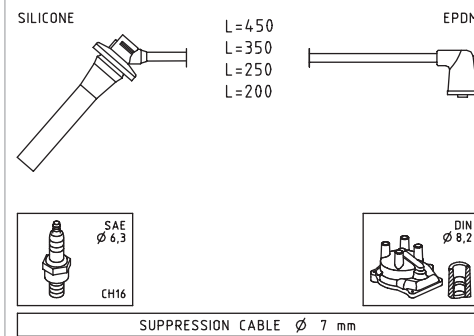
**MAZDA**

323 VIII F 1.9 16V	FP, FP55	09/98 \Rightarrow 01/01
323 VIII S 1.9 16V	FP, FP55	09/98 \Rightarrow 05/04
PROTEGE 1.8i [USA]	--	06/98 \Rightarrow

EPS 1.501.741



07

IGNITION CABLE SETS

Adatt./Suitable:

BOSCH
0 986 357 195**MAZDA**
B33G-18-140A
B33G-18-140B**00 Eliminated on 25-11-2020. Please verify the availability through our local distributors**

- Eliminato il 25-11-2020. Verificare la disponibilità presso i nostri distributori
- Éliminé le 25-11-2020. Vérifier la disponibilité auprès de nos distributeurs sur place
- Am 25-11-2020 gestrichen. Evtl. Verfügbarkeit bitte bei unseren Händlern prüfen
- Eliminado en fecha 25-11-2020. Verificar la disponibilidad a través de nuestros distribuidores locales

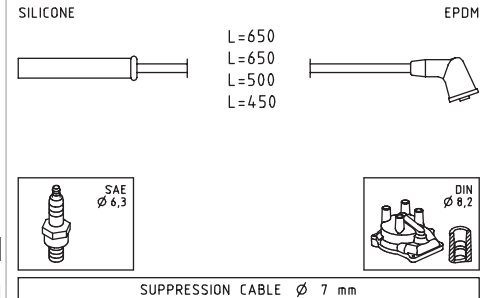
**MAZDA**

323 VIII F 1.4	B3(16V)	01/01 \Rightarrow 05/04
323 VIII F 1.4 16V	B3ME	09/98 \Rightarrow 01/01
323 VIII S 1.3	B3(16V)	01/01 \Rightarrow 05/04
323 VIII S 1.3 16V	B3ME	09/98 \Rightarrow 01/01

EPS 1.501.745



07,5

IGNITION CABLE SETS

Adatt./Suitable:

BOSCH
0 986 356 742**HITACHI**
134286**MAZDA**
B61P-18-140C
B6MC-18-140B
BPE8-18-140
BPE8-18-140A**03 Supplied until depletion**

- Fornibile fino ad esaurimento delle scorte
- Fourni jusqu'à épuisement du stock
- Lieferbar solange vorrat reicht
- Suministrado hasta el stock termina

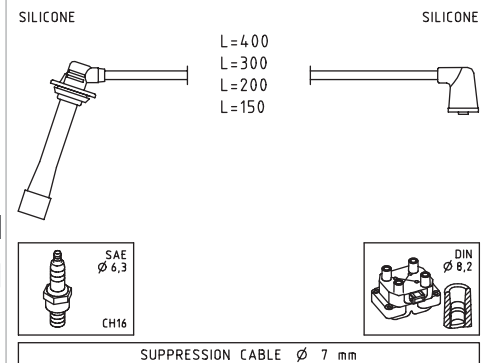
**MAZDA**

MIATA 1.6i 16v	CE16I	03/90 \Rightarrow 08/93
MIATA 1.6i 16v GT	CE16T	11/90 \Rightarrow 08/93
MIATA 1.8i [USA]	--	01/94 \Rightarrow
MX-5 I 1.6	8AN1, B64F	05/90 \Rightarrow 04/98
MX-5 I 1.8	BPF1	01/93 \Rightarrow 04/98
MX-5 II 1.6 16V	B6D	05/98 \Rightarrow 10/05
MX-5 II 1.8	BP6I, BPD	08/02 \Rightarrow 10/05
MX-5 II 1.8 16V	BPD, BP-ZE	11/00 \Rightarrow 10/05

1.501.753

EPS 1.501.753

07

IGNITION CABLE SETS

Adatt./Suitable:

BOSCH

0 986 357 157

MAGNETI MARELLI

941285120871

MITSUBISHI

MD332343

⁰³ Supplied until depletion

- Fornibile fino ad esaurimento delle scorte
- Fourni jusqu'à épuisement du stock
- Lieferbar solange vorrat reicht
- Suministrado hasta el stock termina

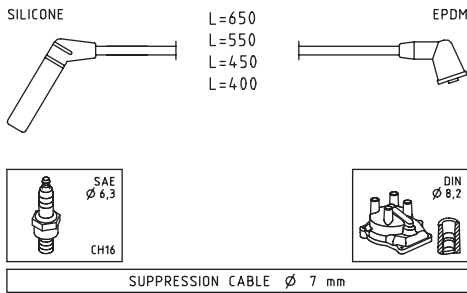

MITSUBISHI

COLT V 1.5	301353C	09/95 ⇒ 09/03
COLT V 1.5 16V	301353C	10/99 ⇒ 09/03
COLT V 1300 GL, GLX	4G13(12V)	05/96 ⇒ 06/00
LANCER VII 1.3 12V	4G13(12V)	12/95 ⇒ 08/03
LANCER VII 1.5	301353C	06/00 ⇒ 08/03
LANCER VII 1.5 16V	301353C	10/99 ⇒ 08/03

EPS 1.501.760

09

IGNITION CABLE SETS

Adatt./Suitable:

BOSCH

0 986 356 966

MAZDA

0000-18-135A

88GP-18-140

88GP-18-140A

88GP-18-140B

88GP-18-140C

K834-18-140A

KF33-18-140C

KF33-18-140D

KF33-18-140E

KL01-18-140C

KL47-18-140B

KL47-18-140C

⁰⁰ Eliminated on 22-02-2022. Please verify the availability through our local distributors

- Eliminato il 22-02-2022. Verificare la disponibilità presso i nostri distributori
- Éliminé le 22-02-2022. Vérifier la disponibilité auprès de nos distributeurs sur place
- Am 22-02-2022 gestrichen. Evtl. Verfügbarkeit bitte bei unseren Händlern prüfen
- Eliminado en fecha 22-02-2022. Verificar la disponibilidad a través de nuestros distribuidores locales

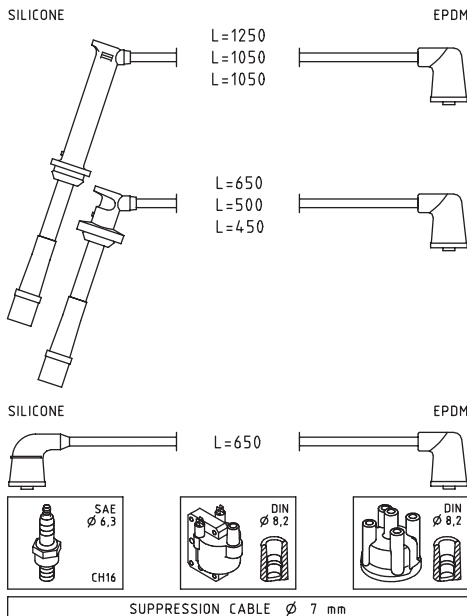

MAZDA

323 VII 2.0 24V	KF	08/94 ⇒ 09/98
626 V 2.5 24V	KL	01/92 ⇒ 04/97
MX-3 1.8 iV6	K838, K8-ZE	01/94 ⇒ 10/97
MX-6 2.5 24V	KL	02/92 ⇒ 09/97
MX-6 2.5 i 24V	KL	08/94 ⇒ 02/97
XED05 6 2.0 V6	KF1	01/92 ⇒ 10/99

MAZDA

XED05 9 2.0	KF	08/98 ⇒ 08/00
XED05 9 2.0 24V	KF	08/93 ⇒ 01/00
XED05 9 2.5 24V	KL	07/93 ⇒ 07/00

EPS 1.501.764

07

IGNITION CABLE SETS

Adatt./Suitable:

CHRYSLER

MD338 624

HITACHI

134613

MITSUBISHI

MD334043

MD336862

MD338624

⁰⁰ Eliminated on 07-06-2021. Please verify the availability through our local distributors

- Eliminato il 07-06-2021. Verificare la disponibilità presso i nostri distributori
- Éliminé le 07-06-2021. Vérifier la disponibilité auprès de nos distributeurs sur place
- Am 07-06-2021 gestrichen. Evtl. Verfügbarkeit bitte bei unseren Händlern prüfen
- Eliminado en fecha 07-06-2021. Verificar la disponibilidad a través de nuestros distribuidores locales

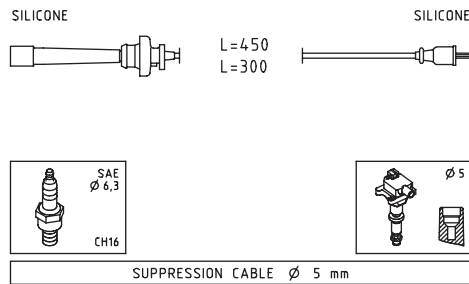

CHRYSLER

SEBRING II 2.4	EDZ, EY7	10/00 ⇒
MITSUBISHI		
CARISMA 1.6	4G92(SOHC16V)	09/00 ⇒ 06/06
CARISMA 1.8	4G93(SOHC16V)	07/95 ⇒ 09/97
COLT V 1600	4G92(SOHC16V)	09/00 ⇒ 09/03
COLT V 1600 GLX	4G92(SOHC16V)	05/96 ⇒ 09/00
GRANDIS 2.0	4G63(SOHC8V)	04/04 ⇒
SPACE WAGON 2.0 16V	4G63(DOHC16V)	06/00 ⇒
SPACE WAGON 2.4 GDI	4G64(GDI)	07/98 ⇒
SPACE WAGON 2.4 GDI GLX	4G64(GDI)	08/00 ⇒ 05/03
GALANT VIII 2.0	4G63(SOHC16V)	09/00 ⇒ 10/04
LANCER VII 1.6 16V	4G92(SOHC16V)	12/95 ⇒ 08/03
MONTERO IO 1.8 GDI	4G93(SOHC16V)	08/99 ⇒
PAJERO PININ 1.8	4G93(SOHC16V)	11/01 ⇒ 06/07
PAJERO PININ 1.8 GDI	4G93(GDI)	10/99 ⇒ 10/01
SPACE RUNNER 2.0	→, 4G63(SOHC16V)	01/92 ⇒ 08/02
SPACE STAR 1.8 GDI	4G93(GDI)	06/98 ⇒ 12/04
SPACE STAR 1.8 MPI	4G93(DOHC16V)	10/02 ⇒ 12/04

EPS 1.501.767

07

IGNITION CABLE SETS

Adatt./Suitable:

⁰³ Supplied until depletion

- Fornibile fino ad esaurimento delle scorte
- Fourni jusqu'à épuisement du stock
- Lieferbar solange vorrat reicht
- Suministrado hasta el stock termina

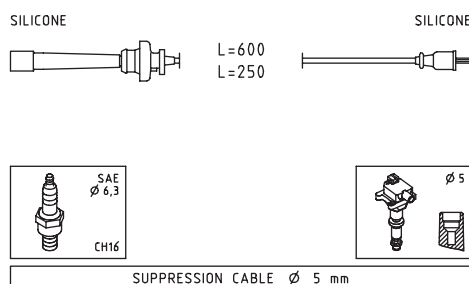

MAZDA

323 VIII F 1.8 Astina	BP(DOHC)	09/98 ⇒ 05/04
323 VIII F 2.0	FS, FS7E, FS7G	02/00 ⇒ 09/04
323 VIII S 1.8 Protege	BP(DOHC)	05/98 ⇒ 05/04

MAZDA

323 VIII S 2.0	FS, FS7E, FS7G	02/00 ⇒ 05/04
MPV II 2.0	FS-DS	09/99 ⇒ 08/00
PREMACY 1.9	FP	07/99 ⇒ 03/05

EPS 1.501.789

07

IGNITION CABLE SETS

Adatt./Suitable:

FORD

1 960 394

1 961 207

NISSAN

22440-1S700

22440-1S710

22440-8B000

⁰⁰ Eliminated on 27-09-2021. Please verify the availability through our local distributors

- Eliminato il 27-09-2021. Verificare la disponibilità presso i nostri distributori
- Éliminé le 27-09-2021. Vérifier la disponibilité auprès de nos distributeurs sur place
- Am 27-09-2021 gestrichen. Evtl. Verfügbarkeit bitte bei unseren Händlern prüfen
- Eliminado en fecha 27-09-2021. Verificar la disponibilidad a través de nuestros distribuidores locales

⁰³ Supplied until depletion

- Fornibile fino ad esaurimento delle scorte
- Fourni jusqu'à épuisement du stock
- Lieferbar solange vorrat reicht
- Suministrado hasta el stock termina

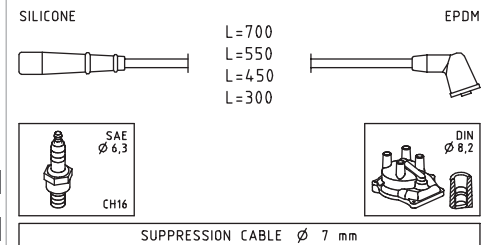

FORD

MAVERICK 2.4 i	KA24	09/96 ⇒ 04/98
NISSAN		
PICK UP II 2.4 i	KA24E	02/98 ⇒ 04/05
PICK UP II 2.4 i 4WD	KA24E	02/98 ⇒ 04/05
TERRANO II 2.4 4WD	KA24E	05/96 ⇒ 09/07
TERRANO II 2.4 i 12V 4WD	KA24E	02/93 ⇒ 12/97

EPS 1.501.792



07,5

IGNITION CABLE SETS

Adatt./Suitable:

TOYOTA
90919-22387

00 Eliminated on 22-02-2022. Please verify the availability through our local distributors

- Eliminato il 22-02-2022. Verificare la disponibilità presso i nostri distributori
- Éliminé le 22-02-2022. Vérifier la disponibilité auprès de nos distributeurs sur place
- Am 22-02-2022 gestrichen. Evtl. Verfügbarkeit bitte bei unseren Händlern prüfen
- Eliminado en fecha 22-02-2022. Verificar la disponibilidad a través de nuestros distribuidores locales

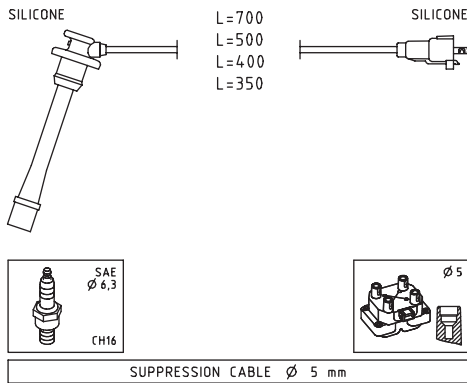

TOYOTA

4 RUNNER 2.7 16V	3RZ-FE	11/95 ⇨ 08/00
4 RUNNER 2.7 i	3RZ-FE	11/95 ⇨ 03/96
COASTER 2.7	3RZFE	07/99 ⇨
DYNA 200 2.7	3RZ-FE	06/95 ⇨ 07/01
HIACE IV 2.7	3RZ-FE	04/98 ⇨ 12/06
HIACE IV 2.7 4WD	3RZ-FE	04/98 ⇨ 08/06
HILUX VI 2.4 i 4WD	2RZ-FE	08/97 ⇨ 10/05
LAND CRUISER 2.7	3RZ-FE	09/02 ⇨ 08/04
T100 2.7 i [USA]	3RZFE	10/93 ⇨ 07/98
TACOMA 2.4 i [USA]	2RZFE	01/95 ⇨
TACOMA 2.7 i [USA]	3RZFE	02/98 ⇨

EPS 1.501.793



07,5

IGNITION CABLE SETS

Adatt./Suitable:

BOSCH
0 986 AM0 035
HOLDEN
9091922370TOYOTA
90919-22369
90919-22370

00 Eliminated on 16-12-2020. Please verify the availability through our local distributors

- Eliminato il 16-12-2020. Verificare la disponibilità presso i nostri distributori
- Éliminé le 16-12-2020. Vérifier la disponibilité auprès de nos distributeurs sur place
- Am 16-12-2020 gestrichen. Evtl. Verfügbarkeit bitte bei unseren Händlern prüfen
- Eliminado en fecha 16-12-2020. Verificar la disponibilidad a través de nuestros distribuidores locales

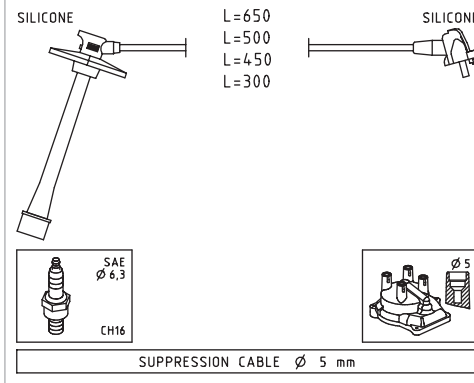

HOLDEN

APOLLO 2.2 i	08GR-FXS	03/93 ⇨ 05/97
--------------	----------	---------------

TOYOTA

CAMRY 2.2	5S-FE	06/91 ⇨ 07/96
CARINA E 2.0	3S-FE	01/93 ⇨ 09/97
CARINA E 2.0 GLI	3S-FE	04/92 ⇨ 09/97
CARINA E 2.0 GTi	3S-GE	04/92 ⇨ 12/95
CARINA E 2.0 GTi 16V	3S-GE	03/94 ⇨ 09/97
CARINA E 2.0 i	3S-FE	12/92 ⇨ 09/97
CELICA V 2.2	5S-FE	10/89 ⇨ 12/94
FUNCRUISER 2.0 i 16V 4WD	3SFE	04/94 ⇨
MR 2 II 2.2 16V	5S-FE	01/90 ⇨ 06/95
CELICA VI 2.2 GT	5S-FE	11/93 ⇨ 08/99
RAV 4 I 2.0	3S-FE	06/97 ⇨ 09/99
RAV 4 I 2.0 4WD	3S-FE	01/94 ⇨ 06/00

EPS 1.501.813



07,5

IGNITION CABLE SETS

Adatt./Suitable:

03 Supplied until depletion

- Fornibile fino ad esaurimento delle scorte
- Fourni jusqu'à épuisement du stock
- Lieferbar solange vorrat reicht
- Suministrado hasta el stock termina

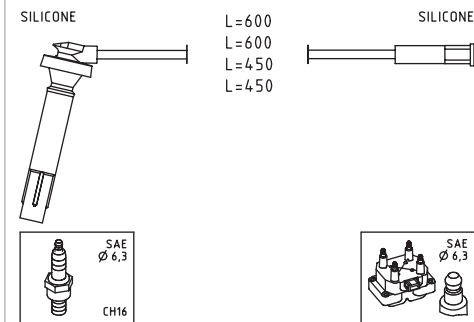

SUBARU

IMPREZA I 1.8 i	EJ181	08/92 ⇨ 12/00
IMPREZA I 2.0	EJ201	09/98 ⇨ 09/00
IMPREZA I 2.0 i	EJ201	09/98 ⇨ 09/00
IMPREZA I 2.0 i 16V AWD	EJ20, EJ20E	06/98 ⇨ 12/00
IMPREZA I 2.0 i AWD	EJ201	06/98 ⇨ 12/00
IMPREZA I 2.2 i	EJ22E, EJ22EZ	11/93 ⇨ 08/98
IMPREZA I 2.5 i	EJ253	11/93 ⇨ 08/98

SUBARU

IMPREZA II 2.0 AWD	EJ20	12/00 ⇨ 12/07
IMPREZA II 2.0 i AWD	EJ201	12/00 ⇨ 06/09
IMPREZA II 2.5 AWD	EJ25	03/01 ⇨ 09/05
IMPREZA II 2.5 i AWD	EJ251	12/02 ⇨ 09/05
FORESTER II 2.0 AWD	EJ20, EJ201	06/02 ⇨ 05/05
FORESTER II 2.5	EJ251	02/02 ⇨
LEGACY III 2.0	EJ201	12/98 ⇨ 08/03
LEGACY III 2.0 AWD	EJ201	12/98 ⇨ 08/03
LEGACY III 2.5	EJ251	10/98 ⇨ 08/03
LEGACY III 2.5 AWD	EJ25	10/98 ⇨ 08/03
OUTBACK II 2.5 AWD	EJ25	10/00 ⇨ 08/03
FORESTER I 2.0 AWD	EJ202	08/97 ⇨ 09/02

EPS 1.501.817



07,5

IGNITION CABLE SETS

Adatt./Suitable:

00 Eliminated on 16-12-2019. Please verify the availability through our local distributors

- Eliminato il 16-12-2019. Verificare la disponibilità presso i nostri distributori
- Éliminé le 16-12-2019. Vérifier la disponibilité auprès de nos distributeurs sur place
- Am 16-12-2019 gestrichen. Evtl. Verfügbarkeit bitte bei unseren Händlern prüfen
- Eliminado en fecha 16-12-2019. Verificar la disponibilidad a través de nuestros distribuidores locales

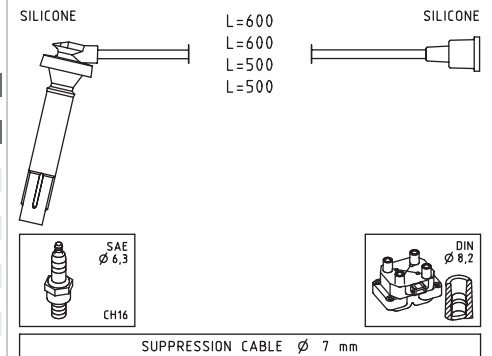

SUBARU

FORESTER I 2.0 AWD	EJ202	08/97 ⇨ 09/02
--------------------	-------	---------------

EPS 1.501.819



07,5

IGNITION CABLE SETS

Adatt./Suitable:

03 Supplied until depletion

- Fornibile fino ad esaurimento delle scorte
- Fourni jusqu'à épuisement du stock
- Lieferbar solange vorrat reicht
- Suministrado hasta el stock termina

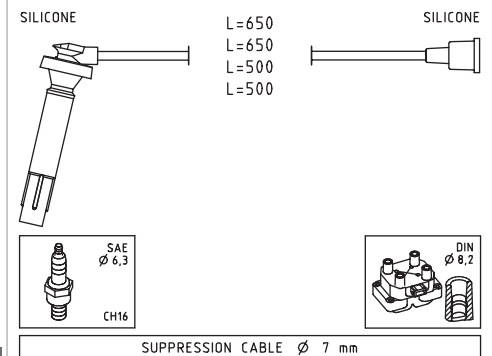

SUBARU

IMPREZA I 1.6	EJ161	09/98 ⇨ 09/00
IMPREZA I 1.6 i	EJ161	06/98 ⇨ 12/00
IMPREZA I 1.6 i AWD	EJ161	06/98 ⇨ 12/00
IMPREZA II 1.6 AWD	8F140GA, EJ161	12/00 ⇨ 06/09

1.501.823

EPS 1.501.823

07

IGNITION CABLE SETS

Adatt./Suitable:

TOYOTA
90919-22209
90919-22210

03 Supplied until depletion

- Fornibile fino ad esaurimento delle scorte
- Fourni jusqu'à épuisement du stock
- Lieferbar solange vorrat reicht
- Suministrado hasta el stock termina

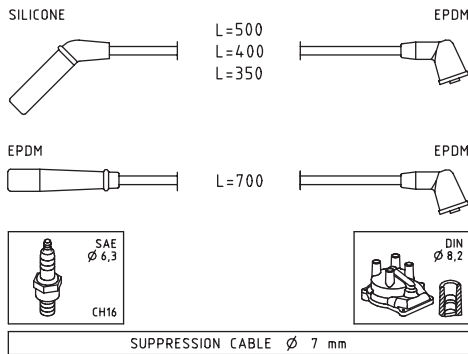
**TOYOTA**

COROLLA VI 1.3	2E	05/87 ⇒ 06/92
COROLLA VI 1.3 i	2E, 2E-E	08/87 ⇒ 06/92
STARLET 1.3 12V	2E, 2E-E	12/89 ⇒ 12/92
STARLET 1.3 12V Cat	2E-E	12/89 ⇒ 03/96
STARLET 1.3 XL	2E	12/89 ⇒ 12/91

EPS 1.501.835

07,5

IGNITION CABLE SETS

Adatt./Suitable:

03 Supplied until depletion

- Fornibile fino ad esaurimento delle scorte
- Fourni jusqu'à épuisement du stock
- Lieferbar solange vorrat reicht
- Suministrado hasta el stock termina

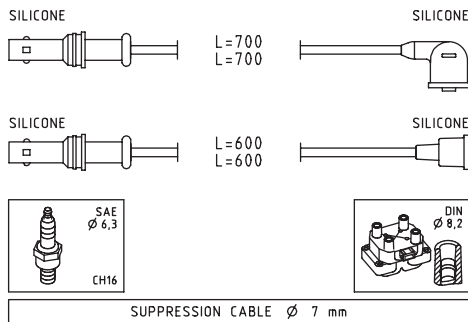
**SUBARU**

IMPREZA I 1.6	EJ16E	01/93 ⇒ 12/00
IMPREZA I 1.6 i	8F140GA	08/92 ⇒ 12/00
IMPREZA I 1.6 i AWD	8F140GA	08/92 ⇒ 12/00
IMPREZA I 1.8	EJ18	01/93 ⇒ 10/95
IMPREZA I 1.8 i	EJ18E	11/95 ⇒ 06/96
IMPREZA I 1.8 i AWD	EJ18, EJ18E	08/92 ⇒ 12/00
LEGACY II 1.8 4WD	EJ18E	05/96 ⇒ 09/98
LEGACY II 2.0 i	EJ20EMPI	09/94 ⇒ 03/99
LEGACY II 2.0 i 4WD	EJ201, EJ20E	09/94 ⇒ 03/99
FORESTER I 2.0	EJ20J	08/97 ⇒ 09/02

EPS 1.501.841

05

IGNITION CABLE SETS

Adatt./Suitable:

03 Supplied until depletion

- Fornibile fino ad esaurimento delle scorte
- Fourni jusqu'à épuisement du stock
- Lieferbar solange vorrat reicht
- Suministrado hasta el stock termina

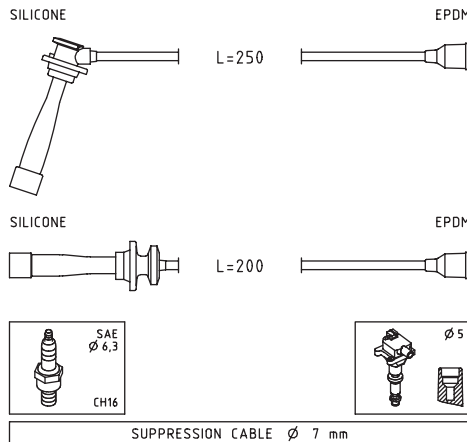
**KIA**

CARENS I 1.8	TB	07/02 ⇒
CARENS I 1.8 i	T8	11/00 ⇒ 07/02
CLARUS 1.8 i 16V	T8	07/96 ⇒
SEPHIA I 1.5 i	B5	02/96 ⇒ 10/97
SEPHIA I 1.8 i 16V	--, OK24N, OK26Y	01/95 ⇒ 10/97
SHUMA I 1.5	OK280	03/96 ⇒ 12/98
SHUMA I 1.5 i 16V	BFD, ZY-VE	10/97 ⇒ 10/01
SHUMA I 1.8 i 16V	T8	10/97 ⇒ 03/01
SHUMA II 1.8	T8	05/01 ⇒ 08/04
SPECTRA 1.5 i	--	09/97 ⇒
SPECTRA 1.5 i 16V	--	09/97 ⇒
SPECTRA 1.8 i 16V	--	09/97 ⇒
SEPHIA 1.5 i 16V	--	09/97 ⇒
SEPHIA 1.8 i 16V	--	09/97 ⇒

EPS 1.501.851

07

IGNITION CABLE SETS

Adatt./Suitable:

KIA
OK30A-18-140A
OK30B-18140
27401-2X000

03 Supplied until depletion

- Fornibile fino ad esaurimento delle scorte
- Fourni jusqu'à épuisement du stock
- Lieferbar solange vorrat reicht
- Suministrado hasta el stock termina

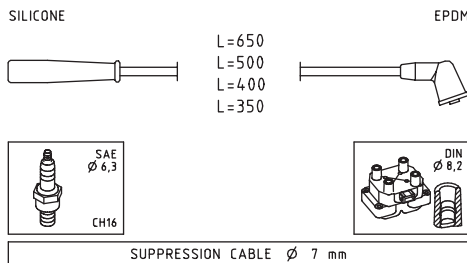
**KIA**

RIO I 1.3	A3E	08/00 ⇒ 02/05
-----------	-----	---------------

EPS 1.501.856

07,5

IGNITION CABLE SETS

Adatt./Suitable:

BOSCH
0 986 AMO 063
TOYOTA
90919-22386
90919-22400

03 Supplied until depletion

- Fornibile fino ad esaurimento delle scorte
- Fourni jusqu'à épuisement du stock
- Lieferbar solange vorrat reicht
- Suministrado hasta el stock termina

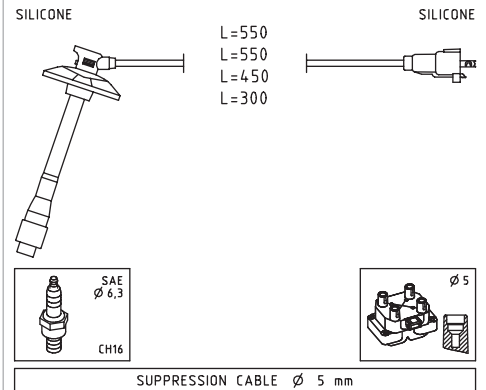
**TOYOTA**

AVENSIS I 2.0	3S-FE	09/97 ⇒ 10/00
CAMRY 2.2	5S-FE, 5S-FNE	08/96 ⇒
CAMRY SOLARA I 2.2	5S-FE	06/98 ⇒ 11/02
FUNCRUISER 2.0 i 16V 4WD	3SFE	04/94 ⇒
PICNIC I 2.0	3S-FE	06/00 ⇒ 12/01
PICNIC I 2.0 16V	3S-FE	08/96 ⇒ 09/00
RAV 4 I 2.0	3S-FE	06/97 ⇒ 09/99
RAV 4 I 2.0 4WD	3S-FE	01/94 ⇒ 06/00

EPS 1.501.879

07,5

IGNITION CABLE SETS

Adatt./Suitable:

TOYOTA
90998-99001
90998-99002

00 Eliminated on 16-09-2019. Please verify the availability through our local distributors

- Eliminato il 16-09-2019. Verificare la disponibilità presso i nostri distributori
- Éliminé le 16-09-2019. Vérifier la disponibilité auprès de nos distributeurs sur place
- Am 16-09-2019 gestrichen. Evtl. Verfügbarkeit bitte bei unseren Händlern prüfen
- Eliminado en fecha 16-09-2019. Verificar la disponibilidad a través de nuestros distribuidores locales

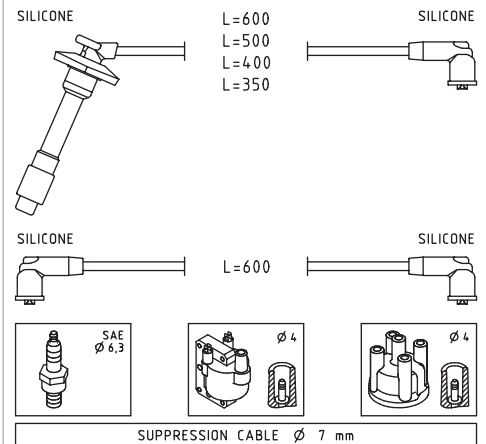
**TOYOTA**

AVENSIS I 1.6	4A-FE	09/97 ⇒ 10/00
CARINA E 1.6	4A-FE	04/92 ⇒ 09/97
CARINA E 1.6 GLV	4A-FE	12/94 ⇒ 09/97
CARINA E 1.6 GLI	4A-FE	04/92 ⇒ 09/97
CARINA E 1.6 i	4A-FE	02/95 ⇒ 09/97
CARINA E 1.8	7A-FE	04/92 ⇒ 09/97
CARINA E 1.8 i	7A-FE	02/95 ⇒ 09/97

TOYOTA		
CARINA E 1.8i 16V	7A-FE	01/95 ⇒ 09/97

EPS 1.501.880 **07**

IGNITION CABLE SETS

Adatt./Suitable:

- BOSCH**
0 986 357 259
- HITACHI**
134132
- TOYOTA**
90919-22395

- 03 Supplied until depletion**
- Fornibile fino ad esaurimento delle scorte
- Fourni jusqu'à épuisement du stock
- Lieferbar solange vorrat reicht
- Suministrado hasta el stock termina

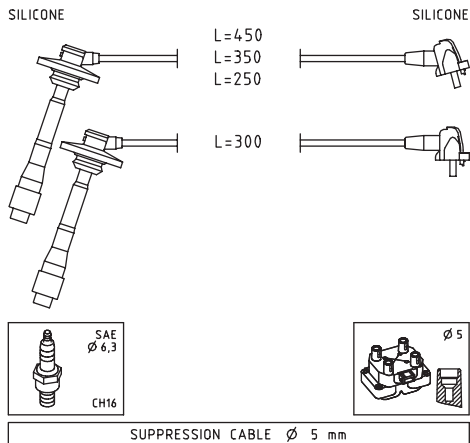

TOYOTA		
COROLLA VIII 1.4	4E-FE	04/97 ⇒ 02/00

EPS 1.501.882 **07,5**

IGNITION CABLE SETS

Adatt./Suitable:

- BOSCH**
0 986 357 272
- MITSUBISHI**
MD362276

- 00 Eliminated on 19-01-2022. Please verify the availability through our local distributors**
- Eliminato il 19-01-2022. Verificare la disponibilità presso i nostri distributori
- Éliminé le 19-01-2022. Vérifier la disponibilité auprès de nos distributeurs sur place
- Am 19-01-2022 gestrichen. Evtl. Verfügbarkeit bitte bei unseren Händlern prüfen
- Eliminado en fecha 19-01-2022. Verificar la disponibilidad a través de nuestros distribuidores locales

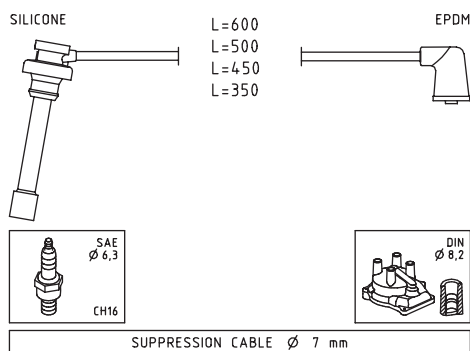

MITSUBISHI		
SPACE STAR 1.3 16V	4G13(16V)	09/00 ⇒ 12/04

EPS 1.501.883 **07**

IGNITION CABLE SETS

Adatt./Suitable:

- BOSCH**
0 986 357 273
- HITACHI**
134619
- MITSUBISHI**
MD365102

- 03 Supplied until depletion**
- Fornibile fino ad esaurimento delle scorte
- Fourni jusqu'à épuisement du stock
- Lieferbar solange vorrat reicht
- Suministrado hasta el stock termina

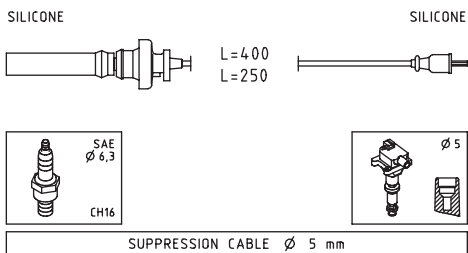

MITSUBISHI		
CARISMA 1.3 16V	4G13(16V)	09/00 ⇒ 10/04
COLT V 1.3	4G19	08/02 ⇒ 09/03
COLT V 1300	4G13(16V)	06/00 ⇒ 09/03
COLT V 1300 GL, GLX	4G13(12V)	05/96 ⇒ 06/00
LANCER VIII 1.3	4G13(16V)	09/03 ⇒ 12/13
LANCER VIII 1.6	4G18	09/03 ⇒ 12/13
SPACE STAR 1.3 16V	4G13(16V)	09/00 ⇒ 12/04
SPACE STAR 1.6 16V	4G18	01/01 ⇒ 12/04

EPS 1.501.887 **07,5**

IGNITION CABLE SETS

Adatt./Suitable:

- 03 Supplied until depletion**
- Fornibile fino ad esaurimento delle scorte
- Fourni jusqu'à épuisement du stock
- Lieferbar solange vorrat reicht
- Suministrado hasta el stock termina

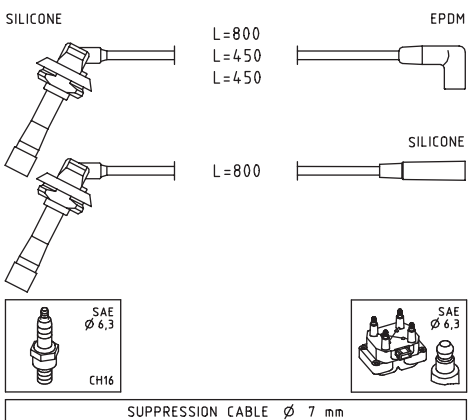

SUBARU		
IMPREZA I 2.0 Turbo GT AWD	EJ205	06/98 ⇒ 12/00
FORESTER I 2.0 S Turbo AWD	EJ20	06/98 ⇒ 04/01

EPS 1.501.888 **07,5**

IGNITION CABLE SETS

Adatt./Suitable:

- BOSCH**
0 986 356 731
- HITACHI**
134287
- ROVER**
GHT284
NGC000090

- 03 Supplied until depletion**
- Fornibile fino ad esaurimento delle scorte
- Fourni jusqu'à épuisement du stock
- Lieferbar solange vorrat reicht
- Suministrado hasta el stock termina

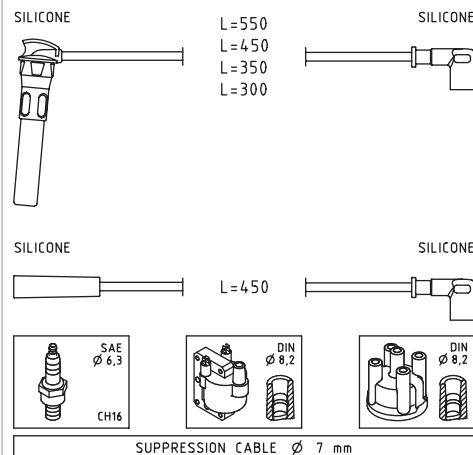

MG		
MGF 1.8 i 16V	18K4F	03/95 ⇒ 03/02
MG TF 115	16K4F	03/02 ⇒ 12/09
MG TF 120	18K4F	03/02 ⇒ 12/09
MG TF 135	18K4F	03/02 ⇒ 12/09
MG ZR 105	14K4F	06/01 ⇒ 04/05
MG ZR 120	18K4F	06/01 ⇒ 04/05

ROVER		
25 1.4 16V	14K4F, 14K4M	10/99 ⇒ 05/05
25 1.6 16V	16K4F	10/99 ⇒ 05/05
25 1.8 16V	18K4F	10/99 ⇒ 05/05
200 II 216	16K4F	01/96 ⇒ 12/97
200 II 216 1.6i 16V	16K4F	01/96 ⇒ 11/99
200 III 214 Si	14K4F	11/95 ⇒ 03/00
200 III 216 Si	16K4F	11/95 ⇒ 06/99
400 II 414 Si	14K4F	05/95 ⇒ 03/00
400 II 416 Si	16K4F, D16Y2	03/95 ⇒ 03/00
400 I 1.6 i	16K4F, D16A8	05/94 ⇒ 11/98
COUPE 1.6 16V	16K4F	03/96 ⇒ 11/99

EPS 1.501.889 **07**

IGNITION CABLE SETS

Adatt./Suitable:

- ROVER**
NGC000040

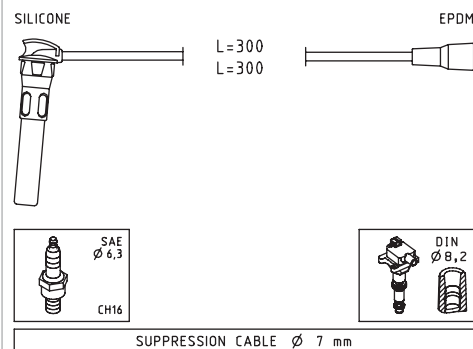

LAND ROVER		
FREELANDER 1.8 16V 4x4	18K4F	04/98 ⇒ 10/06
FREELANDER 1.8 i 16V 4x4	18K4F	02/98 ⇒ 10/06

MG		
MGF 1.8 i 16V	18K4F	03/95 ⇒ 03/02
MG TF 115	16K4F	03/02 ⇒ 12/09
MG TF 120	18K4F	03/02 ⇒ 12/09
MG TF 135	18K4F	03/02 ⇒ 12/09
MG ZR 105	14K4F	06/01 ⇒ 04/05

1.501.900

MG		
MG ZR 120	18K4F	06/01 ⇒ 04/05
MG ZS 120	18K4F	07/01 ⇒ 10/05
ROVER		
25 1.4 16V	14K4F, 14K4M	10/99 ⇒ 05/05
25 1.6 16V	16K4F	10/99 ⇒ 05/05
25 1.8 16V	18K4F	10/99 ⇒ 05/05
45 1.4	14K4F	02/00 ⇒ 05/05
45 1.6	16K4F	02/00 ⇒ 05/05
45 1.8	18K4F	02/00 ⇒ 05/05
75 1.8	K1.8	02/99 ⇒ 05/05
75 1.8 Turbo	--	05/03 ⇒ 05/05
200 III 214 Si	14K4F	11/95 ⇒ 03/00
200 III 216 Si	16K4F	11/95 ⇒ 06/99

EPS 1.501.900

07,5

IGNITION CABLE SETS

Adatt./Suitable:

⁰³ Supplied until depletion

- Fornibile fino ad esaurimento delle scorte
- Fourni jusqu'à épuisement du stock
- Lieferbar solange vorrat reicht
- Suministrado hasta el stock termina

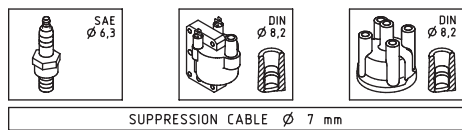
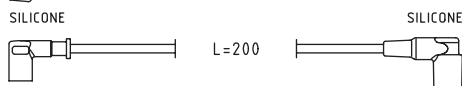
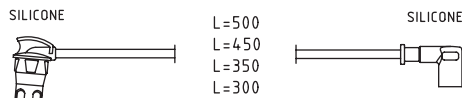

LAND ROVER

FREELANDER 1.8 16V 4x4	18K4F	04/98 ⇒ 10/06
FREELANDER 1.8 i 16V 4x4	18K4F	02/98 ⇒ 10/06

EPS 1.501.904

07,5

IGNITION CABLE SETS

Adatt./Suitable:

GENERAL MOTORS

09 117 892
09 117 893
09 117 894
09 117 895
93 176 701

⁰³ Supplied until depletion

- Fornibile fino ad esaurimento delle scorte
- Fourni jusqu'à épuisement du stock
- Lieferbar solange vorrat reicht
- Suministrado hasta el stock termina

OPEL

12 82 163
12 82 164
12 82 165
12 82 166
16 12 657

¹⁸⁰ with marten protection

- con protezione contro roditori
- avec protection anti-mustélidés
- mit Marderschutz
- con protección contra martas

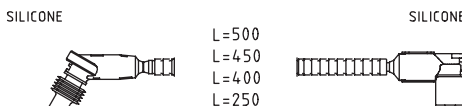

OPEL

ASTRA G 1.6	X16SZR, Z16SE	09/00 ⇒ 04/05
COMBO B 1.4	C14SE, X14SZ	07/94 ⇒ 10/01

OPEL

COMBO C 1.6	Z16SE	10/01 ⇒
CORSA B 1.4	C14SE	04/93 ⇒ 08/94
CORSA B 1.4 i	X14SZ	03/93 ⇒ 09/00
CORSA B 1.4 Si	C14SE	03/93 ⇒ 09/00
CORSA C 1.6	Z16SE	09/00 ⇒
MERIVA A 1.6	Z16SE	05/03 ⇒ 05/10
VECTRA B 1.6 i	X16SZR	10/95 ⇒ 07/03

VAUXHALL

ASTRA IV 1.6	X16SZR, Z16SE	03/98 ⇒ 05/05
ASTRAVAN II 1.6 i	X16SZR, Z16SE	09/00 ⇒ 08/06
COMBO B 1.4	C14SE	07/94 ⇒ 10/01
COMBO C 1.6	Z16SE	09/01 ⇒ 11/11
CORSA B 1.4 i	X14SZ	03/93 ⇒ 09/00
CORSA B 1.4 i S	C14SE	03/93 ⇒ 09/00
MERIVA I 1.6 i	Z16SE	01/03 ⇒ 06/10
VECTRA B 1.6 i	X16SZR	08/95 ⇒ 03/02

EPS 1.501.914

07

IGNITION CABLE SETS

Adatt./Suitable:

BOSCH

0 986 357 153

ROVER

GHT287

NGC000060

⁰³ Supplied until depletion

- Fornibile fino ad esaurimento delle scorte
- Fourni jusqu'à épuisement du stock
- Lieferbar solange vorrat reicht
- Suministrado hasta el stock termina

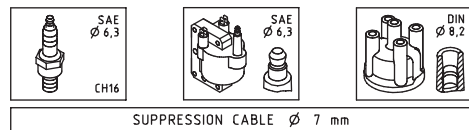
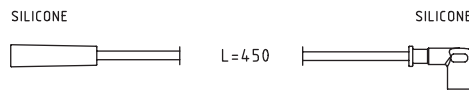
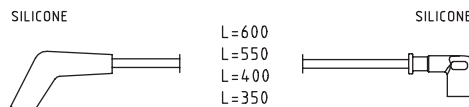

ROVER

200 III 211	11K2D	01/98 ⇒ 03/00
200 III 214 i	14K2F	11/95 ⇒ 03/00

EPS

1.501.921

07,5

IGNITION CABLE SETS

Adatt./Suitable:

⁰⁰ Eliminated on 18-11-2019. Please verify the availability through our local distributors

- Eliminato il 18-11-2019. Verificare la disponibilità presso i nostri distributori
- Éliminé le 18-11-2019. Vérifier la disponibilité auprès de nos distributeurs sur place
- Am 18-11-2019 gestrichen. Evtl. Verfügbarkeit bitte bei unseren Händlern prüfen
- Eliminado en fecha 18-11-2019. Verificar la disponibilidad a través de nuestros distribuidores locales

¹⁸⁰ with marten protection

- con protezione contro roditori
- avec protection anti-mustélidés
- mit Marderschutz
- con protección contra martas

SILICONE

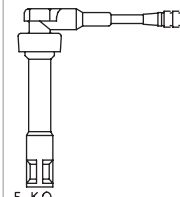

SILICONE

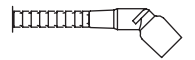

5 K.Ω

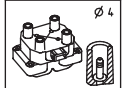
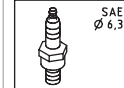
COPPER CORE CABLE \varnothing 7 mm

BMW

3 III 318 is	M42B18(18451), M44B19(19451)	01/92 ⇒ 04/99
3 III 318 ti	M42B18(18451), M44B19(19451)	09/94 ⇒ 08/99
Z3 1.9 i	M44B19(19451)	11/95 ⇒ 03/99

EPS

1.501.932

07

IGNITION CABLE SETS

Adatt./Suitable:

⁰³ Supplied until depletion

- Fornibile fino ad esaurimento delle scorte
- Fourni jusqu'à épuisement du stock
- Lieferbar solange vorrat reicht
- Suministrado hasta el stock termina

SILICONE



SILICONE

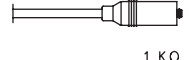

5 K.Ω

1 K.Ω

SILICONE



SILICONE

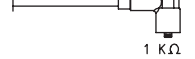

5 K.Ω

1 K.Ω

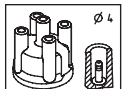
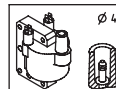
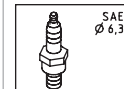
COPPER CORE CABLE \varnothing 7 mm

SEAT

CORDOBA I 1.6 i	AFT	07/96 ⇒ 12/02
IBIZA II 1.6 i	AFT	04/96 ⇒ 02/02

VW

GOLF IV 1.6	AFT, AKS	06/98 ⇒ 06/02
POLO III 1.6	AFT	05/97 ⇒ 09/01
POLO III 100 1.6	AFT	12/95 ⇒ 09/01
PASSAT III 1.6	AFT	07/94 ⇒ 08/96

EPS 1.501.933



IGNITION CABLE SETS

Adatt./Suitable:

00 Eliminated on 13-09-2021. Please verify the availability through our local distributors

- Eliminato il 13-09-2021. Verificare la disponibilità presso i nostri distributori
- Éliminé le 13-09-2021. Vérifier la disponibilité auprès de nos distributeurs sur place
- Am 13-09-2021 gestrichen. Evtl. Verfügbarkeit bitte bei unseren Händlern prüfen
- Eliminado en fecha 13-09-2021. Verificar la disponibilidad a través de nuestros distribuidores locales

03 Supplied until depletion

- Fornibile fino ad esaurimento delle scorte
- Fourni jusqu'à épuisement du stock
- Lieferbar solange vorrat reicht
- Suministrado hasta el stock termina

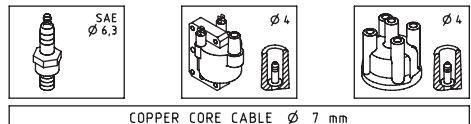
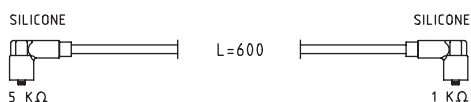
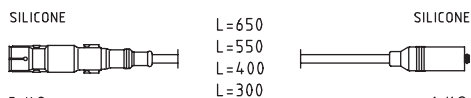

VW		
GOLF III 1.6	AFT	07/94 \Rightarrow 04/99
POLO III 1.6	AFT	05/97 \Rightarrow 09/01
POLO III 100 1.6	AFT	12/95 \Rightarrow 09/01
VENTO 1.6	AFT	10/94 \Rightarrow 09/98

EPS 1.501.937



IGNITION CABLE SETS

Adatt./Suitable:

03 Supplied until depletion

- Fornibile fino ad esaurimento delle scorte
- Fourni jusqu'à épuisement du stock
- Lieferbar solange vorrat reicht
- Suministrado hasta el stock termina

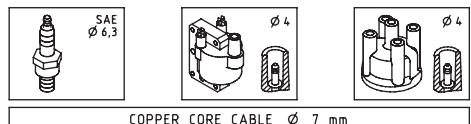
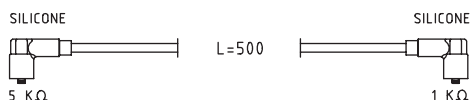
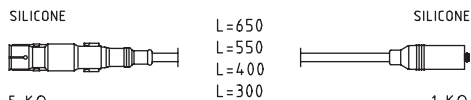

SEAT		
TOLEDO I 1.6 i	AFT	11/96 \Rightarrow 03/99
VW		
GOLF III 1.6	AFT, AKS	07/94 \Rightarrow 04/99
VENTO 1.6	AFT, AKS	10/94 \Rightarrow 02/99

EPS 1.501.942



IGNITION CABLE SETS

Adatt./Suitable:

BOSCH
0 986 356 723
0 986 356 972

DAEWOO
NP1332

GENERAL MOTORS
90 297 423

OPEL
16 12 477

00 Eliminated on 14-04-2020. Please verify the availability through our local distributors

- Eliminato il 14-04-2020. Verificare la disponibilità presso i nostri distributori
- Éliminé le 14-04-2020. Vérifier la disponibilité auprès de nos distributeurs sur place
- Am 14-04-2020 gestrichen. Evtl. Verfügbarkeit bitte bei unseren Händlern prüfen
- Eliminado en fecha 14-04-2020. Verificar la disponibilidad a través de nuestros distribuidores locales

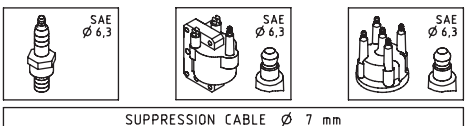
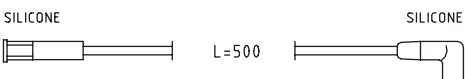
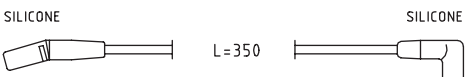
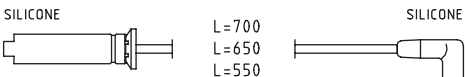

DAEWOO		
NEXIA 1.5	G15MF	02/95 \Rightarrow 08/97
OPEL		
ASCONA C 1.6 i	E16NZ	09/87 \Rightarrow 08/88
ASCONA C 1.6 i Cat	C16LZ, C16NZ	09/86 \Rightarrow 08/88
KADETT E 1.6 i	C16NZ	09/86 \Rightarrow 07/94
KADETT E 1.6 i Cat	C16LZ, C16NZ	09/86 \Rightarrow 02/93

EPS 1.501.947



IGNITION CABLE SETS

Adatt./Suitable:

03 Supplied until depletion

- Fornibile fino ad esaurimento delle scorte
- Fourni jusqu'à épuisement du stock
- Lieferbar solange vorrat reicht
- Suministrado hasta el stock termina

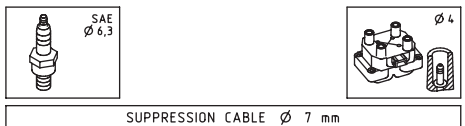
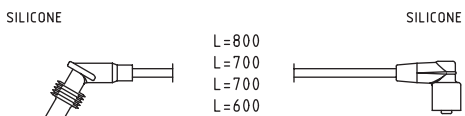

HOLDEN		
FRONTERA UT 2.0i	X20SE	10/95 \Rightarrow 03/99
OPEL		
FRONTERA A 2.0 i	X20SE	03/92 \Rightarrow 10/98
VAUXHALL		
FRONTERA A 2.0	X20SE	04/95 \Rightarrow 08/98
FRONTERA A 2.0 i	X20SE	03/92 \Rightarrow 10/98

EPS 1.501.976



IGNITION CABLE SETS

Adatt./Suitable:

00 Eliminated on 22-02-2021. Please verify the availability through our local distributors

- Eliminato il 22-02-2021. Verificare la disponibilità presso i nostri distributori
- Éliminé le 22-02-2021. Vérifier la disponibilité auprès de nos distributeurs sur place
- Am 22-02-2021 gestrichen. Evtl. Verfügbarkeit bitte bei unseren Händlern prüfen
- Eliminado en fecha 22-02-2021. Verificar la disponibilidad a través de nuestros distribuidores locales

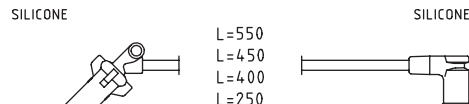

FORD		
GALAXY I 2.3 16V	ESSA, ESSB	09/01 \Rightarrow 05/06

EPS 1.501.984



IGNITION CABLE SETS

Adatt./Suitable:

00 Eliminated on 22-02-2022. Please verify the availability through our local distributors

- Eliminato il 22-02-2022. Verificare la disponibilità presso i nostri distributori
- Éliminé le 22-02-2022. Vérifier la disponibilité auprès de nos distributeurs sur place
- Am 22-02-2022 gestrichen. Evtl. Verfügbarkeit bitte bei unseren Händlern prüfen
- Eliminado en fecha 22-02-2022. Verificar la disponibilidad a través de nuestros distribuidores locales

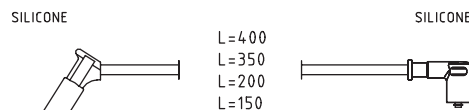

1.501.990

EPS

1.501.990

 07,5

IGNITION CABLE SETS

Adatt./Suitable:

00 Eliminated on 22-02-2022. Please verify the availability through our local distributors

- Eliminato il 22-02-2022. Verificare la disponibilità presso i nostri distributori
- Éliminé le 22-02-2022. Vérifier la disponibilité auprès de nos distributeurs sur place
- Am 22-02-2022 gestrichen. Evtl. Verfügbarkeit bitte bei unseren Händlern prüfen
- Eliminado en fecha 22-02-2022. Verificar la disponibilidad a través de nuestros distribuidores locales

SILICONE



L = 350
L = 350
L = 350

EPDM

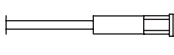

SILICONE

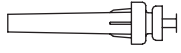

L = 300

SILICONE

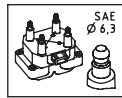
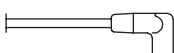

SUPPRESSION CABLE Ø 7 mm

CHRYSLER

PT CRUISER 2.4 GT	EDV	03/04 ⇔ 03/08
PT CRUISER GT 2.4	EDV	08/03 ⇔ 12/10



PICK-UPS

-IMPULSORI -CAPTEURS -IMPULSGEBER -CAPTADORES

(A) P/NRS. - NOTES

- CODICI - NOTE
- RÉFS. - NOTES
- ARTIKEL-NR. - ANMERKUNGEN
- CODIGOS - NOTAS

(B) PICTURE + TECHNICAL INFO

- FOTO + INFORMAZIONE TECNICA
- ILLUSTRATION + INFORMATION TECHNIQUE
- BILD + TECHNISCHE INFO
- FOTO + INFORMACIÓN TÉCNICA

(C) APPLICATION LIST

- GUIDA APPLICAZIONI
- LISTE D'APPLICATIONS
- ANWENDUNGSTABELLE
- LISTA DE APLICACIONES

1.930.161/1 3,5

PICK-UPS

Adatt./Suitable: **MARELLI**

ABARTH
9939762

FIAT
9934729
9939762

LANCIA
9934729

MAGNETI MARELLI
071319801010
610 800 24 *N
712 160 01
713 198 01

***N Available only pick-up coil, not the distributor assy**

- Fornito solo l'impulsore, non lo spinterogeno completo
- Disponible seulement capteur, sans allumeur
- Erhältlich nur Impulsgeber, ohne Zündverteiler
- Disponible solamente captador sin didtribuidor

L	ohm	Pick-Up	
700	730	Coil	

ABARTH		
RITMO 125 TC 2.0	138AR1.000	11/81 ⇄ 12/87
FIAT		
132 2.0	132C2.000	01/76 ⇄ 06/81
RITMO II 105 1.6	138AR.000	01/83 ⇄ 12/87
LANCIA		
A 112 1.0 Abarth	A112A2.000, A112A2.000	03/78 ⇄ 02/84

(A)

1 # EPS

2 **OEM P/NRS.**
 • CODICI ORIGINALI
 • RÉFS. D'ORIGINE
 • ORIGINALTEILE-NR.
 • CODIGOS ORIGINALES

3 **PACKAGING SIZE**
 • FORMATO CONFEZIONE
 • FORMAT DU CONDITIONNEMENT
 • ABPACKENSGROSSE
 • TAMAÑO DEL ENVASE

4 **NOTE**
 • NOTE
 • NOTES
 • BERMERKUNGEN
 • NOTAS

(B)

1 **PICTURE**
 • FOTO
 • PHOTO
 • BILD
 • FOTO

2 **CABLE LENGHT IN "mm" MEASURED AS SHOWN:**
 • LUNGHEZZA IN "mm" DEL CAVO COSÌ MISURATO:
 • LONGUEUR EN "mm" DU CABLE MESURÉ COMME SUIT:
 • KABELLÄNGE IN "mm" GEMESSEN WIE GEZEIGT:
 • LARGO EN "mm" DEL CABLE MEDIDO DE LA MANERA ILUSTRADA:

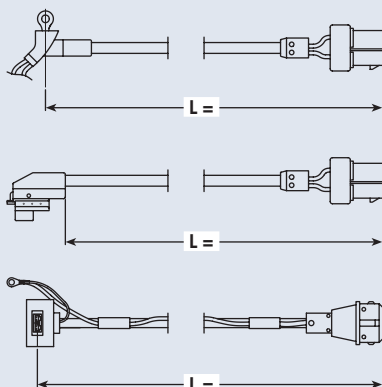

3 **RESISTANCE BETWEEN THE TERMINALS**
 • RESISTENZA TRA I TERMINALI
 • RESISTANCE ENTRE LES CONNEXIONS
 • WIDERSTAND ZWISCHEN DEN ANSCHLÜSSEN
 • RESISTENCIA ENTRE LOS ENCHUFES

4 **PICK-UP COIL**
 • IMPULSORI
 • CAPTEUR
 • IMPULSGEBER
 • CAPTADOR

HALL PICK-UP COIL
 • IMPULSORI SISTEMA HALL
 • CAPTEUR DU SYSTEME HALL
 • HALL-IMPULSGEBER
 • CAPTADOR DEL SISTEMA HALL

5 **TYPE OF CONNECTION**
 • TIPO DI CONNESSIONE
 • TYPE DE CONNEXION
 • ANSCHLUSSART
 • TIPO DE ENCHUFE

1.906.153

EPS 1.906.153



3

PICK-UPS

Adatt./Suitable: BOSCH

ALFA ROMEO

705 420
9938953
9950055****Eliminated on 27-01-2021. Please verify the availability through our local distributors**

• Eliminato il 27-01-2021. Verificare la disponibilità presso i nostri distributori

• Éliminé le 27-01-2021. Vérifier la disponibilité auprès de nos distributeurs sur place

• Am 27-01-2021 gestrichen. Evtl. Verfügbarkeit bitte bei unseren Händlern prüfen
• Eliminado en fecha 27-01-2021. Verificar la disponibilidad a través de nuestros distribuidores localesBOSCH
0 237 002 109 *N
1 234 211 018
1 234 211 218
1 237 031 123 *SFIAT
7073905 *S
7080461
9938953FORD
3 241 724
3 243 330
6 147 957 *S
84AU-12A09-3APEUGEOT
5904 06
5905 09TALBOT
0013 56 6600VOLVO
1276620VW
035 905 205
035 905 205 A *N
035 905 205 B *N
035 905 205 C *N
035 905 205 D *N
035 905 205 E *N
035 905 205 Q *N
035 905 315
047 905 205 C *N
325 905 209 2
477 905 206****Available pick-up coil only-not the distributor assy**

• Fornito solo impulsore, no lo spinterogeno completo

• Disponible seulement capteur, sans l'allumeur

• Erhältlich nur impulsgeber, ohne Zündverteiler

• Disponible solamente captador sin distribuidor

****Available pick-up coil only-not base**

• Fornito solo impulsore, no base

• Disponible seulement capteur, sans base

• Erhältlich nur Impulsgeber, ohne Grundplatte

• Disponible solamente captador, sin base



L	ohm	Pick-Up
---	1.100	Coil

ALFA ROMEO

33 I 1.3	AR30168	10/84 ⇒ 12/89
33 I 1.3 i.e.	AR30168	05/83 ⇒ 12/89
33 I 1.5 4x4	AR30508	12/86 ⇒ 03/89
75 1.6	AR06100	05/85 ⇒ 09/89
75 1.8	AR06202	09/85 ⇒ 06/89
90 1.8	AR06202	10/84 ⇒ 07/87
90 2.0 i.e.	AR06210	10/84 ⇒ 07/87
ALFASUD 1.5 ti	AR30128	05/80 ⇒ 06/84
ALFETTA 1.6	AR01600	01/75 ⇒ 12/84
ALFETTA 1.8	AR01608	10/79 ⇒ 12/84
GIULIETTA I 1.6	AR01600	10/77 ⇒ 04/85
GIULIETTA I 1.8	AR01678	04/79 ⇒ 04/85
GIULIETTA I 2.0	AR01655	06/80 ⇒ 04/85
SPIDER I 1600	AR00526, AR01563	03/76 ⇒ 12/93

FIAT

UNO 70 1.3i SX	--	01/83 ⇒ 12/89
UNO 75 i.e. 1.5	138C2.048	10/85 ⇒ 12/93

FIAT (BR)

PREMIO 1.3	--	01/85 ⇒
PREMIO 1.5	--	01/85 ⇒
UNO 1.5	1.5	01/91 ⇒ 12/93
UNO 1.5R	1.5	01/87 ⇒ 12/89
UNO 1.6R	1.6	01/90 ⇒ 12/93
UNO CS 1.5	1.5	01/89 ⇒ 12/93
UNO CS 1.5 Furgoneta	1.5	01/91 ⇒ 12/93
UNO CSL 1.6	1.6	01/91 ⇒ 12/93
UNO MILLE 1.0	1.0	01/91 ⇒ 04/93

PEUGEOT

309 I 1.3	G1A, G2S	10/85 ⇒ 08/89
505 2.0Ti, STI	829(ZEJ)	08/79 ⇒ 10/86

TALBOT

TAGORA 2.1 SN2 06/80 ⇒ 12/83

VOLVO

240 2.0 B19ET 10/82 ⇒ 08/84
240 2.1 Turbo B21ET, B21FT 08/80 ⇒ 07/85

EPS 1.906.159



3,5

PICK-UPS

Adatt./Suitable: BOSCH

BOSCH

0 237 024 038 *N
0 237 035 001 *N
1 237 011 073PEUGEOT
5904 25SEAT
050 905 205 A *N
051 905 205 *N

VW

026 905 205 AA *N
026 905 205 AB *N
026 905 205 AC *N
026 905 205 AD *N
026 905 205 AF *N
026 905 205 AG *N
026 905 205 AH *N
026 905 205 AJ *N
026 905 205 AK *N
026 905 205 G *N
026 905 205 H *N
026 905 205 J *N
026 905 205 L *N
026 905 205 N *N
026 905 205 P *N
026 905 205 Q *N
026 905 206
026 905 206 A *N
026 905 206 AC *N
026 905 206 AD *N
026 905 206 B *N
026 905 206 C *N
026 905 206 E *N
026 905 206 F *N
026 905 206 G *N
026 905 206 H *N
026 905 206 J *N
026 905 206 K *N
026 905 206 T *N
027 905 205 F *N
027 905 205 H *N
027 905 205 M *N
027 905 205 Q *N
027 905 205 R *N
049 905 206 D *N
049 905 206 F *N
049 905 206 G *N
050 905 205
050 905 205 A *N
050 905 205 B *N
050 905 205 C *N
050 905 205 D *N
050 905 205 E *N
050 905 205 F *N
050 905 205 H *N
050 905 205 J *N
050 905 205 K *N
051 905 205 *N
056 905 205 L
175 905 206 A *N****Available pick-up coil only-not the distributor assy**

• Fornito solo impulsore, no lo spinterogeno completo

• Disponible seulement capteur, sans l'allumeur

• Erhältlich nur impulsgeber, ohne Zündverteiler

• Disponible solamente captador sin distribuidor



L	ohm	Pick-Up
---	---	Hall

PEUGEOT

505 2.1 i	XN9T	01/83 ⇒ 12/88
505 2.2	851(ZDJ), 851X(ZDJL)	05/81 ⇒ 12/93
505 2.2 GTI	851B(ZDJL)	08/83 ⇒ 12/93

SEAT

TOLEDO I 1.6 i	1F	05/91 ⇒ 03/99
TOLEDO I 1.8 i	RP	05/91 ⇒ 12/96

VW

JETTA II 1.6	PN	10/86 ⇒ 10/91
GOLF II 1.6	PN	10/86 ⇒ 12/92
GOLF II 1.6 G	PN	08/86 ⇒ 07/91
GOLF II 1.8 [CHE] [SWE]	HV	04/84 ⇒ 07/86

EPS 1.906.160



3,5

PICK-UPS

Adatt./Suitable: BOSCH

BOSCH

1 230 500 221
9 231 087 552

VW

040 905 359 1

****Supplied until depletion**

- Fornibile fino ad esaurimento delle scorte
- Fourni jusqu'à épuisement du stock
- Lieferbar solange vorrat reicht
- Suministrado hasta el stock termina



L	ohm	Pick-Up
---	---	Hall

VOLKSWAGEN (BR)

GOL 1.6	504, 505	09/94 ⇒ 01/97
GOL 1.8	521, 522	04/94 ⇒ 01/97
GOL 2.0i	528, 529	09/94 ⇒ 01/97
LOGUS 1.6	504, 505	10/94 ⇒ 12/96
LOGUS 1.8	524, 525, 599	12/92 ⇒ 12/96
LOGUS 2.0	653	11/93 ⇒ 05/94
LOGUS 2.0i	526, 527	05/94 ⇒ 12/96
PARATI 1.6	504, 505	08/95 ⇒ 01/97
PARATI 1.8	521, 522	08/95 ⇒ 01/97
PARATI 2.0i	528, 529	08/95 ⇒ 01/97
POINTER 1.8	524, 525, 599	11/93 ⇒ 12/96
POINTER 2.0	653	12/92 ⇒ 05/94
POINTER 2.0i	526, 527	05/94 ⇒ 12/96

EPS 1.906.193



PICK-UPS

Adatt./Suitable: BOSCH

BOSCH
0 237 037 010 *N
1 237 011 076
1 237 011 111

SAAB
74 86 822

SEAT
030 998 065
SE 021914.016A

VW
030 905 205 *N
030 905 205 A *N
030 905 205 B *N
030 905 205 D *N
030 905 205 J *N
030 998 065

- *N Available pick-up coil only-not the distributor assy
- Fornito solo impulsore, no lo spinterogeno completo
 - Disponible seulement capteur, sans l'allumeur
 - Erhältlich nur impulsgeber, ohne Zündverteiler
 - Disponible solamente captador sin distribuidor



L	ohm	Pick-Up	
---	---	Hall	

SAAB			
900 I 2.0 c	B201XC	09/79 ⇨	12/88
900 I 2.0 i	0TLE4G15, B201XI	11/80 ⇨	08/90
900 I 2.0 Turbo	B201XL	01/86 ⇨	12/91
SEAT			
IBIZA I 1.2	021A1000	11/84 ⇨	12/93
MALAGA 1.2	021A1000	05/85 ⇨	12/93
MALAGA 1.5	021A2000	05/85 ⇨	12/93
VW			
POLO II 1.0	AAK, HZ	01/85 ⇨	09/94
POLO II 1.0 Cat	AAK	08/89 ⇨	09/94
POLO II 1.3	MH	08/83 ⇨	07/88
POLO II 1.3 Cat	2G, MH, NZ	07/87 ⇨	09/94
JETTA II 1.0	HZ	08/85 ⇨	10/91
JETTA II 1.3	MH, NU	01/84 ⇨	12/87
JETTA II 1.3 Cat	2G, MH, NZ	06/87 ⇨	12/91
DERBY 1.3	HK	08/83 ⇨	12/84
GOLF II 1.0	HZ	08/85 ⇨	10/91
GOLF II 1.3	MH, NU	08/83 ⇨	12/87
GOLF II 1.3 Cat	2G, NZ	06/86 ⇨	12/92

EPS 1.906.219



PICK-UPS

Adatt./Suitable: BOSCH

AUDI
034 998 065

BOSCH
1 237 011 081
1 237 011 116

VW
034 998 065
035 998 065 A



L	ohm	Pick-Up	
---	---	Hall	

AUDI			
80 II 1.3	EP	09/78 ⇨	07/86
80 II 1.6	DT, JU, SA, WV	08/78 ⇨	03/87
80 II 1.8	DS, JN, SF	01/83 ⇨	08/86
80 II 1.8 CC quattro	JN, JV	08/84 ⇨	08/86
80 II 1.8 GTE	DZ, MU	06/84 ⇨	03/87
80 II 2.0	JS	10/83 ⇨	09/84
80 II 2.0 quattro	JS	10/83 ⇨	09/84
80 III 1.4	SE	08/86 ⇨	07/88
80 III 1.6	ABB, PP, RN, RNA	09/86 ⇨	10/91
80 III 1.8	RU	10/86 ⇨	01/90
80 III 1.8 E	DZ	06/86 ⇨	08/91
80 III 1.8 S	JN, JV, NE, PM, SF	08/86 ⇨	10/91
90 I 1.8	JN	06/84 ⇨	03/87
90 I 2.0	JL, JS	10/84 ⇨	03/87
90 I 2.0 quattro	JS	08/84 ⇨	08/86
90 I 2.2	9CS4, KX	10/84 ⇨	03/87
90 I 2.2 E quattro	9CS4	11/84 ⇨	03/87
90 II 2.0	PS	07/88 ⇨	09/91
90 II 2.2 E	9CS4	04/87 ⇨	07/91
90 II 2.2 E quattro	9CS4	04/87 ⇨	09/91
100 III 1.8	DS, JW, NP, SH	08/83 ⇨	12/90
100 III 1.8 Cat	4B, PH	03/85 ⇨	11/90
100 III 1.8 Cat quattro	4B	08/85 ⇨	11/90
100 III 1.8 quattro	NP, SH	10/84 ⇨	07/90
100 III 2.0 Cat	RT	01/88 ⇨	11/90
100 III 2.0 E Cat	RT	01/88 ⇨	11/90
COUPE 1.8	DZ	08/89 ⇨	07/91
COUPE 2.2	9CS4	11/88 ⇨	07/91
COUPE 2.2 quattro	9CS4	11/88 ⇨	07/91
COUPE 2.3 quattro	NG	01/87 ⇨	12/87
VW			
PASSAT II 2.0	JS	08/83 ⇨	03/88
PASSAT II 2.0 Syncro	JS	05/84 ⇨	03/88
JETTA II 1.6	ABN, EZ, EZA, HM, PN, RF	12/83 ⇨	07/92
JETTA II 1.8	EV, GU, GX, RH	01/84 ⇨	10/91
JETTA II 1.8 Cat	GX, RP	08/87 ⇨	10/91
JETTA II 1.8 Syncro	GU, RP	08/87 ⇨	12/88
JETTA II 1.8i GT	GZ	12/83 ⇨	07/88
CADDY I 1.8	JH	08/85 ⇨	07/92
GOLF I 1.6	EW, HN	08/83 ⇨	04/92
GOLF I 1.8	DX, EX, JH, KT	08/82 ⇨	04/93
GOLF II 1.6	ABN, EZ, PN, RF	08/83 ⇨	12/92
GOLF II 1.6 [CHE] [SWE]	HM	08/83 ⇨	07/88
GOLF II 1.6 G	EZA, PN	08/86 ⇨	07/91
GOLF II 1.8	GU, GX, RH	08/84 ⇨	10/91
GOLF II 1.8 [CHE] [SWE]	HV	08/86 ⇨	07/87
GOLF II 1.8 GTI	EV	08/83 ⇨	10/91
GOLF II 1.8 i	RP	08/87 ⇨	07/91
GOLF II 1.8 i Cat	GX, RP	08/87 ⇨	10/91
GOLF II 1.8 i Cat Syncro	RP	08/87 ⇨	10/91

VW			
GOLF II 1.8 Syncro	GU, GX	02/86 ⇨	07/91
GOLF II 1.8i GTI [CHE] [SWE]	GZ	01/84 ⇨	07/87
GOLF II 1.8i GTI [SWE]	GZ	08/87 ⇨	07/88
PASSAT III 1.6	1F, EZ	04/88 ⇨	07/92
PASSAT III 1.8	RP	02/88 ⇨	05/97
QUANTUM 1.7	--	01/85 ⇨	12/87
SANTANA 2.0	JS	08/83 ⇨	12/84
SCIROCCO II 1.6	EW, EWA, HN, RE	01/83 ⇨	07/90
SCIROCCO II 1.8	DX, EX, JH, KT	08/82 ⇨	07/92

EPS 1.906.222



PICK-UPS

Adatt./Suitable: BOSCH

VOLVO
1346792
13467923

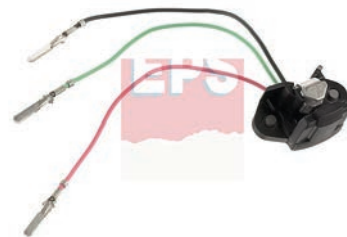

L	ohm	Pick-Up	
---	---	Hall	

VOLVO			
740 2.0	B200E, B200G, B200K	08/85 ⇨	07/92
740 2.3	B230E, B230F, B230K	08/84 ⇨	12/92
740 2.3 GL	B230E	08/84 ⇨	08/87
740 2.3 Turbo	B230FT	08/86 ⇨	08/91
760 2.3	B230FT, B230K	08/84 ⇨	07/92
760 2.3 Turbo	B230FT	08/84 ⇨	08/90
940 12.0	B200E	09/90 ⇨	09/93
940 12.3	B230E	08/90 ⇨	12/94

1.906.223

PICK-UPS

EPS **1.906.223** 

PICK-UPS

Adatt./Suitable: **BOSCH**

- AUDI**
030 905 065
030 905 065 B
- BOSCH**
0 237 522 011 *N
1 237 010 027
1 237 010 039
1 237 011 122
1 237 011 124
1 237 031 296

- *N Available pick-up coil only-not the distributor assy
- Fornito solo impulsore, no lo spinterogeno completo
 - Disponible seulement capteur, sans l'allumeur
 - Erhältlich nur impulsgeber, ohne Zündverteiler
 - Disponible solamente captador sin distribuidor

- SEAT**
030 905 065
030 905 065 B
037 905 205 M *N
050 905 205 AH *N
- SKODA**
030 905 065

- VW**
030 905 065
030 905 065 A
030 905 065 B
035 905 206 AF *N
037 905 205 M *N
050 905 205 AH *N
050 905 205 AL *N
050 905 205 BA *N
052 998 065

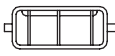

L	ohm	Pick-Up	
---	---	Hall	

AUDI			
80 IV 1.6 E	ADA	06/93 → 01/96	
A4 I 1.6	ADP	11/94 → 09/01	

SEAT			
AROSA 1.0	AER, ALL	05/97 → 06/04	
AROSA 1.4	AEX, AKV, APQ	05/97 → 06/04	
CORDOBA I 1.0 i	AER	09/96 → 10/02	
CORDOBA I 1.4	ANX	12/97 → 04/99	
CORDOBA I 1.4 i	AEX, AKV, APQ	06/94 → 12/02	
CORDOBA I 1.4 i 16V	AFH	09/96 → 10/02	
CORDOBA I 1.6 i	1F, AEE, AFT, ALM	02/93 → 06/99	
CORDOBA I 1.8 i	ABS, ACC, ADZ	02/93 → 09/02	
CORDOBA I 1.8 i 16V	148D	10/93 → 08/96	
CORDOBA I 2.0 i	AGG	02/93 → 06/99	
IBIZA II 1.0 i	AER	09/96 → 02/02	
IBIZA II 1.4	ANX	12/97 → 04/99	
IBIZA II 1.4 i	ABD, AEX, AKV, APQ	09/93 → 02/02	
IBIZA II 1.4 i 16V	AFH	06/97 → 02/02	
IBIZA II 1.6 i	1F, AEE, AFT, ALM	03/93 → 06/99	
IBIZA II 1.8 i	ABS, ADZ	03/93 → 08/99	
IBIZA II 1.8 i 16V	148D	11/93 → 08/96	
IBIZA II 2.0 i	AGG	03/93 → 08/99	
INCA 1.4 i	AEX, AKV, APQ	11/95 → 06/03	
INCA 1.6 i	1F, AEE	11/95 → 05/98	
ALHAMBRA I / II 2.0 i	ADY	04/96 → 03/10	
TOLEDO I 1.6 i	1F, AFT	05/91 → 03/99	
TOLEDO I 1.8 i	ABS, RP	05/91 → 12/96	
TOLEDO I 2.0 i	AGG	05/91 → 03/99	
TOLEDO I 2.0 i 16V	ABF	11/93 → 03/99	

SKODA			
FELICIA 1.6	6A16XHT	06/97 → 04/02	
FELICIA 1.6 GLX	6A16XHT	08/95 → 03/98	
FELICIA 1.6 LX	6A16XHT	08/95 → 03/98	
OCTAVIA I 1.6	6A16XHT	09/96 → 09/04	

VW			
PASSAT IV 1.6	ADP	10/96 → 11/00	
POLO II 1.0	AAU	01/85 → 09/94	
POLO II 1.0 Cat	AAU	08/89 → 09/94	
POLO II 1.3	AAV	09/82 → 07/94	
POLO II 1.3 Cat	AAV	07/87 → 09/94	
JETTA II 1.8 16V	KR, PL	08/86 → 10/91	
CADDY II 1.4	AEX, AKV, APQ	11/95 → 06/03	
CADDY II 1.6	1F, AEE	11/95 → 12/00	
CADDY II 60 1.4	AEX, APQ	11/95 → 01/04	
CADDY II 75 1.6	1F, AEE	11/95 → 05/97	

VW			
CADDY III 1.8 [ARG]	BUR	10/05 →	
CORRADO 1.8 16V	KR	04/89 → 07/92	
CORRADO 2.0 i 16V	7T2220XS560	08/91 → 12/95	
DERBY 1.3	GK	09/82 → 12/84	
GOLF II 1.8 GTI 16V	KR, PL	02/86 → 10/91	
GOLF III 1.4	ABD, AEX	10/91 → 04/99	
GOLF III 1.6	ABU, AEA, AEE, AEK, AFT, AKS	09/92 → 04/99	
GOLF III 1.8	AAM, ABS, ADZ	08/91 → 04/99	
GOLF III 2.0	ADY, AEP, AGG, AKR	11/91 → 04/99	
GOLF III 2.0 GL	AEP	08/95 → 09/97	
GOLF III 2.0 GTI 16V	ABF	08/92 → 08/97	
GOLF III 2.0 Syncro	AGG	08/95 → 04/99	
GOLF IV 1.6	AFT, AKS	06/98 → 06/02	
GOLF IV 2.0	AGG, AKR, AWF, AWG	06/98 → 06/02	
LUPU 1.0	AER, ALL	09/98 → 07/05	
POLO III 1.4	AEX, AKV, ANX, APQ	05/97 → 09/01	
POLO III 1.6	AEA, AEE, AFT, ALM	09/94 → 09/01	
POLO III 100 1.4 16V	AFH	04/96 → 10/99	
POLO III 100 1.6	AFT	12/95 → 09/01	
POLO III 45 1.0	AEV	10/94 → 09/96	
POLO III 50 1.0	AER, ALL	09/96 → 10/99	
POLO III 54 1.4	ANX	01/98 → 08/99	
POLO III 55 1.3	ADX	10/94 → 04/97	
POLO III 55 1.4	AEX	08/95 → 10/99	
POLO III 60 1.4	AEX, AKV, APQ	07/95 → 09/01	
POLO III 75 1.6	AEA, AEE, AHS, ALM	10/94 → 09/01	
POLO III 75 1.6 4motion	AEA	08/95 → 10/99	
PASSAT III 1.8	KR	08/91 → 09/93	
PASSAT III 1.8 16V	KR	04/88 → 12/89	
PASSAT III 1.8 GL	KR	08/91 → 09/93	
POLO IV 1.0	AER	08/96 → 12/01	
SCIROCCO II 1.8 16V	KR, PL	10/85 → 07/92	
TRANSPORTER IV 2.5	ACU, AET, AEU, APL, AVT	11/90 → 04/03	
TRANSPORTER IV 2.5 Syncro	ACU, AET, AEU, APL, AVT	08/92 → 04/03	
VENTO 1.4	ABD	11/91 → 09/98	
VENTO 1.6	AEA, AEK, AFT, AKS	09/92 → 02/99	

EPS **1.906.231** 

PICK-UPS

Adatt./Suitable: **BOSCH**

- VW**
035 998 065 A*
035 998 065 A***

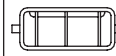

L	ohm	Pick-Up	
---	---	Hall	

AUDI			
80 II 1.6	WV	08/78 → 07/86	
80 III 1.8 quattro	SD	09/86 → 08/90	
80 III 1.8 S quattro	JN	09/86 → 09/91	

VW			
SANTANA 1.6	DT	08/81 → 12/84	
SANTANA 1.8	DS	01/83 → 12/84	

EPS **1.906.233** 

PICK-UPS

Adatt./Suitable: **BOSCH**

- ALFA ROMEO**
60534261 *S
- BOSCH**
0 237 521 047 *N
1 237 010 033
1 237 011 114
1 237 031 180

- *N Available pick-up coil only-not the distributor assy
- Fornito solo impulsore, no lo spinterogeno completo
 - Disponible seulement capteur, sans l'allumeur
 - Erhältlich nur impulsgeber, ohne Zündverteiler
 - Disponible solamente captador sin distribuidor

- FORD**
6 125 612 *S
6 182 576 *N
6 182 577 *N
845F-12100-BA *N
895F-12100-JA *N

- Motorcraft**
EDR 309 *S
- SEAT**
026 905 359 2
051 905 205 C *N

- *S Available pick-up coil only-not base
- Fornito solo impulsore, no base
 - Disponible seulement capteur, sans base
 - Erhältlich nur Impulsgeber, ohne Grundplatte
 - Disponible solamente captador, sin base

- VW**
026 905 359 2
030 998 065 A *S
051 905 205 B *N
051 905 205 C *N

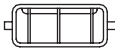

L	ohm	Pick-Up	
---	---	Hall	

FORD			
ESCORT IV 1.6 Turbo RS	LNB	01/86 → 07/90	

SEAT			
CORDOBA I 1.0 16V	AST, AVZ	05/00 → 10/02	
IBIZA II 1.0 16V	AST, AVZ	10/99 → 02/02	
TOLEDO I 1.8 16V	KR, PL	05/91 → 03/99	
TOLEDO I 1.8 GT	KR	05/91 → 11/92	

VOLKSWAGEN (BR)			
CADDY 1.6i	MY4	11/98 →	
GOL 1.0i	510	11/96 →	
GOL 1.0i 16v	511	09/97 →	
GOL 1.6i	540, 541	10/96 →	
GOL 1.8i	542, 543	10/96 →	
GOL 2.0i	546, 547	10/96 →	
PARATI 1.0i 16v	511	09/97 →	
PARATI 1.6i	540, 541	10/96 →	
PARATI 1.8i	542	10/96 →	
PARATI 2.0i	546, 547	10/96 →	
POLO 1.6	MJ3, MY4	07/00 →	
POLO 1.8	MJ2, MY5, MY6	12/96 →	
SAVEIRO 1.6i	540, 541	10/96 →	
SAVEIRO 1.8i	542, 543	10/96 →	
SAVEIRO 2.0i	546, 547	10/96 →	

VW			
CADDY III 1.6 [ARG]	UVC	10/05 →	
POLO II 1.3	3F	10/90 → 09/94	
POLO II 1.3 Cat	3F	10/89 → 09/94	
POLO II 1.3 G40	PY	01/87 → 09/94	

EPS **1.906.234**



PICK-UPS

Adatt./Suitable: **BOSCH**

BOSCH
0 237 021 074 *N
1 237 011 119

SEAT
030 998 065 B

VW
030 998 065 B

*N Available pick-up coil only-not the distributor assy

- Fornito solo impulsore, no lo spinterogeno completo
- Disponible seulement capteur, sans l'allumeur
- Erhältlich nur impulsgeber, ohne Zündverteiler
- Disponible solamente captador sin distribuidor



L	ohm	Pick-Up	
---	---	Hall	

SEAT			
IBIZA II 1.3 i	8C20HD0D	03/93 ⇨	08/99

VW			
POLO II 1.0	HZ	01/85 ⇨	09/94
POLO II 1.0 Cat	ACM	08/89 ⇨	09/94
POLO II 1.3 Cat	2G	07/87 ⇨	09/94
JETTA II 1.0	HZ	08/85 ⇨	10/91
JETTA II 1.3 Cat	2G, NZ	06/87 ⇨	12/91
GOLF II 1.0	HZ	08/85 ⇨	10/91
GOLF II 1.3 Cat	2G, NZ	06/86 ⇨	12/92

EPS **1.906.244**



PICK-UPS

Adatt./Suitable: **BOSCH**

BOSCH
0 237 520 054 *N
0 237 521 024
1 237 031 093
1 237 031 339

HYUNDAI
27180-22000

SAAB
88 57 617 *N

*N Available pick-up coil only-not the distributor assy

- Fornito solo impulsore, no lo spinterogeno completo
- Disponible seulement capteur, sans l'allumeur
- Erhältlich nur impulsgeber, ohne Zündverteiler
- Disponible solamente captador sin distribuidor



L	ohm	Pick-Up	
---	---	Hall	

HYUNDAI			
S COUPE 1.5 i	G4EK	04/92 ⇨	05/96
S COUPE 1.5 i Turbo	G4EK-TC	04/91 ⇨	05/96

SAAB			
900 I 2.0 S Turbo-16	B202S	07/91 ⇨	06/94

SAAB			
900 I 2.0 Turbo-16	B202L, B202XL	11/85 ⇨	06/94
900 I 2.0 Turbo-16 S	B202XL	01/84 ⇨	06/94
900 I 2.0 Turbo-16 S Cat	B202XL	01/89 ⇨	12/93

EPS **1.912.010**



PICK-UPS

Adatt./Suitable: **DELCO REMY**

GENERAL MOTORS
1 978 503

OPEL
12 12 126

⁰³ Supplied until depletion

- Fornibile fino ad esaurimento delle scorte
- Fourni jusqu'à épuisement du stock
- Lieferbar solange vorrat reicht
- Suministrado hasta el stock termina



L	ohm	Pick-Up
---	800	Coil

EPS **1.912.011**



PICK-UPS

Adatt./Suitable: **DELCO REMY**

DELCO REMY
1 103 516 *N
1 103 549 *N

GENERAL MOTORS
1 979 511

OPEL
12 12 125

*N Available pick-up coil only-not the distributor assy

- Fornito solo impulsore, no lo spinterogeno completo
- Disponible seulement capteur, sans l'allumeur
- Erhältlich nur impulsgeber, ohne Zündverteiler
- Disponible solamente captador sin distribuidor

⁰³ Supplied until depletion

- Fornibile fino ad esaurimento delle scorte
- Fourni jusqu'à épuisement du stock
- Lieferbar solange vorrat reicht
- Suministrado hasta el stock termina



L	ohm	Pick-Up
---	800	Coil

OPEL			
ASCONA C 1.3 N	13N	09/81 ⇨	08/86
ASCONA C 1.6	165V	09/86 ⇨	08/88
CORSA A 1.2	12S, 12ST	09/82 ⇨	08/90
CORSA A 1.2 N	12NV	01/90 ⇨	03/93
CORSA A 1.2 S	12S, 12ST	09/82 ⇨	03/93
CORSA A 1.3	13NB, 13SB	09/85 ⇨	10/89
CORSA A 1.3 GL	13S	09/82 ⇨	03/93
CORSA A 1.3 S	13SB	09/82 ⇨	10/89
KADETT D 1.2	12ST	08/82 ⇨	08/84
KADETT E 1.3 N	13N, 13NB	09/84 ⇨	08/91
KADETT E 1.3 S	13S	09/84 ⇨	02/93
KADETT E 1.6	165V	09/86 ⇨	12/91
KADETT E 1.6 i	165V	07/89 ⇨	02/93
KADETT E 1.6 S	165V	09/86 ⇨	08/91

EPS 1.915.017



3,5

PICK-UPS

Adatt./Suitable: **DUCELLIER**

CITROËN

5904 K3
95 624 952

DUCELLIER

2 525 683 A *N
2 525 683 B *N
2 590 264
2 590 938

PEUGEOT

5904 K3
5904 K9

*N Available pick-up coil only-not the distributor assy

- Fornito solo impulsore, no lo spinterogeno completo
- Disponible seulement capteur, sans l'allumeur
- Erhältlich nur impulsgeber, ohne Zündverteiler
- Disponible solamente captador sin distribuidor

03 Supplied until depletion

- Fornibile fino ad esaurimento delle scorte
- Fourni jusqu'à épuisement du stock
- Lieferbar solange vorrat reicht
- Suministrado hasta el stock termina

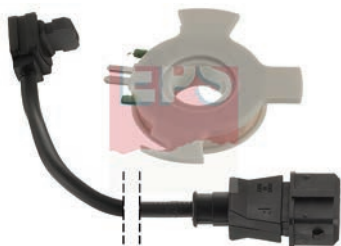

L	ohm	Pick-Up	
265	370	Coil	

CITROËN

BX 1.6	B2C	02/88 ⇒ 12/94
BX 1.9	159B, 159C, D6U, DKK	05/85 ⇒ 12/94
BX 1.9 GTi	D6D, D6K	01/87 ⇒ 01/92
BX 15	B1E(XU51C)	01/87 ⇒ 05/92
BX 16	171A, 171B, 171C, 171D, 23DH, B1E(XU51C), BAY(XU5CP), BAZ(XU5CP)	10/82 ⇒ 12/94
BX 19	159A, D2A(XU92C), D2C(XU92C), D2E, D6A(XU9J2), DKZ(XU9JA)	09/84 ⇒ 12/94
BX 19 Cat	DFZ(XU9J1)	07/86 ⇒ 12/94
BX 19 E 4x4	D2F	04/89 ⇒ 02/93
BX 19 GTi	D6A(XU9J2), DKZ(XU9JA)	07/86 ⇒ 02/93
BX 19 GTi 4x4	DKZ(XU9JA)	06/88 ⇒ 02/93

PEUGEOT

205 I 1.6	B1A(XU51C), B1E(XU51C), BAZ(XU5CP)	08/86 ⇒ 10/87
205 I 1.9 GTi	DFZ(XU9J1)	03/87 ⇒ 10/87
205 II 1.6	B1A(XU51C), B1E(XU51C), BAZ(XU5CP)	10/87 ⇒ 09/98
205 II 1.9 CTI	DFZ(XU9J1)	10/87 ⇒ 12/94
205 II 1.9 GTi Cat	DFZ(XU9J1)	10/87 ⇒ 07/94
309 I 1.6	B1A(XU51C), B1D(XU51C), B1E(XU51C)	10/85 ⇒ 07/89
309 I 1.6 Cat	BAZ(XU5CP)	09/86 ⇒ 12/89
309 I 1.9	D2B(XU9S), DFZ(XU9J1), XU92C	10/85 ⇒ 07/89
309 II 1.9	XU92C	07/89 ⇒ 12/93
405 I 1.9	DFZ(XU9J1)	05/88 ⇒ 08/92
405 I 1.9 Antipollution	XU92C	01/87 ⇒ 12/92
405 I 1.9 Injection	DFZ(XU9J1)	07/87 ⇒ 12/92
405 I 1.9 Trazione integrale	DFZ(XU9J1)	09/88 ⇒ 07/92

EPS 1.915.019



3

PICK-UPS

Adatt./Suitable: **DUCELLIER**

CITROËN

5900 F1 *N
5900 F6 *N
5900 F7 *N
5900 F8 *N
5900 F9 *N
5900 G2 *N
5900 H5 *N
5900 J3 *N
5900 K1 *N
5900 K7 *N
5900 K8 *N
5904 K8
95 624 987
95 643 723
96 001 914 *N
96 002 856 *N
96 004 266 *N
96 014 242 *N
96 020 587 *N
96 039 183 *N

DUCELLIER

2 525 765 A *N
2 590 945

FIAT

9564372380

PEUGEOT

5900 H1 *N
5900 H7 *N
5900 H9 *N
5900 J1 *N
5900 K3 *N
5900 K6 *N
5900 K7 *N
5904 K8
5904 L3
5904 P5

*N Available pick-up coil only-not the distributor assy

- Fornito solo impulsore, no lo spinterogeno completo
- Disponible seulement capteur, sans l'allumeur
- Erhältlich nur impulsgeber, ohne Zündverteiler
- Disponible solamente captador sin distribuidor

03 Supplied until depletion

- Fornibile fino ad esaurimento delle scorte
- Fourni jusqu'à épuisement du stock
- Lieferbar solange vorrat reicht
- Suministrado hasta el stock termina



L	ohm	Pick-Up	
---	370	Coil	

CITROËN

AX 1.3 Sport	M4A	04/87 ⇒ 12/88
AX 10	C1A	09/86 ⇒ 06/92
AX 10 E	C3A	12/86 ⇒ 12/88
AX 11	H1A, H1B, HDZ(TU1M)	09/86 ⇒ 12/97
AX 11 4x4	H1A	06/91 ⇒ 07/92
AX 11 Cat	HAZ(TU1CP)	09/88 ⇒ 12/89
AX 14	K1A(TU3), K1B, K1F, K1G, K1J, K2A, K2B, K2D, KAY(TU3CP), KDX(TU3M/Z), KDY(TU3FM), KDY(TU3M), KDZ(TU3M/Z)	09/86 ⇒ 04/97
AX 14 4x4	KD4, KDX(TU3M/Z), KDY(TU3FM), KDY(TU3M), KDZ(TU3M/Z)	06/91 ⇒ 12/96
AX 14 GT	KDZ(TU3M/Z)	01/89 ⇒ 12/91
BX 1.1	109LA, H1A	04/86 ⇒ 06/91
BX 1.4	150C, K1F, K2D	07/86 ⇒ 12/94
BX 1.4 E	150B(XY8), 150J, 150Y, K1F, KAZ	09/82 ⇒ 12/94
BX 1.6	B2C	02/88 ⇒ 12/94
BX 1.9	159B, 159C, D6U, DKK	05/85 ⇒ 12/94
BX 1.9 GTi	D6D, D6K	01/87 ⇒ 01/92
BX 14	150C, KDY(TU3M), KDZ(TU3M/Z)	01/86 ⇒ 02/93
BX 14 E	150A, 150C, K1G	10/82 ⇒ 02/93
BX 15	B1E(XU51C)	01/87 ⇒ 05/92
BX 16	171A, 171B, 171C, 171D, 23DH, B1E(XU51C), BAY(XU5CP), BAZ(XU5CP)	10/82 ⇒ 12/94
BX 19	159A, D2A(XU92C), D2C(XU92C), D2E, D6A(XU9J2), DKZ(XU9JA)	09/84 ⇒ 12/94
BX 19 Cat	DFZ(XU9J1)	07/86 ⇒ 12/94
BX 19 E 4x4	D2F	04/89 ⇒ 02/93
BX 19 GTi	D6A(XU9J2), DKZ(XU9JA)	07/86 ⇒ 02/93
BX 19 GTi 4x4	DKZ(XU9JA)	06/88 ⇒ 02/93
C15 1.0	108C(XV8), C1A, C1A(TU9/K), C1B(TU9/W), TU9	10/84 ⇒ 12/97
C15 1.1	H1A, HDZ(TU1M), TU1	08/88 ⇒ 07/96
C15 1.1 i	HDZ(TU1M), TU1M2	07/88 ⇒ 12/96

CITROËN

C15 1.4	K1A, K1G, K1H(TU3A), KDY(TU3M)	07/87 ⇒ 12/96
C15 1.4 E	K1F, K1J, K2D, K3A, KAZ	07/86 ⇒ 12/96
C15 1.4 i	KDY(TU3FM), KDY(TU3M)	05/91 ⇒ 12/96
JUMPER I 2.0	XU102C	02/94 ⇒ 02/02
XM I 2.0	--	05/89 ⇒ 04/94
XM I 2.0 i	RFZ(XU102)	05/89 ⇒ 06/94
BERLINGO I 1.4	TU32	07/96 ⇒ 10/98
ZX 1.1	H1A, H1B, HDZ(TU1M), TU1	03/91 ⇒ 06/97
ZX 1.4 i	KDY(TU3M)	10/93 ⇒ 10/97

FIAT

DUCATO II 2.0	--, R5B	03/94 ⇒ 12/95
---------------	---------	---------------

PEUGEOT

106 I 1.0	TU9	09/91 ⇒ 03/01
106 I 1.1	H1B(TU1), HDZ(TU1M)	08/91 ⇒ 04/96
106 I 1.4	K5A(TU3), KDY(TU3M), TU3.2	08/91 ⇒ 04/96
106 II 1.1	H1B(TU1)	04/96 ⇒
205 I 1.4	TU3	01/83 ⇒ 12/90
205 I 1.6	B1A(XU51C), B1E(XU51C)	08/86 ⇒ 10/87
205 II 1.0	TU9	10/87 ⇒ 09/98
205 II 1.1	H1B(TU1), HDZ(TU1M)	10/87 ⇒ 09/98
205 II 1.1 CJ	HDZ(TU1M)	10/89 ⇒ 12/94
205 II 1.4	K1D(TU3A), K2B(TU3S), KDY(TU3M), KDZ(TU3M)	06/87 ⇒ 09/98
205 II 1.4 CJ	K1D(TU3A), KDY(TU3M)	03/89 ⇒ 12/94
205 II 1.6	B1A(XU51C), B1E(XU51C)	10/87 ⇒ 09/98
306 1.4	TU3	01/93 ⇒ 04/02
309 I 1.4	K1D(TU3A), K2B(TU3S), KDY(TU3M), KDZ(TU3M)	08/88 ⇒ 08/89
309 II 1.1	H1B(TU1), HDZ(TU1M)	09/89 ⇒ 12/93
309 II 1.4	KDZ(TU3M), TU3, TU3F2	07/89 ⇒ 12/93
309 II 1.6	18EM, BDZ(XU5M)	07/89 ⇒ 12/93
309 II 1.9	DDZ(XU9M), XU92C	07/89 ⇒ 12/93
405 I 1.4	K5A(TU3), TU3A, TU3F2	01/87 ⇒ 12/92
405 I 1.6	--, 18EM, B1E(XU51C)	01/87 ⇒ 12/92
405 I 1.9	D2C(XU92C)	07/87 ⇒ 12/92
405 II 1.4	TU3F2	01/93 ⇒ 12/96
405 II 1.6	18EM	08/92 ⇒ 05/97
405 II 1.9	XU92C	01/93 ⇒ 12/96
605 2.0	R5A(XU102C)	06/89 ⇒ 09/99
BOXER I 2.0	R5B(XU102C)	02/94 ⇒ 02/02
RANCH 1.4	K5A(TU3.2)	09/96 ⇒ 08/02

EPS 1.928.202



3,5

PICK-UPS

Adatt./Suitable: **LUCAS**

GENERAL MOTORS

90 346 324 *N

OPEL

12 11 006 *N

*N Available pick-up coil only-not the distributor assy

- Fornito solo impulsore, no lo spinterogeno completo
- Disponible seulement capteur, sans l'allumeur
- Erhältlich nur impulsgeber, ohne Zündverteiler
- Disponible solamente captador sin distribuidor



L	ohm	Pick-Up
---	---	Hall

OPEL

ASTRA F 1.4 i	C14NZ	09/91 ⇒ 01/05
CORSA A 1.2 i	C12NZ	09/89 ⇒ 03/93
CORSA A 1.6 GSI	E16SE	05/88 ⇒ 03/92

VAUXHALL

ASTRA III 1.4 i	C14NZ	09/91 ⇒ 09/98
ASTRAVAN I 1.4 i	C14NZ	09/91 ⇒ 08/95



PICK-UPS

Adatt./Suitable: **MARELLI****ABARTH**
9939762

*N Available pick-up coil only-not the distributor assy

FIAT
9934729
9939762

• Fornito solo impulsore, no lo spinterogeno completo

LANCIA
9934729

• Disponible seulement capteur, sans l'allumeur

MAGNETI MARELLI
071319801010
610 800 24 *N
712 160 01
713 198 01• Erhältlich nur impulsgeber, ohne Zündverteiler
• Disponible solamente captador sin distribuidor

03 Supplied until depletion

- Fornibile fino ad esaurimento delle scorte
- Fourni jusqu'à épuisement du stock
- Lieferbar solange vorrat reicht
- Suministrado hasta el stock termina



L	ohm	Pick-Up
700	730	Coil

ABARTH

RITMO 125 TC 2.0 138AR1.000 11/81 ⇨ 12/87

FIAT

132 2.0 132C2.000 01/76 ⇨ 06/81

RITMO II 105 1.6 138AR.000 01/83 ⇨ 12/87

LANCIA

A 112 1.0 Abarth A112A2.000 03/78 ⇨ 02/84



PICK-UPS

Adatt./Suitable: **MARELLI****FIAT**
9936331

*N Available pick-up coil only-not the distributor assy

LANCIA
9936331

• Fornito solo impulsore, no lo spinterogeno completo

MAGNETI MARELLI
071319804010
712 160 03
713 198 04
SM 807 AX *N• Disponible seulement capteur, sans l'allumeur
• Erhältlich nur impulsgeber, ohne Zündverteiler
• Disponible solamente captador sin distribuidor

03 Supplied until depletion

- Fornibile fino ad esaurimento delle scorte
- Fourni jusqu'à épuisement du stock
- Lieferbar solange vorrat reicht
- Suministrado hasta el stock termina



L	ohm	Pick-Up
780	730	Coil

FIAT

124 Spider, Sport [USA] -- 01/79 ⇨ 12/86

131 2.0 Brava [USA] -- 01/79 ⇨ 12/84

LANCIA

BETA 1600 828B.000 08/73 ⇨ 07/82



PICK-UPS

Adatt./Suitable: **MARELLI****FIAT**
9939788
9941231
9941693

*N Available pick-up coil only-not the distributor assy

INNOCENTI
9941693

• Fornito solo impulsore, no lo spinterogeno completo

LANCIA
9939788

• Disponible seulement capteur, sans l'allumeur

MAGNETI MARELLI
713 284 01
713 473 01
713 491 01• Erhältlich nur impulsgeber, ohne Zündverteiler
• Disponible solamente captador sin distribuidor

03 Supplied until depletion

- Fornibile fino ad esaurimento delle scorte
- Fourni jusqu'à épuisement du stock
- Lieferbar solange vorrat reicht
- Suministrado hasta el stock termina

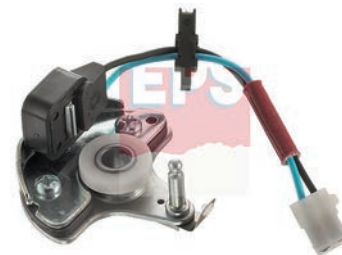

L	ohm	Pick-Up
---	830	Coil

FIAT

DUNA 60 1.1 146A6.000 01/87 ⇨ 12/91

DUNA 70 1.3 146A5.000 01/87 ⇨ 12/91

ELBA 1.3 146A5.000 04/91 ⇨ 02/95

FIORINO I 1.1 60 146A9.000 11/86 ⇨ 04/88

FIORINO I 1.3 146A5.000 12/87 ⇨ 08/93

FIORINO II 1.3 146A5.000 01/88 ⇨ 12/94

FIORINO II 60 1.1 146A9.000 05/88 ⇨ 12/93

FIORINO II 70 1.3 146A5.000 01/88 ⇨ 12/94

REGATA 70 1.3 138B2.000, 149A3.000 09/83 ⇨ 07/89

RITMO I 1.3 149A3.000 11/83 ⇨ 08/85

TEMPRA 1.4 i.e. 159A2.000 04/90 ⇨ 08/96

TIPO I 1.4 160A1.000 07/87 ⇨ 12/89

TIPO I 1.4 i.e. 159A2.000 05/89 ⇨ 04/95

UNO 60 1.1 146A4.048, 146A6.000 02/88 ⇨ 02/92

UNO 60 1.1 SX -- 01/85 ⇨ 12/89

UNO CS 1.1 146A6.000 09/87 ⇨ 09/91

FIAT (BR)

UNO CS 1116 -- 01/88 ⇨

INNOCENTI

ELBA 1.3 146A5.000 08/91 ⇨ 12/96

LANCIA

DELTA I 1.1 831B8.000 01/86 ⇨ 12/90

DELTA I 1.3 1831B.000, 3831B.000, 831A2.000, 831B.000 09/79 ⇨ 10/92

PRISMA 1.3 831A2.000 01/83 ⇨ 12/89

1.930.177/1

EPS 1.930.177/1



3

PICK-UPS

Adatt./Suitable: MARELLI

FIAT

9940429

FORD

1 641 614

INNOCENTI

9940429

LANCIA

9940429

MAGNETI MARELLI

610 453 24 *N

713 269 01

*N Available pick-up coil only-not the distributor assy

- Fornito solo impulsore, no lo spinterogeno completo
- Disponible seulement capteur, sans l'allumeur
- Erhältlich nur impulsgeber, ohne Zündverteiler
- Disponible solamente captador sin distribuidor

03 Supplied until depletion

- Fornibile fino ad esaurimento delle scorte
- Fourni jusqu'à épuisement du stock
- Lieferbar solange vorrat reicht
- Suministrado hasta el stock termina



L	ohm	Pick-Up
---	830	Coil

FIAT

COUPE 2.0 16V	836A3.000	11/93 → 08/96
COUPE 2.0 16V [BRA]	836A3.011	11/93 → 08/96
CROMA I 2000 i.e.	154C3.000, 834B.000, 834B.048	03/86 → 09/92
FIORINO II 1.6	146C6.000	01/94 → 05/01
FIORINO II 75 i.e. 1.6	146C6.000	10/93 → 05/01
REGATA 90 i.e. 1.6	149C2.000	01/87 → 07/89
TEMPRA 1.4 i.e.	160A1.046	04/90 → 08/96
TEMPRA 1.6	159A3.000, 159A3.048, 159A3.098	04/90 → 12/96
TEMPRA 1.6 i.e.	159A3.048	06/92 → 08/96
TEMPRA 1.8 4x4	159A4.000	07/92 → 06/93
TEMPRA 1.8 i.e.	159A4.000, 159A4.046	03/90 → 08/96
TEMPRA 2.0	159A6.046	04/90 → 06/93
TEMPRA 2.0 i.e.	159A6.046	10/90 → 09/96
TEMPRA 2.0 i.e. [BRA]	159A6.011	04/93 → 12/96
TEMPRA 2.0 i.e. 4x4	159A6.046	03/92 → 03/95
TIPO I 1.6	159A3.048	03/93 → 10/95
TIPO I 1.6 i.e.	159A3.048	10/92 → 04/95
TIPO I 1.8 i.e.	159A4.000, 159A4.046	10/90 → 06/93
TIPO I 1.8 i.e. 16V Sport	160A5.000	11/89 → 06/92
TIPO I 2.0	159A5.046, 159A6.046, 836A3.011	10/90 → 04/95
TIPO I 2.0 16V	160A8.046	07/91 → 04/95
TIPO I 2.0 i.e.	159A5.046, 159A6.046	03/90 → 04/95
TIPO I 2.0 i.e. [BRA]	159A6.011	03/93 → 10/95
TIPO I 2.0 i.e. 16V Sport	836A3.000	03/93 → 04/95

FIAT (BR)

COUPÉ 2.0i 16V	2.0Mpi	01/95 → 12/97
TIPO 2.0i 16V	2.0Mpi	01/94 → 12/95
TIPO 2.0i 8v	2.0Mpi	01/94 → 12/95

INNOCENTI

ELBA 1.6 i.e.	146C6.000	09/94 → 12/96
---------------	-----------	---------------

LANCIA

DEDRA 1.8 i.e.	835A2.000, 835A2.046, 835C5.000	09/89 → 07/99
DEDRA 2.0 16V	836A3.000	07/94 → 07/99
DEDRA 2.0 HF Integrale	835A7.046	11/90 → 07/94
DEDRA 2.0 i.e.	835A5.000, 835A5.046	09/89 → 07/99
DEDRA 2.0 i.e. Turbo	835A8.046	04/91 → 07/99
DEDRA 2.0 i.e. Turbo Integrale	835A7.000	04/90 → 08/91
DEDRA 2.0 Integrale	836A3.000	07/94 → 07/99
DEDRA 2.0 Turbo	835A8.000	11/90 → 06/94
DELTA I 1.6 GT i.e.	149C2.000, 831B7.000	08/86 → 08/92
DELTA I 1.6 HF Turbo	831B3.000, 831B7.046	08/86 → 03/89

LANCIA

DELTA I 2.0 16V HF Evo Integrale	831E5.000	06/93 → 01/94
DELTA I 2.0 16V HF Integrale	831D5.000	03/89 → 09/91
DELTA I 2.0 HF Integrale	831B5.000, 831C5.000, 831C5.046	11/86 → 12/92
DELTA II 1.4 i.e.	160A1.046	10/94 → 08/99
DELTA II 2.0 16V	836A3.000	06/93 → 08/99
PRISMA 1.6 i.e.	831B7.000	05/86 → 12/89
PRISMA 2.0 i.e. Trazione integrale	831B4.000	04/86 → 12/89

EPS 1.930.178M



04

PICK-UPS

Adatt./Suitable: MARELLI

PEUGEOT

5904 F1

03 Supplied until depletion

- Fornibile fino ad esaurimento delle scorte
- Fourni jusqu'à épuisement du stock
- Lieferbar solange vorrat reicht
- Suministrado hasta el stock termina

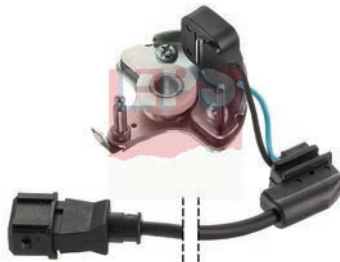

L	ohm	Pick-Up
800	830	Coil



PEUGEOT

505 2.0	106E(XN1A)	09/85 → 09/95
---------	------------	---------------

EPS

1.930.180M



3,5

PICK-UPS

Adatt./Suitable: MARELLI

FIAT

9939786

9941720

LANCIA

9939786

MAGNETI MARELLI

611 101 03 *N

611 101 26 *N

713 277 01

713 474 01

PIAGGIO

498325

*N Available pick-up coil only-not the distributor assy

- Fornito solo impulsore, no lo spinterogeno completo
- Disponible seulement capteur, sans l'allumeur
- Erhältlich nur impulsgeber, ohne Zündverteiler
- Disponible solamente captador sin distribuidor

03 Supplied until depletion

- Fornibile fino ad esaurimento delle scorte
- Fourni jusqu'à épuisement du stock
- Lieferbar solange vorrat reicht
- Suministrado hasta el stock termina



L	ohm	Pick-Up
---	830	Coil

FIAT

FIORINO II 1.0 iE	156A2.246	11/92 → 04/96
PALIO 1.1	178B9.033	07/97 → 10/03
PANDA I 1.1	156C.046	05/91 → 03/95
PANDA I 1000	156A2.100, 156A3.000	01/85 → 12/92
PANDA I 1000 4x4	156A2.100, 156A2.246, 156A3.000	01/86 → 12/94
PANDA I 1000 Fire [CHE]	156A2.146	11/87 → 04/91
PANDA I 1000 Fire [DEU]	156A2.048	01/86 → 07/89
PANDA I 1000 i.e.	156A2.246	08/92 → 02/04
PANDA I 1000 i.e. Cat	156A2.246	10/87 → 08/98
PANDA I 1100 i.e.	156C.046	01/86 → 04/91
PANDA I 1100 Trekking 4x4	156C.046	10/91 → 07/04
PANDA I 750 Cat	156A4.048	01/95 → 10/03
PANDA I 750 Fire	156A4.048	11/88 → 04/91
TIPO I 1.1	160A3.000	01/88 → 10/91
UNO 1.0	146A2.166	11/94 → 08/00
UNO 45 1.0	156A2.000, 156A2.100	06/86 → 12/93
UNO 45 1.0 Fire	--	01/83 → 12/89
UNO 45 i.e. 1.0	156A2.246	10/84 → 10/95
UNO 50 1.1	156C.046	01/90 → 12/93
UNO 50 i.e. 1.1	146C3.000	06/92 → 12/93
UNO 60 1.1	160A3.000	04/89 → 12/92
UNO Mondo 1.0	146A2.166	01/98 →
UNO Mondo 1.0 [IND]	146A2.166	01/98 →

LANCIA

Y10 1.0 Fire	156A2.100	06/85 → 06/91
Y10 1.0 Fire Catalytic-Conv	156A2.246	10/87 → 02/92
Y10 1.0 Fire Trazione integrale	156A2.000, 156A2.100, 156A2.246	12/86 → 02/92
Y10 1.1 i.e. Fire	156C.000	08/89 → 06/92
Y10 1.1 i.e. Fire Trazione integrale	156C.000	08/89 → 06/92
Y10 1.1 i.e. Fire	156C.046	07/89 → 09/95

PICK-UPS

Adatt./Suitable: **MARELLI****MAGNETI MARELLI**
DT 458 BX *N**SEAT**

030 905 205 AE *N

VW

030 905 205 AE *N

***N Available pick-up coil only-not the distributor assy**

- Fornito solo impulsore, no lo spinterogeno completo
- Disponible seulement capteur, sans l'allumeur
- Erhältlich nur impulsgeber, ohne Zündverteiler
- Disponible solamente captador sin distribuidor

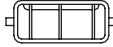

L	ohm	Pick-Up	
---	---	Hall	

SEAT

CORDOBA 1.0 i	AER	09/96 ⇨ 10/02
CORDOBA 1.4	ANX	12/97 ⇨ 04/99
CORDOBA 1.4 i	AKV, APQ	06/94 ⇨ 12/02
CORDOBA 1.4 i 16V	AFH	09/96 ⇨ 10/02
CORDOBA 1.6 i	AEE, ALM	02/93 ⇨ 12/02

VW

GOLF III 1.4	AEX, AEX	10/91 ⇨ 04/99
GOLF III 1.6	AEE	09/92 ⇨ 08/97





MODULES

-MODULI -MODULES -MODULE -MODULOS

(A) P/NRS. - NOTES

- CODICI - NOTE
- RÉFS. - NOTES
- ARTIKEL-NR. - ANMERKUNGEN
- CODIGOS - NOTAS

1.965.076 **3,5**

IGNITION MODULES

Adatt./Suitable:

AUDI
4D0 905 351

BOSCH
0 227 100 030
0 227 100 211
0 227 100 212

SEAT
4D0 905 351

SKODA
4D0 905 351

VW
4D0 905 351

03 Supplied until depletion

- Fornibile fino ad esaurimento delle scorte
- Fourni jusqu'à épuisement du stock
- Lieferbar solange vorrat reicht
- Suministrado hasta el stock termina

1114 Supplied with heat conducting silicone grease capsule

- Fornito con capsula di grasso termico al silicone
- Fourni avec capsule contenant graisse thermique au silicone
- Geliefert mit Thermo-Silikonfettkapsel
- Suministrado con capsula de grasa termica de silicona

(A)

1 # EPS

2 OEM P/NRS.

- CODICI ORIGINALI
- RÉFS. D'ORIGINE
- ORIGINALTEILE-NR.
- CODIGOS ORIGINALES

3 PACKAGING SIZE

- FORMATO CONFEZIONE
- FORMAT DU CONDITIONNEMENT
- ABPACKENSGROESSE
- TAMAÑO DEL ENVASE

4 NOTE

- NOTE
- NOTES
- BERMERKUNGEN
- NOTAS

(B) PICTURE + TECHNICAL INFO

- FOTO + INFORMAZIONE TECNICA
- ILLUSTRATION + INFORMATION TECHNIQUE
- BILD + TECHNISCHE INFO
- FOTO + INFORMACIÓN TÉCNICA



(C) APPLICATION LIST

- GUIDA APPLICAZIONI
- LISTE D'APPLICATIONS
- ANWENDUNGSTABELLE
- LISTA DE APLICACIONES

AUDI		
A3 I 1.8 T	AGU	12/96 ⇒ 05/03
A3 I 1.8 T quattro	AGU	12/96 ⇒ 05/03
A4 I 1.8 T	AEB	01/95 ⇒ 09/01
A4 I 1.8 T quattro	AEB	01/95 ⇒ 09/01
A4 II 1.8 T	AVJ	11/00 ⇒ 07/02
A4 II 1.8 T quattro	AVJ	11/00 ⇒ 07/02
A6 I S6 Plus quattro	AHK	04/96 ⇒ 12/97
A6 II 1.8 T	AEB	01/97 ⇒ 01/05
A6 II 1.8 T quattro	AEB	02/97 ⇒ 01/05
A8 I 3.7	AEW, AKJ	07/95 ⇒ 12/98
A8 I 3.7 quattro	AEW, AKJ	07/95 ⇒ 11/98
A8 I 4.2 quattro	ABZ, AEM, AGH, AKG	03/94 ⇒ 11/98
A8 I S8 quattro	AHC, AKH	07/96 ⇒ 06/99
SEAT		
ALHAMBRA I / II 1.8 T 20V	AJH	10/97 ⇒ 03/10
LEON I 1.8 20V T	APP	11/99 ⇒ 06/06
SKODA		
OCTAVIA I 1.8 T	AGU, ARX, AUM	08/97 ⇒ 12/10
OCTAVIA I 1.8 T 4x4	ARX	05/01 ⇒ 05/06
OCTAVIA I RS 1.8 T	AUQ	05/01 ⇒ 01/06

(B)

1 PICTURE

- FOTO
- PHOTO
- BILD
- FOTO

EPS 1.965.004



3,5

IGNITION MODULES

Adatt./Suitable:

AUDI
 211 905 351

1114 Supplied with heat conducting silicone grease capsule
BMW
 12 14 1 244 089
 12 14 1 244 191
 12 14 1 244 477

- Fornito con capsula di grasso termico al silicone
- Fourni avec capsule contenant graisse termique au silicone
- Geliefert mit Thermo-Silikonfettkapsel
- Suministrado con capsula de grasa termica de silicona

BOSCH
 0 227 100 100
 0 227 100 101
 0 227 100 103
 0 227 100 104
 0 227 100 113
 0 227 100 118
 0 227 100 137
 0 227 100 138
 0 227 100 139
 1 227 022 008

GENERAL MOTORS
 90 008 145
 90 114 676
 90 140 187

LADA
 2108-3734910-10
 3700-3118583

MAGNETI MARELLI
 940038500010

OPEL
 12 08 241
 12 08 246

SAAB
 93 90 220

SCANIA
 2573826

SEAT
 SE 021913.010A

SIEMENS
 2576 12.70.01
 5WK 6105

TELEFUNKEN
 318 738
 335 622
 339 109

VAUXHALL
 90006145
 90114676
 90140187

VW
 211 905 351
 211 905 351 A
 211 905 351 B
 211 905 351 D
 211 905 351 E

HALL TYPE MODULE

AUDI		
80 II 1.6	WV	08/78 ⇒ 07/86
80 III 1.8 quattro	SD	09/86 ⇒ 08/90
80 III 1.8 S quattro	JN	09/86 ⇒ 09/91
90 II 2.2 E quattro	9C54	04/87 ⇒ 09/91
100 III 1.8	DR	08/82 ⇒ 12/87
100 III 1.9	WH	08/82 ⇒ 07/84
100 III 2.2	KZ	10/84 ⇒ 09/86
200 II 2.2	KU	08/84 ⇒ 07/85
COUPE 2.2 GT	9C54	09/84 ⇒ 10/88
COUPE 2.2 quattro	9C54, JT	10/84 ⇒ 10/88

OPEL		
KADETT E 1.6 S	16S	09/84 ⇒ 08/86
KADETT E 1.8	18SE	01/86 ⇒ 08/91
KADETT E 1.8 GSI	18E	09/84 ⇒ 08/86
KADETT E 1.8 i	18E	09/84 ⇒ 08/86

SAAB		
90 2.0	B20I	08/84 ⇒ 08/87
900 I 2.0-16	B202XI	01/86 ⇒ 12/88
900 I 2.0 c	B201XC	09/79 ⇒ 12/88
900 I 2.0 i	0TLE4G15, B201XI	11/80 ⇒ 08/90
900 I 2.0 Turbo	B201XL	01/86 ⇒ 12/91
900 I 2.0 Turbo-16	B202L, B202XL	11/85 ⇒ 06/94
900 I 2.0 Turbo-16 S	B202XL	01/84 ⇒ 06/94
900 I 2.0 Turbo-16 S Cat	B202XL	01/89 ⇒ 12/93
9000 2.0-16 Turbo	B202XL	09/84 ⇒ 08/93
9000 2.0-16 Turbo CD	B202XL	09/88 ⇒ 08/93

VW		
PASSAT II 1.3	79SU16	08/80 ⇒ 07/86
PASSAT II 1.6	DT	08/80 ⇒ 03/88
PASSAT II 1.8	DS	01/83 ⇒ 03/88
PASSAT II 1.8 Syncro	DS	01/86 ⇒ 03/88
PASSAT II 1.9	WN	01/81 ⇒ 07/83
PASSAT II 2.0	JS	08/83 ⇒ 03/88
PASSAT II 2.0 Syncro	JS	05/84 ⇒ 03/88
PASSAT II 2.2	KX	01/85 ⇒ 03/88
POLO II 1.0	HZ	01/85 ⇒ 09/94
POLO II 1.3	MH	08/83 ⇒ 07/88
POLO II 1.3 Cat	MH, NZ	07/87 ⇒ 09/94
DERBY 1.3	GK, HK	09/82 ⇒ 12/84
QUANTUM 2.1	--	01/81 ⇒ 12/89
SANTANA 1.6	DT	08/81 ⇒ 12/84
SANTANA 1.8	DS	01/83 ⇒ 12/84
SANTANA 1.9	WN	08/81 ⇒ 07/83
SANTANA 2.0	JS	08/83 ⇒ 12/84
SCIROCCO II 1.3	GF	08/80 ⇒ 12/83

EPS 1.965.005



3,5

IGNITION MODULES

Adatt./Suitable:

ALFA ROMEO
 60750065

03 Supplied until depletion
BMW
 12 14 1 266 702
 12 14 1 273 217
 12 14 1 273 298
 12 14 1 274 698

- Fornibile fino ad esaurimento delle scorte
- Fourni jusqu'à épuisement du stock
- Lieferbar solange vorrat reicht
- Suministrado hasta el stock termina

BOSCH
 0 227 100 102
 0 227 100 110
 0 227 100 111
 0 227 100 112
 0 227 100 123

1114 Supplied with heat conducting silicone grease capsule
CITROËN
 5945 48
 91 504 912
 91 506 338
 97 522 876
 97 530 125
 97 531 922
 97 532 831

- Fornito con capsula di grasso termico al silicone
- Fourni avec capsule contenant graisse termique au silicone
- Geliefert mit Thermo-Silikonfettkapsel
- Suministrado con capsula de grasa termica de silicona

DUCELLIER
 521 008
 521 013
 594 525
 2 528 008 A
 7 350 370 2

FIAT
 9753012580
 9753283180
 9753293180

GENERAL MOTORS
 90 295 499

MAGNETI MARELLI
 648 330 20
 BKL 2 A
 MTR 01

OPEL
 12 08 248

PEUGEOT
 5927 90
 5945 02
 5945 03
 5945 25
 5945 31
 5945 33
 5945 39
 5945 48

SIEMENS
 17-5607

TALBOT
 0057 18 9700
 9150 49 1280
 9150 63 3880

ALFA ROMEO

33 I 1.3	AR30168	10/84 ⇒ 12/89
33 I 1.3 i.e.	AR30168	05/83 ⇒ 12/89
33 I 1.5 4x4	AR30508	12/86 ⇒ 03/89

BMW		
3 II 316	M10B18(184VC), M10B18(184VD)	09/83 ⇒ 06/88
3 II 323 i	M20B23(236EC)	09/82 ⇒ 09/86
3 I 315	M10B16(164VB)	03/81 ⇒ 03/84
5 II 518	M10B18(184VC), M10B18(184VD)	06/81 ⇒ 09/84



BMW		
5 II 520 i	M20B20(206EA), M20B20(206KA)	06/81 ⇒ 12/87
5 II 525 i	M30B25(256EA)	06/81 ⇒ 12/87
5 II 528 i	M30B28(286EA)	06/81 ⇒ 12/87
5 II 528 i [USA]	--	01/81 ⇒ 12/87
5 I 518	M10B18(184VB)	07/74 ⇒ 05/81
6 I 628 CSi	M30B28	09/79 ⇒ 08/87
6 I 633 CSi	05U18	10/75 ⇒ 08/84
6 I 635 CSi	M30B35(Motronic, 9.3:1)	06/78 ⇒ 04/82
7 I 728	M30B28	05/77 ⇒ 08/79
7 I 728 i	M30B28	09/77 ⇒ 08/86
7 I 730	M30B30	05/77 ⇒ 08/79

CITROËN		
AXEL 11	--	01/84 ⇒ 03/91
BX 1.1	109LA, H1A	04/86 ⇒ 06/91
BX 1.4	150C, K1F, K2D	07/86 ⇒ 12/94
BX 1.4 E	150B(XY8), 150J, 150Y, K1F, KAZ	09/82 ⇒ 12/94
BX 1.6	182A, B2C, B6D, B6E	01/87 ⇒ 12/94
BX 1.9	159B, 159C, D6U, DKK	05/85 ⇒ 12/94
BX 1.9 GTi	D6D, D6K	01/87 ⇒ 01/92
BX 1.9 GTi 16V	159K, DFK	01/87 ⇒ 12/94
BX 14	150C	01/86 ⇒ 02/93
BX 14 E	150A, 150C, K1G	10/82 ⇒ 02/93
BX 15	B1E(XU51C)	01/87 ⇒ 05/92
BX 16	171A, 171B, 171C, 171D, 180Z, 23DH, B1E(XU51C), BAY(XU5CP), BAZ(XU5CP)	10/82 ⇒ 12/94
BX 19	159A, D2A(XU92C), D2C(XU92C), D2E, D6A(XU9J2), DKZ(XU9JA)	09/84 ⇒ 12/94
BX 19 Cat	DFZ(XU9J1)	07/86 ⇒ 12/94
BX 19 E 4x4	D2F	04/89 ⇒ 02/93
BX 19 GTi	D6A(XU9J2), DKZ(XU9JA)	07/86 ⇒ 02/93
BX 19 GTi 16V	D6C(XU9J4), DFU(XU9J4)	09/87 ⇒ 02/93
BX 19 GTi 4x4	DKZ(XU9JA)	06/88 ⇒ 02/93
C15 1.0	108C	10/84 ⇒ 07/88
C15 1.0 E	TU9K	11/92 ⇒ 07/96
C15 1.1	109K, E1A, XW7	10/84 ⇒ 12/96
C15 1.3	G1A	07/87 ⇒ 05/88
C15 1.4	150D(XY7)	05/87 ⇒ 10/92
C15 1.4 E	150D(XY7)	05/87 ⇒ 12/96
CX II 20 RE	829A5	08/85 ⇒ 12/92
CX II 22 TRS	J6TA500	07/85 ⇒ 12/92
GS A 1.3	G13/625	07/78 ⇒ 07/86
XMI 2.0 i	RDZ(XU10MZ)	05/89 ⇒ 04/94
LNA 1.1	109/5E	07/82 ⇒ 04/85
VISA 11 E	109K	09/78 ⇒ 06/88
ZX 1.9	D6E(XU9JA)	03/91 ⇒ 06/97
ZX 1.9 i	DKZ(XU9JA), XU9JA	03/91 ⇒ 06/97

FIAT		
DUCATO I 1.8	169B	01/82 ⇒ 12/88
DUCATO I 2.0	170B, 170D, 170C(XN1T), XN1T	01/82 ⇒ 05/94
DUCATO I 2.0 4x4	170D	06/90 ⇒ 05/94
TALENTO 2.0	170B	03/89 ⇒ 03/94

OPEL		
ASTRA F 1.4	14NV	09/91 ⇒ 09/93
CORSA A 1.2	12NC, E12GV	09/82 ⇒ 08/90
CORSA A 1.2 N	12NC, E12GV	01/85 ⇒ 10/87
CORSA A 1.4 S	14NV	09/89 ⇒ 03/93
KADETT E 1.4 S	14NV	07/89 ⇒ 02/93
VECTRA A 1.4 S	14NV	04/88 ⇒ 06/92

PEUGEOT		
104 1.0	108C(XV8)	09/83 ⇒ 06/88
205 I 1.0	108C(XV8)	02/83 ⇒ 12/90
205 I 1.1	109F(XW7), 109N(XW7)	02/83 ⇒ 10/87
205 I 1.3	G1A	02/84 ⇒ 10/87
205 I 1.4	150(XY6B), 150B(XY8), 150D(XY7), 150G(XY7), 150H(XY8), J2	01/83 ⇒ 12/90
205 I 1.5	Y2/K	02/84 ⇒ 10/87
205 I 1.6	B1A(XU51C), B1E(XU51C), BAZ(XU5CP)	08/86 ⇒ 10/87
205 I 1.6 GTI	180A(XU5J), B6D(XU5JA), XU5J1	01/83 ⇒ 12/90
205 I 1.9 GTI	D6B(XU9JA), DFZ(XU9J1)	10/86 ⇒ 10/87
205 II 1.1	109N(XW7)	10/87 ⇒ 10/90
205 II 1.1 XA	E1	07/87 ⇒ 10/88
205 II 1.2	F1	01/87 ⇒ 12/90
205 II 1.3	G1A	08/90 ⇒ 07/92
205 II 1.4	150(XY6B), 150B(XY8), 150D(XY7), 150G(XY7), 150H(XY8), J2	01/87 ⇒ 12/94
205 II 1.4 CJ	150D(XY7), 150G(XY7)	03/88 ⇒ 05/89
205 II 1.4 CT	150B(XY8), 150H(XY8)	04/86 ⇒ 12/88
205 II 1.6	B1A(XU51C), B1E(XU51C), BAZ(XU5CP)	10/87 ⇒ 09/98
205 II 1.6 CTI	180A(XU5J), 180Z(XU5J)	03/86 ⇒ 10/90
205 II 1.6 GTI	180A(XU5J), 180Z(XU5J), XU5JA	10/87 ⇒ 12/94
205 II 1.9 CTI	DFZ(XU9J1)	10/87 ⇒ 12/94

PEUGEOT		
205 II 1.9 GTI	D6B(XU9JA), DKZ(XU9JAZ)	10/87 ⇒ 09/98
205 II 1.9 GTI Cat	DFZ(XU9J1)	10/87 ⇒ 07/94
305 1.5	117(XRS5)	05/80 ⇒ 09/82
309 I 1.1	E1	10/85 ⇒ 07/89
309 I 1.3	G1A, G2S	10/85 ⇒ 08/89
309 I 1.3 XL	--	09/86 ⇒ 08/89
309 I 1.5	Y2/K	06/87 ⇒ 12/89
309 I 1.6	--, 180Z(XU5J), B1A(XU51C), B1D(XU51C), B1E(XU51C), B6B(XU5J), J2, XU5JA	10/85 ⇒ 07/89
309 I 1.6 Cat	BAZ(XU5CP)	09/86 ⇒ 12/89
309 I 1.9	D2B(XU9S), DFZ(XU9J1), XU92C	10/85 ⇒ 07/89
309 I 1.9 GTI	D6B(XU9JA)	10/86 ⇒ 07/89
309 II 1.6	18EM, J2, XU5JA	07/89 ⇒ 12/93
309 II 1.6 GTI	--	09/89 ⇒ 10/93
309 II 1.9	XU92C	07/89 ⇒ 12/93
309 II 1.9 GTI	DKZ(XU9JAZ)	07/89 ⇒ 12/93
309 II 1.9 GTI 16V	D6C(XU9J4)	08/89 ⇒ 07/90
405 I 1.6	B1E(XU51C), BDZ(XU5M)	07/87 ⇒ 12/92
405 I 1.6 4x4	BDZ(XU5M)	04/88 ⇒ 07/92
405 I 1.6 SRI 4x4	BDZ(XU5M)	04/88 ⇒ 07/92
405 I 1.9	D6C(XU9J4), DFZ(XU9J1), DKZ(XU9JAZ), XU9J2, XU9J2/D6D	01/87 ⇒ 12/92
405 I 1.9 4x4	D6C(XU9J4), DKZ(XU9JAZ)	06/87 ⇒ 07/92
405 I 1.9 Antipollution	XU92C	01/87 ⇒ 12/92
405 I 1.9 Injection	DFZ(XU9J1)	07/87 ⇒ 12/92
405 I 1.9 Sport MI-16	D6C(XU9J4), DFW(XU9J4Z)	06/87 ⇒ 11/92
405 I 1.9 Sport MI-16 4x4	DFW(XU9J4Z)	06/87 ⇒ 07/92
405 I 1.9 Trazione integrale	D6C(XU9J4), DFZ(XU9J1)	06/87 ⇒ 07/92
505 2.0	106E(XN1A)	09/85 ⇒ 09/95
505 2.0 TI, STI	829(ZEJ)	08/79 ⇒ 10/86
505 2.1 i	XN9T	01/83 ⇒ 12/88
505 2.2	851(ZDJ), 851X(ZDJL)	05/81 ⇒ 12/93
505 2.2 GTI	851B(ZDJL)	08/83 ⇒ 12/93
J5 1.8	169B(XM7T)	01/83 ⇒ 11/88
J9 2.0	XN1P	03/80 ⇒ 06/87
VAUXHALL		
ASTRA III 1.4	14NV	09/91 ⇒ 09/93
ASTRA III 1.4 S	14NV	09/91 ⇒ 02/98

EPS 1.965.007



3,5

IGNITION MODULES

Adatt./Suitable:

AUDI

191 905 351 B

BOSCH

0 227 100 142

0 227 100 143

0 227 100 147

SAAB

89 80 534

SEAT

191 905 351 B

TELEFUNKEN

339 373

VW

191 905 351 A

191 905 351 B

Eliminated on 28-06-2021. Please verify the availability through our local distributors

• Eliminato il 28-06-2021. Verificare la disponibilità presso i nostri distributori

• Eliminé le 28-06-2021. Vérifier la disponibilité auprès de nos distributeurs sur place

• Am 28-06-2021 gestrichen. Evtl. Verfügbarkeit bitte bei unseren Händlern prüfen

• Eliminado en fecha 28-06-2021. Verificar la disponibilidad a través de nuestros distribuidores locales



HALL TYPE MODULE

AUDI		
80 II 1.3	DT, JU, SA	09/78 ⇒ 07/86
80 II 1.6	DS, JN, SF	08/78 ⇒ 03/87
80 II 1.8	DS, JN, SF	01/83 ⇒ 08/86
80 II 1.8 CC quattro	JN, JV	08/84 ⇒ 08/86
80 II 1.8 GTE	DZ, MU, PV	06/84 ⇒ 03/87
80 II 2.0	HP, JS	10/83 ⇒ 09/84

AUDI		
80 II 2.0 quattro	JS	10/83 ⇒ 09/84
80 III 1.4	SE	08/86 ⇒ 07/88
80 III 1.6	ABB, PP, RN, RNA	09/86 ⇒ 10/91
80 III 1.8	RU, SD	09/86 ⇒ 01/90
80 III 1.8 E	DZ	06/86 ⇒ 08/91
80 III 1.8 S	JN, JV, NE, PM, SF	08/86 ⇒ 10/91
80 III 2.0	AAD	10/90 ⇒ 08/91
80 III 2.0 E	3A	08/88 ⇒ 10/90
80 III 2.0 E 16V	6A	03/90 ⇒ 09/91
80 IV 1.6	ABB	03/92 ⇒ 05/93
90 I 1.8	JN	06/84 ⇒ 03/87
90 I 2.0	HP, JL, JS, SK	10/84 ⇒ 03/87
90 I 2.0 quattro	JS	08/84 ⇒ 08/86
90 I 2.2	9C54, HY, KX	10/84 ⇒ 03/87
90 I 2.2 E quattro	9C54	11/84 ⇒ 03/87
90 II 2.0	PS	07/88 ⇒ 09/91
90 II 2.0 20V	NM	08/89 ⇒ 07/91
90 II 2.2 E	9C54	04/87 ⇒ 07/91
90 II 2.3 E	NG	04/87 ⇒ 09/91
90 II 2.3 E 20V	7A	08/88 ⇒ 07/91
100 III 1.8	DS, JW, NP, SH	08/83 ⇒ 12/90
100 III 1.8 Cat	4B, PH	03/85 ⇒ 11/90
100 III 1.8 Cat quattro	4B	08/85 ⇒ 11/90
100 III 1.8 quattro	NP, SH	10/84 ⇒ 07/90
100 III 2.0	KP	08/84 ⇒ 12/87
100 III 2.0 E	KP	01/85 ⇒ 12/87
100 III 2.2 Cat	KU	06/89 ⇒ 11/90
100 III 2.2 Cat quattro	KU	06/89 ⇒ 11/90
100 IV 1.6	ABB	03/92 ⇒ 07/93
COUPE 1.8	DZ	08/89 ⇒ 07/91
COUPE 2.2	9C54	11/88 ⇒ 07/91
COUPE 2.2 GT	9C54	09/84 ⇒ 10/88
COUPE 2.2 quattro	9C54, JT	10/84 ⇒ 07/91

SAAB

900 I 2.0 -16	5B6304G5	01/89 ⇒ 06/94
900 I 2.0 i	0TLE4G15, B201XI	11/80 ⇒ 08/90
900 I 2.0 S Turbo-16	B202S	07/91 ⇒ 06/94
900 I 2.0 Turbo	B201XL	01/86 ⇒ 12/91
900 I 2.0 Turbo-16	B202L, B202XL	11/85 ⇒ 06/94
900 I 2.0 Turbo-16 S	B202XL	01/84 ⇒ 06/94
900 I 2.0 Turbo-16 S Cat	B202XL	01/89 ⇒ 12/93

SEAT

TOLEDO I 1.6 i	1F	05/91 ⇒ 03/99
TOLEDO I 1.8 16V	PL	05/91 ⇒ 03/99
TOLEDO I 1.8 i	RP	05/91 ⇒ 12/96

VW

POLO II 1.0	AAK, HZ	01/85 ⇒ 09/94
POLO II 1.0 Cat	AAK	08/89 ⇒ 09/94
POLO II 1.3	3F, MH	08/83 ⇒ 09/94
POLO II 1.3 Cat	2G, 3F, MH, NZ	07/87 ⇒ 09/94
POLO II 1.3 G40	PY	01/87 ⇒ 08/90
JETTA II 1.0	HZ	08/85 ⇒ 10/91
JETTA II 1.3	MH	01/84 ⇒ 06/87
JETTA II 1.3 Cat	2G, MH, NZ	06/87 ⇒ 12/91
JETTA II 1.6	ABN, EZ, EZA, HM, PN, RF	12/83 ⇒ 07/92
JETTA II 1.8	EV, GU, GX, PB, RD, RH, RV	01/84 ⇒ 10/91
JETTA II 1.8 16V	KR, PL	08/86 ⇒ 10/91
JETTA II 1.8 Cat	GX, PF, RP	01/87 ⇒ 10/91
JETTA II 1.8 G60	PG	04/90 ⇒ 07/91
JETTA II 1.8 Syncro	3E82, GU, GX, RH, RP	08/85 ⇒ 07/91
JETTA II 1.8i GT	GZ	12/83 ⇒ 07/88
CADDY I 1.8	JH	08/85 ⇒ 07/92
CORRADO 1.8 16V	KR	04/89 ⇒ 07/92
CORRADO 1.8 G60	PG	09/88 ⇒ 09/93
CORRADO 2.0 i	ADY	04/93 ⇒ 12/95
CORRADO 2.0i 16V	7TZ220XS560	08/91 ⇒ 12/95
CORRADO 2.9 VR6	ABV	08/91 ⇒ 12/95
GOLF I 1.6	EW, HN	08/83 ⇒ 04/92
GOLF I 1.8	2H, DX, EX, JH, KT	08/82 ⇒ 04/93
GOLF II 1.0	HZ	08/85 ⇒ 10/91
GOLF II 1.3	MH	08/83 ⇒ 06/87
GOLF II 1.3 Cat	2G, NZ	06/86 ⇒ 12/92
GOLF II 1.6	ABN, EZ, PN, RF	08/83 ⇒ 12/92
GOLF II 1.6 [CHE] [SWE]	HM	08/83 ⇒ 07/88
GOLF II 1.6 G	EZA, PN	08/86 ⇒ 07/91
GOLF II 1.8	GU, GX, RH, RV	08/84 ⇒ 10/91
GOLF II 1.8 [CHE] [SWE]	HV	04/84 ⇒ 07/87
GOLF II 1.8 GTI	EV, PB, RD	08/83 ⇒ 10/91
GOLF II 1.8 GTI 16V	KR, PL	02/86 ⇒ 10/91
GOLF II 1.8 GTI Cat	PF	01/87 ⇒ 10/91
GOLF II 1.8 GTI G60	PG	04/90 ⇒ 07/91
GOLF II 1.8 GTI G60 Syncro	1H, PG	08/88 ⇒ 12/91
GOLF II 1.8 i	RP	08/87 ⇒ 07/91
GOLF II 1.8 i Cat	GX, RP	08/87 ⇒ 10/91
GOLF II 1.8 i Cat Syncro	RP	08/87 ⇒ 10/91
GOLF II 1.8 Rallye syncro	1H, PG	08/88 ⇒ 07/91
GOLF II 1.8 Syncro	3E82, GU, GX, RH	02/86 ⇒ 07/91
GOLF II 1.8i GTI [CHE] [SWE]	GZ	01/84 ⇒ 07/87

VW		
GOLF I 1.8i GTI [SWE]	GZ	08/87 ⇒ 07/88
PASSAT III 1.6	1F, EZ	04/88 ⇒ 07/92
PASSAT III 1.8	KR, PB, PF	04/88 ⇒ 09/93
PASSAT III 1.8 16V	KR	04/88 ⇒ 12/89
PASSAT III 1.8 GL	KR	08/91 ⇒ 09/93
SCIROCCO II 1.6	EW, HN	01/83 ⇒ 12/89
SCIROCCO II 1.8	DX, EX, JH, KT	08/82 ⇒ 07/92
SCIROCCO II 1.8 16V	KR, PL	10/85 ⇒ 07/92
TRANSPORTER III 1.9	DF, DG	08/82 ⇒ 07/92
TRANSPORTER III 1.9 Syncro	DG	11/84 ⇒ 07/92
TRANSPORTER III 2.1	DJ, MV, SR	08/84 ⇒ 07/92
TRANSPORTER III 2.1 Cat	MV	06/89 ⇒ 07/92
TRANSPORTER III 2.1 i	SS	07/89 ⇒ 07/92
TRANSPORTER III 2.1 Syncro	DJ, MV, SR	08/85 ⇒ 07/92

EPS 1.965.020



3,5

IGNITION MODULES

Adatt./Suitable:

FIAT

9940095

INNOCENTI

9940095

LANCIA

9940095

MAGNETI MARELLI

064833040010

581701070000

648 330 40

BKL 4 A

PIAGGIO

498327



FIAT

DUNA 60 1.1	146A6.000	01/87 ⇒ 12/91
DUNA 70 1.3	146A5.000	01/87 ⇒ 12/91
ELBA 1.3	146A5.000	04/91 ⇒ 02/95
FIORINO I 1.1 60	146A9.000	11/86 ⇒ 04/88
FIORINO I 1.3	146A5.000	12/87 ⇒ 08/93
FIORINO II 1.0 IE	156A2.246	11/92 ⇒ 04/96
FIORINO II 1.3	146A5.000	01/88 ⇒ 12/94
FIORINO II 60 1.1	146A9.000	05/88 ⇒ 12/93
FIORINO II 70 1.3	146A5.000	01/88 ⇒ 12/94
PALIO 1.1	178B9.033	07/97 ⇒ 10/03
PANDA I 1.1	156C.046	05/91 ⇒ 03/95
PANDA I 1000	156A2.100, 156A3.000	01/85 ⇒ 12/92
PANDA I 1000 4x4	156A2.100, 156A2.246, 156A3.000	01/86 ⇒ 12/94
PANDA I 1000 Fire [CHE]	156A2.146	11/87 ⇒ 04/91
PANDA I 1000 Fire [DEU]	156A2.048	01/86 ⇒ 07/89
PANDA I 1000 i.e	156A2.246	08/92 ⇒ 02/04
PANDA I 1000 i.e. Cat	156A2.246	10/87 ⇒ 08/98
PANDA I 1100 i.e.	156C.046	01/86 ⇒ 04/91
PANDA I 1100 Trekking 4x4	156C.046	10/91 ⇒ 07/04
PANDA I 750 Cat	156A4.048	01/95 ⇒ 10/03
PANDA I 750 Fire	156A4.048	11/88 ⇒ 04/91
REGATA 70 1.3	138B2.000, 149A3.000	09/83 ⇒ 07/89
RITMO I 1.3	149A3.000	11/83 ⇒ 08/85
TEMPRA 1.4 i.e.	159A2.000	04/90 ⇒ 08/96
TIPO I 1.1	160A3.000	01/88 ⇒ 10/91
TIPO I 1.4	160A1.000	07/87 ⇒ 12/89
TIPO I 1.4 i.e.	159A2.000	05/89 ⇒ 04/95
UNO 1.0	146A2.166	11/94 ⇒ 08/00
UNO 45 1.0	156A2.000, 156A2.100	06/86 ⇒ 12/93
UNO 45 1.0 Fire	--	01/83 ⇒ 12/89
UNO 45 i.e. 1.0	156A2.246	10/84 ⇒ 10/95
UNO 50 1.1	156C.046	01/90 ⇒ 12/93
UNO 50 i.e. 1.1	146C3.000	06/92 ⇒ 12/93
UNO 60 1.1	146A4.048, 146A6.000, 160A3.000	02/88 ⇒ 12/92
UNO 60 1.1 SX	--	01/85 ⇒ 12/89
UNO CS 1.1	146A6.000	09/87 ⇒ 09/91
UNO Mondo 1.0	146A2.166	01/98 ⇒
UNO Mondo 1.0 [IND]	146A2.166	01/98 ⇒

FIAT (BR)

UNO CS 1116	--	01/88 ⇒
-------------	----	---------

INNOCENTI			
ELBA 1.3	146A5.000	08/91	⇒ 12/96
LANCIA			
DELTA I 1.1	831B8.000	01/86	⇒ 12/90
DELTA I 1.3	1831B.000, 3831B.000, 831A2.000, 831B.000	09/79	⇒ 10/92
PRISMA 1.3	831A2.000	01/83	⇒ 12/89
Y10 1.0 Fire	156A2.100	06/85	⇒ 06/91
Y10 1.0 Fire Catalytic-Conv	156A2.246	10/87	⇒ 02/92
Y10 1.0 Fire Trazione integrale	156A2.000, 156A2.100, 156A2.246	12/86	⇒ 02/92
Y10 1.1 i.e Fire	156C.000	08/89	⇒ 06/92
Y10 1.1 i.e Fire Trazione integrale	156C.000	08/89	⇒ 06/92
Y10 1.1 i.e Fire	156C.046	07/89	⇒ 09/95

EPS 1.965.025



IGNITION MODULES

Adatt./Suitable:

DELCO REMY

1 601 0892
1 977 958
1 979 107
D-1957
D-1958
D-1961

GENERAL MOTORS

1 977 958
1 979 107
1 979 571
1 985 342
10 482 824
16 140 049
16 158 829

ISUZU

8-01979571-0
8-16140049-0

OPEL

12 11 582
12 11 591
12 37 504
62 37 753

⁰³ Supplied until depletion

- Fornibile fino ad esaurimento delle scorte
- Fourni jusqu'à épuisement du stock
- Lieferbar solange vorrat reicht
- Suministrado hasta el stock termina

¹¹¹⁴ Supplied with heat conducting silicone grease capsule

- Fornito con capsula di grasso termico al silicone
- Fourni avec capsule contenant graisse termique au silicone
- Geliefert mit Thermo-Silikonfettkapsel
- Suministrado con capsula de grasa termica de silicona

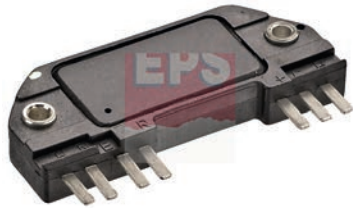

ISUZU			
PICK-UP 3.1i V6 [USA]	LG6	01/90	⇒
RODEO 3.1i V6 [USA]	LG6	01/90	⇒ 12/92
TROOPER 3.2i V6 [USA]	--	01/88	⇒ 12/91
OPEL			
ASCONA C 1.6 i Cat	C16LZ, C16NZ	09/86	⇒ 08/88
ASTRA F 1.6 i	C16NZ	09/91	⇒ 09/98
CORSA A 1.3	C13N	09/85	⇒ 10/87
CORSA A 1.3 i	C13N	09/86	⇒ 09/90
KADETT E 1.3 i Cat	C13N	09/85	⇒ 08/91
KADETT E 1.6 i	C16NZ	09/86	⇒ 07/94
KADETT E 1.6 i Cat	C16LZ, C16NZ	09/86	⇒ 02/93
VECTRA A 1.6 i	C16NZ, E16NZ, X16SZ	09/88	⇒ 11/95
VECTRA A 1.6 i Cat	C16NZ	09/88	⇒ 11/95
VAUXHALL			
ASTRA III 1.6 i	C16NZ	09/91	⇒ 12/98
ASTRAVAN I 1.6 i	C16NZ	10/91	⇒ 08/98

EPS 1.965.029



IGNITION MODULES

Adatt./Suitable:

DUCELLIER

2 528 001 A
7 350 260 2

FIAT

9942040

LANCIA

9942040

⁰³ Supplied until depletion

- Fornibile fino ad esaurimento delle scorte
- Fourni jusqu'à épuisement du stock
- Lieferbar solange vorrat reicht
- Suministrado hasta el stock termina

¹¹¹⁴ Supplied with heat conducting silicone grease capsule

- Fornito con capsula di grasso termico al silicone
- Fourni avec capsule contenant graisse termique au silicone
- Geliefert mit Thermo-Silikonfettkapsel
- Suministrado con capsula de grasa termica de silicona



FIAT

PANDA I 750 Cat	156A4.048	01/95	⇒ 10/03
PANDA I 750 Fire	156A4.048	11/88	⇒ 04/91
TIPO I 1.1	160A3.000	01/88	⇒ 10/91
UNO 45 1.0	156A2.000, 156A2.100	06/86	⇒ 12/93
UNO 45 1.0 Fire	--	01/83	⇒ 12/89
UNO 60 1.1	160A3.000	04/89	⇒ 12/92

LANCIA

Y10 1.0 Fire Trazione integrale	156A2.000	12/87	⇒ 02/90
Y10 1.1 i.e Fire	156C.000	08/89	⇒ 06/92
Y10 1.1 i.e Fire Trazione integrale	156C.000	08/89	⇒ 06/92

EPS 1.965.034



IGNITION MODULES

Adatt./Suitable:

BOSCH

0 227 100 124
1 227 010 003
1 227 010 039

CITROËN

5945 51
96 048 070

GENERAL MOTORS

90 006 499

IVECO

7612955

OPEL

12 08 243

PEUGEOT

5945 51

PORSCHE

928 602 706 01

SAAB

40 23 149
59 60 059
75 03 600

SCANIA

4023149
5960059

VOLVO

1332584
13325840

⁰³ Supplied until depletion

- Fornibile fino ad esaurimento delle scorte
- Fourni jusqu'à épuisement du stock
- Lieferbar solange vorrat reicht
- Suministrado hasta el stock termina

¹¹¹⁴ Supplied with heat conducting silicone grease capsule

- Fornito con capsula di grasso termico al silicone
- Fourni avec capsule contenant graisse termique au silicone
- Geliefert mit Thermo-Silikonfettkapsel
- Suministrado con capsula de grasa termica de silicona



CITROËN

XM I 3.0	UFZ(ZPJ/Z)	05/89	⇒ 05/94
XM I 3.0 V6	SFZ(ZPJ/Z), UFZ(ZPJ/Z)	05/89	⇒ 06/94
XM I 3.0 V6 24V	SKZ(ZPJ4/Z), UKZ(ZPJ4/Z)	07/90	⇒ 06/94

CITROËN

XM II 3.0 V6	SFZ(ZPJ/Z), UFZ(ZPJ/Z)	05/94	⇒ 10/00
XM II 3.0 V6 24V	SKZ(ZPJ4/Z), UKZ(ZPJ4/Z)	05/94	⇒ 10/00

OPEL

KADETT E 1.6 S	16S	09/84	⇒ 08/86
KADETT E 1.8	18SE	01/86	⇒ 08/91
KADETT E 1.8 GSI	18E	09/84	⇒ 08/86
KADETT E 1.8 i	18E	09/84	⇒ 08/86
OMEGA A 3.0	3ONE	03/87	⇒ 09/90

PEUGEOT

605 3.0	UFZ(ZPJ), UKZ(ZPJ4/Z)	08/89	⇒ 09/99
605 3.0 SV 24	UKZ(ZPJ4/Z)	08/89	⇒ 09/99

PORSCHE

911 II 3.6 Carrera	M64.01, M64.02	12/88	⇒ 05/94
911 II 3.6 Carrera 4	M64.01	12/88	⇒ 05/94
911 II 3.6 Carrera RS	M64.03	06/91	⇒ 09/93
928 5.4 GTS	M28.49, M28.50	08/91	⇒ 11/95

SAAB

900 1.2.0 -16	5B6304GS	01/89	⇒ 06/94
9000 2.0 -16	5B6304GS, B202XI	12/85	⇒ 01/93
9000 2.0 -16 CS	5B6304GS	01/89	⇒ 12/98
9000 2.3 -16 CD	B234I	08/89	⇒ 12/98
9000 2.3 -16 CS	B234I	09/89	⇒ 12/98

EPS 1.965.036



IGNITION MODULES

Adatt./Suitable:

GENERAL MOTORS

90 243 618 ⁺
90 360 314 ⁺
90 360 315 ⁺

HOLDEN

90243618 ⁺

OPEL

12 37 334 ⁺
12 37 464 ⁺

⁺ Supplied module only, without bracket

- Fornito solo il modulo, no la flangia
- Fourni le module seul, sans bride
- Geliefert nur das Modul, ohne Montageflansch
- Suministrado solo el módulo, sin base de montaje

⁰³ Supplied until depletion

- Fornibile fino ad esaurimento delle scorte
- Fourni jusqu'à épuisement du stock
- Lieferbar solange vorrat reicht
- Suministrado hasta el stock termina

¹¹¹⁴ Supplied with heat conducting silicone grease capsule

- Fornito con capsula di grasso termico al silicone
- Fourni avec capsule contenant graisse termique au silicone
- Geliefert mit Thermo-Silikonfettkapsel
- Suministrado con capsula de grasa termica de silicona



HOLDEN

BARINA 1.4 i	C14NZ	04/94	⇒ 07/97
BARINA_SB 1.2i	C12NZ	04/94	⇒ 07/97
COMBO 1.4 i	C14NZ	03/96	⇒ 07/97
COMBO_SB 1.4i	C14NZ	04/94	⇒ 07/97

OPEL

ASTRA F 1.4	14SE	09/92	⇒ 09/98
ASTRA F 1.4 i	C14NZ	09/91	⇒ 01/05
ASTRA F 1.4 Si	C14SE	03/92	⇒ 03/01
ASTRA F 1.6	16LZ2, 16NZ2	09/94	⇒ 09/98
ASTRA F 1.8 i	C18NZ	09/91	⇒ 09/98
COMBO B 1.2	C12NZ	07/94	⇒ 10/01
COMBO B 1.4	C14NZ	07/94	⇒ 10/01
CORSA A 1.2 i	C12NZ	09/89	⇒ 03/93
CORSA A 1.4 i	C14NZ	01/85	⇒ 03/93
CORSA A 1.4 Si	C14SE	09/91	⇒ 03/93
CORSA A 1.6 GSI	E16SE	05/88	⇒ 03/92
CORSA B 1.2 i	12NZ, C12NZ	03/93	⇒ 09/00
CORSA B 1.4 i	C14NZ	03/93	⇒ 09/00
KADETT E 1.4 i	C14NZ	01/90	⇒ 07/94
KADETT E 1.6	16SV	09/86	⇒ 12/91
KADETT E 1.6 i	16SV	07/89	⇒ 02/93
KADETT E 1.6 S	16SV	09/86	⇒ 08/91

OPEL			
OMEGA A 1.8 S	18SV	09/86 ⇒	03/94
VECTRA A 1.6	16SV, C16LZ2	09/88 ⇒	07/93
VECTRA A 1.6 i	C16NZ2	09/88 ⇒	11/95
VECTRA A 1.6 i Cat	C16NZ2	09/88 ⇒	11/95
VECTRA A 1.6 S	16SV	09/88 ⇒	05/93
VECTRA A 1.8 i	18SV	09/88 ⇒	10/90
VECTRA A 1.8 i Cat	C18NZ	03/90 ⇒	11/95
VECTRA A 1.8 S	18SV	09/89 ⇒	10/90
VECTRA B 1.6 i	16LZ2	10/95 ⇒	07/03
VAUXHALL			
ASTRA III 1.4 i	C14NZ, C14SE	03/91 ⇒	09/98
ASTRA III 1.8 i	C18NZ	09/91 ⇒	09/98
ASTRAVAN I 1.4 i	C14NZ	09/91 ⇒	08/95
COMBO B 1.2	C12NZ	07/94 ⇒	10/01
COMBO B 1.4	C14NZ	07/94 ⇒	10/01
CORSA B 1.2 i	C12NZ	03/93 ⇒	09/00
CORSA B 1.4 i	C14NZ	03/93 ⇒	09/00
CORSAVAN I 1.4 i	C14NZ	01/94 ⇒	09/00

EPS 1.965.051



3,5

IGNITION MODULES

Adatt./Suitable:

AUDI

4A0 905 351

HITACHI

DIS4-05

VW

4A0 905 351

⁰³ Supplied until depletion

- Fornibile fino ad esaurimento delle scorte
- Fourni jusqu'à épuisement du stock
- Lieferbar solange vorrat reicht
- Suministrado hasta el stock termina

¹¹¹⁴ Supplied with heat conducting silicone grease capsule

- Fornito con capsula di grasso termico al silicone
- Fourni avec capsule contenant graisse termique au silicone
- Geliefert mit Thermo-Silikonfettkapsel
- Suministrado con capsula de grasa termica de silicona



AUDI			
80 IV 2.6	ABC	07/92 ⇒	01/96
80 IV 2.6 E	ACZ	05/93 ⇒	05/95
80 IV 2.6 E quattro	ACZ	11/93 ⇒	05/95
80 IV 2.6 quattro	ABC, ACZ	06/92 ⇒	01/96
80 IV 2.8	AAH	09/91 ⇒	01/96
80 IV 2.8 quattro	AAH	09/91 ⇒	07/95
100 IV 2.6	ABC, ACZ	03/92 ⇒	07/94
100 IV 2.6 E quattro	ACZ	08/93 ⇒	07/94
100 IV 2.6 quattro	ABC	04/92 ⇒	07/94
100 IV 2.8 E	AAH	12/90 ⇒	07/94
100 IV 2.8 E quattro	AAH	12/90 ⇒	07/94
A6 I 2.4	AFM	07/95 ⇒	12/97
A6 I 2.6	ABC, ACZ	06/94 ⇒	12/97
A6 I 2.6 quattro	ABC, ACZ	06/94 ⇒	12/97
A6 I 2.8	AAH, AEJ	06/94 ⇒	12/97
A6 I 2.8 quattro	AAH, AEJ	06/94 ⇒	12/97
A4 I 2.4	AFM	07/95 ⇒	07/97
A4 I 2.6	ABC	01/95 ⇒	09/01
A4 I 2.6 quattro	ABC	01/95 ⇒	09/01
A4 I 2.8	AAH	09/95 ⇒	07/97
A4 I 2.8 quattro	AAH	01/95 ⇒	07/97
A8 I 2.8	AAH, AEJ	03/94 ⇒	03/96
A8 I 2.8 quattro	AAH, AEJ	03/94 ⇒	03/96
CABRIOLET 2.6	ABC, ACZ	06/93 ⇒	08/00
CABRIOLET 2.8	AAH	11/92 ⇒	08/00
COUPE 2.6	ABC	08/92 ⇒	12/96
COUPE 2.6 quattro	ABC	08/92 ⇒	12/96
COUPE 2.8	AAH	09/91 ⇒	12/96
COUPE 2.8 quattro	AAH	08/91 ⇒	12/96

EPS 1.965.052



3,5

IGNITION MODULES

Adatt./Suitable:

ACURA

06302-PT2-000

06302-PT2-A00

HONDA

06302-PT2-000

06302-PT2-A00

06302-PT3-000

06302-PT3-A00

06302-PT-A00

30120-PM-A01

30120-PR3-003

30120-PT2-004

30120-PT3-003

30120-PT3-004

30130-P54-006

30130-PR3-006

30130-PT2-006

ROVER

NJL100030

NJL100040

NJW100030



ACURA			
INTEGRA I 1.6	D16A1	01/85 ⇒	12/90
INTEGRA I 1.6 i	D16A8	01/85 ⇒	12/90
INTEGRA II 1.8	F18A2	10/90 ⇒	09/93
HONDA			
ACCORD IV 2.0 16V	F20A5	01/90 ⇒	12/93
ACCORD IV 2.0 i 16V	F20A4, F20A7, F20A8, F20Z3	01/90 ⇒	12/93
ACCORD IV 2.2	F22A6	05/92 ⇒	12/93
ACCORD IV 2.2 i 16V	F22A3, F22A7, F22A8	01/90 ⇒	12/93
ACCORD IV 2.2 i 16V Automatic	F22A3	01/90 ⇒	03/93
ACCORD V 2.0	F20B3	09/93 ⇒	12/97
ACCORD V 2.0 i	F20Z2	03/93 ⇒	01/96
ACCORD V 2.0 i LS 16V	F20B3	09/93 ⇒	02/98
ACCORD V 2.0 i S	F20Z1	03/93 ⇒	01/96
ACCORD V 2.2 i [USA]	--	01/94 ⇒	12/95
ACCORD V 2.2 i 16V	F22B4	08/95 ⇒	12/97
ACCORD V 2.2 i ES	F22B5	09/93 ⇒	02/98
CIVIC V 1.5	D15B2	01/92 ⇒	12/92
CIVIC V 1.5 i 16V	D15B2, D15Z1	10/91 ⇒	11/95
CIVIC V 1.6 16V Vtec	D16Z6, D16Z7	10/91 ⇒	11/95
CIVIC V 1.6 4x4	D16Z7	01/92 ⇒	10/95
CIVIC V 1.6 i Vtec	B16A2	01/94 ⇒	11/95
CIVIC V 1.6 Vti	B16A2	10/91 ⇒	11/95
CIVIC V 1.6 Vti 16V	B16A2	10/91 ⇒	11/95
CIVIC IV 1.5	D15B1	01/88 ⇒	12/89
CIVIC IV 1.5 i 16V	D15B2	10/87 ⇒	09/91
CIVIC IV 1.6 16V 4x4	D16A6	11/87 ⇒	09/91
CIVIC IV 1.6 i 16V	D16A6, D16A9, D16Z2	09/87 ⇒	09/91
CIVIC IV 1.6 i 16V 4x4	D16A6, D16Z2	01/89 ⇒	12/91
CIVIC IV 1.6 i	--	01/90 ⇒	12/91
CIVIC IV 1.6 i 16V	D16A1, D16A7, D16A8, D16A9	01/88 ⇒	05/92
CIVIC IV 1.6 i 16V 4WD	D16A1, D16Z2	01/88 ⇒	12/91
CIVIC IV SHUTTLE 1.5 i 16V	D15B2	01/88 ⇒	11/91
CIVIC IV SHUTTLE 1.6 4x4	D16A, D16A7	01/88 ⇒	12/92
CIVIC IV SHUTTLE 1.6 i 16V 4WD	D16A6	01/88 ⇒	02/95
CIVIC IV SHUTTLE 1.6 i	--	01/88 ⇒	12/91
CIVIC IV SHUTTLE 1.6 i 16V 4WD	D16Z2	01/88 ⇒	12/92
CONCERTO 1.5 i 16V	D15B2	08/89 ⇒	05/95
CONCERTO 1.6 16V	D16Z2	08/89 ⇒	03/95
CONCERTO 1.6 i 16V	D16A8, D16Z2	08/89 ⇒	03/95
CONCERTO 1.6 i DOHC	--	01/90 ⇒	12/91
CRX II 1.6 i 16V	D16A9, D16Z5	10/87 ⇒	02/92
CRX II 1.6 i 16V Vtec	B16A1	10/89 ⇒	02/92
CRX III 1.6 ESi	D16Y8, D16Z6	03/92 ⇒	12/98
CRX III 1.6 i Vti	B16A2	03/92 ⇒	12/98
PRELUDE IV 2.0 i 16V	F20A4	02/92 ⇒	09/96
PRELUDE IV 2.2 i 16V Vtec	H22A2	02/93 ⇒	09/96
PRELUDE IV 2.3 i 16V	H23A2	02/92 ⇒	09/96
ROVER			
200 II 216	D16A8	10/92 ⇒	06/99

ROVER			
200 II 216 1.6i	D16A8	01/92 ⇒	11/99
200 II 216 GSi	1GH5E-180	01/90 ⇒	12/95
200 II 216 GTi	D16A8	01/90 ⇒	10/95
600 618 i/Si	F18A3	03/96 ⇒	02/99
600 620 i	F20Z2	08/93 ⇒	06/96
600 620 Si	F20Z1	08/93 ⇒	02/99
600 623 Si	H23A3	08/93 ⇒	06/99
400 I 416 GSi	1GH5E-180	04/90 ⇒	04/95
400 I 416 GSi/GSE	D16A7	04/90 ⇒	04/95
400 I 416 GTI	D16A8	04/90 ⇒	04/95

EPS 1.965.072



3,5

IGNITION MODULES

Adatt./Suitable:

AUDI

8D0 905 351

HITACHI

DIS4-08

VW

8D0 905 351

⁰³ Supplied until depletion

- Fornibile fino ad esaurimento delle scorte
- Fourni jusqu'à épuisement du stock
- Lieferbar solange vorrat reicht
- Suministrado hasta el stock termina

¹¹¹⁴ Supplied with heat conducting silicone grease capsule

- Fornito con capsula di grasso termico al silicone
- Fourni avec capsule contenant graisse termique au silicone
- Geliefert mit Thermo-Silikonfettkapsel
- Suministrado con capsula de grasa termica de silicona



AUDI			
A4 I 1.8 T	1HN9, AJL, ANB, APU, ARK	01/95 ⇒	09/01
A4 I 1.8 T quattro	1HN9, AJL, ANB, APU, ARK	01/95 ⇒	09/01
A6 II 1.8 T	1HN9, AJL, ANB, APU, ARK	01/97 ⇒	01/05
A6 II 1.8 T quattro	1HN9, AJL, ANB, APU, ARK	02/97 ⇒	01/05
VW			
PASSAT IV 1.8 T	AEB, ANB, APU	10/96 ⇒	11/00
PASSAT IV 1.8 T Syncro	AEB	11/96 ⇒	08/00

EPS 1.965.073



3

IGNITION MODULES

Adatt./Suitable:

MAZDA
B541-18-V20 *J
MITSUBISHI
J170

00 Eliminated on 04-05-2020. Please verify the availability through our local distributors

- Eliminato il 04-05-2020. Verificare la disponibilità presso i nostri distributori
- Éliminé le 04-05-2020. Vérifier la disponibilité auprès de nos distributeurs sur place
- Am 04-05-2020 gestrichen. Evtl. Verfügbarkeit bitte bei unseren Händlern prüfen
- Eliminado en fecha 04-05-2020. Verificar la disponibilidad a través de nuestros distribuidores locales

***J Supplied module only, without bracket**

- Fornito solo il modulo, no la flangia
- Fourni le module seul, sans bride
- Geliefert nur das Modul, ohne Montageflansch
- Suministrase solo el módulo, sin base de montaje

1114 Supplied with heat conducting silicone grease capsule

- Fornito con capsula di grasso termico al silicone
- Fourni avec capsule contenant graisse termique au silicone
- Geliefert mit Thermo-Silikonfettkapsel
- Suministrado con capsula de grasa termica de silicona



MAZDA

121 I 1.1	B115, B116	10/87 ⇒ 01/91
121 I 1.1 Unleaded Fuel	--	01/87 ⇒ 12/91
121 I 1.3	B3	04/89 ⇒ 10/90
121 I 1.3 Leaded Fuel	--	01/87 ⇒ 12/91
121 II 1.1	B1	11/90 ⇒ 10/93
323 III 1.5	B505, B535, B536	09/89 ⇒ 09/93
323 VI C 1.6	B6E	09/89 ⇒ 06/91
323 VI C 1.6 16V	B6	03/91 ⇒ 10/94
323 VI F 1.6	B6E	09/89 ⇒ 06/91
323 VI F 1.6 16V	B6	03/91 ⇒ 10/94
323 VI S 1.3	B383, B3E	09/89 ⇒ 06/91
323 VI S 1.3 16V	B3(16V)	04/91 ⇒ 07/94
323 VI S 1.6	B6E	09/89 ⇒ 06/91
323 VI S 1.6 16V	B6	08/89 ⇒ 10/96
323 VI 1.3 16V	B384, B386, B387	06/89 ⇒ 03/91

EPS 1.965.074



07

IGNITION MODULES

Adatt./Suitable:

SEAT
071 905 143
TELEFUNKEN
311886

VW
071 905 143

03 Supplied until depletion

- Fornibile fino ad esaurimento delle scorte
- Fourni jusqu'à épuisement du stock
- Lieferbar solange vorrat reicht
- Suministrado hasta el stock termina



SEAT

LEON I 2.3 V5	AGZ	10/98 ⇒ 11/00
TOLEDO II 2.3 V5	AGZ	10/98 ⇒ 11/00

VW

PASSAT IV 2.3 VR5	AGZ	10/96 ⇒ 11/00
PASSAT IV 2.3 VR5 Syncro/4motion	AGZ	10/97 ⇒ 11/00
BORA 2.3 V5	AGZ	10/98 ⇒ 10/00
BORA 2.3 V5 4motion	AGZ	12/98 ⇒ 10/00
GOLF IV 2.3 V5	AGZ	08/97 ⇒ 06/06
GOLF IV 2.3 V5 4motion	AGZ	12/98 ⇒ 06/06

EPS 1.965.076



3,5

IGNITION MODULES

Adatt./Suitable:

AUDI
4D0 905 351

BOSCH
0 227 100 030
0 227 100 211
0 227 100 212

SEAT
4D0 905 351

SKODA
4D0 905 351

VW
4D0 905 351

03 Supplied until depletion

- Fornibile fino ad esaurimento delle scorte
- Fourni jusqu'à épuisement du stock
- Lieferbar solange vorrat reicht
- Suministrado hasta el stock termina

1114 Supplied with heat conducting silicone grease capsule

- Fornito con capsula di grasso termico al silicone
- Fourni avec capsule contenant graisse termique au silicone
- Geliefert mit Thermo-Silikonfettkapsel
- Suministrado con capsula de grasa termica de silicona



AUDI

A3 I 1.8 T	AGU	12/96 ⇒ 05/03
A3 I 1.8 T quattro	AGU	12/96 ⇒ 05/03
A4 II 1.8 T	AVJ	11/00 ⇒ 07/02
A4 II 1.8 T quattro	AVJ	11/00 ⇒ 07/02
A6 I S6 Plus quattro	AHK	04/96 ⇒ 12/97
A4 I 1.8 T	1HN9	01/95 ⇒ 09/01
A4 I 1.8 T quattro	1HN9	01/95 ⇒ 09/01
A6 II 1.8 T	1HN9	01/97 ⇒ 01/05
A6 II 1.8 T quattro	1HN9	02/97 ⇒ 01/05
A8 I 3.7	AEW, AKJ	07/95 ⇒ 12/98
A8 I 3.7 quattro	AEW, AKJ	07/95 ⇒ 11/98
A8 I 4.2 quattro	ABZ, AEM, AGH, AKG	03/94 ⇒ 11/98
A8 I S8 quattro	ZC2CNG, AKH	07/96 ⇒ 06/99

SEAT

ALHAMBRA I / II 1.8 T 20V	AJH	10/97 ⇒ 03/10
LEON I 1.8 20V T	APP	11/99 ⇒ 06/06

SKODA

OCTAVIA I 1.8 T	AGU, ARX, AUM	08/97 ⇒ 12/10
-----------------	---------------	---------------



COILS

-BOBINE -BOBINES -ZÜNDSPULEN -BOBINAS

(A) P/NRS. - NOTES

- CODICI - NOTE
- RÉFS. - NOTES
- ARTIKEL-NR. - ANMERKUNGEN
- CODIGOS - NOTAS

(B) PICTURE + TECHNICAL INFO

- FOTO + INFORMAZIONE TECNICA
- ILLUSTRATION + INFORMATION TECHNIQUE
- BILD + TECHNISCHE INFO
- FOTO + INFORMACIÓN TÉCNICA

(C) APPLICATION LIST

- GUIDA APPLICAZIONI
- LISTE D'APPLICATIONS
- ANWENDUNGSTABELLE
- LISTA DE APLICACIONES

1.970.607 **05,5**

IGNITION COILS

Adatt./Suitable:

BMW

12 13 7 559 842
12 13 7 571 644
12 13 7 582 627
12 13 7 594 935
12 13 7 638 477
7 559 842
7 594 935
7 638 477

BOSCH

0 221 504 471
0 221 504 472

NEW - ITEM NOW AVAILABLE FROM PRODUCTION

- NUOVO - ARTICOLO ORA DISPONIBILE PER LA VENDITA
- NOUVEAU - ARTICLE DISPONIBLE EN PRODUCTION COURANTE
- NEU - JETZT ZUM VERKAUF VERFÜGBARER ARTIKEL
- NUEVO - ARTICULO AHORA DISPONIBLE EN PRODUCCION

MARKET DIFFUSION: MEDIUM

2	GND - +	3	ohm 0,55	4		5	ohm ---	6	
---	------------	---	-------------	---	--	---	------------	---	--

BMW		
3 SERIES 320i Touring	N43B20A	06/07 ⇌ 10/12
1 1 116 i	N43B16A, N43B20A	03/07 ⇌ 12/11
1 1 118 d	M47D20(204D4)	11/03 ⇌ 02/07
1 1 118 i	N43B20A	09/06 ⇌ 12/13
1 1 120 i	N43B20A, N46B20BD	11/03 ⇌ 12/13
3 V 316 i	N43B16A, N43B16AA	09/07 ⇌ 12/13
3 V 318 i	N43B20A	02/07 ⇌ 12/13
3 V 320 i	N43B20A	09/06 ⇌ 12/13

(A)

1 # EPS

2 OEM P/NRS.

- CODICI ORIGINALI
- RÉFS. D'ORIGINE
- ORIGINALTEILE-NR.
- CODIGOS ORIGINALES

3 PACKAGING SIZE

- FORMATO CONFEZIONE
- FORMAT DU CONDITIONNEMENT
- ABPACKENSGROESSE
- TAMAÑO DEL ENVASE

4 PRODUCT AVAILABILITY DATE

- DATA DI DISPONIBILITÀ DEL PRODOTTO
- DATE DISPONIBILITÉ DU PRODUIT
- PRODUKTVERFUEGBARKEITSDATUM
- FECHA DISPONIBILIDAD ARTÍCULO

5 NOTE

- NOTE
- NOTES
- BERMERKUNGEN
- NOTAS

(B)

1 PICTURE

- FOTO
- PHOTO
- BILD
- FOTO

2 LOW TENSION CONNECTION TYPE

- TIPO CONNESSIONE BASSA TENSIONE
- TYPE CONNECTION BAISSE TENSION
- ANSCHLUSSTYP NIEDERSpannung
- TIPO CONNECCION BAJA TENSION

3 PRIMARY RESISTANCE

- RESISTENZA PRIMARIO
- RESISTANCE PRIMAIRE
- WIDERSTAND PRIMÄRSPULE
- RESISTENCIA DEL PRIMARIO

4 HIGH TENSION CONNECTION TYPE

- TIPO CONNESSIONE ALTA TENSIONE
- TYPE CONNECTION HAUTE TENSION
- ANSCHLUSSTYP HOCHSPANNUNG
- TIPO CONNECCION ALTA TENSION

5 SECONDARY RESISTANCE (IT CAN BE MEASURED ONLY IF IT IS WITHOUT DIODE)

- RESISTENZA SECONDARIO (MISURABILE SOLO SE NON È PRESENTE IL DIODO)
- RESISTANCE SECONDAIRE (MESURABLE SEULEMENT S'IL Y A LE DIODE)
- WIDERSTAND SEKUNDÄRSPULE, NUR WENN DIE DIODE ABWESEND IST
- RESISTENCIA DEL SECONDARIO (MENSURABLE SOLAMENTE SI HAY EL DIODO)

6 SYMBOL OF DIODE (IF PRESENT)

- RAPPRESENTAZIONE DIODO (SOLO SE PRESENTE)
- SYMBOL DU DIODE (S'IL Y A)
- ABBILDUNG DER DIODE, NUR WENN SIE ANWESEND IST.
- REPRESENTACION DEL DIODO (SI HAY)



1.970.XXX/1.990.XXX IGNITION COILS

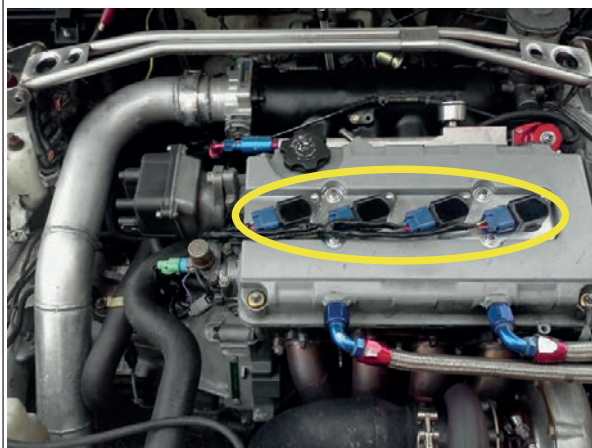

The ignition coils are transformers that are able to provide high voltage pulses. The purpose of these pulses is to generate a spark (arc) between the electrodes of the spark plugs on the internal combustion engine that is of sufficient intensity and duration to start the internal combustion of the air-fuel mixture successfully.

The main causes of failure of the product are:

- short circuit due to overheating
- insufficient power supply
- cable breakage
- low battery
- mechanical, electrical and chemical stress
- humidity

Signs of malfunctions:

- failure to start the engine
- problems of acceleration and power loss
- emergency operation of the control unit
- the engine control light comes on
- NOX emissions
- damage to the catalytic converter

The ignition coils are designed and built to withstand critical mounting conditions in the engine compartment. In particular they must meet the following requirements:

- operating temperature:
 - from -40°C to $+125^{\circ}\text{C}$ for devices mounted on the head and motor (typically, Pencil Coil); the parts in contact with the candle must withstand 180°C .

The coils are subjected to rigorous qualification and durability tests to determine if the product is suitable for being built and sold:

- Electromagnetic immunity test
- Proof of resistance to rapid temperature cycles
- Free discharge dielectric strength test
- Duration test
- Vibration resistance test

Pass these tests and allow the approval to produce during assembly the product undergoes strict control cycles which provide **100% testing**.

Structural components and operating principles

The main elements of construction of a modern ignition coil are:

- primary electrical circuit (copper wire wound around the primary iron core)
- secondary electrical circuit (copper wire wound around the secondary iron core)
- the magnetic circuit (pack)
- the electronic circuit
- the case (containing all the other elements coated in epoxy resin)
- various elements (incorporated only in some models): the interference suppressor, the high voltage diode, the electronic power switch, etc. The primary winding is piloted by the electronic power switch until it reaches the required current. The moment the current is switched off, a high voltage, typically between 20 and 30 kV, is generated on the secondary output, to ensure ignition of the spark. Since the high voltage is generated by releasing the induction energy stored by the primary inductance, these ignition systems are also called "inductive discharge".

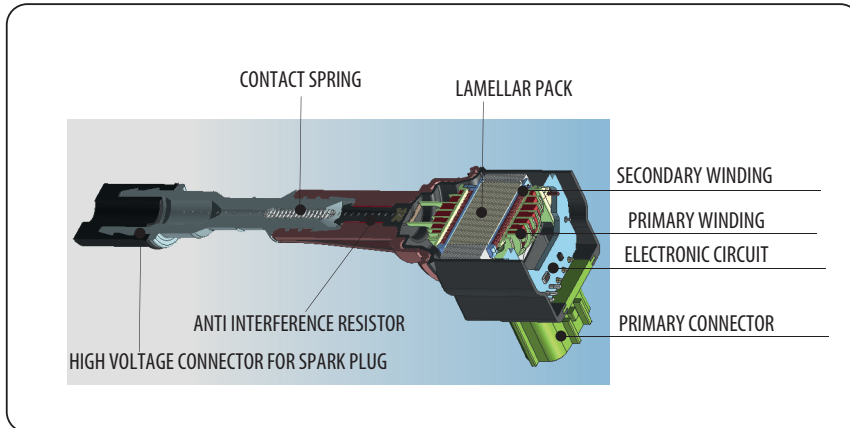

• Mechanical distribution coils:

These are individual coils and the high voltage is "distributed" to the spark plugs through special H.V. cables (abbreviation for High Voltage), by a rotor fitted on the distributor under the "cap". In mechanical distribution ignition systems, the high voltage supplied by the coil is transferred by special high voltage cables and "distributed" to the spark plugs by means of a "commutator rotor" under the distributor "cap", moved by the engine shaft. After a few micro-seconds, when the high voltage exceeds about 15 kV (as an absolute value), the spark is ignited between the electrodes of the spark plug.

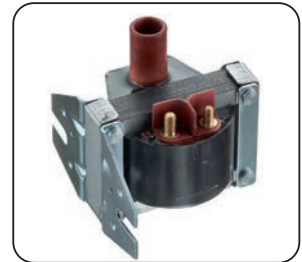

• Wasted spark coil (second generation):

This type of coil is called wasted spark because during the compression stroke there is a normal ignition spark, but during the exhaust stroke, when the gases have different electrical characteristics before and after combustion, there is a spark of lower intensity and therefore a small waste of energy.



• Direct ignition coil (third generation):

The negative output on the secondary winding is connected directly to a single spark plug, while the other end is connected to an earthing point through a low voltage connection, or to the positive terminal of the primary winding (+ battery) inside the coil. There is therefore a coil for each spark plug.





1.970.XXX/1.990.XXX BOBINE DI ACCENSIONE

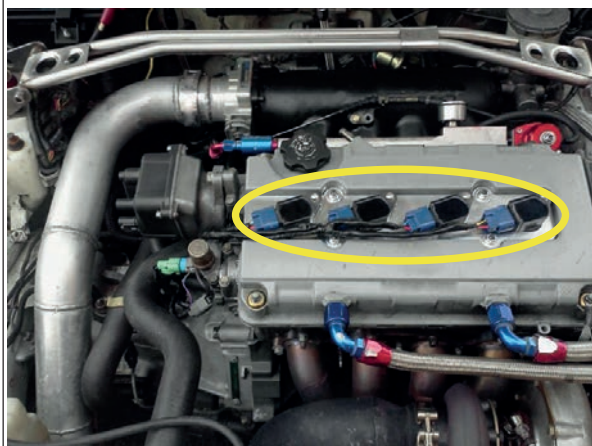

Le bobine d'accensione consentono di accumulare una carica nel sistema elettrico a bassa tensione del veicolo, immagazzinata e fatta scoppiare con una scintilla elettrica prodotta dalla candela per fare accendere in modo ottimale la miscela aria/carburante in modo che si verifichi la combustione completa nei motori a scoppio.

Principali cause malfunzionamento:

- corto circuito per surriscaldamento
- alimentazione insufficiente
- rottura cavo
- batteria scarica
- stress meccanici, elettrici e chimici
- umidità

Effetti malfunzionamento:

- mancato avviamento del motore
- problemi di accelerazione e calo di potenza
- funzionamento di emergenza della centralina
- accensione della spia di controllo motore
- emissioni NOX
- danni al convertitore catalitico

Le bobine di accensione sono progettate e costruite per sopportare le condizioni critiche di montaggio nel vano motore. In particolare devono soddisfare i seguenti requisiti:

- temperatura di funzionamento:
 - da - 40°C a + 125°C per i dispositivi montati sulla testa del motore (tipicamente, Pencil Coil); le parti a contatto con la candela devono resistere a 180°C.

Le bobine sono sottoposte a **rigorose prove di qualificazione e di durata** per stabilire se il prodotto è idoneo per essere costruito e venduto:

- Prova di immunità elettromagnetica
- Prova di resistenza ai cicli rapidi di temperatura
- Prova di rigidità dielettrica a scarica libera
- Prova di durata
- Prova di resistenza alle vibrazioni

Superate tali prove e concesso il benessere a produrre, durante l'assemblaggio il prodotto viene sottoposto a severi cicli di controllo che prevedono il **collaudo al 100%**.

Elementi costruttivi e principio di funzionamento

Gli elementi costruttivi principali di una bobina moderna sono:

- circuito elettrico primario (filo di rame avvolto sul rocchetto primario)
 - circuito elettrico secondario (filo di rame avvolto sul rocchetto secondario)
 - il circuito magnetico (pacco lamellare)
 - circuito elettronico
 - il vassoio (contenente gli altri elementi inglobati in resina epossidica)
 - elementi vari (incorporati solamente in alcuni modelli): il soppressore di disturbi, il diodo ad alta tensione, l'interruttore elettronico di potenza, ecc.
- L'avvolgimento primario viene pilotato dall'interruttore elettronico fino a raggiungere la corrente richiesta. Nell'istante di interruzione della corrente, sull'uscita secondaria viene generata l'alta tensione tipicamente compresa tra 20 e 30 kV per garantire l'innesco della scintilla. Poiché l'alta tensione è generata liberando l'energia induttiva immagazzinata dall'induttanza del primario, questi sistemi di accensione vengono anche chiamati "a scarica induttiva".

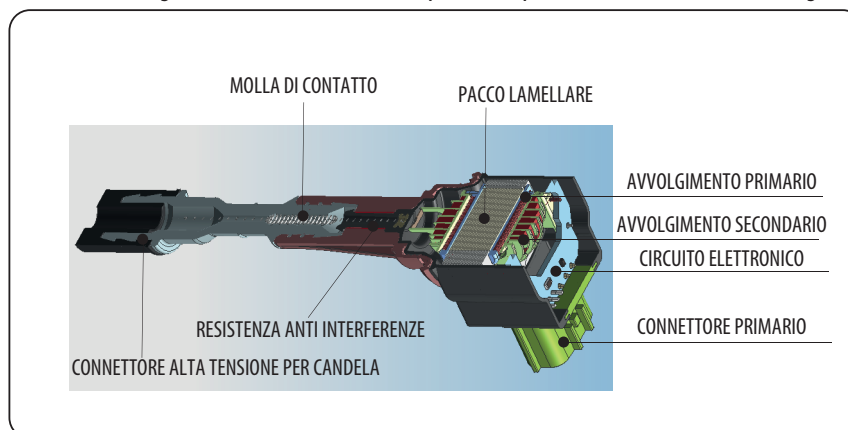

• Bobine per distribuzione meccanica:

Si tratta di bobine singole e l'alta tensione viene "distribuita" alle candele, tramite appositi cavi A.T. (abbreviazione di Alta Tensione), da un distributore rotante montato sullo spinterogeno, all'interno della "calotta". Nei sistemi di accensione a distribuzione meccanica, l'alta tensione erogata dalla bobina viene trasportata tramite appositi cavi ad alta tensione e "distribuita" alle candele tramite un "commutatore rotante" posto nella "calotta" (distributore) e mosso dall'albero motore. Dopo pochi microsecondi, quando l'alta tensione supera (come valore assoluto) i 15 kV circa, si innesca la scintilla tra gli elettrodi della candela.

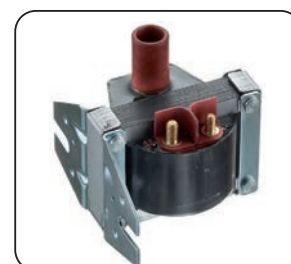

• Bobine a scintilla persa (seconda generazione):

Questo tipo di bobina viene chiamato a scintilla persa perché, mentre nel cilindro in fase di compressione si ha la normale scintilla di accensione, grazie alle diverse caratteristiche elettriche dei gas prima e dopo la combustione, nel cilindro in fase di scarico si ha una scintilla di piccola intensità e quindi una piccola perdita di energia.

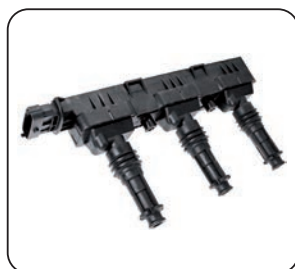

• Bobine dirette (terza generazione):

L'uscita negativa del secondario è collegata ad una sola candela direttamente, l'altro capo è collegato a massa con una connessione a bassa tensione, oppure al terminale positivo del primario (+ batteria) all'interno della bobina. Abbiamo quindi una bobina per ogni candela.





1.970.XXX/1.990.XXX BOBINES D'ALLUMAGE

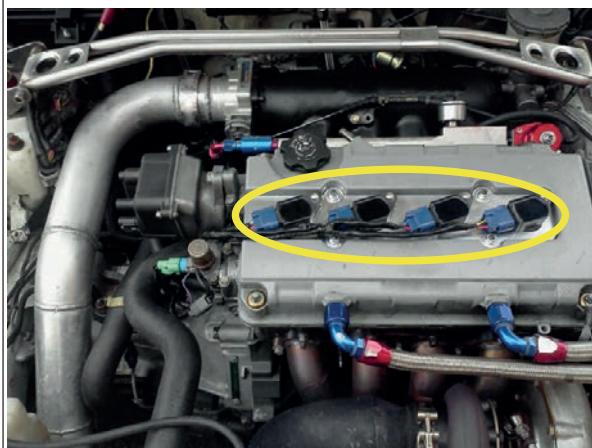

Les bobines d'allumage permettent d'accumuler de l'énergie dans le système électrique à basse tension du véhicule. Stockée, celle-ci permet aux bougies de créer l'étincelle électrique afin d'allumer de manière optimale le mélange air/carburant garantissant ainsi une combustion complète sur les moteurs à combustion.

Principales causes de dysfonctionnement:

- court-circuit dû à une surchauffe
- alimentation insuffisante
- rupture câble
- batterie à plat
- stress mécaniques, électriques et chimiques
- humidité

Conséquences du dysfonctionnement:

- le moteur ne s'allume pas
- problèmes d'accélération et baisse de puissance
- le boîtier électronique fonctionne en urgence
- voyant de contrôle moteur allumé
- émissions NOX
- dommages sur le convertisseur catalytique

Les bobines d'allumage sont conçues et construites pour supporter des conditions difficiles de montage sous le capot. Elles doivent notamment respecter les critères suivants :

- température de fonctionnement :
 - de - 40°C à + 125°C pour les dispositifs montés sur la tête du moteur (habituellement, bobines-crayon);
 - les parties au contact de la bougie doivent résister à 180°C.

Les bobines sont soumises à des tests **rigoureux de qualité et de longévité** garantissant un produit adapté à la construction et à la vente :

- Test d'immunité électromagnétique
- Test de résistance aux cycles rapides de température
- Test de rigidité diélectrique à décharge libre
- Test de durée
- Test de résistance aux vibrations

Si ces tests sont réussis et le feu vert pour la production est donné, lors de l'assemblage, le produit est à nouveau soumis à des cycles de contrôle qui prévoient son **inspection à 100 %**.

Éléments et principes de fonctionnement

Les éléments principaux d'une bobine moderne sont :

- circuit électrique primaire (fil de cuivre enroulé autour du bobinage primaire)
- circuit électrique secondaire (fil de cuivre enroulé autour du bobinage secondaire)
- le circuit magnétique (paquet magnétique)
- le plateau (contenant les autres éléments englobés en résine époxy)
- éléments divers (présents seulement sur certains modèles) : l'antiparasite, la diode à haute tension, l'interrupteur électronique de puissance, etc. Le bobinage primaire est piloté par l'interrupteur électronique jusqu'à ce que le courant requis soit atteint. Au moment de l'interruption du courant, une haute tension, habituellement comprise entre 20 et 30 kV, est générée sur la sortie secondaire pour garantir l'étincelle. Puisque la haute tension est générée en libérant l'énergie inductive stockée par l'inductance du circuit primaire, ces systèmes d'allumage sont également appelés « à décharge inductive ».

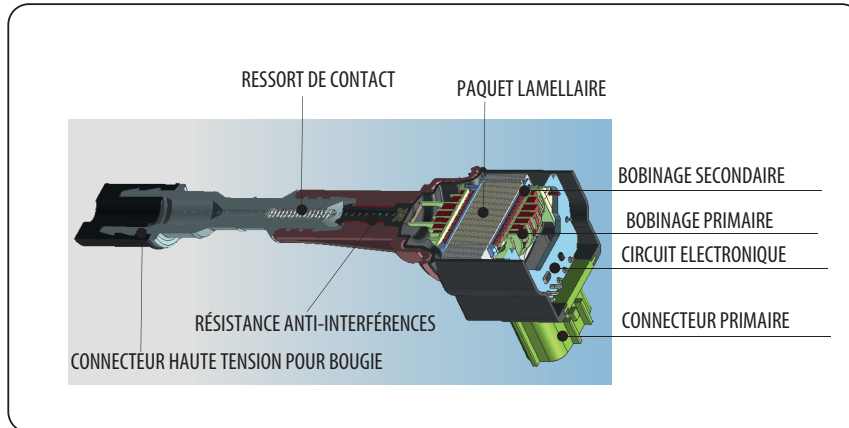

• Bobines pour distribution mécanique:

Il s'agit de bobines simples et la haute tension est distribuée aux bougies avec des câbles H.T. (abréviation de haute tension), par un distributeur tournant monté sur l'allumeur, à l'intérieur de la tête de delco. Sur les systèmes d'allumage à distribution mécanique, la haute tension fournie par la bobine est transportée par des câbles à haute tension et distribuée aux bougies avec un commutateur tournant placé dans la tête de delco (distributeur) et mis en mouvement par l'arbre moteur. Après quelques microsecondes, lorsque la haute tension dépasse (en valeur absolue) les 15 kV environ, l'étincelle est produite sur les électrodes de la bougie.

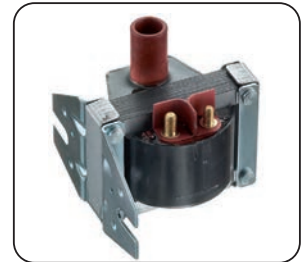

• Bobine à étincelle perdue (seconde génération):

Ce type de bobine est appelée de la sorte, car tandis que dans le cylindre en phase de compression l'on obtient une étincelle d'allumage normale, avec les différentes caractéristiques électriques des gaz avant et après la combustion, dans le cylindre en phase de déchargement, l'on obtient une étincelle de faible intensité et donc une perte d'énergie moindre. Elles peuvent être des typologies suivantes : Bobines avec 2 sorties H.T.



• Bobinas directas (tercera generación):

La sortie négative du bobinage secondaire est directement branchée sur une seule bougie, l'autre extrémité étant reliée à la masse avec une connexion à basse tension, ou au pôle positif du circuit primaire (+ batterie) à l'intérieur de la bobine. Nous avons donc une bobine pour chaque bougie.





1.970.XXX/1.990.XXX ZÜNDSPULEN

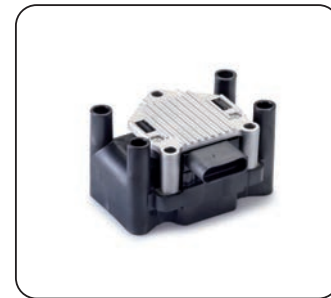
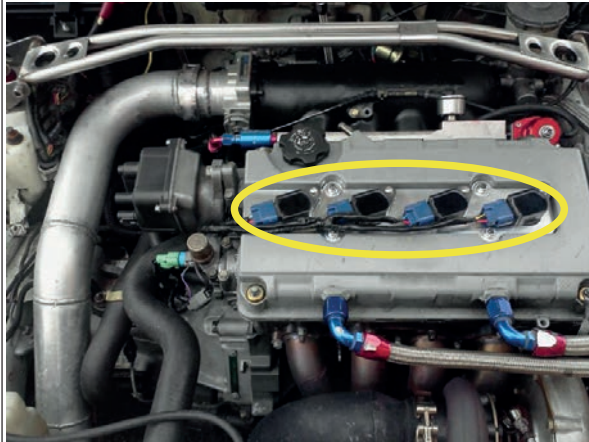

Die Zündspulen dienen als Transformatoren, indem sie für Hochspannungsimpulse sorgen.

Der Zweck dieser Impulse ist es, einen Funken (Lichtbogen) zwischen den Elektroden der Zündkerzen des Verbrennungsmotors zu erzeugen, dessen Intensität und Dauer ausreicht, um die Verbrennung des Gemischs aus Luft und Treibstoff im Inneren richtig in Gang zu setzen.

Wichtigste Störungsursachen:

- Kurzschluss durch Überhitzen
- unzureichende Versorgung
- Kabelbruch
- entladene Batterie
- mechanische, elektrische und chemische Beanspruchungen
- Feuchtigkeit

Störungsauswirkungen:

- nicht erfolgtes Anspringen des Motors
- Beschleunigungsprobleme und Leistungsabfall
- Notbetrieb des Steuergeräts
- Aufleuchten der Motorkontrollanzeige
- NOX-Emissionen
- Schäden am Katalysator

Die Zündspulen wurden so entwickelt und gebaut, dass sie den kritischen Bedingungen der Montage im Motorraum standhalten. Insbesondere müssen sie die folgenden Anforderungen erfüllen:

- Betriebstemperatur:
 - von - 40°C bis + 125°C für auf dem Motorkopf montierte Vorrichtungen (normalerweise Pencil Coil); die mit der Zündkerze in Kontakt geratenden Teile müssen 180°C standhalten.

Die Zündspulen werden **strengen Prüfungen hinsichtlich Qualifizierung und Beständigkeit unterzogen**, um festzustellen, ob das Produkt sich für die Herstellung und den Verkauf eignet:

- Prüfung der elektromagnetischen Störfestigkeit
- Prüfung der Beständigkeit bei schnellen Temperaturwechseln
- Prüfung der Durchschlagfestigkeit bei freier Entladung
- Dauerversuch
- Prüfung der Schwingungsfestigkeit

Nachdem es diese Prüfungen bestanden und die Produktionsgenehmigung erhalten hat, wird das Produkt strengen Kontrollzyklen unterzogen, die die **100 % Endabnahme vorsehen**.

Bauteile und Funktionsprinzip

Die wichtigsten baulichen Elemente einer modernen Zündspule umfassen:

- Primärstromkreis (auf die Primärspule gewickelter Kupferdraht)
- Sekundärstromkreis (auf die Sekundärspule gewickelter Kupferdraht)
- Magnetischer Kreis (Paket)
- das Tablett (das die anderen in Epoxidharz eingeschlossenen Elemente enthält)
- verschiedene Elemente (nur in einige Modelle eingebaut): den Störungsunterdrücker, die Hochspannungsdiode, den elektronischen Leistungsschalter, usw. Die Primärwicklung wird von dem elektronischen Schalter bis zum Erreichen des gewünschten Stroms gesteuert. Im Moment der Stromunterbrechung wird auf dem Sekundärausgang die normalerweise zwischen 20 und 30 kV liegende Hochspannung erzeugt, um den Funkenschlag zu garantieren. Da die Hochspannung durch das Freisetzen von von der Induktanz des Primärstromkreises gespeicherter induktiver Energie erzeugt wird, werden diese Zündsysteme auch „Systeme mit induktiver Entladung“ genannt.

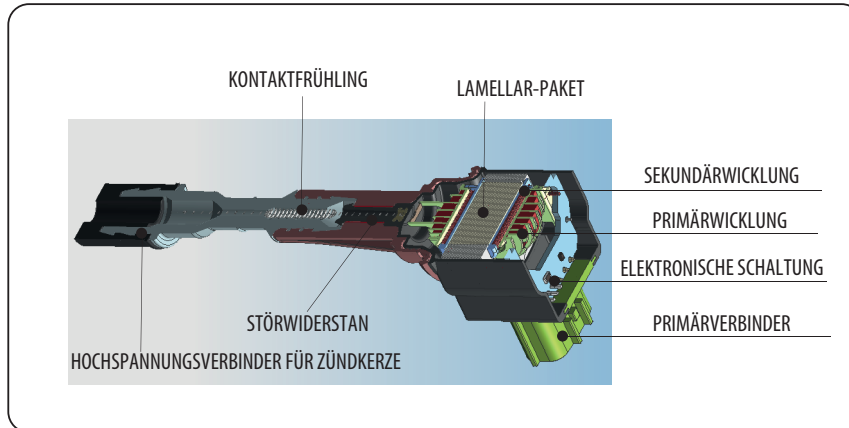

• Zündspulen zur mechanischen Verteilung:

Es handelt sich um Einzelspulen und die Hochspannung wird an die Zündkerzen über entsprechende HS-Kabel „verteilt“ (Abkürzung von Hochspannung), und zwar über einen im Inneren der „Haube“ auf dem Zündverteiler montierten Drehverteiler. In Zündsystemen mit mechanischer Verteilung wird die von der Zündspule abgegebene Hochspannung mit Hilfe entsprechender Hochspannungskabel befördert und an die Kerzen über einen in der „Haube“ (Verteiler) positionierten und von der Motorwelle angetriebenen „Drehkommutator“ verteilt. Nach wenigen Mikrosekunden wird, wenn die Hochspannung (als absoluten Wert) ca. 15 kV übersteigt, der Funke zwischen den Elektroden der Zündkerze gezündet.

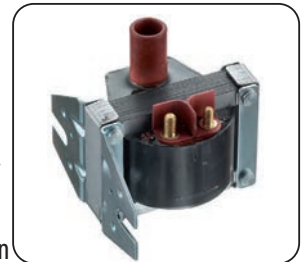

• Doppelfunkenzündspulen (zweite generation)

Dieser Spulentyp wird als Doppelfunkenzündspule bezeichnet, da bei Zylinder in Kompressionsphase der normale Zündfunke erzeugt wird, aufgrund der unterschiedlichen elektrischen Eigenschaften der Gase vor und nach der Verbrennung wird im Zylinder beim Entladen ein Funke geringer Intensität erzeugt und damit ein geringer Energieverlust. Es gibt die folgenden Typen: Spulen mit zwei HS-Ausgängen.



• Direkte Zündspulen (dritte Generation):

Der negative Ausgang des Sekundärstromkreises ist an nur eine Kerze direkt angeschlossen, das andere Ende ist mit einem Niederspannungsanschluss an die Masse angeschlossen bzw. an die positive Klemme des Primärstromkreises (+ Batterie) im Inneren der Spule. Wir haben also eine Spule für jede Kerze.





1.970.XXX/1.990.XXX

BOBINAS DE ENCENDIDO

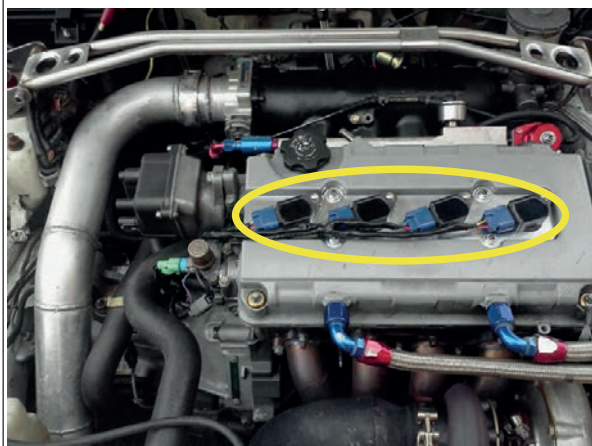

Las bobinas de encendido permiten acumular una carga en el sistema eléctrico de baja tensión del vehículo, que se almacena y se hace explotar con una chispa eléctrica generada por la bujía para encender de forma óptima la mezcla de aire/combustible y para que se produzca la combustión completa en los motores de explosión.

Causas principales de mal funcionamiento:

- cortocircuito por recalentamiento
- alimentación insuficiente
- rotura del cable
- batería descargada
- estrés mecánico, eléctrico y químico
- humedad

Efectos de un mal funcionamiento:

- falta de arranque del motor
- problemas de aceleración y disminución de potencia
- funcionamiento de emergencia de la centralita
- encendido del testigo de control del motor
- emisiones NOX
- daños al convertidor catalítico

Las bobinas de encendido están diseñadas y fabricadas para soportar las condiciones críticas de montaje en el compartimento del motor. En especial, deben cumplir los siguientes requisitos:

- temperatura de funcionamiento:
 - de - 40°C a + 125°C para los dispositivos montados en el cabezal del motor (típicamente, Pencil Coil); las partes en contacto con la bujía deben resistir 180°C.

Las bobinas se someten a **rigurosas pruebas de cualificación y de duración** para determinar si el producto es apto para la fabricación y la venta:

- Prueba de inmunidad electromagnética
- Prueba de resistencia a los ciclos rápidos de temperatura
- Prueba de rigidez dieléctrica de descarga libre
- Prueba de duración
- Prueba de resistencia a las vibraciones

Tras superar esas pruebas, y con la aprobación para la producción, durante el ensamblaje el producto se somete a severos ciclos de control que constituyen el **ensayo al 100%**.

Elementos constructivos y principio de funcionamiento

Los elementos constructivos principales de una bobina moderna son:

- circuito eléctrico primario (alambre de cobre envuelto en el carretel primario)
- circuito eléctrico secundario (alambre de cobre envuelto en el carretel secundario)
- el circuito magnético (paquete)
- la bandeja (que contiene los otros elementos englobados en resina epoxy)
- elementos varios (incorporados solamente en algunos modelos): el supresor de disturbios, el diodo de alta tensión, el interruptor electrónico de potencia, etc. El bobinado primario está controlado por el interruptor electrónico hasta que alcanza la corriente prevista. En el instante de interrupción de la corriente, en la salida secundaria se genera la alta tensión que típicamente es de 20 a 30 kV, para garantizar el encendido de la chispa. Como la alta tensión se genera liberando la energía inductiva almacenada por la inductancia del primario, estos sistemas de encendido también se llaman "de descarga inductiva".

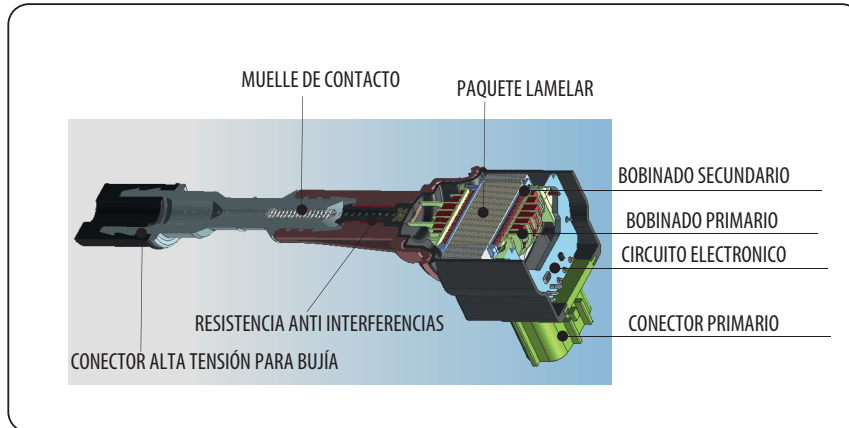

• Bobinas para distribución mecánica:

Se trata de bobinas individuales, y la alta tensión se "distribuye" a las bujías mediante los correspondientes cables A.T. (abreviatura de Alta Tensión) mediante un distribuidor giratorio montado en el distribuidor de encendido, en el interior de la "tapa". En los sistemas de encendido de distribución mecánica, la alta tensión distribuida por la bobina se transporta mediante los correspondientes cables de alta tensión y se "distribuye" a las bujías mediante un "conmutador giratorio" presente en la "tapa" (distribuidor) y movido por el árbol motor. Después de pocos microsegundos, cuando la alta tensión supera (como valor absoluto) los 15 kV aproximadamente, se enciende la chispa entre los electrodos de la bujía.

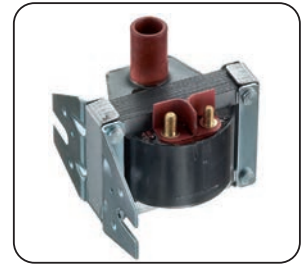

• Bobinas de chispa perdida (segunda generación):

Este tipo de bobina se llama de chispa perdida porque, mientras en el cilindro en fase de compresión se tiene la chispa normal de encendido, gracias a las distintas características eléctricas de los gases antes y después de la combustión, en el cilindro en fase de descarga se tiene una chispa de baja intensidad y, por lo tanto, una pequeña pérdida de energía. Pueden ser de los siguientes tipos: Bobinas con 2 salidas A.T.



• Bobinas directas (tercera generación):

La salida negativa del secundario está conectada a una sola bujía directamente, el otro extremo está conectado a masa con una conexión de baja tensión, o al terminal positivo del primario (+ batería) dentro de la bobina. Por lo tanto, tenemos una bobina por cada bujía.



EPS 1.970.101D



07

COILS

Adatt./Suitable:

ALFA ROMEO

510 897
116 42 65 079 00
60744199

BMW

12 13 1 357 296
12 13 1 359 637

CITROËN

DM 212 08B

DAF

316447

FIAT

39322140
4071394
4158493

HITACHI

CI Z500
CI Z500E

INNOCENTI

39322140

ISUZU

981360005
981360007
982511535
982513508
9-82513508-0
982513509
9-82513509-0

LADA

2101-3705000-02
21013-7050560
2101-3705060-00

LANCIA

4158493

LAND ROVER

PRC9858
RTC5629

MAGIRUS-DEUTZ

41912606

MERCEDES-BENZ

A 000 158 00 03
A 000 158 38 03

PEUGEOT

5970 11
5970 28

RENAULT

77 00 552 370
77 00 562 370
77 01 348 252

ROVER

GCL110
RTC3433

SAAB

85 22 328

SEAT

SE 141915.000A

TALBOT

0055 50 5600

VOLVO

3638411
36384113

VW

043 905 115 A
043 905 115 C
052 905 105
221 100 019

1116 Universal coil (except for electronic ignition)

- Bobina universale (esclusa accensione elettronica)
- Bobine universelle (sauf système d'allumage électronique)
- Universalzündspulen (nicht für elektronische Zündsysteme)
- Bobina universal (con excepción del encendido electrónico)

960 Dry (epoxy) coil replacing original oil-bath coil version

- Bobina (resinizzata) sostituyente originale a bagno d'olio
- Bobine seche, remplaçant la bobine d'origine à bain d'huile
- Trockenspule, die die Originale im Ölbad ersetzt
- Bobina seca, sustituye modelo original con baño de aceite

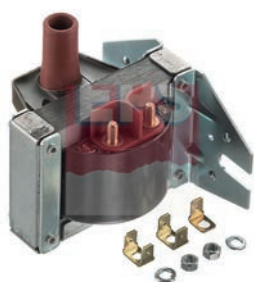

		ohm			ohm
-	+	1,75	Ø 8,2		10500
M5	M5				

ALFA ROMEO

ALFASUD 1.2	AR30102	06/72 ⇒ 09/84
ALFETTA 1.8	AR01608X	07/74 ⇒ 04/82
GIULIETTA I 1.3	AR01644	10/77 ⇒ 06/83

DACIA

1210 1.2	--	01/69 ⇒
1310 1.3	810-02/-99	05/83 ⇒ 07/04
1410 1.4	--	01/69 ⇒

FIAT

124 1200	124A.000	07/66 ⇒ 10/73
124 1400 Special	124B2.000	12/68 ⇒ 12/72

FIAT

124 1600 Special T	132AC.000	01/73 ⇒ 07/75
126 600	126A.000	09/72 ⇒ 06/77
127 0.9	100GL.000, 100GL.048	06/71 ⇒ 12/84
127 1.0	127A.000	01/77 ⇒ 12/86
128 1.1	128A.000	03/69 ⇒ 12/84
131 1.3 Mirafiori	131A6.000	10/74 ⇒ 09/81
132 1.6	132C.000	05/77 ⇒ 09/82
242 1.6	124B3.000	10/75 ⇒ 07/82
500 0.5	110F.000, 120.000	01/60 ⇒ 12/75
500 0.6	111A000	08/68 ⇒ 01/76
DUCATO I 1.8	169B	01/82 ⇒ 12/88
600 0.6	--	03/55 ⇒ 05/61
850 0.8	100G.000	07/64 ⇒ 10/72
ARGENTA 1600	132D.000	04/81 ⇒ 12/85
ARGENTA 1600 i.e	132D.000	04/81 ⇒ 12/85
FIORINO I 1.0	127A.000	01/80 ⇒ 12/87
FIORINO I 1050	127A.000	01/80 ⇒ 12/87
FIORINO I 900	100GL.000	10/77 ⇒ 10/86
PANDA I 1000	156A2.000	12/93 ⇒
PANDA I 1000 CLX	156A2.000	05/91 ⇒ 12/94
PANDA I 1000 Fire	156A2.000	05/86 ⇒ 04/91
PANDA I 1000 Fire [DEU]	156A2.048	01/86 ⇒ 07/89
PANDA I 750	141B.000, 156A4.000	01/86 ⇒ 01/95
PANDA I 800	100GL6.000	02/81 ⇒ 12/85
PANDA I 900	100GL3.000	10/80 ⇒ 06/94
PANDA I 900 CL	146A.048	01/86 ⇒ 12/92
PANDA I 950	A112B1.054	09/82 ⇒ 08/83
PANDA I 950 4x4	A112B1.054	09/83 ⇒ 12/86
REGATA 1.1 60, 60 L	138B.000	10/83 ⇒ 08/86
REGATA 1.6	149A.000	10/84 ⇒ 06/89
REGATA 70 1.3	138B2.000, 149A3.000	09/83 ⇒ 07/89
REGATA 85 1.6	149A.000	10/83 ⇒ 06/90
RITMO I 1.1	146A4.048	04/85 ⇒ 12/87
RITMO I 1.3	149A3.000	11/83 ⇒ 08/85
RITMO II 75 1.5	138A2.000	09/85 ⇒ 12/88
UNO 45 0.9	146A.000, 146A1.000	03/83 ⇒ 07/96
UNO 45 0.9 Trend	146A.048	09/89 ⇒ 09/92
UNO 60 1.1 SX	--	01/83 ⇒ 12/85
X 1/9 1.3	128A5.000	10/75 ⇒ 06/78

FSO

126P 0.6	--	09/72 ⇒ 07/77
POLONEZ I 1.5	AA	10/77 ⇒ 08/88

INNOCENTI

MINI 120	--	01/75 ⇒ 12/83
----------	----	---------------

LADA

NIVA I 1600	BA32121	12/76 ⇒ 12/93
-------------	---------	---------------

LANCIA

A 112 0.9 Junior	A112A5.000	03/81 ⇒ 06/86
------------------	------------	---------------

LAND ROVER

90 2.5 4x4	17H	09/85 ⇒ 08/90
110/127 2.5 4x4	17H	10/85 ⇒ 07/90
DEFENDER 2.25	--	01/87 ⇒
DEFENDER 2.5 90, 110	--	08/90 ⇒ 09/01

MERCEDES-BENZ

0 309	M115.921, M115.952	01/68 ⇒ 02/89
-------	--------------------	---------------

PEUGEOT

305 1.5	117(XR5S)	05/80 ⇒ 09/82
505 1.8	105(XM7)	06/81 ⇒ 10/85

RENAULT

4 0.8	80001	09/71 ⇒ 12/88
5 1.3	810719, 810726	09/76 ⇒ 09/84
5 1.4 Alpine A5	840725	09/77 ⇒ 09/81
9 1.2	C1G700, C1G710	09/85 ⇒ 12/88
11 1.1	C1E715, C1E720	03/83 ⇒ 06/86
11 1.2	C1G700, C1G710	10/84 ⇒ 12/88
20 2.0	829700, 829701, 829702, 829703, 829.01	10/77 ⇒ 12/83

SEAT

FURA 0.9	100GL3000	01/82 ⇒ 06/86
IBIZA I 0.9	146A000	08/86 ⇒ 05/93
MARBELLA 0.8	5K9K718	08/86 ⇒ 12/93
MARBELLA 0.9	09NCA	01/87 ⇒ 12/93
PANDA 0.9	100GL3000	10/80 ⇒ 12/86
PANDA 34 850	--	01/80 ⇒ 12/83
PANDA 35 850	--	01/80 ⇒ 12/83
PANDA 45	--	01/82 ⇒ 12/85
TERRA 0.9	09NCA	02/87 ⇒ 12/96

TALBOT

TAGORA 2.1	5N2	06/80 ⇒ 12/83
------------	-----	---------------

ZASTAVA

101 1.1	128A.000, 128A.064	06/73 ⇒ 12/93
101 1.1 Super	128AC5.000	07/79 ⇒ 09/81

EPS 1.970.102



07,5

COILS

Adatt./Suitable:

BOSCH

0 986 221 028

DUCELLIER

2 526 015
2 526 015 A

FIAT

7588435

MAGNETI MARELLI

060705404010
607 056 01
BAE 506 A

03 Supplied until depletion

- Fornibile fino ad esaurimento delle scorte
- Fourni jusqu'à épuisement du stock
- Lieferbar solange vorrat reicht
- Suministrado hasta el stock termina



		ohm			ohm
		0,75	Ø 8,2		6000
6,4					

FIAT

CROMA I 2000 CHT	154A1.000	12/85 ⇒ 02/89
FIORINO I 1.5	149C1.000	01/88 ⇒ 08/93
FIORINO II 1.5 iE	149C1.000	01/88 ⇒ 10/92
FIORINO II 75 i.e. 1.5	149C1.000	05/88 ⇒ 12/93
REGATA 70 1.3	138B2.000, 149A3.000	09/83 ⇒ 07/89
REGATA 85 1.5	149A5.000	05/85 ⇒ 12/87
RITMO I 1.3	149A3.000	11/83 ⇒ 08/85
RITMO I 1.5	138C2.048	10/85 ⇒ 05/87
UNO 45 1.0 Fire	--	01/83 ⇒ 12/89
UNO 60 1.1 SX	--	01/85 ⇒ 12/89

EPS 1.970.103



07,5

COILS

Adatt./Suitable:

BOSCH

0 221 119 030
0 221 122 012

FIAT

4386221
4460205

LANCIA

4386221
4460205

MAGNETI MARELLI

607 029 02
607 029 03
BAE 209 B
BAE 209 C

03 Supplied until depletion

- Fornibile fino ad esaurimento delle scorte
- Fourni jusqu'à épuisement du stock
- Lieferbar solange vorrat reicht
- Suministrado hasta el stock termina



		ohm			ohm
		0,35	Ø 8,2		6000
6,4					

FIAT

ARGENTA 2000 i.e.	132C3.000	06/81 ⇒ 07/86
CROMA I 1600	154A.048	12/85 ⇒ 12/90

FIAT			
CROMA I 2000 CHT	154A1.000	12/85 ⇒	02/89
FIORINO I 1.5	149C1.000	01/88 ⇒	08/93
FIORINO II 1.5 iE	149C1.000	01/88 ⇒	10/92
FIORINO II 75 i.e. 1.5	149C1.000	05/88 ⇒	12/93
REGATA 1.6	--	09/86 ⇒	06/89
REGATA 100 Super 1.6	149A2.000	10/83 ⇒	12/90
REGATA 85 1.5	149A5.000	05/85 ⇒	12/87
RITMO I 1.6	149A4.000	01/83 ⇒	12/87
RITMO II 75 1.5	138A2.000	09/85 ⇒	12/88
UNO 70 1.3i SX	--	01/83 ⇒	12/89
UNO 75 i.e. 1.5	138C2.048	10/85 ⇒	12/93

LANCIA			
BETA 1600	828B.000	08/73 ⇒	07/82
DELTA I 1.5	831A1.000, 831B1.000	09/79 ⇒	12/92
PRISMA 1.5	831B1.000	05/86 ⇒	07/89
PRISMA 1.6	831B6.000	08/86 ⇒	02/92

EPS 1.970.105



05

COILS

Adatt./Suitable:

BOSCH

F 000 ZS0 114

CITROËN

5970 43

96 010 513

97 530 780

DUCELLIER

520 073

520 073 A

HITACHI

138754

2508754

MAGNETI MARELLI

060717014012

PEUGEOT

5970 43



	ohm	Ø 6.3	ohm
	0,68		6800

CITROËN

AX 1.3 Sport	M4A	04/87 ⇒	12/88
AX 10	C1A	09/86 ⇒	06/92
AX 10 E	C3A	12/86 ⇒	12/88
AX 11	H1A, H1B, HDZ(TU1M)	09/86 ⇒	12/97
AX 11 4x4	H1A	06/91 ⇒	07/92
AX 11 Cat	HAZ(TU1CP)	09/88 ⇒	12/89
AX 14	K1A(TU3), K1B, K1F, K1G, K1J, K2A, K2B, K2D, KAY(TU3CP), KDY(TU3M/Z), KDY(TU3FM)	09/86 ⇒	04/97

AX 14 4x4	KDY(TU3FM)	08/91 ⇒	12/96
AX 14 GT	KDZ(TU3M/Z)	01/89 ⇒	12/91
BX 1.1	109LA, H1A	04/86 ⇒	06/91
BX 1.4	150C, K1F, K2D	07/86 ⇒	12/94
BX 1.4 E	150B(XY8), 150J, 150Y, K1F, KAZ	09/82 ⇒	12/94
BX 1.6	182A, B6D, B6E	01/87 ⇒	12/94
BX 1.9	159C, D6U, DKK	09/85 ⇒	12/94
BX 1.9 GTi	D6D, D6K	01/87 ⇒	01/92
BX 14	150C, KDY(TU3M), KDZ(TU3M/Z)	01/86 ⇒	02/93
BX 14 E	150A, 150C, K1G	10/82 ⇒	02/93
BX 16	180Z	03/86 ⇒	12/94
BX 19	D6A(XU9J2), DKZ(XU9JA)	07/86 ⇒	12/94
BX 19 Cat	DFZ(XU9J1)	07/86 ⇒	12/94
BX 19 GTi	D6A(XU9J2), DKZ(XU9JA)	07/86 ⇒	02/93
BX 19 GTi 4x4	DKZ(XU9JA)	06/88 ⇒	02/93

CITROËN

C15 1.0	108C(XV8), C1A, C1A(TU9/K), C1B(TU9/W), TU9	10/84 ⇒	12/97
C15 1.1	H1A, HDZ(TU1M), TU1	08/88 ⇒	07/96
C15 1.1 i	HDZ(TU1M), TU1M2	07/88 ⇒	12/96
C15 1.4	K1A, K1G, K1H(TU3A), KDY(TU3M)	07/87 ⇒	12/96
C15 1.4 E	K1F, K1J, K2D, K3A, KAZ	07/86 ⇒	12/96
C15 1.4 i	KDY(TU3FM), KDY(TU3M)	05/91 ⇒	12/96

PEUGEOT

205 I 1.4	TU3	01/83 ⇒	12/90
205 I 1.6 GTI	XU5J1	01/83 ⇒	12/90
205 I 1.9 GTI	D6B(XU9JA)	10/86 ⇒	10/87
205 II 1.0	TU9	10/87 ⇒	09/98
205 II 1.1	H1B(TU1), HDZ(TU1M)	10/87 ⇒	09/98
205 II 1.1 CJ	HDZ(TU1M)	10/89 ⇒	12/94
205 II 1.3	TU24	01/91 ⇒	12/94
205 II 1.3 Rallye	TU24	10/87 ⇒	10/90
205 II 1.4	K1D(TU3A), K2B(TU3S), KDY(TU3M), KDZ(TU3M)	06/87 ⇒	09/98
205 II 1.4 Cat	KAY(TU3CP)	08/87 ⇒	09/93
205 II 1.4 CJ	K1D(TU3A), KDY(TU3M), KDZ(TU3M)	03/89 ⇒	12/94
205 II 1.4 CJ Cat	KAY(TU3CP)	01/89 ⇒	09/93
205 II 1.6 GTI	XU5JA	01/91 ⇒	12/94
205 II 1.9 GTI	DFZ(XU9J1)	10/87 ⇒	12/94
205 II 1.9 CTI	D6B(XU9JA), DKZ(XU9JAZ)	10/87 ⇒	09/98
205 II 1.9 GTI Cat	DFZ(XU9J1)	10/87 ⇒	07/94
309 I 1.4	K1D(TU3A), K2B(TU3S), KDY(TU3M), KDZ(TU3M)	08/88 ⇒	08/89
309 II 1.1	H1B(TU1), HDZ(TU1M)	09/89 ⇒	12/93
309 II 1.4	KDZ(TU3M), TU3, TU3F2	07/89 ⇒	12/93
309 II 1.6	XU5JA	07/89 ⇒	12/93
309 II 1.6 GTi	--	09/89 ⇒	10/93
309 II 1.9 GTI	DKZ(XU9JAZ)	07/89 ⇒	12/93
405 I 1.4	K5A(TU3), TU3A, TU3F2	01/87 ⇒	12/92
405 I 1.9	DKZ(XU9JAZ)	06/87 ⇒	08/92
405 I 1.9 4x4	DKZ(XU9JAZ)	06/87 ⇒	07/92

EPS 1.970.106



07

COILS

Adatt./Suitable:

BOSCH

F 000 ZS0 113

CITROËN

5970 42

97 531 206

DUCELLIER

2 526 009

2 526 009 A

MAGNETI MARELLI

060705738010

060717015012

607 057 01

607 057 38

BAE 507 AK

PEUGEOT

5970 42



	ohm	Ø 6.3	ohm
	0,68		6800

CITROËN

BX 1.6	B2C	02/88 ⇒	12/94
BX 1.9	159B, 159C, D6U, DKK	05/85 ⇒	12/94
BX 1.9 GTi	D6D, D6K	01/87 ⇒	01/92
BX 1.9 GTi 16V	159K, DFK	01/87 ⇒	12/94
BX 15	B1E(XU51C)	01/87 ⇒	05/92
BX 16	171A, 171B, 171C, 171D, 23DH, B1E(XU51C), BAY(XU5CP), BAZ(XU5CP), BDY(XU5M), BDZ(XU5M)	10/82 ⇒	12/94
BX 16 E	BDY(XU5M), BDZ(XU5M)	05/89 ⇒	02/93

CITROËN

BX 19	159A, D2A(XU92C), D2C(XU92C), D2E, D6A(XU9J2), DKZ(XU9JA)	09/84 ⇒	12/94
BX 19 Cat	DFZ(XU9J1)	07/86 ⇒	12/94
BX 19 E 4x4	D2F	04/89 ⇒	02/93
BX 19 GTi	D6A(XU9J2), DKZ(XU9JA)	07/86 ⇒	02/93
BX 19 GTi 16V	D6C(XU9J4), DFW(XU9J4)	09/87 ⇒	02/93
BX 19 GTi 4x4	DKZ(XU9JA)	06/88 ⇒	02/93
C15 1.1	E1A	10/84 ⇒	12/96
C15 1.3	G1A	07/87 ⇒	05/88

PEUGEOT

205 I 1.3	G1A	02/84 ⇒	10/87
205 I 1.4	J2	01/83 ⇒	12/90
205 I 1.5	Y2/K	02/84 ⇒	10/87
205 II 1.1 XA	E1	07/87 ⇒	10/88
205 II 1.2	F1	01/87 ⇒	12/90
205 II 1.3	G1A	08/90 ⇒	07/92
205 II 1.4	J2	01/91 ⇒	12/94
309 I 1.1	E1	10/85 ⇒	07/89
309 I 1.3	G1A, G2S	10/85 ⇒	08/89
309 I 1.3 XL	--	09/86 ⇒	08/89
309 I 1.5	Y2/K	06/87 ⇒	12/89
309 I 1.6	--, J2	01/86 ⇒	07/89
309 II 1.6	18EM, BDZ(XU5M), J2	07/89 ⇒	12/93
309 II 1.9	XU92C	07/89 ⇒	12/93
309 II 1.9 GTI 16V	D6C(XU9J4)	08/89 ⇒	07/90
405 I 1.6	--, 18EM, B1E(XU51C), BDZ(XU5M)	01/87 ⇒	12/92
405 I 1.6 4x4	BDZ(XU5M)	04/88 ⇒	07/92
405 I 1.6 SRI 4x4	BDZ(XU5M)	04/88 ⇒	07/92
405 I 1.9	D2C(XU92C), D6A(XU9J2), D6C(XU9J4), XU9J2/D6D	01/87 ⇒	12/93
405 I 1.9 4x4	D6C(XU9J4)	06/87 ⇒	07/92
405 I 1.9 Antipollution	XU92C	01/87 ⇒	12/92
405 I 1.9 Sport MI-16	D6C(XU9J4), DFW(XU9J4Z)	06/87 ⇒	11/92
405 I 1.9 Sport MI-16 4x4	DFW(XU9J4Z)	06/87 ⇒	07/92
405 I 1.9 Trazione integrale	D6C(XU9J4)	06/87 ⇒	07/92
405 II 1.6	18EM	08/92 ⇒	05/97
405 II 1.9	XU92C	01/93 ⇒	12/96

EPS 1.970.107



05

COILS

Adatt./Suitable:

BOSCH

F 000 ZS0 115

CHRYSLER

T1031135

DUCELLIER

520 064

2 526 023

2 526 023 A

2 526 048 A

JEEP

T1031135

MAGNETI MARELLI

BAE 504 B

RENAULT

77 01 031 135

VOLVO

3287677

32876773

Eliminated on 25-11-2020. Please verify the availability through our local distributors

- Eliminato il 25-11-2020. Verificare la disponibilità presso i nostri distributori
- Éliminé le 25-11-2020. Vérifier la disponibilité auprès de nos distributeurs sur place
- Am 25-11-2020 gestrichen. Evtl. Verfügbarkeit bitte bei unseren Händlern prüfen
- Eliminado en fecha 25-11-2020. Verificar la disponibilidad a través de nuestros distribuidores locales

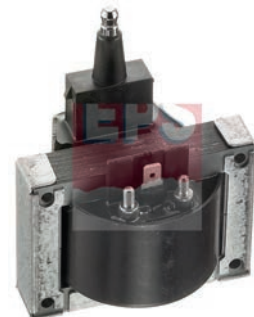

	ohm	Ø 6.3	ohm
	0,47		6000

ALPINE

V6 TURBO	Z7U730, Z7U732, Z7U734	01/88 ⇒	12/90
----------	------------------------	---------	-------

JEEP

CHEROKEE II 2.5	EPE, U150, Y246	10/83 ⇒	09/90
-----------------	-----------------	---------	-------

JEEP			
CHEROKEE II 2.5 4x4	EPE	10/86 ⇒	09/90
CHEROKEE II 4.0 i	1Z7K	10/86 ⇒	09/01
COMANCHE 2.5	EPE	10/86 ⇒	09/90
COMANCHE 4.0 i	1Z7K	10/87 ⇒	09/90
GRAND WAGONEER 4.0 i	1Z7K	10/86 ⇒	09/90
WAGONEER 2.5	EPE	10/83 ⇒	09/90
WAGONEER 4.0 i	1Z7K	10/86 ⇒	09/90
WRANGLER 4.0	1Z7K	10/86 ⇒	09/90
RENAULT			
18 1.4	847720, 847722	04/78 ⇒	07/86
18 1.6 TS	A6M725, A6M726	05/82 ⇒	07/86
18 2.0	J6R716	05/82 ⇒	07/86
19 1.1.2	C1G730	01/88 ⇒	12/92
19 1.1.2i	E7F	01/89 ⇒	12/92
19 1.1.4	C2J772, C2J776, C3J710, E6J700, E6J701, E7J700	01/88 ⇒	05/93
19 1.1.4 Cat	C3J710	01/89 ⇒	04/92
19 1.1.7	F2N720, F2N721, F2N722, F2N724, F3N740, F3N741, F3N742, F3N743, F3N746	07/88 ⇒	12/92
19 1.1.8 16V	F7P700, F7P704	06/89 ⇒	09/92
19 II 1.2	E7F730	05/92 ⇒	09/94
19 II 1.4	C3J710, E6J706, E7J706, E7J742, E7J745	01/92 ⇒	12/95
19 II 1.7	F2N720, F2N721, F2N726, F2N727, F3N740, F3N741, F3N742, F3N743, F3N746	09/90 ⇒	12/95
19 II 1.8	5F140FE, 8NA20S, F3P682, F3P704, F3P705, F3P706, F3P707, F3P708, F3P764, F3P765	04/92 ⇒	06/96
19 II 1.8 16V	F7P704	04/92 ⇒	06/96
21 1.4	C2J770, C2L714, C2L717	06/88 ⇒	12/95
21 1.6	C2L	01/87 ⇒	12/94
21 1.7	F2N710, F2N711, F2N712, F2N722, F2N750, F2N752, F2N754, F2N758, F2N786, F3N722, F3N723, F3N726	03/86 ⇒	12/95
21 1.7 Cat	F3N726	05/88 ⇒	06/93
21 2.0	14ZR, F2R702, J6R758, J6R793, J7R740, J7R747, J7R750, J7R751	03/86 ⇒	06/94
21 2.0 4x4	14ZR, J7R740, J7R747	03/89 ⇒	02/94
21 2.0 Turbo	J7R752, J7R756	04/87 ⇒	10/92
21 2.0 Turbo 4x4	J7R752, J7R756	08/89 ⇒	10/93
21 2.0 TXi	15CRMP10U1, J7R740	07/89 ⇒	05/93
21 2.2	J6T790, J6T791, J7T754, J7T755, J7T756	03/86 ⇒	12/95
21 2.2 4x4	J7T754, J7T755	06/86 ⇒	06/94
25 2.0	08A, J6R706, J6R707, J6R763, J7R722, J7R723	04/84 ⇒	12/93
25 2.0 12V	74AR-FXE, 7CYQD80D-E3, J7R721	06/88 ⇒	12/93
25 2.2	04TNV88-C, 74G69-S4M, J7T706, J7T707, J7T708, J7T715, J7T730, J7T731, J7T732	04/84 ⇒	12/92
25 2.4 V6 Turbo	Z7U702	10/84 ⇒	05/90
25 2.5 V6 Turbo	Z7U700	01/90 ⇒	12/92
25 2.8 V6	Z7W700, Z7W701	06/87 ⇒	02/90
25 2.8 V6 Injection	Z7W706, Z7W707, Z7W709	06/87 ⇒	12/92
CLIO I 1.2	E5F710, E5F716, E7F700, E7F706, E7F708, E7F750	05/90 ⇒	09/98
CLIO I 1.4	E6J712, E6J713, E6J718, E7J601, E7J710, E7J711, E7J716, E7J718, E7J719, E7J754, E7J756, E7J757	01/90 ⇒	09/98
CLIO I 1.7	F2N770	01/91 ⇒	12/93
CLIO I 1.8	OHR10DE, F3P710, F3P714, F3P754	08/90 ⇒	09/98
CLIO I 1.8 16V	F7P720, F7P722	01/91 ⇒	03/96
CLIO I 1.8 Rsi	F3P712, F3P758	01/93 ⇒	09/98
CLIO I Williams	F7R700	01/94 ⇒	09/98
ESPACE I 2.0	53AZ-FXE, J6R234, J6R236	07/84 ⇒	12/90
ESPACE I 2.0 i	J7R760	01/89 ⇒	12/90
ESPACE I 2.0 i Quadra	J7R760	03/88 ⇒	12/92
ESPACE II 2.0	J7R768	01/91 ⇒	10/96
ESPACE II 2.2	J7T772, J7T773, J7T776	01/91 ⇒	10/96
ESPACE II 2.2 4x4	J7T772, J7T773	03/91 ⇒	12/96
ESPACE II 2.8 V6	Z7W712, Z7W713, Z7W717	01/91 ⇒	10/96
EXPRESS 1.2	C1G	01/85 ⇒	10/90
EXPRESS 1.4	C1J, C2J, E6J/E7J	01/85 ⇒	10/90
FUEGO 1.6 [USA] R136B	A7L	01/84 ⇒	12/86
LAGUNA I 1.8	F3P678, F3P720, F3P724	11/93 ⇒	03/01
LAGUNA I 2.0	G27U730, F3R722	11/93 ⇒	03/01
MASTER I 2.0	J5R718, J5R728	06/85 ⇒	12/95
MASTER I 2.2	J7T788	08/93 ⇒	02/98
MASTER I 28-35 2.0	J5R718	10/86 ⇒	07/98
MASTER I 30 2.2	J7T782, J7T788	08/80 ⇒	07/98
MEGANE I 1.4	E7J764	09/96 ⇒	08/03
MEGANE I 1.4 e	E7J764	01/96 ⇒	08/03
MEGANE I 1.4 Eco	E7J624	01/96 ⇒	03/99
MEGANE SCÉNIC I 1.4 i	E7J764	01/97 ⇒	09/99
RAPID 1.2	C1G726	09/91 ⇒	08/93

RENAULT			
RAPID 1.4	C1J768, C1J780, C2J784, E6J738, E7J720, E7J724, E7J726, E7J728, E7J770, E7J771, E7J773	07/85 ⇒	03/98
RAPID 1.4 Cat	C3J702, C3J760, C3J762	08/88 ⇒	03/98
RAPID 1.4 RN	E6J734	09/91 ⇒	08/93
SAFRANE I 2.0	0LJY, J7R732, J7R738, J7R739	08/92 ⇒	09/96
SAFRANE I 2.0 12V	J7R734, J7R735	04/92 ⇒	07/96
SAFRANE I 2.2	1MR4790B, J7T761, J7T762	04/92 ⇒	07/96
SAFRANE I 3.0	Z7X723	02/93 ⇒	06/96
SAFRANE I 3.0 Biturbo 4x4	Z7X726	02/93 ⇒	07/96
SAFRANE I 3.0 V6	Z7X721, Z7X722, Z7X723, Z7X753	12/92 ⇒	07/96
SAFRANE I 3.0 V6 4x4	Z7X721, Z7X722, Z7X723	12/92 ⇒	07/96
SAFRANE II 3.0 V6	6216K4FU, Z7X755	07/96 ⇒	12/00
SUPER 5 1.2	C1G702, C1G720, C1G722	01/87 ⇒	12/96
SUPER 5 1.4	C1J768, C1J780, C1J788, C2J700, C2J780, C2J781, C2J782, C2J784, C2J788, C2J789, C2J798, C3J700	10/84 ⇒	08/90
SUPER 5 1.4 Cat	C3J700, C3J702, C3J760	10/85 ⇒	12/96
SUPER 5 1.4 Turbo	C1J782, C1J784, C1J788	04/85 ⇒	08/90
SUPER 5 1.7	F2N740, F2N742, F3N716, F3N717	10/86 ⇒	03/95
SUPER 5 1.7 i	F3N702	10/86 ⇒	08/91
TRAFIC I 1.7	F1N720	05/89 ⇒	08/94
TRAFIC I 2.0	J5R716	05/89 ⇒	08/90
TRAFIC I 2.0 RWD	J5R726	05/89 ⇒	10/97
TRAFIC I 2.2	J7T600, J7T780	05/89 ⇒	04/98
TRAFIC I 2.2 4x4	J7T600, J7T780	05/89 ⇒	04/98
VOLVO			
340-360 1.3	B13, B13.4E	08/88 ⇒	12/90
340-360 1.4	B14.3E, B14.4E, B14.4ED, B14.40, B14.45	08/82 ⇒	07/91
340-360 1.7	B172K	08/85 ⇒	07/91
340-360 2.0	B200E, B200EA, B200F, B200K	08/84 ⇒	07/90
440 1.6	B16F	09/88 ⇒	12/96
440 1.7	B18E, B18EP, B18F, B18FP, B18K, B18KD, B18KP, B18KPD	08/88 ⇒	12/96
440 1.8	B18U	08/91 ⇒	12/96
440 2.0	B20F	08/92 ⇒	07/96
460 1.6	B16F	07/92 ⇒	07/96
460 1.7	B18EP, B18FP, B18K, B18KD, B18KP	09/88 ⇒	07/96
460 1.8	B18U	08/91 ⇒	07/96
460 2.0	B20F	08/92 ⇒	07/96
480 1.7	B18E, B18ED, B18EP, B18F, B18FP	04/86 ⇒	07/96
480 2.0	B20F	08/92 ⇒	09/95

EPS 1.970.108  **07**

COILS
Adatt./Suitable:
BOSCH
0 986 221 027
FIAT
7582152
7663177
7698431
7746152
7746154
LANCIA
7663177
MAGNETI MARELLI
060705604010
060717017012
607 056 04
BAE 506
BAE 506 D

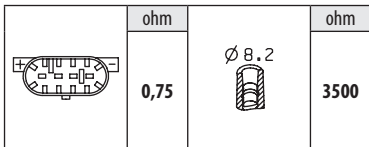
FIAT			
FIORINO II 1.0 iE	156A2.246	11/92 ⇒	04/96
PALIO 1.1	178B9.033	07/97 ⇒	10/03
PANDA I 1.1	156C.046	05/91 ⇒	03/95
PANDA I 1000 4x4	141C2.000, 156A2.246	05/86 ⇒	12/94
PANDA I 1000 Fire [CHE]	156A2.146	11/87 ⇒	04/91
PANDA I 1000 i.e	156A2.246	08/92 ⇒	02/04
PANDA I 1000 i.e. Cat	141C2.000, 156A2.246	10/87 ⇒	08/98
PANDA I 1100 i.e.	156C.046	01/86 ⇒	04/91
PANDA I 1100 Trekking 4x4	156C.046	10/91 ⇒	07/04
TEMPRA 1.4 i.e.	159A2.000, 160A1.046	04/90 ⇒	08/96
TIPO I 1.1	160A3.000	01/88 ⇒	10/91
TIPO I 1.4	160A1.000	07/87 ⇒	12/89
TIPO I 1.4 i.e.	159A2.000	05/89 ⇒	04/95
UNO 45 1.0	156A2.000, 156A2.100	06/86 ⇒	12/93
UNO 45 i.e. 1.0	156A2.246	10/84 ⇒	10/95
UNO 50 1.1	156C.046	01/90 ⇒	12/93
UNO 50 i.e. 1.1	146C3.000	06/92 ⇒	12/93
UNO 60 1.1	146A4.048, 146A6.000, 160A3.000	02/88 ⇒	12/92
UNO Mondo 1.0	146A2.166	01/98 ⇒	
UNO Mondo 1.0 [IND]	146A2.166	01/98 ⇒	
LANCIA			
Y10 1.0 Fire	156A2.100	06/85 ⇒	06/91
Y10 1.0 Fire Catalytic-Conv	156A2.246	10/87 ⇒	02/92
Y10 1.0 Fire Trazione integrale	156A2.000, 156A2.100, 156A2.246	12/86 ⇒	02/92
Y10 1.1 i.e. Fire	156C.000	08/89 ⇒	06/92
Y10 1.1 i.e. Fire Trazione integrale	156C.000	08/89 ⇒	06/92
Y10 1.1 i.e. Fire	156C.046	07/89 ⇒	09/95

EPS 1.970.109



07

COILS

Adatt./Suitable:



DELCO REMY
3 474 227**GENERAL MOTORS**03 474 227
3 474 227**OPEL**

12 08 035

00 Eliminated on 23-02-2022. Please verify the availability through our local distributors

- Eliminato il 23-02-2022. Verificare la disponibilità presso i nostri distributori
- Éliminé le 23-02-2022. Vérifier la disponibilité auprès de nos distributeurs sur place
- Am 23-02-2022 gestrichen. Evtl. Verfügbarkeit bitte bei unseren Händlern prüfen
- Eliminado en fecha 23-02-2022. Verificar la disponibilidad a través de nuestros distribuidores locales

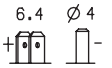

	ohm		ohm
	0,68		8300

OPEL

ASCONA C 1.6	16N	09/81 ⇨ 09/87
ASCONA C 1.6 S	16SH	09/81 ⇨ 08/86
ASCONA C 1.8 i	18E	09/82 ⇨ 08/86
KADETT E 1.8 i	18E	09/84 ⇨ 08/86

EPS 1.970.110



07

COILS

Adatt./Suitable:



00 Eliminated on 24-02-2021. Please verify the availability through our local distributors

- Eliminato il 24-02-2021. Verificare la disponibilità presso i nostri distributori
- Éliminé le 24-02-2021. Vérifier la disponibilité auprès de nos distributeurs sur place
- Am 24-02-2021 gestrichen. Evtl. Verfügbarkeit bitte bei unseren Händlern prüfen
- Eliminado en fecha 24-02-2021. Verificar la disponibilidad a través de nuestros distribuidores locales

1000 After depletion of stock this part is replaced by:

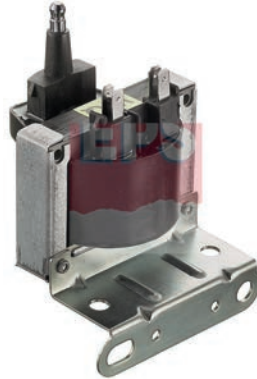
- Esaurite le scorte questo pezzo sarà sostituito da:
- Après épuisement du stock, cette pièce est remplacée par:
- Nach Vorraterschöpfung wird ersetzt durch:
- Despues agotamiento stock, sera sustituido por:

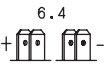
1.970.341

	ohm		ohm
	0,41		5000

EPS 1.970.111



07

COILS

Adatt./Suitable:

DELCO REMY
3 474 221**GENERAL MOTORS**

03 474 221



OPEL

12 08 036

03 Supplied until depletion

- Fornibile fino ad esaurimento delle scorte
- Fourni jusqu'à épuisement du stock
- Lieferbar solange vorrat reicht
- Suministrado hasta el stock termina

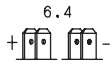

	ohm		ohm
	0,41		5000

OPEL

ASCONA C 1.3 N	13N	09/81 ⇨ 08/86
ASCONA C 1.3 S	13S	09/81 ⇨ 08/88
ASCONA C 1.6	16SV	09/86 ⇨ 08/88
ASCONA C 1.6 i Cat	C16LZ, C16NZ	09/86 ⇨ 08/88

EPS 1.970.112



07



COILS

Adatt./Suitable:

BMW1 720 166
1 720 877
12 13 1 720 166
12 13 1 720 877
12 13 1 742 925
17 20 1 66.2**BOSCH**

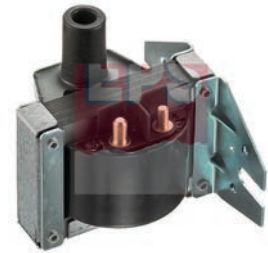
0 221 502 009



	ohm		ohm
	0,36		9000

BMW

5 II 530 i	--	01/84 ⇨ 12/88
5 III M5	S38B36(36651)	09/88 ⇨ 03/92
5 III M5 Cat	S38B36(36651)	09/88 ⇨ 03/92
7 II 750 i, iL V12	M70B50(5012A)	09/87 ⇨ 09/94
8 850 CSi	S70B56(56121)	11/92 ⇨ 12/96
8 850 i, Ci	M70B50(5012A)	01/90 ⇨ 08/94
Z1 2.5	M20B25(256K1)	06/88 ⇨ 06/91

EPS 1.970.125



07

COILS

Adatt./Suitable:

AUDI

211 905 115 D
251 905 115 A

BOSCH

0 221 122 349
0 221 122 350
0 221 122 386

SEAT

211 905 115 D

VW

211 905 115 D
251 905 115 A

960 Dry (epoxy) coil replacing original oil-bath coil version

- Bobina (resinizzata) sostituyente originale a bagno d'olio
- Bobine seche, remplaçant la bobine d'origine à bain d'huile
- Trockenspule, die die Originale im Ölbad ersetzt
- Bobina seca, sustituye modelo original con baño de aceite



-	+	ohm		ohm
M5	M5	0,63	∅ 4	3500

AUDI

80 II 1.3	EP	09/78 ⇒ 07/86
80 II 1.6	DT, JU, SA, WV	08/78 ⇒ 03/87
80 II 1.8	DS, JN, SF	01/83 ⇒ 08/86
80 II 1.8 CC quattro	JN, JV	08/84 ⇒ 08/86
80 II 1.8 GTE	DZ, MU, PV	06/84 ⇒ 03/87
80 II 2.0	HP, JS	10/83 ⇒ 09/84
80 II 2.0 quattro	JS	10/83 ⇒ 09/84
90 I 1.8	JN	06/84 ⇒ 03/87
90 I 2.0	HP, JL, JS, SK	10/84 ⇒ 03/87
90 I 2.0 quattro	JS	08/84 ⇒ 08/86
90 I 2.2	9C54, HY, KX	10/84 ⇒ 03/87
90 I 2.2 E quattro	9C54	11/84 ⇒ 03/87
90 II 2.2 E quattro	9C54	04/87 ⇒ 09/91
100 III 2.0	KP	08/84 ⇒ 12/87
100 III 2.0 E	KP	01/85 ⇒ 12/87
100 III 2.2	KZ	10/84 ⇒ 09/86
200 II 2.2	KU	08/84 ⇒ 07/85
COUPE 2.2 GT	9C54	09/84 ⇒ 10/88
COUPE 2.2 quattro	9C54, JT	10/84 ⇒ 10/88

SEAT

TOLEDO I 1.8 16V	KR, PL	05/91 ⇒ 03/99
TOLEDO I 1.8 GT	KR	05/91 ⇒ 11/92
TOLEDO I 1.8 i	RP	05/91 ⇒ 12/96

VW

PASSAT II 1.6	DT	08/80 ⇒ 03/88
PASSAT II 1.8	DS	01/83 ⇒ 03/88
PASSAT II 1.8 Syncro	DS	01/86 ⇒ 03/88
PASSAT II 2.0	JS	08/83 ⇒ 03/88
PASSAT II 2.0 Syncro	JS	05/84 ⇒ 03/88
POLO II 1.0	AAK, HZ	01/85 ⇒ 09/94
POLO II 1.0 Cat	AAK	08/89 ⇒ 09/94
POLO II 1.3	3F, GK	09/82 ⇒ 09/94
POLO II 1.3 Cat	2G, 3F, MH, NZ	07/87 ⇒ 09/94
POLO II 1.3 G40	PY	01/87 ⇒ 08/90
JETTA II 1.0	HZ	08/85 ⇒ 10/91
JETTA II 1.3	MH, NU	01/84 ⇒ 12/87
JETTA II 1.3 Cat	2G, MH, NZ	06/87 ⇒ 12/91
JETTA II 1.6	ABN, EZ, EZA, HM, PN, RF	12/83 ⇒ 07/92
JETTA II 1.8	EV, GU, GX, PB, RD, RH, RV	01/84 ⇒ 10/91
JETTA II 1.8 16V	KR, PL	08/86 ⇒ 10/91
JETTA II 1.8 Cat	GX, PF, RP	01/87 ⇒ 10/91
JETTA II 1.8 G60	PG	04/90 ⇒ 07/91
JETTA II 1.8 Syncro	3E82, GU, GX, RH, RP	08/85 ⇒ 07/91
JETTA II 1.8i GT	GZ	12/83 ⇒ 07/88
CADDY I 1.8	JH	08/85 ⇒ 07/92
CORRADO 1.8 G60	PG	09/88 ⇒ 09/93
DERBY 1.3	GK, HK	09/82 ⇒ 12/84
GOLF I 1.6	EW, HN	08/83 ⇒ 04/92
GOLF I 1.8	2H, DX, EX, JH, KT	08/82 ⇒ 04/93

VW

GOLF II 1.0	HZ	08/85 ⇒ 10/91
GOLF II 1.3	MH, NU	08/83 ⇒ 12/87
GOLF II 1.3 Cat	2G, NZ	06/86 ⇒ 12/92
GOLF II 1.6	ABN, EZ, PN, RF	08/83 ⇒ 12/92
GOLF II 1.6 [CHE] [SWE]	HM	08/83 ⇒ 07/88
GOLF II 1.6 G	EZA, PN	08/86 ⇒ 07/91
GOLF II 1.8	GU, GX, RH, RV	08/84 ⇒ 10/91
GOLF II 1.8 [CHE] [SWE]	HV	04/84 ⇒ 07/87
GOLF II 1.8 GTI	EV, PB, RD	08/83 ⇒ 10/91
GOLF II 1.8 GTI 16V	KR, PL	02/86 ⇒ 10/91
GOLF II 1.8 GTI Cat	PF	01/87 ⇒ 10/91
GOLF II 1.8 GTI G60	PG	04/90 ⇒ 07/91
GOLF II 1.8 GTI G60 Syncro	1H, PG	08/88 ⇒ 12/91
GOLF II 1.8 i	RP	08/87 ⇒ 07/91
GOLF II 1.8 i Cat	GX, RP	08/87 ⇒ 10/91
GOLF II 1.8 i Cat Syncro	RP	08/87 ⇒ 10/91
GOLF II 1.8 Rallye syncro	1H, PG	08/88 ⇒ 07/91
GOLF II 1.8 Syncro	3E82, GU, GX, RH	02/86 ⇒ 07/91
GOLF II 1.8i GTI [CHE] [SWE]	GZ	01/84 ⇒ 07/87
GOLF II 1.8i GTI [SWE]	GS	08/87 ⇒ 07/88
LT I 2.4 i	1E	08/89 ⇒ 06/96
PASSAT III 1.6	1F, EZ	04/88 ⇒ 07/92
PASSAT III 1.8	KR, PB, PF, RP	02/88 ⇒ 05/97
PASSAT III 1.8 16V	KR	04/88 ⇒ 12/89
PASSAT III 1.8 G60 Syncro	PG	08/88 ⇒ 05/97
PASSAT III 1.8 GL	KR	08/91 ⇒ 09/93
QUANTUM 2.1	--	01/85 ⇒ 12/87
QUANTUM 2.1	--	01/81 ⇒ 12/84
SANTANA 1.6	DT	08/81 ⇒ 12/84
SANTANA 1.8	DS	01/83 ⇒ 12/84
SANTANA 2.0	JS	08/83 ⇒ 12/84
SCIROCCO II 1.6	EW, EWA, HN, RE	01/83 ⇒ 07/90
SCIROCCO II 1.8	DX, EX, JH, KT	08/82 ⇒ 07/92
SCIROCCO II 1.8 16V	KR, PL	10/85 ⇒ 07/92
TRANSPORTER III 1.9	DF, DG	08/82 ⇒ 07/92
TRANSPORTER III 1.9 Syncro	DG	11/84 ⇒ 07/92
TRANSPORTER III 2.1	DJ, MV, SR	08/84 ⇒ 07/92
TRANSPORTER III 2.1 Cat	MV	06/89 ⇒ 07/92
TRANSPORTER III 2.1 i	SS	07/89 ⇒ 07/92
TRANSPORTER III 2.1 Syncro	DJ, MV, SR	08/85 ⇒ 07/92

EPS 1.970.126



07

COILS

Adatt./Suitable:

AUDI

035 905 105 A

BOSCH

0 221 118 398
0 221 122 334
0 221 122 357
0 221 122 358
0 221 122 399
0 221 122 400

FIAT

7612954

LANCIA

7612954

VW

035 905 105 A
191 905 115 A

960 Dry (epoxy) coil replacing original oil-bath coil version

- Bobina (resinizzata) sostituyente originale a bagno d'olio
- Bobine seche, remplaçant la bobine d'origine à bain d'huile
- Trockenspule, die die Originale im Ölbad ersetzt
- Bobina seca, sustituye modelo original con baño de aceite



-	+	ohm		ohm
M5	M5	0,68	∅ 4	7200

AUDI

200 II 2.2 Turbo quattro	MC	01/85 ⇒ 12/91
--------------------------	----	---------------

LANCIA

THEMA 2850 V6 i.e.	834E.146	06/88 ⇒ 05/92
THEMA 8.32	F105L	09/87 ⇒ 05/89

VW

POLO II 1.0	HZ	01/85 ⇒ 09/94
POLO II 1.3	GK	09/82 ⇒ 09/89
POLO II 1.3 Cat	2G, MH, NZ	07/87 ⇒ 09/94
JETTA II 1.0	HZ	08/85 ⇒ 10/91
JETTA II 1.3	MH	01/84 ⇒ 06/87
JETTA II 1.3 Cat	2G, MH, NZ	06/87 ⇒ 12/91
JETTA II 1.6	EZ, PN, RF	01/84 ⇒ 07/92
JETTA II 1.8 16V	PL	08/86 ⇒ 10/91
JETTA II 1.8 Syncro	3E82, GU	08/86 ⇒ 07/91
CADDY I 1.8	JH	08/85 ⇒ 07/92
CORRADO 1.8 16V	KR	04/89 ⇒ 07/92
GOLF I 1.6	EW, HN	08/83 ⇒ 04/92
GOLF I 1.8	2H, DX, EX, JH, KT	08/82 ⇒ 04/93
GOLF II 1.0	HZ	08/85 ⇒ 10/91
GOLF II 1.3	MH	08/83 ⇒ 06/87
GOLF II 1.3 Cat	2G, NZ	06/86 ⇒ 12/92
GOLF II 1.6	EZ, PN, RF	08/84 ⇒ 12/92
GOLF II 1.6 G	PN	08/86 ⇒ 07/91
GOLF II 1.8	GU	08/84 ⇒ 10/91
GOLF II 1.8 GTI 16V	PL	02/86 ⇒ 10/91
GOLF II 1.8 Syncro	3E82, GU	02/86 ⇒ 07/91
PASSAT III 1.6	1F, EZ	04/88 ⇒ 07/92
PASSAT III 1.8	KR	08/91 ⇒ 09/93
PASSAT III 1.8 16V	KR	04/88 ⇒ 12/89
PASSAT III 1.8 GL	KR	08/91 ⇒ 09/93
QUANTUM 2.1	--	01/85 ⇒ 12/89
SCIROCCO II 1.6	EW, RE	01/83 ⇒ 07/90
SCIROCCO II 1.8	DX, EX, JH, KT	08/82 ⇒ 07/92
SCIROCCO II 1.8 16V	KR, PL	10/85 ⇒ 07/92
TRANSPORTER III 1.9	DF, DG	08/82 ⇒ 07/92
TRANSPORTER III 1.9 Syncro	DG	11/84 ⇒ 07/92
TRANSPORTER III 2.1	DJ	08/84 ⇒ 07/92
TRANSPORTER III 2.1 Syncro	DJ	01/86 ⇒ 07/92

EPS 1.970.127



07

COILS

Adatt./Suitable:

AUDI

811 905 115

BOSCH

0 221 122 379
0 221 122 380

VW

811 905 115

960 Dry (epoxy) coil replacing original oil-bath coil version

- Bobina (resinizzata) sostituyente originale a bagno d'olio
- Bobine seche, remplaçant la bobine d'origine à bain d'huile
- Trockenspule, die die Originale im Ölbad ersetzt
- Bobina seca, sustituye modelo original con baño de aceite

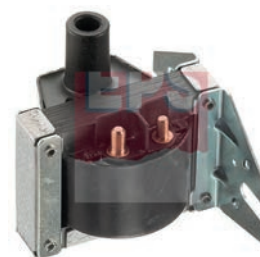

+	-	ohm		ohm
M6	M5	0,63	∅ 4	3500

AUDI

80 II 1.3	EP	09/78 ⇒ 07/86
80 II 1.6	DT, JU, SA	08/78 ⇒ 03/87
80 II 1.8	DS, JN, SF	01/83 ⇒ 08/86
80 II 1.8 CC quattro	JN, JV	08/84 ⇒ 08/86
80 II 1.8 GTE	DZ, MU, PV	06/84 ⇒ 03/87
80 II 2.0	HP, JS	10/83 ⇒ 09/84
80 II 2.0 quattro	JS	10/83 ⇒ 09/84
80 III 1.4	SE	08/86 ⇒ 07/88
80 III 1.6	ABB, PP, RN, RNA	09/86 ⇒ 10/91
80 III 1.8	RU, SD	09/86 ⇒ 01/90
80 III 1.8 E	DZ	06/86 ⇒ 08/91
80 III 1.8 E quattro	DZ	09/86 ⇒ 08/91
80 III 1.8 quattro	SD	09/86 ⇒ 08/90
80 III 1.8 S	JN, JV, NE, PM, SF	08/86 ⇒ 10/91
80 III 1.8 S quattro	JN, NE, PM, SF	09/86 ⇒ 09/91
80 III 2.0	AAD	10/90 ⇒ 08/91

AUDI			
80 IV 1.6	ABB	03/92 ⇒ 05/93	
90 I 1.8	JN	06/84 ⇒ 03/87	
90 I 2.0	HP, JL, JS, SK	10/84 ⇒ 03/87	
90 I 2.0 quattro	JS	08/84 ⇒ 08/86	
90 I 2.2	9C54, HY, KX	10/84 ⇒ 03/87	
90 I 2.2 E quattro	9C54	11/84 ⇒ 03/87	
90 II 2.0	PS	07/88 ⇒ 09/91	
90 II 2.2 E	9C54	04/87 ⇒ 07/91	
90 II 2.2 E quattro	9C54	04/87 ⇒ 09/91	
100 III 1.8	DS, JW, NP, SH	08/83 ⇒ 12/90	
100 III 1.8 Cat	4B, PH	03/85 ⇒ 11/90	
100 III 1.8 Cat quattro	4B, PH	08/85 ⇒ 11/90	
100 III 1.8 quattro	NP, SH	10/84 ⇒ 07/90	
100 III 2.0	KP	08/84 ⇒ 12/87	
100 III 2.0 E	KP	01/85 ⇒ 12/87	
100 III 2.2 Cat	KU	06/89 ⇒ 11/90	
100 III 2.2 Cat quattro	KU	06/89 ⇒ 11/90	
100 IV 1.6	ABB	03/92 ⇒ 07/93	
COUPE 1.8	DZ	08/89 ⇒ 07/91	
COUPE 2.2	9C54	11/88 ⇒ 07/91	
COUPE 2.2 GT	9C54	09/84 ⇒ 10/88	
COUPE 2.2 quattro	9C54, JT	10/84 ⇒ 07/91	

VW			
POLO II 1.3	GK	09/82 ⇒ 09/89	
SANTANA 1.9	WN	08/81 ⇒ 07/83	
SCIROCCO II 1.3	GF	08/80 ⇒ 12/83	
SCIROCCO II 1.6	EW, EWA, HN	01/83 ⇒ 12/89	
SCIROCCO II 1.8	DX, EX, JH, KT	08/82 ⇒ 07/92	
SCIROCCO II 1.8 16V	KR	10/85 ⇒ 07/89	

EPS **1.970.135**  **07**

COILS

Adatt./Suitable:

BOSCH
F 000 Z50 212

DENSO
029700-6700

FORD
1 649 067
6 503 279
6 503 280
885F-12029A-1A
885F-12029A-2A
928F-12029-CA
96BF-12024A-1B
E8TZ-12029-A
E9TF-12029-AA

HITACHI
138803

MAGNETI MARELLI
060717036012

MAZDA
FSD7-18-100

Motorcraft
DG 435
EDG 43

⁰³ Supplied until depletion

- Fornibile fino ad esaurimento delle scorte
- Fourni jusqu'à épuisement du stock
- Lieferbar solange vorrat reicht
- Suministrado hasta el stock termina

EPS **1.970.132**  **07**

COILS

Adatt./Suitable:

AUDI
211 905 115 B

BOSCH
0 221 102 088
0 221 122 022
0 221 122 023

VW
211 905 115 B
211 905 115 C



⁰³ Supplied until depletion

- Fornibile fino ad esaurimento delle scorte
- Fourni jusqu'à épuisement du stock
- Lieferbar solange vorrat reicht
- Suministrado hasta el stock termina



⁹⁶⁰ Dry (epoxy) coil replacing original oil-bath coil version

- Bobina (resinizzata) sostituyente originale a bagno d'olio
- Bobine sèche, remplaçant la bobine d'origine à bain d'huile
- Trockenspule, die die Originale im Ölbad ersetzt
- Bobina seca, sustituye modelo original con baño de aceite



		ohm		ohm
M5	M5	0,63	∅ 8,2	3500



	ohm		ohm
- +	0,50	∅ 7	13000

FORD

ESCORT IV 1.3	J6A, JBD	01/95 ⇒ 08/97
ESCORT IV 1.4	F4B, F6F, F6G	07/90 ⇒ 08/00
ESCORT V 1.4	F4B, F6F, F6G, FUH	07/90 ⇒ 01/95
ESCORT V 1.4 i	F4B	07/93 ⇒ 01/95
ESCORT V 1.6	LJF, LUJ, LUK	07/90 ⇒ 08/93
ESCORT VI 1.4	F4B, F6B, F6D, FUH	01/95 ⇒ 12/99
FIESTA III 1.4	FUG, FUJ	03/89 ⇒ 12/95
FIESTA III 1.4 Cat	F4A	03/89 ⇒ 12/95
FIESTA III 1.6	LUH	01/89 ⇒ 01/94
FIESTA III 1.6 Turbo	LHA	03/90 ⇒ 10/92
FIESTA III 1.6 XR2i	LJC, LJD	03/89 ⇒ 01/94
ORION II 1.4	F6F, F6G, HL14L-FUH	07/90 ⇒ 12/93
ORION II 1.6	LUJ, LUK	07/90 ⇒ 12/92
ORION II 1.6 i	HL16EFH-LJE, LJF	07/90 ⇒ 09/92
SIERRA II 1.6 i	L6B	10/89 ⇒ 02/93
SIERRA II 1.8 i	HL18CFI-R6A	01/92 ⇒ 12/93

MAZDA

626 VI 1.8	FP, FP9A, FPY3	05/97 ⇒ 10/02
626 VI 2.0	FS	05/97 ⇒ 10/02

EPS **1.970.140**  **07**

COILS

Adatt./Suitable:

BOSCH
F 000 Z50 111

DUCELLIER
2 526 049 A

GENERAL MOTORS
03 474 283
3 474 283
90 449 739
90 510 386

HITACHI
138780
2508780

HOLDEN
90449739



MAGNETI MARELLI
060717011012

OPEL
12 08 003
12 08 054
12 08 070
3474283
90449739
90510386

⁰³ Supplied until depletion

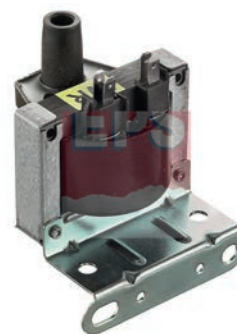
- Fornibile fino ad esaurimento delle scorte
- Fourni jusqu'à épuisement du stock
- Lieferbar solange vorrat reicht
- Suministrado hasta el stock termina



	ohm		ohm
6,4	0,41	∅ 4	5000

HOLDEN

BARINA 1.4 i	C14NZ	04/94 ⇒ 07/97
BARINA_SB 1.2i	C12NZ	04/94 ⇒ 07/97
COMBO 1.4 i	C14NZ	03/96 ⇒ 07/97
COMBO_SB 1.4i	C14NZ	04/94 ⇒ 07/97

OPEL

ASTRA F 1.4	14SE	09/92 ⇒ 09/98
ASTRA F 1.4 i	C14NZ	09/91 ⇒ 01/05
ASTRA F 1.4 Si	C14SE	03/92 ⇒ 03/01
ASTRA F 1.6	16LZ2, 16NZ2	09/94 ⇒ 09/98
ASTRA F 1.8 i	C18NZ	09/91 ⇒ 09/98
COMBO B 1.2	C12NZ	07/94 ⇒ 10/01
COMBO B 1.4	C14NZ	07/94 ⇒ 10/01
CORSA A 1.2 i	C12NZ	09/89 ⇒ 03/93
CORSA A 1.4 i	C14NZ	01/85 ⇒ 03/93
CORSA A 1.4 Si	C14SE	09/91 ⇒ 03/93
CORSA A 1.6 GSi	E16SE	05/88 ⇒ 03/92
CORSA B 1.2 i	12NZ, C12NZ	03/93 ⇒ 09/00
CORSA B 1.4 i	C14NZ	03/93 ⇒ 09/00
KADETT E 1.4 i	C14NZ	01/90 ⇒ 07/94
KADETT E 1.6	16SV	09/86 ⇒ 12/91
KADETT E 1.6 i	16SV	07/89 ⇒ 02/93
KADETT E 1.6 S	16S, 16SV	09/84 ⇒ 08/91
KADETT E 1.8	18SE	01/86 ⇒ 08/91
KADETT E 1.8 i	C18NZ	06/85 ⇒ 05/92
OMEGA A 1.8	18SEH	09/86 ⇒ 03/94
OMEGA A 1.8 S	18SV	09/86 ⇒ 03/94
VECTRA A 1.6	16SV, C16LZ2	09/88 ⇒ 07/93
VECTRA A 1.6 i	C16NZ2	09/88 ⇒ 11/95
VECTRA A 1.6 i Cat	C16NZ2	09/88 ⇒ 11/95
VECTRA A 1.6 S	16SV	09/88 ⇒ 05/93
VECTRA A 1.8 i	18SV	09/88 ⇒ 10/90
VECTRA A 1.8 i Cat	C18NZ	03/90 ⇒ 11/95
VECTRA A 1.8 S	18SV	09/89 ⇒ 10/90
VECTRA B 1.6 i	16LZ2	10/95 ⇒ 07/03

VAUXHALL

ASTRA III 1.4 i	C14NZ, C14SE	03/91 ⇒ 09/98
ASTRA III 1.8 i	C18NZ	09/91 ⇒ 09/98
ASTRAVAN I 1.4 i	C14NZ	09/91 ⇒ 08/95
COMBO B 1.2	C12NZ	07/94 ⇒ 10/01
COMBO B 1.4	C14NZ	07/94 ⇒ 10/01

1.970.146

VAUXHALL

CORSA B 1.2 i	C12NZ	03/93 ⇒ 09/00
CORSA B 1.4 i	C14NZ	03/93 ⇒ 09/00
CORSAVAN I 1.4 i	C14NZ	01/94 ⇒ 09/00

EPS 1.970.146



05

COILS

Adatt./Suitable:

ALFA ROMEO

46548037
60805420
60809492

BOSCH

F 000 Z50 103

CHAMPION

BAE 800 B

FIAT

46543562
46548037
60805420
60809492
60815150
7626232
7672018

HITACHI

138730
2508730

INNOCENTI

46543562

LANCIA

46543562
46548037
60805420
60809492
7626232
7672018

MAGNETI MARELLI

060708038010
060717029012
060780002010
607 080 38
BAE 800 AK
BAE 800 B
BAE 800 DK

	ohm		ohm
	0,54	Ø 8,2	7500

ALFA ROMEO

33 II 1.4 i.e.	AR30753	06/91 ⇒ 09/94
145 1.4 i.e.	AR33501	07/94 ⇒ 12/96
146 1.4 i.e.	AR33501	12/94 ⇒ 12/96
155 2.0 16V Turbo Q4	AR67203	01/92 ⇒ 12/97

FIAT

CINQUECENTO 0.7	170A.000, 171A.000	12/91 ⇒ 02/98
CINQUECENTO 0.7 i	170A.046	07/94 ⇒ 01/98
CINQUECENTO 0.9	170A1.000	07/91 ⇒ 12/93
CINQUECENTO 0.9 i.e.	170A1.046	07/91 ⇒ 09/94
CINQUECENTO 0.9 i.e. S	1170A1.000, 1170A1.046	07/91 ⇒ 07/99
CINQUECENTO 1.1 Sporting	176B2.000	10/94 ⇒ 01/98
COUPE 2.0 16V Turbo	175A1.000	11/93 ⇒ 08/96
DOBLO I 1.2	223A5.000	03/01 ⇒
PUNTO I 1.1	176B2.000	04/96 ⇒ 02/00
PUNTO I 1.2 16V	176B9.000	04/97 ⇒ 09/99
PUNTO I 1.5 1.1	176A6.000, 176B2.000	09/93 ⇒ 09/99
PUNTO I 60 1.2	176A7.000, 176B1.000, 176B4.000	09/93 ⇒ 06/00
PUNTO I 75 1.2	176A8.000	10/93 ⇒ 09/99
PUNTO I 85 16V 1.2	176B9.000	04/97 ⇒ 06/00
FIORINO II 1.2 MPI	178E8.011	01/04 ⇒
PALIO 1.0	178A1.000	04/96 ⇒ 10/03
PALIO 1.0 GLX	--	07/98 ⇒ 10/03
PALIO 1.1	187A1.000	06/06 ⇒
PALIO 1.2	176A8.000, 178B5.000, 178B7.045, 178C4.066, 178E2.000, 188A4.000	04/96 ⇒
PALIO 1.2 75	178B7.045	03/98 ⇒
PALIO 1.2 MPI	178C4.066	01/02 ⇒
PALIO 1.4	178B2.000, 178B2.016	04/96 ⇒ 10/02

FIAT

PALIO 1.4 Cat	178B2.000, 178B2.016	04/96 ⇒ 08/01
PALIO 1.5	178E5.022	02/02 ⇒
PALIO 1.5 MPI	178E5.027	08/01 ⇒
PALIO 1.6 16V 100	178C8.098	01/98 ⇒
PANDA I 1.1	156C.046, 187A1.000	09/00 ⇒ 03/95
PANDA I 1.1 AWD	187A1.000	09/00 ⇒ 02/04
PANDA I 1000 4x4	141C2.000	05/86 ⇒ 12/94
PANDA I 1000 i.e	156A2.246	08/92 ⇒ 02/04
PANDA I 1000 i.e. Cat	141C2.000, 156A2.246	10/87 ⇒ 08/98
PANDA I 1100	156C.046, 176B2.000, 187A1.000	05/91 ⇒ 12/99
PANDA I 1100 4x4	176B2.000	02/95 ⇒ 07/04
PANDA I 1100 i.e. 4x4	187A1.000	12/00 ⇒
PANDA I 1100 Trekking 4x4	156C.046	10/91 ⇒ 07/04
PANDA I 900	1170A1.046	04/92 ⇒ 12/96
PANDA I 900 i.e.	1170A1.046	01/98 ⇒
PANDA II 1.1	--	09/03 ⇒
PANDA II 1.2	188A4.000	09/03 ⇒
PANDA II 1.2 4x4	188A4.000	09/04 ⇒
PANDA II 1.2 Bipower	188A4.000	09/04 ⇒ 12/11
PANDA II 1.2 Bi-Power / Natural Power	--	04/09 ⇒
PANDA II 1.2 Euro 4	--	04/09 ⇒
PANDA II 1.2 LPG	188A4.000	04/09 ⇒
PANDA II 1.2 Natural Power	188A4.000, 188A4000CNG	01/07 ⇒ 12/11
PUNTO II 1.2 60	188A4.000	09/99 ⇒ 12/10
PUNTO II 1.2 Bifuel	188A4.000	08/07 ⇒ 03/12
PUNTO II 1.2 Bipower	188A4.000	08/01 ⇒ 05/03
PUNTO II 1.2 Natural Power	188A4.000, 188A4000CNG	01/03 ⇒ 03/12
SEICENTO / 600 0.9	1170A1.046	11/97 ⇒ 01/10
SEICENTO / 600 1.1	176B2.000, 187A1.000	01/98 ⇒ 01/10
SIENA 1.2	178B7.045	01/98 ⇒
SIENA 1.3	178B5.000, 178C4.066, 188A4.000	09/01 ⇒ 12/12
SIENA 1.4	178B2.000, 178B2.016	04/96 ⇒ 12/09
SIENA 1.4 Cat	178B2.000, 178B2.016	04/96 ⇒ 12/09
SIENA 1.5	178E5.022, 178E5.027	09/02 ⇒
SIENA 1.7 [CHN]	--	01/06 ⇒
STRADA 1.2	178B5.000, 178B7.045, 188A4.000	04/03 ⇒
STRADA 1.2 Trekking	--, 178B7.045	11/05 ⇒
TEMPRA 1.8 i.e.	835C2.000, 835C4.000, 836A5.000	09/93 ⇒ 08/96
TIPO I 1.8 i.e	836A5.000	03/93 ⇒ 04/95
TIPO I 1.8 i.e.	835C2.000, 835C4.000, 836A5.000, 836A6.000	03/93 ⇒ 10/95
UNO 1.0	156A2.000	06/89 ⇒ 02/92
UNO 1.0 i.e.	146C7.000	09/89 ⇒ 03/94
UNO Mondo 1.2 i.e. [IND]	178D5.066	01/96 ⇒

FIAT (BR)

PALIO 1.0i	1.0Mpi	01/96 ⇒
PALIO 1.5i	1.5Mpi	01/96 ⇒ 12/00
PALIO 1.6i	1.6Spi	01/99 ⇒ 12/99
SIENA 1.0i	1.0Mpi	01/99 ⇒ 12/00
SIENA 1.5i	1.5Mpi	01/99 ⇒ 12/00
SIENA 1.6i	1.6Mpi	01/98 ⇒ 12/00
STRADA 1.5i	1.5Mpi	01/99 ⇒ 12/01
STRADA 1.6i 8v	1.6Mpi	01/99 ⇒ 12/00
UNO 1.5i	1.5Spi	01/92 ⇒ 12/96
UNO 1.5i Furgoneta	1.5Mpi	01/92 ⇒
UNO CS 1.5i	1.5Spi	01/92 ⇒ 12/96
UNO MILLE 1.0	1.0	05/93 ⇒ 12/95
UNO MILLE 1.0i	1.0Mpi	01/96 ⇒

INNOCENTI

MILLE 1.0	146C7.000	07/95 ⇒ 05/97
MILLE 1.0i	146C7.000	02/93 ⇒ 02/98

LANCIA

DEDRA 1.8 i.e.	836A5.000	07/94 ⇒ 07/99
DELTA I 2.0 16V HF Evo Integrale	831E5.046	06/93 ⇒ 01/94
DELTA II 1.8 i.e.	835C2.000, 835C4.000, 836A5.000, 836A6.000, 836C4.000	06/93 ⇒ 08/99
DELTA II 2.0 16V Turbo	175A4.000, 836A2.000	06/93 ⇒ 08/99
THEMA 2000 16V Turbo	834C1.000	12/88 ⇒ 06/90
THEMA 2000 i.e. 16V	834B2.000, 834B2.246	05/88 ⇒ 08/92
THEMA 2000 i.e. 16V Turbo	834C1.000, 834C1.246	12/88 ⇒ 03/93
Y I 1.1	176B2.000	11/95 ⇒ 09/03
Y I 1.2	188A4.000, 840A3.000	03/96 ⇒ 09/03
Y I 1.2 16V	176B9.000	04/97 ⇒ 09/03
YPSILON II 1.2	169A4.000, 188A4.000	10/03 ⇒ 12/11

EPS

1.970.148



07

COILS

Adatt./Suitable:

BOSCH

0 986 221 037

FIAT

7746151

INNOCENTI

7746151

LANCIA

7746151

MAGNETI MARELLI

060705404010

607 054 04

BAE 504 D



	ohm		ohm
	0,45	Ø 8,2	5000

FIAT

CROMA I 2000 CHT	154A1.000, 154C5.000	01/91 ⇒ 09/92
CROMA I 2000 i.e.	154C3.000, 154C3.046, 834B.146	10/87 ⇒ 12/96
ELBA 1.5	149C1.000	01/92 ⇒ 12/96
FIORINO II 1.6	146C6.000	01/94 ⇒ 05/01
FIORINO II 70 i.e. 1.4	146C5.000	05/94 ⇒ 05/01
FIORINO II 75 i.e. 1.6	146C6.000	10/93 ⇒ 05/01
TEMPRA 1.4 i.e.	160A1.046	04/90 ⇒ 08/96
TEMPRA 1.6	159A3.000, 159A3.048, 159A3.098	03/90 ⇒ 12/96
TEMPRA 1.6 i.e.	159A3.046, 159A3.048	06/90 ⇒ 08/96
TIPO I 1.4	160A1.048	07/87 ⇒ 12/89
TIPO I 1.4 i.e.	160A1.046	05/89 ⇒ 04/95
TIPO I 1.6	159A3.048, 160A2.000	01/88 ⇒ 10/95
TIPO I 1.6 i.e.	159A3.046, 159A3.048	07/90 ⇒ 04/95
TIPO I 1.6 SX DGT	159A3.000	05/89 ⇒ 10/95
UNO 1.4 Super	146C2.028	09/89 ⇒ 09/92
UNO 70 i.e. 1.4	146C1.000, 160A1.046	09/89 ⇒ 07/96
UNO 70 S 1.4	160A1.048	10/88 ⇒ 06/06
UNO 75 i.e. 1.5	149C1.000	10/85 ⇒ 12/93
UNO Mondo 1.4 Super	146C2.028	01/96 ⇒

INNOCENTI

ELBA 1.4 i.e.	146C5.000	09/94 ⇒ 12/96
ELBA 1.5 i.e.	149C1.000	08/92 ⇒ 09/94
ELBA 1.6 i.e.	146C6.000	09/94 ⇒ 12/96
MILLE 1.4	160A1046	07/95 ⇒ 05/97

LANCIA

DEDRA 1.6 i.e.	835A1.046	08/89 ⇒ 03/93
DELTA II 1.4 i.e.	160A1.046	10/94 ⇒ 08/99
THEMA 2000 i.e	834B1.000	09/88 ⇒ 05/92
THEMA 2000 i.e.	834B.146	09/87 ⇒ 05/92
THEMA 2000 i.e. Turbo	834C.146	07/86 ⇒ 05/90
THEMA 2000 Turbo	834C.146	12/88 ⇒ 03/92
Y10 1.3 i.e.	146A5.046, 156B.000	11/87 ⇒ 12/95

EPS 1.970.155



05

COILS

Adatt./Suitable:

BOSCH

0 986 221 029

CITROËN

5970 45

96 035 284

DUCELLIER

2 526 026 A

HITACHI

138752

2508752

MAGNETI MARELLI

060705754010

060717009012

PEUGEOT

5970 45

96 035 284

03 Supplied until depletion

- Fornibile fino ad esaurimento delle scorte
- Fourni jusqu'à épuisement du stock
- Lieferbar solange vorrat reicht
- Suministrado hasta el stock termina



	ohm		ohm
	0,68		6800

CITROËN

AX 1.3 Sport	M4A	04/87 ⇒ 12/88
AX 10	C1A	09/86 ⇒ 06/92
AX 10 E	C3A	12/86 ⇒ 12/88
AX 11	H1A, H1B, HDZ(TU1M)	09/86 ⇒ 12/97
AX 11 4x4	H1A	06/91 ⇒ 07/92
AX 11 Cat	HAZ(TU1CP)	09/88 ⇒ 12/89
AX 14	K1A(TU3), K1B, K1F, K1G, K1J, K2A, K2B, K2D, KAY(TU3CP), KDX(TU3M/Z), KDY(TU3FM), KDY(TU3M), KDZ(TU3M/Z)	09/86 ⇒ 04/97
AX 14 4x4	KD4, KDX(TU3M/Z), KDY(TU3FM), KDY(TU3M), KDZ(TU3M/Z)	06/91 ⇒ 12/96
XM I 2.0 i	RDZ(XU10M/Z), RFZ(XU10J2)	05/89 ⇒ 06/94
BERLINGO I 1.4	TU32	07/96 ⇒ 10/98
ZX 1.1	H1A, H1B, HDZ(TU1M), TU1	03/91 ⇒ 06/97
ZX 1.4 i	KDY(TU3M)	10/93 ⇒ 10/97
ZX 1.9	D6E(XU9JA)	03/91 ⇒ 06/97
ZX 1.9 i	DKZ(XU9JA), XU9JA	03/91 ⇒ 06/97

PEUGEOT

106 I 1.0	TU9	09/91 ⇒ 04/96
106 I 1.1	H1B(TU1), HDZ(TU1M)	08/91 ⇒ 04/96
106 I 1.4	K5A(TU3), KDY(TU3M), TU3, TU3.2	08/91 ⇒ 04/96
106 II 1.1	H1B(TU1)	04/96 ⇒
205 II 1.0	TU9	10/87 ⇒ 09/98
205 II 1.1	H1B(TU1)	01/91 ⇒ 12/94
306 1.4	TU3	01/93 ⇒ 04/02
405 II 1.4	TU3F2	01/93 ⇒ 12/96
PARTNER I 1.4	TU32	06/96 ⇒ 12/15
RANCH 1.4	K5A(TU3.2)	09/96 ⇒ 08/02

EPS 1.970.158



07

COILS

Adatt./Suitable:

BOSCH

0 986 221 028

FIAT

7553120

7646974

7746153

INNOCENTI

7746153

LANCIA

7646974

MAGNETI MARELLI

060705606010

607 056 06

BAE 506 F



	ohm		ohm
	0,75		3500

FIAT

DUNA 60 1.1	146A6.000	01/87 ⇒ 12/91
DUNA 70 1.3	146A5.000	01/87 ⇒ 12/91
ELBA 1.3	146A5.000	04/91 ⇒ 02/95
FIORINO I 1.1 60	146A9.000	11/86 ⇒ 04/88
FIORINO I 1.3	146A5.000	12/87 ⇒ 08/93
FIORINO II 1.3	146A5.000	01/88 ⇒ 12/94
FIORINO II 60 1.1	146A9.000	05/88 ⇒ 12/93
FIORINO II 70 1.3	146A5.000	01/88 ⇒ 12/94
PANDA I 1000	156A2.100, 156A3.000	01/85 ⇒ 12/92
PANDA I 1000 4x4	156A2.100, 156A2.246, 156A3.000	01/86 ⇒ 12/94
PANDA I 750 Cat	156A4.048	01/95 ⇒ 10/03
PANDA I 750 Fire	156A4.048	11/88 ⇒ 04/91
UNO CS 1.1	146A6.000	09/87 ⇒ 09/91

FIAT (BR)

UNO CS 1116	--	01/88 ⇒
-------------	----	---------

INNOCENTI

ELBA 1.3	146A5.000	08/91 ⇒ 12/96
----------	-----------	---------------

LANCIA

DELTA I 1.1	831B8.000	01/86 ⇒ 12/90
DELTA I 1.3	1831B.000, 3831B.000, 831A2.000, 831B.000	09/79 ⇒ 10/92

EPS 1.970.159



05

COILS

Adatt./Suitable:

BOSCH

0 986 221 002

MAGNETI MARELLI

060717005012

SEAT

867 905 105 A

VW

867 905 105 A

00 Eliminated on 23-02-2022. Please verify the availability through our local distributors

- Eliminato il 23-02-2022. Verificare la disponibilità presso i nostri distributori
- Éliminé le 23-02-2022. Vérifier la disponibilité auprès de nos distributeurs sur place
- Am 23-02-2022 gestrichen. Evtl. Verfügbarkeit bitte bei unseren Händlern prüfen
- Eliminado en fecha 23-02-2022. Verificar la disponibilidad a través de nuestros distribuidores locales



	ohm		ohm
	0,56		3300

SEAT

IBIZA II 1.8 i	ADZ	03/93 ⇒ 08/99
IBIZA II 2.0 i	2E	03/93 ⇒ 08/99
TOLEDO I 1.6 i	1F, ABN, EZ	05/91 ⇒ 03/99
TOLEDO I 1.8 i	ABS	11/93 ⇒ 12/96
TOLEDO I 2.0 i	2E	05/91 ⇒ 03/99
TOLEDO I 2.0 i 16V	ABF	11/93 ⇒ 03/99

VW

PASSAT III 1.6	1F, EZ	04/88 ⇒ 07/92
PASSAT III 2.0	2E	02/90 ⇒ 05/97

EPS 1.970.162S



05

COILS

Adatt./Suitable:

BMW

1 317 232
1 703 359
1 703 360
1 726 177
1 727 108
1 730 520
1 730 766
1 734 468
12 13 1 317 232
12 13 1 317 585
12 13 1 402 440
12 13 1 402 713
12 13 1 404 102
12 13 1 703 359
12 13 1 726 177
12 13 1 726 178
12 13 1 727 108
12 13 1 729 842
12 13 1 730 765
12 13 1 730 766
12 13 1 731 884
12 13 1 734 468
12 13 1 748 394
12 13 1 748 395
12 13 7 599 218
7 599 218

BOSCH

1 227 030 082

03 Supplied until depletion

- Fornibile fino ad esaurimento delle scorte
- Fourni jusqu'à épuisement du stock
- Lieferbar solange vorrat reicht
- Suministrado hasta el stock termina

255 without spark plug connector

- senza cappuccio candela d'accensione
- sans cosse de bougie d'allumage
- ohne Zündkerzenstecker
- sin conector de bujía de encendido

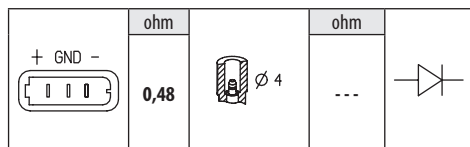

BMW

3 III 318 is	M42B18(18451)	01/92 ⇒ 12/95
3 III 320 i	M50B20(20651), M50B20(20652), M52B20(20653)	01/91 ⇒ 11/99
3 III 325 i	M50B25(25651), M50B25(25652)	09/90 ⇒ 12/95
3 III M3 3.0	S50B30(30651)	11/92 ⇒ 07/95
3 II 318 is	M42B18(18451)	09/89 ⇒ 08/91
5 III 520 i	M50B20(20651), M50B20(20652)	07/91 ⇒ 07/96
5 III 520 i 24V	M50B20(20651), M50B20(20652)	04/90 ⇒ 08/95
5 III 525 i	M50B25(25651), M50B25(25652)	07/91 ⇒ 07/96
5 III 525 i 24V	M50B25(25652)	03/90 ⇒ 08/95
5 III 525 ix	M50B25(25651)	01/92 ⇒ 03/96
5 III 525 ix 24V	M50B25(25651), M50B25(25652)	10/91 ⇒ 08/95
5 III 530 i	M60B30(30851)	09/92 ⇒ 07/96
5 III 530 i V8	M60B30(30851)	09/92 ⇒ 12/95
5 III 540 i	M60B40(40851)	09/93 ⇒ 07/96
5 III 540 i V8	M60B40(40851)	09/92 ⇒ 12/95
5 III M5	S38B38(38651)	01/92 ⇒ 07/95
7 II 730 i, iL V8	M60B30(30851)	04/92 ⇒ 09/94
7 II 740 i, iL V8	M60B40(40851)	05/92 ⇒ 03/94
7 III 730 i, iL	M60B30(30851)	03/94 ⇒ 02/96
7 III 740 i, iL	M60B40(40851)	03/94 ⇒ 02/96
8 840 i	M60B40(40851)	03/93 ⇒ 02/96

EPS 1.970.168



07

COILS

Adatt./Suitable:

ALFA ROMEO

60558152
60586072
60809606

BOSCH

0 221 503 407
0 221 503 457

CITROËN

5970 53

FIAT

60558152
60586072
60809606
7648797

HITACHI

138793
2508793

HONDA

30520-PDF-E01

IVECO

76487970

KIA

OK011-18100

LANCIA

7648797

LAND ROVER

ERR6045

ERR6566 *1

MAGNETI MARELLI

060717037012

PEUGEOT

5970 53

ROVER

ERR6045

VW

048 905 105 1

*1 Without fastening clamp

- Senza staffa di fissaggio
- sans bride de fixation
- ohne Befestigungsbügel
- sin estribo de sujeción

245 without fastening clamp

- senza staffa fissaggio
- sans bride de fixation
- ohne Befestigungsbügel
- sin estribo de sujeción

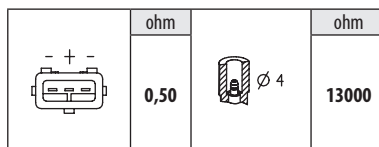

ALFA ROMEO

33 II 1.5 i.e.	AR30738	09/91 ⇒ 12/95
33 II 1.7 i.e.	AR30740	09/91 ⇒ 12/95
145 1.6 i.e.	AR33201	10/94 ⇒ 12/96
145 1.7 i.e. 16V	AR33401	10/94 ⇒ 12/96
146 1.7 i.e. 16V	AR33401	12/94 ⇒ 12/96
155 1.7 T.S.	AR67103, AR67105	04/93 ⇒ 04/96
155 1.8 T.S.	AR67101	02/92 ⇒ 05/94
155 1.8 T.S. Sport	AR67101, AR67102	03/92 ⇒ 12/96
155 2.0 T.S.	AR67201, AR67202	02/92 ⇒ 05/95
164 2.0 T.S.	AR64103	09/92 ⇒ 09/98

CITROËN

JUMPY I 1.6	1580SPI, 220A2.000	10/95 ⇒ 08/00
JUMPY I 1.6 i	1580SPI, 220A2.000	10/95 ⇒ 08/00

FIAT

BRAVA 1.2 16V	182B2.000	12/98 ⇒ 12/02
BRAVA 1.2 16V 80	182B2.000, 188A5.000	10/00 ⇒ 12/02
BRAVA 1.4	182A5.000	10/95 ⇒ 10/01
BRAVA 1.4 12V	182A3.000	10/95 ⇒ 08/98
BRAVO I 1.2 16V 80	182B2.000, 188A5.000	10/00 ⇒ 10/01
BRAVO I 1.4	182A3.000, 182A5.000	10/95 ⇒ 10/01
CROMA I 2000 16V	154E1.000	08/92 ⇒ 08/96
CROMA I 2000 i.e. 16V	154E1.027	03/95 ⇒ 12/96
FIORINO II 1.4	146C5.000	11/92 ⇒ 05/01
FIORINO II 1.6	146D6.000	01/94 ⇒ 05/01
FIORINO II 70 i.e. 1.4	146D5.000	05/94 ⇒ 05/01
FIORINO II 75 i.e. 1.6	146D6.000	10/93 ⇒ 05/01
MAREA 1.2 16V	182B2.000	10/98 ⇒ 05/02
MAREA 1.4 80 12V	182A3.000	09/96 ⇒ 05/02
PALIO 1.2	178D6.011, 188A5.000	03/00 ⇒ 10/04
PUNTO I 1.4 GT Turbo	176A4.000, 176B6.000	10/93 ⇒ 07/99
SCUDO I 1.6	220A2.000	02/96 ⇒ 12/06

FIAT

PUNTO II 1.2 16V	188A5.000	06/03 ⇒
PUNTO II 1.2 16V 80	188A5.000	09/99 ⇒ 04/06
SIENA 1.3	188A5.000	09/01 ⇒ 12/09
TEMPRA 1.4 i.e.	836A4.000	04/90 ⇒ 08/96
TEMPRA 1.6 i.e.	835C1.000	10/90 ⇒ 08/96
TIPO I 1.1 i.e.	156C.046	10/94 ⇒ 10/95
TIPO I 1.4 i.e.	836A4.000	05/89 ⇒ 04/95
TIPO I 1.6	835C1.000	03/93 ⇒ 10/95
TIPO I 1.6 i.e.	835C1.000	10/92 ⇒ 04/95
TIPO I 1.6 i.e. [BRA]	160E2.011	03/93 ⇒ 04/95
UNO Mondo 1.0 i.e.	146D8.000	01/96 ⇒

FIAT (BR)

TIPO 1.6i	1.6Mpi	01/93 ⇒ 12/97
UNO 1.6i	1.6Mpi	01/95 ⇒ 12/96

HONDA

ACCORD 1.6	D16B7	10/98 ⇒ 12/01
ACCORD VI 1.6	D16B6	12/99 ⇒ 12/02
ACCORD VI 1.6 i	D16B6	10/98 ⇒ 12/02
ACCORD VI 1.6 LS	D16B7	10/98 ⇒ 12/02

KIA

SPORTAGE I 2.0 4WD	FE(8V)	06/95 ⇒ 11/98
SPORTAGE I 2.0 i 4WD	FE(8V)	04/94 ⇒ 08/99

LANCIA

DEDRA 1.6 i.e.	835C1.000	04/93 ⇒ 07/99
DELTA II 1.4 i.e.	836A4.000	10/94 ⇒ 08/99
DELTA II 1.6 i.e.	835C1.000	06/93 ⇒ 08/99
KAPPA 2.0 16V Turbo	834A4.000, 838A4.000	02/95 ⇒ 10/01
THEMA 2000 16V	834F1.000	05/92 ⇒ 07/94
THEMA 2000 16V Turbo	834F2.000	10/92 ⇒ 07/94
THEMA 2000 Turbo 16V	834F2.000	11/92 ⇒ 07/94
Y I 1.2 16V	176B9.000, 188A5.000	10/00 ⇒ 09/03
Y I 1.4 12V	840A2.000, 840A4.000	03/96 ⇒ 09/03
Y10 1.1 Fire	176B2.000	01/95 ⇒ 12/95
Y10 1.1 Fire Trazione integrale	176B2.000	01/95 ⇒ 12/95
Y10 1.1 i.e. Fire Trazione integrale	156C.046	09/92 ⇒ 12/95

LAND ROVER

DISCOVERY II 4.0 V8 4x4	35D, 56D, 94D	11/98 ⇒ 06/04
DISCOVERY II 4.6 V8 [USA]	--	01/03 ⇒ 06/04
RANGE ROVER II 3.9 4x4	42D	07/94 ⇒ 03/02
RANGE ROVER II 4.0 4x4	42D, 46698710	01/95 ⇒ 03/02
RANGE ROVER II 4.6 4x4	46D, 48D, 60D	07/94 ⇒ 03/02

PEUGEOT

EXPERT 1.6	222A2(1580SPI)	02/96 ⇒ 09/00
------------	----------------	---------------

VOLKSWAGEN (BR)

GOL 2.0i 16V	112	10/95 ⇒
PARATI 2.0i 16V	112	02/96 ⇒

EPS 1.970.169



07

COILS

Adatt./Suitable:

BOSCH

0 221 122 008
0 221 122 031
0 221 122 450

FORD

1 027 283
6 077 429
79BB-12024-AA
92GB-12024-AA

HITACHI

138803

MERCURY

E73Z12029A

Motorcraft

EDG 27

VW

046 905 105

⁹⁶⁰ Dry (epoxy) coil replacing original oil-bath coil version

- Bobina (resinizzata) sostitutiva originale a bagno d'olio
- Bobine seche, remplaçant la bobine d'origine à bain d'huile
- Trockenspule, die die Originale im Ölbad ersetzt
- Bobina seca, sustituye modelo original con baño de aceite

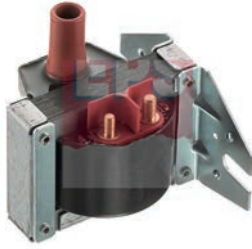

-	+	ohm	ohm
M5	M6	0,75	7200
		Ø 8,2	

EPS 1.970.170



07,5

COILS

Adatt./Suitable:

DENSO

029700-6760
029700-7180
029700-7910

FORD

5 008 196
6 489 415
6 630 365
6 958 305
919F-12029-AA
E95F-12029-AA
E95Z-12029-A
F15U-12029-AA
F55U-12029-AA
F55U-12029-AB

FORD AUSTRALIA

6 958 305
F55U-12029-AA
F55Z-12029-A

FORD USA

5 008 196
6 958 305
F55U-12029-AA
F55U-12029-AB

JAGUAR

LNA 1508AA

MAGNETI MARELLI

060717048012

Motorcraft

DG 440

DGE-456

⁰³ Supplied until depletion

- Fornibile fino ad esaurimento delle scorte
- Fourni jusqu'à épuisement du stock
- Lieferbar solange vorrat reicht
- Suministrado hasta el stock termina



- - - +	ohm	ohm
	0,50	13000
		Ø 7

FORD

COUGAR 2.5 ST 200	SGA	01/00 ⇒ 12/01
COUGAR 2.5 ST 200 24V	MABB	08/98 ⇒
COUGAR 2.5 V6 24V	JP25LCBD, LCBA, LCBB, LCBC, LCBE	06/00 ⇒ 12/01
MONDEO I 2.5 24V	SEA, SEB, SEC	08/96 ⇒ 09/00
MONDEO I 2.5 i 24V	SEA	07/94 ⇒ 08/96
MONDEO I 2.5 ST 200	SGA	05/99 ⇒ 09/00
SCORPIO I 2.9 24V	BOA	08/93 ⇒ 09/94
SCORPIO I 2.9 i 24V	BOA	04/91 ⇒ 09/94
SCORPIO II 2.9 i 24V	BOB	10/94 ⇒ 08/98
WINDSTAR 3.0 i 12V	99U	04/95 ⇒ 07/97
WINDSTAR 3.0 i 12V S	99U	08/97 ⇒

FORD AUSTRALIA

TAURUS 3.0i V6 -- 01/96 ⇒

FORD USA

WINDSTAR 3.0 V6 --, 99U30 01/95 ⇒ 02/99

JAGUAR

XJ 12 6.0 8E 09/94 ⇒ 09/97

FORD

ESCORT III 1.3	JPA	09/80 ⇒ 02/86
ESCORT III 1.4 i	F6B, F6D, FUC	02/86 ⇒ 07/90
ESCORT III 1.6	LP1, LPA	09/80 ⇒ 12/85
ESCORT III 1.6 i	LR1	09/83 ⇒ 12/85
ESCORT III 1.6 XR3i	LR1, LRA	10/82 ⇒ 12/85
ESCORT IV 1.4	F6B, F6D, FUA, FUC	01/86 ⇒ 07/90
ESCORT IV 1.6 Turbo RS	LNB	01/86 ⇒ 07/90
ESCORT IV 1.6 XR3i	LR2, LRB	01/86 ⇒ 07/90
ESCORT V RS Cosworth 4x4	NSF	10/91 ⇒ 01/95
FIESTA II 1.4	FUB, FUD	10/85 ⇒ 11/89
FIESTA II 1.6 XR2	LUB, LUD	03/84 ⇒ 02/89
FIESTA III 1.4	F6E	03/89 ⇒ 12/95
GRANADA 1.7	TV17LC	08/77 ⇒ 05/82
GRANADA 2.0	NEP	08/79 ⇒ 08/85
SIERRA I 1.3	JCT	08/82 ⇒ 12/86
SIERRA I 1.8	REB	10/84 ⇒ 12/86
SIERRA I 2.0	NET	08/82 ⇒ 12/86
SIERRA I 2.0 i	NR2	03/85 ⇒ 12/86
ORION I 1.3	JPA	07/83 ⇒ 03/86
ORION I 1.4	FUA, FUC	12/85 ⇒ 07/90
ORION I 1.4 Cat	F6B, F6D	02/87 ⇒ 07/90
ORION I 1.6	LP1, LPA	07/83 ⇒ 03/86
ORION I 1.6 i	LR1, LRA, LRB	07/83 ⇒ 07/90
SCORPIO I 1.8	REC	04/85 ⇒ 02/92
SCORPIO I 2.0	TL20H-NE4, TL20H-NER	10/84 ⇒ 02/90
SCORPIO I 2.0 i	N9B, N9D, N9F, NRA, NRI	04/85 ⇒ 09/94
SCORPIO I 2.4 i	ARC	09/86 ⇒ 09/88
SCORPIO I 2.9 i	BRC, BRD, BRE, BRF	09/86 ⇒ 12/94
SCORPIO I 2.9 i 4x4	BRC, BRD, BRE, BRF	09/86 ⇒ 10/94
SCORPIO I 2.9 i Cat	BRE	10/87 ⇒ 09/94
SCORPIO II 2.9 i	BRG	02/95 ⇒ 08/98
SIERRA II 1.8	R2C, R6A	05/88 ⇒ 02/93
SIERRA II 2.0	N8C, NES	01/87 ⇒ 02/93
SIERRA II 2.0 i	N4A, N4I, N9B	01/87 ⇒ 02/93
TRANSIT II 1.6	LAC, LAT	09/85 ⇒ 09/92
TRANSIT II 2.0	NGTS, NAT, NAV, NAW, NBA, NCA, NSF, NSG, NSH	09/85 ⇒ 03/00
TRANSIT II 2.0 Cat	NGT	11/85 ⇒ 09/92
TRANSIT II 2.0 EFI	--	08/91 ⇒ 08/94
TRANSIT II 2.0 i	NCA	09/91 ⇒ 07/94
TRANSIT II 2.0 L	NAW, NAX	10/85 ⇒ 03/91
TRANSIT II 2.9 i	BRT	01/91 ⇒ 09/94
TRANSIT 2.0	NSHCNG	06/94 ⇒ 03/00
TRANSIT TOURNEO 2.0	NSF, NSG, NSH	11/94 ⇒ 12/00

EPS

1.970.178



07

COILS

Adatt./Suitable:

BOSCH

0 221 118 329
0 221 502 431

HITACHI

138716

2508716

MERCEDES-BENZ

A 000 158 45 03
A 000 158 48 03
A 000 158 50 03
A 000 158 53 03
A 000 158 54 03
A 000 158 61 03
A 000 158 62 03

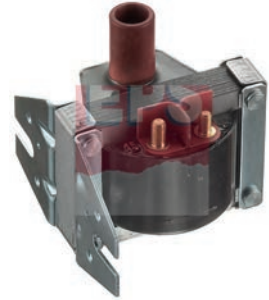

+	-	ohm	ohm
M6	M5	0,38	10500
		Ø 8,2	

MERCEDES-BENZ

CLASSE E I E 300 4-matic	M103.985	06/93 ⇒ 06/95
CLASSE E I E 300 T 4-matic	M103.985	06/93 ⇒ 06/96
CLASSE E I E 420	M119.975	06/93 ⇒ 06/95
CLASSE E I E 500	M119.974	06/93 ⇒ 06/95
CLASSE E I E 60 AMG	M119.974(AMG6.0)	05/94 ⇒ 06/95
124 200 CE	M102.963	09/89 ⇒ 06/93
124 230 CE	M102.982	03/87 ⇒ 12/92
124 230 CE Cat	M102.982	06/89 ⇒ 12/92
124 300 CE	M103.983	03/87 ⇒ 05/93
190 2.0	M102.924	08/83 ⇒ 05/90
190 2.3	M102.985	09/87 ⇒ 09/88
190 2.3 E	M102.985	10/82 ⇒ 09/88
190 2.6	M103.942	10/82 ⇒ 09/88
190 E 1.8	M102.910, M102.919	04/90 ⇒ 12/93
190 E 2.0	M102.962	10/82 ⇒ 08/93
190 E 2.3	M102.985	09/86 ⇒ 08/93
190 E 2.3-16	M102.983	04/84 ⇒ 08/88
190 E 2.5-16	M102.990	09/88 ⇒ 08/93
190 E 2.5-16 Evolution	M102.991	03/89 ⇒ 08/93
190 E 2.5-16 Evolution II	M102.992	05/90 ⇒ 08/93
190 E 2.6	M103.942	09/86 ⇒ 08/93
190 E 3.2 AMG	M103.983	01/88 ⇒
CLASSE G II 200 GE	M102.965	01/90 ⇒ 07/93
CLASSE G II 230 GE	M102.979, M102.989, M102.996, M102.997	09/89 ⇒ 07/96
CLASSE G II 300 GE	M103.987	09/89 ⇒ 09/97
CLASSE S II 260 SE	M103.941	09/85 ⇒ 06/91
CLASSE S II 300 SE, SEL	M103.981	09/85 ⇒ 06/91
CLASSE S II 380 SE, SEL	M116.963	10/81 ⇒ 08/85
CLASSE S II 380 SEC	M116.963	10/81 ⇒ 07/85
CLASSE S II 500 SE, SEL	M117.961, M117.963	12/79 ⇒ 08/85
CLASSE S II 500 SEC	M117.963	08/80 ⇒ 08/85
CLASSE S III 400 SE, SEL/S420	M119.971	02/91 ⇒ 10/98
CLASSE S III 500 SE, SEL	M119.970	02/91 ⇒ 10/98
CLASSE S III 500 SEC / CL 500	M119.970	10/92 ⇒ 12/99
CLASSE S III S 420	M119.971	01/93 ⇒ 10/98
CLASSE S III S 500	M119.970	01/93 ⇒ 10/98
CLASSE S III SEC/CL 420	M119.971	10/94 ⇒ 02/99
CLASSE SL III 300 SL	M103.982	09/85 ⇒ 08/89
CLASSE SL IV 300 SL	M103.984	03/89 ⇒ 08/93
CLASSE SL IV 500 SL	M119.960	09/89 ⇒ 08/92
KOMBI II 200 T	M102.922	09/85 ⇒ 05/90
KOMBI II 200 TE	M102.962, M102.963	09/88 ⇒ 08/92
KOMBI II 230 E Chassis	M102.982	09/86 ⇒ 06/93
KOMBI II 230 TE	M102.982	09/85 ⇒ 08/92
KOMBI II 230 TE Cat	M102.982	06/89 ⇒ 08/92
KOMBI II 260 TE FGST.	M103.940	09/89 ⇒ 08/92
KOMBI II 300 TE	M103.983	01/86 ⇒ 08/92

CITROËN			
SAXO 1.0 X	CDY(TU9M), CDZ(TU9M)	05/96 ⇒	11/98
SAXO 1.1 BiFuel	HDZ(TU1M)	07/00 ⇒	06/03
SAXO 1.1 X, SX	HDZ(TU1M)	05/96 ⇒	09/03
SAXO 1.4 VTS	KFW(TU3JP), KFX(TU3JP)	05/96 ⇒	06/03
SAXO 1.6	NFT(TU5JP), NFZ(TU5JP)	02/01 ⇒	04/04
SAXO 1.6 VTL, VTR	NFZ(TU5JP)	05/96 ⇒	06/03
SAXO 1.6 VTS	NFT(TU5JP)	09/00 ⇒	09/03
XANTIA II 1.6 i SX	BFZ(XU5JP)	01/98 ⇒	03/01
XANTIA II 1.8 i	LFX(XU7JB)	01/98 ⇒	04/03
XANTIA II 2.0 i	RFX(XU10J2C)	01/98 ⇒	04/03
XANTIA II 2.0 Turbo	RGX(XU10J2TE)	01/98 ⇒	04/03
XM II 2.0	XU10J2	08/94 ⇒	07/99
XM II 2.0 Turbo	RGX(XU10J2TE), RGY(XU10J2TE/Z)	05/94 ⇒	10/00
ZX 1.4 i	KFX(TU3JP)	03/91 ⇒	10/97
ZX 1.6	BDY(XU5M), BFZ(XU5JP)	07/94 ⇒	10/97
ZX 1.6 i	BDY(XU5M), BFZ(XU5JP)	03/91 ⇒	10/97
ZX 1.8	LFZ(XU7JP)	03/91 ⇒	10/97
ZX 1.8 i	LFZ(XU7JP)	07/92 ⇒	10/97
ZX 1.9	D6E(XU9JA)	03/91 ⇒	06/97
ZX 1.9 i	DKZ(XU9JA), XU9JA	03/91 ⇒	06/97
ZX 2.0	RFX(XU10J2C)	07/94 ⇒	10/97
ZX 2.0 i	RFX(XU10J2C), XU10J2	07/92 ⇒	10/97

FIAT			
DUCATO II 2.0	RFL	03/94 ⇒	
DUCATO II 2.0 4x4	RFL	11/94 ⇒	07/06
DUCATO II 2.0 Bipower	RFL	11/02 ⇒	
DUCATO II 2.0 LPG	RFL	11/02 ⇒	07/06
DUCATO II 2.0 Panorama/ Combinato	RFW	03/94 ⇒	04/02
ELBA 1.4	146D5.000	10/93 ⇒	02/95
ULYSSE I 1.8	LFW(XU7JP)	05/97 ⇒	08/02
ULYSSE I 2.0	RFU(XU10J2C)	06/94 ⇒	08/02
ULYSSE I 2.0 Turbo	RGX(XU10J2CTE)	06/94 ⇒	08/02

INNOCENTI			
ELBA 1.4 i.e.	146D5.000	09/94 ⇒	12/96
ELBA 1.6 i.e.	146D6.000	09/94 ⇒	12/96

LANCIA			
ZETA 2.0 Turbo	RGX(XU10J2TE)	05/95 ⇒	09/02

PEUGEOT			
106 I 1.0	CDY(TU9M), TU9	04/96 ⇒	03/01
106 II 1.0 i	CDY(TU9M), CDZ(TU9M)	04/96 ⇒	10/99
106 II 1.1 BiFuel	HDZ(TU1M+)	04/96 ⇒	03/01
106 II 1.1 i	HDY(TU1M+), HDZ(TU1M)	05/96 ⇒	07/04
106 II 1.4 i	KFW(TU3JP), KFX(TU3JP)	05/96 ⇒	07/04
106 II 1.6 i	NFZ(TU5JP)	05/96 ⇒	10/99
205 II 1.6 i	BDZ(XU5M)	01/91 ⇒	12/94
306 1.4	KFW(TU3JP), KFX(TU3JP)	04/93 ⇒	04/02
306 1.4 SL	KFW(TU3JP), KFX(TU3JP)	06/94 ⇒	05/01
306 1.6	NFZ(TU5JP)	05/93 ⇒	10/00
306 1.6 SR	NFZ(TU5JP)	06/94 ⇒	10/00
306 1.8	-, LFZ(XU7JP)	05/93 ⇒	04/02
306 1.8 ST	LFZ(XU7JP)	06/94 ⇒	05/01
306 2.0	RFX(XU10J2)	03/94 ⇒	04/02
306 2.0 ST	RFX(XU10J2)	07/94 ⇒	05/01
306 2.0 XSi	RFX(XU10J2)	05/93 ⇒	05/01
BOXER I 2.0	RFL(XU10J2U)	12/01 ⇒	
BOXER I 2.0 4x4	-	03/96 ⇒	09/98
BOXER I 2.0 i	RFW(XU10J2)	03/94 ⇒	04/02
BOXER I 2.0 i 4x4	RFW(XU10J2)	08/96 ⇒	04/02
309 II 1.6	BDZ(XU5M)	07/89 ⇒	12/93
405 II 1.6	BDY(XU5M2Z), BDY(XU5M3Z), BDZ(XU5M), BFZ(XU5JP)	08/92 ⇒	05/97
405 II 1.8	LFZ(XU7JP)	08/92 ⇒	10/96
405 II 1.9	XU9J2/D6D	01/93 ⇒	12/96
405 II 2.0	RFX(XU10J2)	08/92 ⇒	10/96
405 II 2.0 4x4	RFX(XU10J2)	08/92 ⇒	10/96
405 II 2.0 X4	RFX(XU10J2)	08/92 ⇒	10/95
406 1.6	BFZ(XU5JP)	11/95 ⇒	05/04
406 1.8	L6A(XU7JP), LFX(XU7JB), LFZ(XU7JP)	10/96 ⇒	03/99
406 2.0 Turbo	RGX(XU10J2TE)	04/96 ⇒	10/04
EXPERT I 1.8	L6B(XU7JP), LFZ(XU7JP)	09/96 ⇒	
605 2.0	RFZ(XU10J2Z)	06/89 ⇒	09/99
605 2.0 Turbo	RGX(XU10J2TE), RGY(XU10J2TE)	07/91 ⇒	09/99
806 1.8	LFW(XU7JP)	07/95 ⇒	08/02
806 2.0	RFU(XU10J2)	06/94 ⇒	08/02
806 2.0 Turbo	RGX(XU10J2TE)	06/94 ⇒	08/02
PARTNER I 1.1	HDY(TU1M), HDZ(TU1M)	06/96 ⇒	
PARTNER I 1.4	KFX(TU3JP)	06/96 ⇒	12/15
PARTNER I 1.8	LFX(XU7JB)	03/97 ⇒	12/02
RANCH 1.1	HDY(TU1M), HDZ(TU1M)	06/96 ⇒	
RANCH 1.4	KFX(TU3JP)	06/96 ⇒	
RANCH 1.8	LFX(XU7JB)	05/97 ⇒	



COILS

Adatt./Suitable:

BOSCH

0 221 503 003
0 221 503 006
0 221 503 024

CITROËN

5970 49
96 062 288

DUCELLIER

2 526 035 A

HITACHI

138756
2508756

MAGNETI MARELLI

060717129012

PEUGEOT

5970 49
96 062 288

ROVER

GCL204
NEC100710

93 Supplied until depletion

- Fornibile fino ad esaurimento delle scorte
- Fourni jusqu'à épuisement du stock
- Lieferbar solange vorrat reicht
- Suministrado hasta el stock termina



	ohm		ohm
	0,70		9000

CITROËN

AX 1.4 GTi	KFY(TU3FJ2), KFZ(TU3FJ2)	06/91 ⇒	12/96
AX 10	CDY(TU9M), CDZ(TU9M)	07/86 ⇒	12/98
AX 11	HDZ(TU1M)	09/86 ⇒	12/97
AX 14	K6B(TU3FJ2), KDX(TU3M/Z), KDY(TU3FM)	04/87 ⇒	04/97
AX 14 4x4	KDY(TU3FM)	08/91 ⇒	12/96
ZX 1.1	HDZ(TU1M)	03/91 ⇒	06/97
ZX 1.4	KDZ(TU3M/Z)	03/91 ⇒	06/97
ZX 1.4 i	KDX(TU3M/Z), KDZ(TU3M/Z)	03/91 ⇒	10/97

PEUGEOT

106 I 1.0	CDY(TU9M), CDZ(TU9M)	09/91 ⇒	04/96
106 I 1.1	HDZ(TU1M)	09/91 ⇒	04/96
106 I 1.3	TU2J2	10/93 ⇒	04/96
106 I 1.4	KDX(TU3MC)	09/91 ⇒	04/96
106 I 1.4 i	TU3FJ, TU3FMC	01/91 ⇒	12/96
106 I 1.4 i XSi	TU3J	09/91 ⇒	03/96
106 I 1.4 Le Mans	KFZ(TU3J2/Z)	09/91 ⇒	11/94
106 I 1.6	NFY(TU5J2), NFZ(TU5JP)	06/93 ⇒	04/96
106 II 1.6 i	NFW(TU5J2), NFY(TU5J2)	05/96 ⇒	01/01
205 II 1.0	CDZ(TU9M)	08/92 ⇒	05/97
205 II 1.1	HDZ(TU1M)	07/89 ⇒	09/98
205 II 1.4	KDX(TU3MC)	07/88 ⇒	09/98
306 1.1	HDZ(TU1M)	05/93 ⇒	05/01
306 1.4	KDX(TU3MC)	04/93 ⇒	07/01
306 1.4 SL	KDX(TU3MC)	06/94 ⇒	05/01
306 1.6	NFZ(TU5JP)	05/93 ⇒	10/00
306 1.6 SR	NFZ(TU5JP)	06/94 ⇒	10/00
405 II 1.4	TU3FM	01/93 ⇒	12/96

ROVER

400 II 420 Si Lux	1CA46A15-01, 20M4F	12/95 ⇒	03/00
600 620 Ti Vitesse	20T4G	05/94 ⇒	08/98
800 820 I/SI	1CA46A15-01	01/91 ⇒	02/99
400 I 2.0 i	1CA46A15-01	05/94 ⇒	11/98
MINI 1300	12A2A, 12A2B, 12A2D, 12A2E, 12A2L	01/91 ⇒	04/95



COILS

Adatt./Suitable:

BOSCH

0 221 122 402
0 221 122 403
1 227 020 029

GENERAL MOTORS

90 277 970

OPEL

12 08 047

VAUXHALL

90277970

90 Eliminated on 23-02-2022. Please verify the availability through our local distributors

- Eliminato il 23-02-2022. Verificare la disponibilità presso i nostri distributori
- Éliminé le 23-02-2022. Vérifier la disponibilité auprès de nos distributeurs sur place
- Am 23-02-2022 gestrichen. Evtl. Verfügbarkeit bitte bei unseren Händlern prüfen
- Eliminado en fecha 23-02-2022. Verificar la disponibilidad a través de nuestros distribuidores locales

960 Dry (epoxy) coil replacing original oil-bath coil version

- Bobina (resinizzata) sostitutive originale a bagno d'olio
- Bobine sèche, remplaçant la bobine d'origine à bain d'huile
- Trockenspule, die die Originale im Ölbad ersetzt
- Bobina seca, sustituye modelo original con baño de aceite

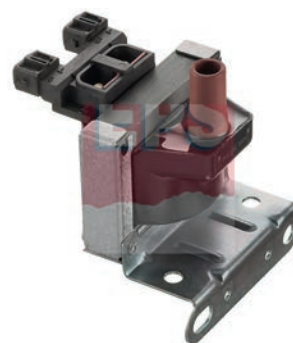

	ohm		ohm
	0,68		7200

OPEL

CALIBRA A 2.0 i	C20NE	08/89 ⇒	12/96
CALIBRA A 2.0 i 4x4	C20NE	06/90 ⇒	07/97
KADETT E 1.8 i	S18NV	06/85 ⇒	08/91
KADETT E 1.8 S	E18NV	09/87 ⇒	08/91
KADETT E 2.0 GSI	Z0NE, Z0SEH	09/86 ⇒	08/91
KADETT E 2.0 GSI Cat	C20NE	09/86 ⇒	08/91
KADETT E 2.0 i	Z0NE	10/86 ⇒	02/93
KADETT E 2.0 i Cat	C20NE	10/86 ⇒	02/93
OMEGA A 1.8	E18NVR, S18NV	09/86 ⇒	03/94
OMEGA A 1.8 N	18NV	09/86 ⇒	08/87
OMEGA A 2.0	Z0SE, C20NE	09/86 ⇒	04/94
OMEGA A 2.0 i	C20NE	09/86 ⇒	04/94
OMEGA A 2.4 i	C24NE	09/88 ⇒	03/94
OMEGA A 3.0	C30LE, C30NE	03/87 ⇒	03/94
OMEGA A 3.0 Cat	C30NE	03/87 ⇒	03/94
OMEGA B 2.0	Z0SE	03/94 ⇒	12/00
SENATOR B 3.0	C30LE	09/87 ⇒	09/93
SENATOR B 3.0 i Cat	C30NE	01/88 ⇒	09/93
VECTRA A 1.8 S	E18NVR	09/88 ⇒	07/89
VECTRA A 1.8 S 4x4	E18NVR	01/89 ⇒	07/89
VECTRA A 2.0 i	Z0NE, Z0SEH	09/88 ⇒	09/92
VECTRA A 2.0 i 4x4	Z0NE, Z0SEH	01/89 ⇒	07/92
VECTRA A 2.0 i Cat	C20NE	09/88 ⇒	11/95
VECTRA A 2.0 i Cat 4x4	C20NE	01/89 ⇒	11/95
VECTRA A 2.0 i GT	Z0SEH	09/88 ⇒	11/95

VAUXHALL

CALIBRA 2.0 i	C20NE	06/90 ⇒	07/97
CALIBRA 2.0 i 4x4	C20NE	06/90 ⇒	07/97
OMEGA B 2.0	Z0SE	09/95 ⇒	09/96

EPS 1.970.192



07

COILS

Adatt./Suitable:

BOSCH

0 221 122 408
0 221 122 409
1 220 522 019
1 221 122 409
F 000 Z50 001

GENERAL MOTORS

30 584 237
90 350 021

OPEL

12 08 053

SAAB

12 08 053
30 584 237
42 26 031
51 71 111
90 350 021
90 350 987
90 369 434

SCANIA

30584237
4226031
5171111

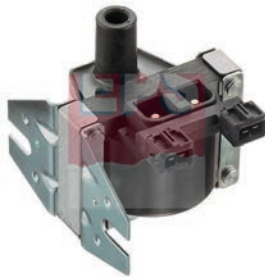

	ohm		ohm
	0,68		7200

⁹⁶⁰ Dry (epoxy) coil replacing original oil-bath coil version

- Bobina (resinizzata) sostituyente originale a bagno d'olio
- Bobine seche, remplaçant la bobine d'origine à bain d'huile
- Trockenspule, die die Originale im Ölbad ersetzt
- Bobina seca, sustituye modelo original con baño de aceite

SAAB

900 II 2.0 i	B204I, B206I	07/93 ⇒ 02/98
900 II 2.3 -16	B234I	07/93 ⇒ 02/98

VAUXHALL

ASTRA III 1.8 i	C18NZ	09/91 ⇒ 09/98
ASTRA III 1.8 i 16V	18SE	09/95 ⇒ 02/98
ASTRA III 2.0 i	C20NE	09/91 ⇒ 09/98
CALIBRA 2.0 i	C20NE	06/90 ⇒ 07/97
CALIBRA 2.0 i 4x4	C20NE	06/90 ⇒ 07/97
FRONTERA A 2.0	C20NE	04/95 ⇒ 08/98
FRONTERA A 2.0 i	C20NE	03/92 ⇒ 10/98
FRONTERA A 2.4 i	C24NE	03/92 ⇒ 10/98
OMEGA B 2.0	20SE	09/95 ⇒ 09/96

EPS 1.970.194



07

COILS

Adatt./Suitable:

BOSCH

0 221 122 369

GENERAL MOTORS

90 240 252

OPEL

12 08 041

VAUXHALL

90240252

⁰³ Supplied until depletion

- Fornibile fino ad esaurimento delle scorte
- Fourni jusqu'à épuisement du stock
- Lieferbar solange vorrat reicht
- Suministrado hasta el stock termina

⁹⁶⁰ Dry (epoxy) coil replacing original oil-bath coil version

- Bobina (resinizzata) sostituyente originale a bagno d'olio
- Bobine seche, remplaçant la bobine d'origine à bain d'huile
- Trockenspule, die die Originale im Ölbad ersetzt
- Bobina seca, sustituye modelo original con baño de aceite



	ohm		ohm
	0,72		7200

OPEL

ASTRA F 1.6	16LZ2, 16NZ2	09/94 ⇒ 09/98
ASTRA F 1.8 i	C18NZ	09/91 ⇒ 09/98
ASTRA F 1.8 i 16V	18SE	09/95 ⇒ 09/96
ASTRA F 2.0 i	C20NE	09/91 ⇒ 09/98
CALIBRA A 2.0 i	C20NE	08/89 ⇒ 12/96
CALIBRA A 2.0 i 4x4	C20NE	06/90 ⇒ 07/97
FRONTERA A 2.0 i	C20NE	03/92 ⇒ 10/98
FRONTERA A 2.4 i	C24NE	03/92 ⇒ 10/98
KADETT E 1.8 i	S18NV	06/85 ⇒ 08/91
KADETT E 1.8 S	E18NV	09/87 ⇒ 08/91
KADETT E 2.0 GSI	20NE, 20SEH	09/86 ⇒ 08/91
KADETT E 2.0 GSI Cat	C20NE	09/86 ⇒ 08/91
KADETT E 2.0 i	20NE	10/86 ⇒ 02/93
KADETT E 2.0 i Cat	C20NE	10/86 ⇒ 02/93
OMEGA A 1.8	E18NVR, S18NV	09/86 ⇒ 03/94
OMEGA A 1.8 N	18NV	09/86 ⇒ 08/87
OMEGA A 2.0	20SE, C20NE	09/86 ⇒ 04/94
OMEGA A 2.0 i	C20NE	09/86 ⇒ 04/94
OMEGA A 2.4 i	C24NE	09/88 ⇒ 03/94
OMEGA A 2.6 i	C26NE	09/90 ⇒ 03/94
OMEGA A 3.0	C30LE, C30NE	03/87 ⇒ 03/94
OMEGA A 3.0 24V	C30SE	09/89 ⇒ 03/94
OMEGA A 3.0 24V Omega 3000	C30SE	09/88 ⇒ 04/94
OMEGA A 3.0 Cat	C30NE	03/87 ⇒ 03/94
OMEGA B 2.0	20SE	03/94 ⇒ 12/00
SENATOR B 3.0	C30LE	09/87 ⇒ 09/93
SENATOR B 3.0 24V	C30SE	09/89 ⇒ 09/93
SENATOR B 3.0 i Cat	C30NE	01/88 ⇒ 09/93
VECTRA A 1.8 S	E18NVR	09/88 ⇒ 07/89
VECTRA A 1.8 S 4x4	E18NVR	01/89 ⇒ 07/89
VECTRA A 2.0 i	20NE, 20SEH	09/88 ⇒ 09/92
VECTRA A 2.0 i 4x4	20NE, 20SEH	01/89 ⇒ 07/92
VECTRA A 2.0 i Cat	C20NE	09/88 ⇒ 11/95
VECTRA A 2.0 i Cat 4x4	C20NE	01/89 ⇒ 11/95
VECTRA A 2.0 i GT	20SEH	09/88 ⇒ 11/95

SAAB

9-3 2.0 i	B204I	02/98 ⇒ 08/03
9-3 2.0 SE Turbo	B204R	02/98 ⇒ 08/03
9-3 2.0 Turbo	B204E, B204L, B205E, B205L, B205R	02/98 ⇒ 08/03
9-3 2.3	B235R	09/99 ⇒ 01/02
9-3 2.3 i	B234I	02/98 ⇒ 08/03

OPEL

ASCONA C 1.8	E18NV	09/87 ⇒ 08/88
ASCONA C 1.8 E	S18NV	01/85 ⇒ 08/86
ASCONA C 2.0 i	20NE	09/86 ⇒ 08/88
ASCONA C 2.0 i Cat	C20NE	09/86 ⇒ 08/88
ASCONA C 2.0 i GT	20SEH	03/87 ⇒ 08/88
KADETT E 1.8 i	S18NV	06/85 ⇒ 08/91
KADETT E 1.8 S	E18NV	09/87 ⇒ 08/91
KADETT E 2.0 GSI	20NE, 20SEH	09/86 ⇒ 08/91
KADETT E 2.0 GSI Cat	C20NE	09/86 ⇒ 08/91
KADETT E 2.0 i	20NE	10/86 ⇒ 02/93
KADETT E 2.0 i Cat	C20NE	10/86 ⇒ 02/93
OMEGA A 1.8	E18NVR, S18NV	09/86 ⇒ 03/94
OMEGA A 1.8 N	18NV	09/86 ⇒ 08/87
OMEGA A 2.0	20SE, C20NE	09/86 ⇒ 04/94
OMEGA A 2.0 i	C20NE	09/86 ⇒ 04/94
OMEGA A 3.0	C30LE, C30NE	03/87 ⇒ 03/94
OMEGA A 3.0 Cat	C30NE	03/87 ⇒ 03/94
OMEGA B 2.0	20SE	03/94 ⇒ 12/00
SENATOR B 3.0	C30LE	09/87 ⇒ 09/93
SENATOR B 3.0 i Cat	C30NE	01/88 ⇒ 09/93

VAUXHALL

OMEGA B 2.0	20SE	09/95 ⇒ 09/96
-------------	------	---------------

EPS

1.970.196



05

COILS

Adatt./Suitable:

BOSCH

0 986 221 033

HITACHI

138738
2508738

MAGNETI MARELLI

060708049010
060708149010
060717051012
BAE 800 EK
BAE 801 EK

RENAULT

77 00 107 269

SEAT

SE 028915.000B



	ohm		ohm
	0,54		7500

RENAULT

ESPACE III 2.0	F3R728, F3R729, F3R742, F3R768, F3R769	11/96 ⇒ 10/00
LAGUNA I 1.8	F3P670, F3P674, F3P676, F3P678	06/95 ⇒ 03/01
LAGUNA I 2.0	---, F3R611, F3R728, F3R729, F3R768	11/93 ⇒ 03/01
MEGANE I 2.0	F3R262, F3R264, F3R750, F3R791	01/97 ⇒ 08/03
MEGANE I 2.0 i	F3R750, F3R751, F3R752, F3R791, F3R796, F3R797, F3R798	01/96 ⇒ 08/03
MEGANE I 2.0 RT	F3R750, F3R751, F3R752, F3R791, F3R796, F3R797, F3R798	10/96 ⇒ 02/99
MEGANE SCÉNIC I 2.0 i	F3R750, F3R751, F3R791, F3R796, F3R797, F3R798	01/97 ⇒ 09/99
MEGANE SCÉNIC I 2.0 RXE 4x4	F3R750	05/97 ⇒ 10/99
SCÉNIC I 2.0	F3R791, F3R797, F3R798	09/99 ⇒ 08/03

SEAT

MARBELLA 0.9 Cat	08NCB	11/96 ⇒ 10/98
TERRA 0.9 Cat	09NCB	02/92 ⇒ 12/94

EPS 1.970.197



05

COILS

Adatt./Suitable:

BOSCH
F 005 X11 771
DENSO
029700-5430
GENERAL MOTORS
94 840 127
HOLDEN
9091902135
TOYOTA
90919-02135

- 00 Eliminated on 23-02-2022. Please verify the availability through our local distributors**
- Eliminato il 23-02-2022. Verificare la disponibilità presso i nostri distributori
 - Éliminé le 23-02-2022. Vérifier la disponibilité auprès de nos distributeurs sur place
 - Am 23-02-2022 gestrichen. Evtl. Verfügbarkeit bitte bei unseren Händlern prüfen
 - Eliminado en fecha 23-02-2022. Verificar la disponibilidad a través de nuestros distribuidores locales



M4	M4	ohm	ohm
		0,45	8500

HOLDEN			
APOLLO 2.0 i	3S-FE		08/89 ⇒ 02/93
TOYOTA			
CAMRY 2.0	3S-FE		03/83 ⇒ 02/93
CAMRY 2.0 4WD	3S-FE		03/83 ⇒ 06/91
CARINA II 2.0	3S-FE		12/87 ⇒ 04/92
CARINA II 2.0 GLi	3S-FE		12/87 ⇒ 03/92
COROLLA V 1.6	4A-C, 4A-LC		08/84 ⇒ 05/89
COROLLA V 1.6 SR	4A-C		08/83 ⇒ 04/85
COROLLA VI 1.6	4A-FE		08/89 ⇒ 04/92
COROLLA VI 1.6 i	4A-FE		05/87 ⇒ 05/92
COROLLA VI 1.6 i 4WD	4A-FE		10/87 ⇒ 08/90
COROLLA VI 1.6 XLI	4A-FE		11/89 ⇒ 06/92
LITEACE 2.2	4Y-EC		01/92 ⇒ 01/95
MODEL F 2.2	4Y-EC		08/85 ⇒ 01/90
CELICA IV 2.0i [USA]	2SEL, 3S-FE		01/85 ⇒ 12/87
TERCEL 1.5	3A-C		08/83 ⇒ 05/85
TERCEL 1.5 4WD	3A-C		09/82 ⇒ 01/88
TERCEL 1.5 i [USA]	3EE		01/89 ⇒ 12/90
VAN 2.0 [USA]	3YEC		01/83 ⇒ 12/90
VAN 2.2 [USA]	4YEC		01/83 ⇒ 12/90

EPS 1.970.198



05

COILS

Adatt./Suitable:

BOSCH
F 000 Z50 121
HITACHI
138866
2508866
HOLDEN
9091902163
TOYOTA
90919-02163

- 03 Supplied until depletion**
- Fornibile fino ad esaurimento delle scorte
 - Fourni jusqu'à épuisement du stock
 - Lieferbar solange vorrat reicht
 - Suministrado hasta el stock termina



M4	M4	ohm	ohm
		0,45	12200

HOLDEN		
APOLLO 2.2 i	08GR-FXS	03/93 ⇒ 05/97
TOYOTA		
4 RUNNER 2.7 4WD	3RZ-FE	11/95 ⇒ 08/02
CAMRY 2.2	5S-FE	06/91 ⇒ 07/96
CARINA E 2.0	3S-FE	01/93 ⇒ 09/97
CARINA E 2.0 GLI	3S-FE	04/92 ⇒ 09/97
CARINA E 2.0 GTi	3S-GE	04/92 ⇒ 12/95
CARINA E 2.0 GTi 16V	3S-GE	03/94 ⇒ 09/97
CARINA E 2.0 i	3S-FE	12/92 ⇒ 09/97
CELICA V 2.2	5S-FE	10/89 ⇒ 12/94
COROLLA VIII 1.8 4WD	7A-FE	04/97 ⇒ 10/01
DYNA 200 2.7	3RZ-FE	06/95 ⇒ 07/01
FUNCRUISER 2.0 i 16V 4WD	3SFE	04/94 ⇒
MR 2 II 2.2 16V	5S-FE	01/90 ⇒ 06/95
HIACE IV 2.4	5YTD050W07	08/89 ⇒ 08/03
HIACE IV 2.4 4WD	5YTD050W07	08/89 ⇒ 08/95
CELICA VI 1.8 i 16V [USA] [CAN]	7A-FE	09/93 ⇒ 08/99
CELICA VI 2.2 GT	5S-FE	11/93 ⇒ 08/99
LAND CRUISER 90 2.7	3RZ-FE	06/95 ⇒ 08/02
PASEO 1.5	5E-FE	06/90 ⇒ 08/95
RAV 4 1.2.0	3S-FE	06/97 ⇒ 09/99
RAV 4 1.2.0 4WD	3S-FE	01/94 ⇒ 06/00
T100 2.7 i [USA]	3RZFE	10/93 ⇒ 07/98
TACOMA 2.4 i [USA]	2RZFE	01/95 ⇒
TERCEL 1.5 [USA]	3E	01/86 ⇒ 12/90
TERCEL 1.5 i [USA]	3EE	01/91 ⇒

EPS 1.970.199



05

COILS

Adatt./Suitable:

BOSCH
F 000 Z50 117
GENERAL MOTORS
94 404 545
94 853 695
HITACHI
138865
2508865
HOLDEN
9091902164
ISUZU
8-94404545-0
MAGNETI MARELLI
060717025012
TOYOTA
90919-02164

- 00 Eliminated on 02-08-2021. Please verify the availability through our local distributors**
- Eliminato il 02-08-2021. Verificare la disponibilità presso i nostri distributori
 - Éliminé le 02-08-2021. Vérifier la disponibilité auprès de nos distributeurs sur place
 - Am 02-08-2021 gestrichen. Evtl. Verfügbarkeit bitte bei unseren Händlern prüfen
 - Eliminado en fecha 02-08-2021. Verificar la disponibilidad a través de nuestros distribuidores locales



M4	M4	ohm	ohm
		1,32	12200

HOLDEN		
APOLLO 2.0	3S-FC	08/89 ⇒ 08/91
NOVA_LE 1.4 Hatchback	6AFC	07/89 ⇒ 07/91
NOVA_LE 1.6 Hatchback	4AFC	07/89 ⇒ 07/91
NOVA_LE 1.6 Sedan	4AFC	07/89 ⇒ 07/91
NOVA_LF 1.8i Hatchback	7AFE	08/91 ⇒ 03/93
NOVA_LF 1.8i Sedan	7AFE	08/91 ⇒ 03/93
NOVA_LG 1.6i Hatchback	4AFE	09/94 ⇒ 09/96
NOVA_LG 1.6i Sedan	4AFE	09/94 ⇒ 09/96
NOVA_LG 1.8i Hatchback	7AFE	09/94 ⇒ 09/96
NOVA_LG 1.8i Sedan	7AFE	09/94 ⇒ 09/96
TOYOTA		
CARINA II 1.6	4A-F	12/87 ⇒ 08/90
CARINA E 1.6	4A-FE	04/92 ⇒ 09/97
CARINA E 1.6 16V	4A-FE	12/94 ⇒ 09/97
CARINA E 1.6 GLI	4A-FE	04/92 ⇒ 09/97
CARINA E 1.6 i	4A-FE	02/95 ⇒ 09/97
CELICA IV 1.6	4A-L	04/86 ⇒ 08/89
COROLLA VI 1.3	2E	05/87 ⇒ 06/92
COROLLA VI 1.3 i	2E, 2E-E	08/87 ⇒ 06/92
COROLLA VI 1.6	4A-F	05/87 ⇒ 12/92
COROLLA VI 1.6 4WD	4A-F	08/87 ⇒ 08/89
COROLLA VI 1.6 GL 4WD	4A-F	10/87 ⇒ 08/90
COROLLA VI 1.6 XL	4A-F	09/89 ⇒ 04/92
COROLLA VII 1.3 12V	2E	07/92 ⇒ 04/97
COROLLA VII 1.3 XLI	4E-FE	07/92 ⇒ 04/97
COROLLA VII 1.3 XLI 16V	4E-FE	07/92 ⇒ 09/95
COROLLA VII 1.6 GLI	4A-FE	07/92 ⇒ 04/97
COROLLA VII 1.6 Si	4A-FE	07/92 ⇒ 04/97
COROLLA VII 1.8 16V 4WD	7A-FE	09/95 ⇒ 04/97
COROLLA VII 1.8 GT	7A-FE	11/92 ⇒ 05/95
COROLLA VIII 1.3	2E	05/97 ⇒ 10/01
COROLLA VIII 1.6	4A-FE	04/97 ⇒ 02/00
COROLLA VIII 1.6 Aut.	4A-FE	04/97 ⇒ 02/00
COROLLA VIII 1.8	7A-FE	10/97 ⇒ 10/01
COROLLA 1.6	4A-FE	05/97 ⇒ 09/99
HIACE 2.4 LPG	2RZE	08/95 ⇒ 06/99
HIACE IV 2.0	1RZ, 1RZ-E	08/89 ⇒ 08/04
HIACE IV 2.4	2RZ, 2RZE, 5YTD050W07	08/89 ⇒ 12/04
HIACE IV 2.4 4WD	2RZE	08/95 ⇒ 04/98
CELICA VI 1.8 i 16V	7A-FE	11/93 ⇒ 11/99
CELICA VI 1.8 i 16V [USA] [CAN]	7A-FE	09/93 ⇒ 08/99
PASEO 1.5	5E-FE	08/95 ⇒ 06/99
PASEO 1.5 Efi	5E-FE	01/97 ⇒ 12/99
STARLET 1.0	1E	12/89 ⇒ 12/92
STARLET 1.3	2E	01/96 ⇒ 07/99
STARLET 1.3 12V	2E, 2E-E	12/89 ⇒ 12/92
STARLET 1.3 12V Cat	2E-E	12/89 ⇒ 03/96
STARLET 1.3 XL	2E	12/89 ⇒ 12/91

EPS 1.970.201



05

COILS

Adatt./Suitable:

SUZUKI

33410-57B10
33410-57B10-000
33410-80C10
33410-80C10-000

00 Eliminated on 02-03-2020. Please verify the availability through our local distributors

- Eliminato il 02-03-2020. Verificare la disponibilità presso i nostri distributori
- Éliminé le 02-03-2020. Vérifier la disponibilité auprès de nos distributeurs sur place
- Am 02-03-2020 gestrichen. Evtl. Verfügbarkeit bitte bei unseren Händlern prüfen
- Eliminado en fecha 02-03-2020. Verificar la disponibilidad a través de nuestros distribuidores locales



	ohm		ohm
	0,98	Ø 8,4	12000

SUZUKI

SIDEKICK 1.6 JX 4x4	G16A(8V)	04/89 ⇨ 04/96
SIDEKICK 1.6i 16V JX 4x4	G16B	04/89 ⇨ 04/96
VITARA I 1.6	G16A(8V), G16B	07/88 ⇨ 03/98
VITARA I 1.6 i 16V	G16B	07/90 ⇨ 03/99
VITARA I 1.6 i 16V Trazione integrale	G16B	07/90 ⇨ 03/98
VITARA I 1.6 Trazione integrale	G16A(8V)	07/88 ⇨ 03/98

EPS 1.970.202



05

COILS

Adatt./Suitable:

DENSO

029700-6820

LEXUS

90919-02185

TOYOTA

90919-02185

03 Supplied until depletion

- Fornibile fino ad esaurimento delle scorte
- Fourni jusqu'à épuisement du stock
- Lieferbar solange vorrat reicht
- Suministrado hasta el stock termina



	ohm		ohm
	0,47	Ø 8,4	12000

LEXUS

ES 250 2VZ-FE 12/89 ⇨ 12/91

TOYOTA

4 RUNNER 3.0	3VZ-E	08/88 ⇨ 11/95
4 RUNNER 3.0 [USA]	3VZ-E	01/88 ⇨ 12/91
CAMRY 2.5	2VZ-FE	10/86 ⇨ 06/91
MR 2 II 2.0 16V	3S-GE	12/89 ⇨ 09/99
MR 2 II 2.0 Turbo	3S-GTE	12/89 ⇨ 07/99
HILUX V 3.0 4WD	3VZ-E	08/89 ⇨ 11/95
LAND CRUISER 80 4.0	3F-E	01/90 ⇨ 10/92
TRUCK 3.0	3VZ-E	08/88 ⇨ 11/95
TRUCK 3.0 i [USA]	3VZ-E	01/88 ⇨ 12/90

EPS 1.970.203



05

COILS

Adatt./Suitable:

BOSCH

F 00E 140 278

DENSO

029700-7050

029700-7051 *U

HITACHI

138868

2508868

LEXUS

90919-02197

90919-02208

MAGNETI MARELLI

060717123012

TOYOTA

19500-74040 *U

90919-02197

90919-02208

VW

J90 919 021 97

00 Supplied only the coil, not the mounting bracket, not the module

- Fornita solo la bobina, non la staffa di fissaggio, non il modulo
- Fourni seule la bobine, non pas le support de montage, et non pas le module
- nur die Spule geliefert wird, nicht die Montagehalterung, nicht das Modul
- Suministra sólo la bobina, no el soporte de montaje, no el módulo

03 Supplied until depletion

- Fornibile fino ad esaurimento delle scorte
- Fourni jusqu'à épuisement du stock
- Lieferbar solange vorrat reicht
- Suministrado hasta el stock termina



	ohm		ohm
	0,47	Ø 5	12000

LEXUS

GS 300	2JZ-GE	01/93 ⇨ 08/97
LS I 400	1UZ-FE	12/89 ⇨ 12/95
LS II 400	1UZ-FE	12/94 ⇨ 08/97
SC 400 4.0i	1UZFE	01/91 ⇨

TOYOTA

4 RUNNER 2.4	22RE	08/88 ⇨ 11/95
4 RUNNER 2.4 i [USA]	22RE	01/89 ⇨ 12/93
4 RUNNER 3.0	3VZ-E	08/88 ⇨ 11/95
4 RUNNER 3.0 [USA]	3VZ-E	01/88 ⇨ 12/91
CELICA V 2.0	3S-GE	09/89 ⇨ 01/94
CELICA V 2.0 4WD	3S-GTE	10/89 ⇨ 01/94
MR 2 II 2.0	3S-FE	12/89 ⇨ 08/92
MR 2 II 2.0 16V	3S-GE	12/89 ⇨ 09/99
MR 2 II 2.0 Turbo	3S-GTE	12/89 ⇨ 07/99
MR 2 II 2.2 16V	5S-FE	01/90 ⇨ 06/95
HILUX IV 2.4 4WD	22R	10/88 ⇨ 12/97
HILUX V 2.4 4WD	22R	10/88 ⇨ 08/97
HILUX V 2.4 i 4WD	22RE	01/89 ⇨ 07/97
HILUX V 3.0 4WD	3VZ-E	08/89 ⇨ 11/95
LITEACE 1.5	5K	01/92 ⇨ 01/95
SUPRA 3.0 i	2JZ-GE	05/93 ⇨ 07/02
T100 3.0 i [USA]	3VZE	08/92 ⇨ 08/94
TRUCK 2.4	22RE	08/88 ⇨ 11/95
TRUCK 2.4 i [USA]	22RE	01/92 ⇨
TRUCK 3.0	3VZ-E	08/88 ⇨ 11/95
TRUCK 3.0 i [USA]	3VZ-E	01/91 ⇨

VW

TARO 2.4 i 4x4 22R 06/89 ⇨ 03/97

EPS 1.970.211



05

COILS

Adatt./Suitable:

HONDA
30520-PH7-006
30520-PH7-016

ROVER
GCL145
GCL146

00 Eliminated on 23-02-2022. Please verify the availability through our local distributors

- Eliminato il 23-02-2022. Verificare la disponibilità presso i nostri distributori
- Éliminé le 23-02-2022. Vérifier la disponibilité auprès de nos distributeurs sur place
- Am 23-02-2022 gestrichen. Evtl. Verfügbarkeit bitte bei unseren Händlern prüfen
- Eliminado en fecha 23-02-2022. Verificar la disponibilidad a través de nuestros distribuidores locales



	ohm		ohm
	0,88		12000

HONDA		
LEGEND I 2.7 i 24V	C27A1	10/87 ⇒ 12/90
ROVER		
800 827 24V	C27A1	08/92 ⇒ 02/99
800 827 24V I/SI Cat	C27A1	01/92 ⇒ 02/99
800 827 SI/Sterling	82RZ-FE	02/88 ⇒ 12/91
800 827 SI/Sterling Catalytic-Conv	C27A1	02/88 ⇒ 02/99
800 827 Vitesse Catalytic-Conv	C27A1	10/88 ⇒ 12/91
800 827 Vitesse/SLI	82RZ-FE	10/88 ⇒ 12/91

EPS 1.970.212



05

COILS

Adatt./Suitable:

ACURA
30500-PE0-006

BOSCH
F 00E 140 011
F 00E 140 012

HONDA
30500-PE0-006
30500-PH1-026

00 Eliminated on 17-02-2020. Please verify the availability through our local distributors

- Eliminato il 17-02-2020. Verificare la disponibilità presso i nostri distributori
- Éliminé le 17-02-2020. Vérifier la disponibilité auprès de nos distributeurs sur place
- Am 17-02-2020 gestrichen. Evtl. Verfügbarkeit bitte bei unseren Händlern prüfen
- Eliminado en fecha 17-02-2020. Verificar la disponibilidad a través de nuestros distribuidores locales



	ohm		ohm
	1,38		13000

ACURA		
INTEGRA I 1.6	D16A1	01/85 ⇒ 12/90
INTEGRA I 1.6 i	D16A8	01/85 ⇒ 12/90
HONDA		
CIVIC III 1.3 [USA]	--	01/85 ⇒ 12/87
CIVIC III 1.5 i Si [USA]	--	01/84 ⇒ 12/87

EPS 1.970.213



05

COILS

Adatt./Suitable:

ACURA
30500-PM5-A02

HONDA
30500-PM5-A02
30500-PM5-A03

MAGNETI MARELLI
060717024012

ROVER
GCL161

03 Supplied until depletion

- Fornibile fino ad esaurimento delle scorte
- Fourni jusqu'à épuisement du stock
- Lieferbar solange vorrat reicht
- Suministrado hasta el stock termina



	ohm		ohm
	0,43		11500

ACURA		
INTEGRA I 1.6	D16A1	01/85 ⇒ 12/90
INTEGRA I 1.6 i	D16A8	01/85 ⇒ 12/90

HONDA		
CIVIC IV 1.5 i 16V	D15B2	10/87 ⇒ 09/91
CIVIC IV 1.6 16V 4x4	D16A6	11/87 ⇒ 09/91
CIVIC IV 1.6 i 16V	D16A6, D16A9	09/87 ⇒ 09/91
CIVIC IV 1.6 i 16V 4x4	D16A6	10/89 ⇒ 09/91
CIVIC IV 1.6 i 16V	D16A7, D16A8, D16A9	01/88 ⇒ 05/92
CIVIC IV 1.6 i 16V 4WD	D16A1, D16Z2	01/88 ⇒ 12/91
CIVIC IV SHUTTLE 1.5 i 16V	D15B2	01/88 ⇒ 11/91
CIVIC IV SHUTTLE 1.6 4x4	D16A, D16A7	01/88 ⇒ 12/92
CIVIC IV SHUTTLE 1.6 i 16V 4WD	D16A6	01/88 ⇒ 02/95
CIVIC IV SHUTTLE 1.6i	--	01/88 ⇒ 12/91
CONCERTO 1.6 16V	D16Z2	08/89 ⇒ 03/95
CONCERTO 1.6 i 16V	D16A8, D16Z2	08/89 ⇒ 03/95
CONCERTO 1.6i DOHC	--	01/90 ⇒ 12/91
CONCERTO 1.6i SOHC	--	01/90 ⇒ 12/91
CRX II 1.6 i 16V	D16A9, D16Z5	10/87 ⇒ 02/92

ROVER		
200 II 216	D16A8	10/92 ⇒ 06/99
200 II 216 1.6i	D16A8	01/92 ⇒ 11/99
200 II 216 GSi	1GH5E-180, D16A7	10/89 ⇒ 12/95
200 II 216 GTi	D16A8, D16A9	01/90 ⇒ 10/95
400 I 416 GSi	1GH5E-180	04/90 ⇒ 04/95
400 I 416 GSi/GSE	D16A7	04/90 ⇒ 04/95
400 I 416 GTI	D16A8	04/90 ⇒ 04/95
400 I 416 GTI/GTE	D16A9	04/90 ⇒ 04/95

EPS 1.970.214



05

COILS

Adatt./Suitable:

ACURA
30510-P73-A01
30510-PT2-006

BOSCH
F 000 Z50 116
F 00E 140 018

HITACHI
138812
2508812

HONDA
30510-P73-A01
30510-P73-A02
30510-PT2-006

MAGNETI MARELLI
060717022012

ROVER
GCL195
NEC100530

03 Supplied until depletion

- Fornibile fino ad esaurimento delle scorte
- Fourni jusqu'à épuisement du stock
- Lieferbar solange vorrat reicht
- Suministrado hasta el stock termina

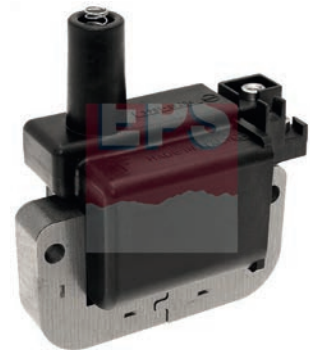

	ohm		ohm
	0,83		18000

ACURA		
INTEGRA II 1.8	F18A2	10/90 ⇒ 09/93
INTEGRA III 1.8 GS-R	F18C2	10/93 ⇒ 09/01
INTEGRA III 1.8 LS	F18C1	10/93 ⇒ 09/01
INTEGRA III 1.8 Sport	F18C1	10/93 ⇒ 09/01

HONDA		
ACCORD IV 2.0 16V	F20A5	01/90 ⇒ 12/93
ACCORD IV 2.0 i 16V	F20A4, F20A7, F20A8, F20Z3	01/90 ⇒ 12/93
ACCORD IV 2.2	F22A6	05/92 ⇒ 12/93
ACCORD IV 2.2 i 16V	F22A3, F22A7, F22A8	01/90 ⇒ 12/93
ACCORD IV 2.2 i 16V Automatic	F22A3	01/90 ⇒ 03/93
ACCORD V 1.8 16V	F18A3	01/94 ⇒ 12/95
ACCORD V 2.0	F20B3	09/93 ⇒ 12/97
ACCORD V 2.0 i	F20Z2	03/93 ⇒ 01/96
ACCORD V 2.0 i LS 16V	F20B3	09/93 ⇒ 02/98

1.970.215

HONDA		
ACCORD V 2.0 i S	F20Z1	03/93 ⇒ 01/96
ACCORD V 2.2 i 16V	F22B4	08/95 ⇒ 12/97
ACCORD V 2.2 i ES	F22B5	09/93 ⇒ 02/98
ACCORD V 2.3 i SR	H23A3	03/93 ⇒ 01/96
ACCORD VI 2.2 Type-R	H22A7	02/99 ⇒ 12/02
CIVIC V 1.5	D15B7	08/93 ⇒ 12/95
CIVIC V 1.5 i 16V	D15B2, D15Z1	10/91 ⇒ 11/95
CIVIC V 1.5 i LSi	D15B7	08/93 ⇒ 11/95
CIVIC V 1.6 16V Vtec	D16Z6, D16Z7	10/91 ⇒ 11/95
CIVIC V 1.6 4x4	D16Z7	01/92 ⇒ 10/95
CIVIC V 1.6 EX	D16A7	08/93 ⇒ 10/95
CIVIC V 1.6 i	D16Y7	01/94 ⇒ 11/95
CIVIC V 1.6 i Vtec	B16A2, D16Z9	01/94 ⇒ 03/96
CIVIC V 1.6 VTi	B16A2	10/91 ⇒ 11/95
CIVIC V 1.6 VTi 16V	B16A2	10/91 ⇒ 11/95
BALLADE 1.6i	B16A6	01/97 ⇒ 02/01
BALLADE 1.8 i	B18B4	01/96 ⇒ 02/01
CIVIC IV 1.6i	--	01/90 ⇒ 12/91
CIVIC VI 1.4 i	D14A2, D14A3, D14Z1, D14Z2, D14Z4	06/95 ⇒ 02/01
CIVIC VI 1.4 i S	D14A2, D14Z2, D14Z4	11/95 ⇒ 02/01
CIVIC VI 1.4i 16V	D14Z1	11/98 ⇒ 03/01
CIVIC VI 1.5	D15Z3	11/95 ⇒ 12/96
CIVIC VI 1.5 16V	D15Z6, D15Z8	01/97 ⇒ 02/01
CIVIC VI 1.5 i	D15Z6, D15Z8	11/95 ⇒ 02/01
CIVIC VI 1.5 i Vtec-E	D15Z3	09/94 ⇒ 01/97
CIVIC VI 1.6	--, D16Y2	10/95 ⇒ 03/01
CIVIC VI 1.6 16V	D16B2, D16W3	01/97 ⇒ 02/01
CIVIC VI 1.6 i	D16Y3	09/94 ⇒ 03/00
CIVIC VI 1.6 i Vtec	B16A2, D16Y2, D16Y8	09/94 ⇒ 02/01
CIVIC VI 1.6 VTi	B16A2	11/95 ⇒ 02/01
CIVIC VI 1.6i 16V	D16Y7	01/96 ⇒
CIVIC VI 1.6i 16V Vtec	D16Y8	01/96 ⇒ 09/99
CIVIC VI 1.8 16V	B18C4	01/97 ⇒ 02/01
CIVIC VI 1.8 i 16V VTi Vtec	D18C4	01/97 ⇒ 12/98
CR-V 1.2.0	B20Z1	04/99 ⇒ 02/02
CR-V 1.2.0 16V 4WD	B20B, B20B3, B20B9, B20Z1, B20Z3	10/95 ⇒ 02/02
CR-V 1.2.0 i 16V	B20B3, B20B4, B20B9, B20Z3	02/97 ⇒ 04/99
CRX III 1.6 Esi	D16Y8, D16Z6	03/92 ⇒ 12/98
CRX III 1.6 i VTi	B16A2	03/92 ⇒ 12/98
HR-V 1.6 16V	D16W1	03/99 ⇒
HR-V 1.6 16V 4WD	D16W1, D16W5	03/99 ⇒
HR-V 1.6i 16V	D16W2	04/99 ⇒
INTEGRA 1.8 i	B18B1, B18C3	01/98 ⇒
INTEGRA 1.8 Type-R	B18C6	11/97 ⇒ 10/01
LOGO 1.3	D13B7	03/99 ⇒ 03/02
PRELUDE IV 2.0 i 16V	F20A4	02/92 ⇒ 09/96
PRELUDE IV 2.2 i 16V Vtec	H22A2	02/93 ⇒ 09/96
PRELUDE IV 2.3 i 16V	H23A2	02/92 ⇒ 09/96
PRELUDE V 2.0 16V	F20A4	10/96 ⇒ 10/00
PRELUDE V 2.2 16V	H22A5, H22A8	10/96 ⇒ 10/00
PRELUDE V 2.2 i 16V	F22A2	10/96 ⇒ 10/01
PRELUDE V 2.2 i 16V VTi-R	H22A8	10/98 ⇒ 12/01
PRELUDE V 2.2 Si	F22Z6	03/97 ⇒ 07/02
SHUTTLE 2.2 16V	F22B8	10/94 ⇒ 02/98

ROVER		
400 II 416 Si	D16Y2, D16Y3, D16B2	03/95 ⇒ 03/00
600 618 i/Si	F18A3	03/96 ⇒ 02/99
600 620 i	F20Z2	08/93 ⇒ 06/96
600 620 Si	F20Z1	08/93 ⇒ 02/99
600 623 Si	H23A3	08/93 ⇒ 06/99

EPS 1.970.215



COILS

Adatt./Suitable:

ACURA
30500-PR4-A02
BOSCH
F 00E 140 015
HONDA
30500-PR4-A02
MAGNETI MARELLI
060717023012

03 Supplied until depletion

- Fornibile fino ad esaurimento delle scorte
- Fourni jusqu'à épuisement du stock
- Lieferbar solange vorrat reicht
- Suministrado hasta el stock termina



		ohm			ohm
M4	-	0,69		+	11500
M4					

ACURA

INTEGRA II 1.8 F18A2 10/90 ⇒ 09/93

HONDA

CIVIC IV 1.5	D15B1	01/88 ⇒ 12/89
CIVIC IV 1.5 i 16V	D15B2	10/87 ⇒ 09/91
CIVIC IV 1.6 i 16V	D16Z2	10/87 ⇒ 09/91
CIVIC IV 1.6 i 16V 4x4	D16Z2	01/89 ⇒ 12/91
CIVIC IV 1.6i	--	01/90 ⇒ 12/91
CIVIC IV 1.6i 16V	D16A1	01/88 ⇒ 12/91
CIVIC IV SHUTTLE 1.5 i 16V	D15B2	01/88 ⇒ 11/91
CIVIC IV SHUTTLE 1.6i	--	01/88 ⇒ 12/91
CIVIC IV SHUTTLE 1.6i 16V 4WD	D16Z2	01/88 ⇒ 12/92
CIVIC V 1.5	D15B2	01/92 ⇒ 12/92
CONCERTO 1.5 i	--	01/90 ⇒ 12/91
CONCERTO 1.5 i 16V	D15B2	08/89 ⇒ 05/95
CRX II 1.6 i 16V Vtec	B16A1	10/89 ⇒ 02/92

EPS 1.970.216



COILS

Adatt./Suitable:

HITACHI
CM1T-209B
CM1T-217
HONDA
30500-PO1-005
30500-PM3-005
30500-PM3-015
30500-PT0-005

00 Eliminated on 17-05-2021. Please verify the availability through our local distributors

- Eliminato il 17-05-2021. Verificare la disponibilità presso i nostri distributori
- Éliminé le 17-05-2021. Vérifier la disponibilité auprès de nos distributeurs sur place
- Am 17-05-2021 gestrichen. Evtl. Verfügbarkeit bitte bei unseren Händlern prüfen
- Eliminado en fecha 17-05-2021. Verificar la disponibilidad a través de nuestros distribuidores locales



		ohm			ohm
-	4.8	0,65		+	16000

HONDA

ACCORD IV 1.8	--	01/90 ⇒ 12/91
ACCORD IV 2.0 16V	F20A2, F20A3, F20A6	01/90 ⇒ 03/93
CIVIC V 1.3	D13B2	01/92 ⇒ 12/92
CIVIC V 1.3 16V	D13B2	10/91 ⇒ 11/95
CIVIC IV 1.2	D12B1	01/88 ⇒ 12/91
CIVIC IV 1.3	D13B1	10/87 ⇒ 12/89
CIVIC IV 1.3 [USA]	--	09/87 ⇒ 12/89
CIVIC IV 1.3 16V Cat	D13B2	09/89 ⇒ 09/91
CIVIC IV 1.4 L	D14A1	10/87 ⇒ 12/89
CIVIC IV 1.4i 16V	D14A1	01/90 ⇒ 12/91
CIVIC IV 1.6 16V 4x4	D16A6	11/87 ⇒ 09/91
CIVIC IV 1.6i 16V	D16A6	10/87 ⇒ 09/91
CIVIC IV 1.6i 16V 4x4	D16A6	10/89 ⇒ 09/91
CIVIC IV 1.6i 16V 4WD	D16A1, D16Z2	01/88 ⇒ 12/91
CIVIC IV SHUTTLE 1.4 i 16V	D14A1	01/88 ⇒ 12/92
CIVIC IV SHUTTLE 1.6 i 16V 4WD	D16A6	01/88 ⇒ 02/95
CONCERTO 1.4	D14A1	08/89 ⇒ 10/92
CONCERTO 1.6i	D16A	01/90 ⇒ 12/91



COILS

Adatt./Suitable:

BOSCH
F 005 X03 219
F 00E 140 476

DAEWOO
96320818 *U
96336522 *U

DENSO
DIC-0116

GENERAL MOTORS
94 136 766

HITACHI
CM1T-205

HOLDEN
2243342L00
2243342L10

HYUNDAI
AA100-18100B *1

ISUZU
8-94136766-0

KIA
AA100-18-100B *1

MAGNETI MARELLI
060717106012

NISSAN
22433-18R10
22433-42L10

OPEL
42 94 029

*1 Without fastening clamp

- Senza staffa di fissaggio
- sans bride de fixation
- ohne Befestigungsbügel
- sin estribo de sujeción

*U Supplied only the coil, not the mounting bracket, not the module

- Fornita solo la bobina, non la staffa di fissaggio, non il modulo
- Fourni seule la bobine, non pas le support de montage, et non pas le module
- nur die Spule geliefert wird, nicht die Montagehalterung, nicht das Modul
- Suministra sólo la bobina, no el soporte de montaje, no el módulo

*3 Supplied until depletion

- Fornibile fino ad esaurimento delle scorte
- Fourni jusqu'à épuisement du stock
- Lieferbar solange vorrat reicht
- Suministrado hasta el stock termina

*245 without fastening clamp

- senza staffa fissaggio
- sans bride de fixation
- ohne Befestigungsbügel
- sin estribo de sujeción



	ohm		ohm
	1,2		9300

CHEVROLET

SPARK I 0.8 F8CV 09/00 ⇨ 12/06

DAEWOO

MATIZ 0.8 F8CV 08/98 ⇨

HOLDEN

CALAIS 3.0 Executive -- 10/88 ⇨ 09/90

CALAIS_VL 2.0i 2.0PFI 01/86 ⇨ 07/88

CALAIS_VL 3.0i Turbo 3.0EFITURBO 01/86 ⇨ 07/88

COMMODORE 3.0 EFi 255263088 03/86 ⇨ 09/88

COMMODORE 3.0 EFi Turbo RB30ET 01/86 ⇨ 08/88

COMMODORE_VL 2.0i 2.0PFI 01/86 ⇨ 07/88

COMMODORE_VL 2.0i Wagon 2.0PFI 01/86 ⇨ 07/88

ISUZU

AMIGO 2.3i [USA] LW3 01/88 ⇨

PICK-UP 2.3i [USA] LW3 01/88 ⇨

TROOPER 2.3 4ZD1 11/85 ⇨ 12/91

KIA

TOWNER 0.8 Gasoline -- 10/97 ⇨

OPEL

MIDI 2.0 i 20PET 09/92 ⇨ 08/94

MIDI 2.0 i 4x4 20PET 09/92 ⇨ 08/94



COILS

Adatt./Suitable:

BOSCH
9 220 081 505

HITACHI
138735
2508735

MAGNETI MARELLI
060705409010
060717020012
607 054 09
BAE 504 L

RENAULT
77 00 749 450

*3 Supplied until depletion

- Fornibile fino ad esaurimento delle scorte
- Fourni jusqu'à épuisement du stock
- Lieferbar solange vorrat reicht
- Suministrado hasta el stock termina

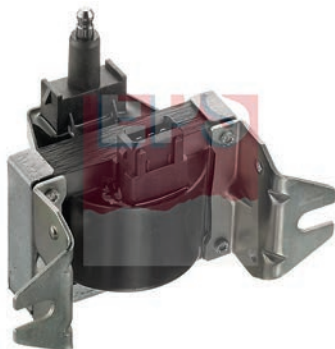

	ohm		ohm
	0,47		5000

RENAULT

19 II 1.8 8NA20S, F3P708 04/92 ⇨ 06/96

CLIO I 1.2 C3G720 06/94 ⇨ 02/98

EXPRESS 1.2 C3G710, C3G712 07/95 ⇨ 10/99

EXPRESS 1.4i C3G/C3J 01/85 ⇨ 10/90

RAPID 1.2 C3G710, C3G712 09/91 ⇨ 03/98

TWINGO I 1.2 C3G700, C3G702 03/93 ⇨ 10/96



COILS

Adatt./Suitable:

BOSCH
F 00E 140 248

FORD
F1CZ-12029-A

MAZDA
B6S7-18-10XA
B6S8-18-10XA

Motorcraft
DGE-447

*3 Supplied until depletion

- Fornibile fino ad esaurimento delle scorte
- Fourni jusqu'à épuisement du stock
- Lieferbar solange vorrat reicht
- Suministrado hasta el stock termina

*246 with fastening clamp

- con staffa fissaggio
- avec bride de fixation/boulon en U/étrier
- mit Befestigungsbügel
- con estribo de sujeción



	ohm		ohm
	1		14500

MAZDA

323 VI C 1.6 B6E 09/89 ⇨ 06/91

323 VI C 1.6 16V B6 03/91 ⇨ 10/94

323 VI F 1.6 B6E 09/89 ⇨ 06/91

323 VI F 1.6 16V B6 03/91 ⇨ 10/94

323 VI F 1.8 16V BP 08/89 ⇨ 07/94

323 VI F 1.8 16V GT BP(DOHC) 08/89 ⇨ 07/94

323 VI F 1.8i 16v GRSi BP31 06/89 ⇨ 03/91

323 VI S 1.3 16V B3(16V) 04/91 ⇨ 07/94

323 VI S 1.6 B6E 09/89 ⇨ 06/91

323 VI S 1.6 16V B6 08/89 ⇨ 10/96

323 VI S 1.8 16V BP52 08/89 ⇨ 07/94

323 VI S 1.8 16V 4WD BP52 09/91 ⇨ 07/94

323 VI S 1.8 16V Turbo 4WD BPTurbo 01/91 ⇨ 07/94

323 VI 1.3 16V B384, B386, B387 06/89 ⇨ 03/91

323 VI 1.8i 16v 4x4 BP51 06/89 ⇨ 03/91

323 VI 1.8i 16v GRSi BP22 06/89 ⇨ 03/91

323 VI 1.8i 16v GT Formula 4 BP55 04/91 ⇨ 04/94

323 VI 1.8i 16v GT-R BP5J 04/91 ⇨ 04/94

Formula 4

323 VI 1.8i 16v Turbo 4x4 BP55 06/89 ⇨ 03/91

MX-3 1.6 B69 05/91 ⇨ 10/93

PROTEGE 1.8i DOHC [USA] -- 01/90 ⇨

PROTEGE 1.8i OHC [USA] -- 01/90 ⇨

1.970.252

EPS 1.970.252



05

COILS

Adatt./Suitable:

DAIHATSU

90048-52072-000
90048-52095-000

00 Eliminated on 09-09-2019. Please verify the availability through our local distributors

- Eliminato il 09-09-2019. Verificare la disponibilità presso i nostri distributori
- Éliminé le 09-09-2019. Vérifier la disponibilité auprès de nos distributeurs sur place
- Am 09-09-2019 gestrichen. Evtl. Verfügbarkeit bitte bei unseren Händlern prüfen
- Eliminado en fecha 09-09-2019. Verificar la disponibilidad a través de nuestros distribuidores locales

240 with fastening clamp

- con staffa fissaggio
- avec bride de fixation/boulon en U/étrier
- mit Befestigungsbügel
- con estribo de sujeción



	ohm		ohm
	1,5		25500

DAIHATSU

CHARADE III 1.0i	G102	01/88 ⇒
CHARADE III 1.3	HC-C	09/88 ⇒ 02/93
CHARADE III 1.3 i	HC-E	06/88 ⇒ 12/92
CHARADE III 1.3 i 4WD	HC-E	06/88 ⇒ 01/93
HJET II 1.3 i 16V	HC-E	05/98 ⇒ 10/05

EPS 1.970.265



05

COILS

Adatt./Suitable:

HITACHI

CM12-100

SUBARU

22433-AA230
22433-AA360

	ohm		ohm
	0,78		14000

SUBARU

IMPREZA I 1.6	EJ16E	01/93 ⇒ 12/00
IMPREZA I 1.6 i	8F140GA	08/92 ⇒ 12/00

SUBARU

IMPREZA I 1.6 i AWD	8F140GA	08/92 ⇒ 12/00
IMPREZA I 1.8	EJ18	01/93 ⇒ 10/95
IMPREZA I 1.8 i	EJ18E	11/95 ⇒ 06/96
IMPREZA I 2.0 i AWD	EJ18, EJ18E	08/92 ⇒ 12/00
LEGACY I 2.0	EJ20E	08/91 ⇒ 12/93
LEGACY I 2.0i 16V	EJ20E	08/91 ⇒ 12/93
LEGACY I 2.2i	--	01/90 ⇒
LEGACY I 2.2i [USA]	--	01/90 ⇒
LEGACY I 2.2i 16v	EJ22E	08/89 ⇒ 10/91
LEGACY I 2.2i Turbo [USA]	--	01/90 ⇒
LEGACY I 2000	EJ20EMPI	09/91 ⇒ 12/93
LEGACY I 2000 4WD	EJ20EMPI	08/91 ⇒ 07/94
LEGACY I 2200 4WD	EJ22EMPI	01/89 ⇒ 07/94
LEGACY I 2200 Super 4WD	EJ22EMPI	01/89 ⇒ 07/94
LEGACY II 1.8 4WD	EJ18E	05/96 ⇒ 09/98

EPS 1.970.266



05

COILS

Adatt./Suitable:

HITACHI

138737
2508737

SUBARU

22433-AA240
22433-AA370

	ohm		ohm
	0,78		20000

SUBARU

IMPREZA I 2.0	EJ20E	09/96 ⇒ 08/98
IMPREZA I 2.0 AWD	EJ20E	12/95 ⇒ 12/00
IMPREZA I 2.0 i	EJ20E	11/95 ⇒ 09/00
IMPREZA I 2.0 i AWD	EJ20	10/95 ⇒ 12/00
IMPREZA I 2.0 i Turbo AWD	EJ20(Turbo)	03/94 ⇒ 12/00
IMPREZA I 2.0 Turbo AWD	EJ20G	12/96 ⇒ 12/00
IMPREZA I 2.0 Turbo GT AWD	EJ20(Turbo)	03/94 ⇒ 12/00
IMPREZA I 2.2 i	EJ22E	11/93 ⇒ 08/98
LEGACY II 2.0 i	EJ20EMPI	09/94 ⇒ 03/99
LEGACY II 2.0 i 4WD	EJ201, EJ20E	09/94 ⇒ 03/99
LEGACY II 2.2	2LF479Q3	07/94 ⇒ 11/98
LEGACY II 2.2 i 4WD	EJ22EMPI	02/94 ⇒ 03/99
LEGACY II 2.5	EJ25D	01/96 ⇒ 12/99
LEGACY II 2.5 i 4WD	EJ25D	06/96 ⇒ 03/99
LEGACY I 2.2i	--	01/90 ⇒
LEGACY I 2.2i [USA]	--	01/90 ⇒
LEGACY I 2.2i Turbo [USA]	--	01/90 ⇒

	ohm		ohm
	0,47		8500

VW

CORRADO 2.9 VR6	ABV	08/91 ⇒ 12/95
GOLF III 2.8 VR6	AAA	01/92 ⇒ 09/97
PASSAT III 2.8 VR6	AAA	06/91 ⇒ 05/97
VENTO 2.8 VR6	AAA	01/92 ⇒ 09/98

COILS

Adatt./Suitable:

BOSCH

1 227 030 051
1 227 030 052

MAGNETI MARELLI

060717006012

VW

357 905 105

03 Supplied until depletion

- Fornibile fino ad esaurimento delle scorte
- Fourni jusqu'à épuisement du stock
- Lieferbar solange vorrat reicht
- Suministrado hasta el stock termina



EPS 1.970.272



07

COILS

Adatt./Suitable:

BOSCH

0 221 503 700
0 986 221 093

DUCELLIER

2 526 055 A

GENERAL MOTORS

90 458 250

HITACHI

138762
2508762

HOLDEN

90458250

MAGNETI MARELLI

060717044012

OPEL

12 08 071
90458250

SAGEM

2 526 055 A

SIEMENS

5WK 90611

VAUXHALL

90458250

03 Supplied until depletion

- Fornibile fino ad esaurimento delle scorte
- Fourni jusqu'à épuisement du stock
- Lieferbar solange vorrat reicht
- Suministrado hasta el stock termina



	ohm		ohm
	0,7	∅ 4	9000

HOLDEN

ASTRA TR 1.8i 16v Hatchback	C18SEL	09/96 ⇒ 09/98
ASTRA TR 1.8i 16v Sedan	C18SEL	09/96 ⇒ 09/98
ASTRA TR 2.0i 16v Hatchback	X20XEV	09/96 ⇒ 09/98
CALIBRA YE 2.0i 16V	X20XEV	08/95 ⇒ 10/97

OPEL

ASTRA F 1.8	Z18XEL	02/03 ⇒ 07/04
ASTRA F 1.8i 16V	C18SEL, C18XE, C18XEL, X18XE	06/93 ⇒ 03/01
ASTRA F 2.0i 16V	X20XER, X20XEV	02/95 ⇒ 08/00
ASTRA G 2.0 16V	X20XEV	02/98 ⇒ 01/05
ASTRA G 2.0 16V OPC	X20XER	11/99 ⇒ 09/02
CALIBRA A 2.0i 16V	X20XEV	02/94 ⇒ 07/97
CALIBRA A 2.0i 16V 4x4	X20XEV	02/94 ⇒ 07/97
OMEGA B 2.0 16V	X20XEV	03/94 ⇒ 09/99
VECTRA 2.0	C20SEL	10/95 ⇒ 04/02
VECTRA A 2.0i 16V	X20XEV	08/92 ⇒ 08/95
VECTRA A 2.0i 16V 4x4	X20XEV	06/94 ⇒ 11/95
VECTRA B 1.8 FlexFuel	X18XE	01/99 ⇒ 09/00
VECTRA B 1.8i 16V	X18XE	10/95 ⇒ 09/00
VECTRA B 2.0i 16V	C20SEL, X20XEV	09/95 ⇒ 07/03
VECTRA B 2.2i 16V	C22SEL	07/00 ⇒ 07/02

VAUXHALL

ASTRA III 1.8	C18XE	09/94 ⇒ 08/96
ASTRA III 1.8 16V	C18XEL, X18XE	11/94 ⇒ 03/01
ASTRA III 1.8i 16V	C18XE, C18XEL, X18XE	06/93 ⇒ 02/98
ASTRA III 2.0i 16V	X20XEV	01/94 ⇒ 09/98
ASTRA IV 2.0	X20XER	10/99 ⇒ 08/00
ASTRA IV 2.0 16V	X20XEV	02/98 ⇒ 05/05
CALIBRA 2.0i 16V	X20XEV	06/90 ⇒ 07/97
CALIBRA 2.0i 16V 4x4	X20XEV	02/94 ⇒ 07/97
OMEGA B 2.0 16V	X20XEV	03/94 ⇒ 07/01
VECTRA B 1.8i 16V	X18XE	09/95 ⇒ 09/00
VECTRA B 2.0 Dualfuel	X20XEV	05/98 ⇒ 01/01
VECTRA B 2.0i 16V	X20XEV	10/95 ⇒ 01/01

EPS 1.970.273



07

COILS

Adatt./Suitable:

BOSCH

0 221 503 001

GENERAL MOTORS

90 443 900

HITACHI

138790
2508790

HOLDEN

90443900

MAGNETI MARELLI

060717066012

OPEL

12 08 065
90443900
90449572

00 Eliminated on 23-02-2022. Please verify the availability through our local distributors

- Eliminato il 23-02-2022. Verificare la disponibilità presso i nostri distributori
- Éliminé le 23-02-2022. Vérifier la disponibilité auprès de nos distributeurs sur place
- Am 23-02-2022 gestrichen. Evtl. Verfügbarkeit bitte bei unseren Händlern prüfen
- Eliminado en fecha 23-02-2022. Verificar la disponibilidad a través de nuestros distribuidores locales



	ohm		ohm
	0,5	∅ 4	13000

HOLDEN

CALIBRA YE 2.0i 16V	C20XE	09/91 ⇒ 07/95
FRONTERA UT 2.0i	X20SE	10/95 ⇒ 03/99

OPEL

ASTRA F 2.0 GSI 16V	C20XE	09/91 ⇒ 01/98
ASTRA F 2.0i 16V	C20XE	03/93 ⇒ 01/98
CALIBRA A 2.0i 16V	C20XE	06/90 ⇒ 02/94
CALIBRA A 2.0i 16V 4x4	C20XE	06/90 ⇒ 02/94
FRONTERA A 2.0i	X20SE	03/92 ⇒ 10/98
FRONTERA A 2.2i	X22XE	03/95 ⇒ 10/98
OMEGA B 2.0	X20SE	03/94 ⇒ 09/99
VECTRA B 2.0i	Z0NEJ	10/95 ⇒ 04/02

VAUXHALL

ASTRA III 2.0i 16V	C20XE	09/91 ⇒ 02/98
CALIBRA 2.0i 16V	C20XE	06/90 ⇒ 02/94
CALIBRA 2.0i 16V 4x4	C20XE	06/90 ⇒ 02/94
FRONTERA A 2.0	X20SE	04/95 ⇒ 08/98
FRONTERA A 2.0i	X20SE	03/92 ⇒ 10/98
FRONTERA A 2.2i	X22XE	03/95 ⇒ 10/98
OMEGA B 2.0	X20SE	03/94 ⇒ 09/99
VECTRA B 2.0i	Z0NEJ	10/95 ⇒ 03/02

COILS

Adatt./Suitable:

BOSCH

0 986 221 089

HITACHI

138736
2508736

MAGNETI MARELLI

060717070012
607 081 38
BAE 801 AK

RENAULT

77 00 854 306
77 00 872 265

	ohm		ohm
	0,73	∅ 6.3	8000

RENAULT

Z1 2.0 Turbo	J7R756	02/90 ⇒ 10/92
Z1 2.0 Turbo 4x4	J7R756	02/90 ⇒ 10/92
ESPACE III 2.0	F3R728, F3R729, F3R768, F3R769	11/96 ⇒ 10/00
ESPACE III 3.0	Z7X775	11/96 ⇒ 10/98
LAGUNA I 1.8	F3P670, F3P674, F3P676, F3P678	06/95 ⇒ 03/01
LAGUNA I 2.0	..., F3R611, F3R728, F3R729, F3R768	11/93 ⇒ 03/01
LAGUNA I 3.0	Z7X760, Z7X765, Z7X767	11/93 ⇒ 03/01
MEGANE I 2.0	F3R262, F3R264, F3R750, F3R751, F3R752, F3R796, F3R797, F3R798	01/97 ⇒ 08/03
MEGANE I 2.0i	F3R750, F3R751, F3R752, F3R791, F3R796, F3R797, F3R798	01/96 ⇒ 08/03
MEGANE I 2.0 RT	F3R752	10/96 ⇒ 02/99
MEGANE SCÉNIC I 2.0 RXE 4x4	F3R750	05/97 ⇒ 10/99
SCÉNIC I 2.0	F3R791, F3R797, F3R798	09/99 ⇒ 08/03

EPS 1.970.276



05

COILS

Adatt./Suitable:

MAGNETI MARELLI607 081 54
BAE 801 BK**RENAULT**77 00 854 307
77 00 872 692**00 Eliminated on 22-02-2021. Please verify the availability through our local distributors**

- Eliminato il 22-02-2021. Verificare la disponibilità presso i nostri distributori
- Éliminé le 22-02-2021. Vérifier la disponibilité auprès de nos distributeurs sur place
- Am 22-02-2021 gestrichen. Evtl. Verfügbarkeit bitte bei unseren Händlern prüfen
- Eliminado en fecha 22-02-2021. Verificar la disponibilidad a través de nuestros distribuidores locales



	ohm		ohm
	0,73	Ø 6,3	8000

RENAULT

21 2.0 Turbo	J7R756	02/90 ⇒ 10/92
21 2.0 Turbo 4x4	J7R756	02/90 ⇒ 10/92
ESPACE III 3.0	Z7X775	11/96 ⇒ 10/98
LAGUNA I 3.0	Z7X760, Z7X765, Z7X767	11/93 ⇒ 03/01

EPS 1.970.285



07

COILS

Adatt./Suitable:

00 Eliminated on 09-09-2019. Please verify the availability through our local distributors

- Eliminato il 09-09-2019. Verificare la disponibilità presso i nostri distributori
- Éliminé le 09-09-2019. Vérifier la disponibilité auprès de nos distributeurs sur place
- Am 09-09-2019 gestrichen. Evtl. Verfügbarkeit bitte bei unseren Händlern prüfen
- Eliminado en fecha 09-09-2019. Verificar la disponibilidad a través de nuestros distribuidores locales



	ohm		ohm
	0,5	Ø 5	12500

EPS 1.970.285S



05

COILS

Adatt./Suitable:

BOSCH

F 000 Z50 117

DENSO

029700-7700

TOYOTA

19070-74170

19080-66010

19500-74090

19500-74091

19500-74100

19500-74120

90919-02209

***U Supplied only the coil, not the mounting bracket, not the module**

- Fornita solo la bobina, non la staffa di fissaggio, non il modulo
- Fourni seule la bobine, non pas le support de montage, et non pas le module
- nur die Spule geliefert wird, nicht die Montagehalterung, nicht das Modul
- Suministra sólo la bobina, no el soporte de montaje, no el módulo



	ohm		ohm
	0,5	Ø 5	12500

TOYOTA

CARINA E 1.6	4A-FE	04/92 ⇒ 09/97
CARINA E 1.6 16V	4A-FE	12/94 ⇒ 09/97
CARINA E 1.6 GLI	4A-FE	04/92 ⇒ 09/97
CARINA E 1.6 i	4A-FE	02/95 ⇒ 09/97
CELICA V 2.2	5S-FE	10/89 ⇒ 12/94
CELICA VI 2.0 GTi	3S-GE	08/94 ⇒ 08/99
CELICA VI 2.0 i 16V	3S-GE	11/93 ⇒ 11/99
CELICA VI 2.0 i Turbo 4WD	3S-GTE	02/94 ⇒ 11/99
CELICA VI 2.2 GT	5S-FE	11/93 ⇒ 08/99
FUNCRUISER 2.0 i 16V 4WD	3SFE	04/94 ⇒
LAND CRUISER 80 4.5	1FZ-FE	08/92 ⇒ 01/98
LAND CRUISER 80 4.5 24V	1FZ-FE	08/92 ⇒ 12/97
RAV 4 I 2.0	3S-FE	06/97 ⇒ 09/99
RAV 4 I 2.0 4WD	3S-FE	01/94 ⇒ 06/00

EPS 1.970.289



07,5

COILS

Adatt./Suitable:

BOSCH

F 005 X11 773

DENSO

029700-6770

029700-6780

029700-7531

FORD

6 383 157

90TF-12029A-1A

E9DF-12029-AA

E9DZ-12029-A

F0TZ-12029-A

F57U-12029-AA

F57Z-12029-A

F82U-12029-AA

FORD USA

6 383 157

F0TZ-12029-A

MAGNETI MARELLI

060717047012

MAZDA

KLG4-18-100A

ZZL0-18-100

ZZM7-18-100

Motorcraft

DG 438

DG 459

DGE-446

00 Eliminated on 23-02-2022. Please verify the availability through our local distributors

- Eliminato il 23-02-2022. Verificare la disponibilità presso i nostri distributori
- Éliminé le 23-02-2022. Vérifier la disponibilité auprès de nos distributeurs sur place
- Am 23-02-2022 gestrichen. Evtl. Verfügbarkeit bitte bei unseren Händlern prüfen
- Eliminado en fecha 23-02-2022. Verificar la disponibilidad a través de nuestros distribuidores locales



	ohm		ohm
	0,5	Ø 7	13000

FORD

ENDEAVOUR 4.0 EFI V6	--	11/03 ⇒
EVEREST 4.0 EFI V6	--	11/03 ⇒
RANGER IV 4.0	--	10/05 ⇒ 06/06
RANGER IV 4.0 4x4	--	10/05 ⇒ 06/06

FORD USA

EXPLORER 4.0 V6 4WD	--	01/93 ⇒ 12/01
MUSTANG 4.0 V6	--	12/04 ⇒ 12/10

MAZDA

NAVAJO 4.0i [USA]	--	01/91 ⇒
-------------------	----	---------

EPS 1.970.296



05

COILS

Adatt./Suitable:

BOSCH

F 00E 140 024

NISSAN



22433-1E400

22448-1E400

⁰³ Supplied until depletion

- Fornibile fino ad esaurimento delle scorte
- Fourni jusqu'à épuisement du stock
- Lieferbar solange vorrat reicht
- Suministrado hasta el stock termina



	ohm		ohm
	1	Ø 8,2	14500

NISSAN

ALTIMA 2.4	KA24DE	06/93 ⇨ 09/01
STANZA 2.4i [USA]	KA24DE	01/92 ⇨

EPS 1.970.299



08

COILS

Adatt./Suitable:

BOSCH

F 000 Z50 212

FORD

6 823 318

6 860 288

MAGNETI MARELLI

060717036012

MAZDA

1E05-18-100

1E05-18-100A



⁰⁰ Eliminated on 23-02-2022. Please verify the availability through our local distributors

- Eliminato il 23-02-2022. Verificare la disponibilità presso i nostri distributori
- Éliminé le 23-02-2022. Vérifier la disponibilité auprès de nos distributeurs sur place
- Am 23-02-2022 gestrichen. Evtl. Verfügbarkeit bitte bei unseren Händlern prüfen
- Eliminado en fecha 23-02-2022. Verificar la disponibilidad a través de nuestros distribuidores locales

²⁴⁰ with fastening clamp

- con staffa fissaggio
- avec bride de fixation/boulon en U/étrier
- mit Befestigungsbügel
- con estribo de sujeción



	ohm		ohm
	0,5	Ø 7	13000

FORD

ESCORT V 1.6 16V XR3i	L1E	12/92 ⇨ 01/95
ESCORT V 1.6 i 16V	L1E, L1H, L1K	09/92 ⇨ 01/95
ESCORT V 1.8 16V	RDA	02/92 ⇨ 01/95
ESCORT V 1.8 16V XR3i	99BFR1740, RDA	02/92 ⇨ 01/95
ESCORT V 1.8 i 16V	99BFR1740	09/92 ⇨ 01/95
ESCORT V 1.8 XR3i 16V 4x4	99BFR1740, RDA	08/93 ⇨ 01/95
FIESTA III 1.6 i 16V	L1G	01/94 ⇨ 12/95
FIESTA III 1.8 16V	RDB	02/92 ⇨ 12/95
FIESTA III 1.8 XR2i 16V	RQC	02/92 ⇨ 12/95
MONDEO I 1.6 i 16V	L1F, L1J	02/93 ⇨ 08/96
MONDEO I 1.8 4x4	RKA	02/93 ⇨ 08/96
MONDEO I 1.8 i 16V	RKA, RKB	02/93 ⇨ 08/96
MONDEO I 1.8 i 16V 4x4	RKA	02/93 ⇨ 08/96
MONDEO I 2.0 i 16V	NGA	01/93 ⇨ 08/96
MONDEO I 2.0 i 16V 4x4	NGA	02/93 ⇨ 08/96
ORION II 1.6 i 16V	L1E, L1K	07/92 ⇨ 12/93
ORION II 1.8 i 16V	99BFR1740, RDA	01/92 ⇨ 12/93

MAZDA

121 III 1.25	1E05, DHF, DHG	03/96 ⇨ 04/03
--------------	----------------	---------------

EPS 1.970.299S



07

COILS

Adatt./Suitable:

BOSCH

F 000 Z50 212

FORD

5 008 193

6 860 289

928F-12029-CB

938F-12024-DA

F5RZ-12029-C

FORD AUSTRALIA

938F-12024-DA

MAZDA

1E06-18-100

Motorcraft

DG 458



⁰⁰ Eliminated on 23-02-2022. Please verify the availability through our local distributors

- Eliminato il 23-02-2022. Verificare la disponibilità presso i nostri distributori
- Éliminé le 23-02-2022. Vérifier la disponibilité auprès de nos distributeurs sur place
- Am 23-02-2022 gestrichen. Evtl. Verfügbarkeit bitte bei unseren Händlern prüfen
- Eliminado en fecha 23-02-2022. Verificar la disponibilidad a través de nuestros distribuidores locales

²⁴⁵ without fastening clamp

- senza staffa fissaggio
- sans bride de fixation
- ohne Befestigungsbügel
- sin estribo de sujeción



	ohm		ohm
	0,5	Ø 7	13000

FORD

FIESTA IV 1.25 i 16V	DHA, DHB, DHC, DHD, DHE, DHF, DHG	08/95 ⇨ 01/02
FIESTA 1.2	DHA, DHB, DHC, DHD, DHF, DHG	01/96 ⇨ 04/02
PUMA 1.4 16V	FHD, FHF	11/97 ⇨ 10/00
PUMA 1.7 16V	MHA, MHB	03/97 ⇨ 06/02
PUMA Racing ST 160	MHA	06/99 ⇨ 06/02

EPS 1.970.312



07

COILS

Adatt./Suitable:

FORD

F1VU-12029A-1A
F1VY-12029-A
F50U-12029-AA
F50U-12029-BA
F50Y-12029-A
F50Y-12029-B

MAGNETI MARELLI

060801006010
BAE 680 D

Motorcraft

DG 449
DG 460
DG 461

00 Eliminated on 22-02-2021. Please verify the availability through our local distributors

• Eliminato il 22-02-2021. Verificare la disponibilità presso i nostri distributori

• Éliminé le 22-02-2021. Vérifier la disponibilité auprès de nos distributeurs sur place

• Am 22-02-2021 gestrichen. Evtl. Verfügbarkeit bitte bei unseren Händlern prüfen

• Eliminado en fecha 22-02-2021. Verificar la disponibilidad a través de nuestros distribuidores locales

1187 Without ignition firing nrs., it can be used in the place of:

• Senza numeri dell'ordine d'accensione, può sostituire:

• Sans nos. de sequence d'allumage, peut être utilisé au lieu:

• Ohne Zündfolge-Nr. verwendbar als Ersatz von:
• Sin nos. de secuencia de ignición puede utilizarse en lugar:

1.970.135



	ohm		ohm
	0,5	Ø 7	13000

FORD

ESCORT III 1.4 i	F6B, F6D, FUC	02/86 ⇒ 07/90
ORION I 1.4	FUA	12/85 ⇒ 07/90
ORION II 1.3	J4B, J6A	07/90 ⇒ 12/93
ORION II 1.4	F6F, F6G, FUH	07/90 ⇒ 12/93
ORION II 1.6	LUJ, LUK	07/90 ⇒ 12/92
ORION II 1.6 i	LJF	07/90 ⇒ 09/92
ORION II 1.6 i 16V	L1E, L1K	07/92 ⇒ 12/93
ORION II 1.8 i 16V	99BFR1740, RDA	01/92 ⇒ 12/93
SIERRA II 1.6 i	L6B	10/89 ⇒ 02/93
SIERRA II 1.8	R2C, R6A	05/88 ⇒ 02/93

MAZDA

121 III 1.25	DHF, DHG	03/96 ⇒ 04/03
626 VI 2.0	FS	05/97 ⇒ 10/02

EPS 1.970.313



07

COILS

Adatt./Suitable:

ALFA ROMEO

60562701
60810690

BOSCH

0 221 504 456

FIAT

60562701
60810690

IVECO

8024220

LANCIA

60562701
60810690

00 Eliminated on 09-04-2019. Please verify the availability through our local distributors

• Eliminato il 09-04-2019. Verificare la disponibilità presso i nostri distributori

• Éliminé le 09-04-2019. Vérifier la disponibilité auprès de nos distributeurs sur place

• Am 09-04-2019 gestrichen. Evtl. Verfügbarkeit bitte bei unseren Händlern prüfen

• Eliminado en fecha 09-04-2019. Verificar la disponibilidad a través de nuestros distribuidores locales



	ohm		ohm	
	0,52		...	

EPS 1.970.314



07,5

COILS

Adatt./Suitable:

BOSCH

0 221 504 006

FIAT

46403328

HITACHI

133865
2503865

LANCIA

46403328

MAGNETI MARELLI

060810245010

03 Supplied until depletion

• Fornibile fino ad esaurimento delle scorte

• Fourni jusqu'à épuisement du stock

• Lieferbar solange vorrat reicht

• Suministrado hasta el stock termina



	ohm		ohm	
	0,45		...	

FIAT

BRAVO I 2.0 HGT 20V	182A1.000	10/95 ⇒ 07/98
COUPE 2.0 20V	182A1.000	08/96 ⇒ 09/98
COUPE 2.0 20V Turbo	175A3.000	08/96 ⇒ 08/00
MAREA 2.0 150 20V	182A1.000	09/96 ⇒ 04/99
MAREA 2.0i 20v [BRA]	182A1.011	10/96 ⇒ 04/99

FIAT (BR)

MAREA 2.0i 20v	2.0Mpi	01/99 ⇒ 12/00
----------------	--------	---------------

LANCIA

KAPPA 2.0 20V	838A1.000, 838A6.000	10/94 ⇒ 10/01
KAPPA 2.0 20V Turbo	175A3.000	06/98 ⇒ 10/01
KAPPA 2.4 20V	838A2.000, 838A2.027	08/94 ⇒ 10/01

FORD

FIESTA III 1.1	G6A, GUD, GUE	03/89 ⇒ 12/95
FIESTA III 1.3	J6B	03/89 ⇒ 02/96
FIESTA III 1.3 Cat	J6B	05/91 ⇒ 01/97
FIESTA III 1.4	F6E, FUG, FUJ	03/89 ⇒ 12/95
FIESTA III 1.4 Cat	F4A	03/89 ⇒ 12/95
FIESTA III 1.6	LUH	01/89 ⇒ 01/94
FIESTA III 1.6 i 16V	L1G	01/94 ⇒ 12/95
FIESTA III 1.6 Turbo	LHA	03/90 ⇒ 10/92
FIESTA III 1.6 XR2i	LJC, LJD	03/89 ⇒ 01/94
FIESTA III 1.8 16V	RDB	02/92 ⇒ 12/95
FIESTA III 1.8 XR2i 16V	RQC	02/92 ⇒ 12/95
ESCORT IV 1.3	JBA	07/88 ⇒ 12/94
ESCORT IV 1.4	F6B, F6D, F6F, F6G, FUA, FUC	01/86 ⇒ 12/94
ESCORT IV 1.6	LUG	04/89 ⇒ 07/90
ESCORT IV 1.6 i	L4B	01/86 ⇒ 07/90
ESCORT IV 1.6 Turbo RS	LNB	01/86 ⇒ 07/90
ESCORT IV 1.6 XR3i	LR2, LRB	01/86 ⇒ 07/90
ESCORT V 1.3	J4B, J6A	07/90 ⇒ 01/95
ESCORT V 1.4	F4B, F6F, F6G, FUH	07/90 ⇒ 01/95
ESCORT V 1.4 i	F4B	07/93 ⇒ 01/95
ESCORT V 1.6	LJF, LUJ, LUK	07/90 ⇒ 08/93
ESCORT V 1.6 16V XR3i	L1E	12/92 ⇒ 01/95
ESCORT V 1.6 i 16V	L1E, L1H, L1K	09/92 ⇒ 01/95
ESCORT V 1.8 16V XR3i	99BFR1740	09/92 ⇒ 01/95
ESCORT V 1.8 i 16V	99BFR1740	09/92 ⇒ 01/95
ESCORT V 1.8 XR3i 16V 4x4	99BFR1740	08/93 ⇒ 01/95
ESCORT VI 1.3	J6A	01/95 ⇒ 02/99
ESCORT VI 1.4	F4B	01/95 ⇒ 02/99
FIESTA II 1.4	F6A, F6C	10/86 ⇒ 02/89
FIESTA IV 1.3 i	JBC	08/95 ⇒ 01/02
MONDEO I 1.6 i 16V	L1F, L1J	02/93 ⇒ 08/96
MONDEO I 1.8 i 16V	RKA, RKB	02/93 ⇒ 08/96
MONDEO I 1.8 i 16V 4x4	RKA	02/93 ⇒ 08/96
MONDEO I 2.0 i 16V	NGA	02/93 ⇒ 08/96
MONDEO I 2.0 i 16V 4x4	NGA	04/93 ⇒ 08/96
ESCORT III 1.3	JBA	07/88 ⇒ 07/90

ALFA ROMEO

147 3.2 GTA	932A.000	02/03 ⇒ 03/10
156 2.5 V6 24V	AR32401, AR32405	02/97 ⇒ 05/06
156 2.5 V6 24V [BRA]	AR32402	10/97 ⇒ 12/01
156 3.2 GTA	932A.000	03/02 ⇒ 05/06
164 3.0	AR64304	04/93 ⇒ 02/95
164 3.0 24V	AR66301, AR66302	09/92 ⇒ 09/98
164 3.0 24V Q4	AR64307, AR64308, AR66304	09/92 ⇒ 10/98
164 3.0 24V QV	AR64304	09/92 ⇒ 09/98
164 3.0 24V QV [USA]	AR64308	04/93 ⇒ 02/95
164 3.0 24V QV Trazione integrale	AR64307	11/92 ⇒ 10/97
164 3.0i 24V Super [BRA]	64306	09/92 ⇒ 10/98
164 3.0i 24V Super Q4	AR66304	03/95 ⇒ 12/98
166 2.5 V6 24V	AR34201, AR36201	10/00 ⇒ 06/07
166 3.0 V6 24V	AR34301, AR36101	10/00 ⇒ 06/07
166 3.0 V6 24V [BRA]	AR34302	08/98 ⇒ 09/00
166 3.2 V6 24V	936A.000	10/03 ⇒ 06/07
GT 3.2 GTA	936A.000	11/03 ⇒ 09/10
GTV 3.0 V6 24V	AR16102, AR16105	10/00 ⇒ 10/05
GTV 3.2 V6 24V	936A6.000	04/03 ⇒ 10/05
SPIDER II 3.0 V6	AR16105	09/94 ⇒ 04/05
SPIDER II 3.0 V6 24V	AR16102	01/99 ⇒ 10/03
SPIDER II 3.2 V6 24V	936A6.000	04/03 ⇒ 04/05

LANCIA

KAPPA 3.0 24V	838B.000	10/94 ⇒ 10/01
THESIS 3.0 V6	841A.000	07/02 ⇒ 07/09
THESIS 3.2 V6	841L.000	05/03 ⇒ 07/09

EPS 1.970.316



05

COILS

Adatt./Suitable:

BOSCH

0 221 506 002
0 221 506 003
0 221 506 444
0 221 506 445

DAEWOO

0001587003
0001587503

MERCEDES-BENZ

A 000 150 02 80
A 000 158 70 03
A 000 158 71 03
A 000 158 75 03

PUCH

000 158 71 03
A 000 150 02 80

SSANGYONG

0001587003
0001587103
0001587503
1621580103

VW

00A 905 105

00 Eliminated on 27-01-2021. Please verify the availability through our local distributors

- Eliminato il 27-01-2021. Verificare la disponibilità presso i nostri distributori
- Éliminé le 27-01-2021. Vérifier la disponibilité auprès de nos distributeurs sur place
- Am 27-01-2021 gestrichen. Evtl. Verfügbarkeit bitte bei unseren Händlern prüfen
- Eliminado en fecha 27-01-2021. Verificar la disponibilidad a través de nuestros distribuidores locales

250 without spark plug connector

- senza cappuccio candela d'accensione
- sans cosse de bougie d'allumage
- ohne Zündkerzenstecker
- sin conector de bujia de encendido



	ohm		ohm
	0,35		7500

DAEWOO

KORANDO 2.0	E20	12/98 ⇒	02/01
KORANDO 2.0 16V	E20, M161.950	02/99 ⇒	
KORANDO 2.3	E23, M161.970	01/99 ⇒	
KORANDO 3.2 4x4	E32, M104.995	01/99 ⇒	
MUSSO 2.3	M111.970	01/99 ⇒	
MUSSO 3.2 4x4	M104.992, M162E32	01/99 ⇒	
REXTON 3.2 V6	M162.992	04/02 ⇒	

MERCEDES-BENZ

100 LI 2.3	M161.971	11/96 ⇒	
CLASSE E I E 280	M104.942	06/93 ⇒	06/95
CLASSE E I E 280 T	M104.942	06/93 ⇒	06/96
CLASSE E I E 320	M104.992	06/93 ⇒	03/98
CLASSE E I E 320 T	M104.992	06/93 ⇒	06/96
CLASSE E I E 36 AMG	M104.992(AMG3.6)	06/93 ⇒	03/98
CLASSE E I E 36 T AMG	M104.992(AMG3.6)	05/94 ⇒	06/96
124 320 CE	M104.992	10/92 ⇒	05/93
CLASSE C I C 180	M111.921	03/93 ⇒	05/00
CLASSE C I C 180 T	M111.921	06/96 ⇒	09/00
CLASSE C I C 200	M111.945	01/94 ⇒	05/00
CLASSE C I C 200 Kompressor	M111.944	10/95 ⇒	05/00
CLASSE C I C 200 T	M111.945	06/96 ⇒	03/01
CLASSE C I C 200 T Kompressor	M111.944	11/96 ⇒	03/01
CLASSE C I C 230	M111.974	06/96 ⇒	06/97
CLASSE C I C 230 Kompressor	M111.975	10/95 ⇒	05/00
CLASSE C I C 230 T	M111.974	06/96 ⇒	06/98
CLASSE C I C 230 T Kompressor	M111.975	06/97 ⇒	09/00
CLASSE C I C 280	M104.941	05/93 ⇒	05/00
CLASSE C I C 36 AMG	M104.941(AMG3.6)	05/94 ⇒	05/00
SPRINTER I 214	M111.979, M111.984	02/95 ⇒	05/06
SPRINTER I 214 NGT	M111.984, M111979NGT, M111984NGT	02/95 ⇒	05/06
SPRINTER I 314	M111.979, M111.984	02/95 ⇒	05/06
SPRINTER I 314 4x4	M111.984	08/02 ⇒	05/06
SPRINTER I 314 NGT	M111.984, M111979NGT, M111984NGT	02/95 ⇒	05/06
SPRINTER I 414	M111.979, M111.984	02/95 ⇒	05/06
SPRINTER I 414 4x4	M111.979, M111.984	05/97 ⇒	05/06
SPRINTER I 414 NGT	M111.979, M111.984, M111979NGT, M111984NGT	02/95 ⇒	05/06
CLASSE CLK I 200	M111.945	06/97 ⇒	06/02

MERCEDES-BENZ

CLASSE CLK I 200 Kompressor	M111.944	06/97 ⇒	06/00
CLASSE CLK I 230 Kompressor	M111.975	06/97 ⇒	06/00
CLASSE E II E 200	M111.942	06/95 ⇒	08/00
CLASSE E II E 200 Kompressor	M111.947	06/97 ⇒	03/02
CLASSE E II E 200 T	M111.942	06/96 ⇒	08/00
CLASSE E II E 200 T Kompressor	M111.947	06/97 ⇒	03/03
CLASSE E II E 230	M111.970	06/95 ⇒	06/97
CLASSE E II E 230 T	M111.970	06/96 ⇒	06/97
CLASSE E II E 280	M104.945	01/96 ⇒	06/97
CLASSE E II E 320	M104.995	06/95 ⇒	06/97
CLASSE E II E 36 AMG	M104995AMG	04/96 ⇒	01/98
CLASSE G II 320 GE	M104.996	09/94 ⇒	11/97
CLASSE G II G 320	M104.996	09/94 ⇒	12/97
CLASSE G II G 36 AMG	M104.996(AMG3.6)	01/95 ⇒	07/98
CLASSE V V 200	M111.948, M111.950	02/97 ⇒	07/03
CLASSE V V 230	M111.978, M111.980	10/96 ⇒	07/03
CLASSE M I ML 230	M111.977	02/98 ⇒	06/05
CLASSE S III 300 SE 2.8	M104.944	01/93 ⇒	10/98
CLASSE S III 300 SE, SEL/S320	M104.994	03/91 ⇒	10/98
CLASSE S III S 280	M104.944	02/93 ⇒	10/98
CLASSE SL IV 280	M104.943	08/93 ⇒	10/01
CLASSE SL IV 320	M104.991	09/93 ⇒	10/01
CLASSE SLK I 200	M111.946	09/96 ⇒	03/00
CLASSE SLK I 200 Kompressor	M111.943	10/96 ⇒	03/00
CLASSE SLK I 230 Kompressor	M111.973	09/96 ⇒	03/00
KOMBI II 280 TE	M104.942	10/92 ⇒	06/93
KOMBI II 320 TE	M104.992	10/92 ⇒	06/93
TRE VOLUMI II 280 E	M104.942	10/92 ⇒	06/93
TRE VOLUMI II 320 E	M104.992	10/92 ⇒	06/93
VITO I 113 2.0	M111.948, M111.950	02/96 ⇒	07/03
VITO I 114 2.3	M111.978	12/96 ⇒	07/03

PUCH

G-MODELL G 320	M104.996	02/94 ⇒	12/97
G-MODELL G 36 AMG	M104.952(AMG3.6)	01/95 ⇒	04/98

SSANGYONG

CHAIRMAN 3.2	G32D	07/11 ⇒	
KORANDO 2.0	E20, E20M160, E20M161, M111E20	05/97 ⇒	10/02
KORANDO 2.3	--, E23, M111.970, M111E23, M111E23-143	05/97 ⇒	11/06
KORANDO 3.2	E32, M104.992, M104.995	12/96 ⇒	11/06
KYRON 3.2 M320 4x4	G32D	03/08 ⇒	
MUSSO 2.0	E20, M111E20	10/96 ⇒	05/05
MUSSO 3.2	M104.992	06/96 ⇒	09/04
REXTON I 3.2 RX320 4x4	G32D	04/02 ⇒	
RODIUS 3.2	M162E32	05/05 ⇒	
RODIUS 3.2 4WD	G32D	07/07 ⇒	

VW

LT II 2.3	AGL	05/96 ⇒	07/06
-----------	-----	---------	-------

EPS 1.970.316K



05

COILS

Adatt./Suitable:

00 Eliminated on 16-09-2019. Please verify the availability through our local distributors

- Eliminato il 16-09-2019. Verificare la disponibilità presso i nostri distributori
- Éliminé le 16-09-2019. Vérifier la disponibilité auprès de nos distributeurs sur place
- Am 16-09-2019 gestrichen. Evtl. Verfügbarkeit bitte bei unseren Händlern prüfen
- Eliminado en fecha 16-09-2019. Verificar la disponibilidad a través de nuestros distribuidores locales

250 incl. spark plug connector

- con cappuccio candela accensione
- Cosse de bougie d'allumage comprise
- inkl. Zündkerzenstecker
- incl. conector bujías



	ohm		ohm
	0,35		7500

MERCEDES-BENZ

100 LI 2.3	M161.971	11/96 ⇒	
CLASSE E I E 280	M104.942	06/93 ⇒	06/95
CLASSE E I E 280 T	M104.942	06/93 ⇒	06/96
CLASSE E I E 320	M104.992	06/93 ⇒	03/98
CLASSE E I E 320 T	M104.992	06/93 ⇒	06/96
CLASSE E I E 36 AMG	M104.992(AMG3.6)	06/93 ⇒	03/98
CLASSE E I E 36 T AMG	M104.992(AMG3.6)	05/94 ⇒	06/96
124 320 CE	M104.992	10/92 ⇒	05/93
CLASSE C I C 180	M111.921	03/93 ⇒	05/00
CLASSE C I C 180 T	M111.921	06/96 ⇒	09/00
CLASSE C I C 200	M111.945	01/94 ⇒	05/00
CLASSE C I C 200 Kompressor	M111.944	10/95 ⇒	05/00
CLASSE C I C 200 T	M111.945	06/96 ⇒	03/01
CLASSE C I C 200 T Kompressor	M111.944	11/96 ⇒	03/01
CLASSE C I C 230	M111.974	06/96 ⇒	06/97
CLASSE C I C 230 Kompressor	M111.975	10/95 ⇒	05/00
CLASSE C I C 230 T	M111.974	06/96 ⇒	06/98
CLASSE C I C 230 T Kompressor	M111.975	06/97 ⇒	09/00
CLASSE C I C 280	M104.941	05/93 ⇒	05/00
CLASSE C I C 36 AMG	M104.941(AMG3.6)	05/94 ⇒	05/00
SPRINTER I 214 NGT	M111.984	02/95 ⇒	05/06
SPRINTER I 314 NGT	M111.984	02/95 ⇒	05/06
SPRINTER I 414	M111.979	02/96 ⇒	05/06
SPRINTER I 414 4x4	M111.979	05/97 ⇒	05/06
CLASSE G II 320 GE	M104.996	09/94 ⇒	11/97
CLASSE G II G 320	M104.996	09/94 ⇒	12/97
CLASSE G II G 36 AMG	M104.996(AMG3.6)	01/95 ⇒	07/98
CLASSE S III 300 SE 2.8	M104.944	01/93 ⇒	10/98
CLASSE S III 300 SE, SEL/S320	M104.994	03/91 ⇒	10/98
CLASSE S III S 280	M104.944	02/93 ⇒	10/98
CLASSE SL IV 280	M104.943	08/93 ⇒	10/01
CLASSE SL IV 320	M104.991	09/93 ⇒	10/01
KOMBI II 280 TE	M104.942	10/92 ⇒	06/93
KOMBI II 320 TE	M104.992	10/92 ⇒	06/93
TRE VOLUMI II 280 E	M104.942	10/92 ⇒	06/93
TRE VOLUMI II 320 E	M104.992	10/92 ⇒	06/93

PUCH

G-MODELL G 320	M104.996	02/94 ⇒	12/97
G-MODELL G 36 AMG	M104.952(AMG3.6)	01/95 ⇒	04/98

EPS 1.970.317



07

COILS

Adatt./Suitable:

BOSCH
0 221 505 437
0 221 505 438**HITACHI**
138711
2508711**MAGNETI MARELLI**
060717098012**MERCEDES-BENZ**
A 000 150 04 80
A 000 150 05 80
A 000 158 68 03**00 Eliminated on 26-04-2021. Please verify the availability through our local distributors**

• Eliminato il 26-04-2021. Verificare la disponibilità presso i nostri distributori

• Éliminé le 26-04-2021. Vérifier la disponibilité auprès de nos distributeurs sur place

• Am 26-04-2021 gestrichen. Evtl. Verfügbarkeit bitte bei unseren Händlern prüfen

• Eliminado en fecha 26-04-2021. Verificar la disponibilidad a través de nuestros distribuidores locales



		ohm		ohm
M5	M5	0,4	∅ 4	9200

MERCEDES-BENZ

CLASSE E I E 200	M111.940	06/93 ⇒ 03/98
CLASSE E I E 200 T	M111.940	06/93 ⇒ 06/96
CLASSE E I E 220	M111.960	06/93 ⇒ 03/98
CLASSE E I E 220 T	M111.960	06/93 ⇒ 06/96
124 220 CE	M111.960	10/92 ⇒ 05/93
CLASSE C I C 180	M111.920	03/93 ⇒ 05/00
CLASSE C I C 180 T	M111.920	06/96 ⇒ 09/00
CLASSE C I C 200	M111.941	01/94 ⇒ 05/00
CLASSE C I C 200 T	M111.941	06/96 ⇒ 03/01
CLASSE C I C 220	M111.961	03/93 ⇒ 05/00
KOMBI II 200 TE	M111.940	05/86 ⇒ 06/93
KOMBI II 220 TE	M111.960	10/92 ⇒ 05/93
TRE VOLUMI II 200 E	M111.940	10/92 ⇒ 06/93
TRE VOLUMI II 220 E	M111.960	10/92 ⇒ 06/93

EPS 1.970.322



05

COILS

Adatt./Suitable:

DENSO

029700-7301

TOYOTA
90919-02200**03 Supplied until depletion**

• Fornibile fino ad esaurimento delle scorte

• Fourni jusqu'à épuisement du stock

• Lieferbar solange vorrat reicht

• Suministrado hasta el stock termina



	ohm		ohm
- +	0,5	∅ 8.4	12500

TOYOTA

PREVIA I 2.4	2TZ-FE	05/90 ⇒ 08/00
PREVIA I 2.4 4WD	2TZ-FE, 2TZ-FZE	01/90 ⇒ 12/99

EPS 1.970.341



07

COILS

Adatt./Suitable:

BOSCH

F 000 Z50 112

DELCO REMY

3 474 232

3 474 282

DUCELLIER

2 526 050 A

GENERAL MOTORS

03 474 232

03 474 282

90 449 740

90 510 387

OPEL

12 08 002

12 08 004

12 08 048

03 Supplied until depletion

• Fornibile fino ad esaurimento delle scorte

• Fourni jusqu'à épuisement du stock

• Lieferbar solange vorrat reicht

• Suministrado hasta el stock termina



	ohm		ohm
6.4	0,45	∅ 6.3	5700

OPEL

ASTRA F 1.6 i	C16NZ	09/91 ⇒ 09/98
CORSA A 1.2	12S, 12ST	09/82 ⇒ 08/90

OPEL

CORSA A 1.2 N	12NV	01/90 ⇒ 03/93
CORSA A 1.2 S	12S, 12ST	09/82 ⇒ 03/93
CORSA A 1.3	13NB, 13SB, C13N	09/85 ⇒ 10/89
CORSA A 1.3 GL	13S	09/82 ⇒ 03/93
CORSA A 1.3 i	C13N	09/86 ⇒ 09/90
CORSA A 1.3 S	13SB	09/82 ⇒ 10/89
CORSA A 1.6 GSI	C16NZ	08/88 ⇒ 09/92
KADETT D 1.2	12ST	08/82 ⇒ 08/84
KADETT E 1.3 i Cat	C13N	09/85 ⇒ 08/91
KADETT E 1.3 N	13N, 13NB	09/84 ⇒ 08/91
KADETT E 1.3 S	13S	09/84 ⇒ 02/93
KADETT E 1.6	16SV	09/86 ⇒ 12/91
KADETT E 1.6 i	16SV, C16NZ, E16NZ	09/86 ⇒ 07/94
KADETT E 1.6 i Cat	C16LZ, C16NZ	09/86 ⇒ 02/93
KADETT E 1.6 S	16S, 16SV	09/84 ⇒ 08/91
VECTRA A 1.6 i	C16NZ, E16NZ	09/88 ⇒ 11/95
VECTRA A 1.6 i Cat	C16NZ	09/88 ⇒ 11/95

VAUXHALL

ASTRA III 1.6 i	C16NZ	09/91 ⇒ 12/98
ASTRAVAN I 1.6 i	C16NZ	10/91 ⇒ 08/98

EPS 1.970.345



07,5

COILS

Adatt./Suitable:

BOSCH

0 986 221 003

CHAMPION

BAE 920 A

BAE 920 AX

FIAT

46446039

46472440

46480361

500309816

7789346

HITACHI

138739

2508739

IVECO

500309816

LANCIA

46446039

46472440

46480361

7789346

MAGNETI MARELLI

060717067012

060792001010

BAE 920 A

BAE 920 AX



	ohm		ohm
- + -	0,55	∅ 4	4500

FIAT

BRAVA 1.6 16V	182A4.000, 182A4.027, 182A6.000, 182B6.000	10/95 ⇒ 12/02
BRAVO I 1.6	182B6.000	09/00 ⇒ 10/01
BRAVO I 1.6 16V	178A8.011, 182A4.000, 182A6.000	10/95 ⇒ 10/01
DOBLO I 1.6 Natural Power	182B6.000, 182B6000CNG	09/02 ⇒
MAREA 1.6	182B6.000, 185A3.000	09/00 ⇒ 08/02
MAREA 1.6 100 16V	182A4.000	09/96 ⇒ 05/02
MAREA 1.6 100 16V Bipower	182A4.000, 185A3.000	04/99 ⇒ 05/02
MAREA 1.6 16V	185A3.000	04/97 ⇒ 02/99
MAREA 1.6 SX	182B5.098	09/00 ⇒ 08/02
MULTIPLA 1.6	182B6.000	09/00 ⇒ 06/10
MULTIPLA 1.6 100 16V	182A4.000	04/99 ⇒ 06/10
MULTIPLA 1.6 16V	182B6.000	04/02 ⇒ 06/10
MULTIPLA 1.6 16V Bipower	182B6.000, 186A4.000	10/01 ⇒ 06/10
MULTIPLA 1.6 16V Blupower	186A3.000, 186A3000CNG	04/99 ⇒ 06/10
MULTIPLA 1.6 16V GPL	182B6.000	10/01 ⇒ 06/10
MULTIPLA 1.6 Natural Power	182B6000CNG	11/08 ⇒ 06/10
MULTIPLA VAN 1.6	182B6.000	09/00 ⇒ 06/10

FIAT			
MULTIPLA VAN Bipower	182B6.000	10/01 ⇒ 06/10	
PALIO 1.6	178C7.098, 178D2.011	07/97 ⇒	
PALIO 1.6 16V	178B3.000, 178C7.098, 178D2.011, 182B6.000	02/01 ⇒	
PALIO 1.6 16V Sport	178E7.000	10/01 ⇒	
SIENA 1.6	182B6.000	11/00 ⇒ 12/12	
SIENA 1.6 16V	178B3.000	09/98 ⇒	
STRADA 1.6 MPI	178D2.011	07/05 ⇒	

FIAT (BR)			
BRAVA 1.6i 16v	1.6Mpi	01/00 ⇒	
PALIO 1.6i	1.6Mpi	01/99 ⇒ 12/00	
PALIO 1.6i 16v	1.6Mpi16v	01/96 ⇒	
SIENA 1.6i 16v	1.6Mpi	01/98 ⇒ 12/99	
STRADA 1.6i 16v	1.6Mpi	01/99 ⇒	

IVECO			
DAILY II 2.8 CNG	8149.03	05/99 ⇒ 07/07	
DAILY II 50 C 11 Natural Power	8149.03	05/99 ⇒ 04/06	
DAILY III 50 C 11 Natural Power	8149.03	05/02 ⇒ 05/06	
DAILY 2.8 CNG	8149.03	07/99 ⇒ 12/06	

LANCIA			
DEDRA 1.6 16V	182A4.000	01/96 ⇒ 07/99	
DELTA II 1.6 i.e.	182A6.000	03/96 ⇒ 08/99	
DELTA II 1.6 i.e. 16V	182A4.000	01/96 ⇒ 08/99	
LYBRA 1.6	182B6.000	10/00 ⇒ 10/05	
LYBRA 1.6 16V	182A4.000	07/99 ⇒ 10/05	

EPS 1.970.347



05

COILS

Adatt./Suitable:

HITACHI
138810
2508810
CM1T-228
CM1T-228 A
CM1T-228 B
CM1T-228 C

03 Supplied until depletion

- Fornibile fino ad esaurimento delle scorte
- Fourni jusqu'à épuisement du stock
- Lieferbar solange vorrat reicht
- Suministrado hasta el stock termina

HONDA
30500-P0A-A01
30500-P0H-A01
30500-PAA-A01
30500-PCA-003
30500-PDA-E01

ISUZU
5-86206161-0
5-86207198-0

MAGNETI MARELLI
060717021012

ROVER
GCL207
NEC100750



ohm		ohm	
4,8	0,49	28000	

HONDA			
ACCORD VI 2.3 i 16V Vtec	F23Z5	11/00 ⇒	
ACCORD VI 2.3 VTi	F23A3	02/98 ⇒ 10/02	
CIVIC VI 1.4 16V	D14A7, D14Z3	04/98 ⇒ 02/01	
CIVIC VI 1.4 i	D14A3, D14A5, D14A7, D14Z1, D14Z3, D14Z4	06/95 ⇒ 02/01	
CIVIC VI 1.4 i S	D14Z4	11/95 ⇒ 02/01	
CIVIC VI 1.4 LPG	D14A4, D14Z4	01/97 ⇒ 02/01	
CIVIC VI 1.4i 16V	D14Z3, D14Z4	11/98 ⇒ 12/00	
CIVIC VI 1.4i 16V Vtec	D14Z4	01/99 ⇒	
CIVIC VI 1.5 16V	D15Z8	01/97 ⇒ 02/01	
CIVIC VI 1.5 i	D15Z8	11/95 ⇒ 02/01	
CIVIC VI 1.6	D16W4, D16Y2	10/95 ⇒ 03/01	
CIVIC VI 1.6 16V	D16B2, D16W3, D16W4	01/97 ⇒ 02/01	
CIVIC VI 1.6 i	D16Y5	11/95 ⇒ 02/01	
CIVIC VI 1.6 i Vtec	D16Y6	11/95 ⇒ 02/01	
CIVIC VI 1.6i 16V	D16W3	11/98 ⇒ 12/00	
CIVIC VI 1.8 16V	B18C4	01/97 ⇒ 02/01	
CIVIC V 1.6i Vtec	D16Y6	01/94 ⇒ 03/96	
ODYSSEY 2.2	F22B6	01/95 ⇒ 12/97	
ODYSSEY 2.3	F23A	10/97 ⇒ 09/03	
ODYSSEY 2.3 4x4	F23A	10/97 ⇒ 09/03	
ODYSSEY 2.3 i 16V Vtec	F23A8	01/98 ⇒	
SHUTTLE 2.3 16V	F23A7, F23A8	10/97 ⇒ 06/04	

ROVER			
400 II 416 Si	16K4F, D16Y2, D16Y3, D16B2	03/95 ⇒ 03/00	
600 618 i/Si	F18A3	03/96 ⇒ 02/99	
600 620 i	F20Z2	08/93 ⇒ 06/96	
600 620 Si	F20Z1	08/93 ⇒ 02/99	

EPS 1.970.352



05

COILS

Adatt./Suitable:

BMW
1 703 227
1 748 017
1 748 018
12 13 1 703 228
12 13 1 703 825
12 13 1 748 017
12 13 1 748 018
12 13 7 599 219
12 13 9 067 830
7 599 219

BOSCH
0 221 504 004
0 221 504 029
1 227 030 081

LAND ROVER
1748018
LR022494
NEC000040
NEC101000L

00 Eliminated on 23-03-2021. Please verify the availability through our local distributors

- Eliminato il 23-03-2021. Verificare la disponibilità presso i nostri distributori
- Éliminé le 23-03-2021. Vérifier la disponibilité auprès de nos distributeurs sur place
- Am 23-03-2021 gestrichen. Evtl. Verfügbarkeit bitte bei unseren Händlern prüfen
- Eliminado en fecha 23-03-2021. Verificar la disponibilidad a través de nuestros distribuidores locales



ohm		ohm	
0,56	∅ 4	---	

BMW			
3 III 320 i	M50B20(20651), M50B20(20652), M52B20(20653)	01/91 ⇒	11/99
3 III 323 i	M52B25(25653)	05/95 ⇒	11/99
3 III 323 ti	M52B25(25653)	09/97 ⇒	08/00
3 III 328 i	M52B28(28651)	01/95 ⇒	11/99
3 III M3 3.2	S50B32(32651)	10/95 ⇒	09/99
3 IV 320 Ci	M52B20(20654), M52B20654, M54B22(22651), M54B22651	01/00 ⇒	12/07
3 IV 320 i	4F8Q636, M52B20(20654), M52B20654, M54B22(22651), M54B22651	09/00 ⇒	02/05
3 IV 323 Ci	0LF8, 8CLS, M52B25(25654), M52B25654	04/99 ⇒	09/00

BMW			
3 IV 323 i	-(24653), M52B25(25654), M52B25654	03/98 ⇒	12/03
3 IV 325 Ci	4CCS, M54B25(25655), M54B25655, M5625656	09/00 ⇒	
3 IV 325 i	-(24654), M54B25(25655), M54B25655, M5625656	09/00 ⇒	
3 IV 325 ti	M54B25(25655), M54B25655	04/01 ⇒	12/04
3 IV 325 xi	M54B25(25655), M54B25655	09/00 ⇒	02/05
3 IV 328 Ci	M52B28(28652), M52B28652	12/98 ⇒	05/00
3 IV 328 i	1LGX, M52B28(28652), M52B28652	02/98 ⇒	06/00
3 IV 330 Ci	7ACR, M54B30(30653), M54B30653	06/00 ⇒	08/06
3 IV 330 i	M54B30(30653), M54B30653	06/00 ⇒	04/05
3 IV 330 xi	M54B30(30653), M54B30653	06/00 ⇒	07/06
5 IV 520 i	6BJT, 8TJ3760E, M52B20653, M52B20654, M54B22(22651), M54B22651	09/00 ⇒	12/03
5 IV 523 i	1LDS, 4M18A, 6GW491Q-E, 8K7M818, M52B25(25653), M52B25653	09/95 ⇒	08/00
5 IV 525 i	8CUG, M54B25(25655), M54B25655	09/00 ⇒	05/04
5 IV 528 i	9D0836LE501, M52B28(28651), M52B28(28652), M52B28652	09/95 ⇒	08/00
5 IV 530 i	2CBL, M54B30(30653), M54B30653	09/00 ⇒	12/03
5 IV 535 i	1H4B410, 6DAM15B, M62B35(35852)	06/96 ⇒	08/98
5 IV 540 i	0JL465QH, 54A915, 9K20C3, M62B44(44851), M62B44(44852), M62B44852	03/96 ⇒	12/03
5 IV M5	8D0836LF40, S62B50(50851)	10/98 ⇒	06/03
7 III 728 i, iL	M52B28(28651), M52B28(28652)	08/95 ⇒	11/01
7 III 728i X	M52B28(28651)	11/95 ⇒	09/01
7 III 735 i, iL	M62B35(35851)	03/96 ⇒	08/98
7 III 740 i, iL	M62B44(44851), M62B44(44852)	02/96 ⇒	07/01
8 840 Ci	M62B44(44851)	03/96 ⇒	06/99
Z3 2.0 i	M52B20(20654)	04/99 ⇒	01/03
Z3 2.2 i	M54B22(22651)	08/00 ⇒	01/03
Z3 2.8 i	M52B28(28651), M52B28(28652)	01/96 ⇒	07/00
Z3 3.0 i	M54B30(30653)	06/00 ⇒	06/03
Z3 M	S50B32(32651)	02/98 ⇒	06/01
Z3 M 3.2	S50B32(32651)	01/97 ⇒	06/00
Z8 4.9	S62B50(50851)	01/00 ⇒	12/03
X5 I 3.0 i	M54B30(30653)	04/00 ⇒	12/06
X5 I 4.4 i	M62B44(44852), M62B44852	01/00 ⇒	09/03
X5 I 4.6 iS	M62B46(46851), M62B46851	10/01 ⇒	09/03

LAND ROVER

DEFENDER 2.8 90, 110	--	09/00 ⇒	
FREELANDER 2.5 V6 4x4	25KV6	11/00 ⇒	10/06
RANGE ROVER III 4.4 4x4	448PN, 445DEX, M62B44	03/02 ⇒	08/12

EPS 1.970.354



COILS
Adatt./Suitable:

- 03 Supplied until depletion**
- Fornibile fino ad esaurimento delle scorte
 - Fourni jusqu'à épuisement du stock
 - Lieferbar solange vorrat reicht
 - Suministrado hasta el stock termina

- 250 incl. spark plug connector**
- con cappuccio candela accensione
 - Cosse de bougie d'allumage comprise
 - inkl. Zündkerzenstecker
 - incl. conector bujias

- 302 Paired article numbers**
- N° articolo appaiato
 - Numéro d'article en paire
 - paarige Artikelnummer
 - Referencia artículo par

1.970.354S

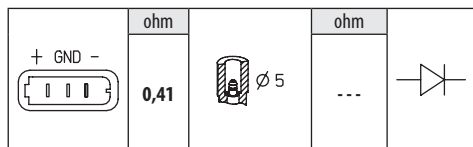

VOLKSWAGEN (BR)		
GOLF A4 1.8i Turbo 20v	AGU	10/99 ⇨
VW		
PASSAT IV 1.8 T Syncro	AEB	11/96 ⇨ 08/00

EPS 1.970.354S



COILS
Adatt./Suitable:

- AUDI**
058 905 101
058 905 105
- BOSCH**
0 986 221 011
0 986 22A 203

- HITACHI**
133805
2503805

- SEAT**
058 905 105

- SKODA**
058 905 101
058 905 105

- VW**
058 905 101
058 905 105

- 03 Supplied until depletion**
- Fornibile fino ad esaurimento delle scorte
 - Fourni jusqu'à épuisement du stock
 - Lieferbar solange vorrat reicht
 - Suministrado hasta el stock termina

- 255 without spark plug connector**
- senza cappuccio candela d'accensione
 - sans cosse de bougie d'allumage
 - ohne Zündkerzenstecker
 - sin conector de bujia de encendido

- 301 Paired article numbers**
- N° articolo appaiato
 - Numéro d'article en paire
 - paarige Artikelnummer
 - Referencia artículo par

1.970.354 1.970.422

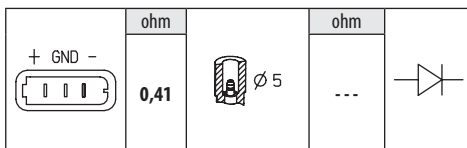

AUDI		
A3 I 1.8 T	AGU	12/96 ⇨ 05/03
A3 I 1.8 T quattro	AGU	12/96 ⇨ 05/03
A6 I S6 Plus quattro	AHK	04/96 ⇨ 12/97
A4 I 1.8 T	AEB, AJL, ANB, APU, ARK	01/95 ⇨ 09/01
A4 I 1.8 T quattro	AEB, AJL, ANB, APU, ARK, AWT	01/95 ⇨ 09/01
A4 I RS4 quattro	ASJ, AZR	05/00 ⇨ 09/01
A4 I S4 quattro	AGB, AZB	09/97 ⇨ 09/01
A6 II 1.8 T	AEB, AJL, ANB, APU, ARK	01/97 ⇨ 01/05
A6 II 1.8 T quattro	AEB, AJL, ANB, APU, ARK	02/97 ⇨ 01/05
A6 II 2.7 T	AJK	02/99 ⇨ 01/05
A6 II 2.7 T quattro	AJK, ARE, AZA	08/01 ⇨ 01/05
A8 I 3.7	AKJ	06/97 ⇨ 12/98
A8 I 4.2 quattro	ABZ, AEM, AGH, AKG, AQF, AUW	03/94 ⇨ 11/98
A8 I S8 quattro	AHC, AKH	07/96 ⇨ 06/99
ALLROAD 2.7 T quattro	1457L77, ARE	05/00 ⇨ 08/05

SEAT		
ALHAMBRA I / II 1.8 T 20V	AJH	10/97 ⇨ 03/10

SKODA		
OCTAVIA I 1.8 T	AGU	08/97 ⇨ 12/10

VOLKSWAGEN (BR)		
GOLF A4 1.8i Turbo 20v	AGU	10/99 ⇨

VW		
PASSAT IV 1.8 T	AEB, ANB, APU	10/96 ⇨ 11/00
PASSAT IV 1.8 T Syncro	AEB	11/96 ⇨ 08/00
BORA 1.8 T	AGU	05/00 ⇨ 05/05
GOLF IV 1.8 T	AGU	08/97 ⇨ 06/06
SHARAN I 1.8 T 20V	AJH	09/97 ⇨ 03/10

EPS 1.970.355



COILS
Adatt./Suitable:

- BOSCH**
0 986 221 030

- DUCELLIER**
2 526 051 A
2 526 110 A

- HITACHI**
138757
2508757

- MAGNETI MARELLI**
060717073012

- RENAULT**
77 00 863 020
77 01 041 607

- SAGEM**
2 526 051 A
2 526 110 A

- VOLVO**
70863020
708630207

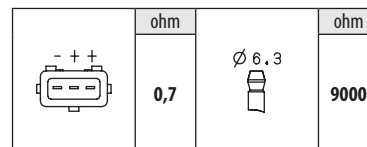

RENAULT		
LAGUNA I 2.0	N7Q700, N7Q704	06/95 ⇨ 02/01
LAGUNA I 2.0 16V	N7Q700, N7Q704	06/95 ⇨ 03/01
MEGANE I 1.6 e	K7M702, K7M703, K7M790	01/96 ⇨ 08/03
MEGANE I 1.6 i	K7M720, K7M790	01/96 ⇨ 03/99
MEGANE I 1.6 LPG	K7M702	08/95 ⇨ 03/99
MEGANE SCÉNIC I 1.6 e	K7M702, K7M703	10/96 ⇨ 10/99
MEGANE SCÉNIC I 1.6 i	K7M720	01/97 ⇨ 09/99
MEGANE 1.6 BiFuel	K7M702	10/96 ⇨ 10/99
SAFRANE II 2.0 16V	N7Q710, N7Q711	07/96 ⇨ 12/00

VOLVO		
S40 I 1.6	B4164S	09/95 ⇨ 08/99
S40 I 1.8	B4184S	07/95 ⇨ 08/99
S40 I 2.0	B4204S, B4204S2	07/95 ⇨ 08/99
V40 I 1.6	B4164S	12/95 ⇨ 08/99
V40 I 1.8	B4184S	07/95 ⇨ 08/99
V40 I 2.0	B4204S	07/95 ⇨ 08/99

EPS 1.970.356



05

COILS

Adatt./Suitable:

BOSCH

0 986 221 031

DUCELLIER

2 526 052 A

2 526 111 A

HITACHI

138758

2508758

MAGNETI MARELLI

060717071012

RENAULT

77 00 863 021

77 01 041 608

SAGEM

2 526 052 A

2 526 111 A

VOLVO

70863021

708630215



	ohm		ohm
	0,7	∅ 6,3	9000

RENAULT

LAGUNA I 2.0	N7Q700, N7Q704	06/95 ⇒ 02/01
LAGUNA I 2.0 16V	N7Q700, N7Q704	06/95 ⇒ 03/01
MEGANE I 1.6 e	K7M702, K7M703, K7M790	01/96 ⇒ 08/03
MEGANE I 1.6 i	K7M720, K7M790	01/96 ⇒ 03/99
MEGANE I 1.6 LPG	K7M702	08/95 ⇒ 03/99
MEGANE SCÉNIC I 1.6 e	K7M702, K7M703	10/96 ⇒ 10/99
MEGANE SCÉNIC I 1.6 i	K7M720	01/97 ⇒ 09/99
MEGANE 1.6 BiFuel	K7M702	10/96 ⇒ 10/99
SAFRANE II 2.0 16V	N7Q710, N7Q711	07/96 ⇒ 12/00

VOLVO

S40 I 1.6	B4164S	09/95 ⇒ 08/99
S40 I 1.8	B4184S	07/95 ⇒ 08/99
S40 I 2.0	B4204S, B4204S2	07/95 ⇒ 08/99
V40 I 1.6	B4164S	12/95 ⇒ 08/99
V40 I 1.8	B4184S	07/95 ⇒ 08/99
V40 I 2.0	B4204S	07/95 ⇒ 08/99

EPS 1.970.364



07

COILS

Adatt./Suitable:

BOSCH

F 000 Z50 212

FORD

1 008 886

1 008 887

1 018 139

1 018 140

96FB-12257-AB

A96BF-12024-A1B

HITACHI

138803

MAGNETI MARELLI

060717036012

⁰⁰ Eliminated on 23-02-2022. Please verify the availability through our local distributors

• Eliminato il 23-02-2022. Verificare la disponibilità presso i nostri distributori

• Éliminé le 23-02-2022. Vérifier la disponibilité auprès de nos distributeurs sur place

• Am 23-02-2022 gestrichen. Evtl. Verfügbarkeit bitte bei unseren Händlern prüfen

• Eliminado en fecha 23-02-2022. Verificar la disponibilidad a través de nuestros distribuidores locales

³⁰⁰ Paired article numbers

- N° articolo appaiato
- Numéro d'article en paire
- paarige Artikelnummer
- Referencia artículo par

1.970.135



	ohm		ohm
	0,5	∅ 7	13000

FORD

FIESTA III 1.0	TLB	03/89 ⇒ 12/95
FIESTA III 1.1	G6A, GUD, GUE	03/89 ⇒ 12/95
FIESTA III 1.3	J6B, JBB, JBC	03/89 ⇒ 02/96
FIESTA III 1.3 Cat	J6B	05/91 ⇒ 01/97
ESCORT V 1.3	J4B, J6A, JBE	07/90 ⇒ 01/95
ESCORT VI 1.3	BL13H-JBE	01/95 ⇒ 02/99
FIESTA IV 1.0 i	OEAL	04/96 ⇒ 09/99
FIESTA IV 1.3 i	JBC	08/95 ⇒ 01/02
ORION II 1.3	BL13H-JBE, J4B, J6A	07/90 ⇒ 12/94

EPS 1.970.365



07

COILS

Adatt./Suitable:

HITACHI

138765

2508765

MAGNETI MARELLI

060717072012

RENAULT

77 00 872 449

77 00 872 834

82 00 141 149

SAGEM

2 526 078 A

2 526 078 B



	ohm		ohm
	0,7	∅ 4	9000

RENAULT

CLIO I 1.2	D7F730	01/96 ⇒ 09/98
CLIO II 1.2	D7F710, D7F720, D7F722, D7F726	09/98 ⇒
CLIO II 1.2 LPG	D7F722	03/99 ⇒ 05/01
CLIO II 2.0 16V Sport	F4R730, F4R732, F4R736, F4R738	02/00 ⇒ 06/09
KANGOO 1.2 BiFuel	D7F710, D7F722, D7F744, D7F764, D7F766	06/97 ⇒ 06/03
KANGOO I 1.2	D7F710, D7F720, D7F722, D7F726, D7F744, D7F746, D7F764, D7F766	08/97 ⇒
KANGOO I 1.2 BiFuel	D7F710, D7F744	07/98 ⇒ 07/01
LAGUNA II 2.0 16V IDE	FSR700, FSR701	04/01 ⇒ 09/07
MEGANE I 2.0 16V	F4R746	01/02 ⇒ 08/03
MEGANE I 2.0 16V IDE	F4R746, FSR740	11/99 ⇒ 08/03
TWINGO I 1.2	D7F700, D7F701, D7F702, D7F703, D7F704, D7F706	05/96 ⇒

1.970.366S

EPS 1.970.366S



05

COILS

Adatt./Suitable:

BOSCH

F 005 X11 775

FORD

4 132 292
B6S7 18100
XM34-4608-CA

FORD USA

4 132 292
XM34-4608-CA

MAZDA

B6S7-18-100
FEJK-18-10X**00 Eliminated on 23-02-2022. Please verify the availability through our local distributors**

- Eliminato il 23-02-2022. Verificare la disponibilità presso i nostri distributori
- Éliminé le 23-02-2022. Vérifier la disponibilité auprès de nos distributeurs sur place
- Am 23-02-2022 gestrichen. Evtl. Verfügbarkeit bitte bei unseren Händlern prüfen
- Eliminado en fecha 23-02-2022. Verificar la disponibilidad a través de nuestros distribuidores locales

1193 Paired article numbers

- N° articolo appaiato
- Numéro d'article en paire
- paarige Artikelnummer
- Referencia artículo par

1.970.233**245 without fastening clamp**

- senza staffa fissaggio
- sans bride de fixation
- ohne Befestigungsbügel
- sin estribo de sujeción



	ohm		ohm
	1		14500

FORD

ENDEAVOUR 2.6 EFI	--	08/03 →
EVEREST 2.6 EFI	--	08/03 →
RANGER IV 2.2	F2D6	03/02 → 09/05
RANGER IV 2.6	--	10/02 → 09/04
RANGER IV 2.6 EFI	--	10/06 →

MAZDA

E2000 2.0i 12v	FERW, FEY9	04/97 →
E2000 2.0i 12v 4x4	FEJM, FEY9	09/90 → 08/99

EPS 1.970.374



07,5

COILS

Adatt./Suitable:

DUCELLIER

2 526 073 A

LAND ROVER

NEC100630

MAGNETI MARELLI

060717131012

MG

NEC100630

ROVER

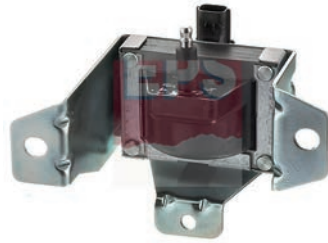
GCL201
NEC100630
NEC100630SLP
NEC100631

	ohm		ohm
	0,75		5600

LAND ROVER

FREELANDER 1.8 16V 4x4	18K4F	04/98 → 10/06
FREELANDER 1.8 4x4	18K4F	10/00 → 10/06
FREELANDER 1.8 i 16V 4x4	18K4F	02/98 → 10/06

MG

EXPRESS 1.4	14K4F	03/03 → 05/05
MG TF 115	16K4F	03/02 → 12/09
MG TF 135	18K4F	03/02 → 12/09
MG TF 160	18K4K	03/02 → 12/09
MG ZR 105	14K4F	06/01 → 04/05
MG ZR 120	18K4F	06/01 → 04/05

ROVER

25 1.1	11K4F, 11K2F	09/99 → 05/05
25 1.1 16V	11K4F	01/04 → 05/05
25 1.4	14K4M	01/03 → 12/05
25 1.4 16V	14K4F, 14K4M	10/99 → 05/05
25 1.6 16V	16K4F	10/99 → 05/05
25 1.8 16V	18K4F	10/99 → 05/05
200 II 214 GSi/Si	14K4C	01/90 → 10/95
200 II 216 1.6i 16V	16K4F	01/96 → 11/99
200 III 1.4	14K4D	01/96 → 12/97
200 III 211	11K2D	01/98 → 03/00
200 III 214 i	14K2F	11/95 → 03/00
200 III 214 Si	14K4F	11/95 → 03/00
200 III 216 Si	16K4F	11/95 → 06/99
400 II 414	14K2F	03/96 → 12/99
400 II 414 Si	14K4F	05/95 → 03/00
400 II 416 Si	16K4F, D16V2	03/95 → 03/00
400 I 1.6 i	16K4F, D16A8	05/94 → 11/98
400 I 414	14K4C	01/93 → 04/95
STREETWISE 1.4	14K4F, 14K4M	08/03 → 05/05
STREETWISE 1.6	16K4F	01/04 → 05/05

EPS 1.970.376



05

COILS

Adatt./Suitable:

BOSCH

0 986 221 025

HITACHI

138759
2508759

MAGNETI MARELLI

060717068012

RENAULT

77 00 100 589

SAGEM

2 526 114 A

03 Supplied until depletion

- Fornibile fino ad esaurimento delle scorte
- Fourni jusqu'à épuisement du stock
- Lieferbar solange vorrat reicht
- Suministrado hasta el stock termina



	ohm		ohm
	0,7		9000

RENAULT

CLIO II 1.4	E7J780	09/98 → 05/05
CLIO II 1.6	K7M744, K7M745	09/98 → 05/05
KANGOO I 1.4	E7J780	08/97 →
MEGANE I 1.6 e	K7M702, K7M703, K7M790	01/96 → 08/03
MEGANE I 1.6 i	K7M720	01/96 → 03/99
MEGANE I 1.6 LPG	K7M702	08/95 → 03/99
MEGANE SCÉNIC I 1.6 e	K7M702, K7M703	10/96 → 10/99
MEGANE SCÉNIC I 1.6 i	K7M720	01/97 → 09/99
MEGANE 1.6 BiFuel	K7M702	10/96 → 10/99

EPS 1.970.377



07

COILS

Adatt./Suitable:

- 00 Eliminated on 16-11-2021. Please verify the availability through our local distributors**
- Eliminato il 16-11-2021. Verificare la disponibilità presso i nostri distributori
 - Éliminé le 16-11-2021. Vérifier la disponibilité auprès de nos distributeurs sur place
 - Am 16-11-2021 gestrichen. Evtl. Verfügbarkeit bitte bei unseren Händlern prüfen
 - Eliminado en fecha 16-11-2021. Verificar la disponibilidad a través de nuestros distribuidores locales

RB Replaced by

- Sostituito da
- Remplacé par
- Ersetzt durch
- Reemplazado por

1.970.596



	ohm		ohm
	0,7		9000

EPS 1.970.378



05

COILS

Adatt./Suitable:

BOSCH
0 986 221 026

HITACHI
138766
2508766

MAGNETI MARELLI
060717069012

RENAULT
77 00 100 643

SAGEM
2 526 115 A

03 Supplied until depletion

- Fornibile fino ad esaurimento delle scorte
- Fourni jusqu'à épuisement du stock
- Lieferbar solange vorrat reicht
- Suministrado hasta el stock termina



	ohm		ohm
	0,7		9000

RENAULT

CLIO II 1.4	E7J780	09/98 ⇨ 05/05
CLIO II 1.6	K7M744, K7M745	09/98 ⇨ 05/05
KANGOO I 1.4	E7J780	08/97 ⇨
MEGANE I 1.6 e	K7M702, K7M703, K7M790	01/96 ⇨ 08/03
MEGANE I 1.6 i	K7M720	01/96 ⇨ 03/99
MEGANE I 1.6 LPG	K7M702	08/95 ⇨ 03/99
MEGANE SCÉNIC I 1.6 e	K7M702, K7M703	10/96 ⇨ 10/99
MEGANE SCÉNIC I 1.6 i	K7M720	01/97 ⇨ 09/99
MEGANE 1.6 BiFuel	K7M702	10/96 ⇨ 10/99

EPS 1.970.384



05,5

COILS

Adatt./Suitable:

FIAT
46473849

HITACHI
133926
2503926
CM11-202

LANCIA
46473849

MAGNETI MARELLI
060810090010



	ohm		ohm	
	

FIAT

BARCETTA 1.8 16V	183A1.000, 188A6.000	04/95 ⇨ 05/05
BRAVO I 1.8 GT	182A2.000	10/95 ⇨ 10/01
COUPE 1.8 16V	183A1.000	03/96 ⇨ 08/00
PUNTO II 1.8 130 HGT	183A1.000, 188A6.000	09/99 ⇨ 03/12
PUNTO II 1.8 16V	188A6.000	06/03 ⇨
STILO 1.8 16V	192A4.000	10/01 ⇨ 08/08

FIAT (BR)

BRAVA 1.8i 16v	1.8Mpi	01/00 ⇨
MAREA 1.8i 16v	1.8Mpi	01/00 ⇨ 12/01

LANCIA

DELTA II 1.8 i.e. 16V GT	183A1.000	03/96 ⇨ 08/99
LYBRA 1.8 16V	839A4.000, 839A7.000, 839A9.000	07/99 ⇨ 10/05

EPS 1.970.386



05

COILS

Adatt./Suitable:

ALFA ROMEO
71711984
7793212

BOSCH
1 227 030 059

255 without spark plug connector

- senza cappuccio candela d'accensione
- sans cosse de bougie d'allumage
- ohne Zündkerzenstecker
- sin conector de bujía de encendido

301 Paired article numbers

- N° articolo appaiato
- Numéro d'article en paire
- paarige Artikelnummer
- Referencia artículo par

1.970.386K



	ohm		ohm
	0,33		7500

ALFA ROMEO

145 1.4 i.e. 16V T.S.	AR33503	12/96 ⇨ 01/01
145 1.6 i.e. 16V T.S.	AR32102, AR67601	12/96 ⇨ 01/01
145 1.6 LPG	AR32102	01/98 ⇨ 01/01
145 1.8 i.e. 16V T.S.	AR67106	12/96 ⇨ 12/98
145 1.8 i.e. 16V T.S. [BRA]	AR67199	10/96 ⇨ 02/99
145 2.0 16V T.S.	AR67204	10/95 ⇨ 01/01
145 2.0 16V T.SPARK [BRA]	AR67299	10/96 ⇨ 02/99
146 1.4 i.e. 16V T.S.	AR33503	11/96 ⇨ 01/01
146 1.6 i.e. 16V T.S.	AR32102, AR67601	11/96 ⇨ 10/01
146 1.8 i.e. 16V T.S.	AR67106	11/96 ⇨ 01/01
146 2.0 16V T.S.	AR67204	10/95 ⇨ 01/01
155 1.6 16V T.S.	AR67601	05/96 ⇨ 12/97
155 1.7 T.S. 16V	AR67106	05/96 ⇨ 12/97
155 2.0 T.S. 16V	AR67204, AR67299	03/95 ⇨ 12/97
156 1.6 16V T.SPARK	AR67601	09/97 ⇨ 09/05
156 1.6 16V T.SPARK.	AR67601	05/00 ⇨ 05/06
GTV 2.0 T.SPARK 16V	AR16201	06/95 ⇨ 10/05
SPIDER II 2.0 T.SPARK 16V	AR16201	06/95 ⇨ 04/05

1.970.386K

EPS 1.970.386K



05

COILS

Adatt./Suitable:

ALFA ROMEO
60605306 *1
BOSCH
0 221 506 001

*1 Without fastening clamp

- Senza staffa di fissaggio
- sans bride de fixation
- ohne Befestigungsbügel
- sin estribo de sujeción

245 without fastening clamp

- senza staffa fissaggio
- sans bride de fixation
- ohne Befestigungsbügel
- sin estribo de sujeción

250 incl. spark plug connector

- con cappuccio candela accensione
- Cosse de bougie d'allumage comprise
- inkl. Zündkerzenstecker
- incl. conector bujias

302 Paired article numbers

- N° articolo appaiato
- Numéro d'article en paire
- paarige Artikelnummer
- Referencia artículo par

1.970.386



	ohm		ohm
	0,33		7500

ALFA ROMEO

145 1.8 i.e. 16V T.S. [BRA]	AR67199	10/96 ⇒ 02/99
145 2.0 16V T.SPARK [BRA]	AR67299	10/96 ⇒ 02/99
145 2.0 16V T.SPARK Q.V. [BRA]	AR67299	10/95 ⇒ 09/96
155 1.6 16V T.S.	AR67601	05/96 ⇒ 12/97
155 1.7 T.S. 16V	AR67106	05/96 ⇒ 12/97
155 2.0 T.S. 16V	AR67204, AR67299	03/95 ⇒ 12/97

EPS 1.970.387



05

COILS

Adatt./Suitable:

ALFA ROMEO
46469863
BOSCH
1 227 030 062
HITACHI
133861
2503861

255 without spark plug connector

- senza cappuccio candela d'accensione
- sans cosse de bougie d'allumage
- ohne Zündkerzenstecker
- sin conector de bujia de encendido

301 Paired article numbers

- N° articolo appaiato
- Numéro d'article en paire
- paarige Artikelnummer
- Referencia artículo par

1.970.387K



	ohm		ohm
	0,33		7500

ALFA ROMEO

145 1.4 i.e. 16V T.S.	AR33503	12/96 ⇒ 01/01
145 1.6 16V T.S.	AR32102	09/97 ⇒ 12/00
145 1.6 i.e. 16V T.S.	AR32102, AR67601	12/96 ⇒ 01/01
145 1.6 LPG	AR32102	01/98 ⇒ 01/01
145 1.8 i.e. 16V	AR32201	03/98 ⇒ 01/01
145 2.0 16V	AR32301	03/98 ⇒ 01/01
146 1.4 i.e. 16V T.S.	AR33503	11/96 ⇒ 01/01
146 1.6 16V T.S.	AR32102	09/97 ⇒ 12/00
146 1.6 i.e. 16V T.S.	AR32102, AR67601	11/96 ⇒ 10/01
146 1.8 i.e. 16V T.S.	AR32201	03/98 ⇒ 01/01
146 2.0 16V	AR32301	03/97 ⇒ 10/01
146 2.0 16V T.S.	AR67204	10/95 ⇒ 01/01
156 1.6 16V T.SPARK	AR32102, AR67601	09/97 ⇒ 09/05
156 1.6 16V T.SPARK.	AR32102, AR67601	05/00 ⇒ 05/06
156 1.8 16V T.SPARK	AR32201, AR32205	09/97 ⇒ 05/06
156 2.0 16V T.SPARK	AR32301, AR32310	05/00 ⇒ 06/02
156 2.0 Twin Spark	AR32303	11/97 ⇒ 04/00
166 2.0 T.SPARK	AR34103	09/98 ⇒ 10/00
GTV 1.8 16V	AR32201	05/98 ⇒ 10/05
GTV 2.0 T.SPARK 16V	AR16201, AR32301	06/95 ⇒ 10/05
SPIDER II 1.8 16V	AR32201	05/98 ⇒ 04/05
SPIDER II 2.0 T.SPARK 16V	AR32301	05/98 ⇒ 08/00

EPS 1.970.387K



05

COILS

Adatt./Suitable:

250 incl. spark plug connector

- con cappuccio candela accensione
- Cosse de bougie d'allumage comprise
- inkl. Zündkerzenstecker
- incl. conector bujias

302 Paired article numbers

- N° articolo appaiato
- Numéro d'article en paire
- paarige Artikelnummer
- Referencia artículo par

1.970.387



	ohm		ohm
	0,33		7500

ALFA ROMEO

156 1.6 16V T.SPARK.	AR32102	05/00 ⇒ 05/06
----------------------	---------	---------------

EPS 1.970.389



07

COILS

Adatt./Suitable:

BOSCH

0 221 503 011

GENERAL MOTORS

90 506 102

OPEL

12 08 076

90506102

VAUXHALL

90506102

03 Supplied until depletion

- Fornibile fino ad esaurimento delle scorte
- Fourni jusqu'à épuisement du stock
- Lieferbar solange vorrat reicht
- Suministrado hasta el stock termina



	ohm		ohm
	0,7		9000

OPEL

SINTRA 2.2 i 16V	X22XE	11/96 ⇒ 04/99
------------------	-------	---------------

VAUXHALL

SINTRA 2.2 i 16V	X22XE	11/96 ⇒ 04/99
------------------	-------	---------------

EPS 1.970.394



05

COILS

Adatt./Suitable:

HYUNDAI
27301-02502 *U

***U Supplied only the coil, not the mounting bracket, not the module**

- Fornita solo la bobina, nol la staffa di fissaggio, non il modulo
- Fourni seule la bobine, non pas le support de montage, et non pas le module
- nur die Spule geliefert wird, nicht die Montagehalterung, nicht das Modul
- Suministra sólo la bobina, no el soporte de montaje, no el módulo

03 Supplied until depletion

- Fornibile fino ad esaurimento delle scorte
- Fourni jusqu'à épuisement du stock
- Lieferbar solange vorrat reicht
- Suministrado hasta el stock termina



	ohm		ohm
	0,85		11500

HYUNDAI

ATOS 1.0 i | G4HC | 02/98 ⇨ 12/00

EPS 1.970.397



05

COILS

Adatt./Suitable:

ALFA ROMEO
46755605
BOSCH
1 227 030 071
HITACHI
133841
2503841

255 without spark plug connector

- senza cappuccio candela d'accensione
- sans cosse de bougie d'allumage
- ohne Zündkerzenstecker
- sin conector de bujia de encendido

301 Paired article numbers

- N° articolo appaiato
- Numéro d'article en paire
- paarige Artikelnummer
- Referencia artículo par

1.970.397K



	ohm		ohm
	0,33		13500

ALFA ROMEO

147 1.6 16V T.SPARK	AR32104	01/01 ⇨ 03/10
147 1.6 16V T.SPARK ECO	AR37203	01/01 ⇨ 03/10
147 1.6 LPG	AR32104, AR37203	03/01 ⇨ 03/10
147 2.0 16V T.SPARK	AR32310	01/01 ⇨ 03/10
156 1.6 16V T.SPARK	AR32103, AR32104	09/97 ⇨ 09/05
156 1.6 16V T.SPARK.	AR32103, AR32104	05/00 ⇨ 05/06
156 1.8 16V T.SPARK	AR32201, AR32205	09/97 ⇨ 05/06
156 2.0 16V T.SPARK	AR32301, AR32310	05/00 ⇨ 06/02
156 2.0 Twin Spark	AR32303	11/97 ⇨ 04/00
166 2.0 T.SPARK	AR36301	10/00 ⇨ 06/07
GT 1.8 TS	AR32205	11/03 ⇨ 09/10
GTV 2.0 T.SPARK 16V	AR32310	06/95 ⇨ 10/05
SPIDER II 2.0 T.SPARK 16V	AR32310	06/95 ⇨ 04/05

EPS 1.970.397K



05

COILS

Adatt./Suitable:

250 incl. spark plug connector

- con cappuccio candela accensione
- Cosse de bougie d'allumage comprise
- inkl. Zündkerzenstecker
- incl. conector bujias

302 Paired article numbers

- N° articolo appaiato
- Numéro d'article en paire
- paarige Artikelnummer
- Referencia artículo par

1.970.397



	ohm		ohm
	0,33		13500

ALFA ROMEO

156 1.6 16V T.SPARK.	AR32103	05/00 ⇨ 05/06
156 2.0 16V T.SPARK	AR32310	09/97 ⇨ 06/02

EPS 1.970.398



08,5

COILS

Adatt./Suitable:

- BOSCH**
0 221 503 014
0 221 503 471
- GENERAL MOTORS**
90 543 059
93 180 806
- HITACHI**
133815
133866
2503815
2503866
- MAGNETI MARELLI**
060717081012
060810208010

- OPEL**
12 08 028
12 08 306
90543059
93180806

- VAUXHALL**
90543059
93180806

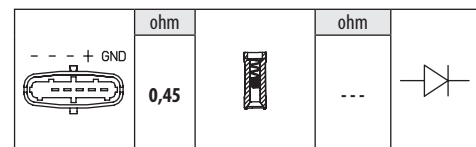

OPEL			
AGILA A 1.0	Z10XEP	08/03	⇒ 12/07
AGILA A 1.0 12V	Z10XE	09/00	⇒ 12/07
CORSA B 1.0 i 12V	X10XE	11/96	⇒ 09/00
CORSA C 1.0	1K10CT, Z10XEP	09/00	⇒ 12/09
CORSA D 1.0	Z10XEP	07/06	⇒ 08/14
VAUXHALL			
AGILA A 1.0 12V	Z10XE, Z10XEP	02/00	⇒ 11/06
CORSA B 1.0 i 12V	X10XE	11/96	⇒ 09/00
CORSA C 1.0 12V	Z10XE, Z10XEP	09/00	⇒ 10/06
CORSA D 1.0	Z10XEP	08/06	⇒ 08/14

EPS 1.970.399



08,6

COILS

Adatt./Suitable:

- BOSCH**
0 986 221 039
- GENERAL MOTORS**
19 005 212
- HITACHI**
133809
2503809
- MAGNETI MARELLI**
060717052012
- OPEL**
12 08 307
19005212
- VAUXHALL**
19005212

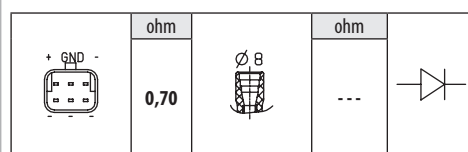

OPEL			
ASTRA G 1.4	X14XE, Z14XE	09/98	⇒ 04/05
ASTRA G 1.4 16V	X14XE, Z14XE	02/98	⇒ 01/05
ASTRA G 1.4 LPG	X14XE, Z14XE	02/98	⇒ 01/05
ASTRA G 1.6	C16SEL, Z16XE, Z16XEP	09/98	⇒ 05/04
ASTRA G 1.6 16V	X16XEL, Z16XE	02/98	⇒ 10/05
ASTRA G 1.6 CNG	Z16YNG	03/03	⇒ 07/04
ASTRA G 1.6 LPG	X16XEL, Z16XE	03/98	⇒ 01/05
ASTRA H 1.4 16V	Z14XE	05/04	⇒ 07/09
ASTRA H 1.6	Z16XE	06/04	⇒ 02/06
ASTRA H 1.6 16V	Z16XE	03/04	⇒ 01/08
ZAFIRA B 1.6 CNG	Z16YNG	07/05	⇒ 04/15
ZAFIRA B 1.6 CNG VAN	Z16YNG	07/05	⇒ 04/15
COMBO C 1.6 CNG	Y16YNG, Z16YNG	04/05	⇒ 12/11
COMBO C 1.6 CNG 16V	Y16YNG, Z16YNG	04/05	⇒
CORSA C 1.4	Z14XE	09/00	⇒ 12/09
CORSA C 1.6 CNG	Y16YNG	05/03	⇒ 12/09
CORSA C 1.6 X	Z16YNG	08/05	⇒
MERIVA A 1.6 16V	Z16XE	05/03	⇒ 01/06
VECTRA B 1.6 i 16V	X16XEL, Y16XE, Z16XE	10/95	⇒ 07/02
VECTRA C 1.6	Z16XE	08/05	⇒ 08/08
VECTRA C 1.6 16V	Z16XE	06/04	⇒ 10/05
ZAFIRA A 1.6 16V	X16XEL, Z16XE, Z16YNG	09/02	⇒ 06/05
ZAFIRA A 1.6 CNG	Z16YNG	09/01	⇒ 06/05
ZAFIRA A 1.6 LPG	X16XEL, Z16XE	10/03	⇒ 06/05

VAUXHALL			
ASTRA IV 1.4 16V	X14XE, Z14XE	02/98	⇒ 05/05
ASTRA IV 1.4 16V Dualfuel	X14XE, Z14XE	09/99	⇒ 06/03
ASTRA IV 1.6 16V	X16XEL, Z16XE	02/98	⇒ 10/05
ASTRA IV 1.6 Dualfuel	X16XEL, Z16XE	03/98	⇒ 05/05
ZAFIRA A 1.6 16V	X16XEL, Z16XE	04/99	⇒ 08/05
ZAFIRA A 1.6 CNG	Z16YNG	09/01	⇒ 06/05
ZAFIRA A 1.6 Dualfuel	X16XEL	11/98	⇒ 08/05
ASTRAVAN II 1.4 16V	Z14XE	09/00	⇒ 05/05
ASTRAVAN II 1.6 Dualfuel	Z16XE	07/00	⇒ 08/05
COMBO C 1.4 16V	Z14XE	10/01	⇒ 05/07
COMBO C 1.6 CNG	Z16YNG	04/05	⇒ 02/12
COMBO C 1.6 CNG 16V	Y16YNG, Z16YNG	04/05	⇒ 02/12
CORSA C 1.4 16V	Z14XE	09/00	⇒ 10/06
MERIVA I 1.6 i 16V	Z16XE	01/03	⇒ 09/05
VECTRA B 1.6 i 16V	X16XEL, Y16XE, Z16XE	08/95	⇒ 03/02
VECTRA C 1.6 16V	Z16XE	06/04	⇒ 07/08
ZAFIRA B 1.6 CNG	Z16YNG	07/05	⇒ 11/14

EPS 1.970.400



08,5

COILS

Adatt./Suitable:

- BOSCH**
0 221 503 015
0 221 503 472
- GENERAL MOTORS**
24 420 584
90 543 253
93 177 212
- HITACHI**
133816
133839
2503816
2503839
- MAGNETI MARELLI**
060717065012
060717133012

- OPEL**
12 08 012
12 08 020
90543253
93177212

- VAUXHALL**
90543253
93177212

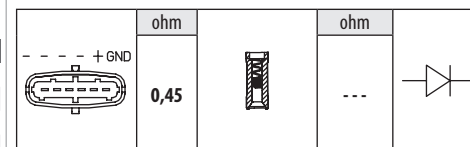

OPEL			
AGILA A 1.2 16V	Z12XE	09/00	⇒ 12/07
AGILA A 1.2 16V Twinport	Z12XEP	07/04	⇒ 12/07
ASTRA G 1.2	X12XE	09/98	⇒ 08/00
ASTRA G 1.2 16V	X12XE, Z12XE	09/00	⇒ 01/05
ASTRA G 1.4	Z14XEP	09/07	⇒ 12/09
ASTRA H 1.2	Z12XEP	08/05	⇒ 10/10
ASTRA H 1.4	Z14XEL, Z14XEP	03/04	⇒ 10/10
ASTRA H 1.4 EcoTec	Z14XEP	12/04	⇒ 12/12
ASTRA H 1.4 LPG	Z14XEP	08/09	⇒ 10/10
ASTRA J 1.4	Z14XEP	01/09	⇒
COMBO C 1.4	Z14XEP	10/04	⇒ 12/11
COMBO C 1.4 16V	Z14XEP	08/05	⇒
CORSA B 1.2 i 16V	X12XE	03/98	⇒ 09/00
CORSA C 1.2	Z12XE	09/00	⇒ 12/09
CORSA C 1.2 16V	Z12XE	09/00	⇒ 07/03
CORSA C 1.2 Twinport	Z12XEP	07/04	⇒ 12/09
CORSA C 1.4	Z14XEP	08/03	⇒ 06/12
CORSA C 1.4 Twinport	Z14XEP	06/03	⇒ 12/09
CORSA D 1.2	Z12XEP	07/06	⇒ 08/14
CORSA D 1.2 LPG	Z12XEP	08/06	⇒ 08/14
CORSA D 1.4	Z14XEP	07/06	⇒ 08/14
CORSA D 1.4 LPG	Z14XEP	08/06	⇒ 12/11
MERIVA A 1.4 16V Twinport	Z14XEP	07/04	⇒ 05/10
MERIVA A 1.4 16V Twinport LPG	Z14XEP	07/04	⇒ 05/10
TIGRA B 1.4	Z14XEP	06/04	⇒ 12/10

VAUXHALL			
AGILA A 1.2 16V	Z12XE	09/00	⇒ 03/08
AGILA A 1.2 16V Twinport	Z12XEP	07/04	⇒ 11/06
ASTRA IV 1.2 16V	X12XE, Z12XE	09/00	⇒ 05/05
ASTRA V 1.2	Z12XEP	08/05	⇒ 10/10
ASTRA V 1.4	Z14XEL, Z14XEP	01/04	⇒ 10/10
ASTRA V 1.4 i 16V	Z14XEP	03/05	⇒ 11/10
COMBO C 1.4	Z14XEP	10/04	⇒ 09/10
COMBO C 1.4 i 16V	Z14XEP	01/04	⇒ 11/11
CORSA B 1.2 i 16V	X12XE	03/98	⇒ 09/00
CORSA C 1.2 16V	Z12XE	09/00	⇒ 10/06
CORSA C 1.2 16V Dualfuel	Z12XE	08/01	⇒ 10/06
CORSA C 1.2 Twinport	Z12XEP	07/04	⇒ 10/06
CORSA C 1.4 Twinport	Z14XEP	06/03	⇒ 10/06
CORSA D 1.2	Z12XEP	08/06	⇒ 08/14
CORSA D 1.2 LPG	Z12XEP	09/09	⇒ 08/14
CORSA D 1.4	Z14XEP	08/06	⇒ 08/14
CORSA D 1.4 LPG	Z14XEP	07/06	⇒ 08/14
CORSAVAN II 1.2 16V	Z12XE, Z12XEP	09/00	⇒ 11/06

VAUXHALL		
CORSAVAN II 1.2 16V Dualfuel	Z12XE, Z12XEP	08/01 ⇒ 06/06
CORSAVAN II 1.4	Z14XEP	11/03 ⇒ 06/06
CORSAVAN III 1.2	Z12XEP	07/09 ⇒
ASTRAVAN III 1.4 i	Z14XEP	03/05 ⇒
MERIVA I 1.4 16V Twinport	Z14XEP	01/03 ⇒ 06/10
TIGRA B 1.4	Z14XEP	06/04 ⇒ 08/09

EPS 1.970.403

08,5

COILS

Adatt./Suitable:

BOSCH

0 986 221 034

CITROËN

5970 72
5970 74
5970 A9
96 246 755 80
96 281 585 80

ELECTRICFIL

15 43 01

HITACHI

133817

2503817

MAGNETI MARELLI

060717031012

PEUGEOT

5970 72
5970 74
5970 A9
96 246 755 80
96 281 585 80

SAGEM

2 526 117 A



	ohm		ohm
	0,53		12000

CITROËN

XSARA 1.4	KFX(TU3JP)	05/98 ⇒ 10/04
XSARA 1.4 i	KFW(TU3JP), KFX(TU3JP)	04/97 ⇒ 08/05
XSARA 1.4 LPG	KFW(TU3JP), KFX(TU3JP)	05/98 ⇒ 08/00
XSARA 1.6 i	NFZ(TU5JP)	04/97 ⇒ 09/00
BERLINGO I 1.4 BiFuel	KFW(TU3JP)	07/96 ⇒ 10/02
BERLINGO I 1.4 bivalent	KFW(TU3JP)	11/02 ⇒ 12/11
BERLINGO I 1.4 i	KFW(TU3JP), KFX(TU3JP)	07/96 ⇒ 12/11
BERLINGO I 1.4 i bivalent	KFW(TU3JP)	04/03 ⇒ 10/08
SAXO 1.4 VTS	KFW(TU3JP), KFX(TU3JP)	05/96 ⇒ 06/03
SAXO 1.6	NFZ(TU5JP)	02/96 ⇒ 06/03
SAXO 1.6 VTL, VTR	NFZ(TU5JP)	05/96 ⇒ 06/03
XSARA PICASSO 1.6	NFZ(TU5JP)	06/02 ⇒ 08/05

PEUGEOT

106 II 1.4 i	KFW(TU3JP), KFX(TU3JP)	05/96 ⇒ 07/04
206 1.1	HFX(TU1JP)	08/98 ⇒ 02/07
206 1.1 i	HFX(TU1JP), HFZ(TU1JP)	09/98 ⇒ 02/07
206 1.4 i	K6C(TU3JP), KFX(TU3JP)	09/98 ⇒
206 1.6 8V	NFZ(TU5JP)	05/99 ⇒ 10/03
206 1.6 i	NFZ(TU5JP)	09/98 ⇒ 12/00
306 1.4	KFW(TU3JP), KFX(TU3JP)	04/93 ⇒ 04/02
306 1.4 SL	KFW(TU3JP), KFX(TU3JP)	06/94 ⇒ 05/01
306 1.6	NFZ(TU5JP)	05/93 ⇒ 10/00
306 1.6 SR	NFZ(TU5JP)	06/94 ⇒ 10/00
RANCH 1.4	K6C(TU3JP), KFX(TU3JP)	06/96 ⇒

EPS 1.970.405

08,6

COILS

Adatt./Suitable:

BOSCH

0 986 221 035
0 986 221 084

CITROËN

5970 78
5970 79
5970 90
5970 97
5970 A8
96 358 647 80
96 358 649 80
96 548 144 80

ELECTRICFIL

15 43 02

FIAT

9467511580

9654347080

HITACHI

133818

2503818

MAGNETI MARELLI

060717030012

PEUGEOT

5970 78

5970 79

5970 90

5970 97

5970 A8

5979 A8

SAGEM

26951960-3



	ohm		ohm
	0,65		21000

CITROËN

C2 1.1	HFX(TU1JP)	09/03 ⇒ 09/12
C2 1.4	KFW(TU3JP)	09/03 ⇒ 12/09
C3 I PLURIEL 1.4	KFW(TU3A), KFX(TU3JP)	05/03 ⇒
C3 I PLURIEL 1.4 Hybrid	KFW(TU3JP)	05/05 ⇒
C3 II 1.1 BiFuel	HFX(TU1A)	11/10 ⇒
C3 II 1.1 i	HFV(TU1A), HFX(TU1A)	09/09 ⇒ 01/13
C3 II 1.4	K6E(TU3A), KFT(TU3A), KFT(TU3AE5), TU3AE5	11/09 ⇒
C3 II 1.4 LPG	KFT(TU3A)	07/10 ⇒
C3 I 1.1 i	HFX(TU1A), HFX(TU1JP)	02/02 ⇒
C3 I 1.1 LPG	HFX(TU1A)	06/06 ⇒ 12/09
C3 I 1.4 BiFuel	KFW(TU3JP)	09/08 ⇒ 12/09
C3 I 1.4 i	KFW(TU3A), KFX(TU3JP)	02/02 ⇒ 11/10
C3 I 1.4 i Bivalent	KFW(TU3JP)	02/02 ⇒
XSARA 1.4	KFX(TU3JP)	05/98 ⇒ 03/05
XSARA 1.4 i	KFW(TU3JP), KFX(TU3JP)	04/97 ⇒ 08/05
BERLINGO I 1.1 i	HFX(TU1JP)	07/96 ⇒ 05/08
BERLINGO I 1.4	K6D(TU3A), KFW(TU3A), KFW(TU3JP)	11/02 ⇒
BERLINGO I 1.4 BiFuel	KFW(TU3JP)	07/96 ⇒ 10/02
BERLINGO I 1.4 bivalent	KFW(TU3JP)	11/02 ⇒ 12/11
BERLINGO I 1.4 CNG	KFW(TU3JP)	11/02 ⇒ 03/08
BERLINGO I 1.4 GNC	KFW(TU3JP)	11/02 ⇒
BERLINGO I 1.4 Hybrid	KFW(TU3JP)	05/05 ⇒
BERLINGO I 1.4 i	KFW(TU3JP), KFX(TU3JP)	07/96 ⇒ 12/11
BERLINGO I 1.4 i bivalent	KFW(TU3JP)	04/03 ⇒ 10/08
NEMO 1.4	KFT(TU3A), KFX(TU3A), TU3AE5	02/08 ⇒
SAXO 1.1 X, SX	HFX(TU1JP)	05/96 ⇒ 09/03
SAXO 1.4 VTS	KFW(TU3JP), KFX(TU3JP)	05/96 ⇒ 06/03
SAXO 1.6	NFT(TU5JP)	02/01 ⇒ 04/04
SAXO 1.6 VTS	NFT(TU5JP)	09/00 ⇒ 09/03
XSARA PICASSO 1.6	NFV(TU5JP)	12/99 ⇒ 12/10
XSARA PICASSO 1.6 Chrono	NFV(TU5JP)	04/01 ⇒ 10/04

FIAT

FIORINO III 1.4

KFT, KFX

11/07 ⇒

QUBO 1.4

KFT, KFX

02/08 ⇒

PEUGEOT

106 II 1.1 i

HFX(TU1JP)

05/96 ⇒ 07/04

PEUGEOT

106 II 1.4 i	KFW(TU3JP), KFX(TU3JP)	05/96 ⇒ 07/04
206 1.1	HFX(TU1JP)	08/98 ⇒ 02/07
206 1.1 i	HFX(TU1JP), HFZ(TU1JP)	09/98 ⇒ 02/07
206 1.4	KFW(TU3A), KFX(TU3JP)	07/02 ⇒
206 1.4 CNG	KFW(TU3A)	05/06 ⇒ 09/07
206 1.4 i	K6D(TU3A), K6D(TU3JP), KFW(TU3A), KFW(TU3JP), TU3AF	04/05 ⇒
206 1.4 LPG	KFW(TU3JP)	07/02 ⇒ 09/07
207 1.4	KFT(TU3A), KFT(TU3AE5), KFW(TU3A), KFW(TU3A)	02/06 ⇒ 12/15
207 1.4 BiFuel	KFW(TU3A)	08/07 ⇒ 12/13
207 1.4 Flex	KFW(TU3A)	11/08 ⇒ 12/14
207 1.4 LPG	KFW(TU3A)	08/07 ⇒ 12/12
306 1.4	KFW(TU3JP), KFX(TU3JP)	04/93 ⇒ 04/02
306 1.4 SL	KFW(TU3JP), KFX(TU3JP)	06/94 ⇒ 05/01
306 1.6	NFT(TU5JP)	10/00 ⇒ 04/02
307 1.4	K6D(TU3JP), KFW(TU3JP)	08/00 ⇒
206+ 1.1	HFX(TU1A)	01/09 ⇒ 06/13
206+ 1.1 LPG	HFX(TU1A), HFX(TU1JP)	04/09 ⇒ 06/13
206+ 1.4 i	K6D(TU3A), KFT(TU3AE5), KFW(TU3A), TU3AE5	01/09 ⇒
1007 1.4	KFW(TU3A), KFX(TU3JP)	04/05 ⇒
BIPPER 1.4	KFW(TU3A), TU3AE5	02/08 ⇒
BIPPER TEPEE 1.4	KFW(TU3A)	04/08 ⇒
PARTNER I 1.1	HDZ(TU1M), HFX(TU1JP)	06/96 ⇒ 10/02
PARTNER I 1.4	K6D(TU3A), KFW(TU3JP)	11/02 ⇒
PARTNER I 1.4 BiFuel	KFW(TU3JP)	04/03 ⇒ 10/06
PARTNER ORIGIN 1.4	KFW(TU3JP)	07/08 ⇒ 12/15
RANCH 1.1	HFX(TU1JP)	06/96 ⇒
RANCH 1.4	K6D(TU3A), K6D(TU3JP), KFW(TU3A), KFW(TU3JP)	04/05 ⇒
RANCH 1.4 BiFuel	KFW(TU3JP)	04/03 ⇒

EPS 1.970.407

08,6

COILS

Adatt./Suitable:

CITROËN

5970 80
5970 99
96 363 378 80

HITACHI

133819

2503819

MAGNETI MARELLI

060717082012

PEUGEOT

5970 80

5970 99

SAGEM

2 526 182 A

2 526 182 B



	ohm		ohm
	0,54		18600

CITROËN

C2 1.6	NFU(TU5JP4)	07/03 ⇒ 10/10
C2 1.6 VTS	NFS(TU5JP4S)	10/04 ⇒ 12/09
C3 I PLURIEL 1.6	NFU(TU5JP4)	05/03 ⇒
C4 I 1.6 16V	NFU(TU5JP4)	11/04 ⇒ 07/11
C4 I 1.6 16V Bio-Flex	N6A(TU5JP4), NFU(TU5JP4)	09/07 ⇒
C4 I 1.6 16V Flex Fuel	N6A(TU5JP4)	02/09 ⇒
C4 I 1.6 Flex	--	02/09 ⇒ 07/11
C3 II 1.6 Flex	NFX(TU5JP4)	11/09 ⇒
C4 II 1.6 Flex	NFX(TU5JP4)	11/09 ⇒
C3 I 1.6 16V	N6A(TU5JP4), NFU(TU5JP4)	02/02 ⇒
XSARA 1.6 16V	NFU(TU5JP4)	09/00 ⇒ 08/05
BERLINGO II 1.6	N6A(TU5JP4), NFR(TU5JP4B), NFU(TU5JP4)	04/08 ⇒
BERLINGO I 1.6 16V	NFU(TU5JP4)	10/00 ⇒ 12/11

1.970.408

CITROËN		
XSARA PICASSO 1.6 16V	NGA(TU5JP4), NFU(TU5JP4)	03/05 →
PEUGEOT		
206 1.6	NFU(TU5JP4)	09/01 → 12/08
206 1.6 16V	NGA(TU5JP4), NFU(TU5JP4)	07/00 →
206 1.6 BiFuel	NFU(TU5JP4)	07/00 → 04/09
206 1.6 LPG	NFU(TU5JP4)	07/02 →
207 1.6	NGA(TU5JP4)	08/08 →
207 1.6 16V	NFU(TU5JP4)	02/06 → 10/13
207 1.6 Bioflex	NGA(TU5JP4)	01/08 → 12/13
308 I 1.6 16V	NGA(TU5JP4)	07/08 →
308 I 1.6 Bioflex	NGA(TU5JP4), NFU(TU5JP4)	04/08 →
307 1.6	NFU(TU5JP4)	07/06 → 04/12
307 1.6 16V	NGA(TU5JP4), NFU(TU5JP4)	08/00 →
307 1.6 BioFlex	→, NGA(TU5JP4), NFU(TU5JP4)	07/06 →
206+ 1.6 16V	NFU(TU5JP4)	07/10 →
1007 1.6 16V	NFU(TU5JP4)	04/05 →
PARTNER I 1.6	NGA(TU5JP4)	09/00 →
PARTNER I 1.6 16V	NFU(TU5JP4)	07/01 → 03/08
PARTNER I 1.6 Bioflex	NFU(TU5JP4)	09/00 → 10/02
PARTNER I 1.6 Flexfuel	NFU(TU5JP4)	09/00 → 10/02
PARTNER II 1.6	NFR(TU5JP4B), NFU(TU5JP4)	04/08 →
PARTNER II TEEPEE 1.6 VTi	NFR(TU5JP4B), NFU(TU5JP4)	04/08 →
PARTNER ORIGIN 1.6	NFU(TU5JP4)	09/11 → 12/15
PARTNER ORIGIN 1.6 16V	NFU(TU5JP4)	09/11 → 12/13
RANCH 1.6 16V	NGA(TU5JP4), NFU(TU5JP4)	07/01 →

EPS 1.970.408

08,7

COILS

Adatt./Suitable:

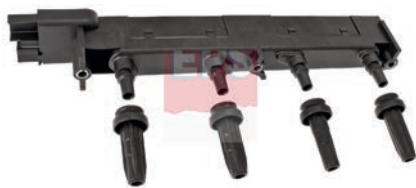
BOSCH
0 986 22A 206CITROËN
5970 75
5970 98
8970 98
96 341 314 80FIAT
9463264180
9634131380HITACHI
133883
2503883LANCIA
9463264180
9634131380MAGNETI MARELLI
060717104012PEUGEOT
5970 75
5970 98SAGEM
2 526 118 A

	ohm		ohm
	0,65		21000

CITROËN

C4 I 2.0 16V	RFN(EW10J4)	11/04 → 07/07
XSARA 2.0 16V	RFN(EW10J4)	09/00 → 08/05
C5 I 1.8	6FZ(EW7J4)	09/04 → 08/05
C5 I 1.8 16V	6FZ(EW7J4)	03/01 →
C5 I 2.0 16V	RFN(EW10J4)	03/01 → 08/04
C8 2.0	RFN(EW10J4)	07/02 →
EVASION 2.0 16V	RFN(EW10J4)	05/00 → 07/02
JUMPY I 2.0	RFN(EW10J4)	04/00 → 12/06
JUMPY I 2.0 i 16V	RFN(EW10J4)	03/00 → 10/06
XSARA PICASSO 1.8 16V	6FZ(EW7J4)	02/00 → 08/05
XSARA PICASSO 2.0	RFN(EW10J4)	02/04 → 10/04
XSARA PICASSO 2.0 16V	RFN(EW10J4)	01/03 → 06/12

FIAT

ULYSSE I 2.0 16V	RFN(EW10J4)	09/00 → 08/02
SCUDO 2.0	RFN	09/99 → 10/06
SCUDO I 2.0	RFN, RFN(EW10J4)	05/00 → 12/06
SCUDO I 2.0 16V	RFN, RFN(EW10J4)	06/00 → 12/06
ULYSSE II 2.0	RFN, RFN(EW10J4)	08/02 → 06/11

LANCIA

PHEDRA 2.0	RFN, RFN(EW10J4)	09/02 → 11/10
------------	------------------	---------------

PEUGEOT

206 2.0 16V	RFN(EW10J4)	07/02 → 02/07
206 2.0 516	RFN(EW10J4), RFR(DEW10J4), RFR(EW10J4)	04/99 → 12/07
307 2.0	RFN(EW10J4)	03/02 → 06/05
307 2.0 16V	RFN(EW10J4)	08/00 → 04/08
406 1.8 16V	6FZ(EW7J4)	10/00 → 10/04
406 1.8 BiFuel	6FZ(EW7J4)	09/00 → 05/04
406 2.0 16V	RFN(EW10J4), RFR(DEW10J4), RFR(EW10J4), RFV(XU10J4R)	08/00 → 12/04
EXPERT I 2.0	RFN(EW10J4)	07/00 → 12/06
407 1.8	6FZ(EW7J4)	03/04 → 07/05
407 1.8 16V	6FY(EW7A)	08/05 → 12/10
407 2.0	RFN(EW10J4)	03/04 → 07/05
607 2.0	RFN(EW10J4)	02/00 → 08/05
806 2.0	RFN(EW10J4)	05/00 → 02/03
806 2.0 16V	RFN(EW10J4)	09/00 → 08/02
807 2.0	RFN(EW10J4)	06/02 →

EPS 1.970.412

05

COILS

Adatt./Suitable:

BOSCH
0 221 504 410
0 221 504 474

00 Eliminated on 17-11-2020. Please verify the availability through our local distributors

- Eliminato il 17-11-2020. Verificare la disponibilità presso i nostri distributori
- Éliminé le 17-11-2020. Vérifier la disponibilité auprès de nos distributeurs sur place
- Am 17-11-2020 gestrichen. Evtl. Verfügbarkeit bitte bei unseren Händlern prüfen
- Eliminado en fecha 17-11-2020. Verificar la disponibilidad a través de nuestros distribuidores locales

250 incl. spark plug connector

- con cappuccio candela accensione
- Cosse de bougie d'allumage comprise
- inkl. Zündkerzenstecker
- incl. conector bujías

302 Paired article numbers

- N° articolo appaiato
- Numéro d'article en paire
- paarige Artikelnummer
- Referencia artículo par

1.970.1625



	ohm		ohm
	0,48		...

BMW

3 III 320 i	M50B20(206S1), M50B20(206S2), M52B20(206S3)	01/91 → 11/99
3 III 325 i	M50B25(256S1), M50B25(256S2)	09/90 → 12/95
3 III M3 3.0	S50B30(306S1)	11/92 → 07/95
5 III 520 i	M50B20(206S1), M50B20(206S2)	07/91 → 07/96
5 III 520 i 24V	M50B20(206S1), M50B20(206S2)	04/90 → 08/95

BMW

5 III 525 i	M50B25(256S1), M50B25(256S2)	07/91 → 07/96
5 III 525 i 24V	M50B25(256S2)	03/90 → 08/95
5 III 525 ix	M50B25(256S1)	01/92 → 03/96
5 III 525 ix 24V	M50B25(256S1), M50B25(256S2)	10/91 → 08/95
5 III 530 i	M60B30(308S1)	09/92 → 07/96
5 III 530 i V8	M60B30(308S1)	09/92 → 12/95
5 III 540 i	M60B40(408S1)	09/93 → 07/96
5 III 540 i V8	M60B40(408S1)	09/92 → 12/95
7 II 730 i, iL V8	M60B30(308S1)	04/92 → 09/94
7 II 740 i, iL V8	M60B40(408S1)	05/92 → 03/94
7 III 730 i, iL	M60B30(308S1)	03/94 → 02/96
7 III 740 i, iL	M60B40(408S1)	03/94 → 02/96
8 840 i	M60B40(408S1)	03/93 → 02/96

EPS 1.970.413

05

COILS

Adatt./Suitable:

LAND ROVER
NEC101010LMG
NEC101000
NEC101010ROVER
NEC101000
NEC10100SLP
NEC101010

00 Eliminated on 17-11-2020. Please verify the availability through our local distributors

- Eliminato il 17-11-2020. Verificare la disponibilità presso i nostri distributori
- Éliminé le 17-11-2020. Vérifier la disponibilité auprès de nos distributeurs sur place
- Am 17-11-2020 gestrichen. Evtl. Verfügbarkeit bitte bei unseren Händlern prüfen
- Eliminado en fecha 17-11-2020. Verificar la disponibilidad a través de nuestros distribuidores locales



	ohm		ohm
	0,56		...

BMW

3 III 320 i	M50B20(206S1), M50B20(206S2), M52B20(206S3)	01/91 → 11/99
3 III 323 i	M52B25(256S3)	05/95 → 11/99
3 III 323 ti	M52B25(256S3)	09/97 → 08/00
3 III 328 i	M52B28(286S1)	01/95 → 11/99
3 III M3 3.2	S50B32(326S1)	10/95 → 09/99
3 IV 320 Ci	M52B20(206S4), M54B22(226S1)	01/00 → 12/07
3 IV 320 i	M52B20(206S4), M54B22(226S1)	09/00 → 02/05
3 IV 323 Ci	M52B25(256S4)	04/99 → 09/00
3 IV 323 i	-(246S3), M52B25(256S4)	03/98 → 12/03
3 IV 325 Ci	M54B25(256S5)	09/00 →
3 IV 325 i	-(246S4), M54B25(256S5), M56256S6	09/00 →
3 IV 325 ti	M54B25(256S5)	04/01 → 12/04
3 IV 325 xi	M54B25(256S5)	09/00 → 02/05
3 IV 328 Ci	M52B28(286S2)	12/98 → 05/00
3 IV 328 i	M52B28(286S2)	02/98 → 06/00
3 IV 330 Ci	M54B30(306S3)	06/00 → 08/06
3 IV 330 i	M54B30(306S3)	06/00 → 02/05
3 IV 330 xi	M54B30(306S3)	06/00 → 07/06
5 IV 520 i	M54B22(226S1)	09/00 → 12/03
5 IV 523 i	M52B25(256S3)	09/95 → 08/00
5 IV 525 i	M54B25(256S5)	09/00 → 05/04
5 IV 528 i	M52B28(286S1), M52B28(286S2)	09/95 → 08/00
5 IV 530 i	M54B30(306S3)	09/00 → 12/03
5 IV 535 i	M62B35(358S2)	06/96 → 08/98
5 IV 540 i	M62B44(448S1), M62B44(448S2)	03/96 → 12/03
5 IV M5	S62B50(508S1)	10/98 → 06/03
7 III 728 i, iL	M52B28(286S1), M52B28(286S2)	08/95 → 11/01
7 III 728i X	M52B28(286S1)	11/95 → 09/01
7 III 735 i, iL	M62B35(358S1)	03/96 → 08/98

BMW		
7 III 740 i, iL	M62B44(44851), M62B44(44852)	02/96 ⇨ 07/01
8 840 Ci	M62B44(44851)	03/96 ⇨ 06/99
Z3 2.0 i	M52B20(20654)	04/99 ⇨ 01/03
Z3 2.2 i	M54B22(22651)	08/00 ⇨ 01/03
Z3 2.8 i	M52B28(28651), M52B28(28652)	01/96 ⇨ 07/00
Z3 3.0 i	M54B30(30653)	06/00 ⇨ 06/03
Z3 M	S50B32(32651)	02/98 ⇨ 06/01
Z3 M 3.2	S50B32(32651)	01/97 ⇨ 06/00
Z8 4.9	S62B50(50851)	01/00 ⇨ 12/03
X5 I 3.0 i	M54B30(30653)	04/00 ⇨ 12/06
X5 I 4.4 i	M62B44(44852)	01/00 ⇨ 09/03
X5 I 4.6 is	M62B46(46851)	10/01 ⇨ 09/03

LAND ROVER		
DEFENDER 2.8 90, 110	--	09/00 ⇨
FREELANDER 2.5 V6 4x4	25KV6	11/00 ⇨ 10/06

MG		
MG ZS 180	25K4F	07/01 ⇨ 10/05

ROVER		
45 2.0V6	20K4F	02/00 ⇨ 05/05

EPS 1.970.414



COILS

Adatt./Suitable:

BOSCH

0 221 503 022

MERCEDES-BENZ

A 000 158 77 03

A 160 158 77 03

SMART

Q 0003100V004000000

Q 0003100V005000000

Eliminated on 16-12-2019. Please verify the availability through our local distributors

• Eliminato il 16-12-2019. Verificare la disponibilità presso i nostri distributori

• Éliminé le 16-12-2019. Vérifier la disponibilité auprès de nos distributeurs sur place

• Am 16-12-2019 gestrichen. Evtl. Verfügbarkeit bitte bei unseren Händlern prüfen

• Eliminado en fecha 16-12-2019. Verificar la disponibilidad a través de nuestros distribuidores locales



	ohm		ohm	
-- GND +	0,45	∅ 4	---	

SMART

CABRIO 0.6	M160E6ALB03, M160E6ALB05, M160.910, M160.920	03/00 ⇨ 01/04
CABRIO 0.7	M160.910, M160.920	01/03 ⇨ 01/04
CITY COUPE 0.6	M160.910	12/99 ⇨ 04/03
CITY-COUPE 0.6	M160E6ALB03, M160E6ALB04, M160E6ALB05, M160.910, M160.920	01/01 ⇨ 01/04
CITY-COUPE 0.7	M160.910, M160.920	01/03 ⇨ 01/04
CROSSBLADE 0.6	M160.910, M160.920	06/02 ⇨ 12/03
FORTWO I 0.6	M160.910	01/04 ⇨ 02/07
FORTWO I 0.7	M160.910, M160.920	01/04 ⇨ 01/07
ROADSTER 0.7	M160.921, M160.922	04/03 ⇨ 11/05
ROADSTER 0.7 Brabus	M160.923	12/03 ⇨ 11/05

EPS 1.970.416



COILS

Adatt./Suitable:

BOSCH

F 000 Z50 206 *4

F 000 Z50 207

FIAT

46752948 *4

HITACHI

138878

2508878

Eliminated on 23-02-2022. Please verify the availability through our local distributors

• Eliminato il 23-02-2022. Verificare la disponibilità presso i nostri distributori

• Éliminé le 23-02-2022. Vérifier la disponibilité auprès de nos distributeurs sur place

• Am 23-02-2022 gestrichen. Evtl. Verfügbarkeit bitte bei unseren Händlern prüfen

• Eliminado en fecha 23-02-2022. Verificar la disponibilidad a través de nuestros distribuidores locales

***Supplied coil only-not alu cast**

• Fornita solo la bobina, non la fusione in alluminio

• Fourni seulement la bobine, non pas la fusion en alu

• Nur Zündspule alleine geliefert-ohne Gussteil

• Suministrada solamente bobina, no la fundición



	ohm		ohm
	0,5	∅ 4	13000

FIAT

PALIO 1.0 MPI 178F1.011 11/03 ⇨ 07/05

PALIO 1.2 16V 178D7.055 06/05 ⇨

SIENA 1.2 16V 178D7.055 01/02 ⇨

SIENA 1.3 188A5.000 09/01 ⇨ 12/09

FIAT (BR)

PALIO 1.0i 16v 1.0Mpi16vFire 01/01 ⇨

PALIO 1.3i 16v 1.3Mpi16vFire 01/00 ⇨

SIENA 1.3i 16v 1.3MpiFire 01/00 ⇨ 12/00

EPS 1.970.417



COILS

Adatt./Suitable:

BOSCH

0 221 503 035

0 221 503 036

CHRYSLER

5098138AA

HITACHI

138709

2508709

MAGNETI MARELLI

060717163012

MAN

51.25919-0016

MERCEDES-BENZ

A 000 158 73 03

A 000 158 78 03

SCANIA

1789358



	ohm		ohm	
	0,53	∅ 4	---	

CHRYSLER

CROSSFIRE 3.2 EGX 07/03 ⇨ 12/08

CROSSFIRE SRT-6 EGZ 09/04 ⇨ 12/07

MAN

LION'S CITY D0826LUH, E2876LUH02, E2876LUH03 05/07 ⇨

NG E2866DUH01, E2876LUH02 05/07 ⇨ 07/99

NL E2866DUH01, E2866DUH02, E2866DUH03, E2866LUH02, E2876LUH02 05/07 ⇨ 07/99

MERCEDES-BENZ

CITARO M476.930, M476.932, M476.933, M476.934 04/00 ⇨

CLASSE A II A 150 M266.920 09/04 ⇨ 06/12

CLASSE A II A 160 M266.920 04/09 ⇨ 06/12

CLASSE A II A 170 M266.940 09/04 ⇨ 06/12

CLASSE A II A 180 M266.940 04/09 ⇨ 06/12

CLASSE A II A 200 M266.960 09/04 ⇨ 06/12

CLASSE A II A 200 TURBO M266.980 09/05 ⇨ 06/12

CLASSE B I B 150 M266.920 03/05 ⇨ 11/11

CLASSE B I B 160 M266.920 04/09 ⇨ 11/11

CLASSE B I B 170 M266.940 03/05 ⇨ 11/11

CLASSE B I B 170 NGT M266.960, M266960NGT 04/08 ⇨ 11/11

CLASSE B I B 180 M266.940 04/09 ⇨ 11/11

CLASSE B I B 180 NGT M266.960, M266960NGT 04/08 ⇨ 11/11

CLASSE B I B 200 M266.960 03/05 ⇨ 11/11

CLASSE B I B 200 TURBO M266.980 03/05 ⇨ 11/11

CLASSE C I C 240 M112.910 06/97 ⇨ 05/00

CLASSE C I C 240 T M112.910, M112.915 09/00 ⇨ 03/01

CLASSE C I C 280 M112.920 06/97 ⇨ 05/00

CLASSE C I C 280 T M112.920 06/97 ⇨ 03/01

CLASSE C I C 43 AMG M113.944 08/97 ⇨ 03/01

CLASSE C II C 240 M112.912 05/00 ⇨ 08/07

CLASSE C II C 240 4-matic M112.916 07/02 ⇨ 08/07

CLASSE C II C 32 AMG M112.961 02/01 ⇨ 08/07

Kompressor

CLASSE C II C 320 M112.946 05/00 ⇨ 05/08

CLASSE C II C 320 4-matic M112.953 07/02 ⇨ 08/07

CLASSE C II C 55 AMG M113.988 02/04 ⇨ 08/07

CLASSE CLK I 320 M112.940 06/97 ⇨ 06/02

CLASSE CLK I 430 M113.943 07/98 ⇨ 06/02

CLASSE CLK I 55 AMG M113.984 01/00 ⇨ 12/03

CLASSE CLK II 240 M112.912 06/02 ⇨ 05/09

CLASSE CLK II 320 M112.955 06/02 ⇨ 05/09

CLASSE CLK II 500 M113.968 06/02 ⇨ 05/09

CLASSE CLK II 55 AMG M113.987 09/02 ⇨ 05/09

CLASSE CLK II CLK 240 M112.912 02/03 ⇨ 03/10

CLASSE CLK II CLK 320 M112.955 02/03 ⇨ 03/10

CLASSE CLK II CLK 500 M113.968 02/03 ⇨ 03/10

1.970.419

MERCEDES-BENZ

CLASSE CLK II CLK 55 AMG	M113.987	06/02 → 03/10
CLASSE CLS I CLS 500	M113.967	10/04 → 12/10
CLASSE CLS I CLS 55 AMG	M113.990	01/05 → 12/10
CLASSE E II E 240	M112.911, M112.914	08/00 → 03/02
CLASSE E II E 240 T	M112.911, M112.914	08/00 → 03/03
CLASSE E II E 280	M112.921	12/96 → 03/02
CLASSE E II E 280 4-matic	M112.921	12/96 → 03/02
CLASSE E II E 280 T	M112.921	12/96 → 03/03
CLASSE E II E 280 T 4-matic	M112.921	12/96 → 03/03
CLASSE E II E 320	M112.941	06/97 → 03/02
CLASSE E II E 320 4-matic	M112.941	06/97 → 03/02
CLASSE E II E 320 T	M112.941	12/96 → 03/03
CLASSE E II E 320 T 4-matic	M112.941	12/96 → 03/03
CLASSE E II E 430	M113.940	06/97 → 03/02
CLASSE E II E 430 4-matic	M113.940	05/99 → 03/02
CLASSE E II E 430 T	M113.940	06/97 → 03/03
CLASSE E II E 430 T 4-matic	M113.940	05/99 → 03/03
CLASSE E II E 55 AMG	M113.980	08/97 → 03/02
CLASSE E II E 55 T AMG	M113.980	08/97 → 03/03
CLASSE E III E 240	M112.913	03/02 → 12/08
CLASSE E III E 240 4-matic	M112.917	03/03 → 12/08
CLASSE E III E 240 T	M112.913	03/03 → 07/09
CLASSE E III E 240 T 4-matic	M112.917	07/03 → 07/09
CLASSE E III E 320	M112.949	03/02 → 12/08
CLASSE E III E 320 4-matic	M112.954	03/03 → 12/08
CLASSE E III E 320 T	M112.949	03/03 → 07/09
CLASSE E III E 320 T 4-matic	M112.954	07/03 → 07/09
CLASSE E III E 500	M113.967	03/02 → 12/08
CLASSE E III E 500 4-matic	M113.969	10/03 → 12/08
CLASSE E III E 500 T	M113.967	10/03 → 07/09
CLASSE E III E 500 T 4-matic	M113.969	10/03 → 07/09
CLASSE E III E 55 AMG	M113.990	10/02 → 12/08
Kompressor		
CLASSE E III E 55 T AMG	M113.990	07/03 → 07/09
Kompressor		
CLASSE E E 280	M112.921	07/99 → 11/02
CLASSE G II G 320	M112.945	06/97 → 11/97
CLASSE G II G 500	M113.962	04/98 →
CLASSE G II G 55 AMG	M113.962, M113.982, M113.993	04/98 →
CLASSE M I ML 320	M112.942	02/98 → 08/02
CLASSE M I ML 350	M112.970	08/02 → 06/05
CLASSE M I ML 430	M113.942	02/98 → 06/05
CLASSE M I ML 500	M113.965	09/01 → 06/05
CLASSE M I ML 55 AMG	M113.981	02/00 → 06/05
CLASSE M II ML 500 4-matic	M113.964	07/05 → 12/11
CLASSE R R 500 4-matic	M113.971	08/05 → 12/14
CLASSE S IV S 280	M112.922	10/98 → 08/05
CLASSE S IV S 320	M112.944	10/98 → 08/05
CLASSE S IV S 350	M112.972	09/02 → 08/05
CLASSE S IV S 350 4-matic	M112.975	06/03 → 08/05
CLASSE S IV S 430	M113.941	10/98 → 08/05
CLASSE S IV S 430 4-matic	M113.948	09/02 → 08/05
CLASSE S IV S 500	M113.960	10/98 → 08/05
CLASSE S IV S 500 4-matic	M113.966	09/02 → 08/05
CLASSE S IV S 55 AMG	M113.986	04/99 → 08/05
CLASSE S IV S 55 AMG	M113.991	06/02 → 08/05
Kompressor		
CLASSE SL IV 280	M112.923	05/98 → 10/01
CLASSE SL IV 320	M112.943	05/98 → 10/01
CLASSE SL IV 500	M113.961	05/98 → 10/01
CLASSE SL V 350	M112.973	03/03 → 01/12
CLASSE SL V 500	M113.963	10/01 → 01/12
CLASSE SL V 55 AMG	M113.992, M113.995	10/01 → 01/12
CLASSE SL V 55 AMG	M113.992	06/02 → 01/12
Kompressor		
CLASSE SLK I 32 AMG	M112.960	03/01 → 04/04
Kompressor		
CLASSE SLK I 320	M112.947	03/00 → 04/04
CLASSE SLK II 55 AMG	M113.989	06/04 → 12/11
SLR MCLAREN 5.4	M155.980	04/04 →
SLR MCLAREN 5.4 722 Edition	M155.980	10/06 →
SLR MCLAREN 5.5	M155.980	09/04 →
SLR MCLAREN 5.5 SLR McLaren	M155.980	04/07 → 12/09
VIANO 3.2	M112.951	09/03 →
VIANO 3.7	M112.976	06/04 →
VITO II 119	M112.951	09/03 →
VITO II 122	M112.951	09/03 →
VITO II 123	M112.976	06/04 → 07/08
PUCH		
G-MODELL G 500	M113.962	12/97 → 11/00
G-MODELL G 55 AMG	M113.982	04/99 → 03/01

EPS 1.970.419

07,5

COILS

Adatt./Suitable:

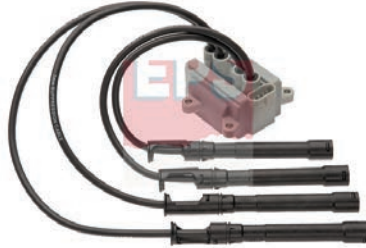
BOSCH
0 986 221 036**HITACHI**
138712
2508712**NISSAN**
22448-00QAD**RENAULT**
82 00 025 256
82 00 084 401

	ohm		ohm
	0,39		11000

NISSAN

KUBISTAR 1.2 16V D4F712 04/06 →

RENAULT

CLIO II 1.0 16V	D4D700	01/01 →
CLIO II 1.2 16V	D4F706, D4F712, D4F714	06/01 → 08/16
CLIO III 1.2 16V	D4F706	06/05 → 12/14
KANGOO 1.2	D4F712, D4F714	07/01 → 10/03
KANGOO 1.0	D4D700, D4D720	01/02 → 01/07
KANGOO I 1.0 16V	59CH23N17, D4D700	03/98 →
KANGOO I 1.2 16V	D4F712, D4F714, D4F716	06/01 →
TWINGO I 1.0 16V	D4D712	01/01 →
TWINGO I 1.2 16V	D4F702	01/01 → 06/07

EPS 1.970.420

05,5

COILS

Adatt./Suitable:

BOSCH
0 986 221 066
0 986 22A 201**HITACHI**
134066
134089
2504066
2504089**MAGNETI MARELLI**
060717183012

MERCEDES-BENZ

A 000 150 15 80
A 000 150 25 80
A 000 150 29 80

	ohm		ohm
	0,42		...

MERCEDES-BENZ

CLASSE C II C 160 Kompressor M271.921 05/02 → 05/08

MERCEDES-BENZ

CLASSE C II C 180 Kompressor	M271.946	05/02 → 05/08
CLASSE C II C 200 CGI Kompressor	M271.942	03/03 → 05/08
CLASSE C II C 200 Kompressor	M271.940	05/02 → 05/08
CLASSE C II C 220	M271.948	05/02 → 05/08
CLASSE C II C 230 Kompressor	M271.948	05/02 → 05/08
CLASSE C III C 180	M271.820	06/11 →
CLASSE C III C 180 CGI	M271.820, M271.952	01/07 → 08/14
CLASSE C III C 180 Kompressor	M271.820, M271.910, M271.952	01/07 → 08/14
CLASSE C III C 200	M271.820	05/11 → 01/14
CLASSE C III C 200 CGI	M271.820, M271.860, M271.950	01/07 →
CLASSE C III C 200 Kompressor	M271.820, M271.860, M271.950	01/07 → 08/14
CLASSE C III C 250	M271.860	06/11 →
CLASSE C III C 250 CGI	M271.860	07/09 → 08/14
CLASSE CLC CLC 160	M271.911, M271.921	02/09 → 06/11
CLASSE CLC CLC 180 Kompressor	M271.940, M271.946	05/08 → 06/11
CLASSE CLC CLC 200 Kompressor	M271.957	05/08 → 06/11
CLASSE CLK II 200 CGI	M271.942	07/03 → 05/09
CLASSE CLK II 200 Kompressor	M271.940, M271.955	09/02 → 05/09
CLASSE CLK II CLK 200 CGI	M271.942	07/03 → 03/10
CLASSE CLK II CLK 200 Kompressor	M271.940, M271.955	02/03 → 03/10
CLASSE E III E 200 Kompressor	M271.941, M271.956	11/02 → 07/09
CLASSE E III E 200 NGT	M271.941, M271.941NGT	03/04 → 12/08
CLASSE E III E 200 T Kompressor	M271.941	03/03 → 07/09
CLASSE E IV E 200 CGI	M271.820, M271.860	08/09 → 12/16
CLASSE E IV E 200 NGT	M271.958, M271.958NGT	03/11 → 12/15
CLASSE E IV E 250 CGI	M271.860	01/09 → 12/16
SPRINTER II 216	M271.951	09/08 →
SPRINTER II 316	M271.951	09/08 →
SPRINTER II 316 LGT	271951	09/08 →
SPRINTER II 316 NGT	M271.951, M271.951NGT	09/08 →
SPRINTER II 516	M271.951	09/08 →
SPRINTER II 516 NGT	M271.951, M271.951NGT	09/08 →
CLASSE SLK II 200 Kompressor	M271.944, M271.954	03/04 → 02/11
CLASSE SLK III 200	M271.861	02/11 →
CLASSE SLK III 250	M271.861	02/11 →

EPS 1.970.422



07

COILS

Adatt./Suitable:

03 Supplied until depletion

- Fornibile fino ad esaurimento delle scorte
- Fourni jusqu'à épuisement du stock
- Lieferbar solange vorrat reicht
- Suministrado hasta el stock termina

250 incl. spark plug connector

- con cappuccio candela accensione
- Cosse de bougie d'allumage comprise
- inkl. Zündkerzenstecker
- incl. conector bujías

302 Paired article numbers

- N° articolo appaiato
- Numéro d'article en paire
- paarige Artikelnummer
- Referencia artículo par

1.970.354S

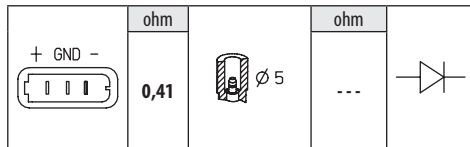

AUDI

A6 I S6 Plus quattro	AHK	04/96 ⇨ 12/97
A8 I 3.7	AKJ	06/97 ⇨ 12/98
A8 I 4.2 quattro	AGH	07/95 ⇨ 09/98

EPS 1.970.423



09

COILS

Adatt./Suitable:

ALFA ROMEO

55200112
55208723

BOSCH

0 986 221 065

CHAMPION

BAE 940 A

CHRYSLER

55208723

FIAT

55200112
55200486
55208723

FORD

1 535 713
1 671 690
9S51-12029-AA
9S51-12029-AB

HITACHI

138727
138769
2508727
2508769

LANCIA

55200112
55208723

MAGNETI MARELLI

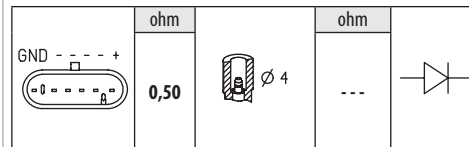
060717135012
060794001010
BAE 940 A

ALFA ROMEO

MITO 1.4 350A1.000,955A9.000 03/11 ⇨ 10/18

CHRYSLER

YPSILON 1.2 169A4.000 05/11 ⇨

FIAT

500 1.2	169A4.000	07/07 ⇨
500 1.2 LPG	169A4.000	12/10 ⇨
500 C 1.2	169A4.000	09/09 ⇨
PUNTO III EVO 1.2	169A4.000, 199A4.000	10/09 ⇨ 02/12
PUNTO III EVO 1.4	199A7000, 350A1.000	03/09 ⇨
PUNTO III EVO 1.4 LPG	350A1.000	06/09 ⇨ 02/12
PUNTO III EVO 1.4 Natural Power	350A1.000, 350A1000CNG	10/09 ⇨ 02/12
500 MY12 1.2	--	01/12 ⇨
PUNTO III 1.2	169A4.000, 199B9.000	03/12 ⇨
PUNTO III 1.4	199A7000, 350A1.000	03/12 ⇨
PUNTO III 1.4 Bifuel	350A1.000	03/12 ⇨
PUNTO III 1.4 Natural Power	350A1.000, 350A1000CNG	03/09 ⇨
FIORINO III 1.4	350A1.000	10/09 ⇨
FIORINO III 1.4 CNG	350A1000CNG	06/08 ⇨
FIORINO III 1.4 Natural Power	350A1.000, 350A1000CNG	06/08 ⇨
DOBLO I 1.4	350A1.000	10/05 ⇨
GRANDE PUNTO 1.4	350A1.000	02/06 ⇨ 06/13
GRANDE PUNTO 1.4 LPG	350A1.000	03/09 ⇨ 12/12
GRANDE PUNTO 1.4 Natural Power	350A1000CNG	03/09 ⇨ 12/12
PANDA III 1.2	169A4.000	02/12 ⇨
PANDA III 1.2 LPG	169A4.000	06/12 ⇨
IDEA 1.4	350A1.000	10/05 ⇨
IDEA 1.4 LPG	350A1.000	03/09 ⇨
LINEA 1.4	350A1.000	06/07 ⇨
PALIO 1.4	350A1.000, 834A1.000	10/02 ⇨
PANDA II 1.2	169A4.000	03/10 ⇨
PANDA II 1.2 4x4	169A4.000	04/10 ⇨
PANDA II 1.2 Euro 5	--	04/09 ⇨
PANDA II 1.2 LPG	169A4.000	09/10 ⇨
PANDA II 1.2 Natural Power	188A4000CNG	01/07 ⇨ 11/09
PANDA II 1.4 16V	--	01/10 ⇨
PANDA II 1.4 Natural Power	350A1.000, 350A1000CNG	10/09 ⇨

FIAT

PUNTO III / GRANDE PUNTO 1.2	169A4.000, 199A4.000	10/05 ⇨
PUNTO III / GRANDE PUNTO 1.2 (IND)	--	01/08 ⇨
PUNTO III / GRANDE PUNTO 1.2 Actual	--	09/09 ⇨
PUNTO III / GRANDE PUNTO 1.2 LPG	199A4.000	06/08 ⇨ 12/12
PUNTO III / GRANDE PUNTO 1.4	199A7000, 350A1.000	06/05 ⇨ 12/15
PUNTO III / GRANDE PUNTO 1.4 Actual	--	09/09 ⇨
PUNTO III / GRANDE PUNTO 1.4 LPG	350A1.000	12/08 ⇨
PUNTO III / GRANDE PUNTO 1.4 Natural Power	350A1.000, 350A1000CNG	07/08 ⇨
QUBO 1.4	350A1.000	10/09 ⇨
QUBO 1.4 Natural Power	350A1.000, 350A1000CNG	10/09 ⇨
500 MY15 1.2	--	01/15 ⇨
500 MY15 1.2 LPG	--	01/15 ⇨
SIENA 1.4	--	01/02 ⇨

FORD

KA II 1.2 169A4000, FP4 10/08 ⇨ 05/16

LANCIA

MUSA 1.4	350A1.000	09/05 ⇨ 09/12
MUSA 1.4 8V	--	01/11 ⇨ 12/12
MUSA 1.4 LPG	350A1.000	11/10 ⇨ 09/12
YPSILON II 1.2	169A4.000, 188A4.000	10/03 ⇨ 12/11
YPSILON II 1.4	350A1.000	02/06 ⇨ 12/11
YPSILON II 1.4 LPG	350A1.000	11/10 ⇨ 12/11
YPSILON III 1.2	169A4.000	05/11 ⇨
YPSILON III 1.2 Bi-fuel	169A4.000	05/11 ⇨

EPS 1.970.425



05,5

COILS

Adatt./Suitable:

BOSCH

0 986 221 054

VW

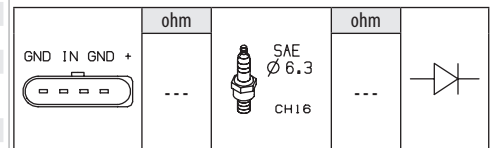
077 905 115 AA
077 905 115 G
077 905 115 J
077 905 115 M
077 905 115 R
077 905 115 S

VW

PHAETON 4.2 V8 4motion	BGH, BGJ	05/03 ⇨ 03/16
TOUAREG I 4.2 V8	AXQ	12/02 ⇨ 11/06

EPS 1.970.426



05,5

COILS

Adatt./Suitable:

AUDI

06F 905 115 C
06F 905 115 E
06F 905 115 F
06H 905 115
06H 905 115 A
06H 905 115 B
07K 905 715 A
07K 905 715 C
07K 905 715 D
07K 905 715 F
07K 905 715 G

BOSCH

0 221 604 115
0 221 604 116

HITACHI

133836
2503836

MAGNETI MARELLI

060717108012
060810196010

SEAT

06F 905 115 A
06F 905 115 B
06F 905 115 C
06F 905 115 E
06F 905 115 F
06H 905 115
06H 905 115 A
06H 905 115 B
07K 905 715 A
07K 905 715 B
07K 905 715 C
07K 905 715 D
07K 905 715 F
07K 905 715 G

SKODA

06F 905 115 C
06F 905 115 F
06H 905 115
06H 905 115 A
06H 905 115 B
07K 905 715 A
07K 905 715 B
07K 905 715 C
07K 905 715 D
07K 905 715 F
07K 905 715 G

VW

06F 905 115
06F 905 115 A
06F 905 115 B
06F 905 115 C
06F 905 115 E
06F 905 115 F
06H 905 115
06H 905 115 A
06H 905 115 B
07K 905 715
07K 905 715 A
07K 905 715 B
07K 905 715 C
07K 905 715 D
07K 905 715 E
07K 905 715 F
07K 905 715 G

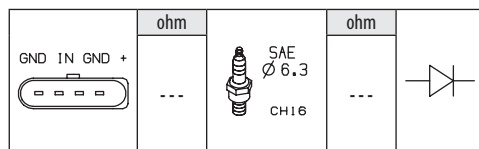

AUDI

A1 2.0 TFSI quattro	CDLH	03/12 ⇒ 11/12
A4 IV 1.8 TFSI	CABA, CABB, CDHA, CDHB	11/07 ⇒ 12/15
A4 IV 1.8 TFSI quattro	CDHB	09/08 ⇒ 03/12
A4 IV 2.0 TFSI	CAEA, CAEB, CAED, CDNB, CDNC, CFKA	06/08 ⇒ 12/15
A4 IV 2.0 TFSI flexible fuel	CFKA	11/09 ⇒ 12/15
A4 IV 2.0 TFSI flexible fuel quattro	CFKA	11/09 ⇒ 12/15
A4 IV 2.0 TFSI quattro	CAEB, CAED, CDNC, CFKA, CPMA, CPMB	06/08 ⇒ 12/15
A4 IV RS4 quattro	CPSA	05/12 ⇒ 08/15
A3 II 1.8 TFSI	BYT, BZB, CDAA	11/06 ⇒ 05/13
A3 II 1.8 TFSI quattro	CDAA	07/08 ⇒ 03/13
A3 II 2.0 FSI	AXW, BLR, BLX, BLY, BMB, BVY, BVZ	05/03 ⇒ 06/08
A3 II 2.0 TFSI	AXX, BPY, BWA, CAWB, CBFA, CCZA	09/04 ⇒ 05/13
A3 II 2.0 TFSI quattro	AXX, BPY, BWA, CCTA, CCZA	09/04 ⇒ 03/13

AUDI

A3 II RS3 quattro	CEPA	01/11 ⇒ 12/12
A3 II S3 quattro	BHZ, BZC, CDLA, CDLC	11/06 ⇒ 03/13
A3 III RS3 quattro	CZGB	03/15 ⇒
A4 III 2.0 TFSI	BGB, BPG, BPJ, BUL, BWE, BWT, BYK	11/04 ⇒ 06/08
A4 III 2.0 TFSI 16V	BWE, BWT	01/06 ⇒ 03/09
A4 III 2.0 TFSI quattro	BGB, BUL, BWE, BWT	11/04 ⇒ 03/09
A4 III RS4 quattro	BNS	09/05 ⇒ 12/08
A5 I 1.8 TFSI	CABD, CDHB	10/07 ⇒ 01/17
A5 I 2.0 TFSI	CAEA, CAEB, CAED, CDNB, CDNC	06/08 ⇒ 12/14
A5 I 2.0 TFSI quattro	CAEB, CAED, CDNC, CPMA, CPMB	06/08 ⇒ 01/17
A5 I RS5 quattro	CPSA	03/10 ⇒ 01/17
A4 IV ALLROAD 2.0 TFSI quattro	CDNC, CPMA, CPMB	04/09 ⇒ 05/16
A6 III 2.0 TFSI	BPJ, BYK	06/05 ⇒ 08/11
A6 IV 2.0 TFSI	CAEB, CAED, CDNB	03/11 ⇒
A6 IV 2.0 TFSI hybrid	CHJA	11/11 ⇒ 09/18
A6 IV 2.0 TFSI quattro	CAEB	05/12 ⇒ 05/13
A8 III 2.0 TFSI hybrid	CHJA	02/12 ⇒ 11/15
Q3 2.0 TFSI	CCTA	10/13 ⇒
Q3 2.0 TFSI quattro	CCTA, CCZC, CPSA	06/11 ⇒ 10/18
Q3 RS 2.5 quattro	CTSA, CZGA	05/13 ⇒ 10/18
Q3 RS performance 2.5 quattro	CZGB	01/15 ⇒ 10/18
Q5 I 2.0 Hybrid quattro	CHJA	09/12 ⇒ 05/16
Q5 I 2.0 TFSI	CDNA	11/08 ⇒
Q5 I 2.0 TFSI Hybrid quattro	CHJA	06/11 ⇒ 06/16
Q5 I 2.0 TFSI quattro	CAEB, CDNB, CDNC, CPMA, CPMB	11/08 ⇒ 05/17
Q5 I 2.0 TFSI quattro [CHN]	CADA	09/09 ⇒
R8 5.2 FSI quattro	CMPA	11/10 ⇒ 07/15
TT II 1.8 TFSI	CDAE	06/08 ⇒ 06/14
TT II 2.0 TFSI	BPY, BWA, CCTA, CESA	08/06 ⇒ 06/14
TT II 2.0 TFSI quattro	BWA, CCZA, CESA, CETA	06/08 ⇒ 06/14
TT II 2.0 TFSI quattro	CDLA, CDLB, CDMA	05/08 ⇒ 06/14
TT II 2.5 RS quattro	CEPA, CEPB	07/09 ⇒ 06/14

SEAT

ALTEA 1.8 TFSI	BYT, BZB, CDAA	01/07 ⇒
ALTEA 2.0 FSI	BLR, BLY, BVY, BVZ	05/04 ⇒ 03/09
ALTEA 2.0 TFSI	BWA	04/06 ⇒ 05/09
ALTEA XL 1.8 TFSI	BYT, BZB, CDAA	01/07 ⇒
ALTEA XL 2.0 FSI	BVY, BVZ	10/06 ⇒ 03/09
ALTEA XL 2.0 TFSI	BWA, CCZB	10/06 ⇒
ALTEA XL 2.0 TFSI 4x4	BWA, CCZB	06/07 ⇒
EXEO 1.8 TFSI	CDHA, CDHB	05/10 ⇒ 05/13
EXEO 2.0 TFSI	BWE, CDND	03/09 ⇒ 05/13
ALHAMBRA III 1.8 TFSI	CDAA	11/12 ⇒
ALHAMBRA III 2.0 TFSI	CCZA	11/10 ⇒ 05/12
LEON II 1.8 TFSI	BZB, CDAA	06/07 ⇒ 12/12
LEON II 2.0 Cupra R	CDLA	09/09 ⇒ 12/12
LEON II 2.0 FSI	BLR, BLY, BVY, BVZ	07/05 ⇒ 05/10
LEON II 2.0 TFSI	BWA, BWJ, CDLD	05/05 ⇒ 05/11
TOLEDO III 1.8 TFSI	BYT, BZB, CDAA	01/07 ⇒ 05/09
TOLEDO III 2.0 FSI	BLR, BLY, BVY, BVZ	10/04 ⇒ 05/09
TOLEDO III 2.0 TFSI	BWA	11/05 ⇒ 05/09

SKODA

OCTAVIA II 1.8 TFSI	BZB, CDAA, CDAB	06/07 ⇒ 06/13
OCTAVIA II 1.8 TFSI 4x4	CDAA, CDAB	11/08 ⇒ 02/13
OCTAVIA II 2.0 4x4	CCZA	11/08 ⇒
OCTAVIA II 2.0 FSI	BLR, BLY, BVY, BVZ	11/04 ⇒ 10/08
OCTAVIA II 2.0 FSI 4x4	BLX, BLY, BVX	11/04 ⇒ 04/09
OCTAVIA II 2.0 TFSI	BWA, CCZA	10/05 ⇒ 02/13
SUPERB II 1.8 TFSI	BZB, CDAA, CDAB	03/08 ⇒ 05/15
SUPERB II 1.8 TFSI 4x4	CDAA, CDAB	11/08 ⇒ 05/15
SUPERB II 2.0 TFSI	CCZA	05/10 ⇒ 05/15
YETI 1.2 TFSI	CBZB	09/09 ⇒ 05/15
YETI 1.8	CDAB	02/11 ⇒
YETI 1.8 TFSI 4x4	CDAA, CDAB	05/09 ⇒ 12/17

VW

AMAROK 2.0 TSI	CFPA	12/10 ⇒ 10/16
GOLF VI 1.8 TFSI	CDAA	06/09 ⇒ 01/11
GOLF VI 2.0	CDLF	05/11 ⇒
GOLF VI 2.0 GTi	CBFA, CCTA, CCZB, CDLG	02/09 ⇒ 05/16
GOLF VI 2.0 R	CDLA	01/13 ⇒ 05/16
GOLF VI 2.0 R 4motion	CDLC, CDLF	11/09 ⇒ 11/13
GOLF VI 2.0 TFSI	CCZA	07/09 ⇒
GOLF VI 2.0 TFSI Gti	CBFA, CCTA, CCZB, CDLG	05/11 ⇒
GOLF VI 2.0 TFSI	CDLC	01/13 ⇒
GOLF VI 2.0 TFSI R 4motion	CDLF	11/09 ⇒ 11/12
GOLF VI 2.5	CBTA, CBUA	07/09 ⇒
BEETLE 2.0 TFSI	CBFA, CCTA, CCZA	04/11 ⇒ 07/16
BEETLE 2.5	CBTA, CBUA, CCA	04/11 ⇒ 07/19
GOLF V 2.0 FSI	AXW, BLR, BLX, BLY, BVX, BVY, BVZ	01/04 ⇒ 11/08
GOLF V 2.0 FSI 4motion	BLX, BVX	08/04 ⇒ 11/08
GOLF V 2.0 GTI	AXX, BPY, BWA, BYD, CAWB, CBFA	10/04 ⇒ 02/09
GOLF V 2.0 TFSI	BWA, CAWB	06/07 ⇒ 07/09

VW

GOLF V 2.5	CBTA, CBUA	05/07 ⇒ 11/08
CALIFORNIA 2.0 TSI	CJKA, CJKB	05/11 ⇒ 07/19
CALIFORNIA 2.0 TSI 4motion	CJKA	07/11 ⇒ 07/19
CAMPMOBILE 2.0 TFSI	CJKA, CJKB	05/11 ⇒ 08/15
CAMPMOBILE 2.0 TFSI BlueMotion	CJKA, CJKB	04/15 ⇒ 07/19
CC 1.8 TSI	CDAE, CDAB	11/11 ⇒ 12/16
CC 2.0 TFSI	CBFA, CCTA	11/11 ⇒ 12/16
CC 2.0 TFSI	CBFA, CCTA, CCZB	11/11 ⇒
EOS 2.0 FSI	BVY, BVZ	03/06 ⇒ 05/08
EOS 2.0 TFSI	BPY, BWA, CAWB, CBFA, CCTA, CCZA	03/06 ⇒ 08/15
EOS 2.0 TFSI	CCZB	11/09 ⇒ 08/15
JETTA V 2.0 FSI	BLR, BLY, BVY, BVZ	08/05 ⇒ 10/10
JETTA V 2.0 TFSI	BPY, BWA, CAWB, CBFA, CCTA, CCZA	10/05 ⇒ 10/10
JETTA V 2.5	BGP, BGQ, BTK, CBTA, CCZA	01/05 ⇒
PASSAT V 1.8 TFSI	BZB, CDAA, CDAB, CGYA	05/07 ⇒ 12/14
PASSAT V 2.0 FSI	BLR, BLY, BVY, BVZ, CCTB	03/05 ⇒ 11/10
PASSAT V 2.0 FSI 4motion	BLX, BLY, BVX	09/05 ⇒ 11/10
PASSAT V 2.0 TFSI	AXX, BPY, BWA, CAWB	07/05 ⇒ 11/10
PASSAT V 2.0 TFSI	CCZB	11/10 ⇒ 12/15
PASSAT V 2.0 TFSI 4motion	CCZB	01/12 ⇒ 12/14
PASSAT V 2.5 SRE	CBTA, CBUA, CCA	01/11 ⇒
JETTA VI 2.0 TFSI	CBFA, CCTA, CCZA	12/10 ⇒
JETTA VI 2.5	CBTA, CBUA, CCA	04/10 ⇒
MULTIVAN 2.0 TFSI	CJKA, CJKB	05/11 ⇒ 07/19
MULTIVAN 2.0 TFSI 4motion	CJKA	07/11 ⇒ 07/19
NEW BEETLE 2.5	BPR, BPS	07/05 ⇒ 09/10
POLO V 2.0 R WRC	CDLJ	08/13 ⇒ 05/14
PASSAT 1.8 TFSI	CDAA	08/10 ⇒ 12/14
PASSAT 2.0 TFSI	CCZB	11/10 ⇒ 12/14
SCIROCCO III 2.0 R	CDLA, CDLC, CDLK	11/09 ⇒ 11/17
SCIROCCO III 2.0 TFSI	CAWB	05/08 ⇒ 05/14
SCIROCCO III 2.0 TFSI	CCZB	11/09 ⇒ 11/17
SHARAN II 1.8 TFSI	CDAA	11/11 ⇒
SHARAN II 2.0 TFSI	CCZA	12/10 ⇒ 11/15
SHARAN II 2.0 TFSI	CCZA	12/10 ⇒ 11/15
PASSAT CC 1.8 TFSI	BZB, CDAA, CDAB, CGYA	06/08 ⇒ 01/12
PASSAT CC 2.0 TFSI	CAWB, CBFA, CCTA, CCZA	06/08 ⇒ 01/12
PASSAT CC 2.0 TFSI	CCZB	11/10 ⇒ 01/12
TIGUAN I 2.0 TFSI	CAWB, CCTA, CCTB	11/07 ⇒
TIGUAN I 2.0 TFSI 4motion	CAWA, CAWB, CCTA, CCTB, CCZA, CCZC	09/07 ⇒ 07/18
TIGUAN I 2.0 TFSI 4motion	CCZA, CCZB, CCZC, CCZD	11/09 ⇒ 07/18
TOUAREG I 4.2 V8 FSI	BAR	06/06 ⇒ 05/10
TOURAN I 2.0 FSI	AXW, BLR, BLX, BLY, BVY, BVZ	10/03 ⇒ 01/07
TRANSPORTER V 2.0 TFSI	CJKA, CJKB	05/11 ⇒ 08/15
TRANSPORTER V 2.0 TFSI 4motion	CJKA	07/11 ⇒ 08/15
TRANSPORTER VI 2.0 TFSI	CJKA, CJKB	04/15 ⇒ 07/19
TRANSPORTER VI 2.0 TFSI 4motion	CJKA	06/15 ⇒ 07/19

EPS 1.970.427

05,5

COILS

Adatt./Suitable:

AUDI

06D 905 115
06D 905 115 A
06D 905 115 C
06D 905 115 D
06D 905 115 F
06D 905 115 G
06D 905 115 J
06D 905 115 K
06E 905 115
06E 905 115 A
06E 905 115 B
06E 905 115 C
06E 905 115 D
06E 905 115 E
06E 905 115 F
06E 905 115 G
07L 905 115
07L 905 115 A
07L 905 115 B

BOSCH

0 221 604 800

HITACHI

133831
2503831
2503835

MAGNETI MARELLI

060717175012

PORSCHE

958 602 102 00

VW

06D 905 115
06D 905 115 A
06D 905 115 C
06D 905 115 D
06D 905 115 F
06D 905 115 G
06D 905 115 K
06E 905 115
06E 905 115 A
06E 905 115 B
06E 905 115 C
06E 905 115 D
06E 905 115 E
06E 905 115 F
06E 905 115 G

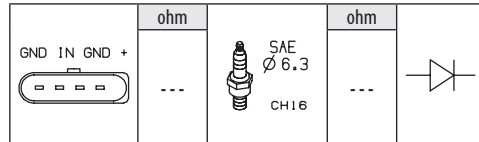

AUDI

A4 IV 3.0 TFSI quattro	CMUA, CRED	02/12 ⇒ 12/15
A4 IV 3.2 FSI	CALA	09/08 ⇒ 03/12
A4 IV 3.2 FSI quattro	CALA	11/07 ⇒ 03/12
A4 IV S4 quattro	CAKA, CCBA, CGWC, CGXC, CREC, CTUB	11/08 ⇒ 12/15
A4 II 2.0 FSI	AWA	07/02 ⇒ 12/04
A4 III 3.2 FSI	AUK	01/05 ⇒ 03/09
A4 III 3.2 FSI quattro	AUK, BKH	01/05 ⇒ 03/09
A5 I 3.0 TFSI quattro	CHMB, CMUA, CRED	08/11 ⇒
A5 I 3.2 FSI	CALA	06/07 ⇒ 03/12
A5 I 3.2 FSI quattro	CALA	06/07 ⇒ 03/12
A5 I S5 quattro	CAKA, CAUA, CCBA, CGWC, CGXC, CREC, CTDA, CTUB	06/07 ⇒ 01/17
A6 III 2.4	BDW	05/04 ⇒ 10/08
A6 III 2.4 [CHN]	BDW	04/05 ⇒
A6 III 2.4 quattro	BDW	01/05 ⇒ 10/08
A6 III 2.8 FSI	BDX, CCDA, CCEA	11/06 ⇒ 08/11
A6 III 2.8 FSI quattro	BDX, CCDA, CCEA	06/07 ⇒ 08/11
A6 III 3.0 TFSI quattro	CAJA, CCAA	10/08 ⇒ 08/11
A6 III 3.2 FSI	AUK, BKH, CALA	05/04 ⇒ 03/11
A6 III 3.2 FSI quattro	AUK, BKH, BYU	05/04 ⇒ 10/08
A6 III 4.2 FSI quattro	BVJ	05/06 ⇒ 08/11
A6 III RS6 quattro	BUH	04/08 ⇒ 08/10
A6 III S6 quattro	BXA	03/06 ⇒ 08/11
A6 IV 2.8 FSI	CHVA	11/10 ⇒ 04/15
A6 IV 2.8 FSI quattro	CHVA, CVPA	11/10 ⇒ 09/18
A6 IV 3.0 TFSI	CREH	09/14 ⇒
A6 IV 3.0 TFSI quattro	CGWB, CGWD, CGXB, CREC, CREH, CTUA	11/10 ⇒ 09/18
A7 SPORTBACK 2.0 TFSI quattro	CYNB	05/15 ⇒ 05/18

AUDI

A7 SPORTBACK 2.5 FSI	CLXB	05/12 ⇒
A7 SPORTBACK 2.8 FSI	CHVA	02/11 ⇒ 03/15
A7 SPORTBACK 2.8 FSI quattro	CHVA, CNYA, CVPA	10/10 ⇒ 05/18
A7 SPORTBACK 2.8 TFSI	CVPA	09/14 ⇒
A7 SPORTBACK 3.0 TFSI	CREH	05/14 ⇒
A7 SPORTBACK 3.0 TFSI quattro	CGWB, CGWD, CGXB, CHMA, CREC, CTTA, CTUA	10/10 ⇒ 05/18
A8 II 2.8 FSI	BDX, CJBA	08/07 ⇒ 07/10
A8 II 3.2 FSI	BPK	06/05 ⇒ 07/10
A8 II 3.2 FSI quattro	BPK	06/05 ⇒ 07/10
A8 II 4.2 FSI quattro	BVJ	06/06 ⇒ 07/10
A8 II S8 quattro	BSM	06/06 ⇒ 07/10
Q7 I 3.0 TFSI quattro	CREC	01/15 ⇒ 12/19
A8 III 2.5 TFSI	CPAA, CVBA	07/12 ⇒ 06/16
A8 III 3.0 TDI quattro	CPNA, CPNB	11/12 ⇒ 06/16
A8 III 3.0 TFSI quattro	CGWA, CGWD, CGXC, CMDA, CREA, CREC, CREG, CTDA, CTUB	06/10 ⇒ 01/18
A8 III 4.2 FSI quattro	CDRA	11/09 ⇒ 12/12
Q5 I 3.0 TFSI quattro	CTUC, CTVA	06/12 ⇒ 05/17
Q5 I 3.2 FSI quattro	CALB	11/08 ⇒ 12/12
Q5 I SQ5 TFSI quattro	CTUD, CTXA	05/13 ⇒ 05/17
Q7 I 3.0 TFSI quattro	CJTB, CJTC, CJWB, CJWC, CJWE, CNA, CTWA, CTWB	05/10 ⇒ 08/15
Q7 I 4.2 FSI quattro	BAR	03/06 ⇒ 05/10
Q7 I 4.2 quattro	BAR	03/06 ⇒ 12/10
R8 4.2 FSI quattro	BYH, CNDA	04/07 ⇒ 07/15
R8 5.2 FSI	CTPA, CTPB, DKAB, DKAC	07/12 ⇒
R8 5.2 FSI quattro	BUJ, CSP, CSPB, CTPA, CTPB, CTYA, DKAA, DKAC, DMWA	04/09 ⇒

PORSCHE

CAYENNE 3.0 S Plug-in Hybrid Supercharged	MCG.EA, MCG.FA	01/15 ⇒
CAYENNE II 3.0 S E-Hybrid	M06.EC, MCG.EA, MCG.FA	10/14 ⇒
PANAMERA 3.0 S E-Hybrid	MCG.EA, MCG.FA	03/11 ⇒ 10/16

VW

TOUAREG I 4.2 V8	AXQ	12/02 ⇒ 11/06
TOUAREG I 4.2 V8 FSI	BAR	06/06 ⇒ 05/10
TOUAREG II 3.0 TFSI	CYJA	01/15 ⇒
TOUAREG II 3.0 V6 TSI	CJTA	08/10 ⇒ 03/18
TOUAREG II 3.0 V6 TSI Hybrid	CGEA, CGFA	04/10 ⇒ 03/18
TOUAREG II 4.2 V8 FSI	CGNA	01/11 ⇒ 03/18

EPS

1.970.429

05,5

COILS

Adatt./Suitable:

AUDI

06A 905 115
06A 905 115 A
06A 905 115 B
06A 905 115 C
06A 905 115 D
06B 905 115 D
06B 905 115 D
06B 905 115 G
06B 905 115 H
06B 905 115 J
06B 905 115 L
06B 905 115 M
06B 905 115 N
06B 905 115 P
06B 905 115 Q
06B 905 115 R
06B 905 115 S
06C 905 115 C

BOSCH

0 986 221 024

HITACHI

133806
2503806

MAGNETI MARELLI

060717053012

SEAT

06A 905 115
06A 905 115 A
06A 905 115 B
06A 905 115 C
06A 905 115 D
06B 905 115 D
06B 905 115 G
06B 905 115 H
06B 905 115 J
06B 905 115 L
06B 905 115 M
06B 905 115 N
06B 905 115 P
06B 905 115 Q
06B 905 115 R
06C 905 115 C

SKODA

06A 905 115
06A 905 115 A
06A 905 115 B
06A 905 115 C
06A 905 115 D
06B 905 115 D
06B 905 115 G
06B 905 115 H
06B 905 115 J
06B 905 115 L
06B 905 115 M
06B 905 115 N
06B 905 115 P
06B 905 115 Q
06B 905 115 R
06C 905 115 C

VW

06A 905 115
06A 905 115 A
06A 905 115 B
06A 905 115 C
06A 905 115 D
06B 905 115 D
06B 905 115 G
06B 905 115 H
06B 905 115 J
06B 905 115 L
06B 905 115 M
06B 905 115 N
06B 905 115 P
06B 905 115 Q
06B 905 115 R
06B 905 115 S
06C 905 115 C

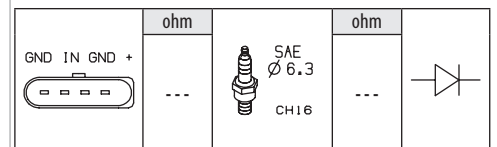

AUDI

A3 I 1.8 T	AGU, ARY, AUM, AUQ	12/96 ⇒ 05/03
A3 I 1.8 T quattro	ARX, ARY	12/96 ⇒ 05/03
A3 I S3 quattro	AMK, APY, AUL, BAM	10/01 ⇒ 05/03
A4 II 1.8 T	AMB, AVJ, BEX, BFB	11/00 ⇒ 12/04
A4 II 1.8 T quattro	AMB, AVJ, BEX, BFB	11/00 ⇒ 12/04
A4 III 1.8 T	BFB	07/02 ⇒ 03/09
A4 III 1.8 T quattro	BFB	05/03 ⇒ 06/08
A4 III 2.0	ALT	11/04 ⇒ 06/08
A4 I 1.8 T	AWT	01/95 ⇒ 09/01
A4 I 1.8 T quattro	AWT	01/95 ⇒ 11/00
A6 II 1.8 T	AWT	01/97 ⇒ 01/05
A6 II 1.8 T quattro	AWT	02/97 ⇒ 01/05

1.970.431

AUDI		
A6 II 2.7 T quattro	1457L77	08/01 ⇒ 01/05
ALLROAD 2.7 T quattro	1457L77, ARE	05/00 ⇒ 08/05
TT 1.8 T	AJQ, APP, ATC, AUM, AUQ, BVP, BVR	01/01 ⇒ 06/06
TT 1.8 T quattro	AJQ, APX, ARY, ATC, AUQ, BAM, BFV, BVR	02/00 ⇒ 06/06

SEAT		
EXEO 1.6	ALZ	03/09 ⇒ 09/10
EXEO 1.8 T	CFMA	12/08 ⇒ 05/10
IBIZA III 1.8 T 20V Cupra	AYP	07/00 ⇒ 02/02
IBIZA III 1.8 T Cupra R	BBU, BLZ	01/04 ⇒ 02/08
IBIZA III 1.8 T FR	BJX, BKV	12/03 ⇒ 05/08
LEON I 1.8 20V T	AUQ	11/99 ⇒ 06/06
LEON I 1.8 20V T 4	ARY	11/99 ⇒ 06/06
LEON I 1.8 T Cupra R	AMK, BAM	02/02 ⇒ 06/06
LEON I 1.8 Turbo 4x4	AMK	05/02 ⇒ 05/03
TOLEDO II 1.8 20VT	APP	09/00 ⇒ 07/04

SKODA		
SUPERB I 1.8 T	AWT	12/01 ⇒ 03/08
OCTAVIA I 1.8 T	ARZ	08/97 ⇒ 12/10
OCTAVIA I 1.8 T 4x4	ARX	05/01 ⇒ 05/06
OCTAVIA I RS 1.8 T	AUQ	05/01 ⇒ 01/06

VW		
BORA 1.8 T	AUM, AUQ	05/00 ⇒ 05/05
GOLF IV 1.8 T	AUM	08/97 ⇒ 06/06
GOLF IV 1.8 T GTI	AUQ	08/01 ⇒ 06/05
POLO IV 1.8 GTI	BJX	09/05 ⇒ 11/09
POLO IV 1.8 GTI Cup Edition	BBU	05/06 ⇒ 11/09
NEW BEETLE 1.8 T	AGU, APH, AVC, AWP, AWU, AWW, BKF, BNU	11/01 ⇒ 09/10
PASSAT IV 1.8 [CHN]	AWL, BGC, CED	06/01 ⇒
PASSAT IV 1.8 4motion	AWM	03/01 ⇒ 05/05
PASSAT IV 1.8 T	AWM	02/01 ⇒ 11/05
PASSAT IV 1.8 T 20V	AWL, AWT	11/00 ⇒ 05/05
PASSAT IV 1.8 T 4motion	AWM	11/03 ⇒ 05/05
PASSAT IV 2.0	ALT	11/01 ⇒ 05/05

EPS 1.970.431



05,5

COILS

Adatt./Suitable:

BOSCH
 0 986 221 047

HITACHI
 133812
 2503812

MAGNETI MARELLI
 060717130012
 060810167010

SEAT
 03D 905 115 F
 03D 905 115 G
 03D 905 715 A

SKODA
 03D 905 115
 03D 905 115 A
 03D 905 115 B
 03D 905 115 C
 03D 905 115 D
 03D 905 115 E
 03D 905 115 F
 03D 905 115 G
 03D 905 715 A

VW
 03D 905 115
 03D 905 115 A
 03D 905 115 B
 03D 905 115 C
 03D 905 115 D
 03D 905 115 E
 03D 905 115 F
 03D 905 115 G
 03D 905 715 A

GND IN GND +	ohm	SAE Ø 6.3 CH16	ohm	
...	

SEAT		
IBIZA III 1.2	BBM	06/07 ⇒ 05/08
SKODA		
FABIA I 1.2	AWY, BMD	07/01 ⇒ 12/07
FABIA II 1.2	BBM, CHFA	12/06 ⇒ 12/14

SKODA		
FABIA II 1.2 LPG	CHFA	03/09 ⇒ 11/11
VW		
FOX 1.2	BMD, CHFA, CHFB	04/05 ⇒ 12/11
POLO IV 1.2	AWY, BBM, BMD	01/02 ⇒ 11/09

EPS 1.970.432



05,5

COILS

Adatt./Suitable:

BOSCH
 0 986 221 001
 0 986 221 045

DACIA
 22 43 325 97R
 22 43 335 29R
 77 00 107 177
 77 00 113 357
 82 00 208 611
 82 00 380 267
 82 00 405 098
 82 00 568 671
 82 00 765 882

DENSO
 029700-8240
 029700-8291

GENERAL MOTORS
 91 159 920
 91 159 996
 93 161 188
 93 161 948

HITACHI
 133800

LADA
 82 00 765 882

MAGNETI MARELLI
 060717035012
 060810070010

NISSAN
 22433-3529R
 22448-00A0C
 22448-00Q0A
 22448-00Q0B
 22448-00Q0C
 22448-00Q0G
 22448-00QAA
 22448-00QAB
 22448-00QAE
 22448-00QAH
 77001-07177
 82006-72564

OPEL

 44 08 283
 44 08 389
 44 13 233
 44 32 202
 91159996
 93161188
 93161948

RENAULT

 22 43 325 97R
 22 43 335 29R
 77 00 107 177
 77 00 113 357
 77 00 113 357 A
 77 00 875 000
 82 00 035 420
 82 00 154 186
 82 00 154 186 A
 82 00 208 611
 82 00 380 267
 82 00 405 098
 82 00 568 671
 82 00 672 564
 82 00 765 882
 89 00 568 671
 H77 00 875 000

SAGEM
 2 526 180 A
 21595273-2

VAUXHALL
 91159996
 93161188
 93161948

- +	ohm		ohm
	0,50		6700

DACIA		
DUSTER 1.6	K4M642, K4M646, K4M694, K4M842, K4M884	04/10 ⇒
DUSTER 1.6 16V	K4M490, K4M606, K4M616, K4M694, K4M696, K4M842, K4M896	04/10 ⇒
DUSTER 1.6 16V 4x4	K4M490, K4M606, K4M646, K4M690	06/10 ⇒

DACIA		
DUSTER 1.6 16V Hi-Flex	K4M696	08/10 ⇒
DUSTER 1.6 16V LPG	K4M616, K4M642, K4M696	04/11 ⇒ 01/18
DUSTER 2.0	F4R400, F4R401, F4R402, F4R403, F4R404, F4R405, F4R408, F4R410, F4R412, F4R414, F4R416	04/10 ⇒
LODGY 1.6	K4M845	03/12 ⇒
LOGAN I 1.6 16V	K4M690, K4M694, K4M696, K4M697, K4M698	12/05 ⇒
LOGAN I 1.6 16V Flexifuel	K4M696	07/10 ⇒
LOGAN I 1.6 16V Hi-Flex	K4M690, K4M696	11/09 ⇒
LOGAN II 1.6 16V	K4M842, K4M845	10/12 ⇒
LOGAN II 2.0	F4R412, F4R416	10/12 ⇒
SANDERO I 1.6 16V	K4M690, K4M694	07/11 ⇒
SANDERO I 1.6 16V Bifuel	K4M690, K4M696	01/11 ⇒
SANDERO II 1.6 16V	K4M842, K4M845	01/13 ⇒
SANDERO II 2.0	F4R416	10/12 ⇒
SANDERO II 2.0 LPG	F4R412	10/12 ⇒

LADA		
LARGUS 1.6	21129, K4M	03/12 ⇒

NISSAN		
ALMERA 1.6	K4M	11/12 ⇒
KUBISTAR 1.6 16V	K4M750, K4M752, K4M753, K4M753	08/03 ⇒
PRIMASTAR 2.0	F4R720, F4R722, F4R820, F4R726	03/01 ⇒
TERRANO III 1.6	K4M, K4M606, K4M690	09/13 ⇒
TERRANO III 1.6 4x4	K4M606, K4M690	03/14 ⇒
TERRANO III 2.0	F4R	09/13 ⇒
TERRANO III 2.0 4x4	F4R	03/14 ⇒

OPEL		
VIVARO A 2.0 16V	F4R720	08/01 ⇒ 07/06
VIVARO A 2.0 ECOTEC	F4R820	08/06 ⇒ 07/14

RENAULT

AVANTIME 2.0 16V Turbo	F4R760, F4R761	11/01 ⇒ 05/03
CLIO II 1.4 16V	K4J700, K4J710, K4J711, K4J712, K4J713, K4J715	02/00 ⇒
CLIO II 1.6	K4M746	11/03 ⇒
CLIO II 1.6 16V	K4M708, K4M734, K4M740, K4M742, K4M743, K4M744, K4M745, K4M746, K4M748	09/98 ⇒

CLIO II 1.6 Hi-Flex	K4M748	01/05 ⇒ 02/10
CLIO II 1.6i	K4M736	11/04 ⇒
CLIO II 2.0 16V	F4R732	06/01 ⇒
CLIO III 1.4 16V	K4J780	06/05 ⇒ 12/12
CLIO III 1.6 16V	K4M800, K4M801, K4M804, K4M862	06/05 ⇒ 12/14

CLIO III 1.6 16V GT	K4M862	06/09 ⇒ 12/14
CLIO III 2.0 16V Sport	--, F4R830, F4R832	02/06 ⇒
MEGANE III 1.6 16V	K4M848, K4M858, K4M866	11/08 ⇒

MEGANE III 1.6 16V BiFuel	K4M858	11/08 ⇒
MEGANE III 1.6 16V Hi-Flex	K4M866	11/08 ⇒ 08/15
MEGANE III 1.6 BiFuel	K4M866	11/08 ⇒
MEGANE III 2.0 R.S.	F4R874	11/08 ⇒
MEGANE III 2.0 TCe	F4R872, F4R870, F4R874	11/08 ⇒
MEGANE III 2.0 TCe 220	F4R874	11/13 ⇒

KANGOO II 1.6	K4M830, K4M831	02/09 ⇒ 12/12
KANGOO II 1.6 16V	K4M830, K4M831, K4M834, K4M835, K4M836	02/08 ⇒

KANGOO II 1.6 16V FLEX	K4M834	02/08 ⇒
KANGOO II 1.6 16V LPG	K4M834, K4M835, K4M836	02/08 ⇒

CLIO 1.6	K4M734	07/00 ⇒ 10/03
DUSTER 1.6 16V	K4M616	02/12 ⇒
DUSTER 1.6 16V 4x4	K4M490, K4M606, K4M646, K4M690	06/11 ⇒ 05/15

DUSTER 2.0	F4R403, F4R405	02/12 ⇒
DUSTER 2.0 4x4	F4R400, F4R402, F4R410, F4R412, F4R401	10/11 ⇒

ESPACE III 2.0	F4R700, F4R701	09/01 ⇒ 10/02
ESPACE III 2.0 16V	F4R700, F4R701	10/98 ⇒ 10/02
ESPACE IV 2.0	F4R790, F4R792, F4R794, F4R795, F4R796, F4R797, F4R896, F4R897	11/02 ⇒

ESPACE IV 2.0 Turbo	F4R794, F4R795, F4R796, F4R797	11/02 ⇒
---------------------	--------------------------------	---------

FLUENCE 1.6 16V	K4M838, K4M839	02/10 ⇒
FLUENCE 1.6 LPG 16V	K4M839	01/12 ⇒
GRAND SCÉNIC II 1.6	K4M761, K4M764, K4M782, K4M788, K4M812, K4M813	04/04 ⇒ 11/08

GRAND SCÉNIC II 1.6 Flex	K4M766	06/06 ⇒ 06/09
GRAND SCÉNIC II 2.0	F4R770, F4R771, F4R776	04/04 ⇒ 06/09
MEGANE II 1.4	K4J730, K4J732, K4J740	08/03 ⇒
MEGANE II 1.4 16V	K4J730, K4J732, K4J740	11/02 ⇒ 02/08
MEGANE II 1.6	K4M760, K4M761, K4M762, K4M768, K4M788, K4M812, K4M813, K4M680	08/03 ⇒

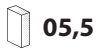

RENAULT		
MEGANE II 1.6 16V	K4M760, K4M761, K4M762, K4M764, K4M768, K4M812, K4M813, K4M856	11/02 →
MEGANE II 1.6 16V Hi-Flex	K4M856	02/08 → 07/09
MEGANE II 1.6 BiFuel	K4M788	06/05 → 02/08
MEGANE II 1.6 Flex-Fuel	K4M856	01/07 → 02/08
MEGANE II 1.6 LPG 16V	K4M760	01/06 → 08/09
MEGANE II 2.0	F4R770, F4R771, F4R774	08/03 →
MEGANE II 2.0 16V	F4R770, F4R771	11/02 → 02/08
MEGANE II 2.0 16V Turbo	F4R776	05/04 → 03/09
MEGANE II 2.0 Renault Sport	F4R774, F4R774	05/04 → 10/09
GRAND SCÉNIC III 1.6 16V	K4M858	02/09 →
GRAND SCÉNIC III 1.6 16V BiFuel	K4M866	02/09 →
GRAND SCÉNIC III 1.6 E85	K4M866	02/09 →
KANGOO 1.6	K4M836	03/13 →
KANGOO 1.6 BiFuel	K4M750	06/05 → 06/08
KANGOO 1.6 CNG	K4M830	10/07 →
KANGOO I 1.6	K4M730	09/01 →
KANGOO I 1.6 16V	K4M708, K4M730, K4M732, K4M750, K4M752, K4M753, K4M754	06/01 →
KANGOO I 1.6 16V 4x4	K4M708, K4M750, K4M752, K4M753, K4M754	02/01 →
KANGOO I 1.6 16V bivalent	K4M850CNG	06/05 →
KANGOO I 1.6 Flex	K4M850	03/07 → 12/18
KAPTUR 2.0 4WD	F4R410	03/16 →
LAGUNA I 1.6 16V	K4M720, K4M724	11/97 → 03/01
LAGUNA I 1.8 16V	F4P760	04/98 → 03/01
LAGUNA I 2.0	F4R780	09/99 → 02/01
LAGUNA I 2.0 16V	F4R780	09/99 → 03/01
LAGUNA II 1.6	K4M710	03/01 → 10/05
LAGUNA II 1.6 16V	K4M710, K4M714, K4M716	03/01 → 12/07
LAGUNA II 1.6 BiFuel	K4M714	06/05 → 12/07
LAGUNA II 1.6 LPG	K4M714	03/01 → 05/05
LAGUNA II 1.8 16V	F4P770, F4P771, F4P772, F4P773, F4P774, F4P775	03/01 →
LAGUNA II 2.0 16V	F4R712, F4R713, F4R714, F4R715, F4R784, F4R786, F4R787, F4R886, F4R887	08/02 → 12/07
LAGUNA II 2.0 16V Turbo	F4R764, F4R765, F4R786, F4R787	01/03 → 08/05
LAGUNA III 1.6 16V	K4M824	10/07 → 12/15
LAGUNA III 2.0	F4R813	02/08 →
LAGUNA III 2.0 16V Turbo	F4R811, F4R813	10/07 → 12/15
LAGUNA III 2.0 GT	F4R800, F4R802	03/08 → 12/15
LOGAN 1.6	K4M690, K4M694, K4M696, K4M697, K4M845	04/07 →
LOGAN 1.6 16V	K4M694	12/05 →
LOGAN/STEPWAY 1.6	K4M842, K4M845	04/14 →
MEGANE 1.4	K4J714, K4J750	04/01 → 07/03
MEGANE 1.6	K4M701, K4M708, K4M709, K4M700	04/01 → 07/03
MEGANE 1.6 BiFuel	K4M704, K4M712	04/01 → 07/03
MEGANE 1.8	F4P722	04/01 → 07/03
MEGANE 2.0	F4R740, F4R746	08/95 → 02/99
MEGANE I 1.4 16V	K4J700, K4J710, K4J711, K4J712, K4J713, K4J714, K4J732, K4J750	03/99 → 08/03
MEGANE I 1.6 16V	K4M701, K4M704, K4M706, K4M708, K4M709, K4M710, K4M712, K4M714, K4M720, K4M724, K4M730, K4M734, K4M740, K4M742, K4M743, K4M744	05/00 →
MEGANE I 1.6 BiFuel	K4M712	03/99 → 09/00
MEGANE I 1.6 LPG	K4M704, K4M712	10/00 → 08/02
MEGANE I 1.8 16V	F4P720, F4P722, F4P760, F4P770, F4P771, F4P772, F4P774, F4P775	07/00 → 08/03
MEGANE I 2.0 16V	F4R276, F4R700, F4R701, F4R712, F4R713, F4R720, F4R730, F4R732, F4R736, F4R746, F4R760, F4R761, F4R762, F4R763, F4R767, F4R770	05/00 →
MEGANE I 2.0 RT	F4R740, F4R741, F4R746, F4R747	03/01 → 08/03
MEGANE SCÉNIC I 1.6 16V	K4M701, K4M704, K4M708, K4M700	04/98 → 10/99
MODUS / GRAND MODUS 1.4	K4J770, K4J780	12/04 →
MODUS / GRAND MODUS 1.6	K4M790, K4M791, K4M792, K4M794, K4M800, K4M801	12/04 →
SANDERO I 1.6	K4M697	12/07 →
SANDERO II 1.6 16V	K4M842, K4M845	04/14 →
SCÉNIC I 1.4 16V	K4J714, K4J750	09/99 → 08/03
SCÉNIC I 1.6	K4M701, K4M706, K4M707, K4M708, K4M709, K4M776, K4M700	03/01 → 09/03
SCÉNIC I 1.6 16V	K4M712	05/00 → 08/03
SCÉNIC I 1.6 BiFuel	K4M704, K4M712	03/01 → 08/03
SCÉNIC I 1.8 16V	F4P720, F4P722	01/01 → 08/03

RENAULT		
SCÉNIC I 1.8 4x4	F4P722	07/00 → 04/01
SCÉNIC I 2.0 16V	F4R740, F4R741, F4R744, F4R746, F4R747	07/00 → 08/03
SCÉNIC I 2.0 16V RX4	F4R744, F4R746	06/00 → 08/03
SCÉNIC II 1.4	K4J730, K4J740	06/03 → 11/08
SCÉNIC II 1.6	K4M761, K4M782, K4M788, K4M812, K4M813	06/03 → 11/08
SCÉNIC II 1.6 16V	K4M764, K4M766, K4M812, K4M813	05/03 →
SCÉNIC II 1.6 BiFuel	K4M764	08/03 → 05/06
SCÉNIC II 1.6 Hi-Flex	K4M766	03/05 → 07/10
SCÉNIC II 2.0	F4R770, F4R771	06/03 → 07/10
SCÉNIC II 2.0 16V Turbo	F4R776	05/04 → 11/08
SCÉNIC III 1.6 16V	K4M858	02/09 →
SCÉNIC III 1.6 16V BiFuel	K4M866	02/09 →
SCÉNIC III 1.6 E85	K4M866	02/09 →
SCÉNIC 1.6 VVT	K4M858	01/13 →
THALIA I 1.4 16V	K4J713	08/00 →
THALIA I 1.6	K4M670, K4M674, K4M744, K4M745	01/01 →
THALIA II 1.4	K4J712, K4J713	01/09 → 12/11
THALIA II 1.6 16V	K4M670, K4M674, K4M744	09/08 →
TRAFIC II 2.0	F4R720, F4R722	03/01 →
TRAFIC II 2.0 16V	F4R820	08/06 →
TWINGO II 1.6 RS	K4M854	05/08 → 09/14
VEL SATIS 2.0 16 V Turbo	F4R766, F4R767	04/04 →
VEL SATIS 2.0 16V Turbo	F4R762, F4R763	06/02 → 08/09
VEL SATIS 2.0 Turbo	F4R767, F4R867	04/05 →
WIND 1.6	K4M854	07/10 →
MEGANE CC 1.6 16V	K4M858	06/10 →
MEGANE CC 1.6 16V Hi-Flex	K4M866	06/10 →
MEGANE CC 2.0 Tce	8XTDM10, F4R872	06/10 →
MEGANE CC 2.0 Turbo	8AR90212	10/11 →

VAUXHALL

VIVARO 2.0 16V	F4R720	08/01 → 07/14
VIVARO 2.0 ECOTEC	F4R820	08/06 → 07/14

EPS 1.970.433

05,5

COILS

Adatt./Suitable:

AUDI

077 905 115 B
077 905 115 C
077 905 115 E
077 905 115 F
077 905 115 H
077 905 115 K
077 905 115 P
077 905 115 Q
077 905 115 T

BOSCH

0 986 221 054

HITACHI

133845
2503845

MAGNETI MARELLI

060717169012

VW

077 905 115 B
077 905 115 C
077 905 115 E
077 905 115 F
077 905 115 H
077 905 115 K
077 905 115 P
077 905 115 Q
077 905 115 T

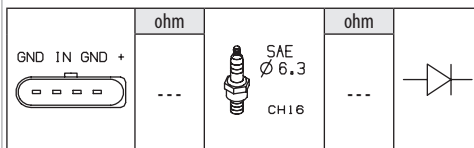

AUDI

A4 II S4 quattro	BBK	03/03 → 12/04
A4 III S4 quattro	BBK, BHF	03/04 → 03/09
A6 III 4.2 quattro	BAT	05/04 → 05/06
A8 II 3.7 quattro	BFL	10/02 → 05/06
A8 II 4.2 quattro	BFM	10/02 → 07/10
ALLROAD 4.2 V8 quattro	BAS	07/02 → 08/05

EPS 1.970.434

COILS

Adatt./Suitable:

AUDI

022 905 100 P
022 905 715 B
022 905 715 D

BOSCH

0 986 221 051

HITACHI

133847
2503847

MAGNETI MARELLI

060717102012

PORSCHE

955 602 101 00
955 602 101 01
955 602 101 02
955 602 101 03
955 602 101 04
955 602 101 05
958 602 101 00
PAB 905 715

SEAT

022 905 100 E
022 905 100 H
022 905 100 P
022 905 715

SKODA

022 905 715

VW

022 905 100 B
022 905 100 E
022 905 100 H
022 905 100 L
022 905 100 P
022 905 100 S
022 905 100 T
022 905 715
022 905 715 B
022 905 715 D

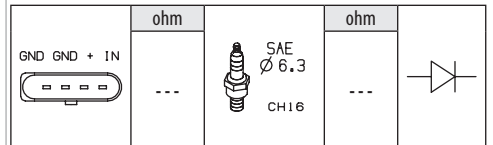

AUDI

A3 I [USA] 3.2 24V	CBRA	07/08 → 05/09
A3 I [USA] 3.2 24V AWD	--	01/06 → 12/09
A3 II 3.2 V6 quattro	BDB, BMJ, BUB	07/03 → 05/09
TT I 3.2 VR6 quattro	BHE, BPF	07/03 → 06/06
TT II 3.2 V6 quattro	BUB	08/06 → 06/10

PORSCHE

CAYENNE I 3.2	M02.2Y	08/03 → 09/07
CAYENNE I 3.6	M55.01	02/07 → 09/10
CAYENNE II 3.6	M55.02, MCE.YA	06/10 →

SEAT

LEON I 2.8	BDE	05/02 → 06/04
LEON I 2.8 Cupra 4	AUE, BDE	02/01 → 06/06

VW

EOS 3.2 V6	BUB, CBRA	06/06 → 05/09
PASSAT V 3.2 FSI 4motion	AXZ	11/05 → 11/10
PASSAT V 3.6 FSI	BLV	06/05 → 11/10
PASSAT V 3.6 FSI 4motion	BLV	09/05 → 11/10
PASSAT V 3.6 R36 4motion	BWS	04/07 → 11/10
GOLF IV 3.2 R32 4motion	BFH, BML	09/02 → 06/05
GOLF V 3.2 R32 4motion	BUB	11/05 → 11/08
MULTIVAN 3.2 V6	BDL, BKK, CFLA	02/04 → 12/09
MULTIVAN 3.2 V6 4motion	BKK, CFLA	07/04 → 12/09
PHAETON 3.2 V6	AYT, BKL	04/02 → 05/05
PHAETON 3.2 V6 4motion	BKL, BRK	02/04 → 11/08
TOUAREG I 3.2 V6	AZZ, BAA, BKJ, BMV, BMX, BRJ	10/02 → 11/06
TOUAREG I 3.6 V6 FSI	BHL	10/05 → 05/10
TRANSPORTER V 3.2 4motion	BDL, BKK, CFLA	11/03 → 11/09
TRANSPORTER V 3.2 V6	BDL, BKK, CFLA	04/03 → 11/09
TRANSPORTER V 3.2 V6 4motion	BDL, BKK, CFLA	04/03 → 12/09

1.970.435

COILS

EPS **1.970.435**  **05,5**

COILS

Adatt./Suitable:

- BOSCH**
0 986 221 073
- FORD**
1 120 169
1 252 407
1 331 283
1 362 718
1 673 468
6M21-12029-AA
YM21-12029-AA
YM21-12029-AB
YM21-12029-AC
YM21-12029-AD

- HITACHI**
133848
2503848
- MAGNETI MARELLI**
060717143012
060717160012

- SEAT**
022 905 100 A
022 905 100 D
022 905 100 G
022 905 100 K
022 905 100 N
022 905 715 C

- VW**
022 905 100 A
022 905 100 AC
022 905 100 D
022 905 100 G
022 905 100 K
022 905 100 N
022 905 715 C

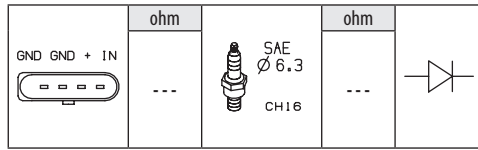

FORD			
GALAXY I 2.8	AAA, AYL	05/00 ⇒	03/06
GALAXY I 2.8 i V6	AAA, AMY	11/95 ⇒	04/00
GALAXY I 2.8 V6	AYL	04/00 ⇒	05/06
SEAT			
ALHAMBRA I / II 2.8 V6	AUE, AYL	06/00 ⇒	03/10
ALHAMBRA I / II 2.8 V6 4motion	AUE, AYL	06/00 ⇒	03/10
LEON I 2.3 VR5	AQN	09/00 ⇒	11/03
TOLEDO II 2.3 V5 20V	AQN	09/00 ⇒	11/03
VW			
BORA 2.3 V5	AQN	10/00 ⇒	05/05
BORA 2.3 V5 4motion	AQN	10/00 ⇒	05/05
BORA 2.8 V6 4motion	AUE, BDE	03/99 ⇒	05/05
BORA 2.8 VR6	AUE	03/00 ⇒	05/00
GOLF IV 2.3 V5	AQN	10/00 ⇒	06/06
GOLF IV 2.3 V5 4motion	AQN	10/00 ⇒	06/06
GOLF IV 2.8 V6 4motion	AUE, BDE	05/99 ⇒	06/06
GOLF IV 2.8 VR6 4motion	AUE, BDE	03/99 ⇒	06/05
NEW BEETLE 2.3 V5	AQN	10/00 ⇒	09/10
NEW BEETLE 3.2 RSI 4motion	AXJ	04/00 ⇒	05/01
SHARAN I 2.8 V6 24V	AYL	04/00 ⇒	03/10
SHARAN I 2.8 V6 24V 4motion	AYL	04/00 ⇒	03/10
SHARAN I 2.8 VR6	AYL	08/01 ⇒	05/03

EPS **1.970.436**  **05,5**

COILS

Adatt./Suitable:

- AUDI**
06C 905 115 A
06C 905 115 B
06C 905 115 D
06C 905 115 E
06C 905 115 F
06C 905 115 G
06C 905 115 H
06C 905 115 J
06C 905 115 K
06C 905 115 L
06C 905 115 M

- BOSCH**
0 986 221 053

- HITACHI**
133834
2503834

- MAGNETI MARELLI**
060717167012

- VW**
06C 905 115 A
06C 905 115 B
06C 905 115 D
06C 905 115 E
06C 905 115 F
06C 905 115 G
06C 905 115 H
06C 905 115 K
06C 905 115 L
06C 905 115 M

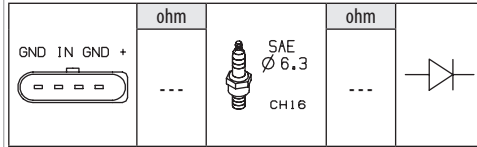

AUDI			
A6 III 3.0	BBJ	08/04 ⇒	05/06
A6 III 3.0 [CHN]	BBJ	04/05 ⇒	
A6 III 3.0 quattro	BBJ	05/04 ⇒	05/06
A4 II 2.0	ALT	11/00 ⇒	12/04
A4 II 3.0	ASN, AVK, BBJ	11/00 ⇒	12/04
A4 II 3.0 quattro	ASN, AVK, BBJ	11/00 ⇒	12/04
A6 II 2.0	ALT	08/01 ⇒	01/05
A6 II 3.0	ASN, BBJ	06/01 ⇒	01/05
A6 II 3.0 quattro	ASN, BBJ	06/01 ⇒	01/05
A8 III 3.0	ASN, BBJ	07/03 ⇒	05/06
A8 III 3.0 quattro	ASN, BBJ	07/03 ⇒	05/05
A4 III 2.0	ALT	09/04 ⇒	12/05
A4 III 3.0	ASN, BBJ	04/02 ⇒	05/06
A4 III 3.0 quattro	ASN	05/03 ⇒	07/06

EPS **1.970.437**  **05,5**

COILS

Adatt./Suitable:

- BOSCH**
0 986 221 055
- VW**
066 905 100
066 905 100 B
066 905 100 C
066 905 100 D
066 905 100 G
066 905 715

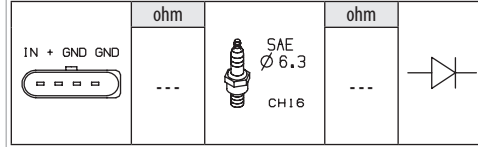

VW		
PASSAT IV 2.3 V5	AZX	11/00 ⇒ 05/05
PASSAT IV 2.3 V5 4motion	AZX	11/00 ⇒ 05/05
PASSAT IV 2.3 VR5	AZX	11/00 ⇒ 05/05
PASSAT IV 2.3 VR5 4motion	AZX	11/00 ⇒ 05/05

EPS **1.970.442**  **05,5**

COILS

Adatt./Suitable:

- ABARTH**
4677288
55246099
- ALFA ROMEO**
4677288
55246099
- BOSCH**
0 986 221 043
0 986 22A 204
- CHAMPION**
BAE 403 C
- FIAT**
4677288
504142675
55246099
- GENERAL MOTORS**
95 512 934
- HITACHI**
133801
2503801
- IVECO**
504142675
- LANCIA**
4677288
55246099
- MAGNETI MARELLI**
060717202012
060740303010
- OPEL**
12 08 108
95512934
- VAUXHALL**
95512934

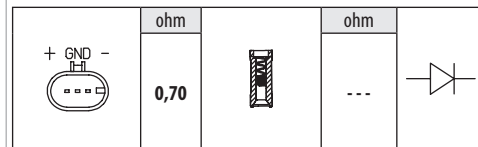

ALFA ROMEO		
MITO 1.4	199A6.000, 955A1000	08/08 ⇒ 08/13
FIAT		
500 0.9	312A4.000, 312A6.000	09/12 ⇒

FIAT		
500 1.4	169A3.000	10/07 →
500 C 0.9	312A4.000, 312A6.000	09/12 →
500 C 1.4	169A3.000, EAB	09/09 →
500 MY12 0.9	--	01/12 →
500 MY12 1.4	--	01/12 →
500L 1.4	843A1.000	09/12 →
BRAVO II 1.4	192B2.000	04/07 → 12/14
BRAVO II 1.4 16V	--	04/07 →
BRAVO II 1.4 LPG	--	12/08 →
BRAVO II 1.4 T-Jet	198A1.000, 198A4.000	09/07 → 12/14
DOBLO II 1.4	843A1.000	02/10 →
DOBLO II 1.4 Natural Power	198A4000CNG	06/10 →
DUCATO III 140 Natural Power	F1CE0441A, F1CFA401A, F1CFA401C	04/09 →
PANDA III 0.9	312A4.000, 312A5.000, 312A6.000, 312A7.000	02/12 →
PANDA III 0.9 4x4	312A2.000	06/14 →
IDEA 1.2	--	01/08 →
IDEA 1.2 16V	188A5.000	01/04 →
IDEA 1.4	192B2.000	12/03 →
IDEA 1.4 16V	--, 843A1.000	01/04 →
LINEA 1.4 16V [IND]	--	06/07 →
LINEA 1.4 T-Jet	198A4.000	05/07 →
PANDA II 1.4	--	10/06 →
PUNTO III / GRANDE PUNTO 1.4 16V	199A6.000	10/05 → 08/11
PUNTO III / GRANDE PUNTO 1.4 16V [IND]	--	01/08 →
500 MY15 0.9	--	01/15 →
500 MY15 1.4	--	01/15 →
PUNTO II 1.4	199A6.000, 843A1.000	09/03 →
STILO 1.2 16V	188A5.000	02/02 → 11/06
STILO 1.4	843A1.000	01/04 → 08/08
STILO 1.4 16V	192B2.000, 843A1.000	10/03 → 08/08
TIPO II 1.4	843A1.000	10/15 →
IVECO		
DAILY IV 35C14 G, 35C14 G/P, 35S14 G, 35S14 G/P, 35C14 GD...	F1CE0441A	07/07 → 08/11
DAILY IV 35C14 GV, 35C14 GV/P, 35S14 GV, 35S14 GV/P	F1CE0441A	07/07 → 08/11
DAILY IV 40C14 G, 40C14 G/P	F1CE0441A	07/07 → 08/11
DAILY IV 40C14 GV, 40C14 GV/P	F1CE0441A	07/07 → 08/11
DAILY IV 50C14 G, 50C14 G/P, 50C14 GD, 50C14 GD/P	F1CE0441A	07/07 → 08/11
DAILY IV 50C14 GV, 50C14 GV/P	F1CE0441A	07/07 → 08/11
DAILY IV 65C14 G, 65C14 G/P, 65C14 GD, 65C14 GD/P	F1CE0441A	07/07 → 08/11
DAILY IV Natural Power 35S14, 35C14, 40C14, 50C14, 65C14, 70C14	F1CE0441A	09/11 → 02/14
DAILY IV Natural Power 35S14, 35C14, 40C14, 50C14, 60C14, 65C14..	F1CE0441A	09/11 → 02/14
DAILY V Natural Power 35S14, 35C14, 40C14, 50C14, 60C14, 65C14...	F1CFA401A	03/14 →
DAILY V Natural Power 40C14, 50C14, 60C14	F1CFA401A, F1CFA401C	03/14 →
DAILY 3.0 CNG	F1CE0441A	06/06 → 02/14
LANCIA		
MUSA 1.4	192B2.000, 843A1.000	10/04 → 09/12
MUSA 1.4 16V	--	01/11 → 12/12
YPSILON II 1.2	188A5.000	10/03 → 12/11
YPSILON II 1.4 16V	843A1.000	10/03 → 12/11
OPEL		
COMBO D 1.4	A14FP	02/12 →
VAUXHALL		
COMBO D 1.4	A14FP	11/11 →

EPS 1.970.445



COILS

Adatt./Suitable:

AUDI

06B 905 115
06B 905 115 B
06B 905 115 E

HITACHI

133828
2503828
CM11-201

MAGNETI MARELLI

060717158012

SEAT

06B 905 115 B
06B 905 115 E

SKODA

06B 905 115 B
06B 905 115 E

VW

06B 905 115
06B 905 115 B
06B 905 115 E

GND IN GND +		ohm	ohm

AUDI

A3 I 1.8 T	AJQ, APP, ARZ	12/96 → 05/03
A3 I 1.8 T quattro	AJQ, AQA	12/96 → 05/03
A3 I S3 quattro	AMK, APY, AUL	03/99 → 04/02
A6 II 1.8	AJP, AQE, ARH	07/97 → 01/05
A6 II 4.2 quattro	ARS, ASG	11/98 → 01/05
A6 II RS6 plus quattro	BRV	04/04 → 01/05
A6 II RS6 quattro	BCY	07/02 → 01/05
A6 II S6 quattro	ANK, AQJ	09/99 → 01/05
A8 I 3.7	AKC, AQG	11/98 → 09/02
A8 I 3.7 quattro	AKC, AQG	11/98 → 09/02
A8 I 4.2 quattro	ABZ, AKB, AQF, ARU, AUW	03/94 → 12/99
A8 I S8 quattro	AQH, AVP, AYS, BCS	09/00 → 09/02
TT I 1.8 T	AJQ, APP, ATC, AUQ	10/98 → 06/06
TT I 1.8 T quattro	AJQ, APX, ARY, ATC, AUQ, BAM	10/98 → 06/06

SEAT

CORDOBA I 1.8 T 20V Cupra	AQX	07/00 → 10/02
IBIZA II 1.8 T 20V Cupra	AQX	07/00 → 02/02
ALHAMBRA I / II 1.8 T 20V	AWC	10/97 → 03/10
LEON I 1.8 20V T	APP	11/99 → 06/06
LEON I 1.8 20V T 4	AJQ	11/99 → 06/06
TOLEDO II 1.8 20V T	AUQ	09/00 → 07/04
TOLEDO II 1.8 4x4	AJQ	05/01 → 04/04

SKODA

OCTAVIA I 1.8 T	ARX, AUM	08/97 → 12/10
-----------------	----------	---------------

VW

GOLF IV 1.8 T	ARZ, AUM	08/97 → 06/06
GOLF IV 1.8 T GTI	AUQ	08/01 → 06/05
NEW BEETLE 1.8 T	AGU, APH, AVC, AWU, AWV	10/99 → 09/10
PASSAT IV 1.8 [CHN]	ANQ	03/00 → 12/03
SHARAN I 1.8 T 20V	AWC	09/97 → 03/10

EPS 1.970.448



COILS

Adatt./Suitable:

BOSCH

0 221 604 001
0 221 604 008

HITACHI

133870
2503870

VOLVO

30713416
9125601

+ GND CF IN		ohm	ohm

VOLVO

C70 I 2.0 T	B5204T3, B5204T4	03/00 → 10/05
C70 I 2.3 T5	B5234T3, B5234T9	07/02 → 10/05
C70 I 2.3 T-5	B5234T3	03/97 → 09/02
C70 I 2.4	B5244S, B5254S, B5254SDENS	06/98 → 10/05
C70 I 2.4 T	B5244T, B5244T7, B5254T	03/97 → 10/05
S60 I 2.0 T	B5204T5	07/00 → 04/10
S60 I 2.3 T5	B5234T7	07/00 → 09/02
S60 I 2.4	B5244S, B5244S2, B5244T4	07/00 → 04/10
S60 I 2.4 Bifuel	B5244SG, B5244SG2	07/01 → 04/10
S60 I 2.4 T	B5244T3	07/00 → 04/10
S60 I 2.4 T AWD	B5244T3	06/01 → 04/10
S60 I 2.4 T5	B5244T5	04/04 → 04/10
S60 I 2.5 T	B5254T2	01/03 → 04/10
S60 I 2.5 T AWD	B5254T2	07/02 → 04/10
S60 I R 2.5 T AWD	B5254T4	01/03 → 04/10
S60 I T5	B5234T3	07/00 → 04/10
S70 2.0	B5204T4	01/97 → 11/00
S70 2.3	B5234F5, B5234T7	01/97 → 07/99
S70 2.3 AWD	B5234T7	04/99 → 09/00
S70 2.4	B5244S, B5244S2, B5244SG, B5254S, B5254SDENS	01/97 → 11/00
S70 2.4 AWD	B5244S, B5244S2, B5254SDENS	10/98 → 05/99
S70 2.4 Bifuel	B5244SG, B5244SG2	07/99 → 11/00
S70 2.4 Blu-Fuel	B5244S2, B5244SG	07/97 → 09/00
S70 2.4 T5 AWD	B5254T	11/96 → 04/99
S70 2.4 Turbo	B5244T	01/97 → 11/00
S80 I 2.0	B5204T4	06/98 → 07/06
S80 I 2.0 T	B5204T3, B5204T5	06/98 → 07/06
S80 I 2.3 R	B5234T7	04/00 → 08/05
S80 I 2.4	B5244S, B5244S2	01/99 → 07/06
S80 I 2.4 Bifuel	B5244SG, B5244SG2	09/01 → 07/06
S80 I 2.4 T	B5244T3	06/00 → 07/06
S80 I 2.4 T5 AWD	B5244T3	04/00 → 09/03
S80 I 2.5 T	B5254T2	03/03 → 07/06
S80 I 2.5 T AWD	B5254T2	07/03 → 07/06
S80 I 2.8 T6	B6284T	05/98 → 12/01
S80 I 2.9	B6294S, B6294S2, B6304S3	05/98 → 02/08
S80 I 2.9 T6	B6294T	06/01 → 07/06
S80 I 3.0	B6294S2	06/01 → 07/06
S80 I 3.0 T6	B6294T	06/01 → 07/06
V70 2.4 LPG	B5244SG2	07/97 → 03/00
V70 I 2.0	B5204T4	01/97 → 12/00
V70 I 2.3	B5234F5	01/97 → 07/99
V70 I 2.3 AWD	B5234T7, B5234T8	12/98 → 02/00
V70 I 2.4	B5244S, B5244S2, B5244SG2, B5254S, B5254SDENS	12/95 → 12/99
V70 I 2.4 AWD	B5254SDENS	06/98 → 12/99
V70 I 2.4 Bifuel	B5244SG, B5244SG2	08/99 → 12/00
V70 I 2.4 Turbo	B5244T	04/96 → 12/00
V70 I 2.4 Turbo AWD	B5244T, B5244T2	04/96 → 12/00

1.970.450

VOLVO		
V70 II 2.3	B5234T7	10/00 → 09/04
V70 II 2.3 AWD	B5234T7	10/00 → 09/04
V70 II 2.3 T5	B5234T3	11/99 → 12/04
V70 II 2.4	B5244S, B5244S2	03/00 → 08/07
V70 II 2.4 Bifuel	B5244SG, B5244SG2	09/01 → 08/07
V70 II 2.4 T	B5244T3	11/99 → 08/03
V70 II 2.4 T AWD	B5244T3	09/01 → 08/02
V70 II 2.5 AWD	B5254T2	09/02 → 12/04
XC70 II 2.3 T XC AWD	B5234T7	01/01 → 07/04
XC70 II 2.5 T XC AWD	B5254T2	09/02 → 08/07
XC90 II 2.5 T AWD	B5254T2, B5254T9	10/02 → 09/14
XC90 II 6 AWD	B6294T	10/02 → 12/06

EPS 1.970.450



08,6

COILS

Adatt./Suitable:

ALFA ROMEO

71739725
71744369
71779115

BOSCH

0 986 221 104

FIAT

71739725
71744369
71779115

GENERAL MOTORS

1 104 082
10 458 316
95 517 924

HITACHI

133832
2503832

MAGNETI MARELLI

060717156012

OPEL

10458316
12 08 021
12 08 120
95517924

SAAB

10 458 316

VAUXHALL

10458316
95517924

	ohm		ohm	
	0,87		...	

ALFA ROMEO

159 1.8 MPI 939A4.000 06/05 → 11/11

FIAT

CROMA II 1.8 16V 939A4.000 12/05 →

STILO 1.6 192B3.000 04/05 → 08/08

STILO 1.6 16V 192B3.000 03/05 → 12/07

OPEL

ZAFIRA TOURER 1.6 CNG A16XNT, B16XNT 10/11 →

ASTRA G 1.6 Z16XEP 11/02 → 12/09

ASTRA G 1.6 16V Z16XEP 03/00 → 05/05

ASTRA G 1.6 LPG Z16XEP 06/02 → 06/07

ASTRA H 1.6 A16XER, Z16XE1, Z16XEP, Z16XER 03/04 → 05/14

ASTRA H 1.6 EcoTec Z16XEP, Z16XER 02/04 → 12/10

ASTRA H 1.6 LPG Z16XER 08/09 → 10/10

ASTRA H 1.6 Turbo A16LET, Z16LET 02/07 → 10/10

ASTRA H 1.8 A18XER, Z18XER 08/05 → 05/14

ZAFIRA B 1.6 A16XER, Z16XE1, Z16XEP, Z16XER 07/05 → 04/15

ZAFIRA B 1.6 CNG Turbo A16XNT, Z16XNT 04/10 → 04/15

ZAFIRA B 1.6 CNG Turbo VAN A16XNT, Z16XNT 02/09 → 04/15

ZAFIRA B 1.6 FlexFuel Z16XER 08/08 → 12/12

ZAFIRA B 1.8 A18XER, Z18XER 07/05 → 04/15

ZAFIRA B 1.8 LPG Z18XER 07/09 → 04/15

ZAFIRA B 1.8 VAN A18XER, Z18XER 07/05 → 04/15

ASTRA J 1.6 Z16XER 12/06 →

ASTRA J 1.8 Z18XER 02/07 →

CORSA D 1.6 Z16LER 07/12 → 08/14

OPEL

CORSA D 1.6 Turbo A16LEL, A16LER, A16LES, B16LER, Z16LEL, Z16LER 11/06 → 08/14

INSIGNIA A 1.6 Turbo A16LET 07/08 → 03/17

MERIVA A 1.6 Z16XEP 01/06 → 05/10

MERIVA A 1.6 Turbo Z16LET 09/05 → 05/10

SIGNUM 1.8 Z18XER 09/05 → 12/08

VECTRA C 1.6 Z16XEP 08/05 → 08/08

VECTRA C 1.8 Z18XER 08/05 → 08/08

ZAFIRA A 1.6 Z16XEP 10/03 → 06/05

ZAFIRA A 1.6 16V Z16XEP 10/03 → 06/05

SAAB

9-5 1.6 Turbo A16LET 05/10 → 01/12

VAUXHALL

ASTRA IV 1.6 Z16XEP 12/02 → 05/05

ASTRA IV 1.6 16V Z16XEP 09/98 → 10/05

ASTRA V 1.6 A16LET, A16XER, Z16LET, Z16XE1, Z16XEP, Z16XER 01/04 → 03/11

ASTRA V 1.6 i 16V A16XER, Z16XER 10/06 → 08/11

ASTRA V 1.6 Turbo A16LET, Z16LET 09/06 → 09/09

ASTRA V 1.8 A18XER, Z18XER 01/04 → 11/10

ASTRA V 1.8 i 16V A18XER, Z18XER 03/07 → 11/10

ASTRAVAN II 1.6 Dualfuel Z16XE, Z16XEP 07/00 → 08/05

ASTRAVAN II 1.6 Dualfuel 16V Z16XEP 10/04 → 12/05

CORSA D 1.6 SRi A16LEL, Z16LEL 05/07 → 08/14

CORSA D 1.6 VXR A16LER, A16LES, B16LER, Z16LER 11/06 → 08/14

INSIGNIA 1.6 Turbo A16LET 01/09 → 05/17

ASTRAVAN III 1.6 Z16XE1, Z16XEP 03/05 →

MERIVA I 1.6 i 16V Twinport Z16XEP 05/03 → 06/10

MERIVA I 1.6 Turbo Z16LET 05/06 → 06/10

SIGNUM 1.8 Z18XER 08/05 → 05/08

VECTRA C 1.6 16V Z16XEP 01/06 → 07/08

VECTRA C 1.8 Z18XER 01/06 → 07/08

ZAFIRA B 1.6 A16XER, Z16XE1, Z16XEP, Z16XER 07/05 → 11/14

ZAFIRA B 1.6 CNG Turbo A16XNT, Z16XNT 02/09 → 11/14

ZAFIRA B 1.8 A18XER, Z18XER 04/05 → 11/14

ZAFIRA C 1.6 CNG A16XNT 10/11 → 08/18

EPS 1.970.457



05,5

COILS

Adatt./Suitable:

BOSCH

F 005 X11 800

DENSO

099 700-061
099 700-072
099 700-114
DIC-0144

HITACHI

133913
2503913
CM11-207A

HONDA

30520-P8E-A01

30520-P8E-S01

30520-P8F-A01

30520-P8F-A02

30520-PGK-A01

30520-PVF-A01

30520-PVJ-A01

30520-RCA-A01

30520-RCA-A02

30520-RCA-S01

30520-RJA-A01

MAGNETI MARELLI

060717088012

060810231010



	ohm		ohm	
	

HONDA

ACCORD VI 3.0 V6 24V J30A1 02/98 → 06/03

ACCORD VI 3.0 Vtec J30A1 03/97 → 12/03

CIVIC VII 1.4 D14Z5 12/00 → 09/05

CIVIC VII 1.4 i D14Z6 02/01 → 09/05

HONDA

CIVIC VII 1.4 iS D14Z5, D14Z6 02/01 → 09/05

CIVIC VII 1.4i 16V D14Z6 02/01 →

CIVIC VII 1.5 D15Y3 02/03 → 09/05

CIVIC VII 1.5 i 16V D15Y2, D15Y3 01/01 →

CIVIC VII 1.6 D16V1, D16W7 02/01 → 09/05

CIVIC VII 1.6 i D16V1, D16W7 02/01 → 12/05

CIVIC VII 1.6i 16V D16W7 04/01 →

CIVIC VII 1.6i 16V Vtec D16V3 04/01 →

CIVIC VII 1.7 D17A6 01/00 → 09/05

CIVIC VII 1.7 i D17A8 05/01 → 12/05

CIVIC VII 1.7 i 16V VTI D17A5, D17Z4 02/01 →

CIVIC VII 1.7 i VTEC D17A5, D17A9 05/01 → 12/05

FR-V 1.7 D17A2 08/04 →

LEGEND IV 3.5 i J35A8 10/04 →

LEGEND IV 3.5 V6 4WD J35A8 05/06 → 12/12

LEGEND IV 3.5 VTEC V6 C35A8 10/04 → 06/09

LEGEND IV 3.7 VTEC V6 4WD J37A3 08/08 → 12/13

MR-V 3.5 J35A4, J35A6, J35A9 01/03 →

ODYSSEY 3.5 J35A2, J35A4, J35A6 01/00 →

STREAM 1.7 16V D17A2 05/01 → 09/06

EPS 1.970.458



05,5

COILS

Adatt./Suitable:

BOSCH

0 986 AGO 508
F 005 X11 793

DENSO

DIC-0134

HITACHI

133874
2503874

LEXUS

90919-02248
90919-02260

MAGNETI MARELLI

060717086012

TOYOTA

90919-02247

90919-02248

90919-02260

90919-A2001

90919-A2006

90919-C2002

90919-C2006

90919-T2001

90919-T2005

90919-T2008



	ohm		ohm	
	

LEXUS

GS F 2UR-GSE 09/15 →

LC 500 2UR-GSE 11/16 →

RC F 2UR-GSE 08/14 →

TOYOTA

COROLLA X 1.5 1NZ-FE 09/06 →

COROLLA X 1.5 4WD 1NZ-FE 09/06 →

COROLLA X 2.4 2AZ-FE 01/08 →

AVENSIS I 2.0 1AZ-FSE 10/00 → 02/03

AVENSIS I 2.0 VVT-i 1AZ-FSE 10/00 → 02/03

AVENSIS II 2.0 1AZ-FSE 03/03 → 11/08

AVENSIS II 2.0 VVTi 1AZ-FE, 1AZ-FSE 01/03 → 11/08

AVENSIS II 2.4 2AZ-FSE 09/03 → 11/08

CAMRY 2.0 1AZ-FE 05/06 →

CAMRY 2.4 2AZ-FE 09/01 → 09/11

CAMRY 2.4 [CHN] 3AZ-FXE 03/10 →

CAMRY 2.4 Hybrid 2AZ-FXE 01/06 → 09/11

CAMRY SOLARA II 2.4 2AZ-FE 07/03 → 11/08

COROLLA XI 1.5 1NZ-FE 05/12 →

COROLLA XI 1.5 4WD 1NZ-FE 05/12 →

LAND CRUISER 200 4.0 1GR-FE 01/10 →

FJ CRUISER 4.0 1GR-FE 06/05 → 12/11

FJ CRUISER 4.0 4WD 1GR-FE 06/05 → 01/18

FORTUNER 2.7 4x4 2TR-FE 05/15 →

HIACE IV 2.7 2TR-FE 01/05 →

TOYOTA		
HIACE IV 2.7 VVTi	2TR-FE	01/05 →
LAND CRUISER 2.7	2TR-FE	08/04 →
LAND CRUISER 4.0	1GR-FE	01/03 → 08/09
LAND CRUISER 120 2.7	2TR-FE	11/03 → 02/10
LAND CRUISER 120 4.0	1GR-FE	09/02 → 12/10
LAND CRUISER 120 4.0 V6 VVT-i	1GR-FE	01/03 → 07/09
MATRIX 2.4	2AZ-FE	01/08 → 05/14
RAV 4 III 2.0 VVT-i [CHN]	1AZ-FE	03/09 →
RAV 4 III 2.4 VVTi [CHN]	2AR-FE	03/09 →
TARAGO MPV / SPACE 2.4 VVTi	2AZ-FE	02/00 → 12/05
HILUX VII 2.0	1TR-FE	06/05 → 05/15
HILUX VII 2.7	2TR-FE	02/05 →
HILUX VII 2.7 4WD	2TR-FE	08/05 → 05/15
HILUX VII 4.0	1GR-FE	02/05 →
HILUX VII 4.0 4WD	1GR-FE	02/05 →

TOYOTA		
YARIS III 1.3	2NZ-FE	12/11 →
YARIS III 1.5	1NZ-FE	12/10 →
YARIS III 1.5 Hybrid	1NZ-FXE	03/12 →
YARIS VERSO 1.3	2NZ-FE	11/02 → 09/05
YARIS VERSO 1.3 VVTi	2NZ-FE	03/00 → 09/05
YARIS VERSO 1.5	1NZ-FE	01/00 → 09/05
YARIS VERSO 1.5 VVTi	1NZ-FE	03/00 → 03/03

TOYOTA		
COROLLA VERSO II 1.6	3ZZ-FE	04/04 → 03/09
COROLLA VERSO II 1.8	1ZZFE	04/04 → 03/09
MR 2 III 1.8 16V VT-i	1ZZFE	10/99 → 06/07
RAV 4 II 1.8	1ZZFE	08/00 → 11/05
VIOS / YARIS 1.0	1KR-FE	09/05 → 10/13
YARIS II 1.0 GPL	1KR-FE	01/06 → 12/11
YARIS II 1.0 VVT-i	1KR-FE	08/05 → 12/11
YARIS III 1.0	1KR-FE	12/10 →

EPS 1.970.459 05,5

COILS

Adatt./Suitable:

BOSCH
0 986 AG0 502

CITROËN
16 115 478 80

DENSO
DIC-0101
DIC-0146

HITACHI
133844
2503844

MAGNETI MARELLI
060717078012

PEUGEOT
16 115 478 80

TOYOTA
90080-19021
90919-02229
90919-02240
90919-02265
90919-02270
90919-W2002

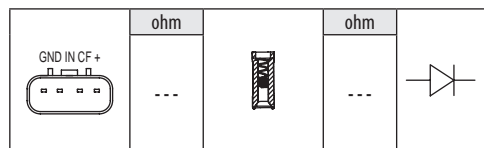

CITROËN		
C1 II 1.0 VTi 68	CFB(1KR)	04/14 →
C1 II 1.0 VTi 72	CFB(1KR)	06/18 →
PEUGEOT		
108 1.0 VTi	1KR-FE, CFB(1KR)	05/14 →
108 1.0 VTi 72	CFB(1KR)	05/18 →
TOYOTA		
AQUA 1.5 Hybrid	1NZ-FXE	12/11 →
COROLLA X 1.3 VVT-i	2NZ-FE	03/08 →
COROLLA X 1.5	1NZ-FE	09/06 →
COROLLA X 1.5 4WD	1NZ-FE	09/06 →
AYGO II 1.0	1KR-FE	05/14 →
AYGO II 1.0 VVTi	1KR-FE	03/18 →
COROLLA XI 1.5 Hybrid	1NZ-FXE	10/14 →
ECHO 1.5 i 16V [USA]	1NZFE	08/99 →
IQ 1.0	1KR-FE	01/09 → 12/15
PRIUS I 1.5 Hybrid	1NZ-FXE	05/00 → 01/04
PRIUS II 1.5 Hybrid	1NZ-FXE	09/03 → 12/09
PRIUS C 1.5 Hybrid	1NZ-FXE	12/11 →
VIOS / YARIS 1.3	2NZ-FE, 2SZ-FE	09/05 → 10/13
VIOS / YARIS 1.3 4WD	2NZ-FE	09/05 → 04/13
VIOS / YARIS 1.5	1NZ-FE	08/07 →
YARIS I 1.0	1SZ-FE	03/03 → 09/05
YARIS I 1.3	2NZ-FE, 2SZ-FE	04/02 → 11/05
YARIS I 1.5	1NZ-FE	03/00 → 11/05
YARIS II 1.3 4WD	2NZ-FE	08/07 → 11/10
YARIS II 1.3 VVT-i	2NZ-FE, 2SZ-FE	08/05 → 12/12
YARIS II 1.5	1NZ-FE	11/05 →
YARIS III 1.0 VVTi	1KR-FE	07/14 →

EPS 1.970.461 05,5

COILS

Adatt./Suitable:

BOSCH
0 986 AG0 503
F 005 X11 783

CITROËN
5970 88
5970 C0
5970 C1

DAIHATSU
90919-02262

DENSO
DIC-0100

HITACHI
133846
2503846

MAGNETI MARELLI
060717126012

PEUGEOT
5970 88
5970 C0
5970 C1

TOYOTA
90080-19015
90080-19019
90919-02239
90919-02262
90919-T2002
90919-T2006
90919-W2001

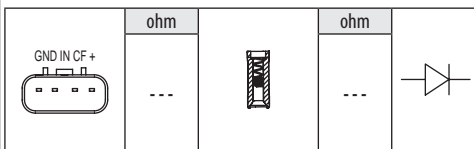

CITROËN		
C1 I 1.0	384F, CFA(384F), CFB(1KR)	06/05 →
DAIHATSU		
CUORE VII 1.0 LPG	1KR-FE	09/11 → 12/12
PEUGEOT		
107 1.0	CFA(384F), CFB(1KR)	06/05 → 05/14
TOYOTA		
COROLLA X 1.4 VVT-i	4ZZFE	11/06 → 11/13
COROLLA X 1.6 VVTi	3ZZ-FE	08/07 → 06/13
COROLLA X 1.8 16V	2CJXG	08/07 →
COROLLA X 1.8 CNG	2CJXG	06/09 →
COROLLA X 1.8 FlexFuel [BRA]	1ZZ-FBE	03/08 →
AURIS I 1.4	85HFC4GB	03/07 → 09/12
AVENSIS I 1.6	3ZZ-FE	07/00 → 02/03
AVENSIS I 1.6 VVT-i	3ZZ-FE	10/00 → 02/03
AVENSIS I 1.8	1ZZFE	10/00 → 02/03
AVENSIS I 1.8 VVT-i	1ZZFE	10/00 → 02/03
AVENSIS II 1.6 VVT-i	3ZZ-FE	04/03 → 11/08
AVENSIS III 1.8	1ZZFE	03/03 → 11/08
AYGO I 1.0	1KR-FE	07/05 → 05/14
AYGO I 1.0 GPL	1KR-FE	07/05 → 05/14
AYGO I 1.0 VVTi	1KR-FE	07/05 → 05/14
CELICA VII 1.8 16V VT-i	1ZZFE	08/99 → 07/05
COROLLA VIII 1.6	3ZZ-FE	10/99 → 01/02
COROLLA VIII 1.6 16V	3ZZ-FE	10/99 → 12/01
COROLLA IX 1.4 VVT-i	02224	10/01 → 02/07
COROLLA IX 1.6 VVT-i	3ZZ-FE	10/01 → 03/08
COROLLA IX 1.8	1ZZFE	12/01 → 12/07
COROLLA VERSO I 1.6 VVT-i	3ZZ-FE	08/01 → 05/04
COROLLA VERSO I 1.8 VVT-i	1ZZFE	12/01 → 05/04
COROLLA VERSO I 1.8 VVTi 4WD	2CJXG	07/01 → 02/04

EPS 1.970.466 05,5

COILS

Adatt./Suitable:

BOSCH
0 986 AG0 506
F 005 X11 794

DENSO
DIC-0102

HITACHI
134010
2504010

LEXUS
90919-02244
90919-02266

MAGNETI MARELLI
060717119012

TOYOTA
90080-19023
90919-02243
90919-02244
90919-02266

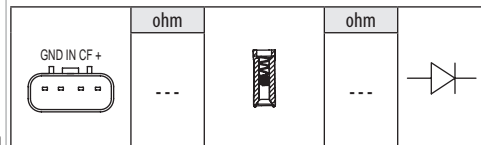

LEXUS		
HS 250h	2AZ-FXE	07/09 → 01/18
TOYOTA		
COROLLA X 2.4	2AZ-FE	01/08 →
AVENSIS II 2.0	1AZ-FE	08/01 → 11/09
AVENSIS II 2.0 VVTi	1AZ-FE	01/03 → 11/08
AVENSIS II 2.4	2AZ-FE	08/01 → 08/07
AVENSIS II 2.4 4WD	2AZ-FE	11/03 → 08/06
AVENSIS III 2.0	1AZ-FE	11/08 → 04/11
CAMRY 2.0	1AZ-FE	08/01 → 11/06
CAMRY 2.4	2AZ-FE	09/01 → 09/11
CAMRY 2.4 Hybrid	2AZ-FXE	01/06 → 09/11
CAMRY 2.4 VVTi LE	2AZ-FE	01/06 → 11/06
CAMRY SOLARA II 2.4	2AZ-FE	07/03 → 11/08
MATRIX 2.4	2AZ-FE	01/08 → 05/14
MATRIX 2.4 4WD	2AZ-FE	01/09 → 12/10
PICNIC II 2.0 VVTi	1AZ-FE	05/01 → 08/06
PICNIC II 2.4 VVTi	2AZ-FE	11/03 → 08/06
PREVIA II 2.4	2AZ-FE	02/00 → 02/06
RAV 4 II 2.0	1AZ-FE	09/00 → 12/03
RAV 4 II 2.0 4WD	1AZ-FE	05/00 → 11/05
RAV 4 II 2.4 4WD	2AZ-FE	08/03 → 11/05
RAV 4 III 2.0 4WD	1AZ-FE	02/06 → 06/13
RAV 4 III 2.4	2AZ-FE	11/05 → 12/13
RAV 4 III 2.4 4WD	2AZ-FE	11/05 → 06/13
PREVIA III 2.4	2AZ-FE	10/05 →
TARAGO MPV / SPACE 2.4 VVTi	2AZ-FE	02/00 → 12/05

EPS 1.970.474



05,5

COILS

Adatt./Suitable:

AUDI

036 905 100 A
036 905 100 B
036 905 100 C
036 905 100 D
036 905 715
036 905 715 A
036 905 715 C
036 905 715 E
036 905 715 F
036 905 715 G
036 905 715 H

BOSCH

0 986 221 023

HITACHI

133807
2503807

MAGNETI MARELLI

060717062012

SEAT

036 905 100 A
036 905 100 B
036 905 100 C
036 905 100 D
036 905 715
036 905 715 A
036 905 715 C
036 905 715 E
036 905 715 F
036 905 715 G
036 905 715 H

SKODA

036 905 100 A
036 905 100 B
036 905 100 C
036 905 100 D
036 905 715
036 905 715 A
036 905 715 C
036 905 715 E
036 905 715 F
036 905 715 G
036 905 715 H

VW

036 905 100 A
036 905 100 B
036 905 100 C
036 905 100 D
036 905 715
036 905 715 A
036 905 715 C
036 905 715 E
036 905 715 F
036 905 715 G
036 905 715 H

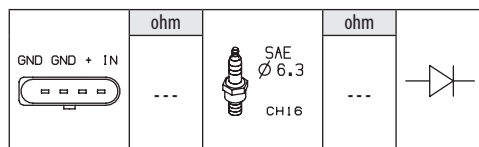

AUDI

A1 1.4 TFSI	CAVG, CAXA, CNVA, CTHG	05/10 ⇒ 04/15
A2 1.4	BBY	02/00 ⇒ 08/05
A2 1.6 FSI	BAD	05/02 ⇒ 08/05
A3 II 1.4 TFSI	CAXC, CMSA	09/07 ⇒ 05/13
A3 II 1.6 FSI	BAG, BLF, BLP	08/03 ⇒ 09/07

SEAT

ALTEA 1.4 16V	BXW, CGGB	05/06 ⇒
ALTEA 1.4 TFSI	CAXC	05/10 ⇒ 04/11
ALTEA 1.4 TSI	CAXC	11/07 ⇒
ALTEA XL 1.4 16V	BXW, CGGB	10/06 ⇒
ALTEA XL 1.4 TSI	CAXC	11/07 ⇒
ALHAMBRA III 1.4 TSI	CAVA, CTHA	06/10 ⇒
IBIZA III 1.2	AZQ, BME	02/02 ⇒ 06/06
IBIZA III 1.2 12V	BXV	05/06 ⇒ 11/09
IBIZA III 1.4 16V	AUB, BBY, BBZ, BKY, BXW	02/02 ⇒ 11/09
IBIZA III 1.6 16V	BTS	11/06 ⇒ 11/09
CORDOBA II 1.2	AZQ, BME	10/02 ⇒ 06/06
CORDOBA II 1.2 12V	BXV	05/06 ⇒ 11/09
CORDOBA II 1.4 16V	BBY, BBZ, BKY, BUD, BXW	09/02 ⇒
CORDOBA II 1.6 16V	BTS	11/06 ⇒ 11/09
IBIZA IV 1.2	BZG, CGPA, CGPB, CLJB	03/08 ⇒ 05/15
IBIZA IV 1.2 LPG	BZG	03/08 ⇒ 05/11
IBIZA IV 1.4	BXW, CGGB	03/08 ⇒ 05/15
IBIZA IV 1.4 LPG	BXW	03/08 ⇒ 05/11
IBIZA IV 1.4 TSI	CAVF, CNUB, CTHF, CTJB	01/09 ⇒ 05/15
IBIZA IV 1.4 TSI Cupra	CAVE, CTHE, CTJC	06/09 ⇒ 05/15

SEAT

IBIZA IV 1.6	BTS	05/08 ⇒ 05/15
IBIZA IV 1.6 LPG	CNKA	05/11 ⇒ 05/15
IBIZA 1.2	BZG, CGPA, CGPB	04/08 ⇒ 05/15
IBIZA 1.4	BXW, CGGB	07/08 ⇒ 05/15
IBIZA 1.6	BTS	07/08 ⇒ 05/15
LEON I 1.4 16V	BCA	11/99 ⇒ 06/06
LEON I 1.6 16V	AZD, BCB	09/00 ⇒ 06/06
LEON II 1.4 16V	BXW	06/06 ⇒ 12/12
LEON II 1.4 TSI	CAXC	11/07 ⇒ 12/12
LEON II 2.0 TFSI	CCZB	06/09 ⇒ 12/12
TOLEDO II 1.4 16V	BCA	01/00 ⇒ 05/02
TOLEDO II 1.6 16V	AZD, BCB	06/00 ⇒ 05/06
TOLEDO III 1.4 16V	BXW	05/06 ⇒ 05/09
TOLEDO IV 1.2	CGPC	07/12 ⇒ 06/15
TOLEDO IV 1.4 TSI	CAXA	07/12 ⇒ 06/15
TOLEDO IV 1.6	CFNA	07/13 ⇒ 06/15

SKODA

FABIA I 1.2	AZQ, BME	01/03 ⇒ 03/08
FABIA I 1.4	BKY	05/04 ⇒ 12/07
FABIA I 1.4 16V	AUB, BBY, BBZ, BKY, BUD	12/99 ⇒ 03/08
OCTAVIA I 1.4 16V	BCA	08/00 ⇒ 12/10
OCTAVIA II 1.4	BCA, BUD, CGGA	05/04 ⇒ 06/13
OCTAVIA II 1.4 [CHN]	CFBA.	03/10 ⇒
OCTAVIA II 1.4 TSI	CAXA	11/08 ⇒ 06/13
OCTAVIA II 1.6 [CHN]	CDFA, CLRA, CPJA	09/07 ⇒
OCTAVIA II 1.6 FSI	BLF	02/04 ⇒ 10/08
RAPID 1.2	CGPC	07/12 ⇒ 06/15
RAPID 1.2 LPG	CGPC	07/12 ⇒ 06/15
RAPID 1.4 TSI	CAXA	07/12 ⇒ 06/15
RAPID 1.6	CFNA	07/12 ⇒ 06/15
ROOMSTER 1.2	BME, BZG, CGPA	05/06 ⇒ 05/15
ROOMSTER 1.2 LPG	CGPA	03/09 ⇒ 05/15
ROOMSTER 1.4	BXW, CGGB	09/06 ⇒ 05/15
ROOMSTER 1.4 LPG	BXW, CGGB	03/10 ⇒ 05/15
ROOMSTER 1.6	BTS, CFNA	09/06 ⇒ 05/15
ROOMSTER 1.6 LPG	BTS	06/06 ⇒ 07/10
FABIA II 1.2	BZG, CEVA, CGPA, CHTA	01/07 ⇒ 12/14
FABIA II 1.2 [IND]	CJLA	09/10 ⇒
FABIA II 1.2 12V	CGPB	11/11 ⇒ 12/14
FABIA II 1.2 LPG	CGPA	07/07 ⇒ 11/14
FABIA II 1.4	BXW, CGGB	01/07 ⇒ 12/14
FABIA II 1.4 [CHN]	CDDA	12/08 ⇒
FABIA II 1.4 LPG	BXW, CGGB	01/07 ⇒ 11/14
FABIA II 1.4 TSI RS	CAVE, CTHE	05/10 ⇒ 12/14
FABIA II 1.6	BTS, CFNA, CLSA	04/07 ⇒ 12/14
FABIA II 1.6 [CHN]	CDEA	12/08 ⇒
SUPERB II 1.4 [CHN]	CFBA.	03/10 ⇒
SUPERB II 1.4 TSI	CAXC	07/08 ⇒ 05/15
YETI 1.4 TSI	CAXA	06/10 ⇒ 05/15

VOLKSWAGEN (BR)

POLO 1.4	BKY	07/06 ⇒
POLO 1.4 16V	BBY	09/02 ⇒

VW

GOLF VI 1.4	BUD, CGGA, CNWA	10/08 ⇒
GOLF VI 1.4 16V	BUD, CGGA	01/09 ⇒ 05/11
GOLF VI 1.4 TSI	CAVD, CAXA, CNWA, CTHD, CTKA	10/08 ⇒
GOLF V TSi	CAXA	10/08 ⇒ 11/12
BEETLE 1.4 TSI	CAVD, CNWA, CTHD, CTKA	10/11 ⇒ 07/16
BORA 1.4 16V	BCA	03/00 ⇒ 05/05
BORA 1.6 16V	AZD, BCB	02/00 ⇒ 05/05
BORA 1.6 FSI	BAD	01/02 ⇒ 05/05
GOLF V 1.4	BUD	06/07 ⇒ 07/09
GOLF V 1.4 16V	BCA, BUD, CGGA	10/03 ⇒ 12/13
GOLF V 1.4 FSI	BKG, BLN	10/03 ⇒ 11/06
GOLF V 1.4 TSI	BLG, BMY, CAVD, CAXA, CNWA, CTHD	11/05 ⇒ 12/13
GOLF V 1.6 FSI	BAG, BLF, BLP	10/03 ⇒ 07/08
CADDY III 1.4	BCA, BUD	03/04 ⇒ 08/10
CC 1.4 TSI	CTHD	11/11 ⇒ 12/16
CC 1.4 TSI MultiFuel	CKMA	11/11 ⇒ 12/16
EOS 1.4 TSI	CAVD, CAXA, CTHD	11/07 ⇒ 08/15
EOS 1.6 FSI	BLF	06/06 ⇒ 05/08
EOS 2.0 TFSI	BPY, BWA, CAWB, CBFA, CCTA, CCZA	03/06 ⇒ 08/15
JETTA V 1.4 TSI	BLG, BMY, CAVD, CAXA	07/06 ⇒ 10/10
JETTA V 1.6 FSI	BLF	09/05 ⇒ 10/10
PASSAT V 1.4 TSI	CAXA, CTHD	05/07 ⇒ 12/14
PASSAT V 1.4 TSI EcoFuel	CDGA	01/09 ⇒ 12/14
PASSAT V 1.4 TSI MultiFuel	CKMA	11/10 ⇒ 12/14
PASSAT V 1.6 FSI	BLF	03/05 ⇒ 06/08
GOLF IV 1.4	BCA	05/00 ⇒ 06/06
GOLF IV 1.4 16V	BCA	10/97 ⇒ 06/06
GOLF IV 1.6	AZD, BCB	05/00 ⇒ 06/06
GOLF IV 1.6 16V	AZD, BCB	02/00 ⇒ 06/06
GOLF IV 1.6 FSI	BAD, BAG	01/02 ⇒ 06/06
GOLF PLUS 1.4 TSi	CAVD, CAXA	01/09 ⇒ 08/14
JETTA VI 1.4 TSI	CAVA, CAVD, CAXA, CMSB, CTHA, CTHD	04/11 ⇒

VW

JETTA VI 1.6	CFNA, CFNB, CLRA	12/11 ⇒
POLO IV 1.2 12V	AZQ, BME, BZG	10/01 ⇒ 11/09
POLO IV 1.4	BBY, BBZ, BKY, BMG, CDD.	11/02 ⇒
POLO IV 1.4 16V	AUB, BBY, BBZ, BKY, BUD	10/01 ⇒ 11/09
POLO IV 1.4 BiFuel	BUD	05/06 ⇒ 11/09
POLO IV 1.4 FSI	AXU	02/02 ⇒ 07/06
POLO IV 1.6	BMH, CDE.	03/06 ⇒
POLO IV 1.6 16V	BTS	05/06 ⇒ 11/09
LUPO 1.4 16V	BBY	09/98 ⇒ 07/05
NEW BEETLE 1.4	BCA	11/01 ⇒ 09/10
POLO V 1.2	CGPA, CGPB	03/09 ⇒
POLO V 1.2 [IND]	CJLA	08/11 ⇒
POLO V 1.2 BlueMotion	CGPA	03/09 ⇒ 05/14
POLO V 1.4	CDDA, CGGB, CLPA	03/09 ⇒ 05/14
POLO V 1.4 BiFuel	CMAA	03/10 ⇒ 01/11
POLO V 1.4 GTI	CAVE, CTHE	05/10 ⇒
POLO V 1.6	CFNA, CFNB, CLSA	01/10 ⇒
POLO V 1.6 BiFuel	CNKA	01/11 ⇒ 05/14
PASSAT 1.4 TSi BlueMotion	CAXA	08/10 ⇒ 12/14
SCIROCCO III 1.4 TSI	CAVD, CAXA, CMSB, CNWA, CTHD, CTKA	05/08 ⇒ 11/17
SHARAN II 1.4 TSI	CAVA, CTHA	05/10 ⇒
PASSAT CC 1.4 TSi MultiFuel	CKMA	01/11 ⇒ 01/12
TIGUAN I 1.4 [CHN]	CFBA.	11/11 ⇒
TIGUAN I 1.4 TSI	BWK, CAVA, CAVD, CAXA, CTHD	05/08 ⇒ 07/18
TIGUAN I 1.4 TSI 4motion	BWK, CAVA, CAVD, CTHD	09/07 ⇒ 07/18
TOURAN I 1.4 [CHN]	CFBA.	04/09 ⇒
TOURAN I 1.4 TSI	BLG, BMY, CAVB, CAVC, CTHB, CTHC	02/06 ⇒ 05/15
TOURAN I 1.4 TSi EcoFuel	CDGA	05/09 ⇒ 05/15
TOURAN I 1.6 FSI	BAG, BLF, BLP	02/03 ⇒ 01/07
TOURAN I FSI	BAG, BLF, BLP	02/03 ⇒ 11/06

EPS 1.970.475

05,5

COILS

Adatt./Suitable:

BMW

12 13 0 148 594
12 13 0 390 064
12 13 1 712 219
12 13 1 712 223
12 13 5 A06 753
12 13 7 523 345
12 13 7 548 553
12 13 7 550 012
12 13 7 551 049
12 13 7 551 260
12 13 7 562 744
12 13 7 571 643
12 13 7 575 010
12 13 7 594 596
12 13 7 594 936
12 13 7 594 937
12 13 7 594 938
12 13 8 611 236
12 13 8 616 153
12 13 8 647 689
12 13 8 657 273
5 575 010
7 548 553
7 551 049
7 571 643
7 594 596
7 594 936
8 611 236
8 616 153
8 647 689

BOSCH

0 221 504 100
0 221 504 463
0 221 504 464
0 221 504 465
0 221 504 467
0 221 504 470
0 221 504 800

CITROËN

5970 64
5970 91
98 067 027 80
98 078 418 80

DS

5970 91

GENERAL MOTORS

3 648 847

HITACHI

133825
133875
134046
134047
134049
2503825
2503875
2504046
2504047
2504049

MAGNETI MARELLI

060717114012
060717115012
060717116012
060717152012

MINI

12 13 5 A06 753
12 13 7 550 012
12 13 7 551 049
12 13 7 562 744
12 13 7 571 643
12 13 7 575 010
12 13 7 594 596
12 13 7 594 937
12 13 7 594 938
12 13 8 616 153
12 13 8 647 689
12 13 8 657 273
7 571 643

OPEL

3648847
5 97 091

PEUGEOT

5970 64
5970 91
98 067 027 80
98 078 418 80

ROLLS-ROYCE

12 13 5 A06 753
12 13 7 571 643
12 13 7 594 937
12 13 7 594 938
12 13 8 616 153
12 13 8 647 689
12 13 8 657 273

VAUXHALL

5 97 091

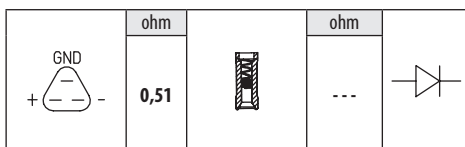

ALPINA		
B6 4.4 Biturbo 4x4 [USA]	N63M20A	03/14 ⇨
B7 4.4 Biturbo [USA]	N63M20A	01/11 ⇨
B7 4.4 Biturbo 4x4 [USA]	N63M20A	01/12 ⇨
B7 BITURBO	N63M10A	03/09 ⇨ 06/12
B7 BITURBO Trazione integrale	N63M10A	09/10 ⇨ 06/12
BMW		
11 116 i	N45B16A	06/04 ⇨ 12/11
11 118 i	N46B20B	07/04 ⇨ 12/13
11 120 i	N46B20B, N46B20BD, N46B20C	06/04 ⇨ 12/13
11 125 i	N52B30A, N52B30B, N52B30BF	10/07 ⇨
11 128 i	N51B30A, N52B30A	12/07 ⇨
11 130 i	N52B30A, N52B30B, N52B30BF	09/05 ⇨ 12/11
11 135 i	N54B30A, N55B30A	10/07 ⇨ 12/13
11 M	N54B30A	03/11 ⇨ 06/12
3VI 316 i	N13B16A	07/12 ⇨ 08/16
3VI 316 Li [CHN]	N13B16A	10/12 ⇨
3VI 320 i	N13B16A, N20B20A, N20B20B	03/12 ⇨ 10/18
3VI 320 i xDrive	N20B20A, N20B20B	07/12 ⇨ 10/18
3VI 320 Li [CHN]	--	02/12 ⇨
3VI 328 i	N20B20A, N26B20A	11/11 ⇨ 10/18
3VI 328 i xDrive	N20B20A, N26B20A	07/12 ⇨ 08/16
3VI 328 i xDrive [USA]	--	10/11 ⇨
3VI 328 Li [CHN]	N20B20A	10/11 ⇨
3VI 328 Li xDrive [CHN]	--	10/11 ⇨
3VI 328i	N20B20A	11/11 ⇨ 06/15
3VI 335 i	N55B30A	11/11 ⇨ 06/16
3VI 335 i xDrive	N55B30A	07/12 ⇨ 06/16
3VI ActiveHybrid	N55B30A	07/12 ⇨ 06/15
3VI M3	S55B30A	03/14 ⇨ 10/18
3VI M3 Competition	S55B30A	03/16 ⇨ 10/18
3VI M3 CS	S55B30A	01/18 ⇨ 10/18
111 114 i	N13B16A	12/11 ⇨
111 116 i	N13B16A	07/11 ⇨
111 118 i	N13B16A	07/11 ⇨
111 120 i	N13B16A	03/15 ⇨
111 125 i	N20B20A	12/11 ⇨
111 125 i Active Flex	N20B20A	11/14 ⇨ 11/17
111 M 135 i	N55B30A	12/11 ⇨
111 M 135 i xDrive	N55B30A	02/12 ⇨
2220 i	N20B20A, N20B20B	10/13 ⇨
2228 i	N20B20A	07/14 ⇨
2 M 235 i	N55B30A	10/13 ⇨
2 M 235 i xDrive	N55B30A	07/14 ⇨
2 M2	N55B30A	11/15 ⇨ 06/18
2 M2 Competition	S55B30A	06/18 ⇨
2 M2 CS	S55B30A	11/19 ⇨
3V 316 i	N45B16A	09/05 ⇨ 10/11
3V 318 i	N46B20B	09/05 ⇨ 03/12
3V 320 i	N46B20A, N46B20B, N46B20C, N46B20CB	12/04 ⇨ 12/13
3V 320 si	N45B20A	09/05 ⇨ 08/06
3V 323 i	N52B25A, N52B25B, N52B25BE, N52B25BF, N52B25BE, N52B25BF	09/05 ⇨
3V 325 i	N52B25A, N52B25AF, N52B25B, N52B25BE, N52B25BF	12/04 ⇨
3V 325 i xDrive	N52B25A	03/10 ⇨ 04/13
3V 325 xi	N52B25A, N52B30A	01/05 ⇨
3V 328 i	N51B30A, N52B30A, N52NB30A	07/05 ⇨
3V 328 xi	N51B30A, N52B30A	09/06 ⇨
3V 330 i	N52B30A, N52B30B, N52B30BF, N53B30A	12/04 ⇨ 10/13
3V 330 xi	N52B30A	09/05 ⇨ 02/10
3V 335 i	N54B30A, N54B30B, N55B30A	03/06 ⇨ 10/13
3V 335 i xDrive	N54B30A, N55B30A	05/08 ⇨ 12/13
3V 335 xi	N54B30A, N55B30A	09/06 ⇨ 02/10
3 SERIES 325i xDrive	N52B25A	09/08 ⇨ 10/11
4420 i	N20B20A, N20B20B	11/13 ⇨ 02/17
4420 i xDrive	N20B20A, N20B20B	11/13 ⇨ 02/16
4428 i	N20B20A, N26B20A	07/13 ⇨ 02/17
4428 i xDrive	N20B20A, N26B20A	07/13 ⇨ 02/16
4435 i	N55B30A	07/13 ⇨ 02/16
4435 i xDrive	N55B30A	07/13 ⇨ 02/16
4 M4	S55B30A	03/14 ⇨
4 M4 Competition	S55B30A	03/16 ⇨
4 M4 CS	S55B30A	07/17 ⇨ 06/19
4 M4 GTS	S55B30A	03/16 ⇨ 02/17
X5 III M	S63B44B	12/14 ⇨ 07/18
X5 III sDrive 35 i [USA]	N55B30A	01/13 ⇨
X5 III xDrive 28 i	N20B20A	06/15 ⇨ 07/18
X5 III xDrive 35 i	N55B30A	12/13 ⇨ 07/18
X5 III xDrive 40e	N20B20A	08/15 ⇨ 07/18
X5 III xDrive 50 i	N63B44B	08/13 ⇨ 07/18

BMW		
X5 III xDrive 50i	N63B40A	07/13 ⇨
3 IV 316 Ci	N40B16A, N45B16A	10/01 ⇨
3 IV 316 i	N40B16A, N42B18A, N45B16A, N46B18A	02/02 ⇨ 02/05
3 IV 316 ti	N40B16A, N42B18A, N45B16A, N46B18A	06/01 ⇨ 02/05
3 IV 318 Ci	N42B20A, N46B20A, N46B20B, N46B20C	12/00 ⇨ 12/07
3 IV 318 i	N42B20A, N46B20A, N46B20C	09/01 ⇨ 07/05
3 IV 318 ti	N42B20A, N46B20A	03/01 ⇨ 12/04
3 IV 320 Ci	M52B20(22654), M54B22(22651), M54B22651	01/00 ⇨ 12/07
3 IV 320 i	4F8Q636, M52B20(20654), M54B22(22651), M54B22651	09/00 ⇨ 02/05
3 IV 325 Ci	4CS5, M54B25(25655), M54B25655, M5625656	09/00 ⇨
3 IV 325 i	-(24654), M54B25(25655), M54B25655, M5625656	09/00 ⇨
3 IV 325 ti	M54B25(25655), M54B25655	04/01 ⇨ 12/04
3 IV 325 xi	M54B25(25655), M54B25655	09/00 ⇨ 02/05
3 IV 330 Ci	7ACR, M54B30(30653), M54B30653	06/00 ⇨ 08/06
3 IV 330 i	M54B30(30653), M54B30653	06/00 ⇨ 04/05
3 IV 330 xi	M54B30(30653), M54B30653	06/00 ⇨ 07/06
3 IV M3	S54B32(32654), S54B32654	07/00 ⇨ 08/06
3 IV M3 CSL	S54B32(32654), S54B32654	05/03 ⇨ 12/03
5 IV 520 i	M54B22(22651), M54B22651	09/00 ⇨ 12/03
5 IV 525 i	8CUG, M54B25(25655), M54B25655	09/00 ⇨ 05/04
5 IV 530 i	2CBL, M54B30(30653), M54B30653	09/00 ⇨ 12/03
5 VII M 550 i xDrive	N63B44C	03/17 ⇨ 06/19
5 VII M5	S63B44B	09/17 ⇨
5 VII M5 Competition	S63B44B	07/18 ⇨
5 VII M5 CS	S63B44B	03/21 ⇨
5 VI 520 i	N20B16A, N20B20A, N20B20B	10/10 ⇨ 02/17
5 VI 520Li [CHN]	N20B20D	01/09 ⇨
5 VI 523 i	N52B25A, N52B25AF, N52B25B, N52B25BF	11/09 ⇨ 08/11
5 VI 523Li [CHN]	N52B25AF	01/09 ⇨
5 VI 525 d	N47D20D(N4751)	09/11 ⇨ 10/16
5 VI 525Li [CHN]	N20B20A	09/11 ⇨
5 VI 528 i	N20B20A, N52B30BF	03/10 ⇨
5 VI 528 i xDrive	N20B20A	09/11 ⇨ 02/17
5 VI 528Li [CHN]	N20B20C	09/10 ⇨
5 VI 530 Hybrid [CHN]	--	01/13 ⇨
5 VI 530 i	N52B30A, N52B30AF, N52B30BF	03/10 ⇨ 06/13
5 VI 530Li [CHN]	N52B30AF	09/10 ⇨
5 VI 535 i	N55B30A	01/10 ⇨ 02/17
5 VI 535 i xDrive	N55B30A	03/11 ⇨ 02/17
5 VI 535Li [CHN]	N55B30A	01/09 ⇨
5 VI 550 i	N63B44A, N63B44B	03/10 ⇨ 02/17
5 VI 550 i xDrive	N63B44A, N63B44B	08/10 ⇨ 10/16
5 VI ActiveHybrid	N55B30A	12/11 ⇨ 10/16
5 VI M5	S63B44B	09/11 ⇨ 10/16
5 VI M5 30th Anniversary	S63B44B	07/14 ⇨ 10/16
5 VI M5 Competition	S63B44B	02/13 ⇨ 10/16
X3 II sDrive 20 i	N20B16A, N20B20A	04/14 ⇨ 08/17
X3 II sDrive 28 i [USA]	N20B20A	01/13 ⇨
X3 II xDrive 20 i	N20B20A	10/11 ⇨ 08/17
X3 II xDrive 28 i	N20B20A, N52B30A, N52B30AF, N52B30BF	01/11 ⇨ 08/17
X3 II xDrive 35 i	N55B30A	09/10 ⇨ 08/17
6 II 630 i	N52B30A, N52B30B, N52B30BF	09/04 ⇨ 08/10
6 II 645 Ci	N62B44A	09/03 ⇨ 08/05
6 II 650 i	N62B48B	09/05 ⇨ 08/10
5 V 520 i	M5422651, M54B22(22651), M54B22651, N46B20B	07/03 ⇨
5 V 520Li	N46B20B, N46B20C	09/07 ⇨
5 V 523 i	N52B25A, N52B25B, N52B25BE, N52B25BF, N52B25B	10/04 ⇨
5 V 523Li	N52B25A, N52B25B, N52B25BE	07/05 ⇨
5 V 525 i	M54B25(25655), M54B25655, N52B25A, N52B25B, N52B25BE, N52B30A, N52B30B, N52B30BF, N52B25B	09/03 ⇨
5 V 525 xi	N52B25A, N52B30A, N53B30A	04/05 ⇨
5 V 525Li	N52B25A, N52B25BE, N52B25B	07/05 ⇨
5 V 528 xi	N52B30A	03/07 ⇨

BMW		
5V 530 i	3CA4GB16, M5430653, M54B30(30653), N52B30A, N52B30BF, N53B30A	12/01 →
5V 530 xi	N52B30A	09/04 → 05/10
5V 530Li	N52B30A, N52B30B, N52B30BF	07/05 →
5V 535 i	N54B30A	04/06 → 12/09
5V 535xi	N54B30A	03/07 →
5V 540 i	N62B40A	09/05 → 12/09
5V 545 i	N62B44A	09/03 → 12/10
5V 550 i	N62B48A, N62B48B	07/05 → 12/10
6 III 640 i	N55B30A	07/11 → 10/18
6 III 640 i xDrive	N55B30A	03/13 → 10/18
6 III 650 i	N63B44A, N63B44B	12/10 → 10/18
6 III 650 i xDrive	N63B40A, N63B44A, N63B44B	09/11 →
6 III 650 i xDrive 4.0	N63B40A	06/11 →
6 III M6	S63B44B	03/12 → 10/18
6 III M6 Competition	S63B44B	07/13 → 10/18
Z4 II sDrive30i	N52B30B, N52B30BF	05/09 →
7V 730 i, Li	N52B30A, N52B30AF, N52B30BF	09/09 → 06/15
7V 740 i, Li	N54B30A, N55B30A	09/08 → 12/15
7V 740 i, Li xDrive	N55B30A	07/12 → 12/15
7V 750 i, Li	N63B44A, N63B44B	09/08 → 06/15
7V 750 i, Li xDrive	N63B44A, N63B44B	09/09 → 06/15
7V 750Li xDrive	N63B40A	01/11 →
7V 760 i, Li	N74B60A	09/09 → 12/15
7V ActiveHybrid 7	N55B30A, N63B44A	04/10 → 06/15
8 M8	S63B44B	07/19 →
8 M8 Competition	S63B44B	07/19 →
X3 I 2.0 i	N46B20B	07/05 → 08/08
X3 I 2.5 i	M54B25(25655), M54B25655	03/04 → 07/06
X3 I 2.5 si	N52B25A, N52B25AF, N52B25BF	08/06 → 08/08
X3 I 2.5 si xDrive	N52B25A, N52B25AF, N52B25BF	08/06 → 08/08
X3 I 3.0 i xDrive	M54B30(30653), M54B30653	09/03 → 07/06
X3 I 3.0 si	N52B30A, N52B30BF, N52KB30	08/06 → 08/08
X3 I xDrive 2.5i	N52B25BF	09/06 →
X3 I xDrive 20 i	N46B20B	09/08 → 08/11
X3 I xDrive 25 i	N52B25A, N52B25AF, N52B25BF	09/08 → 08/10
X3 I xDrive 3.0si	N52B30B	09/06 →
X3 I xDrive 30 i	N52B30A, N52B30BF	09/08 → 08/10
7 IV 730 i, Li	1CYA, M54B30(30653), N52B30A, N52B30BF	03/03 → 08/08
7 IV 730 i, Li	N52B30B	03/05 →
7 IV 735 i, Li	N62B36A	11/01 → 02/05
7 IV 740 i, Li	N62B40A	03/05 → 08/08
7 IV 745 i, Li	N62B44A	07/01 → 03/05
7 IV 750 i, Li	N62B48B	03/05 → 08/08
7 IV 760 i, Li	N73B60A, N73B60B	01/03 → 08/08
7 IV B7 Alpina	H1	01/06 →
X6 II 35 i [USA]	N55B30A	08/14 →
X6 II M	S63B44B	12/14 → 07/19
X6 II xDrive 35 i	N55B30A	08/14 → 07/19
X6 II xDrive 50 i	N63B40A, N63B44B	08/14 →
X6 II xDrive 50 i [USA]	N63B44B	08/14 →
X1 I sDrive 16 i	N20B16A	03/13 → 06/15
X1 I sDrive 18 i	N46B20B, N46B20BD	03/10 → 06/15
X1 I sDrive 18 i [CHN]	N20B20C	01/13 →
X1 I sDrive 20 i	N20B20A	09/11 → 06/15
X1 I sDrive 28 i [USA]	N20B20A	01/09 →
X1 I xDrive 20 i	N20B20A	09/11 → 06/15
X1 I xDrive 25 i	N52B30A	03/10 → 08/11
X1 I xDrive 28 i	N20B20A, N52B30A	09/09 → 06/15
X1 I xDrive 35 i	N55B30A	03/11 → 06/15
7 VI 750 i, Li	N63B44C	11/15 → 02/19
7 VI 750 i, Li xDrive	N63B44C	09/15 → 02/19
7 VI 750 Li xDrive	N63B40B	03/16 →
7 VI M 760 i, Li xDrive	N74B66C	12/16 → 02/19
7 VI M 760 Li xDrive	N74B66C	03/19 →
X4 I M 40 i	N55B30A	12/15 → 03/18
X4 I xDrive 20 i	N20B20A	04/14 → 03/18
X4 I xDrive 28 i	N20B20A	04/14 → 03/18
X4 I xDrive 35 i	N55B30A	04/14 → 03/18
X5 II 3.0 si	N52B30A, N52B30AF, N52B30B, N52B30BF	10/06 → 09/08
X5 II 4.8 i xDrive	N62B48B	10/06 → 09/08
X5 II M	S63B44A	07/09 → 07/13
X5 II xDrive 30 i	N52B30A	02/07 → 12/12
X5 II xDrive 35 i	N55B30A	04/10 → 07/13
X5 II xDrive 40 i	N55B30A	01/12 → 06/13
X5 II xDrive 48 i	N62B48B	10/08 → 03/10
X5 II xDrive 50 i	N63B44A	04/10 → 07/13
X5 IV M	S63B44B	12/19 →
X5 IV M Competition	S63B44B	12/19 →
X5 IV xDrive 50 i	N63B44D	08/18 →

BMW		
X6 I 35 i	N54B30A	05/08 → 08/08
X6 I 50 i	N63B44A	05/08 → 06/14
X6 I ActiveHybrid	N63B44A	01/09 → 10/11
X6 I ActiveHybrid xDrive	N63B44A	01/09 → 10/11
X6 I M	S63B44A	07/09 → 07/14
X6 I xDrive 35 i	N54B30A, N55B30A	06/07 → 07/14
X6 I xDrive 40 i	N55B30A	01/12 →
X6 I xDrive 50 i	N63B44A	10/07 → 07/14
X6 III M	S63B44B	12/19 →
X6 III M Competition	S63B44B	12/19 →
X7 xDrive M 50 i	N63B44D	07/19 →
Z3 M	S54B32(32654)	06/01 → 06/03
Z3 M 3.2	S54B32(32654)	06/01 → 01/03
Z4 I 2.0 i	N46B20A	03/05 → 02/09
Z4 I 2.2 i	M54B22(22651)	10/03 → 10/05
Z4 I 2.5 i	M54B25(25655), N52B25B	12/02 →
Z4 I 2.5 si	N52B25B	01/06 →
Z4 I 3.0 i	M54B30(30653), N52B30A	12/02 →
Z4 I 3.0 si	N52B30B	01/06 →
Z4 I M	S54B32(32654)	01/06 → 08/08
5 VI GT 528 i	N20B20A	07/13 → 02/17
5 VI GT 535 i	N55B30A	01/09 → 02/17
5 VI GT 535 i xDrive	N55B30A	09/10 → 02/17
5 VI GT 550 i	N63B44A, N63B44B	08/09 → 02/17
5 VI GT 550 i xDrive	N63B40A, N63B44A, N63B44B	06/10 → 02/17
X5 I 3.0 i	5CNG, M54B30(30653)	04/00 → 12/06
X5 I 4.4 i	N62B44A, N62B44A	10/03 → 10/06
X5 I 4.8 is	N62B48A	04/04 → 09/06

CITROËN		
C4 PICASSO II 1.6 THP 150	5FX(EP6DT)	09/14 →
C4 PICASSO II 1.6 THP 155	5FV(EP6CDT)	02/13 →
C4 PICASSO II 1.6 THP 165	5GZ(EP6FDT)	07/14 →
C4 PICASSO II 1.6 VTi 120	5FS(EP6C)	02/13 →
C4 PICASSO II THP 155	5FV(EP6CDT)	02/13 →
C4 PICASSO II VTi 120	5FS(EP6C)	02/13 →
C4 PICASSO I 1.6 16V	5FX(EP6DT)	07/08 → 08/13
C4 PICASSO I 1.6 THP 140	5FT(EP6DT)	07/08 → 08/13
C4 PICASSO I 1.6 THP 155	5FV(EP6CDT)	09/10 → 08/13
C4 PICASSO I 1.6 VTi 120	5FW(EP6), EP6C	07/08 →
C3 PICASSO 1.4	EP3C	02/09 →
C3 PICASSO 1.4 VTi 95	8FN(EP3), 8FP(EP3C), 8FS(EP3)	02/09 →
C3 PICASSO 1.4 VTi 95 LPG	8FN(EP3)	01/12 →
C3 PICASSO 1.6 VTi	5FP(EP6)	07/09 →
C3 PICASSO 1.6 VTi 120	5FS(EP6C), 5FW(EP6)	02/09 →
C4 I 1.6 THP	5FT(EP6DT)	06/08 → 07/11
C4 I 1.6 THP 140	5FT(EP6DT)	07/08 → 07/11
C4 I 1.6 THP 150	5FX(EP6DT)	07/08 → 07/11
C4 I 1.6 VTi 120	5FW(EP6)	07/08 → 07/11
C3 II 1.4 16V	EP3C	11/09 →
C3 II 1.4 LPG	8FN(EP3)	06/13 →
C3 II 1.4 VTi	8FR(EP3)	11/09 →
C3 II 1.4 VTi 95	8FP(EP3C)	11/09 →
C3 II 1.6 VTi 120	5FS(EP6C)	11/09 →
C4 II 1.4 16V	EP3C	11/09 →
C4 II 1.4 VTi 95	8FP(EP3C)	11/09 →
C4 II 1.6 16V	EP6FDTX	10/10 →
C4 II 1.6 THP 155	5FV(EP6CDT)	11/09 → 12/16
C4 II 1.6 VTi 120	5FS(EP6C)	11/09 → 12/16
C4 II 1.6 VTi 120 LPG	5FS(EP6C)	09/11 →
C4 III 1.6 THP 165	5GZ(EP6FDT)	04/18 →
C5 II 1.6 THP 150	5FN(EP6CDT)	04/09 →
C5 II 1.6 THP 155	5FV(EP6CDT)	04/09 →
C5 II 1.6 VTi 120	5FS(EP6C)	07/10 →
BERLINGO II 1.6 VTi 120	5FS(EP6C)	11/09 →
BERLINGO II 1.6 VTi 95	5FK(EP6CB)	07/10 →
C5 AIRCROSS 1.6 Hybrid	5GF(EP6FADTXD)	04/20 →
C5 AIRCROSS 1.6 PureTech 180	5GF(EP6FADTXD)	11/18 →
C5 AIRCROSS 1.6 THP 150	5GX(EP6FDTM)	09/19 →
C5 AIRCROSS 1.6 THP 165	5GY(EP6FDTM)	05/19 →
C4 GRAND PICASSO I 1.6 16V	5FT(EP6DT), 5FX(EP6DT), EP6C	07/08 →
C4 GRAND PICASSO I 1.6 THP 155	5FV(EP6CDT)	09/10 → 08/13
C4 GRAND PICASSO I 1.6 VTi 120	5FW(EP6)	07/08 → 08/13
C4 GRAND PICASSO II 1.6 THP 150	5FX(EP6DT)	09/14 →
C4 GRAND PICASSO II 1.6 THP 155	5FV(EP6CDT)	09/13 →
C4 GRAND PICASSO II 1.6 THP 165	5GZ(EP6FDT)	07/14 →
C4 GRAND PICASSO II 1.6 VTi 120	5FS(EP6C)	09/13 →
DS3 1.4 VTi 95	8FP(EP3C)	04/10 → 07/15
DS3 1.4 VTi 95 LPG	8FR(EP3C)	08/12 → 07/15

CITROËN		
DS3 1.4 VTi 98	8FR(EP3C)	11/09 → 07/15
DS3 1.6	5GM(EP6FDTX)	02/11 → 07/15
DS3 1.6 Racing	5FD(EP6DTS), 5FF(EP6DTS)	02/11 → 07/15
DS3 1.6 THP 150	5FN(EP6CDT), 5FX(EP6DT)	01/10 → 07/15
DS3 1.6 THP 155	5FR(EP6DT), 5FV(EP6CDT)	04/10 → 07/15
DS3 1.6 THP 165	5GZ(EP6FDT)	10/14 → 07/15
DS3 1.6 VTi 120	5FS(EP6C)	04/10 → 07/15
DS4 1.6 THP 150	5FE(EP6CDTMD)	04/11 → 07/15
DS4 1.6 THP 155	5FV(EP6CDT)	04/11 → 07/15
DS4 1.6 THP 160	5FM(EP6CDTM)	04/12 → 07/15
DS4 1.6 THP 165	5FM(EP6CDTM), 5FM(EP6DT), 5GZ(EP6FDT)	01/12 → 07/15
DS4 1.6 THP 200	5FU(EP6DTX)	04/11 → 07/15
DS4 1.6 THP 210	5GM(EP6FDTX)	07/15 → 07/15
DS4 1.6 VTi 120	5FS(EP6C)	04/11 → 07/15
DS5 1.6 THP 150	5FE(EP6CDTMD)	11/11 → 07/15
DS5 1.6 THP 155	5FV(EP6CDT)	11/11 → 07/15
DS5 1.6 THP 165	5FM(EP6CDTM), 5FM(EP6DT), 5GZ(EP6FDT)	01/12 → 07/15
DS5 1.6 THP 165 Hybrid	5GZ(EP6FDT)	06/12 → 07/15
DS5 1.6 THP 200	5FU(EP6DTX)	11/11 → 07/15
DS5 1.6 THP 210	5GM(EP6FDTX)	11/14 → 07/15
GRAND C4 SPACETOUREUR 1.6 PureTech 180	5GF(EP6FADTXD)	04/18 →
GRAND C4 SPACETOUREUR 1.6 THP 165	5GX(EP6FDTM), 5GZ(EP6FDT)	04/18 →

DS		
DS 4 PureTech 180	5GF(EP6FADTXD)	10/21 →
DS 5 1.6 THP 165	5GZ(EP6FDT)	07/15 → 12/18
DS 5 1.6 THP 210	5GM(EP6FDTX)	04/15 → 12/18
DS 7 1.6 PureTech 180	5GF(EP6FADTXD)	04/18 →
DS 7 1.6 PureTech 225	5GC(EP6FADTX)	09/17 →
DS 7 E-TENSE	5GQ(EP6FADTXHP)	10/19 →
DS 7 E-TENSE 225	5GQ(EP6FADTXHP)	05/21 →
DS 7 E-TENSE 4x4	5GB(EP6FADTXHP)	05/19 →
DS3 1.6 THP	5GW(EP6FDT), 5GX(EP6FDTMD), 5GZ(EP6FDT)	07/15 → 07/19
DS3 1.6 THP 165	5GZ(EP6FDT)	07/15 → 07/19
DS3 1.6 THP 208	5GR(EP6FDTX)	09/15 → 07/19
DS4 / DS4 CROSSBACK 1.6 THP 150	5FE(EP6CDTMD)	10/16 → 12/18
DS4 / DS4 CROSSBACK 1.6 THP 160	5FM(EP6CDTM)	07/15 → 12/18
DS4 / DS4 CROSSBACK 1.6 THP 165	5GZ(EP6FDT)	07/15 → 12/18
DS4 / DS4 CROSSBACK 1.6 THP 210	5GM(EP6FDTX)	07/15 → 12/18

MINI		
MINI II Cooper	N12B16A, N12B16BA, N16B16A	09/06 → 10/16
MINI II Cooper ALL4	N16B16A, N18B16A	11/12 → 10/16
MINI II Cooper S	N14B16A, N14B16AB, N18B16A	10/06 → 10/16
MINI II Cooper S ALL4	N18B16A	08/10 → 10/16
MINI II Cooper S JCW	N18B16A	12/10 → 04/15
MINI II Cooper S John Cooper Works	N14B16AB, N14B16C, N18B16A	11/06 → 11/13
MINI II John Cooper Works	N14B16C, N18B16C	11/07 → 05/15
MINI II John Cooper Works ALL4	N18B16C	11/12 → 10/16
MINI II John Cooper Works GP	N14B16C, N18B16C	09/12 → 11/13
MINI II John Cooper Works ALL4	N18B16C	11/12 →
MINI II One	N12B14A, N16B16A	11/06 → 10/16
MINI II One LPG	N12B14A	03/09 → 03/10

OPEL		
GRANDLAND / GRANDLAND X 1.6 Turbo	A16XHL(EP6FDTM), D16XHT(EP6FADTXD)	09/18 →
GRANDLAND / GRANDLAND X 1.6 Turbo Hybrid	F16XHR(EP6FADTXD)	12/19 →
GRANDLAND / GRANDLAND X 1.6 Turbo Hybrid4	F16XHR(EP6FADTXD)	06/19 →

PEUGEOT		
207 1.4 16V	8FR(EP3), 8FS(EP3), EP3C	06/07 → 10/13
207 1.6 16V	5FS(EP6C), 5FW(EP6), EP6	06/07 → 10/13
207 1.6 16V RC	5FY(EP6DTS)	02/07 → 12/12
207 1.6 16V Turbo	5FR(EP6DT), 5FX(EP6DT)	02/06 → 10/13
207 1.6 16V VTi	5FS(EP6C), 5FW(EP6), EP6	02/07 → 12/12
207 1.6 VTi	5FW(EP6)	03/07 → 12/12
207 CC 1.6 16V	5FS(EP6C), 5FW(EP6), EP6	02/07 → 10/13
207 CC 1.6 16V Turbo	5FR(EP6DT), 5FV(EP6CDT), 5FX(EP6DT)	02/07 → 12/13

PEUGEOT		
308 I 1.6 THP	EP6CDTM, EP6CDTMD, EP6CDTX	10/10 →
308 I 1.6 THP 16V	5FV(EP6CDT)	10/09 → 10/14
208 I 1.4 GPL	EP3C	10/13 →
208 I 1.4 VTi	8FS(EP3), EP3C	03/12 →
208 I 1.6	5FS(EP6C), 5FV(EP6CDT), 5GZ(EP6FDT)	02/12 →
208 I 1.6 GTi	5FU(EP6CDTX), 9H92	08/12 →
208 I 1.6 THP 165	5GZ(EP6FDT)	03/15 →
208 I 1.6 THP 210	5GM(EP6FDTX)	04/15 →
308 II 1.6	5GZ(EP6FDT)	01/12 →
308 II 1.6 GT 205	3AC	06/14 → 06/21
308 II 1.6 GTi	5GN(EP6FDTR), 6AAS	06/15 → 06/21
308 II 1.6 GTi PureTech 263	EGX(EP6FADTR)	07/18 → 06/21
308 II 1.6 PureTech 225	5GG(EP6FADTX)	01/18 → 06/21
308 II 1.6 THP	5FV(EP6CDT), 5GX(EP6FDTMD)	09/13 → 06/21
308 II 1.6 THP 125	5FA(EP6CDT)	09/13 → 06/21
308 II 1.6 THP 150	5GX(EP6FDTMD)	03/14 → 06/21
308 II 1.6 THP 155	5FV(EP6CDT)	03/14 → 06/21
308 II 1.6 THP 163	5FM(EP6CDTM)	06/14 → 06/21
308 II 1.6 THP 210	5GM(EP6FDTX)	04/15 →
508 I 1.6	5GZ(EP6FDT)	02/12 → 12/18
508 I 1.6 THP	5FE(EP6CDTM), 5FN(EP6CDT), 5FV(EP6CDT), 5GZ(EP6FDT), EP6CDTM	11/10 →
508 I 1.6 VTi	5FH(EP6C), 5FS(EP6C)	11/10 → 12/18
508 II 1.6 PureTech 180	5GF(EP6FADTXD)	09/18 →
508 II 1.6 PureTech 225	5GG(EP6FADTX)	09/18 →
508 II 1.6 THP 150	5GX(EP6FDTMD)	09/18 →
508 II 1.6 THP 165	5GY(EP6FDTM)	09/18 →
508 II Hybrid 224	5GQ(EP6FADTXHPD)	08/19 →
508 II Hybrid 225	5GQ(EP6FADTXHPD)	08/19 →
2008 I 1.6 VTi	5FS(EP6C)	03/13 →
3008 I 1.6 THP	5FE(EP6CDTM), 5FE(EP6CDTMD), 5FM(EP6CDTM), 5FV(EP6CDT), 5FX(EP6DT), EP6CDTM, EP6CDTMD	06/09 →

3008 I 1.6 VTi	EP6	06/09 → 08/16
3008 II 1.6 PureTech 180	5GF(EP6FADTXD)	07/18 →
3008 II 1.6 THP 150	5GX(EP6FDTMD)	11/17 →
3008 II 1.6 THP 165	5GY(EP6FDTM), 5GZ(EP6FDT)	05/16 →
3008 II Hybrid	5GQ(EP6FADTXHPD)	10/19 →
3008 II Hybrid4	5GB(EP6FADTXHPA)	10/19 →
5008 I 1.6 16V	5FS(EP6C), 5FV(EP6CDT), 5FW(EP6), EP6	09/09 → 03/17
5008 I 1.6 THP 150	5FX(EP6DT)	02/12 → 03/17
5008 I 1.6 THP 163	5GZ(EP6FDT)	02/12 → 03/17
5008 I 1.6 THP 165	5GZ(EP6FDT)	02/12 → 03/17
5008 II 1.6	5GX(EP6FDTMD)	07/18 →
5008 II 1.6 PureTech 180	5GF(EP6FADTXD)	07/18 →
5008 II 1.6 THP 165	5GY(EP6FDTM), 5GZ(EP6FDT)	12/16 →
PARTNER II 1.6	5FK(EP6CB), 5FS(EP6C)	04/10 →
PARTNER II TEPEE 1.6 VTi	5FK(EP6CB), 5FS(EP6C)	09/09 →
RCZ 1.6 16V	5FM(EP6CDTM), 5FV(EP6CDT), EP6CDTX	03/10 → 12/15
RCZ 1.6 THP 150	5FE(EP6CDTMD)	03/11 → 12/15
RCZ 1.6 THP 270	5FG(EP6CDTR)	06/13 → 12/15

ROLLS-ROYCE

CULLINAN V12	N74B68A	08/18 →
DAWN V12	N74B66A	02/16 →
GHOST V12	N74B66A, N74B68A	12/09 →
GHOST V-Specification	N74B66A	01/14 → 06/14
PHANTOM 6.75 V12	N73B68A	06/07 → 07/17
PHANTOM V12	N73B68A	01/03 → 07/17
PHANTOM V12, V12 EWB	N74B68A	09/17 →
WRAITH V12	N74B66A	08/13 →

VAUXHALL

GRANDLAND X 1.6 Turbo Hybrid	D16XHT(EP6FADTXHP)	12/19 →
GRANDLAND X 1.6 Turbo Hybrid4	D16XHT(EP6FADTXHP)	06/19 →

EPS 1.970.476



COILS

Adatt./Suitable:

BOSCH

0 986 221 088

CITROËN

5970 87

5970 A0

96 566 957 80

96 582 279 80

HITACHI

133842

2503842

MAGNETI MARELLI

060717207012

PEUGEOT

5970 87

5970 92

5970 A0

5970 A6

96 566 957 80

SAGEM

21597716-4

21603800-7



	ohm		ohm	
---	0,79	---	---	---

CITROËN

C4 PICASSO I 1.8 Bifuel	6FY(EW7A)	01/09 → 10/12
C4 PICASSO I 1.8 i 16V	6FY(EW7A)	02/07 → 12/11
C4 PICASSO I 2.0 i 16V	RFJ(EW10A)	09/07 → 08/13
C4 I 2.0 16V	RFJ(EW10A)	11/04 → 07/11
C4 I 2.0 VTR	RFJ(EW10A)	10/06 → 12/07
C4 II 2.0 Flex	RFJ(EW10A)	11/09 →
C5 I 1.8 16V	6FY(EW7A)	09/05 →
C5 I 2.0	RFJ(EW10A)	11/04 → 01/08
C5 I 2.0 16V	RFJ(EW10A)	09/04 →
C5 II 1.8 16V	6FY(EW7A)	02/08 →
C5 II 2.0 16V	RFJ(EW10A)	02/08 →
C5 II 2.0 16V BioFlex	RFJ(EW10A)	02/08 →
C8 2.0	RFJ(EW10A)	06/04 → 12/11
C8 2.0 16V	RFJ(EW10A)	09/05 →
C4 GRAND PICASSO I 1.8 i 16V	6FY(EW7A)	10/06 → 12/10
C4 GRAND PICASSO I 1.8 i 16V Flex	6FY(EW7A)	06/09 → 01/13
C4 GRAND PICASSO I 2.0 i 16V	RFJ(EW10A)	10/06 → 08/13
JUMPY II 2.0 i	RFH(EW10A), RFJ(EW10A)	01/07 → 03/16

PEUGEOT

EXPERT II TEPEE 2.0 16V	RFH(EW10A), RFJ(EW10A)	01/07 → 03/16
308 I 2.0 Bioflex	RFJ(EW10A)	01/08 → 12/12
308 I 2.0 CVVT	RFJ(EW10A)	07/09 → 12/14
307 2.0 16V	RFJ(EW10A), RFK(EW10J4S)	10/03 → 04/09
407 2.0 16V	RFJ(EW10A)	08/05 → 12/10
407 2.0 Bioflex	RFJ(EW10A)	09/07 → 02/11
407 2.0 Flex	RFJ(EW10A)	10/05 → 02/11
607 2.2 16V	3FY(EW12J4), 3FZ(EW12J4)	02/00 → 06/10
807 2.0 16V	RFJ(EW10A)	09/05 →
EXPERT II 2.0 16V	RFH(EW10A), RFJ(EW10A)	01/07 →

EPS 1.970.478



COILS

Adatt./Suitable:

BOSCH

0 221 604 010

FORD

1 371 601

6M5G-12029-AA

HITACHI

133889

2503889

VOLVO

30713417

8677837



+ GND CF IN	ohm		ohm	
	---	---	---	---

FORD

FOCUS II 2.5 RS	JZDA	01/09 → 07/11
FOCUS II 2.5 RS 500	JZDA	05/10 → 07/11
FOCUS II 2.5 ST	HYDA	10/05 → 09/12
GALAXY II 2.5 ST	HUWA	05/06 →
KUGA I 2.5	HYDB, HYDC	02/08 → 11/12
KUGA I 2.5 4x4	HYDB	02/08 → 11/12
MONDEO III 2.5	HUBA	03/07 → 01/15
S-MAX I 2.5 ST	HUWA	05/06 → 12/14

VOLVO

C30 2.4 i	B524454	10/06 → 12/12
C30 T5	B5254T3, B5254T7	10/06 → 12/13
C70 II 2.4	B524455	03/06 → 10/09
C70 II 2.4 i	B524454	03/06 → 10/09
C70 III T5	B5254T3, B5254T7	03/06 → 06/13
S40 II 2.4	B524454, B524455	01/04 → 12/12
S40 III T5	B5254T3, B5254T7	01/04 → 12/12
S40 III T5 AWD	B5254T3, B5254T7	04/04 → 12/10
S60 I 2.0 T	B5204T5	07/00 → 04/10
S60 I 2.4 AWD	B5244T5	02/04 → 04/10
S60 I 2.5 AWD	B5254T4	09/03 → 04/10
S60 II 2.0 T	B5204T8	05/12 → 12/15
S60 II 2.5 T	B5254T14	01/13 →
S60 II 2.5 T5	B5254T5	09/11 → 12/15
S60 II 2.5 T5 AWD	B5254T14, B5254T5	09/12 → 12/18
S60 III T	B5204T9	04/14 →
S60 III T5 AWD	B5254T12	08/15 → 12/18
S80 2.5 T	B5254T6	01/08 →
S80 2.5 T5	B5254T12	01/12 →
S80 T4	B5204T8	01/12 →
S80 I 2.0 T	B5204T5	12/99 → 07/06
S80 I 2.4 LTP	B5244T4	06/04 → 07/06
S80 II 2.5 T	B5254T10, B5254T12, B5254T14, B5254T6	03/06 → 12/16
S80 II 2.5 T AWD	B5254T6	10/06 → 04/09
S80 II 2.5 T FlexFuel	B5254T11, B5254T8	05/08 → 12/11
V40 II T4	B5204T8	07/13 → 12/15
V40 II T4 AWD	B5204T8	07/13 →
V40 II T5	B5204T9, B5254T12, B5254T14	12/12 →
V40 II T5 AWD	B5204T9, B5254T12, B5254T14	01/13 →
V50 2.4	B524454, B524455	04/04 → 12/10
V50 2.4 AWD	B524454	08/06 → 12/09
V50 T5	B5254T3, B5254T7	04/04 → 12/12
V50 T5 AWD	B5254T3, B5254T7	04/04 → 12/10
V60 I 2.0 BiFuel	B5204T9	03/14 → 12/15
V60 I 2.0 T	B5204T8	01/14 → 07/18
V60 I T5	B5204T9	10/13 → 05/18
V60 I T5 AWD	B5254T12, B5254T14	03/15 → 05/18
V70 II 2.0 T	B5204T5	11/99 → 08/07
V70 II 2.4 T	B5244T4	01/05 → 12/05
V70 II 2.4 T5	B5244T5	04/04 → 08/07
V70 II 2.5 R Sport	B5254T4	12/02 → 08/07

1.970.480

VOLVO		
V70 II 2.5 T	B5254T2	07/01 ⇒ 08/07
V70 II 2.5 T AWD	B5254T2	07/02 ⇒ 08/07
V70 II R 2,5 T AWD	B5254T4	03/03 ⇒ 08/07
V70 III 2.0 BiFuel	B5204T9, B5204T9CNG	03/13 ⇒ 12/15
V70 III 2.0 GDI	B5204T9	04/12 ⇒ 12/15
V70 III 2.5 T	B5254T10, B5254T6	08/07 ⇒ 12/12
V70 III 2.5 T FlexiFuel	B5254T11, B5254T8	05/08 ⇒ 12/11
XC60 I T5 AWD	B5254T12	04/14 ⇒ 02/17
XC70 I 2.4 XC AWD	B5244T4	01/05 ⇒ 12/06
XC70 II T5 AWD	B5254T12	08/15 ⇒ 12/16
XC70 II T6 AWD	B5254T14	03/15 ⇒ 12/16

EPS 1.970.480



05,5

COILS

Adatt./Suitable:

BOSCH

0 221 504 702

FORD

1 224 925
1 314 271
1 322 402
1 578 771
4M5E-12A366-AA
4M5G-12A366-BA
4M5G-12A366-BB
4M5G-12A366-BC
4M5G-12A366-BD
5 047 437

HITACHI

133852
2503852

MAGNETI MARELLI

060717105012
060810269010

MAZDA

LF16-18-100
LF16-18-100A
LF16-18-100B

MERCURY

4M5Z12029B

VOLVO

30711786
31375294
869474
869474

	ohm		ohm
	0,60		6500

FORD

C-MAX I 1.8	QQDA, QQDB, QQDC	02/07 ⇒ 09/10
C-MAX I 1.8 Flexifuel	Q7DA	02/07 ⇒ 09/10
C-MAX I 2.0	AODA, AODB, AODE, SYDA	02/07 ⇒ 09/10
C-MAX I 2.0 CNG	SYDA	04/09 ⇒ 09/10
C-MAX I 2.0 LPG	SYDA	06/08 ⇒ 09/10
ECOSPORT 2.0 4x4	C20HDEA	08/12 ⇒
FOCUS II 1.8	Q7DA, QQDA, QQDB	03/06 ⇒ 09/12
FOCUS II 1.8 Flexifuel	--, 1LQ4(364CIV8), 4LQ2(122CUL4), Q7DA, QQDA, QQDB, QQDD	12/05 ⇒ 09/12
FOCUS II 2.0	AODA, AODB, AODE, SYDA	07/04 ⇒ 09/12
FOCUS II 2.0 CNG	SYDA	04/09 ⇒ 07/11
FOCUS II 2.0 Flex	SYDA	10/08 ⇒ 03/10
FOCUS II 2.0 LPG	SYDA	06/08 ⇒ 07/11
FOCUS C-MAX 1.8	CSDA, CSDB, Q7DA, QQDA, QQDB, QQDC	10/03 ⇒ 03/07
FOCUS C-MAX 1.8 Flexifuel	Q7DA	01/06 ⇒ 03/07
FOCUS C-MAX 2.0	AODA, AODB, AODE, SYDA	03/04 ⇒ 03/07
GALAXY II 2.0	AOWA, AOWB, TBWA, TBWB	05/06 ⇒ 06/15
GALAXY II 2.0 Flexifuel	TBWA, TBWB	05/06 ⇒ 06/15
MAVERICK 2.3	--	05/06 ⇒
MAVERICK 2.3 16V	GZ, ZH23HYU	03/04 ⇒
MONDEO III 2.0	AOBA, AOBC, TBBA, TBBC	03/07 ⇒ 01/15
MONDEO III 2.0 Flexifuel	TBBA, TBBC	03/09 ⇒ 01/15
MONDEO III 2.0 LPG	TBBA, TBBC	07/09 ⇒ 01/15
MONDEO IV 2.0	AOBC	03/07 ⇒ 09/14
S-MAX I 2.0	AODA, AODB, AODE, AOWA, AOWB	05/06 ⇒ 12/14

FORD

S-MAX I 2.0 Flexifuel	TBWA, TBWB	05/06 ⇒ 12/14
TRANSIT III 2.3 16V CNG RWD	GZFC	04/06 ⇒ 08/14
TRANSIT III 2.3 16V LPG RWD	GZFC	04/06 ⇒ 08/14
TRANSIT III 2.3 16V RWD	GZFA, GZFB, GZFC	04/06 ⇒ 08/14

MAZDA

3 2.0	LF17	09/03 ⇒ 06/06
3 I 2.0	LF17, LF50, LF72, LFN7, LFN8	10/03 ⇒ 12/09
TRIBUTE 2.3 AWD	L3-VE	04/04 ⇒ 05/08
TRIBUTE 2.3 GX	L3-VE	12/03 ⇒ 10/04

VOLVO

C30 1.8	B4184511	10/06 ⇒ 12/12
C30 1.8 FlexFuel	B418458	01/07 ⇒ 12/12
C30 2.0	B420453	10/06 ⇒ 12/12
C30 2.0 FlexFuel	B420454	01/10 ⇒ 12/12
S40 II 1.8	B4184511	04/04 ⇒ 12/10
S40 II 1.8 FlexFuel	B418458	01/06 ⇒ 12/10
S40 II 2.0	B420453	10/06 ⇒ 12/12
S40 II 2.0 F	B420454	10/09 ⇒ 12/12
S80 II 2.0	B420453	01/08 ⇒ 09/12
S80 II 2.0 FlexFuel	B420454	01/08 ⇒ 12/11
V50 1.8	B4184511	04/04 ⇒ 12/10
V50 1.8 BiFuel	B418458	01/09 ⇒ 09/10
V50 1.8 FlexFuel	B418458	01/05 ⇒ 12/10
V50 2.0	B420453	10/06 ⇒ 12/12
V50 2.0 FlexFuel	B420454	01/10 ⇒ 12/12
V70 III 2.0	B420453	10/07 ⇒ 12/11
V70 III 2.0 FlexiFuel	B420454	01/08 ⇒ 12/11

EPS 1.970.481



07

COILS

Adatt./Suitable:

BOSCH

0 221 503 485
0 221 503 486
0 221 503 487

FORD

1 350 562
1 350 567
1 458 400
1 459 278
1 727 629
1 754 514
1 823 596
4M5G-12029-ZA
4M5G-12029-ZB
4S7G-12029-AA
4S7G-12029-AB
CM5G-12029-FA
CM5G-12029-FB
CM5G-12029-FC

HITACHI

138808
138809
2508808
2508809

MAGNETI MARELLI

060717036012
060717038012
060717146012
060810209010
060810270010

MAZDA

C401-18-100
C401-18-100A

VOLVO

30731419
31216444
31422170
9487221

	ohm		ohm
	0,53		11800

FORD

B-MAX 1.4	SPJD, SPJE	10/12 ⇒
-----------	------------	---------

FORD

B-MAX 1.4 LPG	RTJC	10/12 ⇒
B-MAX 1.6 Ti	IQJA, IQJC	10/12 ⇒
C-MAX I 1.6	HWDA, HWDB, HXDA, HXDB, SHDA, SHDB, SHDC, SIDA	02/07 ⇒ 09/10
C-MAX I 1.6 Ti-VCT	--	03/07 ⇒
C-MAX II 1.6	--	12/10 ⇒
C-MAX II 1.6 CNG	MUDA	01/13 ⇒ 12/14
C-MAX II 1.6 Flexifuel	MUDA, MUDD	02/11 ⇒ 06/19
C-MAX II 1.6 LPG	MUDA, MUDD	02/12 ⇒ 06/19
C-MAX II 1.6 Ti	IQDA, IQDB, MUDD, MUDD, PNDA, PNDD, XTDA, XTDB	10/10 ⇒ 06/19
FIESTA V 1.25 16V	FUJA, FUJB, M7JA, M7JB	05/02 ⇒ 06/08
FIESTA V 1.3	A9JA, A9JB, BAJA	11/01 ⇒ 08/08
FIESTA V 1.4	FXJA	05/02 ⇒ 09/05
FIESTA V 1.4 16V	FXJA, FXJB	11/01 ⇒ 06/08
FIESTA V 1.6 16V	FYJA, FYJB	11/01 ⇒ 06/08
FIESTA V ST150	N4JB	03/05 ⇒ 06/08
ECOSPORT 1.5 Ti	UEJB, UEJE	10/13 ⇒
ECOSPORT 1.5 Ti-VCT	UEJB, UEJE	10/13 ⇒
ECOSPORT 1.6 Ti-VCT	HXJD, IQJB	08/12 ⇒
FIESTA VI 1.25	SNJA, SNJB, SNJC, SNJD, STJA, STJB, STJC, STJD	06/08 ⇒
FIESTA VI 1.4	--, 24KH1CT5H1, RTJA, SPJA, SPJC, SPJE	06/08 ⇒
FIESTA VI 1.4 LPG	RTJA, RTJB, RTJD, SPJA, SPJC, SPJE	01/09 ⇒ 04/17
FIESTA VI 1.6	XTJA	03/15 ⇒
FIESTA VI 1.6 Ti	--, 68GR-FKS, HXJA, HXJB, HXJE, IQJA, IQJC, IQJE, RVJA, USJA	06/08 ⇒
FIESTA VI 1.6 Ti-VCT	HXJA, HXJB	10/08 ⇒ 12/12
FOCUS II 1.4	ASDA, ASDB	07/04 ⇒ 09/12
FOCUS II 1.6	HWDA, HWDB, SHDA, SHDB, SHDC	07/04 ⇒ 09/12
FOCUS II 1.6 LPG	SIDA	10/09 ⇒ 09/12
FOCUS II 1.6 Ti	HXDA, HXDB, SIDA	07/04 ⇒ 09/12
FOCUS II 1.6 Ti-VCT	--, HXDA, HXDB, SIDA	09/05 ⇒
FOCUS III 1.6 Flexifuel	MUDA, MUDD	07/10 ⇒
FOCUS III 1.6 LPG	MUDA, MUDD	02/12 ⇒
FOCUS III 1.6 Ti	IQDA, IQDB, IQDC, MUDD, MUDD, PNDA, PNDD, XTDA, XTDB	07/10 ⇒
FOCUS III 1.6 Ti-VCT	--	07/10 ⇒
FOCUS C-MAX 1.6	HWDA, HWDB, SHDA, SHDB, SHDC	10/03 ⇒ 03/07
FOCUS C-MAX 1.6 Ti	HXDA, HXDB, SIDA	08/04 ⇒ 03/07
FUSION 1.25	--, FUJA, FUJB	10/02 ⇒
FUSION 1.3	--, BAJA	08/02 ⇒
FUSION 1.4	--, FXJA, FXJB, FXJC	08/02 ⇒
FUSION 1.4 LPG	UTJA	01/10 ⇒ 12/12
FUSION 1.6	FYJA, FYJB, FYJC	08/02 ⇒ 11/09
FUSION 2.0	--	11/04 ⇒
GRAND C-MAX 1.6 Ti	IQDA, IQDB, PNDA, PNDD, XTDA	12/10 ⇒ 06/19
KA+ 1.2	B2KA, YSKD, YSKE	06/16 ⇒
KA+ 1.2 Ti-VCT	YSKD, YSKE	06/16 ⇒
KA I 1.3 i	BAA, J4D, J4K, J4M, J4N, J4P, J4S	09/96 ⇒ 11/08
KA I 1.3 i ROCAM	A9A, A9B	08/02 ⇒ 11/08
KA I 1.6 i	CDB, CDC, HL16SL9B	02/01 ⇒ 11/08
MONDEO II 1.8 16V	CGBA, CGBB, CHBA, CHBB	10/00 ⇒ 03/07
MONDEO II 2.0 16V	CJBA, CJBB	10/00 ⇒ 03/07
MONDEO III 1.6 Ti	KGBA, PNBA, RHBA	03/07 ⇒ 01/15

MAZDA

2 I 1.2	FUJA	02/03 ⇒ 06/07
2 I 1.25	FUJA	04/03 ⇒ 06/07
2 I 1.3 L	ZJ-04	04/03 ⇒ 06/07
2 I 1.4	FXJA	02/03 ⇒ 06/07
2 I 1.5	ZY-VE	04/03 ⇒ 06/07
2 I 1.6	FYJA	02/03 ⇒ 06/07

VOLVO

C30 1.6	B416453	10/06 ⇒ 12/12
S40 II 1.6	B416453	01/05 ⇒ 12/12
V50 1.6	B416453	01/05 ⇒ 12/12

EPS 1.970.483

08,5

COILS

Adatt./Suitable:

BOSCH

0 986 22A 205

CITROËN

5970 85

96 517 106 80

GENERAL MOTORS

1 104 091

HITACHI

133854

2503854

MAGNETI MARELLI

060717157012

PEUGEOT

5970 85



	ohm		ohm	
	0,83		...	

CITROËN

C2 1.4 16V KFU(ET3J4) 04/05 ⇨ 12/09

C4 1.4 16V KFU(ET3J4) 11/04 ⇨ 07/11

C3 1.4 16V KFU(ET3J4) 12/03 ⇨

PEUGEOT

206 1.4 16V KFU(ET3J4) 10/03 ⇨

207 1.4 16V KFU(ET3J4) 02/06 ⇨ 10/13

307 1.4 16V KFU(ET3J4) 11/03 ⇨ 07/07

1007 1.4 16V KFU(ET3J4) 10/05 ⇨

EPS 1.970.487

07,5

COILS

Adatt./Suitable:

BOSCH

0 986 221 058

HITACHI

134041

2504041

MAGNETI MARELLI

060717144012

MERCEDES-BENZ

A 000 150 19 80

A 000 150 26 80

A 000 150 27 80

A 272 906 00 60



	ohm		ohm	
	

MERCEDES-BENZ

CLASSE C II C 230 M272.920 01/05 ⇨ 05/08

CLASSE C II C 280 M272.940 01/05 ⇨ 08/07

CLASSE C II C 280 4-matic M272.941 01/05 ⇨ 08/07

CLASSE C II C 350 M272.960 01/05 ⇨ 05/08

CLASSE C II C 350 4-matic M272.970 01/05 ⇨ 08/07

CLASSE C III C 230 M272.921 01/07 ⇨ 08/14

CLASSE C III C 230 4-matic M272.911 07/07 ⇨ 01/14

MERCEDES-BENZ

CLASSE C III C 250 M272.921 01/07 ⇨

CLASSE C III C 250 4-matic M272.911 07/07 ⇨

CLASSE C III C 280 M272.947 01/07 ⇨ 08/14

CLASSE C III C 280 4-matic M272.948 07/07 ⇨ 01/14

CLASSE C III C 300 M272.947 08/07 ⇨ 08/14

CLASSE C III C 300 4-matic M272.948 07/07 ⇨ 01/14

CLASSE C III C 350 M272.961 01/07 ⇨ 08/14

CLASSE C III C 350 4-matic M272.971 07/07 ⇨ 01/14

CLASSE CLC CLC 230 M272.920 05/08 ⇨ 06/11

CLASSE CLC CLC 250 M272.920 06/09 ⇨ 06/11

CLASSE CLC CLC 350 M272.960 05/08 ⇨ 06/11

CLASSE CLK II 280 M272.940 01/05 ⇨ 05/09

CLASSE CLK II 350 M272.960 01/05 ⇨ 05/09

CLASSE CLK II 500 M273.967 06/06 ⇨

CLASSE CLK II 550 M273.967 06/06 ⇨

CLASSE CLK II CLK 280 M272.940 01/05 ⇨ 03/10

CLASSE CLK II CLK 350 M272.960 01/05 ⇨ 03/10

CLASSE CLK II CLK 500 M273.967 06/06 ⇨ 03/10

CLASSE CLS I CLS 280 M272.943 07/08 ⇨ 12/10

CLASSE CLS I CLS 300 M272.943 04/09 ⇨ 12/10

CLASSE CLS I CLS 350 M272.964 10/04 ⇨ 12/10

CLASSE CLS I CLS 500 M273.960 04/06 ⇨ 12/10

CLASSE CLS I CLS 550 M273.960 04/06 ⇨ 02/11

CLASSE E III 350 CGI M272.985 05/06 ⇨ 07/09

CLASSE E III E 230 M272.922 09/07 ⇨ 12/08

CLASSE E III E 230 T M272.922 05/07 ⇨ 07/09

CLASSE E III E 250 M272.922 09/07 ⇨ 12/08

CLASSE E III E 280 M272.943 03/05 ⇨ 12/08

CLASSE E III E 280 4-matic 9930.61, M272944 03/05 ⇨ 12/08

CLASSE E III E 280 T M272.943 03/05 ⇨ 07/09

CLASSE E III E 280 T 4-matic 9930.61, M272944 03/05 ⇨ 07/09

CLASSE E III E 300 M272.943 03/05 ⇨ 12/08

CLASSE E III E 300 T 4-matic 9930.61 03/05 ⇨ 07/09

CLASSE E III E 350 M272.964 03/05 ⇨ 12/08

CLASSE E III E 350 4-matic M272.972 08/04 ⇨ 12/08

CLASSE E III E 350 CGI M272.985 09/07 ⇨ 12/08

CLASSE E III E 350 T M272.964 03/05 ⇨ 07/09

CLASSE E III E 350 T 4-matic M272.972 03/05 ⇨ 07/09

CLASSE E III E 500 M273.960 04/06 ⇨ 12/08

CLASSE E III E 500 4-matic M273.962 04/06 ⇨ 12/08

CLASSE E III E 500 T M273.960 04/06 ⇨ 07/09

CLASSE E III E 500 T 4-matic M273.962 04/06 ⇨ 07/09

CLASSE E III E 550 4-matic M273.962 04/06 ⇨ 12/08

CLASSE E III E 550 T 4-matic M273.962 04/06 ⇨ 07/09

CLASSE E IV E 250 M272.923 01/10 ⇨

CLASSE E IV E 300 M272.952, M272.980 01/09 ⇨

CLASSE E IV E 350 M272.961, M272.980, M272.988 01/09 ⇨

CLASSE E IV E 350 4-matic M272.977 01/09 ⇨ 12/11

CLASSE E IV E 500 M273.966 01/09 ⇨ 12/16

CLASSE E IV E 500 4-matic M273.970 01/09 ⇨ 12/11

CLASSE E IV E 550 [USA] M273.966 01/09 ⇨

CLASSE E IV E 550 [USA] [CAN] [JPN] M273.971 01/09 ⇨

CLASSE E IV E 550 4-matic [USA] [CAN] M273.970 01/09 ⇨

CLASSE G II G 500 M273.963, M273.969 01/07 ⇨

CLASSE G II G 500 GUARD M273.963 06/10 ⇨

CLASSE G II G 550 M273.963, M273.969 06/10 ⇨

CLASSE GL I GL 450 4-matic M273.923 09/06 ⇨ 08/12

CLASSE GL I GL 500 4-matic M273.963 09/06 ⇨

CLASSE GLK 280 4-matic M272.948 06/08 ⇨ 06/09

CLASSE GLK 300 4-matic M272.948 07/09 ⇨ 12/15

CLASSE GLK 350 M272.991 04/09 ⇨ 06/15

CLASSE GLK 350 4-matic M272.971 06/08 ⇨ 04/11

CLASSE M II ML 300 M272.945 07/09 ⇨

CLASSE M II ML 300 4-matic M272.945 03/10 ⇨ 12/11

CLASSE M II ML 350 M272.967 07/05 ⇨

CLASSE M II ML 350 4-matic M272.967 02/05 ⇨ 12/11

CLASSE M II ML 450 4-matic Hybrid M272.973 07/05 ⇨

CLASSE M II ML 500 4-matic M273.963 12/07 ⇨ 12/11

CLASSE M II ML 550 4-matic M273.963 12/07 ⇨

CLASSE R R 280 M272.945 01/07 ⇨ 12/14

CLASSE R R 280 4-matic M272.945 05/07 ⇨ 12/11

CLASSE R R 300 M272.945 07/09 ⇨ 12/14

CLASSE R R 300 4-matic M272.945 07/09 ⇨

CLASSE R R 350 M272.967 01/07 ⇨ 12/12

CLASSE R R 350 4-matic M272.967 08/05 ⇨ 12/12

CLASSE R R 500 4-matic M273.963 05/07 ⇨ 12/14

CLASSE R R 550 4-matic M273.963 01/07 ⇨

CLASSE SV CL 550 [JPN] M273.961 06/06 ⇨

CLASSE SV CL 550 [USA] M273.961 06/06 ⇨

CLASSE SV CL 550 4-matic [JPN] M273.968 02/08 ⇨

CLASSE SV CL 550 4-matic [USA] M273.968 02/08 ⇨

CLASSE SV S 280 M272.946 08/06 ⇨ 12/13

MERCEDES-BENZ

CLASSE SV S 300 M272.946 08/06 ⇨ 12/13

CLASSE SV S 350 M272.965 10/05 ⇨ 12/13

CLASSE SV S 350 4-matic M272.975 02/08 ⇨ 12/13

CLASSE SV S 400 Hybrid M272.974 01/09 ⇨ 12/13

CLASSE SV S 450 M273.922 12/05 ⇨ 12/13

CLASSE SV S 450 4-matic M273.924 12/05 ⇨ 12/13

CLASSE SV S 500 M273.961 10/05 ⇨ 12/13

CLASSE SV S 500 4-matic M273.968 10/05 ⇨ 12/13

CLASSE SV S 550 [JPN] M273.961 10/05 ⇨

CLASSE SV S 550 [USA] M273.961 10/05 ⇨

CLASSE SV S 550 4-matic [JPN] M273.968 10/05 ⇨

CLASSE SV S 550 4-matic [USA] M273.968 10/05 ⇨

SPRINTER II 224 M272.979 06/06 ⇨

SPRINTER II 324 M272.979 06/06 ⇨ 12/13

SPRINTER II 424 M272.979 06/06 ⇨ 12/13

SPRINTER II 524 M272.979 06/06 ⇨ 12/13

CLASSE SLV 280 M272.949 03/08 ⇨ 01/12

CLASSE SLV 300 M272.949 04/09 ⇨ 01/12

CLASSE SLV 350 M272.966, M272.968 03/06 ⇨ 01/12

CLASSE SLV 500 M273.965 03/06 ⇨ 01/12

CLASSE SLV 550 M273.965 03/06 ⇨ 01/12

CLASSE SLK II 280 M272.942 01/05 ⇨ 02/11

CLASSE SLK II 300 M272.942 04/09 ⇨ 02/11

CLASSE SLK II 350 M272.963, M272.969 06/04 ⇨ 02/11

VIANO 3.5 M272.978 09/07 ⇨

VIANO 3.7 M112.976 06/04 ⇨ 07/07

VITO II 123 M112.976 06/04 ⇨ 07/08

VITO II 126 M272.978 09/07 ⇨

EPS 1.970.489

05,5

COILS

Adatt./Suitable:

BOSCH

0 221 604 014

HITACHI

133863

2503863

MAGNETI MARELLI

060810187010

NISSAN

22448-ED800

22448-ED80A

RENAULT

77 01 065 086



	ohm		ohm	
	

NISSAN

MICRA III 160 SR HR16DE 05/05 ⇨ 06/10

MICRA C+C 1.6 160 SR HR16DE 08/05 ⇨

NOTE I 1.6 HR16DE 03/06 ⇨ 06/12

QASHQAI / QASHQAI +2 1.6 CVTC HR16DE 03/13 ⇨ 04/14

QASHQAI I 1.6 HR16DE 02/07 ⇨ 12/13

QASHQAI I 1.6 LPG HR16DE 11/10 ⇨ 12/13

QASHQAI I 2.0 MR20DE 02/07 ⇨ 12/13

QASHQAI I 2.0 Trazione integrale MR20DE 02/07 ⇨ 12/13

TIIDA I 1.6 HR16DE 09/07 ⇨ 12/12

TIIDA I 1.8 MR18DE 05/04 ⇨ 12/12

X-TRAIL II 2.0 MR20DE 06/08 ⇨ 02/14

X-TRAIL II 2.0 4x4 MR20DE 06/07 ⇨ 11/13

X-TRAIL II 2.0 FWD MR20DE 03/07 ⇨ 11/13

RENAULT

CLIO III 2.0 16V M4R700, M4R701 09/06 ⇨ 12/14

LAGUNA III 2.0 16V M4R704 10/07 ⇨ 12/15

LAGUNA III 2.0 16V Hi-Flex M4R704 10/07 ⇨ 12/15

1.970.492

EPS 1.970.492



05,5

COILS

Adatt./Suitable:

HITACHI134006
2504006**HYUNDAI**

27301-3C000

KIA

27301-3C000

MAGNETI MARELLI

060717148012



	ohm		ohm
	0,72		7160

HYUNDAI

EQUUS / CENTENNIAL II 3.8	--	01/13 →
GENESIS 3.0 GDI	G6DG	06/14 →
GENESIS 3.0 GDI 4WD	G6DG	06/14 →
GENESIS 3.8	G6DA	09/09 →
GENESIS 3.8 GDI	G6DJ	06/14 →
GENESIS 3.8 GDI 4WD	G6DJ	06/14 →
GENESIS 3.8 V6	G6DA, G6DJ	01/08 →
GRANDEUR 3.3	G6DB	04/05 → 12/11
GRAND SANTA FE 3.0 GDI	G6DG	07/13 →
Trazione integrale		
GRAND SANTA FE 3.3	G6DF	01/14 →
GRAND SANTA FE 3.3	G6DF	02/14 →
Trazione integrale		
IX55 3.8 V6	G6DA	01/11 →
IX55 3.8 V6 4WD	G6DA	01/07 →
NF 2.0 CVVT	G4BPE	05/05 → 12/10
SANTA FE II 3.3	G6DB	07/07 → 11/08
SANTA FE II 3.3 Dynamic 4x4	G6DB	03/06 → 12/12
SANTA FE II 3.5	--	01/10 →
SANTA FE II 3.5 4x4	G6DC	08/11 → 12/12
SANTA FE IV 3.5 MPI AWD	G6DC	07/19 →
SONATA V 2.0 VVTi GLS	G4KA	05/05 → 12/10
SONATA V 2.4	G4KC	01/05 → 12/10
SONATA V 3.3	G6DB	01/05 → 12/10
SONICA 3.3 CVVT	G6DB	03/09 → 12/10

KIA

BORREGO 3.8	--	06/08 → 12/13
CADENZA 3.5 CVVT	G6DC	01/10 →
CARENS II 2.0 CVVT	G4KA	09/06 →
MOHAVE 3.8	--	12/08 →
OPIRUS 3.8 V6	G6DA	10/06 →
OPTIMA II 2.0	G4KA	05/08 →
QUORIS 3.8	G6DK	01/13 →
QUORIS 3.8 GDI	G6DJ	04/15 →
MAGENTIS II 2.0	G4JP, G4KA	11/05 →
SORENTO I 3.3 V6	--	12/06 →
SORENTO I 3.3 V6 4WD	G6DB	02/07 → 12/11
SORENTO III 3.5 D-CVVT	G6DC	12/18 →
SORENTO III 3.5 D-CVVT 4WD	G6DC	12/18 →
SORENTO II 3.3 GDI	--	10/12 →
SORENTO II 3.5	G6DC	11/09 →
SORENTO II 3.5 4WD	G6DC	11/09 →

COILS

Adatt./Suitable:

BOSCH

0 986 221 062

HITACHI134045
2504045**HYUNDAI**

27301-2B000

KIA

27301-2B000

MAGNETI MARELLI

060717111012



	ohm		ohm
	0,81		5640

HYUNDAI

ELANTRA IV 1.6 CVVT	G4FC	06/06 → 06/11
I30 I 1.4	G4FA	10/07 → 06/12
I30 I 1.4 LPG	G4FA	01/09 → 06/12
I30 I 1.6	G4FC	10/07 → 06/12

KIA

CEED I 1.4	G4FA	12/06 → 12/12
CEED I 1.6	G4FC	09/07 → 12/12
CEED I 1.6 LPG	G4FC	06/07 → 12/11
CERATO I 1.6	G4ED, G4FC, G4GR	04/04 →
PRO CEE'D I 1.4	G4FA	02/08 → 09/12
PRO CEE'D I 1.6	G4FC	02/08 → 09/12
PRO CEE'D I 1.6 CVVT	G4FC	02/08 → 09/12

EPS 1.970.496



05

COILS

Adatt./Suitable:

BOSCH

0 986 221 005

HITACHI

138746

HYUNDAI

27301-02600 *5

27301-02630 *5

27301-02800 *5

27310-02620

27310-02630

***5 Supplied single coil only, without fastening clamp**

- Fornita bobina singola senza staffa
- Fourni seulement la bobine individuelle, sans étrier
- Nur Zündspule geliefert, ohne Befestigungsbügel
- Suministrada solamente la bobina individual, sin brida

1.970.496

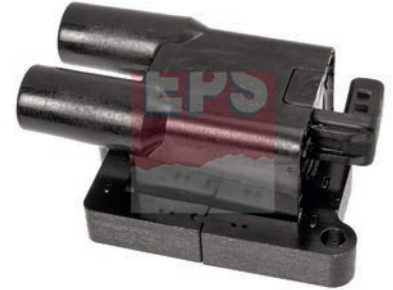

	ohm		ohm
	0,9	Ø 8,2	13200

HYUNDAI

ATOS 1.0 i	G4HC	03/01 → 07/03
ATOS 1.1	G4HD, G4HG	06/03 → 12/10
ATOS PRIME 1.0 i	G4HC-E	03/01 → 07/03
ATOS PRIME 1.1	G4HD, G4HG	08/03 → 12/08
I10 I 1.1	G4HG	12/07 → 12/13
I10 I 1.1 LPG	G4HG	01/09 → 12/13
SANTRO 1.1	G4HD	01/03 →

EPS 1.970.497



05,5

COILS

Adatt./Suitable:

CITROËN

5970 96

HITACHI134083
2504083**MITSUBISHI**

1832A016

PEUGEOT

5970 96



	ohm		ohm

CITROËN

C4 AIRCROSS 2.0	4B11	04/12 →
C4 AIRCROSS 2.0 AWC	4B11	04/12 →
C-CROSSER 2.0	4B11	11/10 →
C-CROSSER 2.0 Trazione integrale	4B11	11/10 →

CITROËN		
C-CROSSER 2.4 16V	SFZ(4B12MMC)	08/08 →
C-CROSSER ENTERPRISE 2.4 16V	4B12	01/09 →
MITSUBISHI		
ASX 1.8	4B10	02/10 →
ASX 1.8 4WD	6B4204T30	02/10 →
ASX 2.0 i	4B11	06/10 →
ASX 2.0 i 4WD	4B11	01/10 →
ASX 2.0 MIVEC	4B11, 4J11	06/10 →
ASX 2.0 MIVEC 4WD	4B11, 4J11	06/10 →
DELICA D5 2.4 4WD	4B12	06/07 →
LANCER 1.8 i	--	10/07 →
LANCER IX 1.8	4B10, 4J10	02/08 →
LANCER IX 1.8 Bifuel	4B10	01/10 →
LANCER IX 1.8 Flex	4B10	03/09 →
LANCER IX 1.8 Flexfuel	4B10, 6B4204T30	03/09 →
LANCER IX 1.8 MIVEC	4B10, 4J10	03/09 →
LANCER IX 2.0	4B11	04/08 →
LANCER IX 2.0 i	4B11	04/07 →
LANCER IX 2.0 i 4WD	4B11	03/07 →
OUTLANDER I 2.4 4WD	4G64(16V)	05/03 → 10/06
OUTLANDER I 2.4 HDD Mivec	4G69	03/01 → 12/06
OUTLANDER II 2.0	4B11	11/06 → 11/12
OUTLANDER II 2.0 4WD	4B11	11/06 → 11/12
OUTLANDER II 2.4	4B12	11/06 → 11/12
OUTLANDER II 2.4 4WD	4B12	09/07 → 11/12
OUTLANDER II 2.4 Flex 4WD	4B12	09/07 → 11/12
OUTLANDER II 3.0 4WD	6B31	11/06 → 12/12
OUTLANDER II 3.0 AWD	6B31	11/06 → 12/10
OUTLANDER II 3.0 FWD	6B31	11/06 → 11/12
OUTLANDER III 3.0	6B31	08/12 →
OUTLANDER III 3.0 4WD	6B31	03/14 →
OUTLANDER III 3.0 GT 4WD	6B31	08/12 →
PAJERO SPORT II 3.0	6B31	09/08 →
PAJERO SPORT II 3.0 4WD	6B31	09/08 →
LANCER VIII 1.8 SEI Limited	4G93(GDI)	09/03 → 03/07

PEUGEOT		
4007 2.0	4B11	11/10 → 03/13
4007 2.0 4x4	4B11	11/10 → 03/13
4007 2.4 16V	SFZ(4B12-MMC), SFZ(4B12-MMC)	02/07 → 03/13
4008 2.0	4B11	05/13 →
4008 2.0 AWC	4B11	05/12 →

EPS **1.970.503**  **05,5**

COILS

Adatt./Suitable:

- HITACHI**
134086
2504086
- MITSUBISHI**
1832A028
- SMART**
A 132 158 00 03

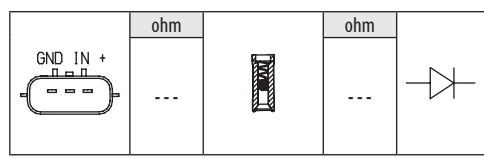

MITSUBISHI		
I 0.7	3B20	02/07 →
SMART		
FORTWO II 1.0	M132.910	01/07 →
FORTWO II 1.0 Brabus	M132.930	01/08 →
FORTWO II 1.0 Turbo	M132.930	01/07 →
FORTWO II 1.0 Turbo Brabus	M132.930	07/10 →

EPS **1.970.505**  **05,5**

COILS

Adatt./Suitable:

- CITROËN**
16 075 767 80
- HITACHI**
134087
2504087
- MITSUBISHI**
MN195805
- PEUGEOT**
16 075 767 80

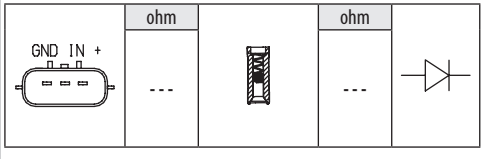

CITROËN		
C4 AIRCROSS 1.6	4A92, NKZ(4A92)	04/12 →
MITSUBISHI		
ASX 1.6 LPG	4A92	06/10 →
ASX 1.6 MIVEC	4A92	05/10 →
COLT VI 1.1	3A91	10/04 → 06/12
COLT VI 1.1 LPG	3A91	10/04 → 06/12
COLT VI 1.3	4A90	06/04 →
COLT VI 1.3 4WD	4A90	08/04 →
COLT VI 1.3 LPG	4A90	06/04 → 06/12
LANCER IX 1.5	4A91	06/08 →
LANCER IX 1.5 Bifuel	4A91	02/10 →
LANCER IX 1.6 MIVEC	4A92	05/10 →
PEUGEOT		
4008 1.6	--, 4A92, MMC	05/12 →

EPS **1.970.507**  **08,6**

COILS

Adatt./Suitable:

- BOSCH**
0 221 503 468
- GENERAL MOTORS**
9 198 834
90 424 480
- HITACHI**
133879
2503879
- MAGNETI MARELLI**
060717185012
- OPEL**
62 35 037
91 98 834
- VAUXHALL**
9198834

- 03 Supplied until depletion**
- Fornibile fino ad esaurimento delle scorte
- Fourni jusqu'à épuisement du stock
- Lieferbar solange vorrat reicht
- Sumministrado hasta el stock termina

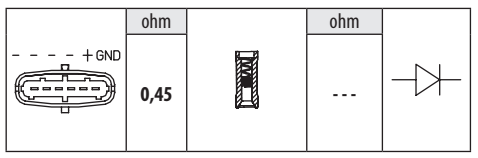

OPEL		
ASTRA G 2.0 16V Turbo	Z20LET	09/00 → 10/05
ASTRA G 2.0 OPC	Z20LET	03/02 → 10/05
ASTRA H 2.0 Turbo	Z20LEH, Z20LEL, Z20LER	03/04 → 10/10
ZAFIRA B 2.0	Z20LEH, Z20LER	07/05 → 12/10
ZAFIRA B 2.0 VAN	Z20LER	07/05 → 12/10
SPEEDSTER 2.0	Z20LET	10/03 → 08/06
SPEEDSTER 2.0 Turbo	Z20LET	08/02 → 08/06
ZAFIRA A 2.0 OPC	Z20LET	09/01 → 06/05
VAUXHALL		
ASTRA IV 2.0	Z20LET	08/02 → 10/05
ASTRA IV 2.0 16V Turbo	Z20LET	09/00 → 08/05
ASTRA IV 2.0 SRI Turbo	Z20LET	11/01 → 05/05
ASTRA IV 2.0 Turbo	Z20LET	03/02 → 10/05
ZAFIRA A 2.0	Z20LET	06/02 → 06/05
ZAFIRA A 2.0 GSI Turbo	Z20LET	09/01 → 06/05
ASTRA V 2.0	Z20LEL	02/06 → 11/10
ASTRA V 2.0 Turbo	Z20LEH, Z20LEL, Z20LER	01/04 → 11/10
ASTRA V 2.0 VXR	Z20LEH	02/09 → 11/10
SPEEDSTER 2.0 Turbo	Z20LET	03/01 → 09/06
SPEEDSTER VXR20	Z20LET	03/01 → 09/06
VX220 2.0 i Turbo	Z20LET	03/01 → 07/05
VX220 2.0 VXR	Z20LET	10/03 → 07/05
ZAFIRA B 2.0	Z20LEH, Z20LER	07/05 → 11/14

EPS **1.970.508**  **08,8**

EPS **1.970.509**  **08,7**

MAZDA
3 II 1.6 MZR | Z668, Z682, Z683 | 12/08 ⇔ 09/14

COILS
Adatt./Suitable:
GENERAL MOTORS
9 119 567
90 536 194
HITACHI
133810
2503810
MAGNETI MARELLI
060717064012
OPEL
12 08 008
91 19 567
SAAB
91 19 567
SAGEM
2 526 116 A
SIEMENS
5WK9 3171
VAUXHALL
9119567

COILS
Adatt./Suitable:
CITROËN
5970 84
5970 A5
96 351 725 80
96 453 331 80
HITACHI
133843
2503843
PEUGEOT
5970 76
5970 84
5970 A5
SAGEM
2 526 131 A

EPS **1.970.516**  **05,5**

COILS
Adatt./Suitable:
BOSCH
0 986 221 092
HITACHI
133936
2503936
MAGNETI MARELLI
060717176012
MAZDA
ZJ20-18-100
ZJ20-18-100A

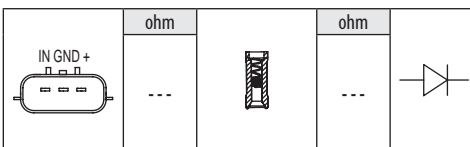
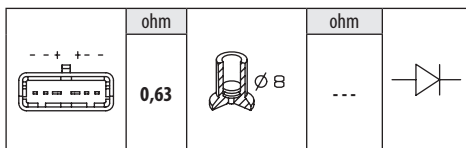
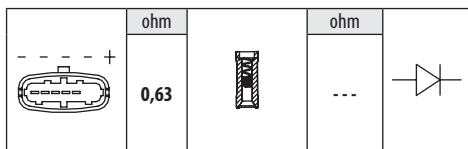

OPEL		
ASTRA F 1.8 i	X18XE1	03/98 ⇔ 08/00
ASTRA G 1.8	Z18XEL	02/03 ⇔ 07/04
ASTRA G 1.8 16V	X18XE1, Z18XE	03/00 ⇔ 10/05
ASTRA H 1.8	Z18XE	01/04 ⇔ 10/10
CORSA C 1.8	Z18XE	09/00 ⇔ 12/09
MERIVA A 1.8	Z18XE	05/03 ⇔ 05/10
SIGNUM 1.8	Z18XE	05/03 ⇔ 07/05
TIGRA B 1.8	Z18XE	06/04 ⇔ 12/10
VECTRA B 1.8 i 16V	X18XE1, Z18XE, Z18XEL	09/00 ⇔ 07/03
VECTRA C 1.8	Z18XE	04/02 ⇔ 07/08
VECTRA C 1.8 16V	Z18XE, Z18XEL	04/02 ⇔ 09/08
ZAFIRA A 1.8	Z18XEL	02/03 ⇔ 06/05
ZAFIRA A 1.8 16V	X18XE1, Z18XE	09/00 ⇔ 06/05

CITROËN		
C4 I 2.0 16V	RFK(EW10J4S)	11/04 ⇔ 12/10
C8 2.2	3FZ(EW12J4)	07/02 ⇔

PEUGEOT		
206 2.0 RC	RFK(EW10J4S)	07/03 ⇔ 12/07
307 2.0 16V	RFK(EW10J4S)	10/03 ⇔ 04/09
406 2.2	3FZ(EW12J4)	07/00 ⇔ 12/04
407 2.2	3FZ(EW12J4)	03/04 ⇔ 10/06
407 2.2 16V	3FY(EW12J4)	08/05 ⇔
607 2.2 16V	3FY(EW12J4), 3FZ(EW12J4)	02/00 ⇔ 06/10
807 2.2	3FZ(EW12J4)	06/02 ⇔

MAZDA		
2 II 1.3	ZJ-46, ZJ-VE	07/07 ⇔ 06/15
2 II 1.3 BiFuel	ZJ-46	05/11 ⇔ 11/14
2 II 1.3 MZR	ZJ-46, ZJ-VE	01/10 ⇔ 06/15
2 II 1.5	ZY06, ZY66, ZY-DE, ZY-VE	07/07 ⇔ 06/15
2 II 1.5 i	ZY-DE	05/10 ⇔ 06/15
2 II 1.5 MZR	ZY05, ZY66	06/11 ⇔ 06/15
3 I 1.3	ZJ-VE	10/03 ⇔ 06/09
3 I 1.4	FXJA	02/04 ⇔ 06/09
3 I 1.6	B6ZE, Z6, Z601, Z627	10/03 ⇔ 06/09
3 II 1.6 MZR	Z6	12/08 ⇔ 09/14
3 III 1.6	Z6Y1, Z6Y3	09/13 ⇔

EPS **1.970.514**  **05,5**

SAAB		
9-3 1.8 i	Z18XE	01/04 ⇔ 02/15

VAUXHALL		
ASTRA IV 1.8 16V	X18XE1, Z18XE	02/98 ⇔ 10/05
ASTRA IV 1.8 16V Dualfuel	Z18XE	07/02 ⇔ 08/05
ZAFIRA A 1.8 16V	X18XE1, Z18XE	09/00 ⇔ 08/05
ZAFIRA A 1.8 Dualfuel	Z18XE	09/00 ⇔ 08/05
ASTRA V 1.8	Z18XE	01/04 ⇔ 11/10
CORSA C 1.8 16V	Z18XE	08/00 ⇔ 09/06
MERIVA I 1.8 i 16V	Z18XE	05/03 ⇔ 06/10
SIGNUM 1.8	Z18XE	06/03 ⇔ 07/05
TIGRA B 1.8	Z18XE	06/04 ⇔ 08/09
VECTRA B 1.8 Dualfuel	Z18XE	09/00 ⇔ 07/03
VECTRA B 1.8 i 16V	X18XE1, Z18XE, Z18XEL	09/00 ⇔ 07/03
VECTRA C 1.8	Z18XEL	04/02 ⇔ 07/08
VECTRA C 1.8 16V	Z18XE	04/02 ⇔ 07/08
VECTRA C 1.8 16V Dualfuel	Z18XE	04/02 ⇔ 07/08

COILS
Adatt./Suitable:
BOSCH
0 986 221 091
HITACHI
133939
2503939
MAZDA
ZJ01-18-100
ZJ01-18-100A

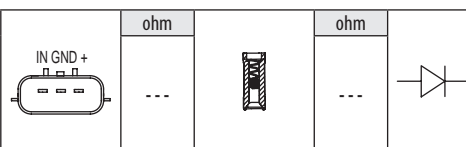

MAZDA		
2 II 1.3	ZJ-46	10/07 ⇔ 06/15
2 II 1.3 BiFuel	ZJ-46	05/11 ⇔ 11/14
2 II 1.5	ZY66	07/07 ⇔ 06/15
3 I 1.3	ZJ07, ZJ30, ZJ-VE	10/03 ⇔ 06/09
3 I 1.4	FXJA	02/04 ⇔ 06/09
3 I 1.6	B6ZE, Z6, Z601, Z627	10/03 ⇔ 06/09

EPS 1.970.518



COILS

Adatt./Suitable:

- BOSCH**
0 986 221 046
- DACIA**
82 00 702 693
- HITACHI**
138713
1548719
2508713
- MAGNETI MARELLI**
060717101012
060717190012
- NISSAN**
22462-00Q0A
- RENAULT**
82 00 702 693



	ohm		ohm
	0,41	∅ 4	5200

DACIA		
LOGAN I 1.0	D4D760	12/05 ⇨
LOGAN I 1.0 Hi-Flex	D4D760	01/11 ⇨ 10/12
LOGAN I 1.2 16V	D4F732	02/06 ⇨
LOGAN I 1.2 16V LPG	D4F734	02/06 ⇨
LOGAN II 1.0	D4D754	10/12 ⇨
LOGAN II 1.2	D4F732, D4F734	10/12 ⇨
LOGAN II 1.2 LPG	D4F732, D4F734	10/12 ⇨
LOGAN II MCV 1.2	D4F732	02/13 ⇨
LOGAN II MCV 1.2 LPG	D4F732, D4F734	02/13 ⇨
SANDERO I 1.0 Hi-Flex	D4D760	01/11 ⇨ 12/12
SANDERO I 1.2 16V	D4F732	11/08 ⇨
SANDERO I 1.2 16V LPG	D4F732, D4F734	11/08 ⇨
SANDERO II 1.0	D4D754	10/12 ⇨
SANDERO II 1.2	D4F732, D4F734	10/12 ⇨
SANDERO II 1.2 LPG	D4F732, D4F734	10/12 ⇨
NISSAN		
KUBISTAR 1.2 16V	D4F730	04/06 ⇨
RENAULT		
CLIO 1.2	D4F728	08/98 ⇨
CLIO II 1.2 16V	D4F722, D4F728	06/01 ⇨ 08/16
CLIO III 1.2	D4F740	10/05 ⇨ 12/14
CLIO III 1.2 16V	D4F740, D4F744, D4F764	06/05 ⇨
CLIO III 1.2 16V Hi-Flex	D4F740, D4F742, D4F744	11/07 ⇨ 12/14
CLIO III 1.2 Ethanol	D4F742	07/08 ⇨ 12/12
CLIO III 1.2 Hi-Flex	D4F742	11/07 ⇨ 12/09
CLIO IV 1.2 16V	D4F740, D4F744	11/12 ⇨
CLIO IV 1.2 16V LPG	D4F744	01/14 ⇨
CLIO IV 1.2 LPG	D4F744	01/14 ⇨
CLIO IV 1.2 LPG 16V	D4F744	11/12 ⇨ 06/15
KANGOO I 1.2 16V	D4F730	06/01 ⇨
LOGAN 1.0	D4D760	12/05 ⇨
LOGAN 1.2 16V	D4F732, D4F734	02/06 ⇨
LOGAN 1.2 16V LPG	D4F732, D4F734	12/13 ⇨
LOGAN/STEPWAY 1.2	D4F732, D4F734	11/13 ⇨
LOGAN/STEPWAY 1.2 16V LPG	D4F732, D4F734	11/13 ⇨
MODUS / GRAND MODUS 1.2	D4F740, D4F742, D4F744, D4F764	12/04 ⇨
MODUS / GRAND MODUS 1.2 16V Hi-Flex	D4F742	10/08 ⇨
MODUS / GRAND MODUS 1.2 GPL	D4F744	05/08 ⇨ 12/12
SANDERO I 1.2 16V	D4F732	11/08 ⇨
SANDERO II 1.2 16V	D4F732, D4F734	12/13 ⇨
SANDERO II 1.2 16V LPG	D4F734	12/13 ⇨
THALIA I 1.2i 16V	D4F728	04/04 ⇨
THALIA II 1.2 16V	D4F728, D4F736	09/08 ⇨ 06/14
TWINGO I 1.2 16V	D4F708	08/04 ⇨ 06/07
TWINGO II 1.2	D4F770	09/10 ⇨ 09/14
TWINGO II 1.2 16V	D4F764, D4F770, D4F772	03/07 ⇨

EPS 1.970.522



COILS

Adatt./Suitable:

- DENSO**
099 700-101
DIC-0143
- HITACHI**
134044
2504044
- HONDA**
30520-RNA-A01
- MAGNETI MARELLI**
060717150012

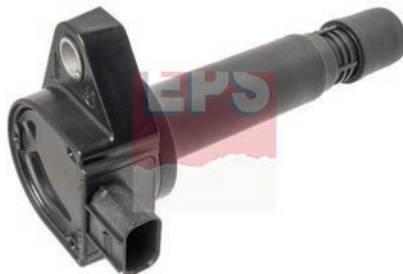

	ohm		ohm	
	---		---	

HONDA		
ACCORD VIII 2.0 i	R20A3	06/08 ⇨ 06/15
CIVIC VIII 1.6	R16A1, R16A2	09/05 ⇨
CIVIC VIII 1.8	R18A1, R18A2	09/05 ⇨
CIVIC VIII 1.8 EXS Flex	R18A1	11/06 ⇨
CR-V II 2.0	R20A1	06/04 ⇨
CR-V III 2.0 i	R20A2	01/07 ⇨
CR-V III 2.0 i-VTEC	R20A2	01/07 ⇨ 06/12
CR-V III 2.0 i-VTEC 4WD	R20A2	10/06 ⇨ 06/12
CR-V IV 2.0	R20A9	01/12 ⇨
FR-V 1.8	R18A1	01/07 ⇨

EPS 1.970.527



COILS

Adatt./Suitable:

- HITACHI**
133944
2503944
CM11-118
- HONDA**
30521-RBJ-003
30521-RBJ-013
30521-RBJ-S01



	ohm		ohm	
	---		---	

HONDA		
INSIGHT 1.3 IMA	LDA3	04/09 ⇨
JAZZ III 1.3 HYBRID	LDA3	04/11 ⇨

EPS 1.970.529



COILS

Adatt./Suitable:

- BOSCH**
0 986 JG1 225
- HITACHI**
133910
2503910
CM11-109
CM11-112
- HONDA**
30520-PWA-003
30520-PWA-013
30520-PWA-S01
30520-REA-Z01
- MAGNETI MARELLI**
060810229010



	ohm		ohm	
	---		---	

HONDA		
JAZZ II 1.2	L12A4	01/06 ⇨
JAZZ II 1.4	L13A6	01/06 ⇨
CITY 1.2	L12A2	05/03 ⇨
CITY 1.3	L13A3	10/05 ⇨ 07/08
CITY 1.5 i i-DSI	L15A2	11/02 ⇨
CIVIC VII 1.3 IMA	LDA1	10/03 ⇨ 09/05
JAZZ I 1.2 i-DSI	L12A1, L12A3, L12A4	03/02 ⇨ 07/08
JAZZ I 1.3 iDSi	L13A1, L13A6	03/02 ⇨ 07/08
JAZZ I 1.4	L13A5	04/05 ⇨ 07/08
JAZZ I 1.4 iDSI	L13A1, L13A6	12/06 ⇨ 10/08
CIVIC VIII 1.3 IMA	LDA2	01/06 ⇨
CIVIC VIII 1.4	L13A7	09/05 ⇨

1.970.532

EPS 1.970.532

07

COILS

Adatt./Suitable:

BOSCH
0 221 503 490
0 221 503 491

*1 Without fastening clamp

- Senza staffa di fissaggio
- sans bride de fixation
- ohne Befestigungsbügel
- sin estribo de sujeción

FORD

1 053 904 *1
1 066 102 *1
1 067 601
1 075 786
1 111 212
1 111 213 *1
1 119 835
1 130 402
1 317 972
1 319 788
1 319 929
1 517 813
1 619 343
157G-12029-AB
157G-12029-AC
157G-12029-AD
988F-12024-AB *1
988F-12029-AB
988F-12029-AC
988F-12029-AD
988F-12029-AE
988F-12029-BA
988F-12257-AB *1
9BBF-10029-BA
YM2F-12024-AC
YM2F-12024-AD
YM2F-12029-AA
YM2F-12029-AB

*245 without fastening clamp

- senza staffa fissaggio
- sans bride de fixation
- ohne Befestigungsbügel
- sin estribo de sujeción

HITACHI

138800
138803
138809
138811
2508800
2508803
2508809
2508811

MAGNETI MARELLI

060717036012
060717038012
060717178012
060801005010
BAE 680 C

MAZDA

1E03-18-10X *1
1E03-18-10XA *1
1E04-18-10X
1E05-18-100B
1F20-18-100
1F20-18-100A
C201-18-100
C201-18-100A
C201-18-100B
LF01-18-100
LF01-18-100A
YF09-18-10X

VOLVO

30735759
31359976



	ohm		ohm
	0,53	∅ 4	11800

FORD

FIESTA V 1.25 16V	FUJA, FUJB, M7JA, M7JB	05/02 ⇨ 06/08
FIESTA V 1.3	A9JA, A9JB, BAJA	11/01 ⇨ 08/08
FIESTA V 1.4	FXJA	05/02 ⇨ 09/05
FIESTA V 1.4 16V	FXJA, FXJB	11/01 ⇨ 06/08
FIESTA V 1.6 16V	FYJA, FYJB	11/01 ⇨ 06/08
FIESTA V ST150	N4JB	03/05 ⇨ 06/08
COUGAR 2.0 16V	EDBA, EDBB, EDBC, EDBD	08/98 ⇨ 12/01
ESCORT-NOMADE 1.6	8LH7(98CUL4), ZH16L1E	01/95 ⇨ 04/00
ESCORT-NOMADE 1.8	0LW2(273CUL8)	01/95 ⇨ 04/00
ESCORT IV 1.6 16V	L1E, L1K	10/98 ⇨ 07/00
ESCORT VI 1.3	J4B, J6A	01/95 ⇨ 02/99
ESCORT VI 1.6 16V	L1E, L1K	01/95 ⇨ 07/00
ESCORT VI 1.6 16V 4x4	L1E	01/95 ⇨ 10/98
ESCORT VI 1.6 16V XR3i	L1E, L1H, L1K	02/95 ⇨ 09/99
ESCORT VI 1.6 i 16V	L1E, L1H, L1K	01/95 ⇨ 02/99
ESCORT VI 1.8 16V	RDA, RKC	01/95 ⇨ 02/99

FORD

ESCORT VI 1.8 16V XR3i	RDA, RKC, RQB	02/95 ⇨ 08/98
FIESTA IV 1.0 i	OEAL	04/96 ⇨ 09/99
FIESTA IV 1.25 i 16V	DHA, DHB, DHC, DHD, DHE, DHF, DHG	08/95 ⇨ 01/02
FIESTA IV 1.3 i	J4C, J4J, J4L, J4Q, J4R, J4T, JBC, JJA, JJC, JJE, JJJ, JJK, JJM	08/95 ⇨ 01/02
FIESTA IV 1.4	FHA	08/98 ⇨ 04/02
FIESTA IV 1.4 i 16V	FHA, FHE	04/96 ⇨ 01/02
FIESTA IV 1.6 16V Sport	L1T, L1V	02/00 ⇨ 01/02
FIESTA 1.2	DHA, DHB, DHC, DHD, DHF, DHG	01/96 ⇨ 04/02
FIESTA 1.3	J4C, J4J, J4R	09/95 ⇨ 08/03
FOCUS I 1.4	FXDA, FXDB, FXDC, FXDD	04/99 ⇨ 03/05
FOCUS I 1.4 16V	FXDA, FXDB, FXDC, FXDD	10/98 ⇨ 11/04
FOCUS I 1.6	FYDA, FYDB, FYDC, FYDD	04/99 ⇨ 03/05
FOCUS I 1.6 16V	--, FYDA, FYDB, FYDC, FYDD, FYDH	02/99 ⇨ 11/04
FOCUS I 1.6 16V Flexifuel	FYDH	01/02 ⇨ 11/04
FOCUS I 1.8	EYDB, EYDC, EYDD, EYDE, EYDF, EYDG	04/99 ⇨ 03/05
FOCUS I 1.8 16V	EYDB, EYDC, EYDD, EYDE, EYDF, EYDG, EYDI, EYDJ, EYDL	10/98 ⇨ 11/04
FOCUS I 1.8 16V BiFuel	EYDD, EYDG, EYDI	09/02 ⇨ 07/04
FOCUS I 1.8 BiFuel	EYDL	02/03 ⇨ 01/05
FOCUS I 2.0 16V	EDDB, EDDC, EDDD, EDDF	10/98 ⇨ 11/04
FOCUS I RS	HMDA	10/02 ⇨ 11/04
FOCUS I ST170	ALDA	03/02 ⇨ 11/04
FOCUS II 1.4	ASDA, ASDB	07/04 ⇨ 09/12
FOCUS II 1.6	HWDA, HWDB, SHDA, SHDB, SHDC	07/04 ⇨ 09/12
FOCUS II 1.6 Ti	HXDA, HXDB, SIDA	07/04 ⇨ 09/12
FOCUS C-MAX 1.6	HWDA, HWDB, SHDA, SHDB, SHDC	10/03 ⇨ 03/07
FOCUS C-MAX 1.6 Ti	HXDA, HXDB, SIDA	08/04 ⇨ 03/07
FUSION 1.25	--, FUJA, FUJB	10/02 ⇨
FUSION 1.3	--, BAJA	08/02 ⇨
FUSION 1.4	--, FXJA, FXJB, FXJC	08/02 ⇨
FUSION 1.6	FYJA, FYJB, FYJC	08/02 ⇨ 11/09
FUSION 2.0	--	11/04 ⇨
GALAXY 1.2.0	ZVSA	03/96 ⇨ 03/06
GALAXY 1.2.0 i	NSE, ZVSA	11/95 ⇨ 05/06
GALAXY 1.2.3	ESSA, ESSB	05/00 ⇨ 03/06
GALAXY 1.2.3 16V	ESSA, ESSB, Y5B	09/01 ⇨ 05/06
IKON 1.3 Rocam	--	10/00 ⇨
KA I 1.3	A9A, A9B	09/02 ⇨ 03/04
KA I 1.3 i	BAA, J4D, J4K, J4M, J4N, J4P, J4S, JJB, JJD, JJE, JJG, JJJ, JJJ	09/96 ⇨ 11/08
KA I 1.3 i ROCAM	A9A, A9B	08/02 ⇨ 11/08
KA I 1.6 i	CCA, CDB, CDC, HL16SL9B	02/01 ⇨ 11/08
MAVERICK 2.0 16V	YF	02/01 ⇨
MAVERICK 2.0 16V FWD	YF	02/01 ⇨
MONDEO I 1.6 i	L1J	08/96 ⇨ 09/00
MONDEO I 1.6 i 16V	L1L, L1N, L1Q	05/98 ⇨ 09/00
MONDEO I 1.8 i	RKA, RKB, RKF, RKH, RKJ, RKK	08/96 ⇨ 09/00
MONDEO I 2.0 i	NGA, NGB, NGC, NGD	08/96 ⇨ 09/00
MONDEO II 1.8 16V	CGBA, CGBB, CHBA, CHBB	10/00 ⇨ 03/07
MONDEO II 2.0 16V	CJBA, CJBB	10/00 ⇨ 03/07
PUMA 1.4 16V	FHD, FHF	11/97 ⇨ 10/00
PUMA 1.6 16V	L1W	08/00 ⇨ 06/02
PUMA 1.7 16V	MHA, MHB	03/97 ⇨ 06/02
PUMA Racing ST 160	MHA	06/99 ⇨ 06/02
STREET KA 1.6	CDRA, CDRB	05/03 ⇨ 07/05
TOURNEO 1.8 BiFuel	EYPCNG	08/05 ⇨ 12/06
TOURNEO 1.8 LPG	EYPC	08/05 ⇨ 12/06
TOURNEO CONNECT I 1.8 16V	EYPA, EYPC, EYPD	06/02 ⇨ 12/13
TRANSIT 1.8 CNG	EYPCNG	05/02 ⇨ 12/13
TRANSIT CONNECT I 1.8 16V	EYPA, EYPC, EYPD	06/02 ⇨ 12/13
TRANSIT CONNECT I 1.8 16V LPG	EYPA, EYPC, EYPD	06/02 ⇨ 12/13

FORD (BR)

FIESTA 1.0i	ZL10	07/99 ⇨
FIESTA 1.6i	ZL16	07/99 ⇨

MAZDA

121 1.3	1E03, 1E04	01/96 ⇨ 05/97
121 III 1.25	1E05	03/96 ⇨ 04/03
121 III 1.3	1E03, 1E04, 1E09, J4R, J4T, JJK, JJM	03/96 ⇨ 04/03
21 1.2	FUJA	02/03 ⇨ 06/07
21 1.25	FUJA	04/03 ⇨ 06/07
21 1.3 L	ZJ-04	04/03 ⇨ 06/07
21 1.4	FXJA	02/03 ⇨ 06/07
21 1.5	ZY-VE	04/03 ⇨ 06/07
21 1.6	FYJA	02/03 ⇨ 06/07
TRIBUTE 2.0	0L65(396CUL8)	03/00 ⇨ 05/08
TRIBUTE 2.0 4WD	1L33(425CUL8)	03/00 ⇨ 05/08
TRIBUTE 2.0i [USA]	B	05/00 ⇨
TRIBUTE 2.0i 4x4 [USA]	B	05/00 ⇨

VOLVO

S40 II 1.6	B416453	01/05 ⇨ 12/12
------------	---------	---------------

VOLVO

V50 1.6	B416453	01/05 ⇨ 12/12
---------	---------	---------------

EPS 1.970.533

05,5

COILS

Adatt./Suitable:

HITACHI

2503902

INFINITI

22448-JA10C
22448-JA11C

NISSAN

22448-JA10A
22448-JA10C
22448-JA11C

RENAULT

22 44 8JA 10C



	ohm		ohm	
	...	∅ 4	...	

INFINITI

EX35 3.5 V6	VQ35HR	04/08 ⇨
FX 35	VQ35HR	07/08 ⇨ 12/11
FX 35 AWD	VQ35HR	07/08 ⇨ 12/10
M 25	VQ25HR	07/10 ⇨
M 35h	VQ35HR	04/11 ⇨
G SERIES 3.5 V6	VQ35HR	12/06 ⇨
G 25	VQ25HR	01/11 ⇨
G 35 X	VQ35HR	01/07 ⇨ 12/08
JX 3.5 AWD	VQ35DE	11/12 ⇨ 09/13
M35 3.5	VQ35HR	09/08 ⇨ 12/10
M35 3.5 h	VQ35HR	01/10 ⇨
M35 3.5 X	VQ35HR	09/08 ⇨ 12/10
Q50 50 Hybrid	VQ35HR	04/13 ⇨
Q50 50 Hybrid AWD	VQ35HR	04/13 ⇨
Q70 2.5	VQ25HR	05/15 ⇨
Q70 3.5 Hybrid	VQ35HR	03/13 ⇨
QX50 2.5 AWD	VQ25HR	02/14 ⇨
QX60 3.5 AWD	VQ35DE	10/13 ⇨

NISSAN

MURANO 3.5 CVT 4x4	VQ35DE	03/13 ⇨ 09/14
MURANO III 3.5 V6	VQ35DE	01/16 ⇨
MURANO III 3.5 V6 ALL MODE 4x4-i	VQ35DE	10/14 ⇨
MURANO II 3.5	VQ35DE	11/07 ⇨ 09/14
MURANO II 3.5 4x4	VQ35DE	11/07 ⇨ 09/14
TEANA II 2.5	VQ25DE	07/08 ⇨ 09/13
TEANA II 3.5	VQ35DE	07/08 ⇨ 09/13
TEANA III 3.5	VQ35DE	01/14 ⇨
TEANA III 3.5 CVT	VQ35DE	01/14 ⇨
PATHFINDER IV 3.5 4WD	VQ35DE	09/12 ⇨

RENAULT

LAGUNA III 3.5 V6	8T2150XSG15	04/08 ⇨ 12/15
LATITUDE 2.5 V6	2ZV604	05/11 ⇨
LATITUDE 3.5	5ZV604	05/11 ⇨

EPS 1.970.535



07,5

COILS

Adatt./Suitable:

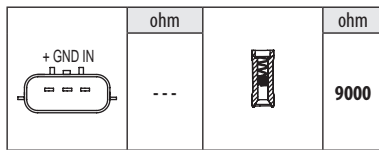
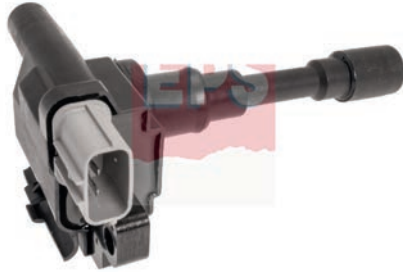
HITACHI
2503947**MAGNETI MARELLI**
060717159012**SUZUKI**33400-65G00
33400-65G00-000
33400-65G01
33400-65G01-000
33400-65G02
33400-65G02-000**SUZUKI**

ALTO VI 1.1	F10D, F10DN	09/04 → 12/08
BALENO 1.6	G16B	07/96 → 01/99
BALENO 1.6 i 16V	G16B	07/95 → 05/02
BALENO 1.6 i 16V 4x4	G16B	07/95 → 05/02
CARRY 1.3	G13BB	02/99 → 12/06
CARRY 1.3 16V	G13BB	03/00 →
ESTEEM 1.6i [USA]	G16B	09/98 →
GRAND VITARA II 1.6	M16A	10/05 →
GRAND VITARA II 1.6 4x4	M16A	09/05 → 02/15
GRAND VITARA II 1.6 Trazione integrale	M16A	04/05 → 02/15
SWIFT IV 1.3	M13A	02/05 →
SWIFT IV 1.3 4x4	M13A	02/05 →
SWIFT IV 1.3 LPG	M13A	09/08 → 12/10
SWIFT IV 1.5	M15A	02/05 →
SWIFT IV 1.5 4x4	M15A	02/05 →
SWIFT IV 1.6	M16A	05/06 →
SWIFT IV 1.6 4x4	M16A	02/05 →
IGNIS I 1.3	M13A	10/00 → 09/03
IGNIS I 1.3 4WD	M13A	10/00 → 09/03
IGNIS I 1.5 Sport	M15A	12/03 → 12/05
JIMNY III 1.3 4WD	M13A	03/13 →
LIANA 1.3	M13A	07/01 →
LIANA 1.6	M16A	07/01 →
LIANA 1.6 4WD	M16A	07/01 →
LIANA 1.6 i	M16A	04/02 →
LIANA 1.8 i	M18A	10/01 →
SX4 I 1.5	M15A	06/06 → 07/10
SX4 I 1.5 VVT	M15A	07/10 →
SX4 I 1.5 VVT 4x4	M15A	07/10 →
SX4 I 1.5 VVTi	M15A	07/07 → 12/15
SX4 I 1.6	M16A	10/07 →
SX4 I 1.6 AWD	M16A	10/07 →
SX4 I 1.6 LPG	M16A	06/06 → 12/12
SX4 I 1.6 VVT	M16A	06/06 →
SX4 I 1.6 VVT 4x4	M16A	06/06 →
WAGON R+ II 1.3	G13BB, M13A	05/00 →
WAGON R II 1.3	G13BB	04/99 → 10/00

EPS 1.970.536



05,5

COILS

Adatt./Suitable:

LEXUS
90919-02258**TOYOTA**
90919-02252
90919-02258

- NEW - ITEM NOW AVAILABLE FROM PRODUCTION

- NUOVO - ARTICOLO ORA DISPONIBILE PER LA VENDITA
- NOUVEAU - ARTICLE DISPONIBLE EN PRODUCTION COURANTE
- NEU - JETZT ZUM VERKAUF VERFÜGBARER ARTIKEL
- NUEVO - ARTICULO AHORA DISPONIBLE EN PRODUCCION

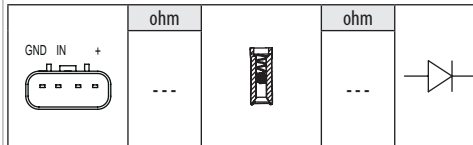
**LEXUS**

CT 200h	2ZR-FXE	12/10 →
NX 200	3ZR-FAE	11/14 →
NX 200 AWD	3ZR-FAE	11/14 →

TOYOTA

COROLLA X 1.6	1ZR-FAE, 1ZR-FE	11/06 → 11/13
COROLLA X 1.6 Dual VVTi	1ZR-FE	01/07 → 07/14
COROLLA X 1.6 VVTi	1ZR-FE	03/07 → 05/14
COROLLA X 1.8	2ZR-FAE, 2ZR-FE	09/06 →
COROLLA X 1.8 4WD	2ZR-FAE	09/06 →
COROLLA X 1.8 VVTi	2ZR-FBE, 2ZR-FE	08/10 →
COROLLA X 2.0	3ZR-FE	04/10 →
COROLLA X 2.0 FlexFuel	3ZR-FBE	04/10 →
COROLLA X 2.0 VVTi	3ZR-FE	08/10 →
AURIS I 1.6	1ZR-FAE, 1ZR-FE	03/07 → 09/12
AURIS I 1.8	2ZR-FAE, 2ZR-FE	10/06 → 09/12
AURIS I 1.8 4WD	2ZR-FAE	10/06 → 10/09
AURIS I 1.8 Hybrid	2ZR-FXE	09/10 → 09/12
AURIS II 1.6	1ZR-FAE	10/12 → 12/18
AURIS II 1.8 Hybrid	2ZR-FXE	10/12 → 12/18
AVENSIS III 1.6	1ZR-FAE	11/08 → 10/18
AVENSIS III 1.8	2ZR-FAE	11/08 → 10/18
AVENSIS III 2.0	3ZR-FAE, 3ZR-FE	11/08 → 10/18
C-HR 2.0	3ZR-FAE	11/16 →
COROLLA IX 1.6	1ZR-FE	11/06 → 07/07
COROLLA XI 1.6	1ZR-FAE, 1ZR-FE	06/13 → 12/18
COROLLA XI 1.6 BiFuel	1ZR-FE	06/13 →
COROLLA XI 1.8	2ZR-FAE	05/12 →
COROLLA XI 1.8 [USA] [CAN]	2ZR-FAE	08/13 →
COROLLA XI 1.8 VVTi	2ZR-FE	06/13 → 08/19
COROLLA XI 1.8 VVT-i	2ZR-FE	12/13 →
COROLLA XI 2.0 VVT-i CNG	3ZRFECNG	10/13 → 12/18
COROLLA 1.6 VVTi	1ZR-FAE, 1ZR-FE	01/19 →
MATRIX 1.8	2ZR-FE	01/08 → 05/14
RAV 4 IV 2.0	3ZR-FE	12/12 →
RAV 4 IV 2.0 4WD	3ZR-FAE, 3ZR-FE	12/12 →
PRIUS III 1.8 Hybrid	2ZR-FXE, 5ZR-FXE	06/08 →
PRIUS 1.8 Plug-In Hybrid	2ZR-FXE	01/12 →
PRIUS PLUS 1.8 Hybrid	2ZR-FXE	11/14 →
RAV 4 2.0 VVTi 4WD	3ZR-FAE	12/12 → 11/18
RAV 4 III 2.0	3ZR-FAE	12/08 → 06/13
RAV 4 III 2.0 4WD	3ZR-FAE	12/08 → 06/13
VERSO 1.6	1ZR-FAE	04/09 → 08/18
VERSO 1.8	2ZR-FAE	04/09 → 08/18
VERSO VVTi	1ZR-FAE, 2ZR-FAE	04/09 → 08/18
YARIS II 1.6 [CHN]	1ZR-FE	05/08 →
YARIS II 1.8 VVTi	2ZR-FE	01/07 → 12/11
YARIS III 1.8 GRMN	2ZR-FE	09/17 →

COILS

Adatt./Suitable:

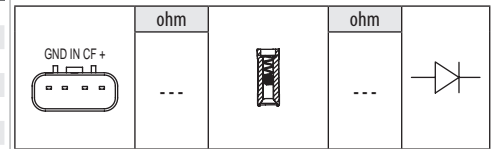
ASTON MARTIN
9091902257**BOSCH**
0 986 AGO 501
F 005 X11 797**DAIHATSU**
90919-02257**DENSO**
DIC-0132
DIC-0147**HITACHI**
134038
2504038**LEXUS**
90919-02250
90919-02256
90919-A2003
90919-A2005
90919-C2004**SUBARU**
90919-02257**TOYOTA**90919-02250
90919-02256
90919-02257
90919-A2003
90919-A2005
90919-A2008
90919-C2004**ASTON MARTIN**

CYGNET 1.3	1NR-FE	04/11 → 10/13
------------	--------	---------------

DAIHATSU

CHARADEVI 1.33 16V	1NR-FE	05/11 →
--------------------	--------	---------

LEXUS

ES 200	6AR-FSE	08/15 →
ES 250	2AR-FE	06/12 → 06/18
ES 300h	2AR-FXE	06/12 → 06/18
GS 250	4GR-FSE	01/12 →
GS 3.5 450h	2GR-FXE	03/12 → 09/18
GS 3.5 VVTi	2GR-FSE	04/05 → 12/12
GS 300	3GR-FE, 3GR-FSE	04/05 → 11/11
GS 300h	2AR-FSE	10/13 →
GS 350	2GR-FSE	09/06 →
GS 350 AWD	2GR-FKS, 2GR-FSE	09/06 →
GS 450h	2GR-FSE, 2GR-FXE	02/06 →
GX 460 4WD	1UR-FE	01/10 →
IS II 250	4GR-FSE	08/05 →
IS II 250 AWD	4GR-FSE	10/05 → 03/13
IS II 350	2GR-FSE	01/08 →
IS III 250	4GR-FSE	04/13 →
IS III 300h	2AR-FSE	04/13 →
LS IV 460	1UR-FE, 1UR-FE-E4, 1UR-FE-E5, 1UR-FSE-E4, 1UR-FSE-E5	04/06 →
LS IV 460 4WD	1UR-FSE	08/06 →
LS IV 460 AWD	1UR-FE-E4, 1UR-FSE	12/08 →
LS IV 600h AWD	2UR-FSE, 2URFSE-E4, 2UR-FSE-E5	04/07 →
LX 570	3UR-FE	08/07 →
NX 300h	2AR-FXE	07/14 →
NX 300h AWD	2AR-FXE	07/14 →
RC 300h	2AR-FSE	09/14 →
RC 350	2GR-FSE	08/14 →
RX III 270	1AR-FE	12/08 → 10/15
RX III 450h AWD	2GR-FXE, 2GRFXE(299H)-E4	12/08 → 10/15

SUBARU

TREZIA 1.3	1NR-FE	03/11 →
------------	--------	---------

TOYOTA

COROLLA X 1.33	1NR-FE	12/08 → 07/14
AURIS I 1.33 Dual-VVTi	1NR-FE	05/09 → 09/12
AURIS II 1.3	1NR-FE	10/12 → 12/18

1.970.538

TOYOTA		
CAMRY 2.0	6ARFSE	12/14 →
CAMRY 2.5	2AR-FE	01/10 →
CAMRY 2.5 [CHN]	5AR-FE	12/11 →
CAMRY 2.5 Hybrid	2AR-FXE	09/11 →
CAMRY 2.5 Hybrid [CHN]	4AR-FXE	05/12 →
COROLLA XI 1.3	1NR-FE	05/12 →
LAND CRUISER 200 4.0	1GR-FE	01/10 →
LAND CRUISER 200 4.6 V8	1UR-FE	09/10 →
LAND CRUISER 200 5.7 V8	3UR-FE	08/07 →
FJ CRUISER 4.0	1GR-FE	06/05 → 06/14
FJ CRUISER 4.0 4WD	1GR-FE	06/05 → 01/18
HIGHLANDER / KLUGER 2.7	1AR-FE	09/16 →
IQ 1.33	1NR-FE	01/09 →
LAND CRUISER 4.0 V6 VVTi	1GR-FE	08/09 →
LAND CRUISER 150 4.0 V6 Dual VVTi	1GR-FE	08/09 →
LAND CRUISER 150 4.0 V6 VVTi	1GR-FE	08/09 →
LAND CRUISER 150 4.0 V6 VVT-i	1GR-FE	08/09 →
RAV 4 IV 2.5	2AR-FE	12/12 → 11/18
RAV 4 IV 2.5 4WD	2AR-FE	12/12 →
RAV 4 IV 2.5 Hybrid	2AR-FXE	10/15 → 11/18
RAV 4 IV 2.5 Hybrid 4WD	2AR-FXE	10/15 → 12/18
RAV 4 III 2.5	2AR-FE	12/08 →
SIENNA 2.7	1AR-FE	09/10 → 07/13
URBAN CRUISER 1.33	1NR-FE	01/09 → 03/16
VENZA 2.7	1AR-FE	11/08 → 11/16
VENZA 2.7 4WD	1AR-FE	11/08 → 11/16
VERSO S 1.33	1NR-FE	11/10 → 10/16
YARIS II 1.33 VVT-i	1NR-FE	11/08 → 12/11
YARIS III 1.3	1NR-FE	09/11 →
YARIS III 1.3 4WD	1NR-FE	12/10 →
YARIS III 1.3 VVTi	1NR-FE	10/12 →
YARIS III 1.5	2NR-FKE	03/17 →
YARIS III 1.5 VVTi	2NR-FKE	03/17 →

EPS 1.970.538



COILS

Adatt./Suitable:

LEXUS

90919-02251
90919-02255
90919-A2004
90919-A2007

TOYOTA

90919-02251
90919-02255
90919-A2002
90919-A2004
90919-A2007

NEW - ITEM NOW AVAILABLE FROM PRODUCTION

- NUOVO - ARTICOLO ORA DISPONIBILE PER LA VENDITA
- NOUVEAU - ARTICLE DISPONIBLE EN PRODUCTION COURANTE
- NEU - JETZT ZUM VERKAUF VERFÜGBARER ARTIKEL
- NUEVO - ARTICULO AHORA DISPONIBLE EN PRODUCCION



ohm		ohm	
	...		

LEXUS

ES 3.5	2GR-FE	05/06 → 06/12
ES 350	2GR-FE	06/12 → 06/18
RX II 350	2GR-FE	01/06 → 12/08
RX II 350 AWD	2GR-FE, 2GR-FE(276)	02/06 → 12/08
RX III 350	2GR-FE	01/09 → 09/15
RX III 350 AWD	2GR-FE	12/08 → 08/15
RX III 450h	2GR-FXE	12/08 → 10/15
RX III 450h AWD	2GR-FXE	12/08 → 10/15

TOYOTA

AURION 3.5	2GR-FE	03/06 →
CAMRY 3.5	2GR-FE	01/06 →
HIGHLANDER / KLUGER 3.5 AWD	2GR-FE, 2GR-FKS	09/14 →
RAV 4 III 3.5 AWD	2GR-FE	11/05 →
SIENNA 3.5	2GR-FE	01/10 →
SIENNA 3.5 4WD	2GR-FE	01/10 →
PREVIA III 3.5	2GR-FE	01/06 →

TOYOTA

PREVIA III 3.5 4WD	2GR-FE	01/06 →
VENZA 3.5	2GR-FE	11/08 → 11/16
VENZA 3.5 4WD	2GR-FE	11/08 → 11/16

EPS

1.970.543



COILS

Adatt./Suitable:

BOSCH

0 986 221 063

HITACHI

134035

2504035

HYUNDAI

27301-2B010

KIA

27301-2B010



ohm		ohm	
	0,81		5640

HYUNDAI

ACCENT 1.4 CVVT	G4FA	11/10 →
CRETA 1.6	G4FG	01/16 →
CRETA 1.6 4WD	G4FG	08/16 →
ELANTRA V 1.6	G4FG	04/11 →
ACCENT IV 1.4	G4FA	11/10 →
ACCENT IV 1.6	G4FC	11/10 →
I20 I 1.4	G4FA	09/08 → 12/15
I20 I 1.4 LPG	G4FA	12/08 → 12/12
I20 I 1.6	G4FC	09/08 → 12/12
I30 I 1.4	G4FA	10/07 → 06/12
I30 I 1.4 LPG	G4FA	01/09 → 06/12
I30 I 1.6	G4FC	10/07 → 06/12
I30 II 1.4	G4FA, G4LC	12/11 →
I30 II 1.4 LPG	G4FA	01/13 →
I30 II 1.6	G4FC, G4FG	12/11 →
I30 II 1.6 MPI	G4FC	06/14 →
IX20 1.4	G4FA	11/10 →
IX20 1.4 LPG	G4FA	11/10 →
IX20 1.6	G4FC	11/10 →
IX20 1.6 LPG	G4FC	11/10 →
SB 11 1.4	--	01/11 →
SB 11 1.6	--	01/11 →
SOLARIS 1.4 16V	--	01/11 →
SOLARIS 1.4 VVTi	G4FA	11/10 →
SOLARIS 1.6	G4FG	01/17 →
SOLARIS 1.6 16V	--	01/11 →
VELOSTER 1.6	G4FG	06/11 →
VELOSTER 1.6 MPI	G4FC	04/11 → 12/17

KIA

CARENS II 1.6 CVVT	G4FC	08/09 →
CEED I 1.4	G4FA	12/06 → 12/12
CEED I 1.4 CVVT	G4FA, G4FA-L	07/09 → 12/12
CEED I 1.4 LPG	G4FA	01/09 → 04/12
CEED I 1.6	G4FC	12/06 → 12/12
CEED I 1.6 CVVT	G4FC	06/09 → 12/12
CEED I 1.6 LPG	G4FC	06/07 → 09/12
CEED II 1.4 CVVT	G4FA, G4FA-L	05/12 → 07/18
CEED II 1.4 LPG	G4FA	05/12 → 07/18
CEED II 1.6 CVVT	G4FC	05/12 →
CEED III 1.6	G4FG	03/18 →
CERATO I 1.6	G4FC	05/06 →
CERATO II 1.6	G4FC	01/10 → 06/13
CERATO II 1.6 CVVT	G4FC	02/09 →
CERATO III 1.6	--	07/12 →
CERATO III 1.6 CVVT	G4FC	07/16 →
CERATO III 1.6 MPI	G4FG	06/13 →
FORTE 1.6	--	07/12 →
PRO CEE'D I 1.4	G4FA	02/08 → 09/12
PRO CEE'D I 1.4 CVVT	G4FA, G4FA-L	06/10 → 09/12

KIA

PRO CEE'D I 1.6	G4FC	02/08 → 09/12
PRO CEE'D I 1.6 CVVT	G4FC	02/08 → 02/13
PRO CEE'D II 1.4 CVVT	G4FA	03/13 → 07/18
PRO CEE'D II 1.4 MPI	G4LC	07/13 → 07/18
PRO CEE'D II 1.6 CVVT	G4FC	03/13 → 07/18
PRO CEE'D 1.4 CVVT	G4FA	05/12 → 07/18
RIO III 1.4 CVVT	G4FA	06/11 →
RIO III 1.6 CVVT	G4FC	06/12 → 12/17
RIO IV 1.6	G4FG	01/17 →
SOUL I 1.6	G4FC	09/09 → 12/14
SOUL I 1.6 CVVT	G4FC	02/09 → 12/14
SOUL I 1.6 Flex	--	01/11 →
SOUL I 1.6 LPG	G4FC	02/09 → 12/14
SOUL II 1.6 CVVT	G4FG	02/14 →
SOUL II 1.6 LPG	G4FG	12/14 →
SOUL III 1.6 MPI	G4FG	01/19 →
VENGA 1.4 CVVT	G4FA, G4FA-L	02/10 →
VENGA 1.4 LPG	G4FA	02/10 →
VENGA 1.6 CVVT	G4FC	02/10 →
VENGA CVVT	G4FA, G4FC	02/15 →

EPS

1.970.545



COILS

Adatt./Suitable:

BOSCH

0 986 221 098

0 986 221 109

CHEVROLET

25186687

55561655

55584404

96476983

GENERAL MOTORS

25 186 687

55 561 655

55 584 404

96 476 983

OPEL

12 08 086

12 08 098

55561655

55584404

SIEMENS

5WK 9397

VAUXHALL

55561655

55584404

NEW - AVAILABLE FROM:

- NUOVO - DISPONIBILE DA:
- NOUVEAU - DISPONIBLE EN:
- NEU - VERFÜGBAR AB:
- NUEVO - DISPONIBLE EN:

22/04



ohm		ohm	
	...		

CHEVROLET

AVEO II 1.6	LDE	03/11 →
CRUZE 1.6	LDE	06/11 →
TRAX 1.6	LDE	12/12 →
TRAX 1.8	2HO	03/13 →
TRAX 1.8 AWD	2HO	03/13 →

OPEL

ASTRA J 1.6	A16LET, A16XER, B16XER	12/09 →
ASTRA J 1.6 LPG	A16XER	10/12 → 10/15
ASTRA J 1.6 Turbo	A16LET	12/09 →
ASTRA J 1.8	A18XER	10/11 → 10/15
ZAFIRA TOURER 1.8	A18XEL, A18XER	10/11 →
ZAFIRA TOURER 1.8 LPG	A18XER	10/11 →
CORSA E 1.6 Turbo	B16LER, B16LES	03/15 →
INSIGNIA A 1.4	B18XER	04/11 →
INSIGNIA A 1.6	A16XER	07/08 → 03/17
INSIGNIA A 1.8	A18XER, B18XER	07/08 → 03/17
MOKKA 1.6	A16XER, B16XER, D16XER	06/12 →
MOKKA 1.8	A18XER	01/13 →
MOKKA 1.8 4x4	A18XER	01/13 →
ZAFIRA B 1.8	A18XEL	06/13 → 04/15

VAUXHALL

ASTRA V 1.6	A16XER	08/04 → 03/11
-------------	--------	---------------

VAUXHALL		
ASTRA V 1.8	A18XER	12/05 → 10/10
ASTRA VI 1.6	A16LET, A16XER, B16XER	12/09 → 10/15
ASTRA VI 1.6 Turbo	A16LET	12/09 → 10/15
CORSA E 1.6 VXR	B16LES	04/15 →
INSIGNIA 1.6	A16XER	07/08 → 05/17
INSIGNIA 1.8	A18XER, B18XER	07/08 → 05/17
MOKKA / MOKKA X 1.6	A16XER, B16XER, D16XER	06/12 →
ZAFIRA B 1.8	A18XEL	04/13 → 11/14
ZAFIRA C 1.8	A18XEL, A18XER	10/11 →

EPS **1.970.547**  **08,5**

COILS
Adatt./Suitable:

BOSCH
0 221 503 800
0 986 221 096

CHEVROLET
25195107
25198623
25200553
55575499
55577898
55579072
95528319

GENERAL MOTORS
25 195 107
25 198 623
55 573 735
55 575 499
55 577 898
55 579 072
95 528 319

HITACHI
134048
2504048

MAGNETI MARELLI
060717137012

OPEL
12 08 092
12 08 093
12 08 096
12 08 123
25195107
25198623
55573735
55577898
55579072
95528319

VAUXHALL
25195107
25198623
55573735
55577898
55579072
95528319

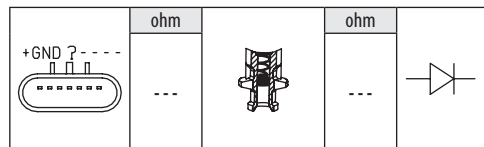

CHEVROLET		
AVEO I 1.4	A14XER	04/08 →
AVEO II 1.2	LDC, LWD	03/11 →
AVEO II 1.2 LPG	LDC	11/12 → 12/15
AVEO II 1.4	LDD	03/11 →
AVEO II 1.4 Turbo	A14NET	08/13 →
CRUZE 1.4	A14NET, A14XER, LDD, LUJ	09/10 →
ORLANDO 1.4	LUJ	06/12 →
TRAX 1.4	A14NET	12/12 →
TRAX 1.4 AWD	A14NET	12/12 →
TRAX 1.4 LPG	A14NET	04/13 →
VOLT EV 150	LUU	11/11 →

OPEL		
ADAM 1.2	A12XEL, B12XEL, D12XEL	10/12 → 02/19
ADAM 1.4	A14XEL, A14XER, B14XEL, B14XER, D14XEL, D14XER	10/12 → 02/19
ADAM 1.4 LPG	A14XEL, B14XEL, D14XEL	07/13 → 11/18
ADAM 1.4 S	B14NEH, D14NEH	11/14 → 01/19
AMPERA EV 150	A14XFL	11/11 → 03/15
ASTRA J 1.4	A14NET, A14NET, A14XEL, A14XER, B14NET, B14NET, B14XER	12/09 →
ASTRA J 1.4 LPG	A14NET	12/11 →

OPEL		
ASTRA J 1.4 Turbo	A14NEL, A14NET, B14NEL, B14NET	12/09 →
ZAFIRA TOURER 1.4	A14NEL, A14NET, B14NEL, B14NET	10/11 →
ZAFIRA TOURER 1.4 LPG	A14NET, B14NET	10/11 →
CASCADA 1.4	A14NEL, B14NEL	03/13 →
CASCADA 1.4 Turbo	A14NET, B14NET	03/13 →
CORSA D 1.2	A12XEL, A12XER	12/09 → 08/14
CORSA D 1.2 LPG	A12XER	06/11 → 08/14
CORSA D 1.4	A14NEL, A14XEL, A14XER	09/09 → 08/14
CORSA D 1.4 LPG	A14XEL	09/09 → 08/14
CORSA E 1.2	B12XEL	09/14 →
CORSA E 1.4	B14XEJ, B14XEL, D14XEL	09/14 →
CORSA E 1.4 LPG	B14XEL	03/15 →
CORSA E 1.4 Turbo	B14NEH, B14NEJ, D14NEH, D14NEJ	09/14 →
INSIGNIA A 1.4	A14NET, B14NET	04/11 → 03/17
INSIGNIA A 1.4 LPG	A14NET, B14NET	07/12 → 03/17
MERIVA B 1.4	A14NEL, A14NET, A14XER, B14NEL, B14NET, B14XER	06/10 → 03/17
MERIVA B 1.4 LPG	A14NEL, B14NEL	06/11 → 03/17
MERIVA 1.4 ECOTEC	A14XER	01/13 → 03/17
MOKKA 1.4	A14NET, B14NET, D14NET	04/13 →
MOKKA 1.4 4x4	A14NET, B14NET, D14NET	06/12 →
MOKKA 1.4 LPG	A14NET, B14NET, D14NET	04/13 →

VAUXHALL		
ADAM 1.2	A12XEL, B12XEL, D12XEL	10/12 → 04/19
ADAM 1.4	A14XEL, A14XER, B14XEL, B14XER, D14XEL	10/12 → 02/19
ADAM 1.4 LPG	A14XEL	07/13 →
ADAM 1.4 S	B14NEH	11/14 → 01/19
AMPERA EV 150	4ET50, A14XFL	03/12 →
CASCADA 1.4	A14NEL, A14NET, B14NET	02/13 →
ASTRA VI 1.4	A14NEL, A14NET, A14XEL, A14XER, B14NEL, B14NET, B14XER	12/09 → 10/15
ASTRA VI 1.4 Turbo	A14NEL, A14NET, B14NET	12/09 →
CORSA D 1.2	A12XEL	06/10 → 08/14
CORSA D 1.2 i 16V	A12XER	12/09 → 08/14
CORSA D 1.2 LPG	A12XER	06/11 → 08/14
CORSA D 1.4	A14NEL, A14XEL, A14XER	09/09 → 08/14
CORSA D 1.4 LPG	A14XEL	09/09 → 08/14
CORSA E 1.2	B12XEL	08/14 →
CORSA E 1.4	B14NEH, B14XEJ, B14XEL, B14NEJ, D14NEJ, D14XEL	08/14 →
CORSA E 1.4 LPG	B14XEL	08/14 →
CORSAVAN III 1.2	A12XEL	01/10 →
CORSAVAN IV 1.2	B12XEL	10/14 →
CORSAVAN IV 1.4	B14XEJ	10/14 →
INSIGNIA 1.4	A14NET, B14NET	04/11 → 05/17
INSIGNIA 1.4 LPG	A14NET	07/12 → 05/17
MERIVA II 1.4	A14NEL, A14NET, A14XER, B14NEL, B14NET, B14XER	06/10 →
MERIVA II 1.4 LPG	A14NEL, B14NET	06/11 →
MOKKA / MOKKA X 1.4	A14NET, B14NET, D14NET	04/13 →
MOKKA / MOKKA X 1.4 4x4	A14NET, B14NET, D14NET	06/12 →
ZAFIRA C 1.4	A14NEL, A14NET, B14NET	10/11 → 08/18
ZAFIRA C 1.4 LPG	A14NET	10/11 → 08/18

EPS **1.970.549**  **05,5**

COILS
Adatt./Suitable:

ABARTH
55224110
55229959

ALFA ROMEO
46337742
55214926
55224110
55229959
55263679
55267630
55270217

BOSCH
0 221 504 026
0 221 504 036

CHRYSLER
55214926
55229959

FIAT
46337742
55214926
55224110
55229959
55263679
55270217

JEEP
46337742
55224110
55229959
55263679
55270217
68298269AA
K68298228AA
K68298269AA
K68436928AA

LANCIA
55214926
55229959

MAGNETI MARELLI
060810224010

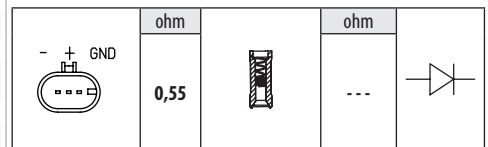

ABARTH		
PUNTO 1.4	955A8.000	03/12 →
PUNTO 1.4 SUPERSPORT	199A8.000, 955A8.000	03/12 →
PUNTO EVO 1.4	955A8.000	10/09 → 02/12
ALFA ROMEO		
159 1.8 Tbi	939B1.000	05/09 → 12/12
4C 1.8	960A1.000	03/13 → 12/20
BRERA 1.8 Tbi	939B1.000	05/09 → 06/10
GIULIETTA II 1.4	940A2.000	04/11 → 12/20
GIULIETTA II 1.4 TB	940A2.000, 940C2.000, 955A8.000	04/10 → 10/18
GIULIETTA II 1.8	940A1.000	04/11 → 02/16
GIULIETTA II 1.8 Tbi	940A1.000, 940B2.000, 960A1.000	04/10 → 10/18
MITO 1.4 MultiAir	940A2.000	09/09 → 10/18
MITO 1.4 TB	955B1.000	12/13 → 10/18
MITO 1.4 Turbo MultiAir	955A2.000, 955A7.000, 955A8.000	10/09 → 10/18
SPIDER III 1.8 Tbi	939B1.000	05/09 → 03/11

CHRYSLER		
DELTA 1.4 16V	198A7.000	08/11 →
FIAT		
PUNTO III EVO 1.4 16V	955A2.000	10/09 → 02/12
PUNTO III 1.4 Turbo Multi Air	955A2.000	03/12 →
500X 1.4	55263624	09/14 →
500X 1.4 4x4	55263623	02/15 →
500X 1.4 LPG	55277701	03/17 →
BRAVO II 1.4 16V	-, 198A7.000	04/07 →
JEEP		
COMPASS 1.4 MultiAir	EAQ(55263624)	03/17 →
COMPASS 1.4 MultiAir Trazione integrale	EAQ(55263623)	03/17 →
RENEGADE 1.4	55263624, EAM, EAM(55263624)	07/14 →
RENEGADE 1.4 4x4	EAM, EAM(55263623)	07/14 →

LANCIA		
DELTA III 1.4 16V	198A7.000	07/10 → 08/14
DELTA III 1.8	939B1.000	01/09 → 08/14

EPS **1.970.551**  **05,5**

COILS

Adatt./Suitable:

HITACHI
133929
2503929

NISSAN
22448-1KCOA

RENAULT
22 44 81K COA

NEW - ITEM NOW AVAILABLE FROM PRODUCTION

- NUOVO - ARTICOLO ORA DISPONIBILE PER LA VENDITA
- NOUVEAU - ARTICLE DISPONIBLE EN PRODUCTION COURANTE
- NEU - JEITZ ZUM VERKAUF VERFÜGBARER ARTIKEL
- NUEVO - ARTICULO AHORA DISPONIBLE EN PRODUCCION

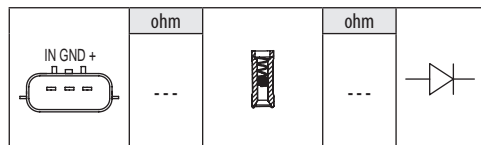
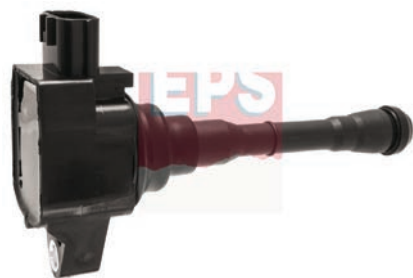

NISSAN

JUKE I 1.6	MR16DDT	03/13 →
JUKE I 1.6 DIG-T	MR16DDT	06/10 →
JUKE I 1.6 DIG-T 4x4	MR16DDT	06/10 →
JUKE I 1.6 DIG-T NISMO	MR16DDT	03/13 → 07/14
JUKE I 1.6 DIG-T NISMO 4x4	MR16DDT	02/13 → 07/14
JUKE I 1.6 DIG-T NISMO RS	MR16DDT	08/14 →
JUKE I 1.6 DIG-T NISMO RS 4x4	MR16DDT	08/14 →
X-TRAIL III 1.6 DIG-T	MR16DDT	06/15 →
X-TRAIL III 2.0	MR20DD	09/14 →
X-TRAIL III 2.0 ALL MODE 4x4-i	MR20DD	09/14 →
PULSAR 1.6 DIG-T	MR16DDT	02/15 →
SENTRA VII 1.6 DIG-T	MR16DDT	07/12 →
SYLPHY III 1.6 DIG-T	MR16DDT	07/12 →
QASHQAI II 1.6 DIG-T	MR16DDT	10/14 →
QASHQAI II 2.0	MR20DD	06/14 →
QASHQAI II 2.0 ALL MODE 4x4-i	MR20DD	10/15 →
TIIDA II 1.6	MR16DDT	02/13 →
TIIDA II 1.6 DIG-T	MR16DDT	08/11 →
X-TRAIL 2.0	MR20DD	12/14 →
X-TRAIL 2.0 ALL MODE 4x4-i	MR20DD	12/14 →

RENAULT

CLIO IV 1.6 RS	M5M400, M5M401	03/13 →
CLIO IV 1.6 RS Trophy	M5M401	03/15 →
MEGANE IV 1.6 Tce 165	M5M450	07/17 →
MEGANE IV 1.6 Tce 205	M5M450	11/15 →
MEGANE IV 1.8 RS 300	M5P404	09/18 →
MEGANE IV 1.8 RS Tce 280	M5P402, M5P404	10/17 →
ESPACE V 1.6 Tce 200	M5M450	02/15 →
ESPACE V 1.8 Tce 225	5T2175X15DYA, M5P403	10/16 →
KADJAR 1.6 Tce 165	M5M460	11/16 →
KOLEOS 2.0 Tce	M5R402	08/16 →
LATITUDE 1.6 RS	M5M400	04/14 →
TALISMAN 1.6 Tce 150	M5M450	11/15 →
TALISMAN 1.6 Tce 200	M5M450	11/15 →
TALISMAN 1.8 Tce 225	M5P403	09/18 →

EPS **1.970.552**  **05,5**

COILS

Adatt./Suitable:

BOSCH
0 986 221 090

DACIA
22 43 327 34R

HITACHI
133901
2503901

INFINITI
22448-JA00C

MAGNETI MARELLI
060717203012

NISSAN
22448-1KTOA
22448-1KT1A
22448-3RCOA
22448-ED000
22448-JA00A
22448-JA00C

RENAULT
22 43 327 34R
22 43 392 77R
22 44 81K TOA
22 44 83R COA
22 44 8JA 00C

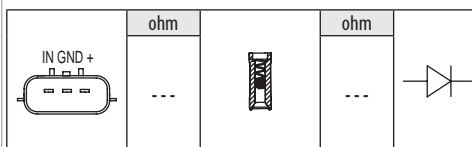

DACIA

DUSTER 1.0 LPG	H4D450, H4D460	01/19 →
DUSTER 1.0 Tce 100	H4D450, H4D460	01/19 →
DUSTER 1.0 Tce 100 4x4	H4D450, H4D460	01/19 →
DUSTER 1.0 Tce 90	H4D470	05/21 →
LOGAN II MCV 1.0 LPG	H4D450, H4D460	11/19 →
LOGAN II MCV 1.0 Tce 100	H4D450, H4D460	11/19 →
SANDERO II 1.0 LPG	H4D450, H4D460	11/19 →
SANDERO II 1.0 Tce 100	H4D450, H4D460	11/19 →
SANDERO II 1.0 Tce 90 GPF	H4D470	01/21 →
SANDERO 1.0 Tce 100	H4D480	01/21 →
SANDERO 1.0 Tce 100 ECO-G	H4D480	01/21 →
SANDERO 1.0 Tce 90	H4D470	01/21 →
SANDERO 1.0 Tce 90 ECO-G	H4D470	01/21 →

INFINITI

FX 50 AWD	VK50VE	10/08 →
M 56	VK56VD	03/10 →
M 56 X	VK56VD	03/10 →
Q70 5.6 AWD	VK56VD	01/15 →
QX70 50 AWD	VK50VE	08/13 →

NISSAN

CUBE 1.6 16V	HR16DE	08/09 →
FRONTIER 2.5 i	QR25DE	11/14 →
JUKE I 1.5	HR15DE	10/13 →
JUKE I 1.6	HR16DE	06/10 →
JUKE I 1.6 CVTC	HR16DE	08/14 →
JUKE I 1.6 LPG	HR16DE	01/12 →
JUKE I CVTC	HR16DE	03/13 →
MICRA IV 1.2	HR12DE	05/10 →
MICRA IV 1.2 4WD	HR12DE	05/10 →
MICRA IV 1.2 LPG	HR12DE	05/10 → 09/15
X-TRAIL III 2.5	QR25DE	12/13 →
X-TRAIL III 2.5 ALL MODE 4x4-i	QR25DE	12/13 →
MURANO III 2.5 HEV ALL MODE 4x4-i	QR25DER	01/16 →
NAVARA III 2.5	QR25DE	07/14 →
NAVARA III 2.5 DDTi	YD25DDTi	01/15 →
NOTE II 1.2	HR12DE	06/13 →
NOTE II 1.2 4WD	HR12DE	06/13 →
NOTE II 1.2 LPG	HR12DE	03/15 →
ALMERA III 1.2 i	HR12DE	09/11 →
NP300 2.5 i	QR25DE	06/14 →
NV200 / EVALIA 2.0	MR20DE	07/10 →
QASHQAI / QASHQAI +2.0	MR20DE	03/13 → 04/14

NISSAN

QASHQAI / QASHQAI +2.0 Trazione integrale	MR20DE	03/13 → 04/14
QASHQAI I 1.6 LPG	HR16DE	11/10 → 12/13
QASHQAI I 2.0	MR20DE	02/07 → 04/14
QASHQAI I 2.0 Trazione integrale	MR20DE	02/07 → 04/14
SENTRA VII 1.8	MRA8DE	08/12 →
SENTRA VII 1.8 [TWN]	MRA8DE	08/13 →
SENTRA VII 1.8 i	MRA8DE	07/12 →
SYLPHY III 1.8	MRA8DE	08/12 →
TEANA II 2.5 FOUR Trazione integrale	QR25DE	06/08 → 12/12
TEANA III 2.5	QR25DE	09/13 →
TIIDA II 1.6 [RUS]	HR16DE	01/15 →
TIIDA II 1.6 CVTC	HR16DE	08/12 →
TIIDA II 1.8	MRA8DE	08/12 →
PATHFINDER IV 2.5 Hybrid	QR25DER	10/13 →
PATHFINDER IV 2.5 Hybrid 4WD	QR25DER	10/13 →
X-TRAIL 2.5 ALL MODE 4x4-i	QR25DE	04/16 →
X-TRAIL II 2.5	QR25DE	09/07 → 11/13
X-TRAIL II 2.5 4x4	QR25DE	06/07 → 07/14

RENAULT

CAPTUR 1.0 Tce 90 ECO-G	H4D470	01/21 →
CAPTUR LPG	H4D460	01/20 →
CAPTUR Tce 100	H4D450	01/20 →
CAPTUR Tce 90	H4D470	09/20 →
CLIO V 1.0 LPG	H4D450, H4D452, H4D460	06/19 →
CLIO V 1.0 Tce 100	H4D450, H4D452, H4D460	06/19 →
CLIO V Tce 90	H4D450, H4D470	08/20 →
FLUENCE 1.6	H4M729	01/13 →
KOLEOS 2.5	2TR700, 2TR701, 2TR703, 2TR705, 2TR702	09/08 →
KOLEOS 2.5 4x4	2TR700, 2TR701, 2TR703, 2TR705, 2TR702	09/08 →
KOLEOS 2.5 Sce 4WD	2TR707	08/16 →
TWINGO III 0.9 Tce 95	H4B453	03/19 →

EPS **1.970.556**  **05,5**

COILS

Adatt./Suitable:

BOSCH
0 986 221 114

HYUNDAI
27300-3F100

KIA
27300-3F100

MAGNETI MARELLI
060717149012

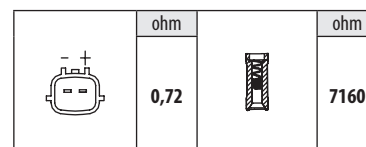
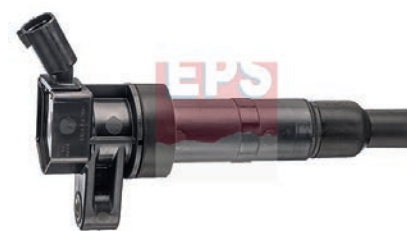

HYUNDAI

AZERA (USA) 2.4	--	09/10 →
EQUUS / CENTENNIAL II 4.6 V8	G8BA	03/09 →
GENESIS 2.0	G4KF	01/13 →
GENESIS 2.0 CVVT	G4KF	06/08 → 02/14
GENESIS 2.0T	G4KF	01/08 → 12/14
GENESIS 2.0Tci	--	01/11 →
GRANDEUR 2.4	G4KE	07/11 →
H-1 II 2.4	--, G4KC	02/08 →
H-1 II 2.4 i	G4KC	02/08 →
H1 2.4 CVVT	G4KC	01/10 →
IX35 2.0	G4KD	01/10 →
IX35 2.0 4WD	G4KD	01/10 →
IX35 2.0 CVVT	G4KD	08/09 → 07/13
IX35 2.0 CVVT AWD	G4KD	08/09 → 07/13

HYUNDAI		
IX35 2.4 DCVVT-I 4WD	G4KE	07/10 → 12/13
IX35 2.4 GDi 4WD	G4KJ	01/13 →
NF 2.0 CVVT	G4BPE	05/05 → 12/10
SANTA FE II 2.4	G4KE	11/10 → 12/12
SANTA FE II 2.4 4x4	G4KE	07/10 → 12/12
SANTA FE III 2.4	G4KJ	09/12 → 12/15
SANTA FE III 2.4 4WD	G4KJ	09/12 →
SANTA FE III 2.4 CCVT	G4KE	09/12 →
SANTA FE III 2.4 CCVT AWD	G4KE	09/12 →
SANTA FE III 2.4 GDI 4WD	G4KJ	05/15 →
SANTA FE IV 2.4 AWD	G4KE	07/18 →
SANTA FE IV 2.4 GDI AWD	G4KJ	07/18 →
SONATA V 2.0 GLSI	G4KD	07/08 → 12/10
SONATA V 2.0 VVTi GLS	G4KA, G4KD	05/05 → 12/10
SONATA V 2.4	G4KC, G4KE	01/05 → 12/10
SONATA VI 2.0	G4KD	06/09 → 06/14
SONATA VI 2.0 i	G4KD	01/11 → 06/14
SONATA VI 2.4	G4KC	06/09 → 12/15

KIA		
BORREGO 4.6	G8BA	09/08 → 12/11
CERATO II 1.6	G4FC	01/10 →
CERATO II 2.0	G4KD	01/09 →
CERATO II 2.0 CVVT	G4KD	01/09 →
CERATO 2.0 CVVT	G4KD	07/09 → 02/14
MOHAVE 4.6	--	09/08 →
OPTIMA III 2.0	--	03/10 →
OPTIMA III 2.0 CVVL	G4KD	03/12 →
OPTIMA III 2.0 CVVT	G4KD	01/11 → 12/15
OPTIMA III 2.4	--, G4KC, G4KE, G4KJ	03/10 →
OPTIMA III 2.4 CVVT	G4KE, G4KJ	01/12 →
OPTIMA III 2.4 Hybrid	G4KC	09/11 →
OPTIMA IV 2.4 MPi	G4KE	09/15 →
QUORIS 5.0 GDI	G8BE	05/15 →
MAGENTIS II 2.0	G4KD	09/09 → 12/10
SORENTO II 2.4 CVVT	G4KE, G4KJ	11/09 → 12/15
SORENTO II 2.4 CVVT 4WD	G4KE, G4KJ	11/09 → 12/15
SORENTO II 2.4 GDI	G4KJ	10/12 → 12/15
SORENTO II 2.4 GDI 4WD	G4KJ	10/12 → 12/15
SORENTO II 2.4 LPG	G4KE	04/10 → 12/15
SORENTO II 2.4 LPG 4WD	G4KE	04/10 → 12/15
SORENTO II CVVT	G4KE	06/09 → 12/15
SORENTO II CVVT 4WD	G4KE	06/09 → 12/15
SPORTAGE III 2.0 CVVT	G4KD	06/10 →
SPORTAGE III 2.0 CVVT AWD	G4KD, G4NC	06/10 →
SPORTAGE III 2.4 i 4WD	G4KE	08/10 →

EPS 1.970.557  05,5

COILS

Adatt./Suitable:

BOSCH
0 986 221 001
0 986 22A 000

HITACHI
133860
2503860

NISSAN
22448-6N000
22448-6N002
22448-6N010
22448-6N011
22448-6N012
22448-6N015
22448-95FOA

⁰³ Supplied until depletion

- Fornibile fino ad esaurimento delle scorte
- Fourni jusqu'à épuisement du stock
- Lieferbar solange vorrat reicht
- Suministrado hasta el stock termina

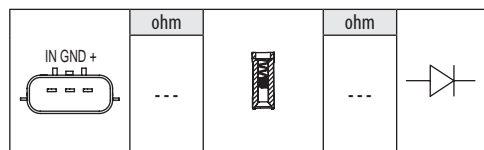

NISSAN		
ALMERA I 1.8	QG18DE	07/95 → 05/00
ALMERA II 1.5	QG15DE	03/00 →
ALMERA II 1.5 XL	QG15DE	03/01 →
ALMERA II 1.8	QG18DE	01/00 →

NISSAN		
ALMERA III 1.5	QG15DE	01/06 →
ALMERA III 1.6	QG16	01/06 →
ALMERA III 1.6 16V	QG16, QG16DE	03/06 →
ALMERA TINO 1.8	QG18DE	08/00 → 02/06
PRIMERA II 1.6 16V	QG16DE	06/96 → 07/02
PRIMERA II 1.6 16V LPG	QG16DE	09/00 → 07/02
PRIMERA II 1.8 16V	QG18DE	08/99 → 07/02
PRIMERA II 1.8 16V LPG	QG18DE	08/99 → 12/01
PRIMERA 1.6 LPG	QG16DE	09/96 → 07/02
PRIMERA 1.8 LPG	QG18DE	08/99 → 07/02
PRIMERA III 1.6	QG16DE	01/02 → 08/08
PRIMERA III 1.6 Visia	QG16DE	01/02 → 04/06
PRIMERA III 1.8	QG18DE	03/02 → 10/08
PRIMERA III 1.8 LPG	QG18DE	03/02 →

EPS 1.970.570  07,5

COILS

Adatt./Suitable:

BOSCH
0 986 22A 207

FIAT
71742420

HITACHI
2503947

MAGNETI MARELLI
060717159012

SUBARU
33400-62J00
33400-83E10

SUZUKI
33400-62J00
33400-62J00-000
33400-83E10
33400-83E10-000
33400M79F00
33400M79F00-000
33400M83E10
33400M83E10-000

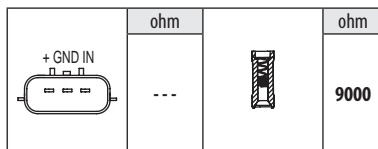
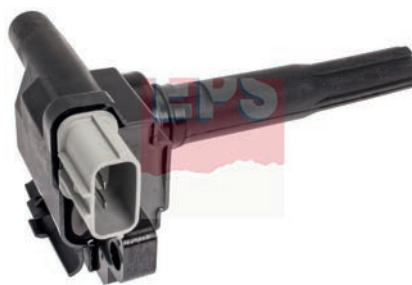

FIAT		
SEDICI 1.6 16V	M16A	06/06 → 10/14
SEDICI 1.6 16V 4x4	M16A	06/06 → 10/14

SUBARU		
JUSTY II 1.3 4x4	G13BB	04/01 → 11/03
JUSTY III 1.3 AWD	M13A	09/03 →
JUSTY III 1.5 AWD	M15A	09/03 →

SUZUKI		
ALTO VI 1.1	F10DN	09/04 → 12/08
SWIFT IV 1.3	M13A	02/05 →
SWIFT IV 1.3 4x4	M13A	02/05 →
SWIFT IV 1.3 LPG	M13A	09/08 → 12/10
SWIFT IV 1.5	M15A	02/05 →
SWIFT IV 1.6	M16A	05/06 →
IGNIS II 1.3	M13A	09/03 →
IGNIS II 1.3 4x4	M13A	09/03 →
IGNIS II 1.5	M15A	09/03 →
IGNIS II 1.5 4x4	M15A	09/03 →
WAGON R III 1.3	M13A	09/03 → 12/10
SX4 I 1.5	M15A	06/06 → 07/10
SX4 I 1.5 VVT	M15A	07/10 →
SX4 I 1.5 VVT 4x4	M15A	07/10 →
SX4 I 1.5 VVTi	M15A	07/07 → 12/15
SX4 I 1.6	M16A	06/06 →
SX4 I 1.6 AWD	M16A	10/07 → 12/11
SX4 I 1.6 VVT	M16A	06/06 →
SX4 I 1.6 VVT 4x4	M16A	06/06 →
WAGON R+ II 1.3	G13BB, M13A	05/00 →
WAGON R+ II 1.3 4WD	G13BB, M13A	10/01 →

SUZUKI		
WAGON R II 1.3	G13BB	04/99 → 10/00

EPS 1.970.579  05

COILS

Adatt./Suitable:

HITACHI
138856
2508856

HYUNDAI

27301-03000 *5
27301-03010 *5
27301-03015 *5
27301-03035 *5
27310-03010
27310-03020
27310-37110

KIA

27301-03010 *5
27301-03100 *5
27310-03010
27310-03020

⁰³ Supplied single coil only, without fastening clamp

- Fornita bobina singola senza staffa
- Fourni seulement la bobine individuelle, sans étrier
- Nur Zündspule geliefert, ohne Befestigungsbügel
- Suministrada solamente la bobina individual, sin brida

1.970.579

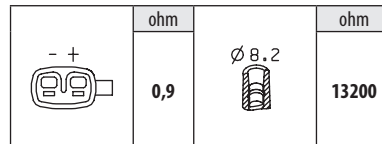
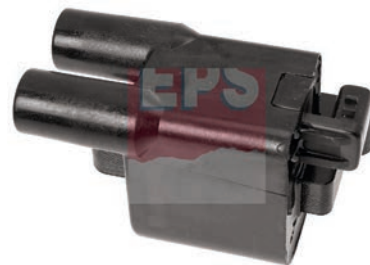

HYUNDAI		
I20 II 1.2	G4LA	11/14 →
I20 II 1.2 LPGI	G4LA	11/14 →
I20 II 1.2 MPI	G4LA	05/15 →
I10 I 1.2	G4LA	11/08 →
I10 I 1.2 LPG	G4LA	01/10 → 12/13
I10 II 1.2	G4LA	12/13 →
I20 I 1.2	G4AG, G4LA	09/08 → 12/15
I20 I 1.2 LPG	G4LA	01/09 → 08/14
SANTA FE 1.2 V6 4x4	G6BA, G6BA-G	02/01 → 03/06

KIA		
PICANTO II 1.2	G4LA	09/11 → 03/17
RIO III 1.2	G4LA	09/11 → 12/17
RIO III 1.2 CVVT	G4LA	11/14 → 12/17
RIO III 1.25 CVVT	G4LA	06/11 → 12/17
RIO III 1.25 LPG	G4LA	09/11 → 12/17

1.970.580

EPS 1.970.580



COILS

Adatt./Suitable:

- HYUNDAI**
27310-02610
27310-37130
- KIA**
27310-02610



	ohm		ohm
	1,05	Ø 8.2	13200

1.970.589		
1.970.580	1.970.587	1.970.589

HYUNDAI		
SANTA FE I 2.7 4x4	G6BA	09/02 ⇨ 12/04
SANTA FE I 2.7 V6 4x4	G6BA, G6BA-G	02/01 ⇨ 03/06
KIA		
PICANTO I 1.0	--, G4HE	04/04 ⇨
PICANTO I 1.0 LPG	G4HE	01/09 ⇨ 04/11
PICANTO I 1.1	--, G4HG	04/04 ⇨
PICANTO I 1.1 LPG	G4HG	01/09 ⇨ 04/11

EPS 1.970.581



COILS

Adatt./Suitable:

- BOSCH**
0 986 221 080
- DENSO**
DIC-0113
DIC-0114
- HYUNDAI**
27301-23700 *5
27301-23710 *5
27301-23900 *5
- KIA**
27301-23700 *5
27301-23710 *5
27301-23720 *5
27301-23900 *5
- MAGNETI MARELLI**
060717155012
060717172012

*5 Supplied single coil only, without fastening clamp

- Fornita bobina singola senza staffa
- Fourni seulement la bobine individuelle, sans étrier
- Nur Zündspule geliefert, ohne Befestigungsbügel
- Suministrada solamente la bobina individual, sin brida

1.970.581

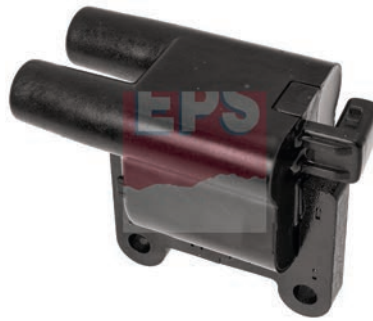

	ohm		ohm
	0,68	Ø 8.2	9200

HYUNDAI		
ELANTRA III 1.8	G4BB, G4GB	06/00 ⇨ 07/06
ELANTRA III 2.0	G4GC, G4GC-G	06/00 ⇨ 07/06
ELANTRA IV 2.0 CVVT	G4GC	06/06 ⇨ 06/11
I30 I 2.0	G4GC, G4GC-G	10/07 ⇨ 06/12
LANTRA 1.8	G4GB	06/00 ⇨
LANTRA 2.0	G4GC-G	06/00 ⇨
LAVITA 1.8	--	01/07 ⇨
MATRIX 1.8	G4GB, G4GB-G	06/01 ⇨ 08/10
MATRIX 1.8 [TUR]	G4GB	04/08 ⇨
SONATA V 2.0 i [RUS]	--	04/06 ⇨ 12/10
COUPE II 2.0	G4GC, G4GC-G	08/01 ⇨ 08/09
COUPE II 2.0 GLS	G4GC, G4GC-G	02/03 ⇨ 08/09
TRAJET 2.0	G4GC, G4GC-G, G4JP-G	03/00 ⇨ 07/08
TRAJET 2.0 CRDi	D4EA	08/05 ⇨ 07/08
TRAJET CVVT	G4GC	01/04 ⇨ 07/08
TUCSON 2.0	G4GC	08/04 ⇨
TUCSON 2.0 LPG	G4GC	06/04 ⇨ 03/10
TUCSON 2.0 LPG Trazione integrale	G4GC	06/09 ⇨ 03/10
TUCSON 2.0 Trazione integrale	G4GC	08/04 ⇨ 11/10
TUCSON CVVT	G4GC	06/04 ⇨ 03/10
KIA		
CARENS I 2.0 CVVT	G4GC	08/04 ⇨
CEED I 2.0	G4GC	12/06 ⇨ 12/12
CERATO I 2.0	G4GC	03/04 ⇨ 05/07
PRO CEE'D I 2.0	G4GC	02/08 ⇨ 09/12
PRO CEE'D I 2.0 LPG	G4GC	01/09 ⇨ 12/09
SPORTAGE II 2.0	G4KD	01/09 ⇨ 05/10
SPORTAGE II 2.0 16V 4WD	G4GC	09/04 ⇨
SPORTAGE II 2.0 i 16V	G4GC	09/04 ⇨
SPORTAGE II 2.0 LPG	G4GC	06/09 ⇨ 05/10
CERATO II 2.0 CVVT	--	01/09 ⇨

EPS 1.970.582



COILS

Adatt./Suitable:

- HYUNDAI**
27310-22600
- KIA**
27310-22600



	ohm		ohm
	1,05	Ø 8.2	13200

1.970.585		
1.970.582	1.970.583	1.970.585

1.970.586		
1.970.582	1.970.584	1.970.586

HYUNDAI		
ACCENT II 1.3	G4EH	08/02 ⇨ 11/05
ACCENT II 1.5	G4EK	09/99 ⇨ 10/02
ACCENT II 1.6	G4ED-G	12/02 ⇨ 11/05
ELANTRA III 1.6	G4ED-G, G4GA	06/00 ⇨ 07/06
GETZ 1.3	G4EA	09/03 ⇨ 06/09
GETZ 1.3 i	G4EA	09/02 ⇨ 03/04
GETZ 1.4 i	G4EE	08/05 ⇨ 12/10
GETZ 1.6	G4ED, G4ED-G	09/02 ⇨ 06/09
LAVITA 1.6	--	01/07 ⇨
MATRIX 1.6	G4ED, G4ED-G, G4ED-L	06/01 ⇨ 08/10
MATRIX 1.6 [TUR]	G4ED	04/08 ⇨
ACCENT III 1.4 GL	G4EE	11/05 ⇨ 11/10
COUPE II 1.6 16V	G4ED-G	03/02 ⇨ 08/09
VERNA I 1.3	G4EA	09/99 ⇨
VERNA I 1.5	G4EB, G4EC-G	09/99 ⇨
VERNA I 1.6	G4ED-G	12/02 ⇨
VERNA II 1.4 GL	--	11/05 ⇨
VERNA II 1.6 GLS	--	11/05 ⇨
KIA		
RIO II 1.4	G4EE	01/10 ⇨ 12/11
RIO II 1.4 16V	G4EE	03/05 ⇨ 12/11

EPS 1.970.583



05

COILS

Adatt./Suitable:

HYUNDAI
27310-22610
⁰³ Supplied until depletion

- Fornibile fino ad esaurimento delle scorte
- Fourni jusqu'à épuisement du stock
- Lieferbar solange vorrat reicht
- Suministrado hasta el stock termina



	ohm		ohm
	1,05	Ø 8.2	13200

1.970.585

1.970.583	1.970.585	1.970.582

HYUNDAI

ACCENT II 1.3	G4EA, G4EH	01/00 ⇒ 11/05
ACCENT II 1.5	G4EB, G4EK	01/00 ⇒ 12/06
GETZ 1.3	G4EA	09/03 ⇒ 06/09
GETZ 1.3 i	G4EA	09/02 ⇒ 03/04
VERNA I 1.3	G4EA	09/99 ⇒
VERNA I 1.5	G4EB	09/99 ⇒

EPS 1.970.584



05

COILS

Adatt./Suitable:

HYUNDAI
27310-26600

KIA
27310-26600

	ohm		ohm
	1,05	Ø 8.2	13200

1.970.586

1.970.584	1.970.586	1.970.582

HYUNDAI

ACCENT II 1.5	G4FK	09/99 ⇒ 10/02
ACCENT II 1.6	G4ED-G	12/02 ⇒ 11/05
ELANTRA III 1.6	G4ED-G, G4GA	06/00 ⇒ 07/06
GETZ 1.4 i	G4EE	08/05 ⇒ 12/10
GETZ 1.6	G4ED, G4ED-G	09/02 ⇒ 06/09
LAVITA 1.6	--	01/07 ⇒
MATRIX 1.6	G4ED-G, G4ED-L	06/01 ⇒ 08/10
MATRIX 1.6 [TUR]	G4ED	04/08 ⇒
ACCENT III 1.4 GL	G4EE	11/05 ⇒ 11/10
COUPE II 1.6 16V	G4ED-G	03/02 ⇒ 08/09
VERNA I 1.5	G4EC-G	09/99 ⇒
VERNA I 1.6	G4ED-G	12/02 ⇒
VERNA II 1.4 GL	--	11/05 ⇒
VERNA II 1.6 GLS	--	11/05 ⇒

KIA

RIO II 1.4	G4EE	01/10 ⇒ 12/11
RIO II 1.4 16V	G4EE	03/05 ⇒ 12/11

EPS 1.970.585



07

COILS

Adatt./Suitable:

CHEVROLET
96453420 *1

DAEWOO
96453420 *1

HYUNDAI
27301-22600 *1
^{*1} Without fastening clamp

- Senza staffa di fissaggio
- sans bride de fixation
- ohne Befestigungsbügel
- sin estribo de sujeción

²⁴⁵ without fastening clamp

- senza staffa fissaggio
- sans bride de fixation
- ohne Befestigungsbügel
- sin estribo de sujeción

1.970.582

1.970.583



CHEVROLET

LACETTI 1.4	F14D3	03/05 ⇒
LACETTI 1.4 16V	L14(85CUL4)	03/05 ⇒ 03/13
LACETTI 1.4 LPG	L14(85CUL4)	01/05 ⇒ 12/12
LACETTI 1.6	LXT	03/05 ⇒
LACETTI 1.6 LPG	LXT	06/09 ⇒ 12/11
LACETTI 1.8	LDA	03/05 ⇒
NUBIRA 1.4	L14(85CUL4)	01/05 ⇒ 12/08
NUBIRA 1.6	L44(96CUL4), LXT	03/05 ⇒
NUBIRA 1.6 LPG	L44(96CUL4), LXT	03/05 ⇒ 12/10
NUBIRA 1.8	LDA	03/05 ⇒ 12/11
OPTRA 1.4 16V	F14D3	03/05 ⇒
OPTRA 1.6	F16D3, LXT	08/03 ⇒ 12/08
OPTRA 1.6 SRV	F16D3	06/06 ⇒

DAEWOO

LACETTI 1.6	F16D3	02/04 ⇒
NUBIRA II 1.4	F14D3	10/03 ⇒ 12/04
NUBIRA II 1.6	F16D3	07/03 ⇒

HYUNDAI

ACCENT II 1.3	G4EA, G4EH	01/00 ⇒ 11/05
ACCENT II 1.5	G4EB, G4EC-G, G4EK, G4FK	01/00 ⇒ 12/06
GETZ 1.3	G4EA	09/04 ⇒ 06/09
VERNA I 1.3	G4EA	09/99 ⇒
VERNA I 1.5	G4EB	09/99 ⇒

EPS 1.970.586



07

COILS

Adatt./Suitable:

HYUNDAI

27301-26600 *1

KIA

27301-26600 *1

*1 Without fastening clamp

- Senza staffa di fissaggio
- sans bride de fixation
- ohne Befestigungsbügel
- sin estribo de sujeción

245 without fastening clamp

- senza staffa fissaggio
- sans bride de fixation
- ohne Befestigungsbügel
- sin estribo de sujeción



1.970.582

1.970.584

HYUNDAI

ACCENT II 1.6	G4ED, G4ED-G	12/02 ⇨ 11/05
COUPE I 1.6 16V	G4GR	03/98 ⇨ 04/02
COUPE I 1.6 i 16V	4G61, G4GR	12/96 ⇨ 04/02
ELANTRA III 1.6	G4ED, G4ED-G, G4GA, G4GR	06/00 ⇨ 07/06
GETZ 1.6	G4ED-G	09/02 ⇨ 06/09
LAVITA 1.6	--	01/07 ⇨
MATRIX 1.6	G4ED-G, G4ED-L	06/01 ⇨ 08/10
MATRIX 1.6 [TUR]	G4ED	04/08 ⇨
COUPE II 1.6 16V	G4ED, G4ED-G	03/02 ⇨ 08/09
VERNA I 1.5	G4EC-G	09/99 ⇨
VERNA I 1.6	G4ED-G	12/02 ⇨
VERNA II 1.4 GL	--	11/05 ⇨
VERNA II 1.6 GLS	--	11/05 ⇨

KIA

CERATO I 1.6	G4ED	04/04 ⇨ 12/09
--------------	------	---------------

EPS 1.970.587



05

COILS

Adatt./Suitable:

HYUNDAI

27301-02100 *5

27310-02611

27310-02612

27310-37120

KIA

27310-02611

*5 Supplied single coil only, without fastening clamp

- Fornita bobina singola senza staffa
- Fourni seulement la bobine individuelle, sans étrier
- Nur Zündspule geliefert, ohne Befestigungsbügel
- Suministrada solamente la bobina individual, sin brida

1.970.587



	ohm		ohm
	1,05		13200

1.970.589



HYUNDAI

GETZ 1.1	G4HD	09/02 ⇨ 06/09
SANTA FE I 2.7 4x4	G6BA	09/02 ⇨ 12/04
SANTA FE I 2.7 V6 4x4	G6BA, G6BA-G	02/01 ⇨ 03/06

KIA

PICANTO I 1.0	--, G4HE	04/04 ⇨
PICANTO I 1.0 LPG	G4HE	01/09 ⇨ 04/11
PICANTO I 1.1	--, G4HG	04/04 ⇨
PICANTO I 1.1 LPG	G4HG	01/09 ⇨ 04/11

EPS 1.970.589



07

COILS

Adatt./Suitable:

KIA

27301-02700 *1

27301-02710 *1

*1 Without fastening clamp

- Senza staffa di fissaggio
- sans bride de fixation
- ohne Befestigungsbügel
- sin estribo de sujeción

245 without fastening clamp

- senza staffa fissaggio
- sans bride de fixation
- ohne Befestigungsbügel
- sin estribo de sujeción



1.970.580

1.970.587

KIA

PICANTO I 1.0	--, G4HE	04/04 ⇨
PICANTO I 1.1	--, G4HG	04/04 ⇨

EPS 1.970.591



07,5

COILS

Adatt./Suitable:

HITACHI

133963

2503963

MAGNETI MARELLI

060717093012

SUZUKI

33410-66D00
33410-66D00-000
33410-66D01
33410-66D01-000
33410-66D10
33410-66D10-000

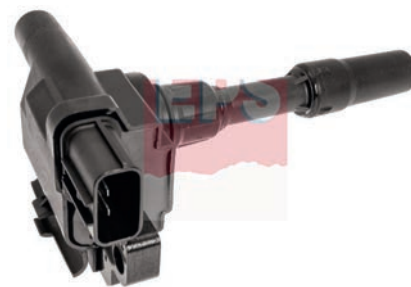

	ohm		ohm
	---		9000

SUZUKI

GRAND VITARA I 1.6 4x4	G16B	03/98 ⇨ 09/05
JIMNY III 1.3	M13A	08/04 ⇨
JIMNY III 1.3 16V	G13BB, M13A	02/01 ⇨
JIMNY III 1.3 16V 4WD	G13BB, M13A	09/98 ⇨
JIMNY III 1.3 16V 4x4	M13A	08/05 ⇨
JIMNY III 1.3 4x4	G13BB	09/98 ⇨ 08/00
SWIFT III 1.3 [USA]	--	06/95 ⇨ 05/01
VITARA I 1.6 16V	G16B	10/99 ⇨ 10/02
VITARA II 1.6i [USA]	--	08/99 ⇨ 12/06

EPS 1.970.596



07

COILS

Adatt./Suitable:

BOSCH

0 986 221 001
0 986 221 060
0 986 221 060

DACIA

22 43 361 34R
60 01 543 604
77 00 274 008

HITACHI

133800
138764
138764

LADA

22 43 361 34R

MAGNETI MARELLI

060717035012
060717055012
060810070010

NISSAN

22448-00QOE
22448-00QAC

RENAULT

22 43 361 34R
60 01 543 604
77 00 274 008
H77 00 873 701

SAGEM

2 526 151 A

NEW - ITEM NOW AVAILABLE FROM PRODUCTION

- NUOVO - ARTICOLO ORA DISPONIBILE PER LA VENDITA
- NOUVEAU - ARTICLE DISPONIBLE EN PRODUCTION COURANTE
- NEU - JETZT ZUM VERKAUF VERFÜGBARER ARTIKEL
- NUEVO - ARTICULO AHORA DISPONIBLE EN PRODUCCION



	ohm		ohm
	0,6	∅ 4	7000

DACIA

DOKKER 1.6	K7M812, K7M828	11/12 ⇨
DOKKER 1.6 LPG	K7M812, K7M828	11/13 ⇨
LODGY 1.6	K7M812, K7M828	03/12 ⇨
LODGY 1.6 LPG	K7M812, K7M828	11/13 ⇨
LOGAN I 1.4	K7J710	09/04 ⇨
LOGAN I 1.4 MPI LPG	K7J710, K7J714	02/06 ⇨ 12/12
LOGAN I 1.6	K7M710, K7M714	09/04 ⇨
LOGAN I 1.6 Bifuel	K7M710, K7M718, K7M800, K7M818	11/08 ⇨
LOGAN I 1.6 LPG	K7M718	08/04 ⇨ 12/12
LOGAN I 1.6 MPI 85	K7M800	05/10 ⇨
LOGAN II 1.6	K7M812	06/13 ⇨ 08/16
LOGAN II 1.6 16V	K7M764, K7M812	10/12 ⇨
LOGAN II MCV 1.6	K7M812	06/13 ⇨
SANDERO I 1.4	K7J710	06/08 ⇨
SANDERO I 1.4 MPI LPG	K7J714	01/09 ⇨
SANDERO I 1.6	K7M710, K7M718	06/08 ⇨
SANDERO I 1.6 Hi-Flex	K7M732	06/08 ⇨ 12/12
SANDERO I 1.6 LPG	K7M718, K7M818	06/08 ⇨ 12/12
SANDERO I 1.6 MPI 85	K7M800	05/10 ⇨ 06/13
SANDERO II 1.6	K7M812	11/12 ⇨
SANDERO II 1.6 I	K7M764	10/12 ⇨
SOLENZA 1.4	E7J262	02/03 ⇨ 10/05

LADA

LARGUS 1.6 11189, K7M 03/12 ⇨

NISSAN

KUBISTAR 1.2	D7F726, D7F744, D7F764, D7F726	08/03 ⇨
KUBISTAR 1.2 LPG	D7F764	10/03 ⇨ 08/05
KUBISTAR 1.4	K7J700, K7J701	08/03 ⇨ 10/09
KUBISTAR 1.6 16V	K4M752, K4M753	08/03 ⇨ 10/09

RENAULT

CLIO II 1.0	D7D760	02/00 ⇨ 05/01
CLIO II 1.2	D7F710, D7F720, D7F722, D7F726, D7F744, D7F746, D7F764, D7F766	03/98 ⇨
CLIO II 1.2 LPG	D7F744, D7F764, D7F766	09/98 ⇨ 06/09
CLIO II 1.4	E7J634, E7J635, K7J700	09/98 ⇨
CLIO II 1.6	K7M746	09/98 ⇨
CLIO III 1.2	D4F784	11/07 ⇨ 12/11

RENAULT

CLIO III 1.2 16V	D4F784, D4F786	05/07 ⇨ 12/14
KANGOO II 1.6	K7M750	02/08 ⇨
CLIO 1.2 BiFuel	D7F722	03/98 ⇨ 10/01
DOKKER 1.6	K7M812	12/13 ⇨
KANGOO 1.2	D7F746	12/01 ⇨ 06/03
KANGOO 1.2 BiFuel	D7F710, D7F722, D7F744, D7F764, D7F766	06/97 ⇨ 06/03
KANGOO I 1.0	D7D700, D7D760	09/98 ⇨
KANGOO I 1.0 RN	D7D700, D7D760	01/02 ⇨ 01/07
KANGOO I 1.2	D7F710, D7F720, D7F722, D7F726, D7F744, D7F746, D7F764, D7F766	08/97 ⇨
KANGOO I 1.2 BiFuel	D7F710, D7F744	07/98 ⇨ 07/01
KANGOO I 1.4	E7J634, E7J635, K7J700, K7J701	08/97 ⇨
KANGOO I 1.6	K7M746	09/99 ⇨
LODGY 1.6	K7M812, K7M828	07/13 ⇨
LOGAN 1.4	K7J710	09/04 ⇨
LOGAN 1.4 LPG	K7J714	02/08 ⇨ 10/13
LOGAN 1.6	K7M710	09/04 ⇨
LOGAN 1.6 MPI 85	K7M800	05/10 ⇨
LOGAN EXPRESS 1.6	K7M710	04/07 ⇨
LOGAN/STEPWAY 1.6	K7M812	11/13 ⇨
MEGANE I 1.4	E7J626	09/96 ⇨ 08/03
MEGANE I 1.4 e	E7J626	01/96 ⇨ 08/03
MEGANE I 1.6	K7M704	02/00 ⇨ 09/00
MEGANE I 1.6 e	K7M702, K7M703, K7M790	01/96 ⇨ 08/03
MEGANE I 1.6 i	K7M720	01/96 ⇨ 03/99
MEGANE I 1.6 LPG	K7M702	08/95 ⇨ 03/99
MEGANE I 2.0 16V	F5R740	01/02 ⇨ 08/03
MEGANE I 2.0 16V IDE	F4R746, F5R740	11/99 ⇨ 08/03
MEGANE SCÉNIC I 1.6 e	K7M702, K7M703	10/96 ⇨ 10/99
MEGANE SCÉNIC I 1.6 i	K7M720	01/97 ⇨ 09/99
MEGANE 1.6 BiFuel	K7M702	10/96 ⇨ 10/99
MODUS / GRAND MODUS 1.2	D4F786	04/11 ⇨
MODUS / GRAND MODUS 1.2 16V	D4F784	05/07 ⇨
SANDERO I 1.4	K7J710	02/09 ⇨
SANDERO I 1.4 LPG	K7J714	02/09 ⇨
SANDERO I 1.6	K7M710	12/07 ⇨
SANDERO I 1.6 MPI 85	K7M800	05/10 ⇨
SANDERO II 1.6	K7M812	11/13 ⇨
THALIA I 1.4	K7J718	05/00 ⇨ 02/09
THALIA I 1.6	K7M730, K7M734	01/01 ⇨
THALIA II 1.4	K7J700	09/08 ⇨ 06/14
TWINGO I 1.0	D7D740	01/00 ⇨
TWINGO I 1.2	D7F700, D7F701, D7F702, D7F703, D7F704, D7F706	05/96 ⇨
TWINGO II 1.2	D7F800	03/07 ⇨ 09/14
TWINGO II 1.2 TCe 100	D4F780, D4F782	02/11 ⇨
TWINGO II 1.2 Turbo	D4F780, D4F782	03/07 ⇨ 09/14
WIND 1.2	D4F782	07/10 ⇨
WIND 1.2 TCe 100	D4F782	02/11 ⇨

EPS 1.970.599



05,5

COILS

Adatt./Suitable:

AUDI

04C 905 110 D
04C 905 110 E
04C 905 110 H
04C 905 110 J
04C 905 110 L
04E 905 110 B
04E 905 110 D
04E 905 110 E
04E 905 110 K
04E 905 110 M
04E 905 110 P

BOSCH

0 986 221 057
0 986 221 072

CUPRA

04E 905 110 K
04E 905 110 P

HITACHI

2503894
2504033

MAGNETI MARELLI

060717199012

SEAT

04C 905 110 B
04C 905 110 D
04C 905 110 E
04C 905 110 H
04C 905 110 J
04C 905 110 L
04E 905 110
04E 905 110 A
04E 905 110 B
04E 905 110 E
04E 905 110 K
04E 905 110 P

SKODA

04C 905 110 A
04C 905 110 B
04C 905 110 D
04C 905 110 E
04C 905 110 H
04C 905 110 J
04C 905 110 L
04E 905 110
04E 905 110 A
04E 905 110 B
04E 905 110 E
04E 905 110 K
04E 905 110 M
04E 905 110 P

VW

04C 905 110 A
04C 905 110 B
04C 905 110 D
04C 905 110 E
04C 905 110 H
04C 905 110 J
04C 905 110 L
04E 905 110
04E 905 110 A
04E 905 110 B
04E 905 110 E
04E 905 110 H
04E 905 110 K
04E 905 110 L
04E 905 110 P



	ohm		ohm	
	

AUDI

A1 1.0 TFSI	CHZB, CHZE, DKLD	03/15 ⇨ 10/18
A1 1.4 TFSI	CPTA, CZCA, CZDD	04/12 ⇨ 10/18
A1 1.4 TSI	CZEA	11/14 ⇨ 10/18
A1 25 TFSI	DKLA, DLAC	11/18 ⇨
A1 30 TFSI	DKJA, DKRF, DLAA	07/18 ⇨
A3 III 1.0 TFSI	CHZD, DKRF	07/16 ⇨ 10/20
A3 III 1.2 TFSI	CJZA, CYVB	02/13 ⇨
A3 III 1.4 TFSI	CMBA, CPTA, CXSA, CXSB, CZCA, CZCC	04/12 ⇨
A3 III 1.4 TFSI e-tron	CUKB, CXUA, DGEA	05/14 ⇨ 10/20
A3 III 1.4 TFSI g-tron	CPWA	11/13 ⇨ 10/20
A3 III 1.4 TSI	CZEA	05/14 ⇨ 10/20
A3 III 30 TFSI	CHZD, DKRF	07/18 ⇨ 10/20
A3 IV 30 TFSI	DLAA	06/20 ⇨
A3 IV 30 TFSI Mild Hybrid	DLAA	06/20 ⇨

AUDI		
A3 IV 40 TFSIe	DGEA	06/20 →
A3 IV 45 TFSIe	DGEA	07/21 →
A4 V 1.4 TFSI	CVNA	08/15 → 11/19
A5 II 1.4 TFSI	CVNA	11/16 → 02/20
Q2 1.0 TFSI	CHZJ, DKRF	10/16 → 10/20
Q2 1.4 TFSI	CZEA	06/16 → 08/18
Q2 30 TFSI	CHZJ, DKRF, DLAA	07/18 →
Q3 1.4 TFSI	CZDB	07/16 → 10/18
Q3 1.4 TSI	CHPB, CZDA, CZEA	10/13 → 10/18

CUPRA		
FORMENTOR 1.4 e-Hybrid	DGEA	01/21 →
FORMENTOR VZ 1.4 e-Hybrid	DGEA	02/21 →
LEON 1.4 e-HYBRID	DGEA	09/20 →
LEON VZ 1.4 e-HYBRID	DGEA	09/20 →

SEAT		
ALHAMBRA III 1.4 TSI	CZDA, DJKA	05/15 →
ALHAMBRA III TSI	CZDA	05/15 →
ARONA 1.0 TGI	DBYA	11/18 →
ARONA 1.0 TSI	CHZJ, CHZL, DKJA, DKLA, DKRF, DLAA	07/17 →
ARONA 1.6 SRE	CWVA	07/17 →
ATECA 1.0 TSI	CHZJ, DKRF	05/16 →
ATECA 1.4 TSI	CZEA	06/16 →
ATECA 1.4 TSI 4Drive	CZEA	06/16 →
IBIZA IV 1.0	CHYB	05/15 → 06/17
IBIZA IV 1.0 TSI	CHZB, CHZC	05/15 → 06/17
IBIZA IV 1.2 TSI	CJZC, CJZD	05/15 → 06/17
IBIZA IV 1.4 TSI	CPTA, CZEA	10/13 → 06/17
IBIZA IV 1.6	CWVA	07/15 → 06/17
IBIZA IV 1.6 SRE	CWVA, CWVB	07/15 →
IBIZA IV 1.8 TSI Cupra	DAJA	11/15 → 12/16
IBIZA V 1.0	CHYB, CHYC	01/17 →
IBIZA V 1.0 TGI	DBYA	11/17 →
IBIZA V 1.0 TSI	CHZJ, CHZL, DKJA, DKLA, DKRF, DLAA, DLAC	01/17 →
IBIZA V 1.6	CWVA	05/17 →
IBIZA 1.0 SRE	CHYB	05/15 → 12/16
IBIZA 1.6 SRE	CWVA	07/15 → 12/16
LEON III 1.0 TSI	CHZD, DKLB	05/15 →
LEON III 1.2 TSI	CJZA, CJZB, CYVA, CYVB	12/12 →
LEON III 1.4 TGI	CPWA	02/13 →
LEON III 1.4 TSI	CHPA, CMBA, CXSA, CZCA, CZDA, CZEA	09/12 →
LEON III 1.6 TSI	CWVA	05/15 →
LEON IV 1.0 TSI	DLAA, DLAB	03/20 →
LEON IV 1.0 TSI Mild Hybrid	DLAA	08/20 →
LEON IV 1.4 TSI e-Hybrid	DGEA	05/20 →
MII 1.0	CHYA, CHYB	10/11 → 07/19
MII 1.0 EcoFuel	CPGA	10/12 → 07/19
TARRACO 1.4 e-HYBRID	DGEA	02/21 →
TARRACO 1.4 TSI Plug in Hybrid	DGEA	02/21 →
TOLEDO IV 1.0 TSI	CHZB, CHZC, DKLD, DKRC	05/17 → 04/19
TOLEDO IV 1.2 TSI	CJZC, CJZD	05/15 → 05/17
TOLEDO IV 1.4 TSI	CZCA	05/15 → 04/19
TOLEDO IV 1.6	CWVA	05/15 → 04/19

SKODA		
CITIGO 1.0	CHYA, CHYB	10/11 → 08/19
CITIGO 1.0 CNG	CPGA	11/12 → 08/19
FABIA 1.0 TSI	DLAA, DLAC	06/21 →
KAMIQ 1.0 TGI CNG	DBYA	11/19 →
KAMIQ 1.0 TSI	DKJA, DKLA, DKRF	07/19 →
KAMIQ 1.6 SRE	CWVA	07/19 →
KAROQ 1.0 TSI	CHZJ, DKRF	07/17 →
KAROQ 1.4 TSI	CZEA, DJKA	07/17 →
KODIAQ 1.4 TSI	CZCA, CZDA, CZEA	10/16 →
KODIAQ 1.4 TSI 4x4	CZDA, CZEA	10/16 →
OCTAVIA III 1.0 TSI	CHZD, DKRA, DKRF	05/16 →
OCTAVIA III 1.2 TSI	CJZA, CJZB, CYVA, CYVB	11/12 →
OCTAVIA III 1.4 TSI	CHPA, CHPB, CZDA	11/12 →
OCTAVIA III 1.4 TSI G-TEC	CPWA	11/13 →
OCTAVIA III 1.6	CWVA	01/14 →
OCTAVIA IV 1.0 TSI	DLAA	06/20 →
OCTAVIA IV 1.0 TSI e-TEC	DLAA	06/20 →
RAPID 1.0 TSI	CHZB, CHZC, DKLD	06/17 → 12/19
RAPID 1.2 TSI	CJZC, CJZD	05/15 → 12/19
RAPID 1.4 TSI	CZCA	05/15 →
RAPID 1.6	CWVA	05/15 →
RAPID 1.6 SRE	CWVA	05/15 →
SCALA 1.0 TGI CNG	DBYA	11/19 →
SCALA 1.0 TSI	DKJA, DKLA, DKRF, DLAA, DLAC	02/19 →
SCALA 1.6 SRE	CWVA	02/19 →
FABIA III 1.0	CHYA, CHYB, CHYE	08/14 →
FABIA III 1.0 TSI	CHZB, CHZC, DKLD, DKRC	08/14 →
FABIA III 1.2 TSI	CJZC, CJZD	08/14 →
FABIA III 1.4 TSI R5	CZCA	02/18 →
FABIA III 1.6	CWVA, CWVB	01/15 →
SUPERB III 1.4 TSI	CZCA, CZDA, CZEA	03/15 →

SKODA		
SUPERB III 1.4 TSI 4x4	CZDA, CZEA	03/15 →
SUPERB III 1.4 TSI iv	DGEB	08/19 →
YETI 1.2 TSI	CYVB	05/15 → 12/17
YETI 1.4 TSI	CZCA	05/15 → 12/17
YETI 1.4 TSI 4x4	CZDA	05/15 → 12/17
YETI 1.6	CWVA	04/14 → 12/17

VW		
ARTEON 1.4 eHybrid	DGEB	11/20 →
BEETLE 1.2 TSI 16V	CYVD	12/14 → 07/19
BEETLE 1.4 TSI	CZDA	12/14 → 07/19
CADDY III 1.0 TSI	CHZG, DKRD, DKRE	11/15 →
CADDY III 1.2 TSI	CYVC	06/15 →
CADDY III 1.4 TGI CNG	CPWA	06/15 →
CADDY III 1.4 TSI	CZCB, DJKD	05/15 →
CADDY III 1.6	CWVA	11/15 → 09/20
CADDY III 1.6 SRE	CWVA	11/15 → 09/20
POLO VI 1.0	CHYB, CHYC, DFNB	06/17 → 08/21
POLO VI 1.0 TGI	DBYA	09/17 →
POLO VI 1.0 TSI	CHZJ, CHZL, DKJA, DKLA, DKRF, DLAA, DLAC	06/17 →
CADDY IV 1.6 SRE	DWYA	02/21 →
CC 1.4 TSI	CZDA	05/15 → 12/16
T-CROSS 1.0 TSI	CHZL, DKJA, DKLA, DKRF, DLAA, DLAC	12/18 →
GOLF VI 1.2 TSI 16V	CJZA, CYVD	11/13 → 05/16
GOLF VI 1.4 TSI	CZCA, CZDA	11/13 → 05/16
GOLF VII 1.0 TSI	CHZC, CHZD, CHZK, DKLB, DKRF	05/15 →
GOLF VII 1.2 TSI	CJZA, CJZB, CYVA, CYVB	08/12 →
GOLF VII 1.2 TSI BlueMotion	CJZA, CJZB, CYVA	08/12 →
GOLF VII 1.4 GTE Hybrid	CUKC, DGEA	05/14 →
GOLF VII 1.4 TGI CNG	CPWA, CZBA	06/13 →
GOLF VII 1.4 TSI	CHPA, CHPB, CMBA, CPTA, CPVA, CPVB, CXSA, CZCA, CZDA, CZDD, CZEA	08/12 →

GOLF VII 1.4 TSI BlueMotion	CHPA, CXSA	08/12 →
GOLF VII 1.4 TSI MultiFuel	CPVA, CPVB	04/13 →
GOLF VII 1.6	CWVA	05/14 →
PASSAT VI 1.4 GTE Hybrid	CUKC, DGEB	06/15 →
PASSAT VI 1.4 TSI	CZCA, CZDA, CZEA	11/14 →
PASSAT VI 1.4 TSI 4motion	CZEA	02/15 →
GOLF VIII 1.0 eTSI	DLAA	06/20 →
GOLF VIII 1.0 TSI	DLAA, DLAB	02/20 →
GOLF VIII 1.4 GTE Plug-in Hybrid	DGEA	07/20 →
GOLF VIII 1.4 TSI eHybrid	DGEA	07/20 →
JETTA VI 1.2 TSI	CYVD	02/11 →
JETTA VI 1.2 TSI 16V	CYVD	08/14 → 12/17
JETTA VI 1.4 TSI	CZCA, CZDA, CZTA	08/14 →
JETTA VI 1.4 TSI Hybrid	CNLA	04/11 →
JETTA VI 1.6	CWVA	09/15 →
JETTA VI 1.6 [RUS]	CWVA, CWVB	01/15 →
JETTA VI 1.6 MPI	CWVB	09/15 → 04/18
MULTIVAN 1.4 e-Hybrid	DGEA	08/21 →
POLO V 1.0	CHYA, CHYB	01/14 →
POLO V 1.0 TSI	CHZB, CHZC	11/14 →
POLO V 1.2 TSI	CJZC, CJZD	01/14 →
POLO V 1.2 TSI 16V	CJZC	02/14 → 10/17
POLO V 1.4 TSI	CPTA, CZCA, CZEA	10/12 →
POLO V 1.4 TSI [RUS]	CZCA	05/14 →
POLO V 1.6	CWVA, CWVB	07/14 →
T-ROC 1.0 TSI	CHZJ, DKRF, DLAA	07/17 →
SCIROCCO III 1.4 TSI	CZCA, CZDA, CZDC	11/13 →
SHARAN II 1.4 TSI	CZDA, DJKA	05/15 →
TAIGO 1.0 TSI	DLAA, DLAC	09/21 →
TAOS 1.4 TSI	DJKA	10/20 →
TAOS 1.4 TSI 4motion	DJKA	05/21 →
TAOS 1.6 MPI	DWYA	07/21 →
TIGUAN I 1.4 TSI	CZDA, CZDB	05/15 → 07/18
TIGUAN II 1.4 TSI	CZCA, CZDA, CZDB, CZEA, DJVA	01/16 →
TIGUAN II 1.4 TSI 4motion	CZDA, CZEA	05/16 → 07/18
TOURAN II 1.0 TSI	DKRB	12/18 →
TOURAN II 1.2 TSI	CYVB	05/15 →
TOURAN II 1.4 TSI	CZDA	05/15 →
UP 1.0	-- CHYA, CHYB, CHYE, DAFa	08/11 →
UP 1.0 EcoFuel	CPGA	11/12 →
UP 1.0 GTI	DKRA	11/17 →
UP 1.0 TSI	CHZA, DKLC	05/16 → 09/18

EPS **1.970.602**  **05,5**

COILS

Adatt./Suitable:

- HITACHI**
133909
2503909
- MAGNETI MARELLI**
060717164012
060810160010
- NISSAN**
22448-AX001

NEW - ITEM NOW AVAILABLE FROM PRODUCTION

- NUOVO - ARTICOLO ORA DISPONIBILE PER LA VENDITA
- NOUVEAU - ARTICLE DISPONIBLE EN PRODUCTION COURANTE
- NEU - JETZ ZUM VERKAUF VERFÜGBARER ARTIKEL
- NUEVO - ARTICULO AHORA DISPONIBLE EN PRODUCCION

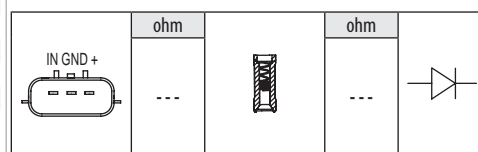

NISSAN

MICRA III 1.0 16V	CG10DE	01/03 → 06/10
MICRA III 1.2	CR12DE	10/03 → 06/10
MICRA III 1.2 16V	CG12DE, CR12DE	01/03 → 06/10
MICRA III 1.2 LPG	CG12DELP, CR12DE	10/02 → 06/10
MICRA III 1.3	CGA3DE	08/04 →
MICRA III 1.4 16V	CR14DE	01/03 → 06/10
MICRA C+ C 1.4 16V	CR14DE	08/05 →
NOTE I 1.4	CR14DE	03/06 → 06/12
NOTE I 1.4 LPG	CR14DE	01/06 → 08/13

EPS **1.970.603**  **05,5**

COILS

Adatt./Suitable:

- HITACHI**
134003
2504003
CM11-116
- HONDA**
30520-RB0-003
30520-RB0-013
30520-RB0-S01

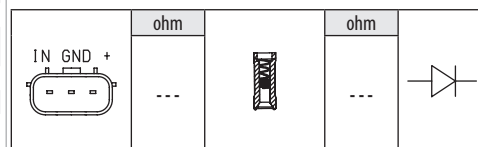

HONDA

CITY 1.4 i-VTEC	L13Z1	09/08 →
CITY 1.5 i-VTEC	L15-A7	08/09 →
CIVIC VIII 1.4	L13Z1	10/08 →
CIVIC IX 1.4 i-VTEC	L13Z4	02/12 →
CR-Z 1.5 IMA	LEA1, LEA3	06/10 →
JAZZ III 1.2	L12B1, L12B2	07/08 →
JAZZ III 1.3 i	L13Z1, L13Z2	07/08 →

HONDA		
JAZZ III 1.4	L13Z1	11/08 ⇨
JAZZ III 1.5 i-VTEC	L15-A7	07/08 ⇨ 06/14

EPS **1.970.607**  **05,5**

COILS

Adatt./Suitable:

BMW

- 12 13 7 559 842
- 12 13 7 571 644
- 12 13 7 582 627
- 12 13 7 594 935
- 12 13 7 638 477
- 7 559 842
- 7 594 935
- 7 638 477

BOSCH

- 0 221 504 471
- 0 221 504 472
- 0 221 504 801

HITACHI

- 133876
- 2503876

MAGNETI MARELLI

- 060717113012

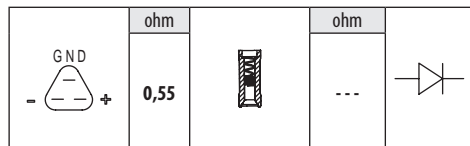

BMW

11 116 i	N43B16A, N43B16AA, N43B20A	03/07 ⇨ 12/11
11 118 d	M47D20(204D4)	06/04 ⇨ 02/07
11 118 i	N43B20A	09/06 ⇨ 12/13
11 120 i	N43B20A, N46B20BD	03/07 ⇨ 12/13
3 V 316 i	N43B16A, N43B16AA	09/07 ⇨ 06/13
3 V 318 i	N43B20A	05/07 ⇨ 12/13
3 V 320 i	N43B20A	09/05 ⇨ 12/13
3 V 325 i	N53B30A	10/06 ⇨ 12/13
3 V 325 i xDrive	N53B30A	09/08 ⇨ 12/13
3 V 325 xi	N53B30A	09/07 ⇨ 08/08
3 V 330 i	N52B30A, N52B30BF, N53B30A	09/06 ⇨ 10/13
3 V 330 i xDrive	N53B30A	09/07 ⇨ 06/13
3 V 330 xi	N53B30A	09/06 ⇨ 06/12
5 VI 523 i	N53B30A	06/09 ⇨ 08/11
5 VI 528 i	N53B30A	11/09 ⇨ 08/11
5 VI 530 i	N53B30A	05/11 ⇨ 06/13
6 II 630 i	N53B30A	09/07 ⇨ 08/10
5 V 520 i	N43B20A	12/06 ⇨ 12/10
5 V 523 i	N53B25A	01/07 ⇨ 12/10
5 V 525 i	N53B30A	01/07 ⇨ 12/10
5 V 525 i xDrive	N53B30A	09/08 ⇨ 12/10
5 V 525 xi	N53B30A	01/07 ⇨ 12/10
5 V 530 i	N53B30A	09/06 ⇨ 12/10
5 V 530 i xDrive	N53B30A	09/08 ⇨ 05/10
5 V 530 xi	N53B30A	09/06 ⇨ 05/10

EPS **1.970.608**  **05,5**

COILS

Adatt./Suitable:

BOSCH

- 0 986 JG1 224

HITACHI

- 133930
- 2503930
- CM11-108
- CM11-111

HONDA

- 30521-PWA-003
- 30521-PWA-013
- 30521-PWA-S01
- 30521-REA-Z01

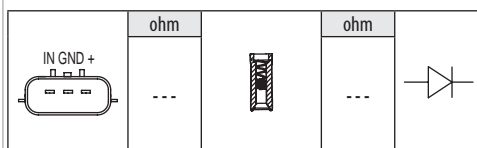

HONDA

JAZZ II 1.2	L12A4	01/06 ⇨
JAZZ II 1.4	L13A6	01/06 ⇨
CITY 1.2	L12A2	05/03 ⇨
CITY 1.3	L13A3	10/05 ⇨ 07/08
CITY 1.5 i-DSI	L15A2	11/02 ⇨
CIVIC VII 1.3 IMA	LDA1	10/03 ⇨ 09/05
JAZZ I 1.2 i-DSI	L12A1, L12A3, L12A4	03/02 ⇨ 07/08
JAZZ I 1.3 iDSi	L13A1, L13A6	03/02 ⇨ 07/08
JAZZ I 1.4	L13A5	04/05 ⇨ 07/08
JAZZ I 1.4 iDSi	L13A1, L13A6	12/06 ⇨ 10/08
CIVIC VIII 1.3 IMA	LDA2	01/06 ⇨
CIVIC VIII 1.4	L13A7	09/05 ⇨

EPS **1.970.609**  **05,5**

COILS

Adatt./Suitable:

BOSCH

- 0 986 221 101

CITROËN

- 96 712 145 80

DS

- 96 712 145 80

GENERAL MOTORS

- 3 639 500

HITACHI

- 134051
- 2504051

MAGNETI MARELLI

- 060717188012

OPEL

- 3639500
- 9671214580

PEUGEOT

- 96 712 145 80

TOYOTA

- SU001-01125

VAUXHALL

- 3639500
- 9671214580

NEW - ITEM NOW AVAILABLE FROM PRODUCTION

- NUOVO - ARTICOLO ORA DISPONIBILE PER LA VENDITA
- NOUVEAU - ARTICLE DISPONIBLE EN PRODUCTION COURANTE
- NEU - JETZT ZUM VERKAUF VERFÜGBARER ARTIKEL
- NUEVO - ARTICULO AHORA DISPONIBLE EN PRODUCCION

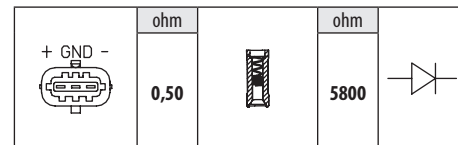

CITROËN

C1 II 1.2 VTi 82	177L, HMT(EB2D), HMZ(EB2F)	04/14 ⇨
C3 III 1.2 PureTech 82	HMR(EB2FA)	05/18 ⇨
C3 III 1.2 PureTech 82 LPG	HMR(EB2FA)	05/18 ⇨
C3 III 1.2 VTi 68	HMM(EB2FAD), HMP(EB2FB)	07/16 ⇨
C3 III 1.2 VTi 82	HMZ(EB2F)	07/16 ⇨
C3 III 1.2 VTi 82 LPG	HMZ(EB2F)	07/16 ⇨
C3 III PureTech 82	HMR(EB2FA)	03/19 ⇨
C3 AIRCROSS 1.2 PureTech 82	HMR(EB2FA), HMZ(EB2F)	06/17 ⇨
C3 AIRCROSS PureTech 82	HMZ(EB2F)	05/19 ⇨
C3 II 1.0 VTi 68	ZMZ(EBO)	08/12 ⇨
C3 II 1.2 VTi 82	177L, HMZ(EB2F)	06/12 ⇨ 09/16
C4 CACTUS 1.2 VTi 75 / PureTech 75	HMU(EB2D), HMU(EB2FD)	09/14 ⇨
C4 CACTUS 1.2 VTi 82	HMZ(EB2F)	09/14 ⇨
C4 CACTUS PureTech 82	177L	05/19 ⇨
C-ELYSEE 1.2 PureTech 82	HMR(EB2FA)	02/18 ⇨
C-ELYSEE 1.2 VTi 72	HMY(EB2M)	11/12 ⇨
C-ELYSEE 1.2 VTi 82	177L, EB2F, HMZ(EB2F)	12/14 ⇨
DS3 1.2 VTi 82	177L, HMZ(EB2F)	01/13 ⇨ 07/15

DS

DS3 1.2 VTi 82	HMZ(EB2), HMZ(EB2F)	04/15 ⇨ 07/19
----------------	---------------------	---------------

OPEL

CORSA F 1.2	F12XEL(EB2FAD)	07/19 ⇨
CROSSLAND X 1.2	F12XE(EB2FA)	07/19 ⇨

PEUGEOT

108 1.2	HMT(EB2D), HMZ(EB2), HMZ(EB2F)	05/14 ⇨
108 1.2 VTi	HMZ(EB2)	05/14 ⇨
108 108 1.2	HMZ(EB2F)	05/14 ⇨
208 I 1.0	ZMZ(EBO)	03/12 ⇨
208 I 1.2 GPL	HMZ(EB2F)	06/15 ⇨
208 I 1.2 PureTech 82	HMR(EB2FA), HMZ(EB2F)	03/18 ⇨
208 I 1.2 VTi	HMZ(EB2)	09/13 ⇨
208 I 1.2 VTi 68 / PureTech 68	HMM(EB2FAD), HMP(EB2FB)	06/15 ⇨
208 I 1.2 VTi 82	HMZ(EB2), HMZ(EB2F)	03/12 ⇨
208 I 1.2 VTi 82 / PureTech 82	HMR(EB2FA), HMZ(EB2), HMZ(EB2F)	06/15 ⇨
208 II 1.2 PureTech 75	HMM(EB2FAD)	06/19 ⇨
301 1.2	HMZ(EB2F)	11/12 ⇨
301 1.2 PureTech 82	HMR(EB2FA)	02/18 ⇨
301 1.2 VTi 72	HMY(EB2M)	11/12 ⇨
301 1.2 VTi 82	HMZ(EB2F)	12/14 ⇨
308 II 1.2 VTi 72	HMZ(EB2), HMZ(EB2F)	09/13 ⇨

1.970.611

PEUGEOT		
2008 I 1.2 PureTech 82	HMR(EB2FA)	01/18 ⇨ 12/19
2008 I 1.2 VTi	HMZ(EB2), HMZ(EB2F)	03/13 ⇨
TOYOTA		
AYGO II 1.2	1PP	05/14 ⇨
VAUXHALL		
CORSA 1.2	F12XL(EB2FAD)	07/19 ⇨
CROSSLAND X 1.2	B12XE(EB2F), D12XE(EB2FA), F12XE(EB2FA)	03/17 ⇨

EPS 1.970.611



05,5

COILS

Adatt./Suitable:

BOSCH

0 986 221 078

DENSO

DIC-0207

HITACHI

134080

2504080

HYUNDAI

27301-2B100

KIA

27301-2B100

MAGNETI MARELLI

060717193012

ITEM NOW AVAILABLE FROM PRODUCTION

- ARTICOLO ORA DISPONIBILE PER LA VENDITA
- ARTICLE DISPONIBLE EN PRODUCTION COURANTE
- JETZT ZUM VERKAUF VERFÜGBARER ARTIKEL
- ARTICULO AHORA DISPONIBLE EN PRODUCCION



	ohm		ohm
	0,81		5640

HYUNDAI

I30 II 1.6	G4FC, G4FD, G4FG	12/11 ⇨ 12/16
I30 II 1.6 GDI	G4FD	12/11 ⇨
I40 1.6 GDI	G4FD	07/11 ⇨
IX35 1.6	G4FD	11/10 ⇨
IX35 GDI	G4FD	05/15 ⇨ 12/15
TUCSON 1.6 GDI	G4FD	06/15 ⇨ 09/20
VELOSTER 1.6 GDI	G4FD	03/11 ⇨ 12/17

KIA

CARENS III 1.6 GDI	G4FD	03/13 ⇨
CEED II 1.6 GDI	G4FD	05/12 ⇨ 07/18
PRO CEE'D II 1.6 GDI	G4FD	03/13 ⇨ 07/18
PRO CEE'D 1.6 GDI	G4FD	04/15 ⇨ 07/18
SOUL I 1.6 Flex	--	01/11 ⇨
SOUL I 1.6 GDI	G4FD	06/11 ⇨ 12/14
SOUL II 1.6 GDI	G4FD	02/14 ⇨
SPORTAGE III 1.6 GDI	G4FD	02/11 ⇨
SPORTAGE III 1.6 LPG	G4FD	01/14 ⇨ 12/15
SPORTAGE IV 1.6 GDI	G4FD	09/15 ⇨
SPORTAGE IV 1.6 LPG	G4FD	07/20 ⇨

EPS 1.970.612



05,5

COILS

Adatt./Suitable:

BOSCH

0 986 221 076

HITACHI

134079

2504079

HYUNDAI

27301-03110

KIA

27301-03110

MAGNETI MARELLI

060717187012

ITEM NOW AVAILABLE FROM PRODUCTION

- ARTICOLO ORA DISPONIBILE PER LA VENDITA
- ARTICLE DISPONIBLE EN PRODUCTION COURANTE
- JETZT ZUM VERKAUF VERFÜGBARER ARTIKEL
- ARTICULO AHORA DISPONIBLE EN PRODUCCION



	ohm		ohm
	0,81		5640

HYUNDAI

I20 II 1.2	G4LA	11/14 ⇨
I20 II 1.2 LPG	G4LA	01/19 ⇨
I20 II 1.2 LPGI	G4LA	11/14 ⇨
I20 II 1.2 MPI	G4LA	05/15 ⇨
I20 I 1.2	G4LA	03/12 ⇨ 12/15

KIA

PICANTO II 1.2	G4LA	09/11 ⇨ 03/17
PICANTO III 1.2	G4LA	03/17 ⇨
RIO III 1.2 CVT	G4LA	11/14 ⇨ 12/17
RIO III 1.25 CVT	G4LA	06/11 ⇨ 12/17
RIO III 1.25 LPG	G4LA	09/11 ⇨ 12/17
RIO IV 1.25	G4LA	01/17 ⇨
STONIC 1.2 CVT	G4LA	07/17 ⇨

EPS 1.970.613



05,5

COILS

Adatt./Suitable:

BOSCH

0 986 221 079

DACIA

22 43 324 28R

HITACHI

134058

2504058

LADA

22 43 324 28R

MAGNETI MARELLI

060810258010

MERCEDES-BENZ

A 281 906 00 00

NISSAN

22448-00Q0F

RENAULT

22 43 324 28R

H82 01 154 128

SMART

A 281 906 00 00

NEW - ITEM NOW AVAILABLE FROM PRODUCTION

- NUOVO - ARTICOLO ORA DISPONIBILE PER LA VENDITA
- NOUVEAU - ARTICLE DISPONIBLE EN PRODUCTION COURANTE
- NEU - JETZT ZUM VERKAUF VERFÜGBARER ARTIKEL
- NUEVO - ARTICULO AHORA DISPONIBLE EN PRODUCCION

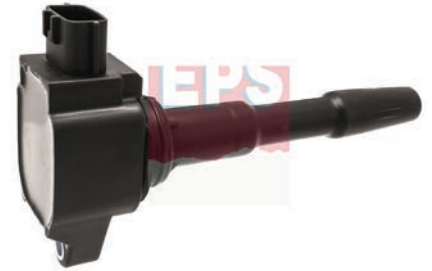

	ohm		ohm	
	---		---	

DACIA

DOKKER 1.2 TCe	H5F402, H5F408	11/12 ⇨
DOKKER 1.2 TCe 115	--, H5F402, H5F408	12/12 ⇨
DOKKER 1.6	H4M738, H4M740	11/12 ⇨
DOKKER 1.6 LPG	H4M740	04/15 ⇨
DUSTER 1.2 TCe 125	H5F404, H5F408	01/12 ⇨
DUSTER 1.2 TCe 125 4x4	H5F404	10/13 ⇨
DUSTER 1.6 SCe 115	H4M438, H4M738	06/15 ⇨
DUSTER 1.6 SCe 115 4x4	H4M430, H4M730, H4M738	06/15 ⇨
DUSTER 1.6 SCe 115 LPG	H4M740	06/15 ⇨
LODGY 1.2 TCe	H5F402, H5F408	03/12 ⇨
LODGY 1.6	H4M738	03/12 ⇨
LODGY 1.6 LPG	H4M740	04/15 ⇨
LODGY 1.6 SCe 100	H4M738, H4M740	06/15 ⇨
LOGAN II TCe 90	H4B400, H4B408, H4B410	10/12 ⇨
LOGAN II TCe 90 LPG	H4B410	09/15 ⇨
LOGAN II MCV TCe 90	H4B400, H4B408	02/13 ⇨
LOGAN II MCV TCe 90 LPG	H4B410	09/15 ⇨
SANDERO II TCe 90	--, H4B400, H4B408	10/12 ⇨
SANDERO II TCe 90 LPG	H4B410	09/15 ⇨

LADA

VESTA 1.6	H4M	11/19 ⇨
-----------	-----	---------

MERCEDES-BENZ

CITAN 112	M200.711	06/13 ⇨ 08/21
-----------	----------	---------------

NISSAN

JUKE I 1.2 DIG-T	HR12DDT, HRA2DDT	05/14 ⇨
MICRA V 0.9 IG-T	HR09DET	12/16 ⇨
MICRA V 0.9 LPG	HR09DET	03/19 ⇨
PULSAR 1.2 DIG-T	HRA2DDT	10/14 ⇨
TERRANO III 1.6	H4M	12/15 ⇨
TERRANO III 1.6 4x4	H4M	12/15 ⇨
QASHQAI II 1.2 DIG-T	HR12DDT, HRA2DDT	11/13 ⇨

RENAULT

MEGANE IV 1.2 TCe 100	H5F408	11/15 ⇨
MEGANE IV 1.2 TCe 130	H5F408	11/15 ⇨
MEGANE IV 1.6 16V	H4M738, H4M750	11/15 ⇨
MEGANE IV 1.6 SCe	H4M738, H4M750	10/16 ⇨
CAPTUR 0.9 TCe 90	H4B400, H4B408	06/13 ⇨
CAPTUR 1.2 T	H5F403	06/13 ⇨
CAPTUR 1.2 TCe	H5F408	02/18 ⇨
CAPTUR 1.2 TCe 120	H5F403, H5F408, H5F412	06/13 ⇨
MEGANE III 1.2 TCe	H5F400, H5F404, H5F405, H5F408, H5F412	03/12 ⇨
KANGOO II 1.2 TCe 115	H5F400, H5F408, H5F412	07/13 ⇨
CLIO IV 0.9 TCe 75	H4B408	05/18 ⇨

RENAULT		
CLIO IV 0.9 TCe 90	H4B400, H4B408	11/12 →
CLIO IV 0.9 TCe 90 LPG	H4B410	08/15 →
CLIO IV 1.2 TCe 120	H5F403, H5F408, H5F412	03/13 →
DUSTER 1.6 16V	H4M438	06/15 →
DUSTER 1.6 16V 4x4	H4M430	06/15 →
GRAND SCÉNIC III 1.2 TCe	H5F400, H5F404, H5F408	04/12 →
GRAND SCÉNIC IV 1.2 TCe 115	H5F408	09/16 →
GRAND SCÉNIC IV 1.2 TCe 130	H5F408	09/16 →
KADJAR 1.2 TCe 130	H5F408	06/15 →
KAPTUR 1.6	H4M429, H4M438	03/16 →
LOGAN/STEPWAY 1.6	H4M429, H4M438	09/16 →
SANDERO II 1.6	H4M429, H4M438	09/16 →
SANDERO II TCe 90	H4B400, H4B408, H4B410, H4B411	09/15 →
SCÉNIC III 1.2 TCe	H5F400, H5F404, H5F408	04/12 →
SCÉNIC IV 1.2 TCe 115	H5F408	09/16 →
SCÉNIC IV 1.2 TCe 130	H5F408	09/16 →
TWINGO III 0.9 TCe 110	H4B401	11/16 →
TWINGO III 0.9 TCe 90	H4B401	09/14 →
TWINGO III 0.9 TCe 90 LPG	H4B451	08/18 →
TWINGO III 1.0 SCe 70	H4D400	09/14 →
MEGANE CC 1.2 TCe	H5F400, H5F404	09/12 →

SMART		
FORFOUR III 0.9	M281.910	11/14 →
FORFOUR III 0.9 Brabus	M281.910	07/16 →
FORFOUR III 1.0	M281.920	07/14 →
FORTWO III 0.9	M281.910	09/14 →
FORTWO III 0.9 Brabus	M281.910	07/16 →
FORTWO III 1.0	M281.920	07/14 →

EPS 1.970.614



COILS

Adatt./Suitable:

- BOSCH**
0 986 221 075
- DENSO**
DIC-0209
- HITACHI**
134081
2504081
- HYUNDAI**
27301-04000
- KIA**
27301-04000

ITEM NOW AVAILABLE FROM PRODUCTION

- ARTICOLO ORA DISPONIBILE PER LA VENDITA
- ARTICLE DISPONIBLE EN PRODUCTION COURANTE
- JETZT ZUM VERKAUF VERFÜGBARER ARTIKEL
- ARTICULO AHORA DISPONIBLE EN PRODUCCION



	ohm		ohm
	0,81		5640

HYUNDAI

I10 I 1.0	G3LA	01/11 → 12/17
I10 II 1.0	G3LA	08/13 →
I10 II 1.0 LPG	B3LA	02/14 →

KIA

PICANTO II 1.0	G3LA	05/11 → 03/17
PICANTO II 1.0 Bi-Fuel	B3LA	05/11 → 10/14
PICANTO II 1.0 LPG	B3LA	08/13 → 03/17

EPS 1.970.619



COILS

Adatt./Suitable:

- FORD**
1 760 593
1 776 803
1 827 901
CM5G-12A366-BA
CM5G-12A366-CA
CM5G-12A366-CB
- FORD USA**
CM5G-12A366-BA
- HITACHI**
134085
2504085
- MAGNETI MARELLI**
060717173012

NEW - ITEM NOW AVAILABLE FROM PRODUCTION

- NUOVO - ARTICOLO ORA DISPONIBILE PER LA VENDITA
- NOUVEAU - ARTICLE DISPONIBLE EN PRODUCTION COURANTE
- NEU - JETZT ZUM VERKAUF VERFÜGBARER ARTIKEL
- NUEVO - ARTICULO AHORA DISPONIBLE EN PRODUCCION



	ohm		ohm
	---		---

FORD

B-MAX 1.0 EcoBoost	M1JA, M1JE, M1JH, SFJA, SFJB, SFJC, SFJD, YYJC	08/12 →
C-MAX II 1.0 EcoBoost	--, M1DA, M1DD, M2DA, M2DC, SFDA	10/12 →
ECOSPORT 1.0 EcoBoost	M1JC, M1JJ, M1JU, SFJL, YYJD, YYJF	10/13 →
FIESTA VI 1.0	P4JA, P4JB, P4JC, P4JD, XMJA, XMJB, XMJC, XMJD	10/12 →
FIESTA VI 1.0 EcoBoost	M1JE, M1JH, SFJA, SFJB, SFJC, SFJD, YYJA, YYJB	09/12 →
FIESTA VI 1.0 Sport	YYJA, YYJB	05/14 → 04/17
FIESTA VII 1.0 EcoBoost	M1JL, M1JM, M1JP, QOJA, QOJB, QOJC, QOJD, SEJE, SEJF, SEJH, SEJJ, SFJK, SFJL, SFJP, YYJE, YYJG	05/17 →
FIESTA VII 1.0 EcoBoost Active	M1JL, M1JM, M1JP, SFJE, SEJF, SEJH, SEJJ, SFJK, SFJL, SFJP, YYJE, YYJG	04/18 →
FIESTA VII 1.0 EcoBoost mHEV	BZJA	07/20 →
FIESTA VII 1.0 EcoBoost mHEV Active	BZJA	01/21 →
FOCUS III 1.0 EcoBoost	M1DA, M1DC, M1DD, M1DH, M2DA, M2DB, M2DC, SFDA, SFDB	02/12 →
GRAND C-MAX 1.0 EcoBoost	M1DA, M1DD, M2DA, M2DC, SFDA	10/12 → 06/19
MONDEO IV 1.0 EcoBoost	M1CA, M1CB	02/15 →
TOURNEO COURIER 1.0 EcoBoost	SFCA, SFCB, SFCC, SFCD, SFCE, SFCF	02/14 →
TOURNEO CUSTOM 1.0 EcoBoost PHEV	M1FA	04/20 →
TRANSIT CONNECT II 1.0 EcoBoost	M2GA, M2GB	02/13 →
TRANSIT COURIER 1.0 EcoBoost	SFCA, SFCB, SFCC, SFCD, SFCE, SFCF	02/14 →
TRANSIT CUSTOM 1.0 EcoBoost PHEV	M1FA	04/20 →

EPS 1.970.620



COILS

Adatt./Suitable:

- BOSCH**
0 986 221 102
- CITROËN**
96 753 909 80
- DS**
96 753 909 80
- GENERAL MOTORS**
3 639 845
- HITACHI**
133962
2503962
- OPEL**
3639845
9675390980
- PEUGEOT**
96 753 909 80
- VAUXHALL**
3639845
9675390980

NEW - ITEM NOW AVAILABLE FROM PRODUCTION

- NUOVO - ARTICOLO ORA DISPONIBILE PER LA VENDITA
- NOUVEAU - ARTICLE DISPONIBLE EN PRODUCTION COURANTE
- NEU - JETZT ZUM VERKAUF VERFÜGBARER ARTIKEL
- NUEVO - ARTICULO AHORA DISPONIBLE EN PRODUCCION



	ohm		ohm
	0,55		---

CITROËN

C4 PICASSO II 1.2 THP 130	HNY(EB2DTS)	04/14 →
C3 III PureTech 110	HNZ(EB2DT)	03/19 →
C3 AIRCROSS PureTech 82	HNZ(EB2DT)	05/19 →
C3 PICASSO 1.2 THP 110	HNZ(EB2DT)	01/15 →
C3 II 1.2 THP 110	HNZ(EB2DT)	10/14 →
C4 II 1.2 THP 110	8D4HH, HNZ(EB2DT)	02/15 → 12/17
C4 II 1.2 THP 130	HNY(EB2DTS)	04/14 →
C4 III 1.2 PureTech 110	HNZ(EB2DTS)	04/18 →
C4 III PureTech 130	HNY(EB2DTS)	05/19 →
C4 CACTUS PureTech 130	HNY(EB2DTS)	05/19 →
BERLINGO II 1.2 PureTech 110	--, EB2DT, HNZ(EB2DT)	02/16 →
C4 GRAND PICASSO II 1.2 THP 130	HNY(EB2DTS)	04/14 →
DS3 1.2 THP 110	HNZ(EB2DT)	10/14 → 07/15
DS4 1.2 THP 130	HNY(EB2DTS)	07/14 → 07/15
GRAND C4 SPACETOURER PureTech 130	HNY(EB2DTS)	05/19 →

DS

DS3 1.2 THP 110 / PureTech 110	HNP(EB2ADT), HNZ(EB2DT)	04/15 → 07/19
DS3 1.2 THP 130	HNY(EB2DTS)	09/15 → 07/19
DS4 / DS4 CROSSBACK 1.2 THP 130	HNY(EB2DTS)	07/15 → 12/18

OPEL

GRANDLAND / GRANDLAND X 1.2	B12XHT(EB2DTS)	06/17 →
-----------------------------	----------------	---------

PEUGEOT

308 II 1.2 THP 130	HNY(EB2DTS)	03/14 → 06/21
2008 I 1.2 THP 130 / PureTech 130	HNS(EB2ADTS), HNY(EB2DTS)	01/15 →
2008 I PureTech 130	HNS(EB2ADTS), HNY(EB2DTS)	01/18 →
3008 I 1.2	HNY(EB2DTS)	01/15 → 08/16
3008 II 1.2 THP / PureTech 130	HNS(EB2ADTS), HNY(EB2DTS)	05/16 →
3008 II PureTech 130	HNY(EB2DTS)	05/16 →
5008 I 1.2	HNY(EB2DTS)	01/15 → 03/17
PARTNER II 1.2 THP	HNZ(EB2DT)	02/16 →
PARTNER II TEPEE 1.2 THP	HNV(EB2DTM), HNZ(EB2DT)	02/16 →

VAUXHALL

CROSSLAND X 1.2	B12XHL(EB2DT), B12XHT(EB2DTS)	03/17 →
GRANDLAND X 1.2 Turbo	B12XHT(EB2DTS)	06/17 →

1.970.621

EPS 1.970.621



05,5

COILS

Adatt./Suitable:

SUZUKI

33400-60R00
33400-60R00-000
33400-78P00
33400-78P00-000
33400-81P00
33400-81P00-000
33400M68P10
33400M68P10-000

NEW - ITEM NOW AVAILABLE FROM PRODUCTION

- NUOVO - ARTICOLO ORA DISPONIBILE PER LA VENDITA
- NOUVEAU - ARTICLE DISPONIBLE EN PRODUCTION COURANTE
- NEU - JETZT ZUM VERKAUF VERFÜGBARER ARTIKEL
- NUEVO - ARTICULO AHORA DISPONIBLE EN PRODUCCION

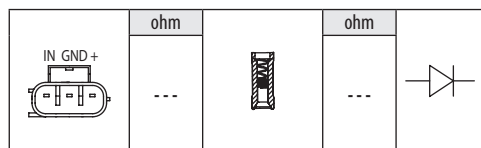

SUZUKI

BALENO 1.0	K10CT	02/16 ⇨
BALENO 1.2	K12C	02/16 ⇨
BALENO 1.2 Hybrid	K12C	02/16 ⇨
IGNIS III 1.2	K12C	10/16 ⇨
IGNIS III 1.2 AllGrip	K12C	10/16 ⇨
IGNIS III 1.2 Hybrid	K12C	10/16 ⇨
IGNIS III 1.2 Hybrid AllGrip	K12C	10/16 ⇨
SWIFT V 1.2	K12B	08/12 ⇨
SWIFT V 1.2 4WD	K12B	08/12 ⇨
SWIFT VI 1.0	K10C	04/17 ⇨
SWIFT VI 1.0 SHVS	K10C	04/17 ⇨
SWIFT VI 1.2	K12C	04/17 ⇨
SWIFT VI 1.2 AllGrip	K12C	04/17 ⇨
SWIFT VI 1.2 SHVS	K12C	04/17 ⇨
SWIFT VI 1.2 SHVS AllGrip	K12C	04/17 ⇨
SWIFT VI 1.4 Sport	K14C	09/17 ⇨
SX4 II 1.0	K10C	08/16 ⇨
SX4 II 1.0 AllGrip	K10C	08/16 ⇨
SX4 II 1.4 T	K14C	08/16 ⇨
SX4 II 1.4 T AllGrip	K14C	08/16 ⇨
VITARA IV 1.0	K10C	10/18 ⇨
VITARA IV 1.0 AllGrip	K10C	10/18 ⇨
VITARA IV 1.4 T	K14C	09/15 ⇨
VITARA IV 1.4 T AllGrip	K14C	09/15 ⇨

EPS 1.970.622



05,5

COILS

Adatt./Suitable:

HYUNDAI

27301-03200

KIA

27301-03200

NEW - ITEM NOW AVAILABLE FROM PRODUCTION

- NUOVO - ARTICOLO ORA DISPONIBILE PER LA VENDITA
- NOUVEAU - ARTICLE DISPONIBLE EN PRODUCTION COURANTE
- NEU - JETZT ZUM VERKAUF VERFÜGBARER ARTIKEL
- NUEVO - ARTICULO AHORA DISPONIBLE EN PRODUCCION

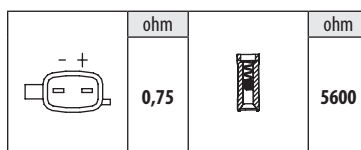

HYUNDAI

ACCENT V 1.4	G4LC	07/18 ⇨
BAYON 1.4 MPI	G4LC	05/21 ⇨
ACCENT IV 1.4	G4LC	11/10 ⇨
ACCENT IV 1.4 CVT	--	11/10 ⇨
I20 II 1.4	G4LC	11/14 ⇨
I20 II 1.4 MPi	G4LC	05/15 ⇨
I30 II 1.4	G4LC	12/14 ⇨
I30 II 1.4 MPI	G4LC	05/15 ⇨
I30 III 1.4 MPI	G4LC	11/16 ⇨
SOLARIS 1.4	G4LC	01/17 ⇨
KIA		
CEED II 1.4 MPI	G4LC	04/15 ⇨ 07/18
CEED III 1.4	G4LC	03/18 ⇨
CEED III 1.4 LPG	G4LC	12/18 ⇨
PRO CEE'D II 1.4 MPI	G4LC	07/13 ⇨ 07/18
RIO IV 1.4	G4LC	01/17 ⇨
STONIC 1.4 CVVT	G4LC	07/17 ⇨
STONIC 1.4 LPG	G4LC	11/18 ⇨

EPS 1.970.623



05,5

COILS

Adatt./Suitable:

FORD

1 800 554
1 836 729
DS7G-12A366-BA
DS7G-12A366-BB

HITACHI

133956

NEW - ITEM NOW AVAILABLE FROM PRODUCTION

- NUOVO - ARTICOLO ORA DISPONIBILE PER LA VENDITA
- NOUVEAU - ARTICLE DISPONIBLE EN PRODUCTION COURANTE
- NEU - JETZT ZUM VERKAUF VERFÜGBARER ARTIKEL
- NUEVO - ARTICULO AHORA DISPONIBLE EN PRODUCCION

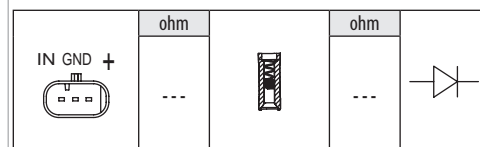

FORD

C-MAX II 1.5 16V	--	03/15 ⇨
C-MAX II 1.5 EcoBoost	M8DB, M8DF, M9DB	03/15 ⇨ 06/19
FOCUS III 1.5 EcoBoost	M8DA, M8DB, M8DD, M8DE, M9DA, M9DB	09/14 ⇨
GALAXY III 1.5 EcoBoost	C15HDTX, UNCL, UNCK	01/15 ⇨
GRAND C-MAX 1.5 EcoBoost	M8DB, M8DF, M9DB	03/15 ⇨ 06/19
KUGA II 1.5 16V	--	03/13 ⇨
KUGA II 1.5 EcoBoost	BNMA, M8MA, M8MB, M8MC, M8MD, M8ME	09/14 ⇨
KUGA II 1.5 EcoBoost 4x4	OCEAA, 285ZV604, 37F3P674K, 65M4R730, M8MA, M8MB, M8MD, M9MA, M9MC, M9ME	09/14 ⇨
MONDEO IV 1.5 EcoBoost	UNCA, UNCB, UNCE, UNCF, UNCN	09/14 ⇨
MONDEO IV 1.5 GTDI	--	09/14 ⇨
S-MAX II 1.5 EcoBoost	6CF4G15, C15HDTX, UNCL, UNCL, UNCK	01/15 ⇨

EPS 1.970.626

07,5

COILS

Adatt./Suitable:

INFINITI

22448-2V70A
22448-HG00A
22448-HG00B
22448-HG00C
22448-HG00E

MERCEDES-BENZ

A 274 906 06 00
A 274 906 07 00
A 274 906 14 00

NEW - ITEM NOW AVAILABLE FROM PRODUCTION

- NUOVO - ARTICOLO ORA DISPONIBILE PER LA VENDITA
- NOUVEAU - ARTICLE DISPONIBLE EN PRODUCTION COURANTE
- NEU - JETZT ZUM VERKAUF VERFÜGBARER ARTIKEL
- NUEVO - ARTICULO AHORA DISPONIBLE EN PRODUCCION



	ohm		ohm	
...

INFINITI

Q30 2.0 T	270920	11/15 ⇔
Q30 2.0 T AWD	270920	11/15 ⇔
Q50 2.0 T	M274	04/14 ⇔
Q60 2.0 T	M274	09/16 ⇔
QX30 2.0 AWD	270920	09/16 ⇔

MERCEDES-BENZ

CLASSE CLS II CLS 250	M274.920	05/14 ⇔
CLASSE B II B 160	M270.910	07/15 ⇔ 12/18
CLASSE B II B 180	M270.910	11/11 ⇔ 12/18
CLASSE B II B 200	M270.910	11/11 ⇔ 12/18
CLASSE B II B 200 Natural Gas Drive / B 200 c	M270.920, M270920NGT	11/12 ⇔ 12/17
CLASSE B II B 220 4-matic	M270.920	05/13 ⇔ 12/18
CLASSE B II B 250	M270.920	05/12 ⇔ 12/18
CLASSE B II B 250 4-matic	M270.920	08/14 ⇔ 12/18
CLASSE C III C 180	M274.910	02/12 ⇔
CLASSE C III C 180 CGI	M274.910	01/08 ⇔ 01/14
CLASSE C IV C 160	M274.910	04/15 ⇔
CLASSE C IV C 180	M274.910	03/14 ⇔
CLASSE C IV C 200	M274.920	12/13 ⇔ 08/18
CLASSE C IV C 200 4-matic	M274.920	04/15 ⇔ 08/18
CLASSE C IV C 250	M274.920	03/14 ⇔ 05/18
CLASSE C IV C 300	M274.920	09/15 ⇔ 12/18
CLASSE C IV C 300 4-matic	M274.920	12/13 ⇔ 08/18
CLASSE C IV C 300 e	M274.920	07/19 ⇔
CLASSE C IV C 300 e 4-matic	M274.920	07/19 ⇔
CLASSE C IV C 350 e	M274.920	02/15 ⇔ 08/18
CLASSE CLA AMG CLA 45 4-matic	M133.980	07/15 ⇔ 03/19
CLASSE CLA CLA 180	M270.910	01/13 ⇔ 03/19
CLASSE CLA CLA 200	M270.910	01/13 ⇔ 03/19
CLASSE CLA CLA 220 4-matic	M270.910, M270.920	01/15 ⇔
CLASSE CLA CLA 250	M270.920	01/13 ⇔ 03/19
CLASSE CLA CLA 250 4-matic	M270.920	07/13 ⇔ 03/19
CLASSE CLA CLA 45 AMG 4-matic	M133.980	07/13 ⇔ 03/19
CLASSE E IV E 180	M274.910	12/12 ⇔
CLASSE E IV E 200	M274.920	11/12 ⇔ 12/16
CLASSE E IV E 200 NGT	M274.920, M274920NGT	07/13 ⇔ 12/15
CLASSE E IV E 250	M274.920	11/12 ⇔ 12/16
CLASSE E V E 180	M274.910	01/17 ⇔
CLASSE E V E 200	M274.920	01/16 ⇔
CLASSE E V E 200 4-matic	M274.920	07/16 ⇔
CLASSE E V E 250	M274.920	07/16 ⇔
CLASSE E V E 300	M274.920	07/16 ⇔
CLASSE E V E 300 e	M274.920	11/18 ⇔
CLASSE E V E 300 e 4-matic	M274.920	07/20 ⇔
CLASSE E V E 350 e	M274.920	07/16 ⇔
CLASSE GLA AMG GLA 45 4-matic	M133.980	07/15 ⇔
CLASSE GLA GLA 180	M270.910	02/15 ⇔
CLASSE GLA GLA 200	M270.910	12/13 ⇔
CLASSE GLA GLA 220 4-matic	M270.920	01/17 ⇔

MERCEDES-BENZ

CLASSE GLA GLA 250	M270.920	12/13 ⇔
CLASSE GLA GLA 250 4-matic	M270.920	12/13 ⇔
CLASSE GLA GLA 250 Flex	M270.920	01/15 ⇔
CLASSE GLA GLA 45 AMG 4-matic	M133.980	05/14 ⇔
CLASSE GLC 250 4-matic	M274.920	06/15 ⇔ 04/19
CLASSE GLC 300 4-matic	M274.920	07/15 ⇔ 04/19
CLASSE GLC 300 e 4-matic	M274.920	11/19 ⇔
CLASSE GLC 350 e 4-matic	M274.920	01/16 ⇔ 04/19
CLASSE GLK 200	M274.920	08/13 ⇔ 06/15
CLASSE GLK 250	M274.920	08/13 ⇔ 06/15
CLASSE GLK 250 4-matic	M274.920	08/13 ⇔ 06/15
CLASSE SLC 180	M274.910	01/16 ⇔
CLASSE SLC 200	M274.920	01/16 ⇔
CLASSE SLC 300	M274.920	01/16 ⇔
CLASSE SLK III 200	M274.920	04/15 ⇔
CLASSE SLK III 300	M274.920	07/15 ⇔
GLE GLE 350 e 4-matic	M274.920	06/20 ⇔
CLASSE A III A 160	M270.910	07/15 ⇔ 05/18
CLASSE A III A 180	M270.910	09/12 ⇔ 05/18
CLASSE A III A 200	M270.910	06/12 ⇔ 05/18
CLASSE A III A 220 4-matic	M270.920	05/14 ⇔ 05/18
CLASSE A III A 250	M270.920	06/12 ⇔ 05/18
CLASSE A III A 250 4-matic	M270.920	06/13 ⇔ 05/18
CLASSE A III A 45 AMG 4-matic	M133.980	06/13 ⇔ 05/18
CLASSE A III AMG A 45 4-matic	M133.980	07/15 ⇔ 05/18

EPS 1.970.627

05,5

COILS

Adatt./Suitable:

HITACHI

133965

MAZDA

P51B-18-100
PE01-18-100
PE20-18-100
PE20-18-100A
PYF5-18-100

NEW - ITEM NOW AVAILABLE FROM PRODUCTION

- NUOVO - ARTICOLO ORA DISPONIBILE PER LA VENDITA
- NOUVEAU - ARTICLE DISPONIBLE EN PRODUCTION COURANTE
- NEU - JETZT ZUM VERKAUF VERFÜGBARER ARTIKEL
- NUEVO - ARTICULO AHORA DISPONIBLE EN PRODUCCION



	ohm		ohm	
...

MAZDA

2 III 1.5	P5X0, P5X2, P5Y4, P5Y5, P5Y6, P5Y8, P5Z7, P5Z8, P5Z9	08/14 ⇔
2 III 1.5 SKYACTIV-G	P5X0, P5X2, P5Y5, P5Y6, P5Y8, P5Z2, P5Z3, P5Z7, P5Z8, P5Z9	08/14 ⇔
3 III 1.5	P5-VPS, P5Y1, P5Y4, P5Y5, P5Z3	09/13 ⇔
3 III 2.0	LFX, PEX2, PEXL, PEY5, PEY7	07/13 ⇔
3 III 2.0 Hybrid	--, PE-VPH	10/14 ⇔
3 IV 1.5 SKYACTIV-G	P5X4	11/18 ⇔
3 IV 2.0 SKYACTIV-G	PEXN, PEXP	11/18 ⇔
3 IV 2.0 SKYACTIV-G M Hybrid	PEXN	11/18 ⇔
3 IV 2.0 SKYACTIV-X M Hybrid	HFY7	02/21 ⇔
3 IV SKYACTIV-X M Hybrid	HFY7	02/21 ⇔
3 IV SKYACTIV-X M Hybrid AWD	HFY7	02/21 ⇔
6 III 2.0	PE-VPR, PEXB, PEXL, PEY5, PEY7	12/12 ⇔
6 III 2.5	PYY1, PYY3, PY-Y8, PYZ4, PYZ8, PY-ZA, PYZC	12/12 ⇔

MAZDA

CX-3 2.0 SKYACTIV-G	PEX3, PEXB, PEXT	05/15 ⇔
CX-3 2.0 SKYACTIV-G AWD	PEX3, PEXB, PEXT	05/15 ⇔
CX-5 2.0	PE-VPS, PEX3, PEXB, PEXP, PEY4, PEY5, PEY6, PEY7	11/11 ⇔
CX-5 2.0 AWD	PE-VPS, PEX3, PEXB, PEXP, PEY4, PEY5, PEY6, PEY7	11/11 ⇔
CX-5 2.0 SKYACTIV-G	PEXB, PEXP	03/18 ⇔
CX-5 2.0 SKYACTIV-G AWD	PEXB, PEXP	03/18 ⇔
CX-5 2.5	PY-VPS, PYY1, PYZ8, PYZC	02/13 ⇔
CX-5 2.5 4WD	PY-VPS	07/14 ⇔
CX-5 2.5 AWD	PYY1, PY-Y8, PYZ8, PY-ZA, PYZC	02/15 ⇔
CX-5 SKYACTIV-G	PEY7	04/15 ⇔ 02/17
CX-5 SKYACTIV-G AWD	PEY7, PYY1	04/15 ⇔ 02/17
CX-9 2.5 T AWD	PYZ4	06/16 ⇔
CX-30 e-SKYACTIV-X M Hybrid	HFY7	06/21 ⇔
CX-30 e-SKYACTIV-X M Hybrid AWD	HFY7	06/21 ⇔
CX-30 SKYACTIV-G M Hybrid	PEXN, PEXW	07/19 ⇔
CX-30 SKYACTIV-G M Hybrid AWD	PEXN, PEXW	07/19 ⇔
CX-30 SKYACTIV-X M Hybrid	HFY1	07/19 ⇔
CX-30 SKYACTIV-X M Hybrid AWD	HFY1	07/19 ⇔
MX-5 IV 1.5	P5-VPR, P5X1, P5Z1	06/15 ⇔
MX-5 IV 2.0	PEX4, PEX6, PEXF	06/15 ⇔

EPS 1.970.631

07

COILS

Adatt./Suitable:

GENERAL MOTORS

12 635 672
12 670 053
12 697 989

HITACHI

134093
2504093

OPEL

12 08 117
12635672
12670053
12697989

VAUXHALL

12635672
12670053
12697989

NEW - ITEM NOW AVAILABLE FROM PRODUCTION

- NUOVO - ARTICOLO ORA DISPONIBILE PER LA VENDITA
- NOUVEAU - ARTICLE DISPONIBLE EN PRODUCTION COURANTE
- NEU - JETZT ZUM VERKAUF VERFÜGBARER ARTIKEL
- NUEVO - ARTICULO AHORA DISPONIBLE EN PRODUCCION



	ohm		ohm	
...	6680	...

OPEL

ADAM 1.0	B10XFL, B10XFT, D10XFL, D10XFT	07/14 ⇔ 11/18
ASTRA K 1.0	D10XFL	05/18 ⇔
ASTRA K 1.0 Turbo	B10XFL, D10XFL	06/15 ⇔
ASTRA K 1.4	D14XFT	06/18 ⇔
ASTRA K 1.4 CNG	B14XNT	10/17 ⇔
ASTRA K 1.4 Turbo	B14XFL, B14XFT, D14XFT, D14XFL	06/15 ⇔
CORSA E 1.0	B10XFL, B10XFT, D10XFL, F10XFL	09/14 ⇔
INSIGNIA B 1.5	B15SFL, B15SFT, D15SFL, D15SFT	03/17 ⇔
MOKKA 1.4 4x4	B14XFT	06/16 ⇔

VAUXHALL

ADAM 1.0	B10XFL, B10XFT, D10XFT	07/14 ⇔
ASTRA VII 1.0	B10XFL, D10XFL	07/15 ⇔
ASTRA VII 1.4 Turbo	B14XFL, B14XFT	07/15 ⇔
CORSA E 1.0	B10XFL, B10XFT, D10XFL, D10XFT, F10XFL	08/14 ⇔
INSIGNIA 1.5	B15SFL, B15SFT, D15SFL, D15SFT, D15XHT	03/17 ⇔
MOKKA / MOKKA X 1.4 4x4	B14XFT	06/16 ⇔

1.970.632

EPS 1.970.632

05,5

COILS

Adatt./Suitable:

BMW

12 13 7 619 385
12 13 8 615 991
12 13 8 643 360
12 13 8 647 463
12 13 8 678 438
8 643 360

BOSCH

0 986 221 124

HITACHI

134090
2504090

MINI

12 13 7 619 385
12 13 8 615 991
12 13 8 643 360
12 13 8 647 463
12 13 8 678 438
8 643 360
8 647 463

TOYOTA

90118-WA474

NEW - ITEM NOW AVAILABLE FROM PRODUCTION

- NUOVO - ARTICOLO ORA DISPONIBILE PER LA VENDITA
- NOUVEAU - ARTICLE DISPONIBLE EN PRODUCTION COURANTE
- NEU - JETZT ZUM VERKAUF VERFÜGBARER ARTIKEL
- NUEVO - ARTICULO AHORA DISPONIBLE EN PRODUCCION



	ohm		ohm	
- GND +			...	
	0,45			

BMW

3 VI 318 i	B38B15A	07/15 →	06/19
3 VI 320 i	B48B20A	07/15 →	
3 VI 320 i xDrive	B48B20A	07/15 →	
3 VI 330 e	B48B20A	11/15 →	10/18
3 VI 330 i	B46B20B, B48B20B	07/15 →	
3 VI 330 i xDrive	B48B20B	07/15 →	
3 VI 340 i	B58B30A	07/15 →	
3 VI 340 i xDrive	B58B30A	07/15 →	
1 II 116 i	B38B15A	03/15 →	
1 II 118 i	B38B15A	03/15 →	
1 II 120 i	B48B20A	07/16 →	
1 II 125 i	B48B20B	10/15 →	
1 II M 140 i	B58B30A	10/15 →	
1 II M 140 i xDrive	B58B30A	09/15 →	
1 III 116 i	B38A15A	11/20 →	
1 III 118 i	B38A15A	07/19 →	
1 III 120 i	B48A20A, B48A20F	11/20 →	
1 III 128 ti	B48A20B, B48A20E	11/20 →	
1 III M 135 i xDrive	B48A20E	07/19 →	
2 216 i	B38A15A	09/14 →	
2 218 i	B38A15A, B38B15A	07/14 →	
2 220 i	B48A20A, B48A20F, B48B20A	03/14 →	
2 220 i xDrive	B48A20A	03/21 →	
2 225 i	B48A20B	11/13 →	
2 225 i xDrive	B48A20B	03/14 →	
2 225 xe Plug-in-Hybrid	B38A15A	11/14 →	
2 230 i	B48B20B	07/16 →	
2 M 235 i xDrive	B48A20E	11/19 →	
2 M 240 i	B58B30A	09/15 →	
2 M 240 i xDrive	B58B30A	09/15 →	
3 III 320 i	B46B20B, B48B20A	11/19 →	
3 III 330 i	B48B20B	07/19 →	
3 III M 340 i xDrive	B58B30B	11/19 →	
3 VII 318 i	B48B20A	03/20 →	
3 VII 320 e Plug-in-Hybrid	B48B20A	07/20 →	
3 VII 320 e Plug-in-Hybrid xDrive	B48B20A	03/21 →	
3 VII 320 i	B46B20B, B48B20A, B48B20B	03/19 →	
3 VII 320 i 1.6	B48B16A	03/19 →	
3 VII 320 i xDrive	B48B20A	07/19 →	
3 VII 330 e Plug-in-Hybrid	B46B20B, B48B20A	07/19 →	
3 VII 330 e Plug-in-Hybrid xDrive	B48B20A	07/20 →	
3 VII 330 i	B48B20B	11/18 →	
3 VII 330 i xDrive	B46B20B, B48B20B	11/18 →	

BMW

3 VII M 340 i Mild-Hybrid xDrive	B58B30B	11/20 →	
3 VII M 340 i xDrive	B58B30B	03/19 →	
3 VII M3	B58B30B	11/20 →	
3 VII M3 Competition	S58B30A	11/20 →	
3 VII M3 Competition xDrive	S58B30A	05/21 →	
4 418 i	B38B15A	07/15 →	
4 420 i	B46B20B, B48B20A	03/16 →	
4 420 i 1.6	B48B16A	11/20 →	
4 420 i xDrive	B48B20A	03/16 →	
4 430 i	B46B20B, B48B20B	03/16 →	
4 430 i xDrive	B48B20B	03/16 →	
4 440 i	B58B30A	03/16 →	
4 440 i xDrive	B58B30A	03/16 →	
4 M 440 i Mild-Hybrid	B58B30B	07/21 →	
4 M 440 i Mild-Hybrid xDrive	B58B30B	07/20 →	
4 M4	S58B30B	11/20 →	
4 M4 Competition	S58B30A	11/20 →	
4 M4 Competition M xDrive	S58B30A	07/21 →	
4 SERIES M440i xDrive Coupe Mild-Hybrid	B58B30B	11/20 →	
5 VII 520 E PLUG-IN-HYBRID	B48B20A	03/21 →	
5 VII 520 i	B48B16A, B48B20A, B48B20B	07/17 →	
5 VII 520 i Mild-Hybrid	B48B20A	07/20 →	
5 VII 530 e Plug-in-Hybrid	B46B20B, B48B20A	03/17 →	
5 VII 530 e Plug-in-Hybrid xDrive	B46B20B, B48B20A	03/17 →	
5 VII 530 i	B46B20B, B48B20B	09/16 →	
5 VII 530 i Mild-Hybrid	B48B20B	07/20 →	
5 VII 530 i Mild-Hybrid xDrive	B48B20B	07/20 →	
5 VII 530 i xDrive	B46B20B, B48B20B	09/16 →	
5 VII 540 i	B58B30A	09/16 →	06/20
5 VII 540 i Mild-Hybrid	B58B30C	07/20 →	
5 VII 540 i Mild-Hybrid xDrive	B58B30C	07/20 →	
5 VII 540 i xDrive	B58B30A	09/16 →	
5 VII 545 e Plug-in-Hybrid xDrive	B58B30C	11/20 →	
6 IV GT 630 i	B48B20B	06/17 →	06/20
6 IV GT 630 i Mild-Hybrid	B48B20B	07/20 →	
6 IV GT 630 i xDrive	B58B30C	07/19 →	
6 IV GT 640 i	B58B30A, B58B30C	06/17 →	06/20
6 IV GT 640 i Mild-Hybrid	B58B30C	07/20 →	
6 IV GT 640 i Mild-Hybrid xDrive	B58B30C	07/20 →	
6 IV GT 640 i xDrive	B58B30A, B58B30C	06/17 →	06/20
8 840 i	B58B30C	07/19 →	
8 840 i xDrive	B58B30C	07/19 →	
X1 I sDrive 18 i	B38A15A	11/15 →	
X1 I sDrive 20 i	B48A20A, B48A20F	07/15 →	
X1 I sDrive 20 i	B48A20A, B48A20B, B48A20F	07/15 →	
X1 II xDrive 25 e Plug-in-Hybrid	B38A15A	03/20 →	
X1 II xDrive 25 i	B46A20B, B48A20B	07/15 →	
7 VI 730 i	B48B20B	11/15 →	
7 VI 730 i, Li	B48B20B	11/15 →	
7 VI 740 e, Le	B48B20B	07/16 →	02/19
7 VI 740 i, Li	B58B30A, B58B30C	07/15 →	
7 VI 740 Le xDrive	B48B20B	07/16 →	02/19
7 VI 740 Li xDrive	B58B30A, B58B30C	03/16 →	
7 VI 745 e, Le Plug-in-Hybrid	B58B30C	03/19 →	
7 VI 745 Le Plug-in-Hybrid xDrive	B58B30C	03/19 →	
X2 M35 i	B48A20E	11/18 →	
X2 sDrive 18 i	B32515A, B38A15A	03/18 →	
X2 sDrive 20 i	B42520A, B48A20A, B48A20F	11/17 →	
X2 xDrive 20 i	B48A20A	03/18 →	
X2 xDrive 25 e Plug-in-Hybrid	B38A15A	03/20 →	
X3 III M	S58B30A	03/19 →	
X3 III M Competition	S58B30A	03/19 →	
X3 III sDrive 20 i	B48B20A	12/17 →	
X3 III sDrive 20 i 1.6	B48B16A	12/17 →	
X3 III xDrive 20 i	B48B20A	12/17 →	
X3 III xDrive 20 i Mild Hybrid	B48B20B	08/21 →	
X3 III xDrive 30 e Plug-in-Hybrid	B46B20B, B48B20A	12/19 →	
X3 III xDrive 30 i	B46B20B, B48B20B	08/17 →	
X3 III xDrive 30 i Mild Hybrid	B48B20B	08/21 →	
X3 III xDrive M40 i	B58B30A, B58B30B	08/17 →	
X4 II M	S58B30A	03/19 →	
X4 II M Competition	S58B30A	03/19 →	
X4 II M40 i xDrive	B58B30A, B58B30B	04/18 →	
X4 II xDrive 20 i	B48B20A	04/18 →	
X4 II xDrive 20 i Mild Hybrid	B46B20B, B48B20A	08/21 →	
X4 II xDrive 30 i	B48B20B	04/18 →	
X4 II xDrive 30 i Mild Hybrid	B46B20B, B48B20B	07/21 →	
X5 IV xDrive 40 i	B58B30C	08/18 →	

BMW

X5 IV xDrive 40 i Mild-Hybrid	B58B30C	12/20 →	
X5 IV xDrive 45 e Plug-in-Hybrid	B58B30C	06/19 →	
X6 III xDrive 40 i	B58B30C	08/19 →	
X6 III xDrive 40 i Mild-Hybrid	B58B30C	12/20 →	
X7 xDrive 40 i	B58B30C	03/19 →	
X7 xDrive 40 i Mild-Hybrid	B58B30C	12/20 →	
MINI			
MINI III Cooper	B36A15A, B38A15A, B38A15F	09/13 →	
MINI III Cooper ALL4	B38A15A, B38A15F	10/16 →	
MINI III Cooper S	B46A20A, B48A20A, B48A20F	09/13 →	
MINI III Cooper S ALL4	B46A20A, B48A20A, B48A20F	04/15 →	
MINI III Cooper S JCW	B46A20A, B48A20A, B48A20F	09/13 →	
MINI III Cooper S JCW ALL4	B48A20A	11/14 →	
MINI III Cooper SE ALL4	B38A15A	01/17 →	
MINI III John Cooper Works	B46A20B, B48A20B, B48A20E	03/15 →	
MINI III John Cooper Works ALL4	B48A20B, B48A20E	03/17 →	
MINI III John Cooper Works GP	B48A20E	03/20 →	
MINI III One	B38A12A, B38A15A	04/14 →	
MINI III One First	B38A12A, B38A15A	06/14 →	
TOYOTA			
SUPRA 2.0	B48H, B48L	06/19 →	
SUPRA 3.0 GR	B58	03/19 →	

EPS 1.970.636

05,5

COILS

Adatt./Suitable:

AUDI

06H 905 110 D
06H 905 110 E
06H 905 110 F
06H 905 110 G
06H 905 110 H
06H 905 110 L
06K 905 110 K
06L 905 110 C
06L 905 110 D
06L 905 110 E
06L 905 110 F
06L 905 110 H
06L 905 110 K

BENTLEY

06H 905 110 G
06H 905 110 L

BOSCH

0 986 221 072

CUPRA

06H 905 110 L
06L 905 110 K

HITACHI

134052
2504052

MAGNETI MARELLI

060717182012
060717200012

PORSCHE

958 905 110 00
958 905 110 01
PAC 905 110
PAC 905 110 A

SEAT

06H 905 110 D
06H 905 110 E
06H 905 110 F
06H 905 110 G
06H 905 110 H
06H 905 110 L
06L 905 110 B
06L 905 110 C
06L 905 110 D
06L 905 110 E
06L 905 110 F
06L 905 110 H
06L 905 110 K

SKODA

06H 905 110 D
06H 905 110 E
06H 905 110 F
06H 905 110 G
06H 905 110 H
06H 905 110 L
06L 905 110 C
06L 905 110 D
06L 905 110 E
06L 905 110 F
06L 905 110 H
06L 905 110 K

VW

06H 905 110 D
06H 905 110 E
06H 905 110 F
06H 905 110 G
06H 905 110 H
06H 905 110 L
06K 905 110 K
06L 905 110 A
06L 905 110 B
06L 905 110 C
06L 905 110 D
06L 905 110 E
06L 905 110 F
06L 905 110 H
06L 905 110 K

NEW - ITEM NOW AVAILABLE FROM PRODUCTION

- NUOVO - ARTICOLO ORA DISPONIBILE PER LA VENDITA
- NOUVEAU - ARTICLE DISPONIBLE EN PRODUCTION COURANTE
- NEU - JETZ ZUM VERKAUF VERFÜGBARER ARTIKEL
- NUEVO - ARTICULO AHORA DISPONIBLE EN PRODUCCION

AUDI		
A3 III 2.0 TFSI	CZPB, DKZA	05/16 → 10/20
A3 III 2.0 TFSI quattro	CZPB, DKZA	05/16 → 10/20
A3 III 40 TFSI	CZPB, DKZA	07/18 → 10/20
A3 III 40 TFSI quattro	CZPB, DKZA	07/18 → 10/20
A3 III S3 quattro	CJXD, CJXG, DJHA, DJHB, DNUE	11/12 → 10/20
A3 IV S3 quattro	DNFB	06/20 →
A4 V 2.0 TFSI	CYMC, CYRB, CYRC	05/15 → 11/19
A4 V 2.0 TFSI Mild Hybrid	DDWA	05/17 → 11/19
A4 V 2.0 TFSI Mild Hybrid quattro	DDWA	05/17 →
A4 V 2.0 TFSI quattro	CYMC, CYRB, CYRC	05/15 →
A4 V 35 TFSI Mild Hybrid	DLVB, DMSB	12/18 →
A4 V 40 TFSI Mild Hybrid	DMSA	06/20 →
A4 V 40 TFSI Mild Hybrid quattro	DMSA	06/20 →
A4 V 45 TFSI Mild Hybrid	DKNA	07/18 → 11/19
A4 V 45 TFSI Mild Hybrid quattro	DKNA, DMTA	07/18 →
A4 V ALLROAD 2.0 TFSI Mild Hybrid quattro	DDWA	11/18 → 10/19
A4 V ALLROAD 2.0 TFSI quattro	CYMC, CYRB, CYRC	01/16 →
A4 V ALLROAD 45 TFSI Mild Hybrid quattro	DKNA, DMTA	07/18 →
A5 I 1.8 TFSI	CJEB, CJED, CJEE	10/07 → 01/17
A5 I 2.0 TFSI	CNCD	05/13 → 05/16
A5 I 2.0 TFSI quattro	CNCD	05/13 → 05/16
A4 IV ALLROAD 2.0 TFSI quattro	CNCD	05/13 → 05/16
A5 II 2.0 TFSI	CYRB	11/16 → 02/20
A5 II 2.0 TFSI Mild Hybrid	DDWA	05/17 → 02/20
A5 II 2.0 TFSI Mild Hybrid quattro	DDWA, DLHB	05/17 →
A5 II 2.0 TFSI quattro	CYMC, CYRB, CYRC	06/16 →
A5 II 35 TFSI Mild Hybrid	DLVB, DMSB	08/18 →
A5 II 40 TFSI Mild Hybrid	DMSA	05/20 →
A5 II 40 TFSI Mild Hybrid quattro	DMSA	06/20 →
A5 II 45 TFSI Mild Hybrid	DKNA	07/18 → 02/20
A5 II 45 TFSI Mild Hybrid quattro	DKNA, DMTA, DPAA	07/18 →
A6 IV 1.8 TFSI	CYGA	09/14 → 09/18
A6 IV 2.0 TFSI	CYNB, CYPA	09/14 → 09/18
A6 IV 2.0 TFSI quattro	CYNB, CYPA	05/14 → 09/18
A6 V 40 TFSI	DMTC	09/20 →
A6 V 45 TFSI Mild Hybrid	DKNA, DLHA, DMTA	08/18 →
A6 V 45 TFSI Mild Hybrid quattro	DKNA, DLHA, DMTA	08/18 →
A6 V 50 TFSI e quattro	DLGA, DRYA	11/19 →
A6 V 55 TFSI e quattro	DLGA, DRYA	11/19 →
A7 SPORTBACK 2.0 TFSI	CYPA	09/14 → 05/18
A7 2.0 50 TFSI e	DLGA	11/19 →
A7 45 TFSI Mild Hybrid	DKNA, DLHA	07/18 →
A7 45 TFSI Mild hybrid quattro	DKNA, DLHA	07/18 →
A7 55 TFSI e quattro	DLGA	07/19 →
Q7 II 2.0 TFSI	CVJA	08/15 →
Q7 II 2.0 TFSI quattro	CYRB	08/15 →
Q2 2.0 TFSI quattro	CZPB, DKZA	05/17 →
Q2 S02 TFSI quattro	DNFC, DNUE	08/18 →
Q5 1.2.0 TFSI quattro	CNCB, CNCD	08/09 → 05/17
Q5 II 2.0 TFSI quattro	DAXB, DAXC, DAYB	06/16 →
Q5 II 35 TDI	DTNA	10/21 →
Q5 II 45 TFSI Mild Hybrid quattro	DNTA, DPUA, DPVA	12/18 →
Q5 II 45 TFSI quattro	DPVA	11/20 →
Q5 II 50 TFSI e quattro	DLGA	04/19 →
Q5 II 55 TFSI e quattro	DLGA	08/19 → 11/20
Q8 45 TFSI	DMFA, DNEA	07/20 →
Q8 45 TFSI quattro	DMFA, DNEA	10/19 →
TT III 1.8 TFSI	CJSA, CJSB	07/15 → 08/18
TT III 2.0 TFSI quattro	CJXF, CJXG, CYFB, DNUF	11/14 →
TT III 40 TFSI	DKZB, DNNB	07/18 →

BENTLEY

BENTAYGA 3.0 Hybrid DCBE 08/18 →
BENTAYGA 4.0 DCUA 01/18 →

CUPRA

FORmentor 2.0 TSI DNPA 03/21 →
FORmentor 2.0 TSI 4Drive DNFB, DNNA 07/20 →
LEON 2.0 TSI DNFC 06/21 →
LEON 2.0 TSI 4Drive DNFB 06/21 →

PORSCHE

CAYENNE III 2.9 S AWD DCAB, MDC.AB 05/17 →
CAYENNE III 3.0 AWD DCBE, MDC.BE 05/17 →
CAYENNE III 3.0 E-Hybrid AWD DCBE, MDC.BE 05/17 →
CAYENNE III 4.0 Turbo AWD DCUA, MDC.UA 05/17 →
CAYENNE III 4.0 Turbo GT AWD DWNA 06/21 →

PORSCHE

CAYENNE III 4.0 Turbo S E-Hybrid AWD	DCUA	10/19 →
MACAN 2.0	DKNA, DLHB, MCN.CC, MCV.NA, MCV.PA	07/14 →
MACAN 2.9 Turbo AWD	DGRC	05/18 →
MACAN 3.0 S	DLZB	05/18 →
PANAMERA 2.9 4	MDG.PA	05/16 →
PANAMERA 2.9 4 E-Hybrid	DGPA, MDG.PA	05/16 →
PANAMERA 2.9 4S	MCS.ZA	05/16 →
PANAMERA 2.9 4S E-Hybrid	CSZA, DGPA	08/20 →
PANAMERA 3.0	MCX.TA	05/16 →
PANAMERA 3.0 4	MCX.TA	05/16 →
PANAMERA 4.0 GTS	CVDD	01/18 →
PANAMERA 4.0 Turbo	MCV.DA	05/16 →
PANAMERA 4.0 Turbo S E-Hybrid	CVDA, MCV.DA	05/17 →

SEAT

LEON III 1.8 TFSI	CJSA	02/13 →
LEON III 1.8 TSI	CJSA	02/13 →
LEON III 1.8 TSI 4Drive	CJSA, CJSB	11/14 →
LEON III 2.0 TSI	DKZA	09/18 →
LEON III 2.0 TSI 4Drive	DKZA	09/18 →
LEON IV 2.0 TFSI	DNNA	03/21 →
TARRACO 2.0 TFSI 4Drive	DNPA	01/21 →
TARRACO 2.0 TSI 4Drive	DKZA	11/18 →

SKODA

KAROQ 2.0 TSI 4x4	DKZA, DNNA	04/19 →
KODIAQ 2.0 TSI 4x4	CZPA, DKZA, DNNA	10/16 →
OCTAVIA III 1.8 TSI	CJSA, CJSB	11/12 →
OCTAVIA III 1.8 TSI 4x4	CJSA, CJSB	11/12 →
OCTAVIA III 2.0 TSI	DKZA	02/17 →
OCTAVIA III 2.0 TSI 4x4	DKZA	02/19 →
SUPERB III 1.8 TSI	CJSA, CJSC	03/15 →

VW

ARTEON 2.0 TSI	CZPB, DKZA, DNNA	05/17 →
ARTEON 2.0 TSI 4motion	DJHC, DLRB	06/20 →
BEEETLE 2.0 TSI	CPLA, CPPA, CULC	12/12 → 07/19
POLO VI 2.0 GTI	CZPC, DKZC	11/17 →
GOLF VII 1.8 TSI 4motion	CJSB	12/14 →
GOLF VII 2.0 GTI	CXCA, CXDA	04/13 →
GOLF VII 2.0 GTI TCR	CJXH, DNUC	11/18 →
GOLF VII 2.0 R 4motion	CJXC, CJXD, CJXG, DJHA, DJHB, DNUC, DNUE	11/13 →
PASSAT VI 1.8 TSI	CJSA, CJSC	02/15 →
PASSAT VI 2.0 TSI	CXDA, CZPB, DKZA, DRFA	08/14 →
GOLF VIII 2.0 GTI	DNPA	09/20 →
GOLF VIII 2.0 GTI Clubsport	DNFC	10/20 →
GOLF VIII 2.0 TSI R 4motion	DNFG, DSFE, DSFF	09/20 →
JETTA VI 1.8 TSI	CPKA, CPRA	07/14 →
JETTA VI 2.0 TSI	CPLA, CPPA	12/12 → 12/17
MULTIVAN 2.0 TSI	DRNB	10/21 →
POLO V 1.8 GTI	DAJA, DAJB	11/14 →
PASSAT V 1.8 TSI	CPKA, CPRA	06/13 →
T-ROC 2.0 R 4motion	DNFC, DNUE	09/19 →
T-ROC 2.0 TSI 4motion	CZPB, DKZA, DNNA	07/17 →
TIGUAN II 2.0 TSI	DGUA, DTEA	04/17 →
TIGUAN II 2.0 TSI 4motion	CXDA, CZPA, DGUA, DGVA, DKZA, DNJA, DNLA, DNNA, DNPA, DTEA	01/16 →
TIGUAN II 2.0 TSI R 4motion	DNFG	11/20 →
TOUAREG II 2.0 TFSI 4motion	CYRC	05/18 →
TOURAN II 1.8 TSI	CJSA	11/15 →

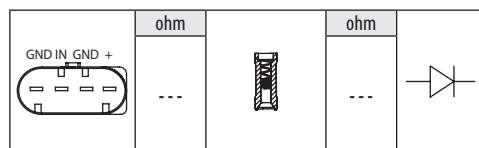

AUDI

A1 1.8 TFSI	DAJB	02/15 → 10/18
A1 40 TFSI	CZPC, DKZC, DNND	09/18 →
A4 IV 1.8 TFSI	CJEB	11/11 → 12/15
A4 IV 1.8 TFSI quattro	CJEB	11/11 → 12/15
A4 IV 2.0 TFSI	CNCD	05/13 → 12/15
A4 IV 2.0 TFSI quattro	CNCD	05/13 → 12/15
A3 III 1.8 TFSI	CJSA, CJSB, CNSB	04/12 →
A3 III 1.8 TFSI quattro	CJSB	08/12 →

1.970.638

COILS

EPS **1.970.638**  **05,5**

COILS

Adatt./Suitable:

HYUNDAI
27301-04110
KIA
27301-04110

NEW - ITEM NOW AVAILABLE FROM PRODUCTION

- NUOVO - ARTICOLO ORA DISPONIBILE PER LA VENDITA
- NOUVEAU - ARTICLE DISPONIBLE EN PRODUCTION COURANTE
- NEU - JETZT ZUM VERKAUF VERFÜGBARER ARTIKEL
- NUEVO - ARTICULO AHORA DISPONIBLE EN PRODUCCION

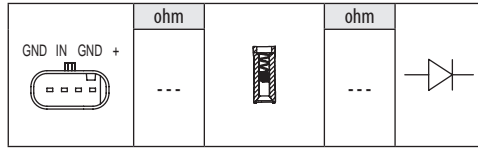

HYUNDAI

I20 II 1.0 T-GDi	G3LC	09/15 →
I30 III 1.0 T-GDi	G3LC	11/16 →
KONA 1.0 T-GDi	G3LC	07/17 →

KIA

CEED II 1.0 T-GDi	G3LC	04/15 → 07/18
CEED III 1.0 T-GDi	G3LC	03/18 →
CEED III T-GDi	G3LC	03/18 →
PICANTO III 1.0	G3LA, G3LD	03/17 →
PICANTO III 1.0 LPG	G3LA	11/18 →
PICANTO III 1.0 T-GDi	G3LC	03/17 →
PROCEED 1.0 T-GDi	G3LC	10/18 →
PRO CEE'D II 1.0 T-GDi	G3LC	07/15 → 07/18
RIO IV 1.0 T-GDi 100	G3LC, G3LE	01/17 →
RIO IV 1.0 T-GDi 100 Eco-Dynamics+	G3LF	02/17 →
RIO IV 1.0 T-GDi 120	G3LC	01/17 →
STONIC 1.0 T-GDi	G3LC	07/17 →
XCEED 1.0 T-GDi	G3LC	06/19 →

EPS **1.970.645**  **05,5**

COILS

Adatt./Suitable:

TOYOTA
90919-02271

NEW - ITEM NOW AVAILABLE FROM PRODUCTION

- NUOVO - ARTICOLO ORA DISPONIBILE PER LA VENDITA
- NOUVEAU - ARTICLE DISPONIBLE EN PRODUCTION COURANTE
- NEU - JETZT ZUM VERKAUF VERFÜGBARER ARTIKEL
- NUEVO - ARTICULO AHORA DISPONIBLE EN PRODUCCION

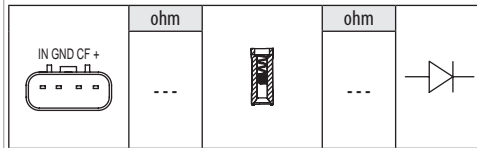

TOYOTA

AURIS II 1.2	8NR-FTS	03/15 → 12/18
C-HR 1.2	8NR-FTS	10/16 →
C-HR 1.2 4WD	8NR-FTS	10/16 →
COROLLA 1.2	8NR-FTS	01/19 →

EPS **1.970.647**  **05,5**

COILS

Adatt./Suitable:

HYUNDAI
27301-03HA0
KIA
27301-03HA0

NEW - ITEM NOW AVAILABLE FROM PRODUCTION

- NUOVO - ARTICOLO ORA DISPONIBILE PER LA VENDITA
- NOUVEAU - ARTICLE DISPONIBLE EN PRODUCTION COURANTE
- NEU - JETZT ZUM VERKAUF VERFÜGBARER ARTIKEL
- NUEVO - ARTICULO AHORA DISPONIBLE EN PRODUCCION

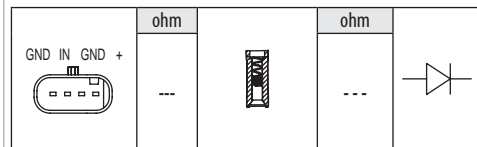
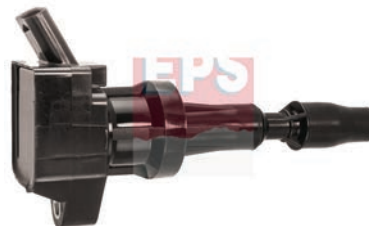

HYUNDAI

IONIQ 1.6 GDi Hybrid	G4LE	03/16 →
IONIQ 1.6 GDi Plug-in Hybrid	G4LE	03/16 →
KONA 1.6 GDi Hybrid	G4LE	06/19 →

KIA

CEED III 1.6 GDi Hybrid	G4LE	12/19 →
CEED III GDi Hybrid	G4LE	12/19 →
NIRO 1.6 GDi Hybrid	G4LE	09/16 →
NIRO GDi Hybrid	G4LE	09/16 →
XCEED 1.6 GDi Hybrid	G4LE	12/19 →

EPS **1.990.303**  **07,5**

COILS

Adatt./Suitable:

FIAT
7588436
7746226
LANCIA
7588436

03 Supplied until depletion

- Fornibile fino ad esaurimento delle scorte
- Fourni jusqu'à épuisement du stock
- Lieferbar solange vorrat reicht
- Suministrado hasta el stock termina

MAGNETI MARELLI

064825072010
581700540000
581700540010
648 250 72
AEI 600 C
AEI 600 F

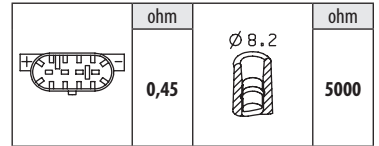
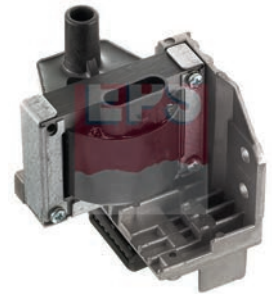

FIAT

COUPE 2.0 16V	836A3.000	11/93 → 08/96
COUPE 2.0 16V [BRA]	836A3.011	11/93 → 08/96
CROMA I 2000 i.e.	154C3.000, 834B.000	03/87 → 09/92
CROMA I 2000 i.e. Turbo	154C4.000, 154C4.046, 834C.146	11/86 → 08/96
TEMPRA 1.8 4x4	159A4.000	07/92 → 06/93
TEMPRA 1.8 i.e.	159A4.000, 159A4.046	03/90 → 08/96
TEMPRA 2.0	159A6.046	04/90 → 06/93
TEMPRA 2.0 i.e.	159A6.046	10/90 → 09/96
TEMPRA 2.0 i.e. [BRA]	159A6.011	04/93 → 12/96
TEMPRA 2.0 i.e. 4x4	159A6.046	03/92 → 03/95
TIPO I 1.8 i.e.	159A4.000, 159A4.046	10/90 → 06/93
TIPO I 1.8 i.e. 16V Sport	160A5.000	11/89 → 06/92
TIPO I 2.0	159A5.046, 159A6.046, 836A3.011	10/90 → 04/95
TIPO I 2.0 16V	160A8.046	07/91 → 04/95
TIPO I 2.0 i.e.	159A5.046, 159A6.046	03/90 → 04/95
TIPO I 2.0 i.e. [BRA]	159A6.011	03/93 → 10/95
TIPO I 2.0 i.e. 16V Sport	836A3.000	03/93 → 04/95
UNO 1.3 Turbo i.e.	146A2.000, 146A2.246	04/85 → 03/91
UNO 1.4 Turbo i.e.	146A8.000, 146A8.046	09/89 → 12/96

FIAT (BR)

COUPE 2.0i 16V	2.0Mpi	01/95 → 12/97
TIPO 2.0i 16V	2.0Mpi	01/94 → 12/95
TIPO 2.0i 8v	2.0Mpi	01/94 → 12/95
UNO 1.4i Turbo	1.4Mpi	01/94 → 12/96

LANCIA

DEDRA 1.6	835A1000	07/94 → 02/97
DEDRA 1.6 i.e.	835A1.000	08/89 → 06/94
DEDRA 1.8 i.e.	835A2.000, 835A2.046, 835C5.000	09/89 → 07/99
DEDRA 2.0 16V	836A3.000	07/94 → 07/99
DEDRA 2.0 HF Integrale	835A7.046	11/90 → 07/94
DEDRA 2.0 i.e.	835A5.000, 835A5.046	09/89 → 07/99
DEDRA 2.0 i.e. Turbo	835A8.046	04/91 → 07/99
DEDRA 2.0 i.e. Turbo Integrale	835A7.000	04/90 → 08/91
DEDRA 2.0 Integrale	836A3.000	07/94 → 07/99
DEDRA 2.0 Turbo	835A8.000	11/90 → 06/94
DELTA I 2.0 16V HF Integrale	831D5.000	03/89 → 09/91
DELTA I 2.0 HF Integrale	831C5.046	12/86 → 12/92
DELTA II 2.0 16V	836A3.000	06/93 → 08/99
THEMA 8.32	F105L, F105L.046	09/87 → 05/92

EPS 1.990.414



07

COILS

Adatt./Suitable:

AUDI

6N0 905 104
867 905 352

BOSCH

0 986 221 000
1 227 022 030
1 227 030 030

DENSO

DIC-0200

HITACHI

138419
138701
2508419

MAGNETI MARELLI

060717004012
060717005012
060717007012
060717008012

SEAT

6N0 905 104
867 905 352

SKODA

004 050 014
004 050 016
6N0 905 104

TELEFUNKEN

311 354
339 700

VW

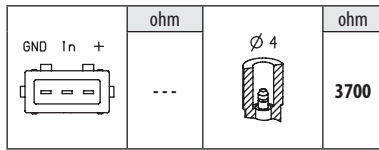
6N0 905 104
867 905 352

AUDI			
80 IV 2.0 E	ABK	09/91 ⇨	01/96
80 IV 2.0 E quattro	ABK	09/91 ⇨	12/94
CABRIOLET 2.0 E	ABK	01/93 ⇨	07/98
COUPE 2.0	ABK	05/89 ⇨	12/96

SEAT			
ALHAMBRA I / II 2.0	ADY	03/96 ⇨	03/10
ALHAMBRA I / II 2.0 i	ADY	04/96 ⇨	03/10
AROSA 1.0	AER, ALL	05/97 ⇨	06/04
AROSA 1.4	AEX, AKV, APQ	05/97 ⇨	06/04
CORDOBA I 1.0 16V	AST, AVZ	05/00 ⇨	10/02
CORDOBA I 1.0 CL	AAU	02/93 ⇨	06/96
CORDOBA I 1.0 i	AER	09/96 ⇨	10/02
CORDOBA I 1.3	AAV	02/93 ⇨	08/94
CORDOBA I 1.4	ANX	12/97 ⇨	04/99
CORDOBA I 1.4 i	ABD, AEX, AKV, APQ	06/94 ⇨	12/02
CORDOBA I 1.4 i 16V	AFH	09/96 ⇨	10/02
CORDOBA I 1.6 i	1F, ABU, AEE, AFT, ALM	02/93 ⇨	06/99
CORDOBA I 1.8 i	ABS, ACC, ADZ	02/93 ⇨	09/02
CORDOBA I 1.8 i 16V	148D	10/93 ⇨	08/96
CORDOBA I 2.0 i	2E, AGG	02/93 ⇨	06/99
CORDOBA I 2.0 i 16V	ABF	08/96 ⇨	06/99
IBIZA II 1.0	AAU	03/93 ⇨	09/96
IBIZA II 1.0 16V	AST, AVZ	10/99 ⇨	02/02
IBIZA II 1.0 i	AER	09/96 ⇨	02/02
IBIZA II 1.3 i	AAV	03/93 ⇨	08/99
IBIZA II 1.4 i	ABD, AEX	09/93 ⇨	02/02
IBIZA II 1.4 i 16V	AFH	06/97 ⇨	02/02
IBIZA II 1.6 i	1F, ABU, AEE, AFT, ALM	03/93 ⇨	06/99
IBIZA II 1.8 i	ABS, ACC, ADZ	03/93 ⇨	08/99
IBIZA II 1.8 i 16V	148D	11/93 ⇨	08/96
IBIZA II 2.0 i	2E, AGG	03/93 ⇨	08/99
IBIZA II 2.0 i 16V	ABF	08/96 ⇨	08/99
INCA 1.4 i	AEX, AKV, APQ	11/95 ⇨	06/03
INCA 1.6 i	1F, AEE	11/95 ⇨	05/98
TOLEDO I 1.6 i	1F, ABN, AFT, EZ	05/91 ⇨	03/99
TOLEDO I 1.8 i	ABS, ADZ	11/93 ⇨	12/96

SEAT			
TOLEDO I 2.0 i	2E, AGG	05/91 ⇨	03/99
TOLEDO I 2.0 i 16V	ABF	11/93 ⇨	03/99
SKODA			
FAVORIT 1.3	135B, 136B, 781.135E	09/91 ⇨	06/97
FAVORIT 1.3 135 X, LX, GLX	781.135E	01/90 ⇨	09/94
FELICIA 1.3	061GW4G15K, 135, 135I, 136I, 136B	10/94 ⇨	04/02
FELICIA 1.3 LXI	136I	08/95 ⇨	03/98
FELICIA 1.6	AEE	06/97 ⇨	04/02
FELICIA 1.6 GLX	AEE	08/95 ⇨	03/98
FELICIA 1.6 LX	AEE	08/95 ⇨	03/98
OCTAVIA I 1.6	AEE	09/96 ⇨	09/04
VOLKSWAGEN (BR)			
CADDY 1.6i	MY4	11/98 ⇨	
POLO 1.6	MJ3, MY4	07/00 ⇨	
POLO 1.8	MJ2, MYS, MY6	12/96 ⇨	

VW			
POLO II 1.0	AAU, HZ	01/85 ⇨	09/94
POLO II 1.0 Cat	AAU, ACM	08/89 ⇨	09/94
POLO II 1.3	3F	10/90 ⇨	09/94
POLO II 1.3 Cat	2G, 3F, AAV, MH, NZ	07/87 ⇨	09/94
POLO II 1.3 G40	PY	08/90 ⇨	09/94
CADDY II 1.4	AEX, APQ	11/95 ⇨	06/03
CADDY II 1.6	1F, AEE	11/95 ⇨	12/00
CADDY II 60 1.4	AEX, APQ	11/95 ⇨	01/04
CADDY II 75 1.6	1F, AEE	11/95 ⇨	05/97
CADDY III 1.6 [ARG]	UVC	10/05 ⇨	
CORRADO 2.0 i	2E, ADY	04/93 ⇨	12/95
PASSAT III 1.6	1F, ABN, AEK, AFT, EZ	04/88 ⇨	08/96
PASSAT III 1.8	AAM, ABS, ADZ, RP	02/88 ⇨	05/97
PASSAT III 2.0	2E, ADY, AEP, AGG	02/90 ⇨	05/97
PASSAT III 2.0 16V	ABF	01/94 ⇨	05/97
PASSAT III 2.0 Syncro	2E, ADY, AGG	03/90 ⇨	12/96
PASSAT III 2.0i	ACX	08/92 ⇨	12/96
GOLF III 1.4	ABD, AEX	10/91 ⇨	04/99
GOLF III 1.6	ABU, AEA, AEE, AEK, AFT, AKS	09/92 ⇨	04/99
GOLF III 1.8	AAM, ABS, ACC, ADZ	08/91 ⇨	04/99
GOLF III 1.8 Syncro	ABS, ADZ	01/93 ⇨	04/99
GOLF III 2.0	2E, ADY, AEP, AGG, AKR	11/91 ⇨	04/99
GOLF III 2.0 GL	AEP	08/95 ⇨	09/97
GOLF III 2.0 GTI 16V	ABF	08/92 ⇨	08/97
GOLF III 2.0 Syncro	AGG	08/95 ⇨	04/99
GOLF IV 1.6	AFT, AKS	06/98 ⇨	06/02
GOLF IV 1.8	AAM, ADZ, ANN, ANP	06/98 ⇨	06/02
GOLF IV 2.0	AGG, AKR, ATU, AWF, AWG	06/98 ⇨	06/02
LUPO 1.0	AER, ALL	09/98 ⇨	07/05
POLO III 1.0	AER, AEV, ALD, ALL, AUC	10/94 ⇨	05/02
POLO III 1.4	AEX, AKV, ANX, APQ	05/97 ⇨	09/01
POLO III 1.4 16V	AFH	10/99 ⇨	09/01
POLO III 1.6	AEA, AEE, AFT, ALM	09/94 ⇨	09/01
POLO III 100 1.4 16V	AFH	04/96 ⇨	10/99
POLO III 100 1.6	AFT	12/95 ⇨	09/01
POLO III 2.0	ADC	08/99 ⇨	09/01
POLO III 45 1.0	AEV	10/94 ⇨	09/96
POLO III 50 1.0	AER, ALD, ALL, AUC	09/96 ⇨	10/99
POLO III 54 1.4	ANX	01/98 ⇨	08/99
POLO III 55 1.3	ADX	10/94 ⇨	04/97
POLO III 55 1.4	AEX, ANX	08/95 ⇨	10/99
POLO III 60 1.4	AEX, AKV, APQ	07/95 ⇨	09/01
POLO III 75 1.6	1F, AEA, AEE, AHS, ALM	10/94 ⇨	10/99
POLO III 90 1.8	ADD	01/97 ⇨	09/01
POLO IV 1.0	AER	08/96 ⇨	12/01
SHARAN 2.0	ADY	09/95 ⇨	03/10
TRANSPORTER IV 2.0	AAC	07/90 ⇨	04/03
TRANSPORTER IV 2.5	AAF, ACU, AET, AEU, APL, AVT	09/90 ⇨	06/03
TRANSPORTER IV 2.5 Syncro	AAF, ACU, AET, AEU, APL, AVT	08/92 ⇨	04/03
VENTO 1.4	ABD, AEX, APQ	11/91 ⇨	09/98
VENTO 1.6	ABU, AEA, AEE, AEK, AFT, AKS	09/92 ⇨	02/99
VENTO 1.8	AAM, ABS, ADZ, ANP	11/91 ⇨	02/99
VENTO 2.0	2E, ADY, AGG, AKR	11/91 ⇨	09/98
VENTO 2.0 GL	AEP	05/96 ⇨	12/97

EPS 1.990.416



07

COILS

Adatt./Suitable:

BOSCH

0 986 221 002

SEAT

701 905 104 A

TELEFUNKEN

310 481

VW

701 905 104 A

⁰⁰ Eliminated on 23-02-2022. Please verify the availability through our local distributors

- Eliminato il 23-02-2022. Verificare la disponibilità presso i nostri distributori
- Éliminé le 23-02-2022. Vérifier la disponibilité auprès de nos distributeurs sur place
- Am 23-02-2022 gestrichen. Evtl. Verfügbarkeit bitte bei unseren Händlern prüfen
- Eliminado en fecha 23-02-2022. Verificar la disponibilidad a través de nuestros distribuidores locales

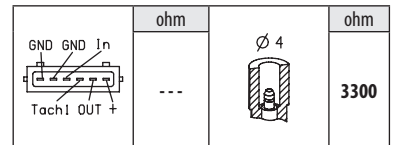

SEAT			
CORDOBA I 1.3	8C20HD0D	02/93 ⇨	08/94
IBIZA II 1.3 i	8C20HD0D	03/93 ⇨	08/99
TOLEDO I 1.8 i	ADZ	11/93 ⇨	12/96
TOLEDO I 2.0 i	AGG	05/91 ⇨	03/99
VW			
POLO II 1.0	HZ	01/85 ⇨	09/94
POLO II 1.0 Cat	ACM	08/89 ⇨	09/94
POLO II 1.3 Cat	2G, MH, NZ	07/87 ⇨	09/94
PASSAT III 1.6	1F, ABN, EZ	04/88 ⇨	07/92
PASSAT III 1.8	AAM, RP	02/88 ⇨	05/97
TRANSPORTER IV 1.8	5K7M710	12/90 ⇨	07/92

EPS 1.990.420



07

COILS

Adatt./Suitable:

AUDI

032 905 106
032 905 106 B
032 905 106 D
032 905 106 E
032 905 106 F

BOSCH

0 221 603 010
0 986 221 048
F 000 Z50 210

HITACHI

138425
138704
2508425
2508704

MAGNETI MARELLI

060717041012
060717042012

SEAT

032 905 106
032 905 106 B
032 905 106 D
032 905 106 E
032 905 106 F

SKODA

032 905 106
032 905 106 B
032 905 106 D
032 905 106 E
032 905 106 F

TELEFUNKEN

311 740

VW

032 905 106
032 905 106 B
032 905 106 D
032 905 106 E
032 905 106 F
06B 905 106 A

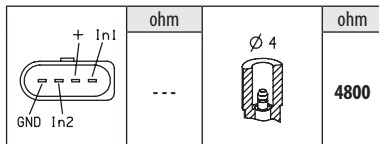

AUDI

A1 1.2 TFSI	CBZA	05/10 ⇒ 04/15
A2 1.4	AUA	02/00 ⇒ 08/05
A3 1.6	AEH, AKL, APF, AVU, BFQ	08/00 ⇒ 05/03
A3 1.8	AGN, APG	09/96 ⇒ 05/03
A3 II 1.2 TFSI	CBZB	03/10 ⇒ 05/13
A3 II 1.2 TSI	CBZB	04/10 ⇒ 03/13
A3 II 1.6	BGU, BSE, BSF, CCSA	05/03 ⇒ 03/13
A3 II 1.6 E-Power	CCSA, CMXA	01/11 ⇒ 03/13
A4 II 1.6	ALZ	11/00 ⇒ 12/04
A4 I 1.6	AHL, ALZ, ANA, ARM	07/00 ⇒ 09/01
A4 III 1.6	ALZ	11/04 ⇒ 06/08

SEAT

ALHAMBRA I / II 2.0	ATM	03/96 ⇒ 03/10
ALHAMBRA I / II 2.0 i	ATM	04/96 ⇒ 03/10
ALTEA 1.2 TSI	CBZB	04/10 ⇒
ALTEA 1.6	BGU, BSE, BSF, CCSA	03/04 ⇒
ALTEA 1.6 LPG	CHGA	09/09 ⇒
ALTEA 1.6 Multifuel	CMXA	11/10 ⇒ 05/11
ALTEA XL 1.2 TSI	CBZB	04/10 ⇒
ALTEA XL 1.6	BGU, BSE, BSF, CCSA	10/06 ⇒
ALTEA XL 1.6 LPG	CHGA	09/09 ⇒
ALTEA XL 1.6 Multifuel	BSE, BSF, CCSA, CMXA	10/06 ⇒ 11/10
AROSA 1.0	ALD, ANV, AUC	05/97 ⇒ 06/04
AROSA 1.4	AKK, ANW, AUD	05/97 ⇒ 06/04
AROSA 1.4 16V	AFK, AQQ, AUB	01/00 ⇒ 06/04
CORDOBA I 1.4 16V	2CJXE, AUA	06/99 ⇒ 12/02
CORDOBA I 1.6 i	AKL	07/96 ⇒ 10/02
EXEO 1.6	ALZ	03/09 ⇒ 09/10
EXEO 1.8 T	CFMA	12/08 ⇒ 05/10
IBIZA II 1.0 i	AUC	09/96 ⇒ 02/02

SEAT

IBIZA II 1.4 16V	2CJXE, AUA	05/00 ⇒ 02/02
IBIZA II 1.4 i	AUD	09/93 ⇒ 02/02
IBIZA II 1.4 i 16V	AQQ	06/97 ⇒ 02/02
IBIZA II 1.6 i	AKL	04/96 ⇒ 02/02
IBIZA III 1.4 16V	AUB	02/02 ⇒ 11/09
IBIZA III 1.6	BAH	02/03 ⇒ 11/09
IBIZA III 2.0	AZL, BBX	04/02 ⇒ 11/09
CORDOBA II 1.6	BAH	04/03 ⇒ 11/09
CORDOBA II 2.0	AZL, BBX	09/02 ⇒ 11/09
IBIZA IV 1.2 TSI	CBZA, CBZB	09/10 ⇒ 05/15
IBIZA IV 2.0	CEKA	10/08 ⇒ 05/15
INCA 1.4 16V	AUA	04/00 ⇒ 06/03
INCA 1.4 i	AUD	11/95 ⇒ 06/03
LEON I 1.4 16V	2CJXE, AHW, AXP	11/99 ⇒ 06/06
LEON I 1.6	AEH, AKL, BFQ	10/05 ⇒ 06/06
LEON I 1.6 16V	AUS	09/00 ⇒ 06/06
LEON I 1.8 20V	AGN, APG	11/99 ⇒ 06/06
LEON II 1.2 TSI	CBZB	02/10 ⇒ 12/12
LEON II 1.6	BSE, BSF, CCSA	07/05 ⇒ 12/12
LEON II 1.6 LPG	CHGA	12/09 ⇒ 12/12
LEON II 1.6 MultiFuel	BSE, CCSA, CMXA	07/05 ⇒ 08/13
TOLEDO II 1.4 16V	2CJXE, AHW, AXP	01/00 ⇒ 05/02
TOLEDO II 1.6	AEH, AKL, APF	10/98 ⇒ 07/04
TOLEDO II 1.6 16V	AUS	06/00 ⇒ 05/06
TOLEDO II 1.8 20V	AGN, APG	10/98 ⇒ 07/04
TOLEDO III 1.6	BGU, BSE, BSF, CCSA	10/04 ⇒ 05/09
TOLEDO IV 1.2 TSI	CBZA, CBZB	07/12 ⇒ 06/15

SKODA

FABIA I 1.4 16V	AUA, AUB, BBY, BBZ	10/99 ⇒ 03/08
FABIA I 2.0	AZL	12/99 ⇒ 03/08
SUPERB I 2.0	AZM	12/01 ⇒ 03/08
OCTAVIA I 1.4 16V	AXP	08/00 ⇒ 12/10
OCTAVIA I 1.6	AEH, AKL, AVU, BFQ	09/00 ⇒ 12/10
OCTAVIA I 1.8	AGN	09/96 ⇒ 07/00
OCTAVIA I 1.8 20V	AGN	07/98 ⇒ 07/00
OCTAVIA I 2.0	AEG, APK, AQY	04/99 ⇒ 05/07
OCTAVIA I 2.0 4x4	AZH	08/00 ⇒ 09/04
OCTAVIA II 1.2 TSI	CBZB	02/10 ⇒ 06/13
OCTAVIA II 1.6	BGU, BSE, BSF, CCSA, CMXA	06/04 ⇒ 06/13
OCTAVIA II 1.6 LPG	BSE, CHGA	08/09 ⇒ 11/12
OCTAVIA II 1.6 MultiFuel	CCSA	01/08 ⇒ 06/13
OCTAVIA II 2.0 [CHN]	BXX., CGZA.	04/07 ⇒
RAPID 1.2 LPG	CBZA	07/12 ⇒ 05/15
RAPID 1.2 TSI	CBZA, CBZB	07/12 ⇒ 05/15
ROOMSTER 1.2 TSI	CBZA, CBZB	03/10 ⇒ 05/15
FABIA II 1.2 TSI	CBZA, CBZB	03/10 ⇒ 12/14
YETI 1.2 TSI	CBZB	09/09 ⇒ 05/15

VOLKSWAGEN (BR)

GOL 1.0i 16v Turbo	512	06/00 ⇒
GOLF A4 1.6i	AKL	10/99 ⇒
GOLF A4 2.0i	APK	08/99 ⇒
PARATI 1.0i 16v Turbo	512	06/00 ⇒
POLO 1.6	BAH, BPA, CCRA	02/02 ⇒
POLO 2.0	BBX	05/02 ⇒

VW

PASSAT IV 1.6	AHL, ALZ, ANA, ARM	10/96 ⇒ 05/05
PASSAT IV 2.0	AZM, BFF	11/00 ⇒ 05/05
PASSAT IV 2.0 [CHN]	BFF, BNL	06/03 ⇒
PASSAT IV 2.0 4motion	AZM	11/00 ⇒ 05/05
GOLF VI 1.2 TSI	CBZA, CBZB	11/08 ⇒
GOLF VI 1.2 TSI BlueMotion	CBZB	05/09 ⇒ 11/12
GOLF VI 1.6	BSE, BSF, CCSA, CMXA	10/08 ⇒
GOLF VI 1.6 BiFuel	BSF	03/09 ⇒
GOLF VI 1.6 MultiFuel	CCSA, CHGA, CMXA	10/08 ⇒
BEETLE 1.2 TSI	CBZB	07/11 ⇒ 07/19
BORA 1.4 16V	AHW, AKQ, APE, AXP	03/00 ⇒ 05/05
BORA 1.6	AEH, AKL, APF, AVU, BFQ	08/00 ⇒ 05/05
BORA 1.6 16V	ATN, AUS	02/00 ⇒ 05/05
BORA 1.8 4motion	AGN	02/99 ⇒ 05/05
BORA 2.0	APK, AQY, AZH	10/98 ⇒ 12/13
BORA 2.0 4motion	AZH	04/00 ⇒ 05/05
CADDY II 1.4	AUA	11/95 ⇒ 01/04
CADDY II 1.4 16V	AUA	08/00 ⇒ 01/04
CADDY II 60 1.4	AUD	11/95 ⇒ 01/04
GOLF V 1.2 TSI	CBZA, CBZB	11/09 ⇒ 12/13
GOLF V 1.6	BGU, BSE, BSF, CCSA, CHGA, CMXA	01/04 ⇒
GOLF V 1.6 BiFuel	CHGA	05/09 ⇒ 12/13
GOLF V 1.6 MultiFuel	CCSA, CMXA	10/07 ⇒ 12/13
GOLF V 2.0	BHY	01/05 ⇒ 11/08
CADDY III 1.2 TSI	CBZA, CBZB	09/10 ⇒ 05/15
CADDY III 1.6	BGU, BRY, BSE, BSF	04/04 ⇒ 05/15
CADDY III 1.6 BiFuel	CHGA	05/11 ⇒ 05/15
FOX 1.0	--, AQZ, BNX, CCNA	10/03 ⇒
FOX 1.0 Alcohol	BJE, BNX	10/03 ⇒
FOX 1.0 Total Flex	CCNA	03/08 ⇒
FOX 1.4	BKR	04/05 ⇒ 12/09

VW

FOX 1.6	BAH, BLH, BPA, CCRA, CFZA	10/03 ⇒ 08/14
FOX 1.6 Alcohol	--	10/03 ⇒
FOX 1.6 Total Flex	BJA, BPA, CCRA	10/03 ⇒ 08/14
JETTA V 1.6	BSE, BSF, CCSA	09/04 ⇒ 10/10
JETTA V 1.6 [CHN]	BJG	01/05 ⇒
JETTA V 1.6 MultiFuel	CCSA	01/08 ⇒ 10/10
PASSAT V 1.6	BSE, BSF	05/05 ⇒ 11/10
GOLF IV 1.4	AXP	05/00 ⇒ 06/06
GOLF IV 1.4 16V	AHW, AKQ, APE, AXP	10/97 ⇒ 06/06
GOLF IV 1.6	AEH, AKL, APF, AUS, AVU, BFQ	05/00 ⇒ 06/06
GOLF IV 1.6 16V	ATN, AUS	02/00 ⇒ 06/06
GOLF IV 1.8	AGN	08/97 ⇒ 06/05
GOLF IV 1.8 4motion	AGN	05/98 ⇒ 06/06
GOLF IV 2.0	APK, AQY	07/98 ⇒ 06/06
GOLF IV 2.0 4motion	AZH	10/00 ⇒ 06/06
GOLF PLUS 1.2 TSI	CBZB	11/09 ⇒ 08/14
JETTA VI 1.2 TSI	CBZB	10/10 ⇒ 12/17
JETTA VI 2.0	CBPA	06/10 ⇒ 12/17
POLO IV 1.4	BLM	08/02 ⇒ 08/10
POLO IV 1.4 16V	AUA	10/01 ⇒ 05/08
POLO IV 1.6	BAH, BPA	08/02 ⇒
POLO IV 1.6 Flex	BPA	12/04 ⇒ 10/14
POLO IV 1.6 Total Flex	BPA	10/04 ⇒ 06/06
POLO IV 2.0	BBX	09/02 ⇒
LUPU 1.0	ALD, ANV, AUC	09/98 ⇒ 07/05
LUPU 1.4	AUD	10/00 ⇒ 07/05
LUPU 1.4 16V	AFK, AHW, AKQ, ANM, APE, AQQ, AUA, AUB	09/98 ⇒ 07/05
LUPU 1.6 GTI	AVY	09/00 ⇒ 07/05
POLO III 1.0	ALD, AUC	05/99 ⇒ 05/02
POLO III 1.4	AKK, AKP, ANW, AUA, AUD	05/97 ⇒ 09/01
POLO III 1.4 16V	AFK, AHW, APE, AUA, AUB	10/99 ⇒ 09/01
POLO III 1.6	AEH, AKL, APF, AUR	05/96 ⇒ 09/01
POLO III 1.6 16V GTI	ARC, AVY	10/99 ⇒ 09/01
POLO III 100 1.4 16V	AFK, AUB	04/96 ⇒ 10/99
POLO III 100 1.6	AEH, AKL, APF, AUR	12/95 ⇒ 09/01
POLO III 120 1.6 16V GTI	AJV	09/98 ⇒ 10/99
POLO III 50 1.0	ALD, AUC	09/96 ⇒ 10/99
POLO III 55 1.4	AKP	08/95 ⇒ 10/99
POLO III 60 1.4	AKK, ANW, AUD	07/95 ⇒ 09/01
POLO III 75 1.4 16V	APE, AUA	10/99 ⇒ 09/01
MULTIVAN 2.0	AXA	11/03 ⇒ 08/15
NEW BEETLE 1.6	AHW, AYD, BFS	06/00 ⇒ 09/10
NEW BEETLE 2.0	AEG, APK, AQY, BER	01/98 ⇒ 10/10
POLO V 1.2 TSI	CBZB, CBZC	11/09 ⇒
POLO V 1.2 TSI BlueMotion	CBZB	11/09 ⇒ 05/14
SHARAN I 2.0	ATM	09/95 ⇒ 03/10
SHARAN I 2.0 LPG	ATM	04/06 ⇒ 03/10
SPACEFOX / SPACE CROSS 1.6	BAH, BLH	03/06 ⇒
SPACEFOX / SPACE CROSS 1.6 FSI	BPA, CCRA, CFZA	03/06 ⇒
SPACEFOX / SPACE CROSS 1.6 Total Flex	BPA, CCRA, CFZA	03/06 ⇒
TOURAN I 1.2 TSI	CBZB	05/10 ⇒ 05/15
TOURAN I 1.6	BGU, BSE, BSF	07/03 ⇒ 05/10
TOURAN I 1.6 BiFuel	BSF	11/06 ⇒ 05/10
TOURAN I 2.0 FSI	BJZ	10/04 ⇒ 05/10
TOURAN I 2.0 TDI [CHN]	CGZA	04/09 ⇒
TRANSPORTER V 1.4 Brasile	BTJ	12/05 ⇒
TRANSPORTER V 2.0	AXA	11/03 ⇒ 08/15
TRANSPORTER V 2.0 BiFuel	AXA	05/11 ⇒ 08/15
TRANSPORTER V 2.0 CNG	AXACNG	11/03 ⇒ 08/15

EPS 1.990.423

07

COILS

Adatt./Suitable:

BOSCH
0 221 601 012**RENAULT**
74 01 275 174**VOLVO**
1275174**Eliminated on 12-01-2021. Please verify the availability through our local distributors**

- Eliminato il 12-01-2021. Verificare la disponibilità presso i nostri distributori
- Éliminé le 12-01-2021. Vérifier la disponibilité auprès de nos distributeurs sur place
- Am 12-01-2021 gestrichen. Evtl. Verfügbarkeit bitte bei unseren Händlern prüfen
- Eliminado en fecha 12-01-2021. Verificar la disponibilidad a través de nuestros distribuidores locales



	ohm		ohm
	0,53		8600

RENAULT		
SAFRANE II 2.5 20V	N7U700, N7U701	07/96 ⇒ 12/00
VOLVO		
850 2.0	B5202S, B5204F, B5204FS	06/91 ⇒ 12/96
850 2.0 10V	B5202FS	08/94 ⇒ 12/97
850 2.0 Turbo	B5204FT, B5204T, B5204T2	02/93 ⇒ 10/97
850 2.3	B5234FS	01/96 ⇒ 10/96
850 2.3 T5	9M9T872	02/93 ⇒ 12/96
850 2.3 T5-R	B5234T4	08/95 ⇒ 12/96
850 2.3 Turbo R	B5234T5	06/95 ⇒ 10/97
850 2.4	B5252, B5252FS, B5254S	06/91 ⇒ 12/96
850 2.4 AWD	B5254T	04/96 ⇒ 12/96
850 2.4 GLE	B5254T	09/93 ⇒ 10/97
850 2.5 10V	B5252FS	06/91 ⇒ 12/97
850 2.5 20V	B5254FS	08/91 ⇒ 12/97
C70 I 2.0	B5204T2	03/97 ⇒ 10/05
C70 I 2.4 T	B5254T	03/98 ⇒ 10/05
S70 2.0	B5202FS, B5202S, B5204T2	01/97 ⇒ 11/00
S70 2.0 Turbo	B5204T2, B5204T3	01/97 ⇒ 11/00
S70 2.3	B5234FS, B5234T3	11/96 ⇒ 07/99
S70 2.3 AWD	B5234T7	04/99 ⇒ 09/00
S70 2.3 T-5	B5234T3	01/97 ⇒ 11/00
S70 2.3 T5 AWD	B5234T3, B5234T4	11/96 ⇒ 09/98
S70 2.3 T5-R AWD	B5234T2	11/96 ⇒ 09/98
S70 2.3 Turbo	B5234FT+, B5234T4	01/97 ⇒ 11/00
S70 2.4	B5252FS, B5254FS, B5254S	01/97 ⇒ 11/00
S70 2.4 AWD	B5252FS	11/96 ⇒ 05/99
S70 2.4 Bifuel	GB5252S	10/98 ⇒ 11/00
S70 2.4 T5 AWD	B5254T	11/96 ⇒ 04/99
S70 2.4 Turbo	B5254T	01/97 ⇒ 11/00
S70 2.5 20V	B5254FS	01/97 ⇒ 12/98
S70 2.5 Bifuel	GB5252S2	01/99 ⇒ 12/99
V70 I 2.0	B5202FS, B5202S, B5204T2	12/95 ⇒ 03/00
V70 I 2.0 Turbo	B5204T2, B5204T3	12/95 ⇒ 12/00
V70 I 2.0 Turbo AWD	B5204T3	11/96 ⇒ 12/00
V70 I 2.3	B5234FS, B5234T3	11/96 ⇒ 07/99
V70 I 2.3 AWD	B5234T3, B5234T7	04/97 ⇒ 09/98
V70 I 2.3 T AWD	B5234FT+, B5234T4, B5234T6	04/97 ⇒ 12/98
V70 I 2.3 T-5	B5234T3	11/96 ⇒ 12/00
V70 I 2.3 T-5 AWD	B5234T3	01/97 ⇒ 12/00
V70 I 2.3 Turbo	B5234FT+, B5234T2, B5234T4	12/95 ⇒ 12/98
V70 I 2.4	B5252FS, B5254S	12/95 ⇒ 12/99
V70 I 2.4 Bifuel	GB5252S	05/98 ⇒ 12/99
V70 I 2.4 Turbo	B5254T	04/96 ⇒ 12/00

VOLVO

V70 I 2.4 Turbo AWD	B5254T	04/96 ⇒ 12/00
V70 I 2.5	B5252FS	01/97 ⇒ 03/00
V70 I 2.5 20V	B5254FS	01/97 ⇒ 12/99
V70 I 2.5 Bifuel	GB5252S2	01/99 ⇒ 12/99



CROSS REFERENCE LIST OEM/OES

EPS-IGN22Q1

- TABELLA COMPARATIVA OEM/OES - TABLE DE COMPARAISON OEM/OES - VERGLEICHSTABELLE OEM/OES - TABLA DE EQUIVALENCIAS OEM/OES

MANUFACTURER	MANUFACTURER	MANUFACTURER	MANUFACTURER
A	G	O	Z
ABARTH	GENERAL MOTORS	OPEL	ZASTAVA
ACURA	H	P	
ALFA ROMEO	HITACHI	PEUGEOT	
ASTON MARTIN	HOLDEN	PIAGGIO	
AUDI	HONDA	PORSCHE	
B	HYUNDAI	PUCH	
BENTLEY	I	R	
BMW	INFINITI	RELIANT	
BOSCH	INNOCENTI	RENAULT	
C	ISUZU	ROLLS-ROYCE	
CHEVROLET	IVECO	ROVER	
CHRYSLER	J	S	
CITROËN	JAGUAR	SAAB	
CUPRA	JEEP	SEAT	
D	K	SKODA	
DACIA	KIA	SMART	
DAEWOO	L	SOLO	
DAF	LADA	SSANGYONG	
DAIHATSU	LANCIA	STERLING	
DELPHI	LAND ROVER	SUBARU	
DENSO	LEXUS	SUZUKI	
DS	M	T	
DUCATI	MARUTI	TALBOT	
E	MASERATI	TOYOTA	
EFI AUTOMOTIVE	MAZDA	V	
F	MERCEDES-BENZ	VALEO	
FIAT	MG	VAUXHALL	
FIAT (YV)	MINI	VOLVO	
FORD	MINI	VW	
FORD AUSTRALIA	MITSUBISHI	Y	
FORD USA	N	YUGO	
	NISSAN		



MANUFACTURER'S NAMES AND PART NUMBERS ARE QUOTED FOR REFERENCE PURPOSE ONLY.

- I nomi dei fabbricanti e i loro numeri sono menzionati unicamente per facilitare la ricerca della nostra corrispondente parte di ricambio.
- Les noms et références des fabricants sont mentionnées seulement pour faciliter la recherche de nos références.
- Die Namen und Teile-Nr. der Hersteller dienen nur zur Erleichterung bei der Suche unserer Teile-Nr.
- Los nombres de los fabricantes y sus códigos sirven únicamente para la individuación de nuestros productos.



CROSS REFERENCE LIST OEM/OES

EPS-IGN22Q1

- TABELLA COMPARATIVA OEM/OES - TABLE DE COMPARAISON OEM/OES - VERGLEICHSTABELLE OEM/OES - TABLA DE EQUIVALENCIAS OEM/OES

AUDI

022 905 100 P	1.970.434
022 905 715 B	1.970.434
023 905 207	1.306.231 ^{*A}
026 905 207 A	1.315.068
026 905 209	1.306.129
026 905 225	1.406.116R
026 905 225 K	1.415.099R
027 905 207	1.306.094
027 905 207 A	1.306.266
030 905 065	1.906.223
030 905 065 B	1.906.223
030 905 207	1.306.094
032 905 106	1.990.420
032 905 106 B	1.990.420
032 905 106 D	1.990.420
032 905 106 E	1.990.420
032 905 106 F	1.990.420
034 905 207 B	1.306.231 ^{*A}
034 998 065	1.906.219
035 905 105 A	1.970.126
035 905 207 A	1.306.093
035 905 225	1.406.116R
035 905 225 B	1.406.055R
035 905 225 C	1.406.059R
036 905 715 A	1.970.474
036 905 715 F	1.970.474
036 905 715 G	1.970.474
043 905 207	1.306.079
051 905 207	1.306.266
051 905 225	1.406.121R
052 905 225 C	1.406.121R



1.306.231

**04**

DISTRIBUTOR CAPS

Adatt./Suitable: **BOSCH**

AUDI

023 905 207
034 905 207 B

BOSCH

0 290 004 032
0 290 004 035
1 235 522 369
1 235 522 371
1 235 522 385
1 235 522 404
1 235 522 405

VW

023 905 207
034 905 207
034 905 207 A
034 905 207 B
035 905 209 B

^{*A} without cover

- senza copertura
- sans revêtement
- ohne Abdeckung
- sin cubierta



AUDI

80 II 2.0	HP, JS	10/83 ⇨ 09/84
80 II 2.0 quattro	JS	10/83 ⇨ 09/84
80 IV 2.3 E	NG	09/91 ⇨ 01/96
80 IV 2.3 E quattro	NG	09/91 ⇨ 11/94
90 I 2.0	HP, JL, JS, SK	10/84 ⇨ 03/87
90 I 2.0 quattro	JS	08/84 ⇨ 08/86
90 I 2.2	HY, KV, KX	10/84 ⇨ 03/87
90 I 2.2 E quattro	KV	11/84 ⇨ 03/87
90 II 2.0	PS	07/88 ⇨ 09/91
90 II 2.0 20 V quattro	NM	08/88 ⇨ 09/91
90 II 2.2 E	KV	04/87 ⇨ 07/91
90 II 2.2 E quattro	KV	04/87 ⇨ 09/91
90 II 2.3 E	NG	04/87 ⇨ 09/91
90 II 2.3 E 20V quattro	7A	06/88 ⇨ 09/91
90 II 2.3 E quattro	NG	04/87 ⇨ 09/91
100 III 2.0	KP	08/84 ⇨ 12/87
100 III 2.0 Cat	RT	01/88 ⇨ 11/90
100 III 2.0 E	KP	01/85 ⇨ 12/87
100 III 2.0 E Cat	RT	01/88 ⇨ 11/90
100 III 2.2 Cat	KU	06/89 ⇨ 11/90
100 III 2.2 Cat quattro	KU	06/89 ⇨ 11/90
100 III 2.2 E Turbo quattro	MC	08/86 ⇨ 11/90
100 III 2.2 Turbo	MC	08/86 ⇨ 11/90
100 III 2.3	NF	08/86 ⇨ 11/90
100 III 2.3 E	NF	10/86 ⇨ 11/90
100 III 2.3 E quattro	NF	08/86 ⇨ 11/90
100 III 2.3 quattro	NF	01/90 ⇨ 11/90
100 IV 2.3 E	AAR	12/90 ⇨ 07/94
100 IV 2.3 E quattro	AAR	12/90 ⇨ 07/94
200 II 2.2	KU	08/84 ⇨ 07/85
200 II 2.2 Turbo	1B, MC	08/85 ⇨ 09/91

ABARTH

46777288	1.970.442
55224110	1.970.549
55229959	1.970.549
55246099	1.970.442
9937767	1.430.054R
9939762	1.930.161/1

ACURA

06302-PT2-000	1.965.052
06302-PT2-A00	1.965.052
30102-P54-006	1.322.068
30102-PM5-A02	1.322.069
30102-PT2-006	1.322.068
30102-PV1-A05	1.322.084
30103-P08-003	1.422.095
30103-PAI-732	1.422.056
30103-PM5-A04	1.422.082
30103-PW0-G02	1.422.097R
30500-PE0-006	1.970.212
30500-PM5-A02	1.970.213
30500-PR4-A02	1.970.215
30510-P73-A01	1.970.214
30510-PT2-006	1.970.214

ALFA ROMEO

510 897	1.970.101D
700 216	1.306.079
700 218	1.406.012R
700 220	1.206.034HVS
700 291	1.315.049
700 295	1.415.091
700 299	1.115.034
701 707	1.130.117
705 390	1.430.051R
705 410	1.306.079
705 420	1.906.153
705 559	1.315.054
105 02 05 011 00/03	1.230.127
105 48 05 011 00/01	1.406.012R
105 48 05 011 04/03	1.230.139
105 48 05 011 06/01	1.306.076
105 48 05 011 08/02	1.306.079
115 44 05 011 00/02	1.406.055R
115 48 05 089 00	1.500.716
116 34 05 011 00/03	1.230.139
116 36 05 011 01/01	1.406.025R
116 42 65 079 00	1.970.101D
116 55 05 011 00/02	1.306.079
116 55 05 011 01/01	1.430.042R
116 55 05 011 01/09	1.130.117
116 55 05 011 03/01	1.415.083R
116 55 05 011 03/02	1.215.055
116 55 05 011 03/04	1.115.023
116 58 05 011 00/02	1.430.054R
116 69 05 011 00/02	1.406.113R
116 97 05 011 00/04	1.406.061R
119 00 05 011 04/02	1.306.081
119 11 05 011 00/02	1.406.024R
130 85 50 06/07	1.306.062
140 20 05 011 00/01	1.206.034HVS
140 20 05 011 00/03	1.406.012R
165 55 05 011 00/02	1.306.079
195 05 05 011 02/01	1.406.121R
195 17 05 011 00/02	1.406.121R
195 32 05 021 00/00	1.306.236 ^A
195 32 05 023 00/00	1.406.119R
46337742	1.970.549
46469863	1.970.387
46469919	1.501.608
46469920	1.501.608
46548037	1.970.146
46755605	1.970.397

ALFA ROMEO

46755606	1.501.607
46756506	1.501.608
46777288	1.970.442
46786044	1.501.608
55200112	1.970.423
55208723	1.970.423
55214926	1.970.549
55224110	1.970.549
55229959	1.970.549
55246099	1.970.442
55263679	1.970.549
55267630	1.970.549
55270217	1.970.549
60513050	1.306.236 ^A
60513052	1.406.119R
60522981	1.500.716
60534261	1.906.233 ^S
60534855	1.500.660
60558152	1.970.168
60562701	1.970.313
60566481	1.500.623
60566483	1.500.623
60567866	1.500.666
60569567	1.500.716
60573030	1.500.660
60573733	1.500.666
60586072	1.970.168
60605306	1.970.386K ¹
60710643	1.230.127
60714274	1.230.139
60714282	1.306.076
60714284	1.306.079
60723008	1.406.055R
60727364	1.230.139
60730437	1.430.042R
60730444	1.130.117
60730445	1.215.055
60731801	1.430.054R
60732287	1.406.113R
60735405	1.306.081
60735860	1.406.024R
60739126	1.206.034HVS
60739128	1.406.012R
60743670	1.406.121R
60743768	1.406.121R
60744199	1.970.101D
60748373	1.315.049
60748377	1.415.091
60748381	1.115.034
60749285	1.130.117
60749769	1.430.051R
60749869	1.315.054
60750065	1.965.005
60752000	1.406.055R
60755007	1.406.061R
60755091	1.406.123R
60801306	1.306.079
60805420	1.970.146
60809492	1.970.146
60809606	1.970.168
60810690	1.970.313
71711984	1.970.386
71713719	1.501.607
71713719	1.501.608
71739725	1.970.450
71744369	1.970.450
71779115	1.970.450
7789742	1.501.608
7789743	1.501.608
7793212	1.970.386
82305237	1.306.079
96586846	1.306.079
9916117	1.415.083R
9927967	1.406.025R
9938173	1.430.055R
9938953	1.906.153

ALFA ROMEO

9940437	1.406.061R
9950021	1.406.025R
9950047	1.430.055R
9950051	1.330.098
9950055	1.906.153
9950142	1.430.059
9950152	1.115.034
9950519	1.330.115

ASTON MARTIN

9091902257	1.970.537
------------	-----------

AUDI

022 905 100 P	1.970.434
022 905 715 B	1.970.434
022 905 715 D	1.970.434
023 905 207	1.306.231 ^A
026 905 207 A	1.315.068
026 905 209	1.306.129
026 905 225	1.406.116R
026 905 225 K	1.415.099R
027 905 207	1.306.094
027 905 207 A	1.306.266
030 905 065	1.906.223
030 905 065 B	1.906.223
030 905 207	1.306.094
032 905 106	1.990.420
032 905 106 B	1.990.420
032 905 106 D	1.990.420
032 905 106 E	1.990.420
032 905 106 F	1.990.420
034 905 207 B	1.306.231 ^A
034 998 065	1.906.219
035 905 105 A	1.970.126
035 905 207 A	1.306.093
035 905 225	1.406.116R
035 905 225 B	1.406.055R
035 905 225 C	1.406.059R
036 905 100 A	1.970.474
036 905 100 B	1.970.474
036 905 100 C	1.970.474
036 905 100 D	1.970.474
036 905 715	1.970.474
036 905 715 A	1.970.474
036 905 715 C	1.970.474
036 905 715 E	1.970.474
036 905 715 F	1.970.474
036 905 715 G	1.970.474
036 905 715 H	1.970.474
043 905 207	1.306.079
04C 905 110 D	1.970.599
04C 905 110 E	1.970.599
04C 905 110 H	1.970.599
04C 905 110 J	1.970.599
04C 905 110 L	1.970.599
04E 905 110 B	1.970.599
04E 905 110 D	1.970.599
04E 905 110 E	1.970.599
04E 905 110 K	1.970.599
04E 905 110 M	1.970.599
04E 905 110 P	1.970.599
051 905 207	1.306.266
051 905 225	1.406.121R
052 905 225 C	1.406.121R
055 905 225 B	1.406.055R
058 905 101	1.970.354S
058 905 105	1.970.354S
06A 905 115	1.970.429
06A 905 115 A	1.970.429
06A 905 115 B	1.970.429
06A 905 115 C	1.970.429

AUDI

06A 905 115 D	1.970.429
06B 905 115	1.970.445
06B 905 115 B	1.970.445
06B 905 115 D	1.970.429
06B 905 115 E	1.970.445
06B 905 115 G	1.970.429
06B 905 115 H	1.970.429
06B 905 115 J	1.970.429
06B 905 115 L	1.970.429
06B 905 115 M	1.970.429
06B 905 115 N	1.970.429
06B 905 115 P	1.970.429
06B 905 115 Q	1.970.429
06B 905 115 R	1.970.429
06B 905 115 S	1.970.429
06C 905 115 A	1.970.436
06C 905 115 B	1.970.436
06C 905 115 C	1.970.429
06C 905 115 D	1.970.436
06C 905 115 E	1.970.436
06C 905 115 F	1.970.436
06C 905 115 G	1.970.436
06C 905 115 H	1.970.436
06C 905 115 J	1.970.436
06C 905 115 K	1.970.436
06C 905 115 L	1.970.436
06C 905 115 M	1.970.436
06D 905 115	1.970.427
06D 905 115 A	1.970.427
06D 905 115 C	1.970.427
06D 905 115 D	1.970.427
06D 905 115 F	1.970.427
06D 905 115 G	1.970.427
06D 905 115 J	1.970.427
06D 905 115 K	1.970.427
06E 905 115	1.970.427
06E 905 115 A	1.970.427
06E 905 115 B	1.970.427
06E 905 115 C	1.970.427
06E 905 115 D	1.970.427
06E 905 115 E	1.970.427
06E 905 115 F	1.970.427
06E 905 115 G	1.970.427
06F 905 115 C	1.970.426
06F 905 115 E	1.970.426
06F 905 115 F	1.970.426
06H 905 110 D	1.970.636
06H 905 110 E	1.970.636
06H 905 110 F	1.970.636
06H 905 110 G	1.970.636
06H 905 110 H	1.970.636
06H 905 110 L	1.970.636
06H 905 115	1.970.426
06H 905 115 A	1.970.426
06H 905 115 B	1.970.426
06K 905 110 K	1.970.636
06L 905 110 C	1.970.636
06L 905 110 D	1.970.636
06L 905 110 E	1.970.636
06L 905 110 F	1.970.636
06L 905 110 H	1.970.636
06L 905 110 K	1.970.636
077 905 115 B	1.970.433
077 905 115 C	1.970.433
077 905 115 E	1.970.433
077 905 115 F	1.970.433
077 905 115 H	1.970.433
077 905 115 K	1.970.433
077 905 115 P	1.970.433
077 905 115 Q	1.970.433
077 905 115 T	1.970.433
077 905 205	1.306.248 ^A
077 905 207	1.306.248 ^A
07K 905 715 A	1.970.426
07K 905 715 C	1.970.426
07K 905 715 D	1.970.426

AUDI

07K 905 715 F	1.970.426
07K 905 715 G	1.970.426
07L 905 115	1.970.427
07L 905 115 A	1.970.427
07L 905 115 B	1.970.427
191 905 351 B	1.965.007
211 905 115 B	1.970.132
211 905 115 D	1.970.125
211 905 351	1.965.004
251 905 115 A	1.970.125
4A0 905 351	1.965.051
4D0 905 351	1.965.076
6N0 905 104	1.990.414
811 905 115	1.970.127
867 905 352	1.990.414
8D0 905 351	1.965.072

BENTLEY

06H 905 110 G	1.970.636
06H 905 110 L	1.970.636

BMW

1 317 232	1.970.162S
1 703 227	1.970.352
1 703 359	1.970.162S
1 703 360	1.970.162S
1 715 903	1.306.238
1 720 166	1.970.112
1 720 877	1.970.112
1 726 177	1.970.162S
1 727 108	1.970.162S
1 730 520	1.970.162S
1 730 766	1.970.162S
1 734 468	1.970.162S
1 748 017	1.970.352
1 748 018	1.970.352
12 11 1 243 843	1.206.034HVS
12 11 1 267 391	1.206.034HVS
12 11 1 267 392	1.206.062
12 11 1 267 393	1.206.034HVS
12 11 1 267 394	1.206.049HVS
12 11 1 267 464	1.406.024R
12 11 1 271 656	1.306.062
12 11 1 271 657	1.306.081
12 11 1 271 687	1.206.062
12 11 1 272 144	1.406.055R
12 11 1 272 300	1.406.061R
12 11 1 276 277	1.406.112R
12 11 1 284 372	1.306.121
12 11 1 284 446	1.406.119R
12 11 1 285 058	1.306.238 ^{FA}
12 11 1 286 110	1.406.115R
12 11 1 286 111	1.406.112R
12 11 1 289 425	1.306.247
12 11 1 289 519	1.306.121
12 11 1 304 909	1.406.117R
12 11 1 326 765	1.306.094
12 11 1 328 430	1.406.117R
12 11 1 351 446	1.306.072
12 11 1 351 447	1.406.012R
12 11 1 353 117	1.306.072
12 11 1 354 449	1.306.079
12 11 1 354 499	1.306.062
12 11 1 354 501	1.306.072
12 11 1 354 502	1.206.034HVS
12 11 1 354 503	1.406.012R
12 11 1 354 584	1.206.049HVS
12 11 1 354 999	1.306.062
12 11 1 355 211	1.406.027R
12 11 1 355 624	1.206.062
12 11 1 355 626	1.306.081

BMW

12 11 1 356 919	1.206.049HVS
12 11 1 357 720	1.406.115R
12 11 1 359 704	1.106.212
12 11 1 359 705	1.206.034HVS
12 11 1 359 706	1.306.081
12 11 1 359 873	1.206.034HVS
12 11 1 359 874	1.306.079
12 11 1 360 305	1.406.027R
12 11 1 360 306	1.406.024R
12 11 1 360 648	1.206.034HVS
12 11 1 361 760	1.206.034HVS
12 11 1 362 221	1.406.027R
12 11 1 363 191	1.306.079
12 11 1 363 291	1.306.079
12 11 1 363 292	1.306.081
12 11 1 363 422	1.306.081
12 11 1 363 423	1.306.079
12 11 1 706 122	1.306.094
12 11 1 707 263	1.406.060R
12 11 1 710 735	1.406.115R
12 11 1 720 124	1.306.238
12 11 1 722 649	1.306.238
12 11 1 725 070	1.306.238
12 11 1 734 109	1.306.247 ^{FA}
12 11 1 734 110	1.406.119R
12 11 8 630 144	1.406.012R
12 11 8 630 146	1.306.062
12 11 8 730 024	1.206.034HVS
12 11 8 730 055	1.306.062
12 12 1 247 362	1.500.900
12 12 1 247 363	1.500.900
12 12 1 247 364	1.500.900
12 12 1 247 365	1.500.900
12 12 1 247 511	1.501.921
12 12 1 247 512	1.501.921
12 12 1 247 513	1.501.921
12 12 1 247 514	1.501.921
12 12 1 247 523	1.501.921
12 12 1 247 524	1.501.921
12 12 1 247 525	1.501.921
12 12 1 247 526	1.501.921
12 12 1 355 211	1.406.027R
12 12 1 705 697	1.500.572
12 12 1 709 206	1.499.069
12 12 1 709 207	1.499.069
12 12 1 709 208	1.499.069
12 12 1 709 209	1.499.069
12 12 1 717 646	1.500.573
12 12 1 720 529	1.500.587
12 12 1 722 253	1.500.578
12 12 1 726 037	1.500.597
12 12 1 727 686	1.500.573
12 12 1 727 855	1.500.605
12 13 0 148 594	1.970.475
12 13 0 390 064	1.970.475
12 13 1 317 232	1.970.162S
12 13 1 317 585	1.970.162S
12 13 1 357 296	1.970.101D
12 13 1 359 637	1.970.101D
12 13 1 402 440	1.970.162S
12 13 1 402 713	1.970.162S
12 13 1 404 102	1.970.162S
12 13 1 703 228	1.970.352
12 13 1 703 359	1.970.162S
12 13 1 703 825	1.970.352
12 13 1 712 219	1.970.475
12 13 1 712 223	1.970.475
12 13 1 720 166	1.970.112
12 13 1 720 877	1.970.112
12 13 1 726 177	1.970.162S
12 13 1 726 178	1.970.162S
12 13 1 727 108	1.970.162S
12 13 1 729 842	1.970.162S
12 13 1 730 765	1.970.162S
12 13 1 730 766	1.970.162S
12 13 1 731 884	1.970.162S

BMW

12 13 1 734 468	1.970.162S
12 13 1 742 925	1.970.112
12 13 1 748 017	1.970.352
12 13 1 748 018	1.970.352
12 13 1 748 394	1.970.162S
12 13 1 748 395	1.970.162S
12 13 5 A06 753	1.970.475
12 13 7 523 345	1.970.475
12 13 7 548 553	1.970.475
12 13 7 550 012	1.970.475
12 13 7 551 049	1.970.475
12 13 7 551 260	1.970.475
12 13 7 559 842	1.970.607
12 13 7 562 744	1.970.475
12 13 7 571 643	1.970.475
12 13 7 571 644	1.970.607
12 13 7 575 010	1.970.475
12 13 7 582 627	1.970.607
12 13 7 594 596	1.970.475
12 13 7 594 935	1.970.607
12 13 7 594 936	1.970.475
12 13 7 594 937	1.970.475
12 13 7 594 938	1.970.475
12 13 7 599 218	1.970.162S
12 13 7 599 219	1.970.352
12 13 7 619 385	1.970.632
12 13 7 638 477	1.970.607
12 13 8 611 236	1.970.475
12 13 8 615 991	1.970.632
12 13 8 616 153	1.970.475
12 13 8 643 360	1.970.632
12 13 8 647 463	1.970.632
12 13 8 647 689	1.970.475
12 13 8 657 273	1.970.475
12 13 8 678 438	1.970.632
12 13 9 066 468	1.970.162S
12 13 9 067 830	1.970.352
12 14 1 244 089	1.965.004
12 14 1 244 191	1.965.004
12 14 1 244 477	1.965.004
12 14 1 266 702	1.965.005
12 14 1 273 217	1.965.005
12 14 1 273 298	1.965.005
12 14 1 274 698	1.965.005
17 20 1 66.2	1.970.112
5 575 010	1.970.475
7 548 553	1.970.475
7 551 049	1.970.475
7 559 842	1.970.607
7 571 643	1.970.475
7 594 596	1.970.475
7 594 935	1.970.607
7 594 936	1.970.475
7 599 218	1.970.162S
7 599 219	1.970.352
7 638 477	1.970.607
8 611 236	1.970.475
8 616 153	1.970.475
8 643 360	1.970.632
8 647 689	1.970.475

BOSCH

0 221 102 088	1.970.132
0 221 102 090	1.970.101D
0 221 102 091	1.970.101D
0 221 118 307	1.970.180
0 221 118 329	1.970.178
0 221 118 398	1.970.126
0 221 119 008	1.970.101D
0 221 119 018	1.970.101D
0 221 119 025	1.970.101D
0 221 119 027	1.970.101D
0 221 119 035	1.970.101D
0 221 119 048	1.970.101D

BOSCH

0 221 122 008	1.970.169
0 221 122 012	1.970.103
0 221 122 022	1.970.132
0 221 122 023	1.970.132
0 221 122 031	1.970.169
0 221 122 349	1.970.125
0 221 122 350	1.970.125
0 221 122 357	1.970.126
0 221 122 358	1.970.126
0 221 122 369	1.970.194
0 221 122 379	1.970.127
0 221 122 380	1.970.127
0 221 122 386	1.970.125
0 221 122 399	1.970.126
0 221 122 400	1.970.126
0 221 122 402	1.970.191
0 221 122 403	1.970.191
0 221 122 408	1.970.192
0 221 122 409	1.970.192
0 221 123 007	1.970.101D
0 221 502 009	1.970.112
0 221 502 431	1.970.178
0 221 502 433	1.970.179
0 221 503 001	1.970.273
0 221 503 003	1.970.189
0 221 503 004	1.970.188
0 221 503 006	1.970.189
0 221 503 011	1.970.389
0 221 503 014	1.970.398
0 221 503 022	1.970.414
0 221 503 024	1.970.189
0 221 503 025	1.970.188
0 221 503 035	1.970.417
0 221 503 036	1.970.417
0 221 503 407	1.970.168
0 221 503 457	1.970.168
0 221 503 468	1.970.507
0 221 503 471	1.970.398
0 221 503 485	1.970.481
0 221 503 486	1.970.481
0 221 503 487	1.970.481
0 221 503 491	1.970.532
0 221 504 004	1.970.352
0 221 504 006	1.970.314
0 221 504 026	1.970.549
0 221 504 029	1.970.352
0 221 504 036	1.970.549
0 221 504 100	1.970.475
0 221 504 410	1.970.412
0 221 504 456	1.970.313
0 221 504 463	1.970.475
0 221 504 467	1.970.475
0 221 504 471	1.970.607
0 221 504 472	1.970.607
0 221 504 474	1.970.412
0 221 505 437	1.970.317
0 221 505 438	1.970.317
0 221 506 002	1.970.316
0 221 506 003	1.970.316
0 221 506 444	1.970.316
0 221 506 445	1.970.316
0 221 601 012	1.990.423
0 221 604 001	1.970.448
0 221 604 008	1.970.448
0 221 604 010	1.970.478
0 221 604 014	1.970.489
0 221 604 115	1.970.426
0 221 604 116	1.970.426
0 227 100 030	1.965.076
0 227 100 100	1.965.004
0 227 100 101	1.965.004
0 227 100 102	1.965.005
0 227 100 103	1.965.004
0 227 100 104	1.965.004
0 227 100 110	1.965.005
0 227 100 111	1.965.005

BOSCH		BOSCH		BOSCH		BOSCH	
0986 221 027	1.970.108	1234 332 279	1.406.060R	1234 332 861	1.412.096	1235 522 323	1.306.092
0986 221 029	1.970.155	1234 332 280	1.406.027R	1234 332 902	1.406.012R	1235 522 324	1.306.090
0986 221 030	1.970.355	1234 332 281	1.406.115R	1234 332 903	1.406.014R	1235 522 325	1.306.117 ^A
0986 221 031	1.970.356	1234 332 282	1.406.049R	1234 332 904	1.406.018R	1235 522 326	1.306.108
0986 221 033	1.970.196	1234 332 284	1.406.117R	1234 332 906	1.406.021R	1235 522 327	1.306.108 ^A
0986 221 034	1.970.403	1234 332 285	1.406.026R	1234 332 907	1.406.021R	1235 522 329	1.306.123
0986 356 345	1.499.223	1234 332 288	1.406.115R	1234 332 908	1.406.025R	1235 522 330	1.306.123 ^A
1217 013 001	1.206.060	1234 332 291	1.406.067R	1234 332 918	1.412.093R	1235 522 332	1.306.124
1217 013 002	1.206.060	1234 332 296	1.406.060R	1234 335 082	1.406.014R	1235 522 333	1.306.121
1217 013 003	1.206.060	1234 332 300	1.406.055R	1234 335 215	1.406.025R	1235 522 356	1.306.079
1217 013 006	1.206.060	1234 332 301	1.406.055R	1234 335 216	1.406.026R	1235 522 357	1.306.094
1217 013 009	1.206.064	1234 332 303	1.406.067R	1234 335 280	1.406.027R	1235 522 361	1.306.121
1217 013 015	1.206.060	1234 332 305	1.406.059R	1234 335 300	1.406.055R	1235 522 362	1.306.081 ^A
1217 013 020	1.206.083	1234 332 309	1.406.055R	1234 335 305	1.406.059R	1235 522 364	1.306.238
1217 013 021	1.206.068	1234 332 313	1.406.112R	1234 335 801	1.412.093R	1235 522 365	1.306.238 ^A
1217 013 022	1.206.068	1234 332 317	1.406.117R	1234 335 802	1.415.091	1235 522 366	1.306.127
1217 013 025	1.206.083	1234 332 332	1.406.024R	1234 335 805	1.415.083R	1235 522 368	1.306.123
1217 013 103	1.206.060	1234 332 333	1.406.070R	1234 335 845	1.415.088R	1235 522 369	1.306.231
1217 031 015	1.206.068	1234 332 337	1.406.049R	1235 522 040	1.306.081	1235 522 370	1.306.129
1220 522 019	1.970.192	1234 332 340	1.406.114R	1235 522 041	1.306.081	1235 522 371	1.306.231
1221 122 409	1.970.192	1234 332 341	1.406.122R	1235 522 050	1.306.076	1235 522 372	1.306.261
1227 010 003	1.965.034	1234 332 343	1.406.115R	1235 522 051	1.306.072	1235 522 374	1.306.235
1227 010 039	1.965.034	1234 332 344	1.406.112R	1235 522 053	1.306.081	1235 522 375	1.306.266
1227 020 029	1.970.191	1234 332 346	1.406.113R	1235 522 056	1.306.079	1235 522 380	1.306.234 ^A
1227 022 008	1.965.004	1234 332 347	1.406.119R	1235 522 058	1.306.076	1235 522 381	1.306.234
1227 022 030	1.990.414	1234 332 348	1.406.116R	1235 522 059	1.306.076	1235 522 382	1.306.127 ^A
1227 030 030	1.990.414	1234 332 349	1.406.118R	1235 522 060	1.306.072	1235 522 384	1.306.237
1227 030 051	1.970.269	1234 332 350	1.406.121R	1235 522 074	1.306.092	1235 522 385	1.306.231 ^A
1227 030 052	1.970.269	1234 332 351	1.406.112R	1235 522 075	1.306.081	1235 522 387	1.306.236
1227 030 059	1.970.386	1234 332 353	1.406.117R	1235 522 103	1.306.072	1235 522 388	1.306.236 ^A
1227 030 062	1.970.387	1234 332 359	1.406.055R	1235 522 107	1.306.062	1235 522 390	1.306.233
1227 030 071	1.970.397	1234 332 360	1.406.121R	1235 522 109	1.306.072	1235 522 391	1.306.239
1230 500 221	1.906.160	1234 332 364	1.406.122R	1235 522 134	1.306.062	1235 522 392	1.306.239 ^A
1230 591 003	1.306.080	1234 332 365	1.406.125R	1235 522 141	1.306.076	1235 522 395	1.306.128 ^A
1230 591 040	1.306.266	1234 332 366	1.406.121R	1235 522 144	1.306.076	1235 522 396	1.306.247 ^A
1234 211 018	1.906.153	1234 332 370	1.406.123R	1235 522 145	1.306.076	1235 522 397	1.306.247
1234 211 218	1.906.153	1234 332 371	1.406.122R	1235 522 146	1.306.072	1235 522 399	1.306.240
1234 332 024	1.406.018R	1234 332 374	1.406.121R	1235 522 147	1.306.072	1235 522 400	1.306.240 ^A
1234 332 029	1.406.018R	1234 332 381	1.406.127R	1235 522 154	1.306.072	1235 522 401	1.306.241
1234 332 030	1.406.018R	1234 332 382	1.406.126R	1235 522 155	1.306.079	1235 522 404	1.306.231
1234 332 033	1.406.012R	1234 332 387	1.406.121R	1235 522 157	1.306.062	1235 522 405	1.306.231 ^A
1234 332 062	1.406.018R	1234 332 390	1.406.147R	1235 522 158	1.306.072	1235 522 408	1.306.260 ^A
1234 332 072	1.406.018R	1234 332 393	1.406.121R	1235 522 159	1.306.072	1235 522 409	1.306.080 ^A
1234 332 074	1.406.012R	1234 332 395	1.406.140R	1235 522 167	1.306.076	1235 522 417	1.306.251 ^A
1234 332 076	1.406.014R	1234 332 399	1.406.121R	1235 522 169	1.306.076	1235 522 418	1.306.251
1234 332 082	1.406.014R	1234 332 401	1.406.061R	1235 522 171	1.306.072	1235 522 419	1.306.248
1234 332 087	1.406.018R	1234 332 402	1.406.121R	1235 522 173	1.306.076	1235 522 420	1.306.248 ^A
1234 332 088	1.406.018R	1234 332 408	1.406.146R	1235 522 175	1.306.076	1235 522 421	1.306.238
1234 332 089	1.406.014R	1234 332 414	1.406.121R	1235 522 176	1.306.072	1235 522 423	1.306.253
1234 332 106	1.406.021R	1234 332 417	1.406.125R	1235 522 177	1.306.072	1235 522 424	1.306.080
1234 332 107	1.406.021R	1234 332 421	1.406.148R	1235 522 179	1.306.076	1235 522 426	1.306.233
1234 332 109	1.406.021R	1234 332 422	1.406.146R	1235 522 181	1.306.072	1235 522 434	1.306.257
1234 332 144	1.406.067R	1234 332 426	1.406.149R	1235 522 183	1.306.079	1235 522 435	1.306.257 ^A
1234 332 158	1.406.067R	1234 332 800	1.412.093	1235 522 185	1.306.079	1235 522 436	1.306.249
1234 332 162	1.406.067R	1234 332 801	1.412.093R	1235 522 188	1.306.079	1235 522 437	1.306.256
1234 332 173	1.406.024R	1234 332 802	1.415.091	1235 522 189	1.306.079	1235 522 438	1.306.258
1234 332 177	1.406.023R	1234 332 803	1.415.081	1235 522 193	1.306.079	1235 522 439	1.306.258 ^A
1234 332 197	1.406.024R	1234 332 805	1.415.083R	1235 522 195	1.306.081	1235 522 442	1.306.252 ^A
1234 332 200	1.406.113R	1234 332 808	1.430.037	1235 522 196	1.306.080	1235 522 443	1.306.094
1234 332 204	1.406.034R	1234 332 809	1.430.037R	1235 522 198	1.306.081	1235 522 444	1.306.266
1234 332 208	1.406.027R	1234 332 810	1.430.037	1235 522 199	1.306.079	1235 522 447	1.306.260
1234 332 209	1.406.067R	1234 332 811	1.430.037R	1235 522 201	1.306.079	1235 522 449	1.306.233 ^A
1234 332 213	1.406.025R	1234 332 812	1.430.037	1235 522 202	1.306.080	1235 522 453	1.306.263
1234 332 215	1.406.025R	1234 332 813	1.430.037R	1235 522 203	1.306.079	1235 522 454	1.306.263 ^A
1234 332 216	1.406.026R	1234 332 814	1.430.036R	1235 522 208	1.306.090	1235 522 456	1.306.079
1234 332 220	1.406.115R	1234 332 827	1.413.014	1235 522 213	1.306.094	1235 522 465	1.306.094
1234 332 236	1.406.024R	1234 332 828	1.413.014	1235 522 218	1.306.093	1235 522 496	1.306.080
1234 332 237	1.406.024R	1234 332 836	1.406.014R	1235 522 219	1.306.079	1235 522 801	1.312.066
1234 332 242	1.406.116R	1234 332 838	1.415.088R	1235 522 227	1.306.079	1235 522 803	1.315.049
1234 332 261	1.406.025R	1234 332 841	1.415.088R	1235 522 229	1.306.081	1235 522 804	1.315.041
1234 332 271	1.406.061R	1234 332 845	1.415.088R	1235 522 256	1.306.079	1235 522 805	1.315.045
1234 332 272	1.406.117R	1234 332 848	1.428.012	1235 522 290	1.306.081	1235 522 806	1.315.045
1234 332 273	1.406.056R	1234 332 849	1.430.042R	1235 522 295	1.306.081	1235 522 807	1.330.069
1234 332 275	1.406.061R	1234 332 850	1.415.083R	1235 522 307	1.306.099	1235 522 810	1.330.081
1234 332 276	1.406.112R	1234 332 859	1.446.014R	1235 522 315	1.306.079	1235 522 812	1.342.043
1234 332 277	1.406.117R	1234 332 860	1.415.094	1235 522 322	1.306.109	1235 522 816	1.322.003

BOSCH		BOSCH		BOSCH		BOSCH	
1 235 522 819	1.322.003	1 237 013 079	1.206.062	1 237 013 821	1.242.054	1 987 233 012	1.331.003/00
1 235 522 822	1.319.083	1 237 013 081	1.206.034HVS	1 237 013 824	1.230.123	1 987 233 020	1.331.003/00
1 235 522 829	1.330.086	1 237 013 082	1.206.049HVS	1 237 013 826	1.213.011HV	1 987 233 022	1.313.093
1 235 522 831	1.328.075	1 237 013 083	1.206.034HVS	1 237 013 827	1.215.076	1 987 233 030	1.313.262
1 235 522 832	1.315.059	1 237 013 086	1.206.062	1 237 013 828	1.215.111U	1 987 233 032	1.313.122
1 235 522 835	1.347.025	1 237 013 087	1.206.034HVS	1 237 013 831	1.230.142	1 987 233 033	1.313.092
1 235 522 836	1.330.069	1 237 013 088	1.206.034HVS	1 237 013 832	1.222.056HV	1 987 233 036	1.322.011
1 235 522 837	1.317.014	1 237 013 090	1.206.034HVS	1 237 013 835	1.230.127	1 987 233 037	1.322.022
1 235 522 843	1.328.078	1 237 013 091	1.206.062	1 237 013 837	1.246.071	1 987 233 043	1.331.118
1 235 522 844	1.330.090	1 237 013 094	1.206.034HVS	1 237 013 838	1.215.086	1 987 233 044	1.331.121
1 235 522 845	1.315.054	1 237 013 096	1.206.034HVS	1 237 013 840	1.215.102	1 987 233 047	1.322.057
1 235 522 863	1.312.073	1 237 013 098	1.206.034HVS	1 237 013 842	1.212.055HVS	1 987 233 051	1.322.040
1 235 522 901	1.306.076	1 237 013 101	1.206.047	1 237 013 846	1.212.055HVS	1 987 233 052	1.322.046
1 235 522 902	1.306.072	1 237 013 102	1.206.029HV	1 237 013 848	1.215.103	1 987 233 054	1.313.123
1 235 522 903	1.306.076	1 237 013 103	1.206.029HV	1 237 013 901	1.206.047	1 987 233 055	1.313.107
1 235 522 904	1.306.072	1 237 013 105	1.206.032HV	1 237 013 902	1.206.029HV	1 987 233 908	1.322.003
1 235 522 905	1.306.079	1 237 013 106	1.206.034HVS	1 237 013 904	1.206.032HV	1 987 233 912	1.331.003/00
1 235 522 907	1.306.062	1 237 013 107	1.206.040	1 237 013 906	1.206.034HVS	1 987 234 001	1.413.014
1 235 522 908	1.306.079	1 237 013 108	1.206.062	1 237 013 907	1.206.040	1 987 234 003	1.413.014
1 235 522 930	1.312.066	1 237 013 109	1.206.034HVS	1 237 013 910	1.215.055	1 987 234 009	1.431.023
1 235 522 931	1.306.080	1 237 013 110	1.206.034HVS	1 237 013 911	1.242.054	1 987 234 015	1.422.052
1 235 525 056	1.306.079	1 237 013 111	1.206.034HVS	1 237 013 912	1.206.049HVS	1 987 234 021	1.413.014
1 235 525 059	1.306.076	1 237 013 112	1.206.062	1 237 013 913	1.206.034HVS	1 987 234 024	1.431.023
1 235 525 196	1.306.080	1 237 013 113	1.206.049HVS	1 237 013 914	1.206.034HVS	1 987 234 025	1.413.027
1 235 525 801	1.312.066	1 237 013 114	1.206.034HVS	1 237 013 915	1.206.049HVS	1 987 234 027	1.413.029
1 235 525 803	1.315.049	1 237 013 115	1.206.062	1 237 013 916	1.206.034HVS	1 987 234 031	1.422.073
1 235 525 806	1.315.045	1 237 013 116	1.206.034HVS	1 237 013 917	1.206.034HVS	1 987 234 033	1.431.113
1 235 525 812	1.342.043	1 237 013 117	1.206.034HVS	1 237 013 918	1.212.055HVS	1 987 234 038	1.431.110
1 237 000 065	1.306.241 ^A	1 237 013 119	1.206.034HVS	1 237 013 919	1.230.132	1 987 234 041	1.413.028
1 237 010 027	1.906.223	1 237 013 121	1.206.049HVS	1 237 013 920	1.230.139	1 987 234 042	1.422.056
1 237 010 033	1.906.233	1 237 013 122	1.206.062	1 237 013 921	1.230.140	1 987 234 901	1.413.014
1 237 010 039	1.906.223	1 237 013 123	1.206.034HVS	1 237 013 923	1.206.034HVS	1 987 234 909	1.431.023
1 237 011 073	1.906.159	1 237 013 124	1.206.034HVS	1 237 013 924	1.212.055HVS	2 207 013 002	1.206.064
1 237 011 076	1.906.193	1 237 013 125	1.206.034HVS	1 237 015 802	1.212.055HVS	2 207 013 003	1.206.064
1 237 011 081	1.906.219	1 237 013 129	1.206.049HVS	1 237 015 804	1.230.132	2 207 013 004	1.206.071
1 237 011 111	1.906.193	1 237 013 130	1.206.034HVS	1 237 015 805	1.230.139	2 207 013 005	1.206.071
1 237 011 114	1.906.233	1 237 013 138	1.206.034HVS	1 237 015 806	1.230.140	2 207 013 007	1.206.064
1 237 011 119	1.906.234	1 237 013 139	1.206.062	1 237 015 808	1.215.055	2 207 110 007	1.206.071
1 237 011 122	1.906.223	1 237 013 140	1.206.034HVS	1 237 015 821	1.242.054	2 207 330 011	1.106.030
1 237 011 124	1.906.223	1 237 013 143	1.206.062	1 237 015 848	1.215.103	2 207 330 041	1.106.180
1 237 013 000	1.206.047	1 237 013 144	1.206.034HVS	1 237 031 093	1.906.244	2 207 330 050	1.106.180
1 237 013 001	1.206.047	1 237 013 145	1.206.034HVS	1 237 031 123	1.906.153 ^S	9 220 332 702	1.970.101D
1 237 013 002	1.206.034HVS	1 237 013 146	1.206.049HVS	1 237 031 180	1.906.233	9 230 087 016	1.906.153 ^N
1 237 013 003	1.206.047	1 237 013 147	1.206.049HVS	1 237 031 296	1.906.223	9 230 087 019	1.906.153 ^N
1 237 013 006	1.206.029HV	1 237 013 150	1.206.034HVS	1 237 031 339	1.906.244	9 230 087 030	1.906.153 ^N
1 237 013 007	1.206.029HV	1 237 013 151	1.206.049HVS	1 237 330 035	1.106.030	9 230 087 036	1.906.153 ^N
1 237 013 008	1.206.021	1 237 013 152	1.206.049HVS	1 237 330 036	1.106.030	9 230 087 038	1.906.153 ^N
1 237 013 009	1.206.029HV	1 237 013 157	1.206.049HVS	1 237 330 039	1.106.030	9 230 087 039	1.906.153 ^N
1 237 013 010	1.206.029HV	1 237 013 158	1.206.049HVS	1 237 330 307	1.106.212	9 230 087 044	1.906.153 ^N
1 237 013 025	1.206.029HV	1 237 013 300	1.215.106	1 237 330 310	1.106.196	9 230 087 046	1.906.153 ^N
1 237 013 027	1.206.021	1 237 013 302	1.215.106	1 237 330 316	1.106.195	9 230 087 056	1.906.153 ^N
1 237 013 029	1.206.029HV	1 237 013 305	1.215.105	1 237 330 340	1.106.212	9 230 087 062	1.906.153 ^N
1 237 013 039	1.206.032HV	1 237 013 307	1.236.045	1 237 330 348	1.106.257	9 230 087 065	1.906.153 ^N
1 237 013 041	1.206.021	1 237 013 600	1.222.056HV	1 237 330 353	1.106.212	9 231 064 336	1.406.131
1 237 013 042	1.206.021	1 237 013 710	1.206.029HV	1 237 330 801	1.115.023	9 231 064 346	1.406.131
1 237 013 044	1.206.034HVS	1 237 013 712	1.206.034HVS	1 237 330 803	1.115.023	9 231 065 501	1.306.112
1 237 013 045	1.206.029HV	1 237 013 713	1.230.120	1 237 330 805	1.115.034	9 231 065 502	1.306.072
1 237 013 047	1.206.021	1 237 013 714	1.230.132	1 237 330 806	1.115.034	9 231 065 503	1.306.072
1 237 013 049	1.206.029HV	1 237 013 715	1.219.043HV	1 237 330 810	1.142.056	9 231 065 504	1.306.072
1 237 013 051	1.206.034HVS	1 237 013 717	1.215.061	1 237 330 811	1.142.056	9 231 065 506	1.306.112
1 237 013 052	1.206.049HVS	1 237 013 718	1.215.064	1 237 330 828	1.130.117	9 231 065 516	1.306.112
1 237 013 053	1.206.029HV	1 237 013 719	1.228.083MHV	1 987 231 000	1.213.011HV	9 231 065 529	1.306.244
1 237 013 055	1.206.032HV	1 237 013 720	1.215.056	1 987 231 001	1.213.011HV	9 231 067 027	1.206.034HVS
1 237 013 056	1.206.029HV	1 237 013 724	1.219.044HV	1 987 231 004	1.222.056HV	9 231 081 319	1.306.098
1 237 013 057	1.206.040	1 237 013 728	1.219.043HV	1 987 231 006	1.231.084	9 231 081 413	1.306.098
1 237 013 059	1.206.049HVS	1 237 013 802	1.212.055HVS	1 987 231 015	1.231.084	9 231 081 628	1.406.045R
1 237 013 060	1.206.047	1 237 013 803	1.230.120	1 987 231 020	1.213.022HV	9 231 081 678	1.306.098
1 237 013 061	1.206.049HVS	1 237 013 804	1.230.132	1 987 231 032	1.231.084	9 231 086 370	1.306.094
1 237 013 062	1.206.049HVS	1 237 013 805	1.230.139	1 987 231 033	1.231.085	9 231 087 552	1.906.160
1 237 013 063	1.206.034HVS	1 237 013 806	1.230.140	1 987 231 900	1.213.011HV	9 231 087 677	1.406.121R
1 237 013 065	1.206.034HVS	1 237 013 808	1.215.055	1 987 231 904	1.222.056HV	9 231 140 245	1.306.079
1 237 013 066	1.206.034HVS	1 237 013 809	1.215.061	1 987 231 915	1.231.084	9 231 337 005	1.217.024
1 237 013 068	1.206.040	1 237 013 811	1.215.064	1 987 231 932	1.231.084	9 231 337 005 706	1.217.024
1 237 013 074	1.206.034HVS	1 237 013 812	1.215.067	1 987 231 933	1.231.085	9 231 337 041	1.230.132
1 237 013 075	1.206.062	1 237 013 814	1.215.111U	1 987 233 003	1.331.003/00	9 231 337 072	1.217.024
1 237 013 077	1.206.034HVS	1 237 013 819	1.228.083MHV	1 987 233 008	1.322.003	9 231 337 072 706	1.217.024

BOSCH

9 231 337 074	1.217.026
9 232 081 442	1.306.094
9 232 337 354	1.117.097
9 232 337 354 706	1.117.097
9 233 335 511	1.317.014
F 000 ZSO 001	1.970.192
F 000 ZSO 111	1.970.140
F 000 ZSO 206	1.970.416^A
F 000 ZSO 207	1.970.416

CHEVROLET

10495411	1.412.098
25183557	1.499.249
25186687	1.970.545
25195107	1.970.547
25198623	1.970.547
25200553	1.970.547
55561655	1.970.545
55575499	1.970.547
55577898	1.970.547
55579072	1.970.547
55584404	1.970.545
93740920	1.331.139
93740921	1.431.131
93740943	1.331.172
93740944	1.431.139
95528319	1.970.547
96190263	1.501.677
96211948	1.501.680
96256433	1.501.634
96288956	1.499.006
96291306	1.499.007
96305387	1.501.731
96342284	1.501.730
96450249	1.501.509
96453420	1.970.585
96460220	1.501.677
96460221	1.499.247
96460222	1.499.247
96460223	1.499.247
96460224	1.499.247
96476983	1.970.545
96497773	1.501.680
96518123	1.501.634
96651945	1.499.249
96984145	1.499.249

CHRYSLER

4773841	1.501.508
4797685	1.501.343
4883233	1.501.507
4883233AB	1.501.507
5018394AE	1.501.511
5019593AA	1.501.345
5033216AC	1.501.719
5033217AC	1.501.719
5033218AC	1.501.719
5033219AC	1.501.719
5033233AB	1.501.511
5033233AB	1.501.990
5033266AA	1.501.990
5098138AA	1.970.417
5226535	1.410.179
55208723	1.970.423
55214926	1.970.549
55229959	1.970.549
56 027 075	1.419.092
83 300 121	1.315.059
83 300 122	1.315.054
83 300 123	1.315.065
83 300 124	1.315.063
83 300 126	1.415.091

CHRYSLER

83 300 127	1.415.088
83 300 128	1.415.094
83 300 129	1.415.097
83 300 133	1.215.086
83 300 134	1.215.055
MD338 624	1.501.764
MD61 9050	1.331.161
MD611 459	1.431.109
MD611 526	1.331.116
MD611 757	1.431.109
SPW07685AA	1.501.343
T0267693	1.406.119R
T0267694	1.306.236^A
T1020357	1.415.088
T1031135	1.970.107
T1407311	1.315.059
T1407311	1.415.088

CITROËN

16 075 767 80	1.970.505
16 115 478 80	1.970.459
2L 548 622 2Y	1.430.042R
2L 548 635 8B	1.130.117
54 283 90	1.415.083R
54 283 90P	1.415.083R
54 463 39M	1.215.056
54 524 17C	1.115.023
54 524 19Z	1.315.045
54 524 21	1.415.091
54 524 21W	1.415.091
54 524 22G	1.215.055
54 656 04	1.315.059
54 656 04P	1.315.059
54 747 41	1.215.064
54 862 20	1.130.117
54 862 21M	1.230.142
54 862 24	1.330.090
55 081 70	1.415.091
5900 F1	1.915.019^N
5900 F6	1.915.019^N
5900 F7	1.915.019^N
5900 F8	1.915.019^N
5900 F9	1.915.019^N
5900 G2	1.915.019^N
5900 H5	1.915.019^N
5900 J3	1.915.019^N
5900 K1	1.915.019^N
5900 K7	1.915.019^N
5900 K8	1.915.019^N
5904 K3	1.915.017
5904 K8	1.915.019
5937 42	1.406.119R
5940 57	1.315.087
5941 47	1.306.252^A
5945 48	1.965.005
5945 51	1.965.034
5967 K9	1.500.491
5967 L0	1.500.674
5967 L1	1.500.494
5967 L6	1.500.494
5967 L7	1.500.674
5967 L8	1.500.494
5967 L9	1.501.025
5967 N1	1.500.494
5967 N2	1.500.655
5967 N6	1.501.374
5967 N7	1.500.674
5967 N9	1.501.376
5967 P1	1.501.374
5970 42	1.970.106
5970 43	1.970.105
5970 45	1.970.155
5970 48	1.970.188

CITROËN

5970 49	1.970.189
5970 53	1.970.168
5970 60	1.970.188
5970 64	1.970.475
5970 70	1.970.188
5970 72	1.970.403
5970 74	1.970.403
5970 75	1.970.408
5970 78	1.970.405
5970 79	1.970.405
5970 80	1.970.407
5970 84	1.970.509
5970 85	1.970.483
5970 87	1.970.476
5970 88	1.970.461
5970 90	1.970.405
5970 91	1.970.475
5970 96	1.970.497
5970 97	1.970.405
5970 98	1.970.408
5970 99	1.970.407
5970 A0	1.970.476
5970 A5	1.970.509
5970 A8	1.970.405
5970 A9	1.970.403
5970 C0	1.970.461
5970 C1	1.970.461
75 520 155	1.315.058
75 524 767	1.315.059
75 531 089	1.130.117
77 002 676 93	1.406.119R
79 015 927 44	1.215.076
79 015 927 83	1.215.103
79 015 937 22	1.415.088
79 015 948 11	1.115.034
8970 98	1.970.408
91 504 912	1.965.005
91 506 338	1.965.005
91 538 999	1.315.077
91 539 003	1.315.078^M
91 541 615	1.315.078^M
94 059 373 08	1.415.096R
94 059 413 28	1.306.124
95 534 910	1.315.054
95 534 913	1.215.086
95 538 865	1.430.042R
95 539 165	1.315.058
95 539 596	1.415.083R
95 547 732	1.115.034
95 559 241	1.415.094
95 602 185	1.406.056R
95 610 822	1.315.059
95 610 822	1.415.091
95 611 732	1.415.094
95 618 396	1.315.067
95 619 491	1.306.241
95 624 952	1.915.017
95 624 985	1.315.074
95 624 987	1.915.019
95 643 723	1.915.019
95 651 019	1.415.102R
95 659 596	1.500.747
95 659 654	1.306.241^A
96 001 914	1.915.019^N
96 002 856	1.915.019^N
96 004 266	1.915.019^N
96 010 513	1.970.105
96 014 242	1.915.019^N
96 020 587	1.915.019^N
96 035 284	1.970.155
96 038 183	1.315.078^M
96 038 185	1.315.078^M
96 039 183	1.915.019^N
96 048 070	1.965.034
96 054 877	1.306.252
96 062 288	1.970.189

CITROËN

96 070 995	1.500.491
96 074 054	1.970.188
96 074 954	1.315.077
96 088 851	1.500.494
96 094 933	1.500.674
96 099 747	1.500.674
96 099 749	1.500.494
96 161 266	1.500.494
96 228 897	1.970.188
96 246 755 80	1.970.403
96 281 585 80	1.970.403
96 341 314 80	1.970.408
96 351 725 80	1.970.509
96 358 647 80	1.970.405
96 358 649 80	1.970.405
96 363 378 80	1.970.407
96 453 331 80	1.970.509
96 517 106 80	1.970.483
96 548 144 80	1.970.405
96 566 957 80	1.970.476
96 582 279 80	1.970.476
96 712 145 80	1.970.609
96 753 909 80	1.970.620
97 522 876	1.965.005
97 530 125	1.965.005
97 530 780	1.970.105
97 531 206	1.970.106
97 531 922	1.965.005
97 532 831	1.965.005
97 534 955	1.500.747
98 067 027 80	1.970.475
98 078 418 80	1.970.475
AZ 211-17	1.215.064
DM 211-15	1.315.049
DM 211-16	1.415.091
DM 211-17	1.215.055
DM 212 08B	1.970.101D
DM21 18	1.115.023
DX 211-202A	1.115.023
DX 211-215A	1.315.045
GX 061 800 1A	1.315.045
GX 061 850 1A	1.115.034

CUPRA

04E 905 110 K	1.970.599
04E 905 110 P	1.970.599
06H 905 110 L	1.970.636
06L 905 110 K	1.970.636

DACIA

0.0323_GA	1.115.023
22 43 324 28R	1.970.613
22 43 325 97R	1.970.432
22 43 327 34R	1.970.552
22 43 335 29R	1.970.432
22 43 361 34R	1.970.596
22 44 042 52R	1.499.252
60 01 543 604	1.970.596
77 00 107 177	1.970.432
77 00 113 357	1.970.432
77 00 273 826	1.499.244
77 00 274 008	1.970.596
82 00 208 611	1.970.432
82 00 380 267	1.970.432
82 00 405 098	1.970.432
82 00 506 297	1.499.244
82 00 568 671	1.970.432
82 00 702 693	1.970.518
82 00 713 680	1.499.246
82 00 765 882	1.970.432
82 00 943 801	1.499.252

DAEWOO

0001587003	1.970.316
0001587503	1.970.316
10467543	1.312.075
10495411	1.412.098
10496278	1.312.075
329010	1.331.172
329013	1.431.139
33321-78B40-000	1.331.139
93740920	1.331.139
93740921	1.431.131
93740943	1.331.172
93740944	1.431.139
96190263	1.501.677
96211948	1.501.680
96256433	1.501.634
96288956	1.499.006
96291306	1.499.007
96305387	1.501.731
96320818	1.970.219 ^U
96336522	1.970.219 ^U
96342284	1.501.730
96450249	1.501.509
96453420	1.970.585
96460220	1.501.677
96497773	1.501.680
96518123	1.501.634
NP1149	1.501.433
NP1332	1.501.942
TD200C01001	1.431.131
TS100C00601	1.331.139

DAF

22 12 12	1.206.029HV
22 45 64	1.206.034HVS
22 45 66	1.406.021R
22 48 85	1.415.091
22 48 86	1.215.055
22 48 87	1.115.023
22 48 88	1.315.049
52 84 20	1.406.018R
57 32 24 887	1.115.023

DAIHATSU

02935-00200	1.213.011HV
19101-1516	1.313.262
19101-15160-000	1.313.262
19101-2507	1.313.093
19101-25070-000	1.313.093
19101-87103-000	1.313.258
19101-87105-000	1.313.258
19101-87207-000	1.313.128
19101-87301	1.322.003
19101-87601-000	1.313.257
19101-87703	1.313.094
19101-87703-000	1.313.094
19102-26150-000	1.413.014
19102-33012-000	1.413.014
19102-38210-000	1.413.027
19102-87101-000	1.413.028
19102-87102-000	1.413.028
19102-87204-000	1.413.014
19102-87206-000	1.413.030
19102-87207-000	1.413.034
19102-87701-000	1.413.014
19102-87703-000	1.413.029
19102-87704-000	1.413.030
19102-87705-000	1.413.029
19103-87204-000	1.213.022HV
19145-26060-000	1.213.011HV
19145-87203-000	1.213.011HV
19145-87204-000	1.213.022HV

DAIHATSU

19145-87205-000	1.213.022HV
19145-87206-000	1.213.011HV
19145-87301	1.222.056HV
19145-87701	1.213.011HV
19145-87701-000	1.213.011HV
19901-87186-000	1.501.732
19901-87196-000	1.501.732
19901-87B87-000	1.501.436
90048-52072-000	1.970.252
90048-52095-000	1.970.252
90048-66019-000	1.501.732
90919-02257	1.970.537
90919-02262	1.970.461
99329-35902	1.213.011HV

DELPHI

1104082	1.970.450
1104091	1.970.483
19005212	1.970.399
19005267	1.970.487
19005293	1.970.475
19005316	1.970.607
19005358	1.970.545
19005362	1.970.547
28114820	1.970.475
28211913	1.970.609
28276583	1.970.620
28326927	1.970.545
28372862	1.970.475
28400714	1.970.626
CE20009-12B1	1.970.450
CE20014-12B1	1.970.432
CE20042-12B1	1.970.532
CE20044-12B1	1.970.532
GN10210-12B1	1.970.475
GN10236-12B1	1.970.429
GN10314-12B1	1.970.461
GN10571-12B1	1.970.475
GN10572-12B1	1.970.475

DENSO

029 120-135	1.313.099
029 120-139	1.313.114
029 120-152	1.313.119
029 120-167	1.313.099
029 120-224	1.313.278
029 120-227	1.313.119
029 120-234	1.313.278
029 120-253	1.313.257
029 120-255	1.313.099
029 120-256	1.313.099
029 120-263	1.313.251
029 120-265	1.313.248
029 120-273	1.313.278
029 120-282	1.313.252
029 120-321	1.313.265
029 120-333	1.313.275
029 120-340	1.313.267
029 120-357	1.313.272
029 120-366	1.313.273
029120-0600	1.313.093
029120-0601	1.313.093
029120-0741	1.313.092
029120-0760	1.313.094
029120-1020	1.313.099
029120-1080	1.313.102
029120-1290	1.313.113
029120-1390	1.313.114
029120-1410	1.313.262
029120-1480	1.313.117
029120-1510	1.313.122

DENSO

029120-1520	1.313.119
029120-1540	1.313.107
029120-1600	1.313.240
029120-1700	1.313.241
029120-1720	1.313.128
029120-1850	1.313.123
029120-2120	1.313.278
029120-2130	1.313.262
029120-2291	1.313.245
029120-2311	1.313.093
029120-2590	1.313.123
029120-2610	1.313.258
029180-0240	1.413.014
029180-0241	1.413.014
029180-0340	1.413.014
029180-0430	1.413.014
029180-0580	1.413.014
029180-0660	1.413.027
029180-0910	1.413.029
029180-0920	1.413.028
029180-0921	1.413.028
029180-0930	1.413.029
029180-0990	1.413.030
029180-1130	1.413.030
029180-1230	1.413.029
029180-1260	1.413.030
029180-1280	1.413.034
029180-1300	1.413.034
029180-1310	1.413.028
029180-1391	1.413.028
029350-0200	1.213.011HV
029350-0270	1.213.011HV
029350-0550	1.213.022HV
029350-0650	1.213.011HV
029350-0660	1.213.022HV
029350-0690	1.213.011HV
029350-0740	1.213.022HV
029350-0820	1.213.022HV
029350-0860	1.213.011HV
029700-5430	1.970.197
029700-6700	1.970.135
029700-6760	1.970.170
029700-6770	1.970.289
029700-6780	1.970.289
029700-6820	1.970.202
029700-7050	1.970.203
029700-7051	1.970.203 ^U
029700-7180	1.970.170
029700-7301	1.970.322
029700-7531	1.970.289
029700-7700	1.970.2855
029700-7910	1.970.170
029700-8240	1.970.432
029700-8291	1.970.432
099 700-061	1.970.457
099 700-072	1.970.457
099 700-101	1.970.522
099 700-114	1.970.457

DS

5970 91	1.970.475
96 712 145 80	1.970.609
96 753 909 80	1.970.620

DUCATI

11 30 26	1.106.030
31 30 26	1.106.030
331.04.0290	1.106.030
1129.26. 00	1.106.030
1129.26. 90	1.106.030
1130.26. 00	1.106.030

DUCATI

1130.26. 90	1.106.030
3011.30. 26	1.106.030
4011.29.2600	1.106.030
4011.29.2690	1.106.030
4011.30.2600	1.106.030
4011.30.2690	1.106.030

EFI AUTOMOTIVE

1420	1.500.920
1429	1.499.244
1431	1.501.492
1439	1.499.049
1443	1.501.681
1514	1.970.419
151401	1.970.419
151408	1.970.518
1543	1.970.403
154301	1.970.403
154302	1.970.405
154303	1.970.405
155001	1.970.314
155002	1.970.386
155003	1.970.398
155004	1.970.316
155006	1.970.397
155009	1.970.480
155010	1.970.532
155013	1.970.376
155014	1.970.378
155015	1.970.196
155016	1.970.596
155017	1.970.146
155018	1.970.355
155019	1.970.356
155020	1.970.442
155022	1.970.400
155022	1.970.400
155025	1.970.275
155026	1.990.414
155026	1.990.414
155027	1.970.408
155027	1.970.408
155028	1.970.459
155028	1.970.459
155029	1.970.400
155031	1.970.509
155032	1.970.407
155033	1.970.188
155034	1.970.189
155038	1.970.508
155039	1.970.450
155039	1.970.450
155040	1.970.476
155041	1.970.476
155045	1.970.398
155046	1.970.507
155049	1.970.475
155050	1.970.365
155051	1.970.345
155054	1.970.434
155056	1.970.108
155057	1.970.272
155058	1.970.148
155059	1.970.155
155060	1.970.228
155061	1.970.107
155062	1.970.341
155064	1.970.140
155065	1.970.158
155066	1.970.214
155067	1.970.374
155068	1.970.394

FIAT		FIAT		FIAT		FORD	
7700267693	1.406.119R	9913860	1.330.069	9937592	1.315.049	1 006 346	1.501.630
7700267694	1.306.236	9913862	1.230.132	9937709	1.215.105	1 006 347	1.501.630
7703382	1.500.700	9915391	1.330.076	9937715	1.115.034	1 006 348	1.501.630
7716092	1.500.815	9915910	1.430.037	9937716	1.315.054	1 006 349	1.501.630
7716094	1.500.808	9916116	1.315.049	9937729	1.430.037R	1 008 886	1.970.364
7730973	1.500.692	9916117	1.415.083R	9937767	1.430.054R	1 008 887	1.970.364
7735100	1.500.613	9916118	1.215.055	9938166	1.115.039	1 00E-12116-A	1.328.070
7735397	1.500.655	9916593	1.430.037R	9938173	1.430.055R	1 00E-12116-B	1.328.070
7742005	1.500.694	9917213	1.430.037R	9938268	1.130.127	1 018 119	1.501.639
7742689	1.500.456	9918269	1.246.071	9938269	1.130.128	1 018 131	1.501.639
7745367	1.500.887	9918275	1.347.025	9938272	1.330.098	1 018 139	1.970.364
7746151	1.970.148	9919037	1.315.059	9938273	1.330.101	1 018 140	1.970.364
7746152	1.970.108	9919038	1.215.056	9938274	1.330.104	1 027 283	1.970.169
7746153	1.970.158	9919040	1.215.056	9938276	1.230.146M	1 037 292	1.501.007
7746154	1.970.108	9919346	1.230.139	9938359	1.330.098	1 037 293	1.501.007
7746226	1.990.303	9919348	1.430.037	9938360	1.330.104	1 037 294	1.501.007
7749930	1.500.650	9919623	1.230.140	9938573	1.215.122	1 037 295	1.501.007
7749930	1.500.692	9919627	1.430.036R	9938953	1.906.153	1 052 493	1.501.624
7760523	1.501.363	9919628	1.330.081	9939707	1.406.023R	1 053 904	1.970.532 ^{*1}
7776810	1.500.616	9919723	1.230.140	9939762	1.930.161/1	1 053 905	1.501.624
7785350	1.500.888	9920029	1.315.045	9939786	1.930.180M	1 053 907	1.501.624
7787458	1.500.889	9920036	1.230.139	9939787	1.330.101	1 053 908	1.501.624
7789346	1.970.345	9920580	1.430.036R	9939788	1.930.176M	1 066 102	1.970.532 ^{*1}
7980793	1.230.139	9920581	1.330.081	9939789	1.330.109	1 067 601	1.970.532
82205020	1.230.127	9921039	1.215.056	9939790	1.430.060	1 071 985	1.501.625
82272761	1.230.139	9921198	1.315.045	9940095	1.965.020	1 071 986	1.501.625
82288614	1.406.025R	9921476	1.430.037R	9940302	1.415.094	1 071 987	1.501.625
82289883	1.206.049HVS	9921508	1.430.037	9940428	1.430.057R	1 071 988	1.501.625
82301158	1.430.037R	9921509	1.330.082	9940429	1.930.177/1	1 075 786	1.970.532
82301920	1.306.079	9922446	1.430.036R	9940437	1.406.061R	1 086 377	1.501.568
82305235	1.206.034HVS	9923115	1.430.037	9940569	1.230.149M	1 086 378	1.501.568
82305237	1.306.079	9924187	1.430.042R	9940656	1.330.101	1 086 379	1.501.568
82309214	1.430.041	9924316	1.330.086	9941231	1.930.176M	1 086 380	1.501.568
82316498	1.406.025R	9924394	1.430.041	9941693	1.930.176M	1 089 980	1.501.568
82345471	1.430.037R	9924654	1.430.037	9941720	1.930.180M	1 092 379	1.501.624
82348987	1.306.079	9924733	1.415.083R	9941721	1.315.080	1 094 676	1.501.691
82357741	1.406.115R	9925257	1.230.139	9942040	1.965.029	1 094 677	1.501.691
82361894	1.306.079	9925993	1.330.086	9942108	1.249.350	1 094 679	1.501.691
82361914	1.330.101	9926748	1.430.040	9943506	1.430.059	1 094 680	1.501.691
82361915	1.430.047R	9927624	1.206.029HV	9944407	1.430.060	1 094 681	1.501.691
82368100	1.330.093	9927962	1.406.025R	9944576	1.330.114	1 094 682	1.501.691
8660	1.230.140	9927967	1.406.025R	9944630	1.330.098	1 095 589	1.501.568
8661	1.230.139	9928245	1.130.117	9944668	1.330.115	1 095 591	1.501.568
9405937478	1.415.096R	9928247	1.430.042R	9944794	1.330.101	1 095 592	1.501.568
9463264180	1.970.408	9928250	1.330.090	9946355	1.330.114	1 107 701	1.501.630
9467511580	1.970.405	9928255	1.230.142	9946356	1.430.060	1 110 740	1.501.625
9564372380	1.915.019	9929182	1.230.139	9947326	1.330.115	1 110 741	1.501.625
9567469880	1.315.087	9929187	1.430.042R	9950519	1.330.115	1 110 742	1.501.625
9607405480	1.970.188	9929188	1.230.142	AXE2055	1.206.049HVS	1 110 743	1.501.625
9609493380	1.500.674	9934266	1.115.023	AXE2056	1.406.025R	1 111 212	1.970.532
9617237080	1.500.494	9934545	1.315.059			1 111 213	1.970.532 ^{*1}
9619064880	1.500.674	9934549	1.315.045			1 111 215	1.501.976
9622889780	1.970.188	9934652	1.306.079			1 111 217	1.501.976
9634131380	1.970.408	9934708	1.415.091			1 111 220	1.501.976
9654347080	1.970.405	9934726	1.430.037R			1 111 221	1.501.976
9753012580	1.965.005	9934727	1.430.037R	7073052/1	1.230.132	1 113 148	1.501.691
9753283180	1.965.005	9934728	1.330.093	7073054/1	1.417.052	1 113 150	1.501.691
9753293180	1.965.005	9934729	1.930.161/1	7073055/1	1.330.069	1 113 152	1.501.691
98080037	1.330.081	9934741	1.430.036R			1 113 154	1.501.691
9808037	1.430.036R	9935150	1.215.101			1 114 743	1.501.624
9902725	1.430.029	9935176	1.315.045			1 114 744	1.501.624
9903324	1.230.120	9935177	1.315.049			1 114 745	1.501.624
9908338	1.330.059	9935782	1.406.026R			1 119 835	1.970.532
9908418	1.430.029	9936014	1.306.079			1 119 840	1.501.614
9909412	1.230.150M	9936023	1.430.047R			1 119 841	1.501.614
9909413	1.230.120	9936027	1.330.098			1 119 842	1.501.614
9909418	1.430.029	9936331	1.930.163/1			1 119 843	1.501.614
9911453	1.230.127	9936677	1.215.106			1 120 169	1.970.435
9911509	1.330.082	9936734	1.115.039			1 120 169	1.970.435
9911552	1.230.120	9936735	1.315.058			1 130 402	1.970.532
9911554	1.230.123	9936807	1.417.052			1 13E-12116-A	1.328.075
9911960	1.430.029	9936814	1.317.016			1 142 546 9	1.406.014R
9912921	1.230.127	9936823	1.217.020			1 142 596 1	1.406.012R
9912922	1.230.127	9936831	1.417.052R			1 142 598 1	1.406.012R
9913856	1.430.037	9936866	1.415.083R			1 142 609	1.501.984
9913857	1.430.037R	9937480	1.415.083R			1 142 610	1.501.984
						1 142 611	1.501.984

FIAT (YV)

7073052/1	1.230.132
7073054/1	1.417.052
7073055/1	1.330.069

FORD

0 267 26	1.419.085	1 119 835	1.970.532
0 267 2617	1.319.083	1 119 840	1.501.614
0 425 469	1.406.014R	1 119 841	1.501.614
0 425 981	1.406.012R	1 119 842	1.501.614
0 464 163	1.206.049HVS	1 119 843	1.501.614
0 548 495	1.206.049HVS	1 120 169	1.970.435
0 623 389	1.319.083	1 130 402	1.970.532
0 710 254	1.306.079	1 13E-12116-A	1.328.075
0 710 255	1.306.076	1 142 546 9	1.406.014R
0 710 256	1.306.072	1 142 596 1	1.406.012R
1 004 427	1.501.619	1 142 598 1	1.406.012R
1 004 430	1.501.619	1 142 609	1.501.984
1 004 431	1.501.619	1 142 610	1.501.984
1 004 432	1.501.619	1 142 611	1.501.984

FORD		FORD		FORD		FORD	
1 142 612	1.501.984	1 626 436	1.501.281	4M5G-12A366-BB	1.970.480	6 189 558	1.501.078
1 144 700 2	1.306.072	1 627 668	1.501.281	4M5G-12A366-BC	1.970.480	6 234 60	1.219.044HV
1 144 706 9	1.306.079	1 628 315	1.319.092	4M5G-12A366-BD	1.970.480	6 383 157	1.970.289
1 151 630 2	1.206.021	1 641 610	1.330.098	4S7G-12029-AA	1.970.481	6 486 345	1.501.007
1 154 411 5	1.206.047	1 641 611	1.430.057R	4S7G-12029-AB	1.970.481	6 486 346	1.501.007
1 154 849 5	1.206.049HVS	1 641 614	1.930.177/1	5 008 193	1.970.299S	6 486 347	1.501.007
1 171 025 4	1.306.079	1 641 810	1.319.092	5 008 196	1.970.170	6 486 348	1.501.007
1 171 025 5	1.306.076	1 643 632	1.319.093	5 014 402	1.319.083	6 489 415	1.970.170
1 171 025 6	1.306.072	1 643 692	1.419.092	5 014 405	1.419.085	6 493 644	1.501.281
1 171 026 8	1.306.072	1 649 067	1.970.135	5 018 844	1.206.049HVS	6 493 645	1.501.281
1 207 832	1.501.691	1 649 200	1.419.094R	5 019 831	1.206.049HVS	6 493 649	1.500.864
1 212 115	1.501.691	1 655 993	1.428.026R	5 021 112	1.406.061R	6 493 650	1.501.281
1 213 032	1.501.691	1 657 033	1.501.007	5 027 482	1.219.044HV	6 493 651	1.501.281
1 213 034	1.501.691	1 657 147	1.501.007	5 027 532	1.406.025R	6 493 655	1.500.864
1 214 215	1.499.208	1 657 149	1.501.007	5 047 437	1.970.480	6 493 656	1.501.281
1 224 925	1.970.480	1 660 332	1.406.121R	5 441 16	1.206.021	6 493 657	1.501.281
1 231 646	1.501.614	1 663 375	1.501.145	5 484 95	1.206.049HVS	6 493 661	1.500.864
1 252 407	1.970.435	1 663 376	1.501.145	6 002 610	1.406.024R	6 493 662	1.501.281
1 255 505	1.501.614	1 665 193	1.319.092	6 075 742	1.406.060R	6 493 663	1.501.281
1 255 507	1.501.614	1 671 690	1.970.423	6 077 429	1.970.169	6 493 666	1.500.864
1 255 509	1.501.614	1 673 468	1.970.435	6 077 487	1.328.083	6 493 667	1.500.864
1 313 549	1.499.208	1 680 402	1.499.242	6 077 549	1.306.109	6 503 279	1.970.135
1 313 550	1.499.208	1 680 403	1.499.242	6 084 817	1.501.078	6 503 280	1.970.135
1 313 551	1.499.208	1 680 404	1.499.242	6 087 381	1.228.089	6 542 391	1.330.101
1 313 552	1.499.208	1 680 405	1.499.242	6 124 108	1.406.061R	6 596 257	1.501.630
1 314 271	1.970.480	1 727 629	1.970.481	6 125 612	1.906.233 ^S	6 596 258	1.501.630
1 317 972	1.970.532	1 754 514	1.970.481	6 133 233	1.501.281	6 596 259	1.501.630
1 319 060	1.499.208	1 760 593	1.970.619	6 134 771	1.406.121R	6 596 260	1.501.630
1 319 061	1.499.208	1 776 803	1.970.619	6 137 397	1.501.281	6 609 875	1.500.864
1 319 062	1.499.208	1 800 554	1.970.623	6 137 398	1.501.281	6 609 876	1.500.864
1 319 063	1.499.208	1 823 596	1.970.481	6 137 399	1.501.281	6 609 877	1.500.864
1 319 788	1.970.532	1 827 901	1.970.619	6 137 400	1.501.281	6 609 878	1.500.864
1 319 929	1.970.532	1 836 729	1.970.623	6 137 406	1.501.281	6 630 365	1.970.170
1 322 402	1.970.480	1 953 279	1.422.070	6 138 918	1.206.049HVS	6 789 823	1.501.630
1 331 283	1.970.435	1 953 281	1.322.046	6 146 328	1.501.281	6 789 824	1.501.630
1 335 369	1.501.625	1 960 394	1.501.789	6 146 423	1.306.235	6 789 825	1.501.630
1 335 371	1.501.625	1 960 491	1.422.102 ^{XC}	6 147 957	1.906.153 ^S	6 789 826	1.501.630
1 335 374	1.501.625	1 961 043	1.322.089	6 149 976	1.501.078	6 823 318	1.970.299
1 335 377	1.501.625	1 961 207	1.501.789	6 152 292	1.501.281	6 828 806	1.501.145
1 350 562	1.970.481	1S7G-12029-AB	1.970.532	6 152 293	1.501.281	6 828 807	1.501.145
1 350 567	1.970.481	1S7G-12029-AC	1.970.532	6 152 294	1.501.281	6 831 197	1.501.007
1 362 718	1.970.435	1S7G-12029-AD	1.970.532	6 153 386	1.328.096	6 831 198	1.501.007
1 371 601	1.970.478	1S7G-12283-AE	1.501.614	6 153 387	1.428.026R	6 831 199	1.500.864
1 444 043	1.419.085	1S7G-12283-AF	1.501.614	6 153 393	1.501.281	6 831 200	1.501.007
1 451 676	1.406.012R	1S7G-12284-AD	1.501.614	6 153 394	1.501.281	6 831 201	1.501.007
1 458 400	1.970.481	1S7G-12284-AE	1.501.614	6 155 949	1.501.078	6 831 202	1.500.864
1 458 944	1.219.043HV	1S7G-12286-AE	1.501.614	6 160 862	1.501.281	6 831 203	1.501.007
1 458 945	1.219.044HV	1S7G-12286-AF	1.501.614	6 161 016	1.501.078	6 831 204	1.501.007
1 459 278	1.970.481	1S7G-12287-AD	1.501.614	6 166 882	1.501.078	6 831 205	1.500.864
1 462 196	1.319.083	1S7G-12287-AE	1.501.614	6 166 884	1.501.078	6 831 206	1.501.007
1 502 365	1.499.242	2S7E-12280-AF	1.499.214	6 166 886	1.501.078	6 831 207	1.501.007
1 502 366	1.499.242	2S7E-12281-AE	1.499.214	6 170 394	1.501.078	6 831 208	1.500.864
1 502 367	1.499.242	3 240 335	1.406.025R	6 170 395	1.501.078	6 860 288	1.970.299
1 502 368	1.499.242	3 240 336	1.306.079	6 170 396	1.501.078	6 860 289	1.970.299S
1 517 813	1.970.532	3 241 724	1.906.153	6 170 397	1.501.078	6 958 305	1.970.170
1 523 785	1.306.081	3 243 330	1.906.153	6 170 844	1.501.078	681F-12107-AA	1.219.043HV
1 523 817	1.306.079	3 395 566	1.431.133	6 171 209	1.501.078	682F-12107-AA	1.219.044HV
1 535 417	1.499.170	3 857 542	1.431.137	6 177 981	1.406.140R	6M21-12029-AA	1.970.435
1 535 419	1.499.170	3 880 181	1.431.133	6 178 534	1.501.281	6M5G-12029-AA	1.970.478
1 535 713	1.970.423	3 891 726	1.431.134	6 178 536	1.501.281	7 094 524	1.501.639
1 568 737	1.206.049HVS	3 898 173	1.331.137	6 182 127	1.306.253	7 094 525	1.501.639
1 578 771	1.970.480	3 993 623	1.431.132	6 182 576	1.906.233 ^{HN}	7 094 526	1.501.639
1 583 458	1.306.081	4 006 232	1.331.132	6 182 577	1.906.233 ^{HN}	7 094 527	1.501.639
1 584 304	1.206.049HVS	4 046 843	1.431.108	6 182 579	1.406.061R	7 388 352	1.501.639
1 584 305	1.206.049HVS	4 132 265	1.331.121	6 182 581	1.428.026R	7 388 353	1.501.639
1 595 255	1.306.109	4 132 292	1.970.366S	6 182 571	1.500.864	7 388 354	1.501.639
1 604 959	1.406.024R	4 367 127	1.499.214	6 182 872	1.500.864	7 388 355	1.501.639
1 606 399	1.406.025R	4 367 128	1.499.214	6 182 904	1.500.864	71HM-12200-AA	1.406.012R
1 612 099	1.406.112R	4 429 613	1.499.214	6 182 905	1.500.864	72HF-12106-AA	1.306.079
1 617 277	1.406.112R	4 434 842	1.499.214	6 183 208	1.501.007	72TF-12106-AA	1.306.081
1 619 343	1.970.532	4 538 936	1.499.214	6 183 213	1.501.007	72TF-12200-AA	1.406.024R
1 626 385	1.501.078	4 641 63	1.206.034HVS	6 183 218	1.501.007	730X-12300B-AA	1.142.056
1 626 386	1.501.078	4M5E-12A366-AA	1.970.480	6 183 223	1.501.007	73TF-12200-AA	1.406.024R
1 626 387	1.501.078	4M5G-12029-ZA	1.970.481	6 184 281	1.501.078	77BF-12107-AA	1.206.049HVS
1 626 388	1.501.078	4M5G-12029-ZB	1.970.481	6 184 283	1.501.078	77BF-12171-AA	1.206.049HVS
1 626 434	1.501.281	4M5G-12A366-BA	1.970.480	6 189 557	1.501.078	77HF-12107-AA	1.206.034HVS

FORD

78MU-12200-A	1.406.025R
78TF-12106-AA	1.306.081
79BB-12024-AA	1.970.169
80SX-12200-AA	1.406.061R
815F-12106-DA	1.328.083
815F-12106-EA	1.306.109
815F-12171-CA	1.228.089
815F-12200-FA	1.406.060R
82HF-12200-AA	1.406.025R
82TF-12200-AA	1.406.024R
84AU-12A09-3A	1.906.153
84SF-12100-BA	1.906.233 ^{NI}
84SF-12106-AA	1.328.096
84SF-12200-AA	1.406.061R
84SF-12200-BA	1.406.121R
84SF-12200-CA	1.428.026R
88SF-12029A-1A	1.970.135
88SF-12029A-2A	1.970.135
88SX-12200-AA	1.406.061R
89SF-12100-JA	1.906.233 ^{NI}
89SF-12200-AA	1.406.061R
89SF-12200-BA	1.406.121R
90TF-12029A-1A	1.970.289
919F-12029-AA	1.970.170
915F-12283-AC	1.500.864
915F-12286-AC	1.500.864
915F-12287-AC	1.500.864
920X-12107-BA	1.219.044HV
928F-12029-CA	1.970.135
928F-12029-CB	1.970.299S
928F-12283-AG	1.501.630
928F-12283-AJ	1.501.630
928F-12284-AG	1.501.630
928F-12284-AJ	1.501.630
928F-12286-AG	1.501.630
928F-12286-AJ	1.501.630
928F-12287-AG	1.501.630
928F-12287-AJ	1.501.630
92GB-12024-AA	1.970.169
938F-12024-DA	1.970.299S
968F-12283-AD	1.501.630
968F-12284-AD	1.501.630
968F-12286-AD	1.501.630
968F-12287-AD	1.501.630
96BF-12024A-1B	1.970.135
96BF-12283-AA	1.501.007
96BF-12284-AA	1.501.007
96BF-12286-AA	1.501.007
96BF-12287-AA	1.501.007
96FB-12257-AB	1.970.364
96MF-12283-BA	1.501.619
96MF-12284-BA	1.501.619
96MF-12286-BA	1.501.619
96MF-12287-BA	1.501.619
988F-12024-AB	1.970.532 ^{NI}
988F-12029-AB	1.970.532
988F-12029-AC	1.970.532
988F-12029-AD	1.970.532
988F-12029-AE	1.970.532
988F-12029-BA	1.970.532
988F-12257-AB	1.970.532 ^{NI}
988F-12283-AA	1.501.624
988F-12284-AA	1.501.624
988F-12286-AA	1.501.624
988F-12286-AB	1.501.624
988F-12287-AA	1.501.624
98MF-12283-AA	1.501.625
98MF-12284-AA	1.501.625
98MF-12286-AA	1.501.625
98MF-12287-AA	1.501.625
9BBF-10029-BA	1.970.532
9S51-12029-AA	1.970.423
9S51-12029-AB	1.970.423
9S51-12286-AA	1.499.170
9S51-12286-BA	1.499.170
A700X-12276-AGA	1.315.058

FORD

A720-X12171-EA	1.222.056HV
A720-X12171-FA	1.215.056
A730-X12171-BA	1.222.056HV
A730X-12300-AKA	1.115.023
A760-X12276-CA	1.330.069
A760-X12276-EA	1.330.069
A770-X12276-CA	1.315.058
A770-X12300-KA	1.115.023
A790-X12200-DA	1.415.091
A790-X12200-RA	1.428.014
A800-X12171-MA	1.215.056
A800-X12276-RA	1.330.069
A810-X12171-RA	1.215.056
A830-X12276-FA	1.315.058
A830-X12300-EA	1.115.023
A96BF-12024-A1B	1.970.364
B657 18100	1.970.366S
C3DF-12171-A	1.219.043HV
C3DZ-12171-A	1.219.043HV
C5AZ-12171-A	1.219.043HV
C6AH-12106-A	1.319.083
C6AH-12171-A	1.219.043HV
C6AH-12200-A	1.419.085
C6CH-12171-A	1.219.044HV
C7AH-12200-A	1.419.085
C7KH-12106-A	1.319.083
CM5G-12029-FA	1.970.481
CM5G-12029-FB	1.970.481
CM5G-12029-FC	1.970.481
CM5G-12A366-BA	1.970.619
CM5G-12A366-CB	1.970.619
D5FZ-12200-A	1.419.085
DIFZ-12106-A	1.306.079
DIFZ-12200-A	1.406.012R
DORY-12200-A	1.419.085
D57G-12A366-BA	1.970.623
D57G-12A366-BB	1.970.623
E32Z-12200-B	1.431.131
E3EE-12106-BA	1.319.092
E3EE-12106-BB	1.319.092
E5FZ-12106-B	1.319.092
E5FZ-12106-C	1.319.092
E6AE-12106-CA	1.319.093
E6AZ-12106-A	1.319.093
E6EE-12200-AA	1.419.092
E6FZ-12200-A	1.419.092
E7EE-12200-DA	1.419.094R
E7GZ-12200-A	1.422.073
E8BZ-12200-A	1.431.108
E8TZ-12029-A	1.970.135
E9DF-12029-AA	1.970.289
E9DZ-12029-A	1.970.289
E9FZ-12106-A	1.319.092
E9SF-12029-AA	1.970.170
E9SZ-12029-A	1.970.170
E9TF-12029-AA	1.970.135
EOTA 12 160	1.228.083MHV
EOTA 12 162 C	1.228.083MHV
EOTA 12 199 C	1.228.083MHV
EOTT-A1220-0A	1.428.007
EOTT-A1220-0B	1.428.007
EOTT-A1220-0C	1.428.007
F0TZ-12029-A	1.970.289
F1CZ-12029-A	1.970.233
F15U-12029-AA	1.970.170
F1VU-12029A-1A	1.970.312
F1VY-12029-A	1.970.312
F220 18V00 A	1.331.121
F32Z-12106-C	1.331.137
F32Z-12200-A	1.431.137
F32Z-12200-B	1.431.131
F32Z-12200-C	1.431.133
F42Z-12200-A	1.431.137
F4BZ-12106-A	1.331.150
F4BZ-12200-A	1.431.132

FORD

F50U-12029-AA	1.970.312
F50U-12029-BA	1.970.312
F50Y-12029-A	1.970.312
F50Y-12029-B	1.970.312
F52Z-12200-A	1.431.134
F52Z-12200-B	1.431.131
F52Z-12200-C	1.431.134
F52Z-12200-D	1.431.132
F57U-12029-AA	1.970.289
F57Z-12029-A	1.970.289
F5RZ-12029-C	1.970.299S
F5SU-12029-AA	1.970.170
F5SU-12029-AB	1.970.170
F82U-12029-AA	1.970.289
FOJY-12200-A	1.431.108
FS01-18V05-A	1.431.137
G 509 193	1.206.047
G 516 302	1.206.021
KK 150 18 V00	1.331.122
KK 150 18 V05	1.431.108
KL01-18V00-A	1.331.137
KL01-18V05-A	1.431.133
V83H-F12200-AA	1.430.057R
V83S-F12200-AA	1.406.112R
V83S-F12200-AB	1.406.112R
V90H-F12106-AA	1.330.101
XM34-12106-AA	1.331.132
XM34-12106-BA	1.331.121
XM34-12200-BA	1.431.108
XM34-4608-CA	1.970.366S
XS6F-12283B-2C	1.501.691
XS6F-12283B-2D	1.499.208
XS6F-12284B-2D	1.501.691
XS6F-12284B-4D	1.499.208
XS6F-12286B-2D	1.501.691
XS6F-12286B-4D	1.499.208
XS6F-12287B-2C	1.501.691
XS6F-12287B-2D	1.501.691
XS6F-12287B-4D	1.499.208
XS8Z-12286-BA	1.501.624
XS8Z-12286-CA	1.501.624
XS8Z-12286-DA	1.501.624
YM21-12029-AA	1.970.435
YM21-12029-AB	1.970.435
YM21-12029-AC	1.970.435
YM21-12029-AD	1.970.435
YM2F-12024-AC	1.970.532 ^{NI}
YM2F-12024-AD	1.970.532
YM2F-12029-AA	1.970.532
YM2F-12029-AB	1.970.532
YS6F-12283A-1A	1.501.625
YS6F-12283-AA	1.501.625
YS6F-12283B-1A	1.499.242
YS6F-12283B-9A	1.499.242
YS6F-12284A-1A	1.501.625
YS6F-12284-AA	1.501.625
YS6F-12284B-1A	1.499.242
YS6F-12284B-9A	1.499.242
YS6F-12286-AA	1.501.625
YS6F-12286B-1A	1.499.242
YS6F-12286B-9A	1.499.242
YS6F-12287A-1A	1.501.625
YS6F-12287-AA	1.501.625
YS6F-12287B-1A	1.499.242
YS6F-12287B-9A	1.499.242

FORD AUSTRALIA

6 958 305	1.970.170
938F-12024-DA	1.970.299S
ADH-2	1.306.244
ADR-3	1.406.131
B 593-18-V00 A	1.331.150

FORD AUSTRALIA

F 590-18-V00	1.322.092
F 590-18-V05	1.422.102
F55U-12029-AA	1.970.170
F55Z-12029-A	1.970.170
K L01-18-V05 A	1.431.133

FORD USA

3 880 181	1.431.133
3 891 726	1.431.134
3 898 173	1.331.137
4 132 292	1.970.366S
5 008 196	1.970.170
6 383 157	1.970.289
6 958 305	1.970.170
CM5G-12A366-BA	1.970.619
F0TZ-12029-A	1.970.289
F55U-12029-AA	1.970.170
F55U-12029-AB	1.970.170
XM34-4608-CA	1.970.366S

GENERAL MOTORS

01 972 927	1.312.073
01 985 771	1.312.074
01 986 109	1.412.096
01 988 515	1.412.097
02 894 488	1.206.034HVS
03 469 032	1.306.081
03 469 033	1.306.080
03 470 026	1.212.055HVS
03 470 056	1.412.093
03 474 227	1.970.109
03 474 232	1.970.341
03 474 282	1.970.341
03 474 283	1.970.140
03 479 003	1.312.066
06 682 671	1.406.012R
08 983 490	1.206.034HVS
09 117 892	1.501.904
09 117 893	1.501.904
09 117 894	1.501.904
09 117 895	1.501.904
09 119 169	1.501.506
1 104 082	1.970.450
1 104 091	1.970.483
1 972 927	1.312.073
1 977 958	1.965.025
1 978 503	1.912.010
1 979 107	1.965.025
1 979 511	1.912.011
1 979 571	1.965.025
1 985 342	1.965.025
1 985 771	1.312.074
1 986 109	1.412.096
1 988 515	1.412.097
10 457 153	1.312.075
10 458 316	1.970.450
10 467 543	1.312.075
10 469 006	1.412.100
10 482 824	1.965.025
10 496 278	1.312.075
12 338 891	1.413.027
12 635 672	1.970.631
12 670 053	1.970.631
12 697 989	1.970.631
16 140 049	1.965.025
16 158 829	1.965.025
19 005 212	1.970.399
24 420 584	1.970.400
25 183 557	1.499.249
25 186 687	1.970.545
25 195 107	1.970.547

GENERAL MOTORS		GENERAL MOTORS		GENERAL MOTORS		GENERAL MOTORS	
25 198 623	1.970.547	7 992 341	1.230.139	90 114 107	1.406.025R	90 518 760	1.501.559
3 470 026	1.212.055HVS	7 992 344	1.206.062	90 114 676	1.965.004	90 518 761	1.501.559
3 470 056	1.412.093	7 992 346	1.215.076	90 140 187	1.965.004	90 536 194	1.970.508
3 470 061	1.312.066	7 992 353	1.115.034	90 141 495	1.406.055R	90 540 398	1.415.103R
3 470 093	1.412.093R	7 992 359	1.115.034	90 141 911	1.406.056R	90 542 968	1.501.529
3 470 391	1.412.093R	7 992 396	1.322.003	90 230 573	1.406.127R	90 543 059	1.970.398
3 474 221	1.970.111	7 992 398	1.306.081	90 230 575	1.306.240 ^{RA}	90 543 253	1.970.400
3 474 227	1.970.109	7 992 610	1.331.003/00	90 240 252	1.970.194	90 543 259	1.501.559
3 474 283	1.970.140	7 992 617	1.315.058	90 243 618	1.965.036 ^{RI}	90 543 260	1.501.559
3 474 600	1.115.023	7 992 618	1.347.025	90 277 970	1.970.191	90 543 261	1.501.559
3 479 003	1.312.066	7 992 619	1.306.092	90 295 499	1.965.005	90 543 262	1.501.559
3 639 500	1.970.609	7 992 630	1.406.024R	90 297 423	1.501.942	91 103 092	1.406.061R
3 639 845	1.970.620	7 992 632	1.430.037	90 297 426	1.306.251	91 125 557	1.413.030
3 648 847	1.970.475	7 992 633	1.430.037R	90 297 570	1.500.514	91 159 920	1.970.432
30 584 237	1.970.192	7 992 636	1.431.023	90 336 536	1.306.257 ^{RA}	91 159 996	1.970.432
55 561 655	1.970.545	7 992 638	1.406.027R	90 337 744	1.499.195	91 172 825	1.431.136
55 573 735	1.970.547	7 992 639	1.415.088R	90 337 744	1.499.199	92 061 881	1.501.947
55 575 499	1.970.547	7 992 640	1.406.014R	90 346 324	1.928.202 ^{RI}	92 061 882	1.501.947
55 577 898	1.970.547	7 992 645	1.206.040	90 348 450	1.306.080	92 061 883	1.501.947
55 579 072	1.970.547	7 992 646	1.215.111U	90 349 877	1.428.028R	92 061 884	1.501.947
55 584 404	1.970.545	7 992 648	1.206.034HVS	90 349 878	1.328.099	93 150 074	1.230.142
7 406 087	1.306.072	7 992 650	1.246.071	90 350 021	1.970.192	93 150 077	1.215.086
7 426 989	1.206.029HV	7 992 653	1.215.064	90 350 555	1.500.527	93 150 082	1.106.196
7 992 026	1.228.083MHV	7 992 654	1.206.029HV	90 350 560	1.500.956	93 150 083	1.106.195
7 992 027	1.219.043HV	7 992 655	1.206.049HVS	90 350 748	1.306.080 ^{RA}	93 150 084	1.130.117
7 992 201	1.228.083MHV	7 992 658	1.206.047	90 350 765	1.306.249	93 150 091	1.330.090
7 992 202	1.219.044HV	7 992 663	1.206.049HVS	90 350 988	1.306.256	93 150 093	1.317.014
7 992 205	1.328.075	7 992 668	1.215.056	90 350 997	1.328.100	93 150 098	1.306.090
7 992 206	1.328.070	7 992 680	1.142.056	90 360 314	1.965.036 ^{RI}	93 150 099	1.406.067R
7 992 207	1.319.083	7 992 850	1.142.056	90 360 315	1.965.036 ^{RI}	93 150 102	1.406.034R
7 992 214	1.428.006	7 992 852	1.142.056	90 369 031	1.306.258	93 150 104	1.415.088
7 992 216	1.428.007	7 992 857	1.315.058	90 369 758	1.500.513	93 150 117	1.115.034
7 992 217	1.419.085	7 992 859	1.306.072	90 376 979	1.415.103R	93 150 118	1.106.212
7 992 219	1.206.047	7 992 865	1.306.079	90 384 308	1.500.688	93 150 120	1.430.042R
7 992 221	1.206.021	7 992 874	1.430.054R	90 384 310	1.500.688	93 150 124	1.115.034
7 992 222	1.206.032HV	7 992 878	1.406.018R	90 398 282	1.500.514	93 150 126	1.306.093
7 992 224	1.206.034HVS	7 992 883	1.406.018R	90 398 586	1.500.513	93 150 134	1.415.088R
7 992 226	1.206.040	7 992 887	1.406.014R	90 424 480	1.970.507	93 150 378	1.306.079
7 992 227	1.215.055	7 992 888	1.406.021R	90 442 011	1.315.084	93 150 379	1.315.058
7 992 228	1.215.061	7 992 892	1.415.083R	90 442 051	1.500.514	93 150 380	1.315.059
7 992 230	1.230.120	7 992 896	1.430.029	90 442 064	1.500.527	93 150 385	1.330.076
7 992 232	1.230.132	7 992 951	1.213.011HV	90 442 356	1.406.127R	93 150 392	1.306.062
7 992 234	1.242.054	7 992 953	1.230.132	90 442 358	1.306.257 ^{RA}	93 150 393	1.306.076
7 992 236	1.206.049HVS	7 992 957	1.206.034HVS	90 442 404	1.500.634	93 150 396	1.430.036R
7 992 237	1.206.034HVS	7 992 978	1.330.086	90 442 405	1.500.514	93 150 398	1.430.041
7 992 238	1.215.111U	7 992 979	1.306.081	90 442 406	1.501.237	93 150 399	1.430.042R
7 992 253	1.142.056	7 992 982	1.315.059	90 442 410	1.501.237	93 150 413	1.206.029HV
7 992 265	1.306.079	7 992 984	1.328.078	90 442 448	1.500.513	93 150 415	1.206.049HVS
7 992 266	1.306.072	7 992 985	1.406.023R	90 443 584	1.500.688	93 150 418	1.206.049HVS
7 992 269	1.306.076	7 992 986	1.406.026R	90 443 687	1.500.688	93 150 421	1.231.084
7 992 271	1.315.049	7 992 988	1.413.014	90 443 690	1.501.237	93 150 455	1.115.039
7 992 272	1.315.041	7 992 994	1.431.023	90 443 691	1.501.237	93 150 461	1.330.069
7 992 274	1.330.059	7 992 996	1.428.012	90 443 692	1.500.689	93 150 580	1.206.034HVS
7 992 275	1.330.069	82 044 5	1.412.090	90 443 693	1.500.689	93 150 581	1.206.049HVS
7 992 279	1.342.043	9 119 567	1.970.508	90 443 694	1.500.689	93 150 584	1.231.084
7 992 280	1.330.081	9 193 022	1.501.506	90 443 900	1.970.273	93 150 586	1.106.212
7 992 281	1.306.080	9 198 834	1.970.507	90 449 673	1.499.195	93 150 645	1.415.089R
7 992 284	1.406.012R	9 300 152	1.406.045R	90 449 674	1.499.195	93 150 904	1.213.022HV
7 992 285	1.406.012R	9 977 002	1.206.029HV	90 449 675	1.499.195	93 150 906	1.306.099
7 992 286	1.406.014R	9 977 007	1.206.029HV	90 449 676	1.499.195	93 150 907	1.330.093
7 992 289	1.406.018R	9 977 008	1.206.029HV	90 449 739	1.970.140	93 150 911	1.406.116R
7 992 290	1.406.021R	9 977 032	1.413.014	90 449 740	1.970.341	93 161 188	1.970.432
7 992 291	1.415.091	9 977 034	1.406.025R	90 458 250	1.970.272	93 161 948	1.970.432
7 992 292	1.415.081	90 006 499	1.965.034	90 486 611	1.500.634	93 176 701	1.501.904
7 992 296	1.430.029	90 006 547	1.406.056R	90 486 612	1.500.634	93 177 212	1.970.400
7 992 299	1.430.037	90 008 145	1.965.004	90 487 571	1.501.562	93 180 806	1.970.398
7 992 300	1.430.037	90 008 241	1.500.514	90 506 102	1.970.389	93 740 920	1.331.139
7 992 304	1.430.036R	90 008 612	1.406.121R	90 510 386	1.970.140	93 740 943	1.331.172
7 992 318	1.230.123	90 009 490	1.106.212	90 510 387	1.970.341	93 740 944	1.431.139
7 992 319	1.230.127	90 010 693	1.312.066	90 510 851	1.501.531	94 021 067	1.322.003
7 992 324	1.206.029HV	90 010 695	1.412.095R	90 510 857	1.501.529	94 022 297	1.222.056HV
7 992 326	1.213.011HV	90 010 696	1.212.055HVS	90 510 858	1.501.529	94 129 202	1.313.093
7 992 330	1.206.034HVS	90 087 360	1.406.026R	90 518 663	1.499.199	94 136 766	1.970.219
7 992 331	1.230.140	90 113 411	1.500.509	90 518 664	1.499.199	94 174 468	1.422.069
7 992 338	1.215.067	90 113 422	1.306.099	90 518 665	1.499.199	94 206 140	1.413.014
7 992 340	1.222.056HV	90 114 106	1.106.212	90 518 666	1.499.199	94 208 408	1.213.022HV

GENERAL MOTORS

94 216 729	1.413.014
94 216 730	1.313.092
94 221 206	1.413.014
94 321 537	1.313.254
94 322 990	1.322.060
94 338 910	1.413.030
94 404 545	1.970.199
94 404 559	1.413.029
94 404 560	1.313.122
94 625 744	1.306.079
94 632 557	1.406.026R
94 632 558	1.306.080
94 840 127	1.970.197
94 844 585	1.413.027
94 845 144	1.413.027
94 845 173	1.313.119
94 847 241	1.413.029
94 850 617	1.313.248
94 853 695	1.970.199
94 855 135	1.313.265
95 512 934	1.970.442
95 517 924	1.970.450
95 528 319	1.970.547
96 052 016	1.413.030
96 053 294	1.313.107
96 055 178	1.413.030
96 056 629	1.431.108
96 058 494	1.501.415
96 059 524	1.313.093
96 061 556	1.413.034
96 061 557	1.313.245
96 064 787	1.431.131
96 064 788	1.331.140
96 066 463	1.413.028
96 066 464	1.313.123
96 067 826	1.431.131
96 068 686	1.331.144
96 288 956	1.499.006
96 291 306	1.499.007
96 342 284	1.501.730
96 460 220	1.501.677
96 460 221	1.499.247
96 460 222	1.499.247
96 460 223	1.499.247
96 460 224	1.499.247
96 476 983	1.970.545
96 497 773	1.501.680
96 518 123	1.501.634
96 984 145	1.499.249
V S10 858	1.206.034HVS
V S10 867	1.306.112
V S11 643	1.306.072
V S12 013	1.206.034HVS

HITACHI

43J83-17001	1.322.048
43S85-16001	1.422.073
43S85-17001	1.322.041
43S86-16001	1.422.073
4461-13301	1.222.056HV
4461-1700	1.322.003
4461-2700 B	1.322.003
4461-3330 A	1.222.056HV
4461-3330 AY	1.222.056HV
4461-4330 AY	1.222.056HV
44A2-13301	1.222.056HV
44A2-16001	1.422.052
44A5-13301	1.222.056HV
44AZ-13301	1.222.056HV
44P88-16001	1.422.093
44P88-17001	1.322.075
44R80-17001	1.322.057
44R84-16002	1.422.052
44R86-16001	1.422.073

HITACHI

44S88-17001	1.322.046
CM11-108	1.970.608
CM11-109	1.970.529
CM11-111	1.970.608
CM11-112	1.970.529
CM11-116	1.970.603
CM11-118	1.970.527
CM11-201	1.970.445
CM11-202	1.970.384
CM11-207A	1.970.457
CM12-100	1.970.265
CM1T-205	1.970.219
CM1T-209B	1.970.216
CM1T-217	1.970.216
CM1T-228	1.970.347
CM1T-228 A	1.970.347
CM1T-228 B	1.970.347
CM1T-228 C	1.970.347
DIS4-05	1.965.051
DIS4-08	1.965.072

HOLDEN

10457153	1.312.075
10467546	1.412.098
10495411	1.412.098
10496278	1.312.075
1910111060	1.313.265
1910115120	1.313.278
1910174050	1.313.278
1910174180	1.313.267
1910202010	1.413.027
1910211010	1.413.029
1910211031	1.413.029
1910211370	1.413.029
22157H9560	1.422.052
2216215M04	1.322.057
2243342L00	1.970.219
2243342L10	1.970.219
3314074010	1.213.011HV
3331070B50	1.431.119
3331082010	1.413.030
3331082610	1.413.028
3331086240	1.431.108
3332160A10	1.313.093
3332162E10	1.331.131
3332163B40	1.331.132
3332175110	1.313.093
3370083010	1.499.020
8941744680	1.422.069
8942167300	1.313.092
8942212060	1.413.014
8942389820	1.413.027
8943215370	1.313.254
8943229900	1.322.060
8943389100	1.413.030
90008612	1.406.121R
90243618	1.965.036¹
90336536	1.306.257
90349877	1.428.028R
90350988	1.306.256
90350997	1.328.100
90443584	1.500.688
90443687	1.500.688
90443690	1.501.237
90443692	1.500.689
90443900	1.970.273
90449739	1.970.140
90458250	1.970.272
90487571	1.501.562
9091902135	1.970.197
9091902163	1.970.198
9091902164	1.970.199
9091922327	1.501.209
9091922370	1.501.793

HOLDEN

92061881	1.501.947
92061882	1.501.947
92061883	1.501.947
92061884	1.501.947
GB819	1.306.080
GB835	1.306.112
GB838	1.406.056R
GB901	1.406.131
GB926	1.306.112
GD679	1.313.093
GD696	1.413.028
GH203	1.222.056HV
GH506	1.322.003
GH605	1.422.052
GH617	1.322.057
VS19424	1.406.127R
VS21273	1.406.121R

HONDA

06302-PT2-000	1.965.052
06302-PT2-A00	1.965.052
06302-PT3-000	1.965.052
06302-PT3-A00	1.965.052
06302-PT-A00	1.965.052
30102-590-075	1.322.003
30102-634-005	1.322.003
30102-634-0050	1.322.003
30102-634-0051	1.322.003
30102-P0A-A01	1.322.082
30102-P0A-A02	1.322.082
30102-P12-A01	1.322.076
30102-P1J-E01	1.328.106
30102-P2A-J01	1.322.093
30102-P2M-A01	1.322.082
30102-P45-G02	1.322.082
30102-P54-006	1.322.068
30102-PA1-732	1.322.011
30102-PA6-924	1.322.011
30102-PC1-004	1.322.011
30102-PCB-004	1.322.068
30102-PD2-006	1.322.022
30102-PD2-016	1.322.022
30102-PEL-J01	1.322.068
30102-PI2-A01	1.322.076
30102-PM3-015	1.322.071
30102-PM3-025	1.322.071
30102-PM3-035	1.322.071
30102-PM3-045	1.322.071
30102-PM3-A02	1.322.069
30102-PM5-A03	1.322.069
30102-PM5-A04	1.322.069
30102-PM5-A05	1.322.069
30102-PM7-006	1.322.069
30102-PM7-016	1.322.069
30102-PM7-036	1.322.069
30102-PR3-003	1.322.069
30102-PR3-006	1.322.069
30102-PR3-026	1.322.069
30102-PR4-A02	1.322.069
30102-PT2-006	1.322.068
30102-PT2-016	1.322.068
30102-PT2-026	1.322.068
30102-PT3-A12	1.322.076
30102-PV1-A03	1.322.084
30102-PV1-A04	1.322.084
30102-PV1-A05	1.322.084
30103-657-005	1.422.052
30103-P01-005	1.422.081
30103-P08-003	1.422.095
30103-P0A-A01	1.422.098
30103-P2A-J01	1.422.102
30103-P72-003	1.422.095
30103-PA1-732	1.422.056
30103-PA1-733	1.422.056
30103-PAA-A01	1.422.098
30103-PAI-732	1.422.056
30103-PC3-822	1.422.056
30103-PDA-E01	1.422.098
30103-PE1-731	1.422.073
30103-PE9-006	1.422.056
30103-PM0-B01	1.422.081
30103-PM3-015	1.422.081
30103-PM3-025	1.422.081
30103-PM5-702	1.422.082
30103-PM5-703	1.422.082
30103-PM5-A02	1.422.082
30103-PM5-A04	1.422.082
30103-PR3-006	1.422.082
30103-PT2-016	1.422.092
30103-PW0-G02	1.422.097R
30103-PW0-G03	1.422.097R
30105-590-075	1.222.056HV
30105-634-005	1.222.056HV
30105-634-0051	1.222.056HV
30105-657-005	1.222.056HV
30105-679-005	1.222.056HV
30120-PM-A01	1.965.052
30120-PR3-003	1.965.052
30120-PT2-004	1.965.052
30120-PT3-003	1.965.052
30120-PT3-004	1.965.052
30130-P54-006	1.965.052
30130-PR3-006	1.965.052
30130-PT2-006	1.965.052
30500-P01-005	1.970.216
30500-POA-A01	1.970.347
30500-POH-A01	1.970.347
30500-PAA-A01	1.970.347
30500-PCA-003	1.970.347
30500-PDA-E01	1.970.347
30500-PE0-006	1.970.212
30500-PH1-026	1.970.212
30500-PM3-005	1.970.216
30500-PM3-015	1.970.216
30500-PM5-A02	1.970.213
30500-PM5-A03	1.970.213
30500-PR4-A02	1.970.215
30500-PT0-005	1.970.216
30510-P73-A01	1.970.214
30510-P73-A02	1.970.214
30510-PT2-006	1.970.214
30520-P8E-A01	1.970.457
30520-P8E-S01	1.970.457
30520-P8F-A01	1.970.457
30520-P8F-A02	1.970.457
30520-PDF-E01	1.970.168
30520-PGK-A01	1.970.457
30520-PH7-006	1.970.211
30520-PH7-016	1.970.211
30520-PVF-A01	1.970.457
30520-PVJ-A01	1.970.457
30520-PWA-003	1.970.529
30520-PWA-013	1.970.529
30520-PWA-S01	1.970.529
30520-RB0-003	1.970.603
30520-RB0-013	1.970.603
30520-RB0-S01	1.970.603
30520-RCA-A01	1.970.457
30520-RCA-A02	1.970.457
30520-RCA-S01	1.970.457
30520-REA-Z01	1.970.529
30520-RJA-A01	1.970.457
30520-RNA-A01	1.970.522
30521-PWA-003	1.970.608
30521-PWA-013	1.970.608
30521-PWA-S01	1.970.608
30521-RBJ-003	1.970.527
30521-RBJ-013	1.970.527
30521-RBJ-S01	1.970.527
30521-REA-Z01	1.970.608

HONDA

32700-POD-000	1.501.711
32700-P0K-G00	1.501.711
32700-P1J-E01	1.501.686
32700-P5K-003	1.501.711
32700-P5N-G01	1.501.711
32700-PEL-004	1.501.699
32700-PHK-003	1.501.709
32700-PT0-000	1.501.711
32700-PT0-G00	1.501.711
32701-P14-A00	1.501.711
32701-PT0-000	1.501.711
32702-P14-A00	1.501.711
32702-PT0-000	1.501.711
32703-P14-A00	1.501.711
32703-PT0-000	1.501.711
32704-P14-A00	1.501.711
32704-PT0-000	1.501.711
32722-P2A-000	1.501.702
32722-P2A-003	1.501.702
32722-P2A-J00	1.501.702
32722-P2A-J01	1.501.702
32722-P2F-A02	1.501.702
32722-P2F-A03	1.501.702
32722-P75-A01	1.501.709
32722-PT3-A00	1.501.711
33105-590-075	1.222.056HV
8-94174-468-0	1.422.069
8-94322-990-0	1.322.060

HYUNDAI

27110-02503	1.331.121
27110-02750	1.331.170
27110-21020	1.331.003/00
27110-21021	1.331.003/00
27110-21060	1.331.003/00
27110-22000	1.306.124
27110-32810	1.331.003/00
27110-36010	1.331.116
27115-21020	1.431.023
27115-32500	1.431.107
27115-35000	1.431.109
27120-11000	1.331.003/00
27131-02750	1.431.138
27131-11000	1.431.023
27131-22000	1.406.121R
27131-32810	1.431.107
27131-35010	1.431.109
27132-11000	1.431.023
27135-11000	1.231.084
27180-22000	1.906.244
27300-3F100	1.970.556
27301-02100	1.970.587 ⁵
27301-02502	1.970.394 ^U
27301-02600	1.970.496 ⁵
27301-02630	1.970.496 ⁵
27301-02800	1.970.496 ⁵
27301-03000	1.970.579 ⁵
27301-03010	1.970.579 ⁵
27301-03015	1.970.579 ⁵
27301-03035	1.970.579 ⁵
27301-03110	1.970.612
27301-03200	1.970.622
27301-03HA0	1.970.647
27301-04000	1.970.614
27301-04110	1.970.638
27301-22600	1.970.585
27301-23700	1.970.581 ⁵
27301-23710	1.970.581 ⁵
27301-23900	1.970.581 ⁵
27301-26600	1.970.586
27301-2B000	1.970.495
27301-2B010	1.970.543
27301-2B100	1.970.611

HYUNDAI

27301-3C000	1.970.492
27310-02611	1.970.587
27310-02612	1.970.587
27310-02620	1.970.496
27310-02630	1.970.496
27310-03010	1.970.579
27310-03020	1.970.579
27310-22600	1.970.585
27310-22600	1.970.586
27310-22610	1.970.585
27310-26600	1.970.586
27310-37110	1.970.579
27310-37120	1.970.589
27310-37130	1.970.589
27420-02610	1.499.235
27420-03011	1.499.255
27420-23700	1.501.385
27420-37200	1.499.236
27420-37310	1.499.236
27430-02610	1.499.235
27430-03000	1.499.255
27430-03011	1.499.255
27430-23700	1.501.385
27430-37200	1.499.236
27440-02610	1.499.235
27440-03000	1.499.255
27440-03011	1.499.255
27440-23700	1.501.385
27440-37200	1.499.236
27440-37310	1.499.236
27450-02610	1.499.235
27450-03000	1.499.255
27450-03010	1.499.255
27450-23700	1.501.385
27450-37200	1.499.236
27460-37200	1.499.236
27460-37310	1.499.236
27470-37200	1.499.236
27501-02A00	1.499.120
27501-02D00	1.499.235
27501-02H00	1.499.119
27501-22B00	1.499.119
27501-22B10	1.499.119
27501-23A00	1.501.385
27501-23B00	1.501.385
27501-23B01	1.501.385
27501-23B70	1.501.385
27501-26A00	1.499.111
27501-26C00	1.499.111
27501-26D00	1.499.111
27501-33A00	1.501.401
27501-37B00	1.499.236
27501-38B00	1.499.241
AA100-18100B	1.970.219 ^{*1}
KK150-18V00A	1.331.122

INFINITI

22157-46N12	1.431.136
22157-70J00	1.422.085
22162-0M811	1.331.151
22162-53J00	1.322.073
22448-2V70A	1.970.626
22448-HG00A	1.970.626
22448-HG00B	1.970.626
22448-HG00C	1.970.626
22448-HG00E	1.970.626
22448-JA00C	1.970.552
22448-JA10C	1.970.533
22448-JA11C	1.970.533

INNOCENTI

39322140	1.970.101D
46543562	1.970.146
638326146	1.206.049HVS
638326383	1.406.025R
6553206203	1.213.022HV
6553206400	1.413.034
6553221201	1.313.094
6553221203	1.213.011HV
6553221400	1.413.014
659321119	1.328.078
659321324	1.428.012
7735397	1.500.655
7746151	1.970.148
7746153	1.970.158
82361915	1.430.047R
9622889780	1.970.188
9938360	1.330.104
9940095	1.965.020
9940429	1.930.177/1
9941693	1.930.176M
9943506	1.430.059
9944668	1.330.115
9944794	1.330.101
9946355	1.330.114
9946356	1.430.060

ISUZU

GR 2384	1.213.022HV
2-23115-15	1.222.056HV
5-82311215-0	1.322.003
5-86202572-0	1.322.082
5-86202573-0	1.422.098
5-86206161-0	1.970.347
5-86207198-0	1.970.347
8-01979571-0	1.965.025
8-10495411-0	1.412.098
8-10496278-0	1.312.075
8-16140049-0	1.965.025
8-23115-14	1.222.056HV
8-23115-15	1.222.056HV
8-23212-14	1.322.003
8-94136766-0	1.970.219
8-94174468-0	1.422.069
8-94201644-0	1.213.011HV
8-94206140-0	1.413.014
8-94206144-0	1.213.022HV
8-94206145-0	1.213.022HV
8-94208-408	1.213.022HV
8-94216729-0	1.413.014
8-94216730-0	1.313.092
8-94221206-0	1.413.014
8-94221-206-00	1.413.014
8-94238982-0	1.413.027
8-94321537-0	1.313.254
8-94322990-0	1.322.060
8-94338910-0	1.413.030
8-94404545-0	1.970.199
8-94404559-0	1.413.029
8-94404560-0	1.313.122
9-40210-67	1.322.003
9-40222-97	1.222.056HV
9-42084-08	1.213.022HV
9-42212-06	1.413.014
9-82311214-0	1.322.003
9-82311515-0	1.222.056HV
9-82311518-0	1.222.056HV

IVECO

500309816	1.970.345
504142675	1.970.442
8024220	1.970.313

JAGUAR

AEU 1501	1.428.012
AEU 1502	1.328.085
JLM 150	1.328.098
JLM 1909	1.330.110
JLM 1911	1.430.058
JLM 381	1.428.027R
JLM 838	1.306.081
JLM 839	1.406.113R
JLM 9522	1.228.089
JLM 9528	1.328.085
JLM 9623	1.428.012
LNA 1508AA	1.970.170

JEEP

33003389	1.419.092
33004024	1.319.093
46337742	1.970.549
4728190	1.499.181
4728190AC	1.499.181
55224110	1.970.549
55229959	1.970.549
55263679	1.970.549
55270217	1.970.549
56026876	1.319.093
56027075	1.419.092
68298269AA	1.970.549
K68298228AA	1.970.549
K68298269AA	1.970.549
K68436928AA	1.970.549
T1031135	1.970.107

KIA

OK011-18100	1.970.168
OK201-18140	1.501.398
OK201-18150	1.501.398
OK201-18-150A	1.501.398
OK247-18-160A	1.501.841
OK247-18-160B	1.501.841
OK247-18-180A	1.501.841
OK247-18-180B	1.501.841
OK2A3-18-160A	1.501.841
OK2A3-18-180A	1.501.841
OK2BW-18160	1.501.841
OK2BW-18180	1.501.841
OK30A-18-140A	1.501.851
OK30B-18140	1.501.851
OK30E-18140	1.499.239
OK30F-18140	1.499.239
27300-3F100	1.970.556
27301-02700	1.970.589
27301-02710	1.970.589
27301-03010	1.970.579 ⁵
27301-03100	1.970.579 ⁵
27301-03110	1.970.612
27301-03200	1.970.622
27301-03HA0	1.970.647
27301-04000	1.970.614
27301-04110	1.970.638
27301-23700	1.970.581 ⁵
27301-23710	1.970.581 ⁵
27301-23720	1.970.581 ⁵
27301-23900	1.970.581 ⁵
27301-26600	1.970.586
27301-2B000	1.970.495
27301-2B010	1.970.543
27301-2B100	1.970.611
27301-3C000	1.970.492
27310-02611	1.970.587
27310-03010	1.970.579
27310-03020	1.970.579

KIA

27400-2X140	1.499.239
27401-2X000	1.501.851
27420-23700	1.501.385
27420-26700	1.499.111
27420-37310	1.499.236
27430-23700	1.501.385
27430-26700	1.499.111
27430-37200	1.499.236
27440-23700	1.501.385
27440-26700	1.499.111
27440-37310	1.499.236
27450-23700	1.501.385
27450-26700	1.499.111
27450-37200	1.499.236
27460-37310	1.499.236
27470-37200	1.499.236
27501-02H00	1.499.119
27501-23B70	1.501.385
27501-26D00	1.499.111
27501-33A00	1.501.401
27501-38B00	1.499.241
AA100-18-100B	1.970.219 [†]
KK137-18-140A	1.501.398
KK137-18-150A	1.501.398
KK137-18V00	1.331.121
KK150-18V00	1.331.122
KK150-18-V00A	1.331.122
KK150-18V05	1.431.108
KK150-18-V05A	1.431.108
MB593-18V00	1.331.150
MB593-18-V00A	1.331.150
MB593-18V05	1.431.132
MB6BF-18V05	1.431.132
MF220-18-V00A	1.331.121

LADA

21010-3706020-10	1.446.014R
21010-3706500-00	1.347.025
21010-3706800-10	1.246.070
2101-3705000-02	1.970.101D
21013-7050560	1.970.101D
2101-3705060-00	1.970.101D
21013-7060010-10	1.446.014R ^C
2101-3706020	1.446.014R
2101-3706020-10	1.446.014R
2101-3706500	1.347.025
2101-3706800	1.246.071
2101-3706800-10	1.246.070
2107-3706020-10	1.446.014R
2107-3706020-20	1.446.014R
2107-3706500	1.347.025
2108-3706020	1.446.016R
2108-3706500	1.347.027
2108-3706500-10	1.347.027
2108-3734910-10	1.965.004
22 43 324 28R	1.970.613
22 43 361 34R	1.970.596
3037-06020	1.446.014R
3700-3118583	1.965.004
38-37060-20	1.446.014R
38-37065-00	1.347.025
82 00 765 882	1.970.432

LANCIA

4158493	1.970.101D
4386221	1.970.103
4460205	1.970.103
46403328	1.970.314
46413088	1.501.503
46425912	1.501.504

LANCIA

46446039	1.970.345
46472440	1.970.345
46473849	1.970.384
46474814	1.501.505
46480361	1.970.345
46543562	1.970.146
46548037	1.970.146
46749624	1.501.451
46777288	1.970.442
55200112	1.970.423
55202897	1.501.451
55208723	1.970.423
55214926	1.970.549
55229959	1.970.549
55246099	1.970.442
60562701	1.970.313
60805420	1.970.146
60809492	1.970.146
60809702	1.306.236
60810690	1.970.313
7080442	1.306.079
7588436	1.990.303
7612954	1.970.126
7625943	1.500.456
7626232	1.970.146
7646974	1.970.158
7648797	1.970.168
7663177	1.970.108
7672018	1.970.146
7700267693	1.406.119R
7703382	1.500.700
7735397	1.500.655
7742005	1.500.694
7742689	1.500.456
7746151	1.970.148
7760523	1.501.363
7776810	1.500.616
7785350	1.500.888
7787458	1.500.889
7789346	1.970.345
9463264180	1.970.408
9607405480	1.970.188
9622889780	1.970.188
9634131380	1.970.408
9924733	1.415.083R
9927962	1.406.025R
9934266	1.115.023
9934728	1.330.093
9934729	1.930.161/1
9935150	1.215.101
9936023	1.430.047R
9936027	1.330.098
9936331	1.930.163/1
9936735	1.315.058
9937767	1.430.054R
9938173	1.430.055R
9938360	1.330.104
9939707	1.406.023R
9939786	1.930.180M
9939787	1.330.101
9939788	1.930.176M
9939789	1.330.109
9940095	1.965.020
9940302	1.415.094
9940428	1.430.057R
9940429	1.930.177/1
9941721	1.315.080
9942040	1.965.029
9943506	1.430.059
9944407	1.430.060
9944576	1.330.114
9944668	1.330.115

LAND ROVER

00000A00069	1.317.023
00000A00070	1.417.058
00000A00071	1.217.024
00000A00072	1.117.097
1748018	1.970.352
262704	1.428.007
269987	1.228.083MHV
566859	1.328.075
600328	1.328.070
605190	1.328.091
AUU1675	1.501.900
AUU1676	1.501.900
AUU1677	1.501.900
AUU1678	1.501.900
ERR6045	1.970.168
ERR6566	1.970.168 [†]
LRO22494	1.970.352
NEC000040	1.970.352
NEC100630	1.970.374
NEC101000L	1.970.352
NEC101010L	1.970.413
NGC103570	1.501.900
NGC103740	1.499.107
NGC103750	1.499.107
NGC103760	1.499.107
NGC103780	1.499.107
NGC103800	1.499.107
NGC104170L	1.501.889
NGC500370	1.501.900
NGC500380	1.501.900
NGC500390	1.501.900
NGC500400	1.501.900
NGC500410	1.501.900
NJD10010	1.328.093
NJE10003	1.428.029R
PRC9858	1.970.101D
RTC3197	1.328.091
RTC3199	1.428.022
RTC3270	1.228.083MHV
RTC3278	1.328.078
RTC3282	1.228.089
RTC3295	1.315.049
RTC3313	1.228.083MHV
RTC3339	1.428.012
RTC3341	1.415.091
RTC3473	1.115.034
RTC3526	1.115.034
RTC3612	1.428.006
RTC3613	1.428.014
RTC3614	1.428.012
RTC3616	1.415.091
RTC3618	1.428.021
RTC3881	1.228.083MHV
RTC4932	1.315.054
RTC4933	1.415.091
RTC4935	1.115.034
RTC5629	1.970.101D
RTC5946	1.228.089
RTC5947	1.228.089
RTC6627	1.228.089
RTC6629	1.428.022
STC1857	1.428.022
STC8368	1.328.091

LEXUS

90919-02185	1.970.202
90919-02197	1.970.203
90919-02208	1.970.203
90919-02244	1.970.466
90919-02248	1.970.458
90919-02250	1.970.537
90919-02251	1.970.538
90919-02255	1.970.538
90919-02256	1.970.537

LEXUS

90919-02258	1.970.536
90919-02260	1.970.458
90919-02266	1.970.466
90919-A2003	1.970.537
90919-A2004	1.970.538
90919-A2005	1.970.537
90919-A2007	1.970.538
90919-C2004	1.970.537

MARUTI

33102-75110	1.213.011HV ^F
33310-82110	1.413.030
33321-78110	1.313.107

MASERATI

313220203	1.430.054R
6313220203	1.430.054R

MAZDA

0000-18-135A	1.501.760
0324-24-310	1.331.003/00
0324-24-312	1.431.023
0494-24-314	1.231.084
1E03-18-10X	1.970.532 [†]
1E03-18-10XA	1.970.532 [†]
1E04-18-10X	1.970.532
1E05-18-100	1.970.299
1E05-18-100A	1.970.299
1E05-18-100B	1.970.532
1E06-18-100	1.970.2995
1F20-18-100	1.970.532
1F20-18-100A	1.970.532
3710-24-310	1.322.003
3763-24-314	1.231.084
3823-24-314	1.231.084
3879-24-314	1.231.084
8BBG-18-140	1.501.398
8BBY-18-140	1.501.398
8BGP-18-140	1.501.760
8BGP-18-140A	1.501.760
8BGP-18-140B	1.501.760
8BGP-18-140C	1.501.760
AM01-24-312	1.431.023
AM15-18-V00	1.331.003/00
B303-18-V00	1.331.122
B303-18-V05	1.431.108
B33G-18-140A	1.501.741
B33G-18-140B	1.501.741
B3B1-18-V00	1.331.122
B3C7-18-V00	1.322.088
B3C7-18-V05	1.422.094
B3M5-18-V00	1.331.154
B3S5-18-V00	1.331.150
B541-18-V00	1.331.131
B541-18-V20	1.965.073 [†]
B593-18-V00	1.331.150
B593-18-V00A	1.331.150
B593-18-V05	1.431.132
B601-18-V05	1.422.073
B616-18-V00	1.331.125
B61P-18-140C	1.501.745
B61V-18-V05	1.431.119
B69F-18-140A	1.501.231
B69F-18-140B	1.501.231
B6BF-18-140A	1.501.231
B6BF-18-140B	1.501.231
B6BF-18-V05	1.431.132
B6MC-18-140B	1.501.745

MAZDA

B6S7-18-100	1.970.3665
B6S7-18-10XA	1.970.233
B6S8-18-10XA	1.970.233
BP05-18-V00	1.331.121
BPE8-18-140	1.501.745
BPE8-18-140A	1.501.745
C201-18-100	1.970.532
C201-18-100A	1.970.532
C201-18-100B	1.970.532
C201-18-160A	1.499.242
C201-18-170A	1.499.242
C201-18-180A	1.499.242
C201-18-190A	1.499.242
C401-18-100	1.970.481
C401-18-100A	1.970.481
E594-24-310	1.331.109
E5D5-18-V00A	1.331.118
F201-18-V00	1.331.125
F220-18-V00A	1.331.121
F220-18-V05	1.431.113
F2G8-18-V00	1.331.121
F829-18-V00	1.331.132
F829-18-V05	1.431.108
F855-24-312	1.431.023
FE01-24-310	1.331.109
FE01-24-310A	1.331.109
FE1H-18-V00	1.331.117
FE1H-18-V00A	1.331.117
FE2S-18-V00	1.331.132
FE2S-18-V00A	1.331.132
FE2S-18-V05	1.431.108
FEEN-18-V00	1.331.132
FEH1-18-V00A	1.331.117
FEJK-18-10X	1.970.3665
FP13-18-140A	1.500.884
FP13-18-140B	1.500.884
FP39-18-140	1.501.740
FP39-18-140A	1.501.740
FP85-18-140A	1.501.767
FP86-18-140A	1.501.767
FS01-18-140	1.500.884
FS01-18-V05	1.431.137
FS01-18-V05A	1.431.137
FS05-18-V00	1.322.077
FS05-18-V05	1.422.094
FS07-18-V05	1.431.131
FS07-18-V05A	1.431.131
FS90-18-V00	1.322.092
FS90-18-V05	1.422.102
FSD7-18-100	1.970.135
FSD7-18-140B	1.501.739
G601-18-V05	1.431.108
G602-18-V00	1.331.122
G609-18-V00	1.331.121
H612-24-310	1.331.003/00
K834-18-140A	1.501.760
KF33-18-140C	1.501.760
KF33-18-140D	1.501.760
KF33-18-140E	1.501.760
KF34-18-V00	1.331.149
KF34-18-V05	1.431.134
KF34-18-V05A	1.431.134
KL01-18-140C	1.501.760
KL01-18-V00	1.331.137
KL01-18-V00A	1.331.137
KL01-18-V05	1.431.133
KL01-18-V05A	1.431.133
KL47-18-140B	1.501.760
KL47-18-140C	1.501.760
KL64-18-100A	1.970.289
L813-18-140B	1.499.245
L813-18-140C	1.499.245
LF01-18-100	1.970.532
LF01-18-100A	1.970.532
LF16-18-100	1.970.480
LF16-18-100A	1.970.480

MAZDA

LF16-18-100B	1.970.480
P51B-18-100	1.970.627
PE01-18-100	1.970.627
PE20-18-100	1.970.627
PE20-18-100A	1.970.627
PYFS-18-100	1.970.627
YF09-18-10X	1.970.532
Z501-18-140	1.501.738
Z501-18-140A	1.501.738
ZJ01-18-100	1.970.514
ZJ01-18-100A	1.970.514
ZJ20-18-100	1.970.516
ZJ20-18-100A	1.970.516
ZL01-18-140A	1.501.729
ZZLO-18-100	1.970.289
ZZMO-24-310	1.319.093
ZZMO-24-312	1.419.092
ZZM1-24-310	1.319.093
ZZM2-24-310	1.319.093
ZZM7-18-100	1.970.289

MERCEDÉS-BENZ

A 000 150 04 80	1.970.317
A 000 150 05 80	1.970.317
A 000 150 15 80	1.970.420
A 000 150 19 80	1.970.487
A 000 150 25 80	1.970.420
A 000 150 26 80	1.970.487
A 000 150 27 80	1.970.487
A 000 150 29 80	1.970.420
A 000 158 06 02	1.306.062
A 000 158 07 02	1.306.072
A 000 158 07 90	1.206.029HV
A 000 158 15 31	1.406.018R
A 000 158 16 02	1.306.072
A 000 158 18 02	1.306.079
A 000 158 18 90	1.206.029HV
A 000 158 20 31	1.406.018R
A 000 158 20 90	1.206.021
A 000 158 21 31	1.406.021R
A 000 158 22 31	1.406.024R
A 000 158 22 90	1.206.049HVS
A 000 158 23 31	1.406.023R
A 000 158 23 90	1.206.034HVS
A 000 158 24 90	1.206.034HVS
A 000 158 25 02	1.306.072
A 000 158 26 31	1.406.034R
A 000 158 27 02	1.306.092
A 000 158 27 31	1.406.025R
A 000 158 28 02	1.306.079
A 000 158 28 90	1.206.062
A 000 158 31 31	1.406.025R
A 000 158 33 31	1.406.061R
A 000 158 34 02	1.306.090 ^A
A 000 158 34 31	1.406.055R
A 000 158 35 31	1.406.060R
A 000 158 35 90	1.206.062
A 000 158 36 02	1.306.092 ^A
A 000 158 36 31	1.406.049R
A 000 158 37 31	1.406.112R
A 000 158 37 90	1.206.062
A 000 158 39 31	1.406.121R
A 000 158 39 90	1.206.062
A 000 158 40 03	1.970.180
A 000 158 40 31	1.406.126R
A 000 158 40 90	1.206.034HVS
A 000 158 41 02	1.306.092 ^A
A 000 158 42 02	1.306.090 ^A
A 000 158 42 31	1.406.121R
A 000 158 43 02	1.306.108 ^A
A 000 158 44 02	1.306.123 ^A
A 000 158 45 03	1.970.178
A 000 158 48 02	1.306.234

MERCEDÉS-BENZ

A 000 158 48 03	1.970.178
A 000 158 49 02	1.306.234 ^A
A 000 158 50 03	1.970.178
A 000 158 52 02	1.306.239 ^A
A 000 158 53 03	1.970.178
A 000 158 54 03	1.970.178
A 000 158 56 03	1.970.179
A 000 158 58 03	1.970.179
A 000 158 61 03	1.970.178
A 000 158 62 03	1.970.178
A 000 158 64 03	1.970.179
A 000 158 70 03	1.970.316
A 000 158 71 03	1.970.316
A 000 158 73 03	1.970.417
A 000 158 75 03	1.970.316
A 000 158 77 03	1.970.414
A 000 158 78 03	1.970.417
A 102 150 53 18	1.501.657
A 102 150 54 18	1.501.654
A 102 150 54 18	1.501.657
A 102 150 55 18	1.501.654
A 102 150 55 18	1.501.657
A 102 150 56 18	1.501.654
A 102 150 56 18	1.501.657
A 102 150 58 18	1.501.657
A 102 150 59 18	1.501.654
A 103 158 00 02	1.306.237
A 103 158 02 31	1.406.125R
A 103 158 03 31	1.406.125R
A 112 150 01 18	1.501.649
A 112 150 02 18	1.501.649
A 112 150 06 18	1.501.649
A 112 150 07 18	1.501.649
A 119 158 01 31	1.406.146R
A 119 158 02 31	1.406.146R
A 119 158 03 31	1.406.146R
A 266 150 01 18	1.499.234
A 266 150 02 18	1.499.234
A 266 150 06 18	1.499.234
A 266 150 07 18	1.499.234
A 266 150 10 18	1.499.232
A 266 150 11 18	1.499.232
A 266 150 12 18	1.499.232
A 266 150 13 18	1.499.232
A 272 906 00 60	1.970.487
A 274 906 06 00	1.970.626
A 274 906 07 00	1.970.626
A 274 906 14 00	1.970.626
A 281 906 00 00	1.970.613

MG

NEC100630	1.970.374
NEC101000	1.970.413
NEC101010	1.970.413

MINI

12 12 1 496 996	1.501.719
12 12 1 496 997	1.501.719
12 12 1 496 998	1.501.719
12 12 1 496 999	1.501.719
12 12 7 513 032	1.501.719
12 12 7 513 033	1.501.719
12 12 7 513 034	1.501.719
12 12 7 513 035	1.501.719
12 13 5 A06 753	1.970.475
12 13 7 550 012	1.970.475
12 13 7 551 049	1.970.475
12 13 7 562 744	1.970.475
12 13 7 571 643	1.970.475
12 13 7 575 010	1.970.475
12 13 7 594 596	1.970.475
12 13 7 594 937	1.970.475

MINI

12 13 7 594 938	1.970.475
12 13 7 619 385	1.970.632
12 13 8 615 991	1.970.632
12 13 8 616 153	1.970.475
12 13 8 643 360	1.970.632
12 13 8 647 463	1.970.632
12 13 8 657 273	1.970.475
12 13 8 678 438	1.970.632
7 571 643	1.970.475
8 643 360	1.970.632
8 647 463	1.970.632
82 11 0 393 996	1.501.719
82 11 0 404 488	1.501.719

MITSUBISHI

08605	1.331.003/00
1832A016	1.970.497
1832A028	1.970.503
27110-21060	1.331.003/00
27110-32810	1.331.003/00
27131-32810	1.431.107
49371	1.331.145
62571	1.331.143
J170	1.965.073
MD134754	1.501.401
MD183124	1.501.278
MD192995	1.501.401
MD193015	1.501.278
MD198216	1.501.278
MD310297	1.501.278
MD315902	1.501.278
MD332343	1.501.753
MD334017	1.501.278
MD334021	1.501.278
MD334026	1.501.278
MD334039	1.501.278
MD334043	1.501.764
MD336862	1.501.764
MD338249	1.501.344
MD338624	1.501.764
MD343245	1.499.251
MD362276	1.501.882
MD365102	1.501.883
MD371794	1.501.344
MD371980	1.501.344
MD602756	1.331.003/00
MD602758	1.431.023
MD602949	1.331.003/00
MD604338	1.413.014
MD604411	1.313.117
MD607101	1.231.084
MD607394	1.231.085
MD607402	1.231.085
MD607597	1.331.003/00
MD611151	1.431.107
MD611459	1.431.109
MD611526	1.331.116
MD611604	1.331.003/00
MD611686	1.331.003/00
MD611757	1.431.109
MD611850	1.431.023
MD618187	1.431.131
MD618210	1.331.003/00
MD618283	1.331.158
MD618284	1.431.119
MD618297	1.331.134
MD618364	1.331.131
MD618374	1.331.135
MD618431	1.331.143
MD618555	1.331.138
MD618556	1.431.137
MD618760	1.331.147
MD618977	1.331.138

MITSUBISHI

MD618979	1.331.147
MD619000	1.431.136
MD619050	1.331.161
MD619092	1.331.169
MD619176	1.331.143
MD619186	1.331.158
MD619216	1.431.136
MD619272	1.431.131
MD619273	1.431.137
MD619274	1.431.134
MD619354	1.431.136
MD619363	1.331.168
MD619387	1.331.169
MD619388	1.331.168
MD619434	1.431.136
MD619468	1.331.168
MD619637	1.431.136
MD620555	1.413.030
MD626374	1.331.135
MN195805	1.970.505
T100T20871	1.231.084
T100T20872	1.231.084
T100T21271	1.231.085
T100T21272	1.231.084
T12271	1.431.023
T13371	1.431.030
T15672	1.431.109
T15673	1.431.109
T16571	1.431.107
T16871	1.431.108
T17371	1.431.110
T232T42271	1.331.003/00
T232T42471	1.331.003/00
T232T42771	1.331.003/00
T232T48972	1.331.158
T31771	1.331.139
T42271	1.331.003/00
T43574	1.331.109
T43576	1.331.109
T43871	1.331.003/00
T44771	1.331.120
T45071	1.331.118
T45372	1.331.117
T45671	1.331.125
T46371	1.331.114
T46382	1.331.114
T46671	1.331.122
T46771	1.331.003/00
T46772	1.331.003/00
T46971	1.331.121
T47371	1.331.122
T48171	1.331.132
T48271	1.331.136
T48372	1.331.131
T61471	1.331.116
T880T12271	1.431.023
T880T13371	1.431.030
T880T21572	1.431.119

NISSAN

15501-208	1.322.003
22102-01M11	1.131.131
22145-18005	1.222.056HV
22145-18005A	1.228.083MHV
22145-71301	1.222.056HV
22145-73415	1.231.085
22145-73416	1.231.084
22145-78506	1.222.056HV
22145-89900	1.231.085
22145-89901	1.231.085
22145-89905	1.231.085
22145-U6001	1.222.056HV
22145-U6002	1.222.056HV

NISSAN

22149-B8900	1.422.052
22149-N3602	1.422.052
22157-03A00	1.422.086
22157-03P10	1.431.109
22157-0M512	1.431.136
22157-0M810	1.431.136
22157-10B10	1.431.023
22157-17B00	1.422.070
22157-17B10	1.431.110
22157-18F00	1.422.066
22157-1E410	1.431.118
22157-20R00	1.422.066
22157-21E00	1.422.070
22157-21E01	1.422.070
22157-21F01	1.422.070
22157-23G15	1.431.030
22157-27M02	1.422.070
22157-27M15	1.431.110
22157-2J210	1.431.136
22157-30R00	1.422.085
22157-40F00	1.422.070
22157-46N11	1.431.136
22157-46N12	1.431.136
22157-4B000	1.422.102
22157-50Y10	1.431.131
22157-53F11	1.431.118
22157-54C01	1.422.085
22157-55K10	1.431.119
22157-55Y00	1.422.070
22157-70J00	1.422.085
22157-70J01	1.422.085
22157-71J00	1.422.070
22157-71J10	1.422.086
22157-72B00	1.422.102
22157-73C00	1.428.030
22157-77A01	1.422.086
22157-78A00	1.422.070
22157-99B01	1.428.030
22157-99B03	1.428.030
22157-H3602	1.422.052
22157-H9560	1.422.052
22157-KA030	1.422.073
22157-M5610	1.431.030
22157-N3602	1.422.052
22157-R9006	1.431.023
22157-R9007	1.431.023
22157-U6001	1.422.052
22157-U6091	1.422.052
22157-U6091MP	1.422.052
22157-U6094	1.422.052
22157-U6094DY	1.422.052
22162-01B01	1.322.046
22162-03M00	1.322.089
22162-06W00	1.322.040
22162-06W03	1.322.040
22162-06W03MP	1.322.040
22162-06W04	1.322.040
22162-06W04MP	1.322.040
22162-06W05	1.322.040
22162-06W06	1.322.040
22162-0M200	1.322.089
22162-0M300	1.322.089
22162-0M810	1.331.151
22162-0M811	1.331.151
22162-11E07	1.322.063
22162-12E01	1.322.046
22162-15M00	1.322.057
22162-15M01	1.322.057
22162-15M01MP	1.322.057
22162-15M02	1.322.057
22162-15M02MP	1.322.057
22162-15M03	1.322.057
22162-15M03MP	1.322.057
22162-15M04	1.322.057
22162-17M00	1.322.046
22162-17M01	1.322.046

NISSAN

22162-17M02	1.322.046
22162-17M03	1.322.046
22162-17M04	1.322.046
22162-17M05	1.322.046
22162-18F01	1.322.040
22162-1S700	1.322.089
22162-21007	1.322.003
22162-21F03	1.322.046
22162-23G15	1.331.114
22162-25G10	1.331.120
22162-25G11	1.331.120
22162-35S00	1.322.089
22162-40F00	1.322.046
22162-40F10	1.331.114
22162-41B00	1.328.105
22162-41L11	1.331.126
22162-42L10	1.331.126
22162-42L11	1.331.126
22162-52A01	1.322.057
22162-52H20	1.331.126
22162-53J00	1.322.073
22162-70F10	1.331.152
22162-70F11	1.331.152
22162-70J00	1.328.102
22162-71300	1.322.003
22162-71312	1.322.003
22162-71J00	1.328.103
22162-71J10	1.328.101
22162-72Y10	1.331.155
22162-73C00	1.322.079
22162-78A00	1.322.046
22162-78A10	1.331.114
22162-82J00	1.328.105
22162-94M01	1.328.101
22162-94M11	1.331.136
22162-99B00	1.328.104
22162-A3514	1.331.120
22162-G5710	1.331.114
22162-G5711	1.331.114
22162-KA020	1.322.041
22162-N8801	1.322.003
22162-N8801MP	1.322.003
22162-R9006	1.331.003/00
22162-R9007	1.331.003/00
22162-W4502	1.322.040
22433-18R10	1.970.219
22433-1E400	1.970.296
22433-3529R	1.970.432
22433-42L10	1.970.219
22440-15700	1.501.789
22440-15710	1.501.789
22440-2F200	1.501.411
22440-2J210	1.501.411
22440-57Y10	1.501.399
22440-73C00	1.501.399
22440-73C10	1.501.399
22440-86J00	1.501.658
22440-86J10	1.501.658
22440-8B000	1.501.789
22440-99B00	1.500.608
22440-99B05	1.500.608
22440-99B06	1.500.608
22448-00A0C	1.970.432
22448-00Q0A	1.970.432
22448-00Q0B	1.970.432
22448-00Q0C	1.970.432
22448-00Q0E	1.970.596
22448-00Q0F	1.970.613
22448-00Q0G	1.970.432
22448-00QAA	1.970.432
22448-00QAB	1.970.432
22448-00QAC	1.970.596
22448-00QAD	1.970.419
22448-00QAE	1.970.432
22448-00QAH	1.970.432
22448-1E400	1.970.296

NISSAN

22448-1KCOA	1.970.551
22448-1KTOA	1.970.552
22448-1KT1A	1.970.552
22448-3RCOA	1.970.552
22448-6N000	1.970.557
22448-6N002	1.970.557
22448-6N010	1.970.557
22448-6N011	1.970.557
22448-6N012	1.970.557
22448-6N015	1.970.557
22448-95FOA	1.970.557
22448-AX001	1.970.602
22448-ED000	1.970.552
22448-ED800	1.970.489
22448-ED80A	1.970.489
22448-JA00A	1.970.552
22448-JA00C	1.970.552
22448-JA10A	1.970.533
22448-JA10C	1.970.533
22448-JA11C	1.970.533
22450-00Q0A	1.499.230
22450-00Q0B	1.499.244
22450-00Q0C	1.499.230
22450-00QAA	1.499.230
22450-00QAB	1.499.244
22450-71J25	1.500.609
22462-00Q0A	1.970.518
24488-00QAA	1.499.246
77001-07177	1.970.432
82006-72564	1.970.432
B2162-06W05	1.322.040

OPEL

01972927	1.312.073
01985771	1.312.074
03469033	1.306.080
1 46 015	1.406.024R
10458316	1.970.450
12 08 002	1.970.341
12 08 003	1.970.140
12 08 004	1.970.341
12 08 008	1.970.508
12 08 012	1.970.400
12 08 020	1.970.400
12 08 021	1.970.450
12 08 028	1.970.398
12 08 035	1.970.109
12 08 036	1.970.111
12 08 041	1.970.194
12 08 047	1.970.191
12 08 048	1.970.341
12 08 053	1.970.192
12 08 054	1.970.140
12 08 065	1.970.273
12 08 070	1.970.140
12 08 071	1.970.272
12 08 076	1.970.389
12 08 086	1.970.545
12 08 092	1.970.547
12 08 093	1.970.547
12 08 096	1.970.547
12 08 098	1.970.545
12 08 108	1.970.442
12 08 117	1.970.631
12 08 120	1.970.450
12 08 123	1.970.547
12 08 241	1.965.004
12 08 243	1.965.034
12 08 246	1.965.004
12 08 248	1.965.005
12 08 306	1.970.398
12 08 307	1.970.399
12 11 000	1.306.249
12 11 006	1.928.202 TM

OPEL		OPEL		OPEL		PEUGEOT	
12 11 250	1.306.081	12 82 154	1.501.559	44 32 202	1.970.432	5937 09	1.415.088
12 11 252	1.306.080	12 82 155	1.501.559	5 97 091	1.970.475	5937 16	1.415.091
12 11 253	1.306.076	12 82 156	1.501.559	55561655	1.970.545	5937 17	1.415.083R
12 11 256	1.306.099	12 82 163	1.501.904	55573735	1.970.547	5937 18	1.415.088R
12 11 258	1.312.073	12 82 164	1.501.904	55577898	1.970.547	5937 21	1.406.023R
12 11 260	1.312.074	12 82 165	1.501.904	55579072	1.970.547	5937 22	1.415.088
12 11 261	1.306.240 ^A	12 82 166	1.501.904	55584404	1.970.545	5937 25	1.406.056R
12 11 262	1.306.251	12635672	1.970.631	62 35 037	1.970.507	5937 26	1.406.049R
12 11 265	1.306.080	12670053	1.970.631	62 37 753	1.965.025	5937 28	1.415.094
12 11 266	1.328.099	12697989	1.970.631	90009490	1.106.212	5937 29	1.430.047R
12 11 267	1.306.080 ^A	16 12 001	1.501.506	90230575	1.306.240	5937 30	1.415.096R
12 11 268	1.306.249	16 12 005	1.206.047	90297426	1.306.251	5937 31	1.406.055R
12 11 269	1.306.256	16 12 006	1.206.029HV	90336536	1.306.257	5937 32	1.406.025R
12 11 270	1.306.257 ^A	16 12 011	1.206.034HVS	90350765	1.306.249	5937 34	1.415.091
12 11 271	1.328.100	16 12 013	1.501.506	90350988	1.306.256	5937 40	1.406.061R
12 11 273	1.306.258	16 12 229	1.212.055HVS	90350997	1.328.100	5937 42	1.406.119R
12 11 275	1.315.084	16 12 385	1.206.034HVS	90443900	1.970.273	5937 43	1.415.094
12 11 276	1.306.257 ^A	16 12 433	1.206.049HVS	90449572	1.970.273	5937 44	1.415.104
12 11 582	1.965.025	16 12 434	1.500.509	90449739	1.970.140	5937 47	1.415.102R
12 11 591	1.965.025	16 12 459	1.500.514	90458250	1.970.272	5937 49	1.415.096R
12 12 125	1.912.011	16 12 477	1.501.942	90506102	1.970.389	5937 51	1.406.026R
12 12 126	1.912.010	16 12 479	1.500.514	90510386	1.970.140	5940 52	1.306.241
12 12 128	1.306.062	16 12 497	1.500.527	90543059	1.970.398	5940 52	1.406.026R
12 12 131	1.306.072	16 12 512	1.500.956	90543253	1.970.400	5941 06	1.315.049
12 12 135	1.306.072	16 12 523	1.500.513	91 19 567	1.970.508	5941 08	1.315.049
12 12 136	1.306.076	16 12 524	1.500.514	91 98 834	1.970.507	5941 20	1.315.049
12 12 137	1.306.076	16 12 527	1.500.513	91159996	1.970.432	5941 23	1.315.054
12 12 138	1.306.072	16 12 531	1.500.527	93161188	1.970.432	5941 26	1.315.058
12 12 140	1.312.066	16 12 532	1.500.513	93161948	1.970.432	5941 27	1.306.079
12 12 141	1.306.081	16 12 533	1.501.237	93177212	1.970.400	5941 28	1.315.059
12 12 143	1.306.079	16 12 539	1.500.514	93180806	1.970.398	5941 30	1.330.101
12 12 147	1.306.062	16 12 541	1.501.237	95512934	1.970.442	5941 32	1.306.124
12 12 154	1.212.055HVS	16 12 542	1.500.514	95517924	1.970.450	5941 41	1.315.067
12 12 200	1.428.028R	16 12 543	1.500.634	95528319	1.970.547	5941 42	1.306.236 ^A
12 12 203	1.412.100	16 12 544	1.501.237	9671214580	1.970.609	5941 43	1.330.098
12 12 204	1.415.103R	16 12 545	1.500.513	9675390980	1.970.620	5941 44	1.306.241
12 12 206	1.406.127R	16 12 552	1.500.688	RP 1 212 007	1.206.034HVS	5941 45	1.315.077
12 12 207	1.415.103R	16 12 556	1.501.237	RP 1 212 154	1.212.055HVS	5941 46	1.315.074
12 12 208	1.412.093	16 12 557	1.501.237	RP121201	1.206.047	5941 47	1.306.252 ^A
12 12 213	1.406.026R	16 12 558	1.500.689	RP121202	1.206.029HV	5941 48	1.315.077
12 12 216	1.406.055R	16 12 559	1.500.689			5945 02	1.965.005
12 12 217	1.406.056R	16 12 560	1.500.689			5945 03	1.965.005
12 12 218	1.412.096	16 12 561	1.500.688			5945 10	1.230.146M
12 12 219	1.406.061R	16 12 591	1.500.634			5945 25	1.965.005
12 12 220	1.406.056R	16 12 592	1.500.634			5945 31	1.965.005
12 12 221	1.412.097	16 12 598	1.501.562			5945 33	1.965.005
12 12 222	1.406.121R	16 12 606	1.501.529			5945 39	1.965.005
12 12 224	1.406.127R	16 12 607	1.501.529			5945 48	1.965.005
12 12 253	1.106.212	16 12 608	1.501.531	5900 H1	1.915.019 ^{FN}	5945 51	1.965.034
12 12 259	1.106.212	16 12 610	1.501.237	5900 H7	1.915.019 ^{FN}	5948 04	1.142.056
12 12 260	1.106.212	16 12 639	1.501.529	5900 H9	1.915.019 ^{FN}	5948 05	1.115.023
12 16 011	1.206.034HVS	16 12 646	1.501.506	5900 J1	1.915.019 ^{FN}	5948 06	1.115.023
12 37 334	1.965.036 ^J	16 12 651	1.500.634	5900 K3	1.915.019 ^{FN}	5948 11	1.115.034
12 37 464	1.965.036 ^J	16 12 657	1.501.904	5900 K6	1.915.019 ^{FN}	5948 17	1.115.034
12 37 504	1.965.025	17 84 226	1.406.012R	5900 K7	1.915.019 ^{FN}	5948 17	1.115.034
12 82 044	1.499.195	17 84 228	1.412.093R	5904 06	1.906.153	5948 27	1.115.034
12 82 044	1.499.199	17 84 231	1.412.093R	5904 25	1.906.159	5967 79	1.500.846
12 82 077	1.500.688	17 84 234	1.412.095R	5904 F1	1.930.178M	5967 84	1.500.846
12 82 078	1.500.688	17 84 235	1.406.012R	5904 K3	1.915.017	5967 C3	1.500.747
12 82 079	1.500.688	19005212	1.970.399	5904 K8	1.915.019	5967 E5	1.500.748
12 82 080	1.500.688	25195107	1.970.547	5904 K9	1.915.017	5967 H5	1.500.748
12 82 084	1.499.195	25198623	1.970.547	5904 L3	1.915.019	5967 H5	1.500.748
12 82 089	1.499.195	3474283	1.970.140	5904 P5	1.915.019	5967 K4	1.500.748
12 82 090	1.499.195	3639500	1.970.609	5905 09	1.906.153	5967 K6	1.500.780
12 82 091	1.499.195	3639845	1.970.620	5927 09	1.215.055	5967 K7	1.500.747
12 82 133	1.499.199	3648847	1.970.475	5927 30	1.206.040	5967 K9	1.500.491
12 82 134	1.499.199	42 91 891	1.413.030	5927 35	1.215.112U	5967 L0	1.500.674
12 82 135	1.499.199	42 94 009	1.313.093	5927 43	1.215.076	5967 L1	1.500.494
12 82 141	1.499.199	42 94 029	1.970.219	5927 44	1.215.076	5967 L6	1.500.494
12 82 142	1.501.947	43 00 976	1.313.254	5927 50	1.206.034HVS	5967 L7	1.500.674
12 82 143	1.501.947	43 00 982	1.322.060	5927 65	1.206.049HVS	5967 L8	1.500.494
12 82 144	1.501.947	43 12 974	1.422.069	5927 73	1.215.102	5967 L9	1.501.025
12 82 145	1.501.947	43 13 484	1.413.030	5927 83	1.215.103	5967 N1	1.500.494
12 82 146	1.501.559	44 08 283	1.970.432	5927 90	1.965.005	5967 N2	1.500.655
12 82 147	1.501.559	44 08 389	1.970.432	5927 92	1.215.105	5967 N6	1.501.374
12 82 153	1.501.559	44 13 233	1.970.432	5927 96	1.215.103	5967 N7	1.500.674
				5937 05	1.415.091	5967 P1	1.501.374
						5970 11	1.970.101D

PEUGEOT

PEUGEOT

5970 28	1.970.101D
5970 42	1.970.106
5970 43	1.970.105
5970 45	1.970.155
5970 48	1.970.188
5970 49	1.970.189
5970 53	1.970.168
5970 64	1.970.475
5970 70	1.970.188
5970 72	1.970.403
5970 74	1.970.403
5970 75	1.970.408
5970 76	1.970.509
5970 78	1.970.405
5970 79	1.970.405
5970 80	1.970.407
5970 84	1.970.509
5970 85	1.970.483
5970 87	1.970.476
5970 88	1.970.461
5970 90	1.970.405
5970 91	1.970.475
5970 92	1.970.476
5970 96	1.970.497
5970 97	1.970.405
5970 98	1.970.408
5970 99	1.970.407
5970 A0	1.970.476
5970 A5	1.970.509
5970 A6	1.970.476
5970 A8	1.970.405
5970 A9	1.970.403
5970 C0	1.970.461
5970 C1	1.970.461
5979 A8	1.970.405
96 035 284	1.970.155
96 062 288	1.970.189
96 228 897	1.970.188
96 246 755 80	1.970.403
96 281 585 80	1.970.403
96 566 957 80	1.970.476
96 712 145 80	1.970.609
96 753 909 80	1.970.620
98 067 027 80	1.970.475
98 078 418 80	1.970.475

PIAGGIO

19102-87704-000	1.413.030
498325	1.930.180M
498327	1.965.020

PORSCHÉ

177 860 820 20	1.206.034HVS
616 602 215 00	1.306.062
616 602 215 02	1.306.076
616 602 221 00	1.406.018R
616 602 221 05	1.406.021R
616 602 223 00	1.206.034HVS
616 602 226 00	1.206.021
616 602 226 02	1.206.047
901 602 901 00	1.306.072
901 602 928 00	1.406.012R
901 602 932 00	1.230.132
901 602 960 00	1.206.049HVS
901 602 960 03	1.206.047
901 602 963 00	1.306.072
923 602 929 00	1.406.025R
928 602 211 01	1.306.128 ^A
928 602 706 01	1.965.034
928 602 902 00	1.306.090 ^A
928 602 904 03	1.406.023R
930 602 902 00	1.406.024R

PORSCHÉ

930 602 902 01	1.406.113R
930 602 902 02	1.406.113R
930 602 904 00	1.306.081
930 602 908 00	1.306.081
930 602 919 00	1.306.123 ^A
931 602 906 00	1.406.055R
944 602 251 00	1.306.117 ^A
944 602 901 00	1.406.070R
944 602 902 00	1.306.117 ^A
944 602 906 01	1.406.070R
955 602 101 00	1.970.434
955 602 101 01	1.970.434
955 602 101 02	1.970.434
955 602 101 03	1.970.434
955 602 101 04	1.970.434
955 602 101 05	1.970.434
958 602 101 00	1.970.434
958 602 102 00	1.970.427
958 905 110 00	1.970.636
958 905 110 01	1.970.636
PAB 905 715	1.970.434
PAC 905 110	1.970.636
PAC 905 110 A	1.970.636

PUCH

000 158 71 03	1.970.316
302 3 50 015 0	1.206.068
364 4 50 513 2	1.106.030
A 000 150 02 80	1.970.316
E 023 015	1.206.068
E 644 513	1.106.030

RELIANT

17 241	1.328.075
17 509	1.228.083MHV
90 792	1.328.078
91 119	1.328.078
210 803	1.219.044HV

RENAULT

08 02 119 800	1.142.056
08 51 874 100	1.315.049
08 51 877 600	1.142.056
08 53 712 500	1.115.023
08 54 120 600	1.415.091
08 54 137 800	1.215.055
08 54 233 000	1.142.056
08 54 719 900	1.315.041
08 54 720 000	1.415.081
08 54 725 600	1.215.061
08 54 910 100	1.142.056
08 54 913 400	1.342.043
08 54 921 500	1.242.054
08 54 923 300	1.142.056
08 54 943 800	1.142.056
08 54 954 600	1.215.056
08 55 054 100	1.415.083R
08 57 113 200	1.330.069
08 57 113 600	1.230.132
08 57 113 700	1.417.052
22 43 324 28R	1.970.613
22 43 325 97R	1.970.432
22 43 327 34R	1.970.552
22 43 335 29R	1.970.432
22 43 361 34R	1.970.596
22 43 392 77R	1.970.552
22 44 81K COA	1.970.551

RENAULT

22 44 81K TOA	1.970.552
22 44 83R COA	1.970.552
22 44 8JA 00C	1.970.552
22 44 8JA 10C	1.970.533
60 01 543 604	1.970.596
60 25 003 011	1.500.539
60 25 003 095	1.500.543
74 01 275 174	1.990.423
74 31 275 284	1.499.061
74 31 367 783	1.406.147R
74 33 501 944	1.306.260
74 39 135 700	1.499.064
74 39 445 258	1.499.064
77 00 100 589	1.970.376
77 00 100 643	1.970.378
77 00 102 012	1.315.072 ^M
77 00 106 221	1.501.492
77 00 107 177	1.970.432
77 00 107 269	1.970.196
77 00 107 662	1.501.447
77 00 113 357	1.970.432
77 00 113 357 A	1.970.432
77 00 114 549	1.501.681
77 00 267 693	1.406.119R
77 00 267 694	1.306.236 ^A
77 00 267 728	1.306.236 ^A
77 00 273 226	1.501.443
77 00 273 826	1.499.244
77 00 274 008	1.970.596
77 00 552 370	1.970.101D
77 00 562 370	1.970.101D
77 00 682 481	1.500.839
77 00 720 781	1.500.539
77 00 720 842	1.500.539
77 00 726 529	1.500.839
77 00 726 626	1.500.543
77 00 726 736	1.315.069
77 00 727 261	1.415.097
77 00 729 838	1.315.091 ^B
77 00 730 116	1.315.066 ^B
77 00 733 982	1.315.073 ^M
77 00 736 209	1.315.072 ^M
77 00 739 893	1.315.083 ^B
77 00 740 118	1.500.539
77 00 741 025	1.500.415
77 00 742 835	1.500.801
77 00 742 837	1.500.802
77 00 742 853	1.315.083 ^B
77 00 743 290	1.315.083 ^M
77 00 743 602	1.315.083 ^M
77 00 749 450	1.970.228
77 00 749 516	1.500.415
77 00 749 516	1.500.802
77 00 749 517	1.500.801
77 00 749 521	1.501.332
77 00 749 521	1.501.497
77 00 749 877	1.500.415
77 00 850 462	1.500.539
77 00 850 463	1.500.543
77 00 850 475	1.500.802
77 00 851 781	1.315.072 ^M
77 00 854 306	1.970.275
77 00 854 307	1.970.276
77 00 855 322	1.500.415
77 00 855 902	1.501.497
77 00 857 045	1.501.332
77 00 857 980	1.500.920
77 00 857 981	1.500.920
77 00 857 981	1.501.499
77 00 859 053	1.315.086 ^M
77 00 863 020	1.970.355
77 00 863 021	1.970.356
77 00 866 923	1.501.446
77 00 872 265	1.970.275
77 00 872 449	1.970.365
77 00 872 692	1.970.276

RENAULT

77 00 872 834	1.970.365
77 00 873 186	1.501.499
77 00 874 109	1.501.447
77 00 874 564	1.501.501
77 00 875 000	1.970.432
77 01 000 998	1.142.056
77 01 003 813	1.242.054
77 01 008 141	1.242.054
77 01 008 855	1.142.056
77 01 012 471	1.142.056
77 01 012 533	1.206.049HVS
77 01 012 535	1.406.012R
77 01 012 536	1.306.079
77 01 012 957	1.315.045
77 01 018 729	1.115.034
77 01 019 468	1.315.049
77 01 019 885	1.415.081
77 01 019 886	1.315.041
77 01 020 079	1.115.034
77 01 020 357	1.415.088
77 01 020 378	1.342.043
77 01 020 784	1.315.054
77 01 021 676	1.142.056
77 01 021 905	1.406.023R
77 01 021 981	1.415.091
77 01 022 130	1.115.023
77 01 022 175	1.315.041
77 01 025 237	1.428.012
77 01 025 238	1.228.089
77 01 025 240	1.330.098
77 01 025 241	1.430.047R
77 01 026 824	1.415.094
77 01 027 411	1.315.059
77 01 027 491	1.315.059
77 01 027 870	1.415.094
77 01 029 263	1.306.079
77 01 029 971	1.315.063
77 01 029 972	1.415.097
77 01 029 973	1.315.070
77 01 030 505	1.330.101
77 01 031 135	1.970.107
77 01 031 149	1.215.126 ^P
77 01 031 411	1.215.127 ^P
77 01 031 989	1.230.148M
77 01 032 418	1.215.126 ^P
77 01 033 621	1.315.081
77 01 033 622	1.415.101
77 01 034 946	1.330.111
77 01 034 947	1.430.059
77 01 041 607	1.970.355
77 01 041 608	1.970.356
77 01 041 745	1.306.236 ^A
77 01 065 086	1.970.489
77 01 200 739	1.215.086
77 01 200 876	1.206.040
77 01 202 293	1.315.063
77 01 202 683	1.315.066 ^M
77 01 202 755	1.315.088 ^M
77 01 203 118	1.315.082
77 01 203 118	1.315.083 ^M
77 01 348 252	1.970.101D
77 01 349 467	1.500.543
77 01 349 467	1.500.839
77 01 349 468	1.500.839
77 02 001 761	1.230.132
77 02 037 711	1.206.034HVS
77 02 037 713	1.406.012R
77 02 038 122	1.306.079
77 02 038 190	1.230.140
77 02 038 439	1.406.025R
77 02 124 314	1.217.024
77 02 124 317	1.117.097
77 02 124 320	1.417.058
77 02 124 325	1.317.023
77 02 163 081	1.217.026
82 00 025 256	1.970.419

RENAULT

82 00 035 420	1.970.432
82 00 084 401	1.970.419
82 00 122 243	1.499.049
82 00 141 149	1.970.365
82 00 154 186	1.970.432
82 00 154 186 A	1.970.432
82 00 208 611	1.970.432
82 00 380 267	1.970.432
82 00 405 098	1.970.432
82 00 486 877	1.499.230
82 00 506 297	1.499.244
82 00 568 671	1.970.432
82 00 575 895	1.499.229
82 00 672 564	1.970.432
82 00 702 693	1.970.518
82 00 713 680	1.499.246
82 00 765 882	1.970.432
82 00 805 133	1.499.230
82 00 943 801	1.499.252
85 51 874 100	1.315.049
89 00 568 671	1.970.432
89 33 003 389	1.419.092
89 33 004 024	1.319.093
89 56 026 876	1.319.093
H77 00 873 701	1.970.596
H77 00 875 000	1.970.432
H82 01 154 128	1.970.613

ROLLS-ROYCE

12 13 5 A06 753	1.970.475
12 13 7 571 643	1.970.475
12 13 8 616 153	1.970.475
12 13 8 657 273	1.970.475
UE 46152	1.406.070R
UE 46153	1.306.117 ^A

ROVER

AUU1186	1.328.093
AUU1641	1.428.029R
AUU1690	1.428.024R
ERR6045	1.970.168
GCL110	1.970.101D
GCL145	1.970.211
GCL146	1.970.211
GCL161	1.970.213
GCL195	1.970.214
GCL201	1.970.374
GCL204	1.970.189
GCL207	1.970.347
GCS124	1.228.089
GDC136	1.328.078
GDC152	1.328.093
GDC156	1.328.094
GDC160	1.328.093
GDC214	1.315.049
GDC346	1.322.069
GDC347	1.322.069
GDC377	1.328.093
GDC384	1.328.093
GDC405	1.322.068
GDC406	1.322.068
GDC407	1.322.082
GHT274	1.501.711
GHT284	1.501.888
GHT287	1.501.914
GRA114	1.428.012
GRA138	1.428.024R
GRA143	1.428.025
GRA2123	1.415.091
GRA2138	1.428.024R

ROVER

GRA2143	1.428.025
GRA2236	1.406.060R
GRA2245	1.422.056
GRA2264	1.406.060R
GRA2274	1.428.024R
GRA2285	1.428.029R
GRA2287	1.422.082
GRA2310	1.428.029R
GRA2324	1.422.095
GRA2327	1.422.098
GSC113	1.115.034
NEC100530	1.970.214
NEC100630	1.970.374
NEC100630SLP	1.970.374
NEC100631	1.970.374
NEC100710	1.970.189
NEC100750	1.970.347
NEC101000	1.970.413
NEC101000SLP	1.970.413
NEC101010	1.970.413
NGC000040	1.501.889
NGC000060	1.501.914
NGC000090	1.501.888
NJD10006	1.322.069
NJD10008	1.322.069
NJD10009	1.322.069
NJD10010	1.328.093
NJD100150	1.322.068
NJD100190	1.322.082
NJD100200	1.328.106
NJE100060	1.422.095
NJE100070	1.428.029R
NJE100100	1.422.102
NJI100030	1.422.098
NJL100030	1.965.052
NJL100040	1.965.052
NJW100030	1.965.052
RTC3433	1.970.101D
RTC6620	1.115.034
RTC6627	1.228.089
STC8368	1.328.091

SAAB

10 458 316	1.970.450
12 08 053	1.970.192
30 584 237	1.970.192
40 23 149	1.965.034
42 26 031	1.970.192
51 71 111	1.970.192
59 60 059	1.965.034
74 86 822	1.906.193
75 01 216	1.306.079
75 03 600	1.965.034
75 19 309	1.406.055R
75 64 420	1.406.123R
78 63 236	1.406.012R
78 66 353	1.206.034HVS
78 66 932	1.306.076
83 52 346	1.306.079
83 55 919	1.206.049HVS
83 55 935	1.306.079
83 55 950	1.406.025R
85 22 328	1.970.101D
88 17 520	1.501.138
88 22 686	1.406.121R
88 57 617	1.906.244 ^N
89 80 534	1.965.007
90 350 021	1.970.192
90 350 987	1.970.192
90 369 434	1.970.192
91 19 567	1.970.508
91 70 259	1.306.124
93 06 697	1.406.025R

SAAB

93 37 346	1.501.140
93 50 323	1.406.026R
93 51 743	1.106.195
93 55 488	1.406.026R
93 59 597	1.206.049HVS
93 90 220	1.965.004

SEAT

000 389 117 3	1.230.132
000 389 287 3	1.417.052
000 389 806 0	1.130.117
000 389 806 5	1.430.042R
000 389 842 4	1.415.083R
000 389 948 9	1.430.054R
000 389 973 1	1.115.039
000 389 976 9	1.330.098
000 389 977 0	1.430.047R
000 389 978 9	1.317.014
000 398 066 5	1.306.079
000 398 066 6	1.406.056R
000 398 090 7	1.330.101
000 992 918 8	1.230.142
000 993 470 8	1.415.091
000 993 623 8	1.430.042R
000 993 667 7	1.215.106
000 993 673 4	1.115.039
000 993 673 5	1.315.058
000 993 681 4	1.317.016
000 993 683 1	1.417.052R
000 993 686 6	1.415.083R
007083.06	1.230.120
008415.06	1.430.029
022 905 100 A	1.970.435
022 905 100 D	1.970.435
022 905 100 E	1.970.434
022 905 100 G	1.970.435
022 905 100 H	1.970.434
022 905 100 K	1.970.435
022 905 100 N	1.970.435
022 905 100 P	1.970.434
022 905 715	1.970.434
022 905 715 C	1.970.435
026 905 207 2	1.306.094
026 905 207 A	1.315.068
026 905 225 2	1.406.121R
026 905 225 K	1.415.099R
026 905 359 2	1.906.233
027 905 207 A	1.306.266
030 905 065	1.906.223
030 905 065 B	1.906.223
030 905 205 AE	1.930.182 ^N
030 905 207	1.306.094
030 905 207 A	1.330.116
030 905 225 C	1.430.057R
030 905 430 J	1.501.595
030 905 430 K	1.501.595
030 905 430 L	1.501.595
030 905 430 M	1.501.595
030 905 430 N	1.501.601
030 905 430 P	1.501.601
030 905 430 Q	1.501.601
030 905 430 R	1.501.601
030 998 065	1.906.193
030 998 065 B	1.906.234
032 905 106	1.990.420
032 905 106 B	1.990.420
032 905 106 D	1.990.420
032 905 106 E	1.990.420
032 905 106 F	1.990.420
032 905 430 B	1.501.569
032 905 430 C	1.501.569
032 905 430 E	1.501.569
036 905 100 A	1.970.474
036 905 100 B	1.970.474

SEAT

036 905 100 C	1.970.474
036 905 100 D	1.970.474
036 905 225 H	1.406.056R
036 905 430 AA	1.501.575
036 905 430 AB	1.501.575
036 905 430 AC	1.501.575
036 905 430 AD	1.501.575
036 905 430 AE	1.501.575
036 905 430 H	1.501.575
036 905 430 J	1.501.575
036 905 430 K	1.501.575
036 905 430 L	1.501.575
036 905 430 M	1.501.575
036 905 430 N	1.501.575
036 905 430 Q	1.501.575
036 905 430 R	1.501.575
036 905 430 S	1.501.575
036 905 430 T	1.501.575
036 905 715	1.970.474
036 905 715 A	1.970.474
036 905 715 C	1.970.474
036 905 715 E	1.970.474
036 905 715 F	1.970.474
036 905 715 G	1.970.474
036 905 715 H	1.970.474
037 905 205 M	1.906.223 ^N
037 905 207	1.306.263
03D 905 115 F	1.970.431
03D 905 115 G	1.970.431
03D 905 715 A	1.970.431
04C 905 110 B	1.970.599
04C 905 110 D	1.970.599
04C 905 110 E	1.970.599
04C 905 110 H	1.970.599
04C 905 110 J	1.970.599
04C 905 110 L	1.970.599
04E 905 110	1.970.599
04E 905 110 A	1.970.599
04E 905 110 B	1.970.599
04E 905 110 E	1.970.599
04E 905 110 K	1.970.599
04E 905 110 P	1.970.599
050 905 205 A	1.906.159 ^N
050 905 205 AH	1.906.223 ^N
051 905 205	1.906.159 ^N
051 905 205 C	1.906.233 ^N
051 905 207	1.306.266
051 905 225	1.406.121R
052 905 225 C	1.406.121R
055 905 225 B	1.406.055R
058 905 105	1.970.354S
06A 905 115	1.970.429
06A 905 115 A	1.970.429
06A 905 115 B	1.970.429
06A 905 115 C	1.970.429
06A 905 115 D	1.970.429
06A 905 430 AA	1.501.484
06A 905 430 AC	1.501.585
06A 905 430 AD	1.501.585
06A 905 430 AE	1.501.585
06A 905 430 AG	1.501.585
06A 905 430 H	1.501.585
06A 905 430 J	1.501.585
06A 905 430 K	1.501.585
06A 905 430 L	1.501.585
06A 905 430 M	1.501.489
06A 905 430 N	1.501.489
06A 905 430 P	1.501.489
06A 905 430 Q	1.501.489
06A 905 430 R	1.501.484
06A 905 430 S	1.501.484
06A 905 430 T	1.501.484
06B 905 115 B	1.970.445
06B 905 115 D	1.970.429
06B 905 115 E	1.970.445
06B 905 115 G	1.970.429

SOLO

05 20 100	1.106.030
05 20 144	1.206.071
05 20 145	1.106.180
05 20 146	1.206.083

SSANGYONG

0001587003	1.970.316
0001587103	1.970.316
0001587503	1.970.316

STERLING

182 182 000 30	1.970.211
----------------	------------------

SUBARU

22107-KA080	1.231.084
22136-KA050	1.231.084^F
22157-AA030	1.422.052
22157-AA040	1.422.073
22157-AA080	1.422.093
22157-KA010	1.422.073
22157-KA020	1.413.030
22157-KA030	1.422.073
22157-KA040	1.413.029
22157-KA060	1.431.119
22162-AA030	1.322.058
22162-AA040	1.322.046
22162-AA060	1.322.075
22162-AA090	1.331.145
22162-KA010	1.313.241
22162-KA020	1.322.041
22162-KA050	1.322.041
22162-KA100	1.313.259
22433-AA230	1.970.265
22433-AA240	1.970.266
22433-AA360	1.970.265
22433-AA370	1.970.266
22451-AA341	1.501.835
22451-AA450	1.501.835
22451-AA511	1.501.835
22451-AA630	1.501.835
22451-AA640	1.501.835
22451-AA660	1.501.817
22451-AA660	1.501.819
22451-AA661	1.499.100
22451-AA661	1.501.817
22451-AA661	1.501.819
22451-AA710	1.499.100
22451-AA710	1.501.817
22451-AA74A	1.501.835
22451-AA780	1.501.819
22451-AA781	1.501.819
22451-AA793	1.501.887
22451-AA800	1.501.813
22451-AA810	1.501.813
22451-AA822	1.501.887
22451-AA890	1.499.100
22451-AA940	1.499.106
22452-AA112	1.501.835
22452-AA120	1.501.835
22452-AA160	1.501.835
22452-AA682	1.501.887
22452-AA690	1.499.106
22453-AA140	1.499.106
22454-AA140	1.499.106
33310-71C30	1.413.028
33321-63B10	1.313.123
33400-62J00	1.970.570
33400-83E10	1.970.570

SUBARU

39100-0601	1.322.003
39101-4302	1.413.014
39146-4302	1.213.022HV
39146-4312	1.213.022HV
49100-5501	1.322.048
49100-8711	1.322.057
49101-3202	1.413.014
49101-7102	1.413.014
49101-8711	1.422.052
49146-7011	1.222.056HV
89100-4111	1.322.003
89146-4111	1.222.056HV
89146-4821	1.222.056HV
90919-02257	1.970.537

SUZUKI

33140-74010	1.213.011HV
33140-74010-000	1.213.011HV
33310-56B10	1.431.131
33310-56B10-000	1.431.131
33310-60B50	1.413.034
33310-60B50-000	1.413.034
33310-60C30	1.431.131
33310-60C30-000	1.431.131
33310-60C31	1.431.131
33310-60C31-000	1.431.131
33310-63B10	1.413.028
33310-63B10-000	1.413.028
33310-70B50	1.431.119
33310-70B50-000	1.431.119
33310-70E00	1.431.136
33310-70E00-000	1.431.136
33310-70E01	1.431.136
33310-70E01-000	1.431.136
33310-71C30	1.413.028
33310-71C30-000	1.413.028
33310-73010	1.413.014
33310-73010-000	1.413.014
33310-75F00	1.422.073
33310-75F00-000	1.422.073
33310-77090	1.413.014
33310-77090-000	1.413.014
33310-80C10	1.413.036
33310-80C10-000	1.413.036
33310-82010	1.413.030
33310-82010-000	1.413.030
33310-82032	1.431.108
33310-82032-000	1.431.108
33310-82110	1.413.030
33310-82110-000	1.413.030
33310-82610	1.413.028
33310-82610-000	1.413.028
33310-86240	1.431.108
33310-86240-000	1.431.108
33321-56B10	1.331.140
33321-56B10-000	1.331.140
33321-58B10	1.331.144
33321-58B10-000	1.331.144
33321-60A10	1.313.093
33321-60A10-000	1.313.093
33321-62E10	1.331.131
33321-62E10-000	1.331.131
33321-63B10	1.313.123
33321-63B10-000	1.313.123
33321-63B40	1.331.132
33321-63B40-000	1.331.132
33321-64B10	1.322.046
33321-64B10-000	1.322.046
33321-75110	1.313.093
33321-75110-000	1.313.093
33321-78110	1.313.107
33321-78110-000	1.313.107
33321-78B40	1.331.139

SUZUKI

33321-78B40-000	1.331.139
33321-79210	1.313.102
33321-79210-000	1.313.102
33321-79611	1.313.107
33321-79611-000	1.313.107
33321-80C10	1.313.256
33321-80C10-000	1.313.256
33321-82010	1.313.107
33321-82010-000	1.313.107
33321-85570	1.313.245
33321-85570-000	1.313.245
33321-86510	1.313.123
33321-86510-000	1.313.123
33400-60R00	1.970.621
33400-60R00-000	1.970.621
33400-62J00	1.970.570
33400-62J00-000	1.970.570
33400-65G00	1.970.535
33400-65G00-000	1.970.535
33400-65G01	1.970.535
33400-65G01-000	1.970.535
33400-65G02	1.970.535
33400-65G02-000	1.970.535
33400-78P00	1.970.621
33400-78P00-000	1.970.621
33400-81P00	1.970.621
33400-81P00-000	1.970.621
33400-83E10	1.970.570
33400-83E10-000	1.970.570
33400M68P10	1.970.621
33400M68P10-000	1.970.621
33400M79F00	1.970.570
33400M79F00-000	1.970.570
33400M83E10	1.970.570
33400M83E10-000	1.970.570
33410-57B10	1.970.201
33410-57B10-000	1.970.201
33410-66D00	1.970.591
33410-66D00-000	1.970.591
33410-66D01	1.970.591
33410-66D01-000	1.970.591
33410-66D10	1.970.591
33410-66D10-000	1.970.591
33410-80C10	1.970.201
33410-80C10-000	1.970.201
33700-51G10	1.501.413
33700-51G10-000	1.501.413
33700-60A10	1.501.415
33700-60A10-000	1.501.415
33700-60A20	1.501.415
33700-60A20-000	1.501.415
33700-80001	1.499.020
33700-80001-000	1.499.020
33700-80012	1.499.020
33700-80012-000	1.499.020
33700-82610	1.499.020
33700-82610-000	1.499.020
33700-83010	1.499.020
33700-83010-000	1.499.020
33700-83020	1.501.417
33700-83020-000	1.501.417
33700M70FA0	1.499.231
33700M70FA0-000	1.499.231
33705-51G10	1.501.413
33705-51G20	1.501.434
33705-51G20-000	1.501.434
33705-57B21	1.499.004
33705-66D00	1.499.005
33705-66D00-000	1.499.005
33705-75F02-000	1.499.028
33705-75F03-000	1.499.028
33705-80040	1.499.020
33705-80040-000	1.499.020
33705-80G00	1.499.013
33705-80G00-000	1.499.013
33705-83020	1.501.417

SUZUKI

33705-83020-000	1.501.417
33705-86G00	1.499.013
33705-86G00-000	1.499.013
33705M79F00	1.499.005
33705M79F00-000	1.499.005
33710-51G10-000	1.501.413
33710-57B20	1.499.004
33710-57B20-000	1.499.004
33710-63B30-000	1.501.413
33710-75F00-000	1.499.028
33710-80010	1.499.020
33710-80010-000	1.499.020
33710-82010	1.501.413
33710-82010-000	1.501.413
33710-83020	1.501.417
33710-83020-000	1.501.417
33710-86001-000	1.501.413
33710M70F30	1.499.231
33710M70F30-000	1.499.231
33730-86G00-000	1.499.013
33740-86G00-000	1.499.013

TALBOT

0013 52 9900	1.406.025R
0013 56 6600	1.906.153
0016 85 6600	1.315.058
0017 67 1000	1.315.054
0017 67 1100	1.415.091
0043 21 2900	1.415.094
0043 23 7300	1.406.061R
0055 50 5600	1.970.101D
0057 18 9700	1.965.005
0060 06 6500	1.230.132
0174 98 900	1.206.034HVS
1350 02 00	1.315.049
1350 03 00	1.415.091
1352 99 00	1.406.025R
1353 00 00	1.306.079
1356 65 00	1.306.079
1361 48 00	1.115.034
1361 51 00	1.215.111U
1364 49 00	1.206.034HVS
1685 66 00	1.315.058
1690 1	1.315.049
1743 05 00	1.115.034
1832 10 01	1.306.079
1832 20 01	1.406.025R
2009 9Z	1.215.055
2882 9V	1.115.023
3065 2H	1.315.045
3792 5	1.115.034
3798 9P	1.215.111U
3888 0	1.315.045
4033 01 9620	1.206.034HVS
4519 2Q	1.215.067
4613 6	1.315.045
5043 70 9	1.328.075
5135 00 300	1.415.091
7506 20 75	1.228.083MHV
7506 37 64	1.428.012
7506 60 02	1.415.091
7506 63 87	1.328.078
9150 49 1280	1.965.005
9150 63 3880	1.965.005
9405 92 7838	1.215.103
9405 93 7228	1.415.088
9405 94 8178	1.115.034
9611 6	1.415.083R

TOYOTA

04191-41010	1.213.011HV
-------------	--------------------

VALEO		VALEO		VALEO		VALEO	
CB 035	1.231.084	CD 025	1.406.112R	D 816	1.315.074	2 524 134	1.315.074
CB 036	1.230.146M	CD 026	1.406.114R	D 842	1.315.077	2 525 628	1.315.078 ^M
CB 039	1.215.076	CD 027	1.406.116R	D 870	1.315.063	2 526 009	1.970.106
CB 042	1.206.040	CD 028	1.406.121R	D 871	1.315.072 TM	2 526 015	1.970.102
CB 043	1.206.049HVS	CD 029	1.430.041	D 881	1.415.104	2 526 017	1.970.101D
CB 044	1.230.120	CD 030	1.430.051R	D 888	1.315.080	2 526 017 0	1.970.101D
CB 045	1.230.132	CD 031	1.430.054R	D 889	1.315.081	2 526 023	1.970.107
CB 046	1.230.139	CD 032	1.430.060	D 901	1.415.083R	2 526 026	1.970.155
CB 047	1.230.140	CD 033	1.406.060R	D 902	1.415.081	2 526 026 A	1.970.155
CB 048	1.228.083MHV	CD 034	1.428.026R	D 905	1.415.089R	2 526 030	1.970.108
CB 050	1.219.044HV	CD 035	1.430.047R	D 908	1.415.094	2 526 034	1.970.228
CB 052	1.217.026	CD 036	1.430.055R	D 909	1.415.088	2 526 035 A	1.970.189
CB 055	1.230.149M	CD 038	1.412.096	D 910	1.415.096R	2 526 037 A	1.970.188
CB 060	1.215.101	CD 040	1.415.096R	D 911	1.415.091	2 526 039	1.970.189
CB 070	1.215.067	CD 042	1.406.026R	D 913	1.415.099R	2 526 040 A	1.970.188
CB 304	1.106.212	CD 048	1.415.099R	D 936	1.415.104	2 526 048	1.970.107
CB 310	1.130.117	CD 049	1.417.058	D 964	1.415.097	2 526 048 A	1.970.107
CB 318	1.115.023	CD 050	1.415.101	E 456	1.217.026	2 526 049	1.970.140
CB 319	1.115.034	CD 051	1.406.025R	E 833	1.317.016	2 526 050	1.970.341
CB 331	1.106.196	CD 303	1.970.101D	E 928	1.430.029	2 526 051	1.970.355
CB 336	1.106.257	CD 308	1.970.105	F 420	1.219.043HV	2 526 052	1.970.356
CB 338	1.130.127	CD 309	1.970.101D	F 421	1.219.044HV	2 526 055	1.970.272
CB 344	1.115.023	CD 315	1.970.101D	F4036	1.319.083	2 526 055 A	1.970.272
CB 601	1.306.093	CD 321	1.970.106	F4521	1.419.085	2 526 060	1.970.103
CB 602	1.306.094	CD 323	1.970.101D	J 436	1.213.011HV	2 526 062	1.970.111
CB 603	1.306.109	CD 324	1.970.102	J 438	1.222.056HV	2 526 063	1.970.109
CB 604	1.306.109	CD 325	1.970.107	J 454	1.213.022HV	2 526 071	1.970.125
CB 605	1.306.129	CD 328	1.970.108	J 830	1.313.093	2 526 073	1.970.374
CB 606	1.306.231	CD 330	1.970.155	J 836	1.331.109	2 526 079	1.970.365
CB 607	1.328.096	CD 331	1.970.188	J 876	1.322.022	2 526 081	1.970.194
CB 608	1.330.109	CD 334	1.970.189	J 927	1.413.014	2 526 082	1.970.103
CB 609	1.315.049	CD 338	1.970.140	J 970	1.413.014	2 526 110	1.970.355
CB 610	1.312.066	CD 339	1.970.341	L 431	1.228.083MHV	2 526 111	1.970.356
CB 611	1.319.083	CD 440	1.970.272	L 453	1.228.089	2 526 208	1.970.405
CB 612	1.306.079	CD 442	1.970.103	L 837	1.328.096	2 528 001	1.965.029
CB 613	1.328.078	CD 443	1.970.111	L 880	1.428.025	2 528 001 A	1.965.029
CB 614	1.330.069	CD 444	1.970.109	L 887	1.328.094	2 528 008	1.965.005
CB 618	1.342.043	CD 446	1.970.125	L 935	1.428.026R	2 528 008 A	1.965.005
CB 624	1.330.090	CD 605	1.965.029	L4035	1.328.078	2 537 077	1.315.080
CB 625	1.315.058	CD 856	1.965.005	L4520	1.428.012	2 537 260	1.415.104
CB 626	1.315.058	CD 859	1.915.019	M 20	1.130.117	2 553 495	1.315.081
CB 627	1.315.041	CK 006	1.215.126 ^P	M 32	1.117.097	2 553 499 0	1.415.101
CB 628	1.306.076	CK 007	1.215.126 ^P	M 34	1.130.127	2 558 654	1.415.096R
CB 631	1.315.059	D 204	1.115.034	M 408	1.230.146M	2 558 743	1.415.101
CB 632	1.315.074	D 214	1.215.126 ^P	M 410	1.230.149M	2 559 115	1.415.097
CB 633	1.315.054	D 236	1.215.126 ^P	M 416	1.230.132	2 590 166	1.215.126 ^P
CB 635	1.330.098	D 301	1.215.064	M 417	1.230.140	2 590 251	1.142.056
CB 636	1.330.104	D 303	1.215.056	M 418	1.230.139	2 590 253	1.215.111U
CB 640	1.315.067	D 304	1.215.055	M 419	1.230.120	2 590 254	1.215.112U
CB 641	1.312.073	D 306	1.215.061	M 432	1.230.142	2 590 832	1.970.101D
CB 643	1.315.079	D 309	1.215.086	M 450	1.217.024	2 590 841	1.213.022HV
CB 645	1.315.065	D 312	1.215.103	M 459	1.230.149	2 590 843	1.217.026
CB 646	1.315.068	D 313	1.215.105	M 758	1.130.128	2 590 846	1.230.149
CB 649	1.317.023	D 316	1.215.106	M 840	1.330.109	2 590 862	1.106.196
CB 651	1.315.080	D 323	1.215.122	M 881	1.347.025	2 590 871	1.106.257
CB 652	1.315.081	D 329	1.215.067	M 885	1.430.059	2 590 874	1.306.081
CD 001	1.415.091	D 332	1.215.076	M 893	1.330.111	2 590 877	1.306.093
CD 002	1.415.088	D 333	1.215.101	M 930	1.430.041	2 590 878	1.306.094
CD 003	1.415.094	D 337	1.215.111U	M 931	1.430.051R	2 590 879	1.306.108
CD 005	1.415.089R	D 338	1.215.112U	M 932	1.430.054R	2 590 880	1.306.109
CD 006	1.415.081	D 396	1.415.104	M 933	1.430.060	2 590 881	1.306.121
CD 007	1.412.093	D 512	1.315.086 ^M	M 934	1.406.060R	2 590 882	1.306.124
CD 008	1.419.085	D 703	1.115.023	M4029	1.330.069	2 590 883	1.306.129
CD 009	1.406.014R	D 707	1.115.034	M4043	1.330.090	2 590 884	1.306.231
CD 010	1.406.021R	D 708	1.115.023	M4045	1.330.104	2 590 886	1.313.093
CD 011	1.406.012R	D 709	1.142.056	M4047	1.317.023	2 590 889	1.317.016
CD 012	1.430.037	D 801	1.315.058	M4048	1.330.098	2 590 892	1.331.109
CD 013	1.428.012	D 805	1.315.058	M4518	1.430.037	2 590 893	1.328.096
CD 016	1.415.083R	D 806	1.315.054	M4530	1.430.042R	2 590 896	1.330.109
CD 017	1.430.042R	D 807	1.315.049	M4533	1.430.047R	2 590 897	1.406.012R
CD 018	1.406.012R	D 808	1.315.041	M4535	1.417.058	2 590 898	1.406.023R
CD 019	1.406.023R	D 810	1.315.065	M4536	1.430.055R	2 590 899	1.406.025R
CD 020	1.406.055R	D 811	1.315.059	MTR-01	1.965.005	2 590 900	1.406.055R
CD 021	1.406.056R	D 812	1.315.068	S 406	1.242.054	2 590 901	1.406.056R
CD 022	1.406.059R	D 814	1.315.067	S4010	1.342.043	2 590 902	1.406.059R
CD 024	1.406.024R	D 815	1.315.079	U 592	1.236.045	2 590 904	1.406.024R

VALEO

2 590 905	1.406.112R
2 590 906	1.406.114R
2 590 907	1.406.116R
2 590 908	1.406.121R
2 590 910	1.413.014
2 590 911	1.430.029
2 590 913	1.430.041
2 590 914	1.430.051R
2 590 915	1.430.054R
2 590 916	1.430.060
2 590 917	1.406.060R
2 590 918	1.428.026R
2 590 935	1.315.077
2 590 945	1.915.019
2 591 820	1.231.084
2 591 821	1.230.149M
2 591 823	1.230.146M
2 591 824	1.130.127
2 591 838	1.406.112R
2 595 007	1.965.004
2 595 009	1.965.007
2 595 013	1.965.020
2 595 016	1.965.036
2 595 020	1.990.414
2 595 025	1.965.034
2 595 041	1.965.052
21597716-4	1.970.476
21603121-9	1.970.432
21603800-7	1.970.476
245098	1.970.408
245104	1.970.432
245139	1.970.532
245142	1.970.429
245178	1.970.461
26951960-3	1.970.405
400 01503	1.242.054
400 10603	1.206.034HVS
400 10703	1.206.040
400 10803	1.230.132
400 10903	1.230.140
400 11003	1.230.139
400 11103	1.230.120
400 11203	1.219.043HV
400 11303	1.219.044HV
400 11403	1.212.055HVS
400 11703	1.206.049HVS
400 11903	1.228.083MHV
400 12003	1.230.142
400 12403	1.213.011HV
400 12603	1.222.056HV
400 20903	1.217.024
400 21203	1.228.089
402 60303	1.406.014R
402 60403	1.406.021R
402 60503	1.406.012R
402 60703	1.430.037
402 60903	1.428.012
402 61003	1.419.085
402 61103	1.412.093
403 53803	1.342.043
403 80603	1.306.079
403 80703	1.306.076
403 80903	1.330.069
403 81503	1.319.083
403 81603	1.312.066
403 81803	1.328.078
413 80403	1.330.090
413 80603	1.330.104
413 80803	1.317.023
413 80903	1.330.098
413 81103	1.312.073
414 50303	1.406.026R
414 50503	1.430.042R
414 50803	1.430.047R
414 50903	1.412.096
414 51003	1.417.058

VALEO

414 51103	1.430.055R
430 40603	1.106.212
430 41003	1.130.117
430 90703	1.117.097
430 90903	1.130.127
441 19102	1.970.101D
7 350 370 2	1.965.005
735 02 602	1.965.029
735 03 702	1.965.005
949033	1.306.108
949034	1.306.121
949035	1.317.016
949041	1.312.073
949042	1.412.096

VAUXHALL

10458316	1.970.450
12635672	1.970.631
12670053	1.970.631
12697989	1.970.631
19005212	1.970.399
25195107	1.970.547
25198623	1.970.547
3639500	1.970.609
3639845	1.970.620
5 97 091	1.970.475
55561655	1.970.545
55573735	1.970.547
55577898	1.970.547
55579072	1.970.547
55584404	1.970.545
7079424	1.428.007
7100387	1.328.070
7101586	1.428.007
90006145	1.965.004
90114676	1.965.004
90140187	1.965.004
90240252	1.970.194
90277970	1.970.191
90458250	1.970.272
90506102	1.970.389
90543059	1.970.398
90543253	1.970.400
91159996	1.970.432
9119567	1.970.508
9198834	1.970.507
93161188	1.970.432
93161948	1.970.432
93177212	1.970.400
93180806	1.970.398
95512934	1.970.442
95517924	1.970.450
95528319	1.970.547
9671214580	1.970.609
9675390980	1.970.620

VOLVO

076978	1.406.021R
0769786	1.406.021R
1269920	1.306.236 ^A
12699203	1.306.236 ^A
1269921	1.406.119R
12699211	1.406.119R
1275174	1.990.423
1275284	1.499.061
12752846	1.499.061
1275603	1.499.059
1276620	1.906.153
1306169	1.206.034HVS
13061692	1.206.034HVS
1332584	1.965.034

VOLVO

13325840	1.965.034
1336240	1.406.055R
13362405	1.406.055R
1336241	1.406.055R
13362413	1.406.055R
1346787	1.406.118R
13467873	1.406.118R
1346788	1.306.127 ^A
13467881	1.306.127 ^A
1346792	1.906.222
13467923	1.906.222
1357418	1.406.122R
13574181	1.406.122R
1367052	1.406.122R
13670526	1.406.122R
1367783	1.406.147R
13677836	1.406.147R
1389425	1.406.121R
13894258	1.406.121R
233260	1.306.062
2332609	1.306.062
233910	1.206.029HV
2339109	1.206.029HV
238036	1.206.021
2380368	1.206.021
238859	1.206.021
2388593	1.206.021
240149	1.206.047
2401495	1.206.047
240247	1.406.012R
2402477	1.406.012R
240305	1.406.012R
2403053	1.406.012R
241652	1.206.049HVS
2416527	1.206.049HVS
241653	1.306.076
2416535	1.306.076
241655	1.306.062
241664	1.206.034HVS
2416642	1.206.034HVS
241669	1.306.072
2416691	1.306.072
243460	1.206.034HVS
243632	1.306.076
2436327	1.306.076
243657	1.406.024R
2436574	1.406.024R
243658	1.306.081
2436582	1.306.081
243796	1.406.025R
243797	1.306.079
2437978	1.306.079
243801	1.206.062
2438018	1.206.062
243803	1.306.081
2438034	1.306.081
243903	1.406.025R
2439032	1.406.025R
243922	1.406.023R
2439222	1.406.023R
245664	1.206.034HVS
2456642	1.206.034HVS
2714830	1.500.372
284509	1.415.083R
2845097	1.415.083R
30711786	1.970.480
30713416	1.970.448
30713417	1.970.478
30731419	1.970.481
30731424	1.499.242
30735759	1.970.532
3100134	1.215.055
31001340	1.215.055
3100770	1.415.083R
31007701	1.415.083R
3100771	1.315.049

VOLVO

31007719	1.315.049
3102885	1.115.023
31028855	1.115.023
31216444	1.970.481
31359976	1.970.532
31375294	1.970.480
31422170	1.970.481
3213390	1.415.096R
32133902	1.415.096R
3213392	1.315.059
32133928	1.315.059
3267443	1.215.055
32674434	1.215.055
3277417	1.315.054
32774176	1.315.054
3277441	1.115.023
32774416	1.115.023
3277442	1.315.049
32774422	1.315.049
3277840	1.212.055HVS
32778409	1.212.055HVS
3277854	1.312.066
32778540	1.312.066
3277855	1.412.095R
32778557	1.412.095R
3287598	1.315.059
32875981	1.315.059
3287599	1.415.096R
32875999	1.415.096R
3287677	1.970.107
32876773	1.970.107
32879249	1.501.332
32879256	1.501.332
3342161	1.315.063
33421611	1.315.063
3342163	1.415.097
33421637	1.415.097
3342164	1.315.070
33421645	1.315.070
3342440	1.315.072 ^M
33424409	1.315.072 ^M
3342441	1.415.097
3342442	1.315.069
33424425	1.315.069
3342443	1.315.070
33424433	1.315.070
33428467	1.500.415
33428467	1.500.417
3342862	1.315.069
33428624	1.315.069
3342863	1.415.097
33428632	1.415.097
3342864	1.315.070
33428640	1.315.070
33444092	1.501.332
34181545	1.500.415
34333625	1.500.417
3449620	1.415.097
3501944	1.306.260 ^A
35019447	1.306.260 ^A
35312776	1.500.372
3638411	1.970.101D
36384113	1.970.101D
546279	1.306.079
70863020	1.970.355
708630207	1.970.355
70863021	1.970.356
708630215	1.970.356
8677837	1.970.478
869474	1.970.480
8694741	1.970.480
870690	1.306.062
8706905	1.306.062
9125601	1.970.448
9135701	1.499.064

VOLVO		VW		VW		VW	
9445258	1.499.064	027 905 207	1.306.094	036 905 100 D	1.970.474	04C 905 110 H	1.970.599
9487221	1.970.481	027 905 207 A	1.306.266	036 905 225 H	1.406.056R	04C 905 110 J	1.970.599
		027 905 225	1.406.025R	036 905 295 B	1.106.257	04C 905 110 L	1.970.599
		028 905 207 C	1.315.049	036 905 409 K	1.501.575	04E 905 110	1.970.599
		030 905 065	1.906.223	036 905 430 AA	1.501.575	04E 905 110 A	1.970.599
		030 905 065 A	1.906.223	036 905 430 AB	1.501.575	04E 905 110 B	1.970.599
		030 905 065 B	1.906.223	036 905 430 AC	1.501.575	04E 905 110 E	1.970.599
		030 905 205	1.906.193 ^N	036 905 430 AD	1.501.575	04E 905 110 H	1.970.599
		030 905 205 A	1.906.193 ^N	036 905 430 AE	1.501.575	04E 905 110 K	1.970.599
		030 905 205 AE	1.930.182 ^N	036 905 430 D	1.501.575	04E 905 110 L	1.970.599
		030 905 205 B	1.906.193 ^N	036 905 430 E	1.501.575	04E 905 110 P	1.970.599
		030 905 205 D	1.906.193 ^N	036 905 430 F	1.501.575	050 905 205	1.906.159
		030 905 205 J	1.906.193 ^N	036 905 430 G	1.501.575	050 905 205 A	1.906.159 ^N
		030 905 207	1.306.094	036 905 430 H	1.501.575	050 905 205 AH	1.906.223 ^N
		030 905 207 A	1.330.116	036 905 430 J	1.501.575	050 905 205 AL	1.906.223 ^N
		030 905 225 C	1.430.057R	036 905 430 K	1.501.575	050 905 205 B	1.906.159 ^N
		030 905 430 J	1.501.595	036 905 430 L	1.501.575	050 905 205 BA	1.906.223 ^N
		030 905 430 K	1.501.595	036 905 430 M	1.501.575	050 905 205 C	1.906.159 ^N
		030 905 430 L	1.501.595	036 905 430 N	1.501.575	050 905 205 D	1.906.159 ^N
		030 905 430 M	1.501.595	036 905 430 P	1.501.575	050 905 205 E	1.906.159 ^N
		030 905 430 N	1.501.601	036 905 430 Q	1.501.575	050 905 205 F	1.906.159 ^N
		030 905 430 P	1.501.601	036 905 430 R	1.501.575	050 905 205 H	1.906.159 ^N
		030 905 430 Q	1.501.601	036 905 430 S	1.501.575	050 905 205 J	1.906.159 ^N
		030 905 430 R	1.501.601	036 905 430 T	1.501.575	050 905 205 K	1.906.159 ^N
		030 998 065	1.906.193	036 905 715	1.970.474	051 905 205	1.906.159 ^N
		030 998 065 A	1.906.233 ^S	036 905 715 A	1.970.474	051 905 205 B	1.906.233 ^N
		030 998 065 B	1.906.234	036 905 715 C	1.970.474	051 905 205 C	1.906.233 ^N
		032 905 106	1.990.420	036 905 715 E	1.970.474	051 905 207	1.306.266
		032 905 106 B	1.990.420	036 905 715 F	1.970.474	051 905 225	1.406.121R
		032 905 106 D	1.990.420	036 905 715 G	1.970.474	052 905 105	1.970.101D
		032 905 106 E	1.990.420	036 905 715 H	1.970.474	052 905 225	1.406.026R
		032 905 106 F	1.990.420	036 998 051	1.206.049HVS	052 905 225 A	1.415.089R
		032 905 430 E	1.501.569	036 998 051 A	1.206.049HVS	052 905 225 B	1.406.114R
		032 905 430 F	1.501.569	036 998 051 C	1.206.049HVS	052 905 225 C	1.406.121R
		032 905 430 G	1.501.569	036 998 051 D	1.206.049HVS	052 905 295	1.106.195
		032 905 430 H	1.501.569	037 905 205 M	1.906.223 ^N	052 998 051	1.206.049HVS
		032 905 430 K	1.501.723	037 905 207	1.306.263 ^A	052 998 051 D	1.206.049HVS
		032 905 430 L	1.501.723	039 905 225	1.406.061R	052 998 065	1.906.233
		032 905 430 M	1.501.723	03D 905 115	1.970.431	053 905 225 1	1.406.061R
		032 905 430 N	1.501.723	03D 905 115 A	1.970.431	053 905 431	1.501.356
		032 905 430 P	1.501.640	03D 905 115 B	1.970.431	053 905 433	1.501.356
		032 905 430 P	1.501.641	03D 905 115 C	1.970.431	055 905 207	1.306.094
		032 905 430 Q	1.501.640	03D 905 115 D	1.970.431	055 905 225	1.406.027R
		032 905 430 Q	1.501.641	03D 905 115 E	1.970.431	055 905 225 B	1.406.055R
		032 905 430 R	1.501.640	03D 905 115 F	1.970.431	056 905 205 L	1.906.159
		032 905 430 R	1.501.641	03D 905 115 G	1.970.431	058 905 101	1.970.354S
		032 905 430 T	1.501.640	03D 905 715 A	1.970.431	058 905 105	1.970.354S
		032 905 430 T	1.501.641	03F 905 409 B	1.499.248	058 905 207	1.306.079
		034 905 207	1.306.231 ^A	03F 905 430	1.499.248	058 905 409 A	1.501.491
		034 905 207 A	1.306.231 ^A	03F 905 430 A	1.499.248	058 905 447 C	1.501.491
		034 905 207 B	1.306.231 ^A	03F 905 430 B	1.499.248	058 998 051	1.206.062
		034 998 065	1.906.219	03F 905 430 C	1.499.248	058 998 051 A	1.206.062
		035 905 105 A	1.970.126	03F 905 430 D	1.499.248	058 998 051 B	1.206.062
		035 905 205	1.906.153	03F 905 430 E	1.499.248	059 905 207	1.306.076
		035 905 205 A	1.906.153 ^N	03F 905 430 F	1.499.248	059 905 225	1.406.021R
		035 905 205 B	1.906.153 ^N	03F 905 430 G	1.499.248	059 998 015	1.206.034HVS
		035 905 205 C	1.906.153 ^N	040 905 225	1.406.045R	059 998 051	1.206.034HVS
		035 905 205 D	1.906.153 ^N	040 905 359 1	1.906.160	059 998 051 B	1.206.034HVS
		035 905 205 E	1.906.153 ^N	041 905 207 2	1.306.098	060 905 295	1.106.196
		035 905 205 Q	1.906.153 ^N	043 905 115 A	1.970.101D	066 905 100	1.970.437
		035 905 206 AF	1.906.223 ^N	043 905 115 C	1.970.101D	066 905 100 B	1.970.437
		035 905 207	1.306.093	043 905 207	1.306.079	066 905 100 C	1.970.437
		035 905 207 A	1.306.093	043 905 225	1.406.025R	066 905 100 D	1.970.437
		035 905 209 B	1.306.231	046 905 105	1.970.169	066 905 100 G	1.970.437
		035 905 225	1.406.116R	047 905 205 C	1.906.153 ^N	066 905 715	1.970.437
		035 905 225 B	1.406.055R	048 905 105 1	1.970.168	06A 905 115	1.970.429
		035 905 225 C	1.406.059R	049 905 206 D	1.906.159 ^N	06A 905 115 A	1.970.429
		035 905 225 D	1.406.121R	049 905 206 F	1.906.159 ^N	06A 905 115 B	1.970.429
		035 905 225 F	1.406.121R	049 905 206 G	1.906.159 ^N	06A 905 115 C	1.970.429
		035 905 315	1.906.153	049 905 207	1.306.079	06A 905 115 D	1.970.429
		035 998 065 A	1.906.219	049 905 225 C	1.406.115R	06A 905 409 L	1.501.585
		035 998 065 A*	1.906.231	049 905 225 D	1.406.115R	06A 905 409 N	1.499.223
		035 998 065 A***	1.906.231	04C 905 110 A	1.970.599	06A 905 409 P	1.501.585
		036 905 100 A	1.970.474	04C 905 110 B	1.970.599	06A 905 430 AA	1.501.484
		036 905 100 B	1.970.474	04C 905 110 D	1.970.599	06A 905 430 AF	1.501.585
		036 905 100 C	1.970.474	04C 905 110 E	1.970.599	06A 905 430 AH	1.501.585

VW		VW		VW		VW	
06A 905 430 AJ	1.501.585	06F 905 115 E	1.970.426	211 905 115 B	1.970.132	N10 052 911	1.501.580
06A 905 430 AK	1.499.223	06F 905 115 F	1.970.426	211 905 115 C	1.970.132	N10 070 202	1.500.768
06A 905 430 AL	1.499.223	06H 905 110 D	1.970.636	211 905 115 D	1.970.125	N10 070 210	1.501.549
06A 905 430 AM	1.499.223	06H 905 110 E	1.970.636	211 905 351	1.965.004	N10 070 210	1.501.551
06A 905 430 AN	1.499.223	06H 905 110 F	1.970.636	211 905 351 A	1.965.004	N10 204 402	1.501.353
06A 905 430 AP	1.501.585	06H 905 110 G	1.970.636	211 905 351 B	1.965.004	N10 238 502	1.501.356
06A 905 430 AQ	1.501.585	06H 905 110 H	1.970.636	211 905 351 D	1.965.004	N10 243 603	1.501.667
06A 905 430 D	1.501.479	06H 905 110 L	1.970.636	211 905 351 E	1.965.004	N10 243 604	1.501.667
06A 905 430 E	1.501.479	06H 905 115	1.970.426	221 100 019	1.970.101D	N10 243 607	1.501.551
06A 905 430 F	1.501.479	06H 905 115 A	1.970.426	251 905 115 A	1.970.125	N10 243 608	1.501.667
06A 905 430 G	1.501.479	06H 905 115 B	1.970.426	281 905 207	1.306.094	N10 243 611	1.501.353
06A 905 430 H	1.501.585	06K 905 110 K	1.970.636	311 998 063	1.206.034HVS	N10 243 612	1.501.667
06A 905 430 J	1.501.585	06L 905 110 A	1.970.636	311 998 063 1	1.206.034HVS	N10 264 601	1.500.965
06A 905 430 K	1.501.585	06L 905 110 B	1.970.636	325 905 207 1	1.306.129	N10 266 901	1.501.356
06A 905 430 L	1.501.585	06L 905 110 C	1.970.636	325 905 207 2	1.306.094	N10 316 401	1.501.932
06A 905 430 M	1.501.489	06L 905 110 D	1.970.636	325 905 209 2	1.906.153	N10 316 401	1.501.933
06A 905 430 N	1.501.489	06L 905 110 E	1.970.636	357 905 105	1.970.269	N10 316 401	1.501.937
06A 905 430 P	1.501.489	06L 905 110 F	1.970.636	411 963 073	1.106.030	N10 316 402	1.501.932
06A 905 430 Q	1.501.489	06L 905 110 H	1.970.636	477 905 206	1.906.153	N10 316 402	1.501.933
06A 905 430 R	1.501.484	06L 905 110 K	1.970.636	4A0 905 351	1.965.051	N10 316 402	1.501.937
06A 905 430 S	1.501.484	071 905 143	1.965.074	4D0 905 351	1.965.076	N10 316 403	1.501.932
06A 905 430 T	1.501.484	071 905 225	1.406.067R	6N0 905 104	1.990.414	N10 316 403	1.501.933
06B 905 106 A	1.990.420	071 905 225 A	1.406.067R	701 905 104 A	1.990.416	N10 316 403	1.501.937
06B 905 115	1.970.445	073 905 207	1.306.081	71 314 347	1.406.045R	N10 316 404	1.501.932
06B 905 115 B	1.970.445	073 905 207 B	1.306.233	71 314 348	1.306.098	N10 316 404	1.501.933
06B 905 115 D	1.970.429	073 905 225	1.406.024R	811 905 115	1.970.127	N10 316 404	1.501.937
06B 905 115 E	1.970.445	073 905 225 A	1.406.117R	867 905 105 A	1.970.159	N10 316 602	1.501.932
06B 905 115 G	1.970.429	073 998 051	1.206.034HVS	867 905 352	1.990.414	N10 418 501	1.501.580
06B 905 115 H	1.970.429	077 905 115 AA	1.970.425	892 031 048	1.306.076	N10 418 502	1.501.580
06B 905 115 J	1.970.429	077 905 115 B	1.970.433	892 031 090	1.206.029HV	N10 418 503	1.501.580
06B 905 115 L	1.970.429	077 905 115 C	1.970.433	892 031 520	1.406.018R	N10 418 504	1.501.580
06B 905 115 M	1.970.429	077 905 115 E	1.970.433	8D0 905 351	1.965.072	N10 421 002	1.501.932
06B 905 115 N	1.970.429	077 905 115 F	1.970.433	J19 101 350 10	1.313.273	N10 430 003	1.501.569
06B 905 115 P	1.970.429	077 905 115 G	1.970.425	J19 101 351 80	1.313.099	N10 430 003	1.501.641
06B 905 115 Q	1.970.429	077 905 115 H	1.970.433	J19 101 710 10	1.313.113	ZBA 905 225 B	1.406.025R
06B 905 115 R	1.970.429	077 905 115 J	1.970.425	J19 101 710 20	1.313.114		
06B 905 115 S	1.970.429	077 905 115 K	1.970.433	J19 102 160 60	1.413.027		
06B 905 430	1.501.585	077 905 115 M	1.970.425	J19 102 261 51	1.413.014		
06B 905 430 A	1.501.585	077 905 115 P	1.970.433	J19 145 260 60	1.213.011HV		
06B 905 430 B	1.501.585	077 905 115 Q	1.970.433	J90 919 021 97	1.970.203		
06B 905 430 C	1.501.585	077 905 115 R	1.970.425	N 038 875 3	1.500.727		
06B 905 431 A	1.501.585	077 905 115 S	1.970.425	N 038 885 1	1.500.493		
06B 905 431 C	1.501.585	077 905 115 T	1.970.433	N 038 885 1	1.500.725		
06B 905 433 A	1.501.585	077 905 205	1.306.248 ^A	N 038 885 1	1.500.737		
06B 905 435 A	1.501.585	077 905 207	1.306.248 ^A	N 038 887 5	1.500.493		
06B 905 437 A	1.501.585	07K 905 715	1.970.426	N 038 908 5	1.500.727		
06C 905 115 A	1.970.436	07K 905 715 A	1.970.426	N10 050 201	1.500.768		
06C 905 115 B	1.970.436	07K 905 715 B	1.970.426	N10 050 201	1.501.549		
06C 905 115 C	1.970.429	07K 905 715 C	1.970.426	N10 050 205	1.500.725		
06C 905 115 D	1.970.436	07K 905 715 D	1.970.426	N10 050 205	1.500.965		
06C 905 115 E	1.970.436	07K 905 715 E	1.970.426	N10 052 601	1.500.737		
06C 905 115 F	1.970.436	07K 905 715 F	1.970.426	N10 052 704	1.500.493		
06C 905 115 G	1.970.436	07K 905 715 G	1.970.426	N10 052 704	1.501.671		
06C 905 115 H	1.970.436	111 905 207 B	1.306.062	N10 052 706	1.500.965		
06C 905 115 K	1.970.436	111 905 207 D	1.306.076	N10 052 706	1.501.667		
06C 905 115 L	1.970.436	111 905 225 B	1.406.018R	N10 052 801	1.501.671		
06C 905 115 M	1.970.436	111 905 225 C	1.406.018R	N10 052 805	1.501.660		
06D 905 115	1.970.427	111 905 225 F	1.406.014R	N10 052 808	1.499.159		
06D 905 115 A	1.970.427	111 905 225 G	1.406.014R	N10 052 808	1.501.660		
06D 905 115 C	1.970.427	111 998 051	1.206.047	N10 052 808	1.501.682		
06D 905 115 D	1.970.427	111 998 053	1.206.029HV	N10 052 809	1.500.493		
06D 905 115 F	1.970.427	111 998 055	1.206.029HV	N10 052 809	1.501.364		
06D 905 115 G	1.970.427	111 998 059	1.206.032HV	N10 052 809	1.501.660		
06D 905 115 K	1.970.427	111 998 063	1.206.040	N10 052 812	1.499.159		
06E 905 115	1.970.427	111 998 295	1.206.034HVS	N10 052 812	1.501.682		
06E 905 115 A	1.970.427	113 905 207 A	1.306.079	N10 052 815	1.501.660		
06E 905 115 B	1.970.427	113 905 207 B	1.306.079	N10 052 903	1.501.640		
06E 905 115 C	1.970.427	113 905 207 C	1.306.079	N10 052 903	1.501.660		
06E 905 115 D	1.970.427	113 905 225 E	1.406.021R	N10 052 903	1.501.682		
06E 905 115 E	1.970.427	175 905 206 A	1.906.159 ^N	N10 052 904	1.501.364		
06E 905 115 F	1.970.427	181 905 225	1.406.012R	N10 052 904	1.501.660		
06E 905 115 G	1.970.427	181 905 225 C	1.406.025R	N10 052 904	1.501.937		
06F 905 115	1.970.426	181 998 053	1.206.029HV	N10 052 907	1.499.159		
06F 905 115 A	1.970.426	191 905 115 A	1.970.126	N10 052 907	1.500.493		
06F 905 115 B	1.970.426	191 905 351 A	1.965.007	N10 052 907	1.500.725		
06F 905 115 C	1.970.426	191 905 351 B	1.965.007	N10 052 907	1.501.933		

YUGO

46600871	1.407.701R
4660870	1.307.701

ZASTAVA

1335050	1.330.081
1335052	1.230.140
1335055	1.430.036R
46600193	1.306.079
46600861	1.207.701
46600871	1.407.701R
4660870	1.307.701
5248175	1.306.079



CROSS REFERENCE LIST OTHER MANUFACTURERS

·TABELLA COMPARATIVA ALTRI COSTRUTTORI ·TABLE DE COMPARAISON D'AUTRES FABRICANTS
·VERGLEICHSTABELLE ANDERE HERSTELLER ·TABLA DE EQUIVALENCIAS OTRAS FABRICANTES

POSSIBLE CROSS REFERENCE FROM OTHER MANUFACTURERS

- POSSIBILI CROSS REFERENCE DI ALTRI COSTRUTTORI
- RENVOIS POSSIBLES À D'AUTRES FABRICANTS
- MÖGLICHE QUERVERWEISE AUF ANDERE HERSTELLER
- POSIBLES REFERENCIAS CRUZADAS DE OTRAS FABRICANTES

1203	1.115.023	243 592	1.236.045	415 088	1.428.007	607 453	1.115.023
1203 B	1.115.023	243 758	1.130.128	418 726	1.428.007	607 453	1.115.023
1203 C	1.115.023	243 842	1.315.077	422	1.230.120	608 012	1.215.055
1205	1.115.023	243 870	1.315.063	422 A	1.230.120	608 460	1.115.034
1205 D	1.115.023	243 871	1.315.072 ^M	423 153	1.228.083MHV	608 514	1.215.111U
1216	1.115.023	243 876	1.322.022	438	1.230.120	608 515	1.215.111U
8194	1.315.049	243 881	1.347.025	440	1.230.123	608 640	1.215.067
9500	1.115.023	243 882	1.306.080	448	1.230.132	608 640	1.215.067
9534	1.115.023	243 886	1.306.241	450 001	1.315.049	608 719	1.215.112U
1203	1.115.023	243 887	1.328.094	450 002	1.415.083R	608 728	1.315.058
16 575	1.315.058	243 889	1.315.081	450 005	1.115.039	608 969	1.215.111U
16 903	1.415.091	243 890	1.306.252	450 009	1.415.083R	609 082	1.315.058
18 132	1.315.049	243 893	1.330.111	451	1.230.139	609 504	1.115.034
18 137	1.415.083R	243 910	1.415.096R	452	1.230.140	610 891	1.415.088
18 137	1.415.083R	243 964	1.415.097	453	1.246.071	611 037	1.315.049
18 435	1.315.049	243 965	1.406.115R	454	1.230.142	611 149	1.315.049
19 401	1.315.058	243 969	1.406.112R	455	1.230.139	611 152	1.315.049
22 321	1.315.058	243 970	1.413.014	455	1.230.143	611 228	1.215.111U
22 321	1.315.058	244 512	1.315.086 ^M	460	1.217.024	611 514	1.315.058
22 946	1.315.059	2443- 1	1.430.041	463	1.217.026	611 723	1.415.091
23 263	1.215.064	245 001	1.970.106	466	1.230.146M	618 015	1.215.076
23 263	1.215.064	245 027	1.970.105	467	1.230.149M	618 015	1.215.076
27 620	1.342.043	245 039	1.970.155	469	1.230.148M	618 431	1.215.111U
27 630	1.142.056	245 040	1.970.188	4765	1.430.029	618 435	1.315.049
27 637	1.142.056	245 041	1.970.189	520	1.215.106	618 642	1.215.101
2790	1.970.101D	245 042	1.970.140	520 004	1.970.101D	618 642	1.215.101
47 430	1.315.049	245 043	1.970.341	520 023	1.970.101D	618 701	1.215.055
49 423	1.415.091	245 049	1.970.108	520 064	1.970.107	618 765	1.215.101
54 099	1.142.056	245 052	1.970.158	520 064 A	1.970.107	620	1.228.083MHV
69 211	1.142.056	245 054	1.970.107	520 073	1.970.105	623	1.228.089
69 272	1.142.056	245 057	1.970.272	520 073	1.970.105	623 V	1.228.089
71 129	1.215.056	245 059	1.970.103	520 073 A	1.970.105	660 494	1.115.034
71 129	1.215.056	245 060	1.970.109	521 008	1.965.005	660 501	1.115.034
71 133	1.215.055	245 062	1.970.111	521 013	1.965.005	660 542	1.315.058
71 133	1.215.055	245 064	1.970.125	525 409 D	1.315.073 ^M	660 548	1.415.088R
71 974	1.215.061	245 066	1.970.355	525 536	1.315.072 ^M	660 588	1.315.059
71 974	1.215.061	245 067	1.970.356	525 536 B	1.315.072 ^M	660 740	1.415.089R
72 192	1.415.081	245 068	1.970.228	525 536 F	1.315.069	660 740	1.415.089R
72 192	1.415.081	245 071	1.970.374	525 551 B	1.915.019 ^N	660 996	1.315.049
72 196	1.315.041	245 076	1.970.355	531	1.215.126	661 004	1.415.091
76 901	1.315.049	245 077	1.970.356	532	1.215.127	661 149	1.315.049
79 432	1.415.083R	245 079	1.970.365	540	1.215.086	661 152	1.315.049
79 874	1.142.056	245 080	1.970.178	542	1.215.055	661 154	1.415.091
80	1.201.006	245 082	1.970.194	545	1.215.102	661 156	1.415.083R
C 1	1.142.056	245 083	1.970.103	546	1.215.103	661 371	1.415.088
D 409	1.215.056	245 509	1.965.029	548	1.215.105	661 450	1.315.054
D 4511	1.415.091	245 510	1.965.005	567	1.215.055	661 764	1.415.091
J 438	1.222.056HV	245 516	1.965.036	570	1.215.056	661 822	1.315.054
P 17	1.142.056	245 519	1.965.004	570 V	1.215.056	661 822 E	1.315.054
S 1	1.142.056	245 521	1.965.007	572	1.215.061	661 920	1.315.058
S 406	1.242.054	245 527	1.965.020	573	1.242.054	661 920	1.315.058
S 4010	1.342.043	245 531	1.990.414	582 018	1.215.086	662 165	1.315.054
114	1.206.047	245 536	1.965.034	582 018	1.215.086	662 165	1.315.054
116	1.206.029HV	245 550	1.965.052	582 130	1.215.102	662 368	1.415.091
141	1.206.029HV	248 880	1.428.025	582 133	1.215.103	662 414	1.315.049
141 F	1.206.029HV	248 881	1.415.101	582 133	1.215.103	662 414	1.315.049
142	1.206.021	248 885	1.430.059	582 156	1.215.105	662 434	1.315.041
143	1.206.029HV	248 888	1.315.080	582 156	1.215.105	662 434	1.315.041
147	1.206.029HV	248 889	1.315.081	582 169	1.115.034	662 471	1.315.059
149	1.206.060	250	1.206.034HVS	582 186	1.215.106	662 540	1.115.034
157	1.206.032HV	251	1.206.034HVS	582 191	1.215.106	662 899	1.415.089R
161	1.206.034HVS	254	1.206.034HVS	582 199	1.215.106	662 913	1.315.058
164	1.206.049HVS	258	1.206.049HVS	582 199	1.215.106	663 205	1.315.059
166	1.206.060	260	1.206.083	582 309	1.215.122	663 296	1.115.034
167	1.206.064	263	1.207.701	582 309	1.215.122	663 550	1.415.094
171	1.206.040	335	1.230.127	582 482	1.215.126 ^P	663 869	1.415.094
178	1.206.071	343	1.222.056HV	582 482	1.215.126 ^P	664 203	1.415.094
179	1.206.062	343 V	1.222.056HV	582 514	1.315.063	664 203	1.415.094
185	1.206.083	344	1.213.011HV	583	1.215.064	664 225	1.415.088
186	1.206.068	352	1.212.055HVS	585	1.215.067	664 225	1.415.088
187	1.206.071	361	1.231.084	589	1.215.111U	664 369	1.315.065
192	1.206.062	362	1.213.022HV	594	1.215.111U	664 369	1.315.065
193	1.206.034HVS	368	1.231.084	594 525	1.965.005	664 518	1.415.096R
194	1.206.049HVS	400 051	1.428.006	595	1.215.112U	664 518	1.415.096R
195	1.206.034HVS	405 468	1.428.006	596	1.215.076	664 706	1.115.039
196	1.206.049HVS	407 030	1.428.007	599 178	1.228.089	664 813	1.315.059
197	1.206.062	408 355	1.428.007	599 183	1.222.056HV	664 813	1.315.059
243 408	1.230.146M	410 610	1.428.006	599 210	1.330.069	664 895	1.415.091
243 410	1.230.149M	413	1.215.076	607 374	1.315.058	664 895	1.415.091

665 561	1.115.034	CB 008	1.217.024	CD 012	1.430.037	D 396	1.415.104
665 561	1.115.034	CB 011	1.215.055	CD 013	1.428.012	D 512	1.315.086 ^M
665 752	1.315.070	CB 014	1.230.142	CD 016	1.415.083R	D 607453	1.115.023
665 757	1.315.063	CB 017	1.215.105	CD 017	1.430.042R	D 703	1.115.023
665 852	1.415.097	CB 018	1.215.103	CD 018	1.406.012R	D 707	1.115.034
666 203	1.315.073 ^M	CB 019	1.215.106	CD 019	1.406.023R	D 708	1.115.023
666 349	1.315.068	CB 021	1.215.122	CD 020	1.406.055R	D 709	1.142.056
666 349	1.315.068	CB 027	1.215.056	CD 021	1.406.056R	D 801	1.315.058
666 592	1.315.062	CB 029	1.215.061	CD 022	1.406.059R	D 805	1.315.058
666 777	1.415.097	CB 030	1.215.064	CD 024	1.406.024R	D 806	1.315.054
666 778	1.315.073 ^M	CB 031	1.228.089	CD 025	1.406.112R	D 807	1.315.049
666 867	1.415.099R	CB 033	1.213.011HV	CD 026	1.406.114R	D 808	1.315.041
666 867	1.415.099R	CB 034	1.222.056HV	CD 027	1.406.116R	D 810	1.315.065
667 287	1.315.067	CB 035	1.231.084	CD 028	1.406.121R	D 811	1.315.059
667 287	1.315.067	CB 036	1.230.146M	CD 029	1.430.041	D 812	1.315.068
667 308	1.315.079	CB 039	1.215.076	CD 030	1.430.051R	D 814	1.315.067
667 308	1.315.079	CB 042	1.206.040	CD 031	1.430.054R	D 815	1.315.079
7083	1.230.120	CB 043	1.206.049HVS	CD 032	1.430.060	D 816	1.315.074
750	1.236.045	CB 044	1.230.120	CD 033	1.406.060R	D 842	1.315.077
803 34 A	1.965.036	CB 045	1.230.132	CD 034	1.428.026R	D 870	1.315.063
8415	1.430.029	CB 046	1.230.139	CD 035	1.430.047R	D 871	1.315.072 ^M
848 90 D	1.965.036	CB 047	1.230.140	CD 036	1.430.055R	D 881	1.415.104
908 081	1.142.056	CB 048	1.228.083MHV	CD 038	1.412.096	D 888	1.315.080
908 086	1.142.056	CB 050	1.219.044HV	CD 040	1.415.096R	D 889	1.315.081
908 148	1.142.056	CB 052	1.217.026	CD 042	1.406.026R	D 901	1.415.083R
908 149	1.142.056	CB 055	1.230.149M	CD 048	1.415.099R	D 902	1.415.081
908 247	1.242.054	CB 060	1.215.101	CD 049	1.417.058	D 905	1.415.089R
9575- 2	1.215.064	CB 070	1.215.067	CD 050	1.415.101	D 908	1.415.094
9575- 3	1.215.064	CB 304	1.106.212	CD 051	1.406.025R	D 909	1.415.088
A 422	1.212.055HVS	CB 310	1.130.117	CD 303	1.970.101D	D 910	1.415.096R
A4037	1.312.066	CB 318	1.115.023	CD 308	1.970.105	D 911	1.415.091
A4050	1.312.073	CB 319	1.115.034	CD 309	1.970.101D	D 913	1.415.099R
A4522	1.412.093	CB 331	1.106.196	CD 315	1.970.101D	D 936	1.415.104
A4534	1.412.096	CB 336	1.106.257	CD 321	1.970.106	D 964	1.415.097
B 15	1.106.212	CB 338	1.130.127	CD 323	1.970.101D	DAB 126	1.965.036
B 414	1.206.034HVS	CB 344	1.115.023	CD 324	1.970.102	DAB 134	1.965.036
B 415	1.206.040	CB 601	1.306.093	CD 325	1.970.107	DAB 201	1.965.005
B 429	1.206.049HVS	CB 602	1.306.094	CD 328	1.970.108	DAB 202	1.965.029
B 721	1.106.196	CB 603	1.306.109	CD 330	1.970.155	DAB 400	1.965.004
B 732	1.106.257	CB 604	1.306.109	CD 331	1.970.188	DAB 402	1.965.007
B 817	1.306.081	CB 605	1.306.129	CD 334	1.970.189	DAB 405	1.965.034
B 820	1.306.093	CB 606	1.306.231	CD 338	1.970.140	DAB 703	1.965.025
B 821	1.306.094	CB 607	1.328.096	CD 339	1.970.341	DAB 800	1.965.020
B 822	1.306.108	CB 608	1.330.109	CD 440	1.970.272	DAB 954	1.990.414
B 824	1.306.109	CB 609	1.315.049	CD 442	1.970.103	DC 625	1.330.069
B 825	1.306.121	CB 610	1.312.066	CD 443	1.970.111	DC 627	1.330.069
B 826	1.306.124	CB 611	1.319.083	CD 444	1.970.109	DCB 203	1.115.034
B 827	1.306.129	CB 612	1.306.079	CD 446	1.970.125	DCB 207	1.115.039
B 828	1.306.231	CB 613	1.328.078	CD 605	1.965.029	DCB 214	1.142.056
B 882	1.306.080	CB 614	1.330.069	CD 856	1.965.005	DCB 221	1.115.023
B 886	1.306.241	CB 618	1.342.043	CD 859	1.915.019	DCB 222	1.142.056
B 890	1.306.252	CB 624	1.330.090	CK 006	1.215.126 ^P	DCB 225	1.142.056
B 914	1.406.012R	CB 625	1.315.058	CK 007	1.215.126 ^P	DCB 239	1.115.034
B 915	1.406.023R	CB 626	1.315.058	CL 1	1.970.101D	DCB 243	1.115.039
B 916	1.406.025R	CB 627	1.315.041	CL 101	1.970.101D	DCB 404	1.106.212
B 917	1.406.055R	CB 628	1.306.076	CS 19	1.228.089	DCB 413	1.106.196
B 918	1.406.056R	CB 631	1.315.059	CS 25	1.215.056	DCB 414	1.106.195
B 919	1.406.059R	CB 632	1.315.074	CS 75	1.222.056HV	DCB 427	1.106.212
B 921	1.406.024R	CB 633	1.315.054	CS 91	1.228.089	DCB 532	1.106.257
B 922	1.406.112R	CB 635	1.330.098	CS 303	1.222.056HV	DCB 633	1.117.097
B 923	1.406.114R	CB 636	1.330.104	D 1203	1.115.023	DCB 867	1.130.117
B 924	1.406.116R	CB 640	1.315.067	D 71129	1.215.056	DCB 874	1.130.117
B 925	1.406.121R	CB 641	1.312.073	D 204	1.115.034	DCB 874E	1.130.117
B 965	1.406.115R	CB 643	1.315.079	D 214	1.215.126 ^P	DCB 880	1.130.127
B 969	1.406.112R	CB 645	1.315.065	D 236	1.215.126 ^P	DCB 881	1.130.128
B4025	1.306.076	CB 646	1.315.068	D 301	1.215.064	DCJ 233	1.131.131
B4027	1.306.079	CB 649	1.317.023	D 303	1.215.056	DDB 100	1.328.104
B4514	1.406.014R	CB 651	1.315.080	D 304	1.215.055	DDB 105	1.328.070
B4515	1.406.021R	CB 652	1.315.081	D 306	1.215.061	DDB 106	1.328.075
B4516	1.406.012R	CD 001	1.415.091	D 309	1.215.086	DDB 108	1.328.078
B4528	1.406.026R	CD 002	1.415.088	D 312	1.215.103	DDB 109	1.328.096
BD 12-2	1.970.101D	CD 003	1.415.094	D 313	1.215.105	DDB 119	1.328.091
CB 001	1.242.054	CD 005	1.415.089R	D 316	1.215.106	DDB 130	1.328.098
CB 002	1.206.034HVS	CD 006	1.415.081	D 323	1.215.122	DDB 132	1.328.099
CB 003	1.219.043HV	CD 007	1.412.093	D 329	1.215.067	DDB 133	1.328.100
CB 004	1.212.055HVS	CD 008	1.419.085	D 332	1.215.076	DDB 150	1.328.083
CB 005	1.215.086	CD 009	1.406.014R	D 333	1.215.101	DDB 152	1.328.085
CB 006	1.215.111U	CD 010	1.406.021R	D 337	1.215.111U	DDB 175	1.328.091
CB 007	1.215.112U	CD 011	1.406.012R	D 338	1.215.112U	DDB 176	1.328.091

DDB 182	1.328.094	DDB 506	1.306.257	DLB 125	1.970.169	DRB 435	1.406.018R
DDB 184	1.328.093	DDB 507	1.306.247	DLB 204	1.970.107	DRB 436	1.406.021R
DDB 199	1.328.078	DDB 508	1.306.248	DLB 205	1.970.105	DRB 439	1.406.024R
DDB 208	1.315.049	DDB 627	1.330.069	DLB 206	1.970.106	DRB 441	1.406.025R
DDB 208E	1.315.049	DDB 627C	1.330.069	DLB 232	1.970.180	DRB 445	1.406.067R
DDB 209	1.315.054	DDB 628	1.317.016	DLB 233	1.970.155	DRB 446	1.406.027R
DDB 209E	1.315.054	DDB 630	1.317.014	DLB 246	1.970.127	DRB 447	1.406.026R
DDB 217	1.315.059	DDB 633	1.317.023	DLB 301	1.970.228	DRB 453	1.406.023R
DDB 221	1.315.049	DDB 701	1.312.066	DLB 303	1.970.101D	DRB 455	1.406.034R
DDB 222	1.315.041	DDB 705	1.312.073	DLB 305	1.970.341	DRB 462	1.406.056R
DDB 223	1.315.058	DDB 751	1.319.092	DLB 310	1.970.192	DRB 464	1.406.055R
DDB 224	1.342.043	DDB 752	1.319.093	DLB 312	1.990.303	DRB 466	1.406.060R
DDB 230	1.315.058	DDB 754	1.319.083	DLB 313	1.970.126	DRB 467	1.406.116R
DDB 231	1.315.058	DDB 754C	1.319.083	DLB 314	1.970.146	DRB 468	1.406.059R
DDB 231E	1.315.058	DDB 804	1.330.076	DLB 401	1.970.127	DRB 469	1.406.061R
DDB 232	1.315.059	DDB 806	1.330.111	DLB 403	1.970.125	DRB 470	1.406.112R
DDB 232E	1.315.059	DDB 813	1.330.086	DLB 701	1.970.111	DRB 472	1.406.034R
DDB 235	1.315.059	DDB 816	1.330.090	DLB 702	1.970.109	DRB 473	1.406.055R
DDB 237	1.315.059	DDB 851	1.347.025	DLB 703	1.970.341	DRB 475	1.406.061R
DDB 238	1.315.062	DDB 861	1.330.069	DLB 704	1.970.140	DRB 476	1.406.112R
DDB 245	1.315.065	DDB 863	1.330.081	DLB 705	1.970.213	DRB 480	1.406.067R
DDB 246	1.315.067	DDB 864	1.330.059	DLB 706	1.970.148	DRB 484	1.406.117R
DDB 247	1.315.068	DDB 882	1.330.104	DLB 708	1.970.159	DRB 485	1.406.115R
DDB 248	1.315.069	DDB 883	1.330.093	DLB 800	1.970.108	DRB 488	1.406.067R
DDB 249	1.315.074	DDB 886	1.330.101	DLB 801	1.970.102	DRB 491	1.406.024R
DDB 250	1.315.081	DDB 888	1.330.098	DLB 802	1.970.103	DRB 493	1.406.117R
DDB 251	1.315.082	DDB 889	1.330.098	DLJ 402	1.970.233	DRB 494	1.406.112R
DDB 252	1.315.080	DDB 891	1.330.101	DMB 200	1.970.188	DRB 498	1.406.113R
DDB 302	1.315.079	DDB 894	1.330.098	DMB 201	1.970.189	DRB 499	1.406.114R
DDB 304	1.322.068	DDB 895	1.330.098	DMB 300	1.970.168	DRB 500	1.406.115R
DDB 400	1.306.094	DDB 897	1.330.109	DMB 400	1.970.162S	DRB 501	1.406.116R
DDB 401	1.306.093	DDB 900	1.315.077	DMB 751	1.970.135	DRB 504	1.406.045R
DDB 412	1.306.079	DDB 901	1.315.086	DMB 800	1.970.272	DRB 505	1.406.067R
DDB 413	1.306.079	DDB 954	1.338.242	DPB 801	1.930.161/1	DRB 506	1.406.117R
DDB 436	1.306.062	DDB 955	1.347.027	DPB 808	1.930.180M	DRB 507	1.406.118R
DDB 437	1.306.076	DDJ 100	1.322.003	DPB 812	1.930.176M	DRB 508	1.406.119R
DDB 438	1.306.072	DDJ 106	1.331.003/00	DPB 813	1.930.177/1	DRB 510	1.406.121R
DDB 439	1.306.081	DDJ 107	1.322.011	DRB 100	1.428.030	DRB 511	1.406.122R
DDB 440	1.306.092	DDJ 115	1.322.057	DRB 101	1.428.006	DRB 512	1.406.123R
DDB 441	1.306.080	DDJ 156	1.322.046	DRB 104	1.428.012	DRB 514	1.406.126R
DDB 442	1.306.079	DDJ 167	1.322.057	DRB 106	1.428.007	DRB 515	1.406.125R
DDB 450	1.306.072	DDJ 189	1.328.103	DRB 113	1.428.014	DRB 518	1.406.127R
DDB 453	1.306.099	DDJ 190	1.328.101	DRB 117	1.428.028R	DRB 519	1.406.070R
DDB 457	1.306.092	DDJ 191	1.328.102	DRB 121	1.428.027R	DRB 520	1.406.140R
DDB 458	1.306.090	DDJ 201	1.331.003/00	DRB 126	1.428.007	DRB 625	1.417.052
DDB 460	1.306.090	DDJ 206	1.331.137	DRB 128	1.428.007	DRB 626	1.417.052R
DDB 462	1.306.109	DDJ 220	1.331.003/00	DRB 131	1.428.029R	DRB 627	1.430.029
DDB 467	1.306.108	DDJ 224	1.313.117	DRB 139	1.428.021	DRB 628	1.430.036R
DDB 470	1.306.079	DDJ 235	1.331.114	DRB 147	1.428.025	DRB 631	1.417.058
DDB 472	1.306.079	DDJ 258	1.331.131	DRB 148	1.428.026R	DRB 633	1.430.041
DDB 473	1.306.079	DDJ 261	1.331.117	DRB 149	1.428.024R	DRB 701	1.412.093
DDB 475	1.306.108	DDJ 300	1.331.003/00	DRB 151	1.428.029R	DRB 701R	1.412.093R
DDB 478	1.306.121	DDJ 301	1.313.252	DRB 195	1.428.022	DRB 703	1.412.090
DDB 479	1.306.123	DDJ 302	1.313.256	DRB 204	1.415.083R	DRB 704	1.412.096
DDB 480	1.306.123	DDJ 303	1.313.259	DRB 205	1.415.091	DRB 705	1.412.095R
DDB 481	1.306.124	DDJ 305	1.322.040	DRB 205E	1.415.091	DRB 706	1.412.097
DDB 482	1.306.098	DDJ 306	1.322.041	DRB 205R	1.415.091	DRB 707	1.412.100
DDB 483	1.306.076	DDJ 307	1.331.116	DRB 208	1.415.089R	DRB 750	1.419.085
DDB 484	1.306.062	DDJ 308	1.331.121	DRB 208E	1.415.089R	DRB 752	1.419.085
DDB 485	1.306.079	DDJ 309	1.331.125	DRB 221	1.415.091	DRB 757	1.419.094R
DDB 486	1.306.233	DDJ 310	1.331.132	DRB 222	1.415.081	DRB 811	1.430.037R
DDB 487	1.306.231	DDJ 311	1.331.155	DRB 229	1.415.091	DRB 812	1.430.042R
DDB 488	1.306.123	DDJ 404	1.313.093	DRB 233	1.415.088	DRB 815	1.430.037R
DDB 489	1.306.090	DDJ 407	1.313.094	DRB 233R	1.415.088R	DRB 817	1.430.042R
DDB 490	1.306.127	DDJ 411	1.313.092	DRB 234	1.415.094	DRB 853	1.446.014R
DDB 491	1.306.128	DDJ 420	1.313.099	DRB 234R	1.415.094	DRB 862	1.430.029
DDB 492	1.306.234	DDJ 427	1.313.102	DRB 238	1.415.096R	DRB 863	1.430.036R
DDB 493	1.306.235	DDJ 428	1.313.107	DRB 239	1.415.097	DRB 864	1.430.036R
DDB 494	1.306.241	DDJ 440	1.313.113	DRB 240	1.415.091	DRB 864R	1.430.036R
DDB 495	1.306.240	DDJ 442	1.322.022	DRB 243	1.415.097	DRB 868	1.430.041
DDB 496	1.306.237	DDJ 446	1.313.262	DRB 244	1.415.099R	DRB 869	1.430.040
DDB 497	1.306.239	DDJ 447	1.313.114	DRB 246	1.415.101	DRB 871	1.430.042R
DDB 498	1.306.238	DDJ 450	1.313.240	DRB 247	1.415.104	DRB 871E	1.430.042R
DDB 500	1.306.117	DDJ 451	1.313.119	DRB 301	1.422.095	DRB 871R	1.430.042R
DDB 501	1.306.257	DDJ 463	1.313.107	DRB 431	1.406.014R	DRB 872	1.430.037
DDB 502	1.306.249	DDJ 464	1.313.122	DRB 431N	1.406.014R	DRB 886	1.430.047R
DDB 503	1.306.256	DDJ 491	1.322.069	DRB 432	1.406.012R	DRB 889	1.430.051R
DDB 504	1.306.258	DLB 101	1.970.101D	DRB 432N	1.406.012R	DRB 890	1.430.054R
DDB 505	1.306.253	DLB 105	1.970.101D	DRB 433	1.406.021R	DRB 891	1.430.055R

DRB 892	1.430.060	DSB 443V	1.206.034HVS	DUB 430	1.306.081	0 221 119 035	1.970.101D
DRB 893	1.430.057R	DSB 445	1.206.049HVS	DUB 443	1.406.026R	0 221 119 048	1.970.101D
DRB 895	1.430.059	DSB 445V	1.206.049HVS	DUB 455	1.306.258	0 221 122 008	1.970.169
DRB 900	1.415.102R	DSB 446	1.206.034HVS	DUB 455	1.406.113R	0 221 122 012	1.970.103
DRB 954	1.438.262R	DSB 446S	1.206.034HVS	DUB 753	1.319.093	0 221 122 022	1.970.132
DRB 957	1.446.014R	DSB 447	1.206.062	DVB 865	1.230.139	0 221 122 023	1.970.132
DRB 958	1.446.016R	DSB 448	1.206.040	E 456	1.217.026	0 221 122 031	1.970.169
DRJ 102	1.422.052	DSB 625	1.230.132	E 833	1.317.016	0 221 122 334	1.970.126
DRJ 104	1.422.092	DSB 625V	1.230.132	E 928	1.430.029	0 221 122 349	1.970.125
DRJ 107	1.422.056	DSB 626	1.230.140	F 420	1.219.043HV	0 221 122 350	1.970.125
DRJ 119	1.422.066	DSB 626V	1.230.140	F 421	1.219.044HV	0 221 122 357	1.970.126
DRJ 125	1.422.070	DSB 627	1.215.064	F4036	1.319.083	0 221 122 358	1.970.126
DRJ 131	1.422.069	DSB 628	1.230.139	F4521	1.419.085	0 221 122 369	1.970.194
DRJ 153	1.422.070	DSB 628V	1.230.139	J 436	1.213.011HV	0 221 122 379	1.970.127
DRJ 154	1.422.085	DSB 629	1.230.120	J 438	1.222.056HV	0 221 122 380	1.970.127
DRJ 201	1.431.133	DSB 629V	1.230.120	J 454	1.213.022HV	0 221 122 386	1.970.125
DRJ 202	1.431.023	DSB 631	1.215.064	J 830	1.313.093	0 221 122 399	1.970.126
DRJ 202R	1.431.023	DSB 633	1.217.024	J 836	1.331.109	0 221 122 400	1.970.126
DRJ 206	1.431.137	DSB 636	1.230.127	J 876	1.322.022	0 221 122 402	1.970.191
DRJ 220	1.431.023	DSB 636V	1.230.127	J 927	1.413.014	0 221 122 403	1.970.191
DRJ 224	1.431.107	DSB 637	1.217.026	J 970	1.413.014	0 221 122 408	1.970.192
DRJ 245	1.431.108	DSB 700	1.212.055HVS	L 431	1.228.083MHV	0 221 122 409	1.970.192
DRJ 300	1.431.131	DSB 700S	1.212.055HVS	L 453	1.228.089	0 221 123 007	1.970.101D
DRJ 401	1.413.014	DSB 700V	1.212.055HVS	L 837	1.328.096	0 221 502 009	1.970.112
DRJ 409	1.413.027	DSB 752	1.219.044HV	L 880	1.428.025	0 221 502 431	1.970.178
DRJ 419	1.413.014	DSB 753	1.219.043HV	L 887	1.328.094	0 221 502 433	1.970.179
DRJ 425	1.413.027	DSB 800	1.230.140	L 935	1.428.026R	0 221 503 001	1.970.273
DRJ 438	1.413.029	DSB 801	1.246.071	L4035	1.328.078	0 221 503 003	1.970.189
DRJ 447	1.422.082	DSB 801V	1.246.071	L4520	1.428.012	0 221 503 004	1.970.188
DSB 101	1.228.083MHV	DSB 853	1.246.070	M 20	1.130.117	0 221 503 006	1.970.189
DSB 109	1.228.083MHV	DSB 853V	1.246.070	M 32	1.117.097	0 221 503 011	1.970.389
DSB 191	1.228.089	DSB 861	1.230.132	M 34	1.130.127	0 221 503 014	1.970.398
DSB 201	1.206.034HVS	DSB 861V	1.230.132	M 408	1.230.146M	0 221 503 022	1.970.414
DSB 204	1.215.086	DSB 862	1.230.120	M 410	1.230.149M	0 221 503 024	1.970.189
DSB 210	1.215.105	DSB 862V	1.230.120	M 416	1.230.132	0 221 503 025	1.970.188
DSB 210E	1.215.105	DSB 863	1.230.140	M 417	1.230.140	0 221 503 035	1.970.417
DSB 213	1.215.111U	DSB 863V	1.230.140	M 418	1.230.139	0 221 503 036	1.970.417
DSB 215	1.215.064	DSB 865	1.230.139	M 419	1.230.120	0 221 503 407	1.970.168
DSB 220	1.215.076	DSB 865V	1.230.139	M 432	1.230.142	0 221 503 457	1.970.168
DSB 230	1.215.103	DSB 868	1.230.142	M 450	1.217.024	0 221 503 468	1.970.507
DSB 230E	1.215.103	DSB 868V	1.230.142	M 459	1.230.149	0 221 503 471	1.970.398
DSB 232	1.215.106	DSB 869	1.230.127	M 758	1.130.128	0 221 503 485	1.970.481
DSB 232E	1.215.106	DSB 869V	1.230.127	M 840	1.330.109	0 221 503 486	1.970.481
DSB 241	1.215.055	DSB 880M	1.230.146M	M 881	1.347.025	0 221 503 487	1.970.481
DSB 242	1.215.061	DSB 883M	1.230.148M	M 885	1.430.059	0 221 503 491	1.970.532
DSB 242V	1.215.061	DSB 884	1.230.149	M 893	1.330.111	0 221 503 700	1.970.272
DSB 244	1.215.067	DSB 884M	1.230.149M	M 930	1.430.041	0 221 503 800	1.970.547
DSB 245	1.215.056	DSB 886	1.230.148M	M 931	1.430.051R	0 221 504 004	1.970.352
DSB 246	1.242.054	DSB 887	1.230.149M	M 932	1.430.054R	0 221 504 006	1.970.314
DSB 250	1.215.067	DSB 951	1.236.045	M 933	1.430.060	0 221 504 026	1.970.549
DSB 252	1.215.101	DSB 956	1.207.701	M 934	1.406.060R	0 221 504 029	1.970.352
DSB 252E	1.215.101	DSJ 100	1.222.056HV	M4029	1.330.069	0 221 504 036	1.970.549
DSB 255	1.215.111U	DSJ 100V	1.222.056HV	M4043	1.330.090	0 221 504 100	1.970.475
DSB 256	1.215.112U	DSJ 204	1.231.084	M4045	1.330.104	0 221 504 410	1.970.412
DSB 266	1.215.055	DSJ 205	1.231.084	M4047	1.317.023	0 221 504 456	1.970.313
DSB 275	1.215.122	DSJ 402	1.213.011HV	M4048	1.330.098	0 221 504 463	1.970.475
DSB 276	1.206.049HVS	DSJ 403	1.213.011HV	M4518	1.430.037	0 221 504 467	1.970.475
DSB 279	1.215.126 ^P	DSJ 405V	1.213.022HV	M4530	1.430.042R	0 221 504 471	1.970.607
DSB 280	1.215.127 ^P	DTB 415	1.206.034HVS	M4533	1.430.047R	0 221 504 472	1.970.607
DSB 283	1.215.056	DTB 419	1.206.034HVS	M4535	1.417.058	0 221 504 474	1.970.412
DSB 431	1.206.032HV	DTB 422	1.206.040	M4536	1.430.055R	0 221 504 801	1.970.607
DSB 431V	1.206.032HV	DTB 812	1.230.140	MTR-01	1.965.005	0 221 505 437	1.970.317
DSB 432	1.206.034HVS	DTJ 452	1.213.011HV	RA 13	1.428.014	0 221 505 438	1.970.317
DSB 432C	1.206.034HVS	DTJ 453	1.213.011HV	RA 29	1.415.091	0 221 506 002	1.970.316
DSB 432S	1.206.034HVS	DUB 105	1.328.091	RA 200	1.406.014R	0 221 506 003	1.970.316
DSB 432V	1.206.034HVS	DUB 105	1.428.022	S 406	1.242.054	0 221 506 444	1.970.316
DSB 433	1.206.021	DUB 107	1.328.075	S4010	1.342.043	0 221 506 445	1.970.316
DSB 435	1.206.047	DUB 107	1.428.006	U 592	1.236.045	0 221 601 012	1.990.423
DSB 436	1.206.049HVS	DUB 111	1.328.098	0 009 3079 13	1.212.055HVS	0 221 604 001	1.970.448
DSB 436S	1.206.049HVS	DUB 111	1.428.027R	0 221 102 088	1.970.132	0 221 604 008	1.970.448
DSB 436V	1.206.049HVS	DUB 114	1.328.085	0 221 102 090	1.970.101D	0 221 604 010	1.970.478
DSB 437	1.206.040	DUB 114	1.428.012	0 221 102 091	1.970.101D	0 221 604 014	1.970.489
DSB 438	1.206.029HV	DUB 115	1.328.091	0 221 118 307	1.970.180	0 221 604 115	1.970.426
DSB 438V	1.206.029HV	DUB 115	1.428.021	0 221 118 329	1.970.178	0 221 604 116	1.970.426
DSB 439	1.206.029HV	DUB 116	1.328.091	0 221 118 398	1.970.126	0 221 604 701	1.970.626
DSB 440	1.206.029HV	DUB 116	1.428.021	0 221 119 008	1.970.101D	0 227 100 030	1.965.076
DSB 443	1.206.034HVS	DUB 226	1.315.054	0 221 119 018	1.970.101D	0 227 100 100	1.965.004
DSB 443C	1.206.034HVS	DUB 226	1.415.088	0 221 119 025	1.970.101D	0 227 100 101	1.965.004
DSB 443S	1.206.034HVS	DUB 227	1.315.054	0 221 119 027	1.970.101D	0 227 100 102	1.965.005

0986 221 030	1.970.355	029120-1540	1.313.107	06.549	1.500.386	060717101012	1.970.518
0986 221 031	1.970.356	029120-1600	1.313.240	06.551	1.500.398	060717104012	1.970.408
0986 221 033	1.970.196	029120-1700	1.313.241	06.552	1.500.398	060717105012	1.970.480
0986 221 034	1.970.403	029120-1720	1.313.128	06.557	1.500.466	060717106012	1.970.219
0986 221 103	1.970.638	029120-1850	1.313.123	06.558	1.500.386	060717111012	1.970.495
0986 221 114	1.970.556	029120-2120	1.313.278	06.560	1.500.351	060717113012	1.970.607
0986 221 146	1.970.647	029120-2130	1.313.262	06.561	1.500.347	060717119012	1.970.466
0986 22A 000	1.970.557	029120-2291	1.313.245	06.562	1.500.354	060717123012	1.970.203
0986 22A 201	1.970.420	029120-2311	1.313.093	06.563	1.500.815	060717126012	1.970.461
0986 22A 203	1.970.354S	029120-2590	1.313.123	06.565	1.500.815	060717130012	1.970.431
0986 22A 204	1.970.442	029120-2610	1.313.258	06.568	1.500.615	060717131012	1.970.374
0986 22A 205	1.970.483	029180-0240	1.413.014	06.569	1.500.808	060717135012	1.970.423
0986 22A 206	1.970.408	029180-0241	1.413.014	06.570	1.500.887	060717137012	1.970.547
0986 22A 207	1.970.570	029180-0340	1.413.014	06.572	1.500.616	060717144012	1.970.487
0986 22A 209	1.970.450	029180-0430	1.413.014	06.573	1.500.650	060717146012	1.970.481
0986 22A 216	1.970.619	029180-0580	1.413.014	06.574	1.500.456	060717148012	1.970.492
0986 22A 218	1.970.608	029180-0660	1.413.027	06.576	1.500.613	060717149012	1.970.556
0986 22A 222	1.970.533	029180-0910	1.413.029	06.577	1.500.655	060717150012	1.970.522
0986 22A 402	1.970.374	029180-0920	1.413.028	06.578	1.500.616	060717151012	1.970.536
0986 356 345	1.499.223	029180-0921	1.413.028	06.579	1.501.363	060717156012	1.970.450
0986 356 717	1.500.615	029180-0930	1.413.029	06.580	1.501.503	060717157012	1.970.483
0986 356 835	1.500.716	029180-0990	1.413.030	06.584	1.500.808	060717158012	1.970.445
0986 356 928	1.501.209	029180-1130	1.413.030	06.585	1.500.808	060717160012	1.970.435
0986 357 226	1.501.531	029180-1230	1.413.029	06.587	1.500.655	060717163012	1.970.417
0986 357 252	1.501.446	029180-1260	1.413.030	06.588	1.500.889	060717164012	1.970.602
0986 357 261	1.501.503	029180-1280	1.413.034	06.591	1.501.504	060717167012	1.970.436
0986 357 277	1.501.732	029180-1300	1.413.034	06.592	1.500.398	060717168012	1.970.586
0986 AG0 506	1.970.466	029180-1310	1.413.028	06.594	1.500.887	060717169012	1.970.433
0.71374201.010	1.330.116	029180-1391	1.413.028	06.598	1.501.505	060717173012	1.970.619
0.71377402.010	1.430.057R	029350-0200	1.213.011HV	0601-9106-5	1.331.139	060717175012	1.970.427
005.300	1.201.006	029350-0270	1.213.011HV	060690003010	1.970.101D	060717176012	1.970.516
01.522	1.500.623	029350-0550	1.213.022HV	060705404010	1.970.102	060717183012	1.970.420
01.526	1.500.660	029350-0650	1.213.011HV	060705404010	1.970.148	060717185012	1.970.507
01.527	1.500.623	029350-0660	1.213.022HV	060705409010	1.970.228	060717187012	1.970.612
01.529	1.500.716	029350-0690	1.213.011HV	060705604010	1.970.108	060717188012	1.970.609
01.534	1.500.623	029350-0740	1.213.022HV	060705606010	1.970.158	060717190012	1.970.518
01.538	1.501.608	029350-0820	1.213.022HV	060705738010	1.970.106	060717193012	1.970.611
01.538C	1.501.608	029350-0860	1.213.011HV	060705754010	1.970.155	060717199012	1.970.599
01.543	1.501.607	029700-5430	1.970.197	060708038010	1.970.146	060717202012	1.970.442
01.543C	1.501.607	029700-6700	1.970.135	060708049010	1.970.196	060717203012	1.970.552
014 885 0000	1.970.417	029700-6760	1.970.170	060708149010	1.970.196	060717206012	1.970.545
014 885 0005	1.970.487	029700-6770	1.970.289	060717026012	1.970.269	060717206012	1.970.545
014 885 0015	1.970.505	029700-6780	1.970.289	060717008012	1.990.414	060717207012	1.970.476
014 885 0017	1.970.503	029700-6820	1.970.202	060717009012	1.970.155	060717243012	1.970.614
014 885 0018	1.970.626	029700-7050	1.970.203	060717011012	1.970.140	060717244012	1.970.589
02.506	1.500.768	029700-7051	1.970.203^u	060717014012	1.970.105	060717247012	1.970.529
02.520	1.501.491	029700-7180	1.970.170	060717015012	1.970.106	060717250012	1.970.551
02.520C	1.501.491	029700-7301	1.970.322	060717017012	1.970.108	060717251012	1.970.505
029 120-135	1.313.099	029700-7531	1.970.289	060717020012	1.970.228	060717256012	1.970.537
029 120-139	1.313.114	029700-7700	1.970.285S	060717021012	1.970.347	060740303010	1.970.442
029 120-152	1.313.119	029700-7910	1.970.170	060717022012	1.970.214	060780002010	1.970.146
029 120-167	1.313.099	029700-8240	1.970.432	060717023012	1.970.215	060792001010	1.970.345
029 120-224	1.313.278	029700-8291	1.970.432	060717024012	1.970.213	060794001010	1.970.423
029 120-227	1.313.119	03.506	1.500.694	060717026012	1.970.233	060801005010	1.970.532
029 120-234	1.313.278	0347	1.501.883	060717029012	1.970.146	060801006010	1.970.312
029 120-253	1.313.257	0350	1.501.732	060717030012	1.970.405	060801012010	1.970.450
029 120-255	1.313.099	0355	1.501.413	060717031012	1.970.403	060810070010	1.970.432
029 120-256	1.313.099	04.500	1.500.572	060717037012	1.970.168	060810090010	1.970.384
029 120-263	1.313.251	04.506	1.500.572	060717042012	1.990.420	060810160010	1.970.602
029 120-265	1.313.248	04.527	1.500.572	060717043012	1.970.188	060810167010	1.970.431
029 120-273	1.313.278	05.513	1.501.374	060717044012	1.970.272	060810176010	1.970.475
029 120-282	1.313.252	05.515	1.500.674	060717048012	1.970.170	060810187010	1.970.489
029 120-321	1.313.265	05.516	1.500.780	060717051012	1.970.196	060810196010	1.970.426
029 120-333	1.313.275	05.518	1.500.494	060717052012	1.970.399	060810210010	1.970.475
029 120-340	1.313.267	05.524	1.500.748	060717053012	1.970.429	060810212010	1.970.475
029 120-357	1.313.272	05.528	1.500.494	060717055012	1.970.419	060810224010	1.970.549
029 120-366	1.313.273	056181168010	1.130.117	060717060012	1.970.596	060810229010	1.970.529
029120-0600	1.313.093	056181176010	1.130.117	060717064012	1.970.508	060810245010	1.970.314
029120-0601	1.313.093	056181182010	1.130.127	060717067012	1.970.345	060810269010	1.970.480
029120-0741	1.313.092	056181183010	1.130.128	060717068012	1.970.376	060810270010	1.970.481
029120-0760	1.313.094	056181202010	1.130.117	060717069012	1.970.378	061110041010	1.930.176M
029120-1020	1.313.099	06.500	1.500.386	060717070012	1.970.275	061110055010	1.930.176M
029120-1080	1.313.102	06.5100	1.501.451	060717071012	1.970.356	061110062010	1.930.176M
029120-1290	1.313.113	06.533	1.500.429	060717072012	1.970.365	061110103010	1.930.180M
029120-1390	1.313.114	06.543	1.500.466	060717073012	1.970.355	061110126010	1.930.180M
029120-1410	1.313.262	06.544	1.500.347	060717078012	1.970.459	064825072010	1.990.303
029120-1480	1.313.117	06.546	1.500.432	060717082012	1.970.407	064833040010	1.965.020
029120-1510	1.313.122	06.547	1.500.347	060717086012	1.970.458	0675	1.500.351
029120-1520	1.313.119	06.548	1.500.354	060717093012	1.970.591	0689	1.500.432

07.508	1.500.398	1 217 013 001	1.206.060	1 234 332 301	1.406.055R	1 234 335 305	1.406.059R
07.509	1.500.398	1 217 013 002	1.206.060	1 234 332 303	1.406.067R	1 234 335 801	1.412.093R
07.513	1.500.808	1 217 013 003	1.206.060	1 234 332 305	1.406.059R	1 234 335 802	1.415.091
07.514	1.500.692	1 217 013 006	1.206.060	1 234 332 309	1.406.055R	1 234 335 805	1.415.083R
07.515	1.500.398	1 217 013 009	1.206.064	1 234 332 313	1.406.112R	1 234 335 845	1.415.088R
07.516	1.500.456	1 217 013 015	1.206.060	1 234 332 317	1.406.117R	1 235 522 040	1.306.081
07.518	1.500.700	1 217 013 020	1.206.083	1 234 332 332	1.406.024R	1 235 522 041	1.306.081
07.521	1.500.650	1 217 013 021	1.206.068	1 234 332 333	1.406.070R	1 235 522 050	1.306.076
07.525	1.500.456	1 217 013 022	1.206.068	1 234 332 337	1.406.049R	1 235 522 051	1.306.072
07.528	1.500.456	1 217 013 025	1.206.083	1 234 332 340	1.406.114R	1 235 522 053	1.306.081
070005501010	1.330.059	1 217 013 103	1.206.060	1 234 332 341	1.406.122R	1 235 522 056	1.306.079
070189501010	1.430.029	1 217 031 015	1.206.068	1 234 332 343	1.406.115R	1 235 522 058	1.306.076
071006701010	1.230.120	1 220 522 019	1.970.192	1 234 332 344	1.406.112R	1 235 522 059	1.306.076
071093003010	1.430.054R	1 221 122 409	1.970.192	1 234 332 346	1.406.113R	1 235 522 060	1.306.072
071101607010	1.430.051R	1 227 010 003	1.965.034	1 234 332 347	1.406.119R	1 235 522 074	1.306.092
071111601010	1.230.139	1 227 010 039	1.965.034	1 234 332 348	1.406.116R	1 235 522 075	1.306.081
071118501010	1.230.140	1 227 020 029	1.970.191	1 234 332 349	1.406.118R	1 235 522 103	1.306.072
071119505010	1.430.042R	1 227 022 008	1.965.004	1 234 332 350	1.406.121R	1 235 522 107	1.306.062
071129001010	1.330.082	1 227 022 030	1.990.414	1 234 332 351	1.406.112R	1 235 522 109	1.306.072
071142401010	1.430.036R	1 227 030 030	1.990.414	1 234 332 353	1.406.117R	1 235 522 134	1.306.062
071142402010	1.430.042R	1 227 030 051	1.970.269	1 234 332 359	1.406.055R	1 235 522 141	1.306.076
071153901010	1.430.037R	1 227 030 052	1.970.269	1 234 332 360	1.406.121R	1 235 522 144	1.306.076
071171101010	1.330.086	1 227 030 059	1.970.386	1 234 332 364	1.406.122R	1 235 522 145	1.306.076
071171301010	1.430.040	1 227 030 062	1.970.387	1 234 332 365	1.406.125R	1 235 522 146	1.306.072
071174301010	1.330.090	1 227 030 071	1.970.397	1 234 332 366	1.406.121R	1 235 522 147	1.306.072
071197502010	1.230.142	1 230 500 221	1.906.160	1 234 332 370	1.406.123R	1 235 522 154	1.306.072
071237201010	1.430.047R	1 230 591 003	1.306.080	1 234 332 371	1.406.122R	1 235 522 155	1.306.079
071237202010	1.430.057R	1 230 591 040	1.306.266	1 234 332 374	1.406.121R	1 235 522 157	1.306.062
071237801010	1.430.047R	1 234 211 018	1.906.153	1 234 332 381	1.406.127R	1 235 522 158	1.306.072
071243702010	1.330.098	1 234 211 218	1.906.153	1 234 332 382	1.406.126R	1 235 522 159	1.306.072
071246105010	1.330.101	1 234 332 024	1.406.018R	1 234 332 387	1.406.121R	1 235 522 167	1.306.076
071275301010	1.430.055R	1 234 332 029	1.406.018R	1 234 332 390	1.406.147R	1 235 522 169	1.306.076
071277902010	1.230.146M	1 234 332 030	1.406.018R	1 234 332 393	1.406.121R	1 235 522 171	1.306.072
071277905010	1.230.149M	1 234 332 033	1.406.012R	1 234 332 395	1.406.140R	1 235 522 173	1.306.076
071293402010	1.230.148M	1 234 332 062	1.406.018R	1 234 332 399	1.406.121R	1 235 522 175	1.306.076
071302701010	1.330.109	1 234 332 072	1.406.018R	1 234 332 401	1.406.061R	1 235 522 176	1.306.072
071319801010	1.930.161/1	1 234 332 074	1.406.012R	1 234 332 402	1.406.121R	1 235 522 177	1.306.072
071319804010	1.930.163/1	1 234 332 076	1.406.014R	1 234 332 408	1.406.146R	1 235 522 179	1.306.076
071326901010	1.930.177/1	1 234 332 082	1.406.014R	1 234 332 414	1.406.121R	1 235 522 181	1.306.072
071347401010	1.930.180M	1 234 332 087	1.406.018R	1 234 332 417	1.406.125R	1 235 522 183	1.306.079
071349101010	1.930.176M	1 234 332 088	1.406.018R	1 234 332 421	1.406.148R	1 235 522 185	1.306.079
071351702010	1.430.059	1 234 332 089	1.406.014R	1 234 332 422	1.406.146R	1 235 522 188	1.306.079
071358401010	1.330.111	1 234 332 106	1.406.021R	1 234 332 426	1.406.149R	1 235 522 189	1.306.079
071366701010	1.330.101	1 234 332 107	1.406.021R	1 234 332 800	1.412.093	1 235 522 193	1.306.079
071366702010	1.330.101	1 234 332 109	1.406.021R	1 234 332 801	1.412.093R	1 235 522 195	1.306.081
071366801010	1.330.098	1 234 332 144	1.406.067R	1 234 332 802	1.415.091	1 235 522 196	1.306.080
071371301010	1.430.060	1 234 332 158	1.406.067R	1 234 332 803	1.415.081	1 235 522 198	1.306.081
08.502	1.501.654	1 234 332 162	1.406.067R	1 234 332 805	1.415.083R	1 235 522 199	1.306.079
08.510	1.501.305	1 234 332 173	1.406.024R	1 234 332 808	1.430.037	1 235 522 201	1.306.079
08.512	1.501.323	1 234 332 177	1.406.023R	1 234 332 809	1.430.037R	1 235 522 202	1.306.080
0825	1.500.514	1 234 332 197	1.406.024R	1 234 332 810	1.430.037	1 235 522 203	1.306.079
0890	1.501.888	1 234 332 200	1.406.113R	1 234 332 811	1.430.037R	1 235 522 208	1.306.090
09.506	1.500.509	1 234 332 204	1.406.034R	1 234 332 812	1.430.037	1 235 522 213	1.306.094
09.515	1.501.237	1 234 332 208	1.406.027R	1 234 332 813	1.430.037R	1 235 522 218	1.306.093
09.516	1.500.527	1 234 332 209	1.406.067R	1 234 332 814	1.430.036R	1 235 522 219	1.306.079
09.518	1.500.514	1 234 332 213	1.406.025R	1 234 332 827	1.413.014	1 235 522 227	1.306.079
09.519	1.500.634	1 234 332 215	1.406.025R	1 234 332 828	1.413.014	1 235 522 229	1.306.081
09.531	1.500.688	1 234 332 216	1.406.026R	1 234 332 836	1.406.014R	1 235 522 256	1.306.079
09.532	1.501.562	1 234 332 220	1.406.115R	1 234 332 838	1.415.088R	1 235 522 290	1.306.081
09.536	1.501.531	1 234 332 236	1.406.024R	1 234 332 841	1.415.088R	1 235 522 295	1.306.081
09.538	1.501.529	1 234 332 237	1.406.024R	1 234 332 845	1.415.088R	1 235 522 307	1.306.099
09.539	1.500.688	1 234 332 242	1.406.116R	1 234 332 848	1.428.012	1 235 522 315	1.306.079
09.543	1.500.527	1 234 332 261	1.406.025R	1 234 332 849	1.430.042R	1 235 522 322	1.306.109
09.545	1.500.689	1 234 332 271	1.406.061R	1 234 332 850	1.415.083R	1 235 522 323	1.306.092
09.554	1.501.947	1 234 332 272	1.406.117R	1 234 332 859	1.446.014R	1 235 522 324	1.306.090
099 700-061	1.970.457	1 234 332 273	1.406.056R	1 234 332 860	1.415.094	1 235 522 325	1.306.117^A
099 700-072	1.970.457	1 234 332 275	1.406.061R	1 234 332 861	1.412.096	1 235 522 326	1.306.108
099 700-101	1.970.522	1 234 332 276	1.406.112R	1 234 332 902	1.406.012R	1 235 522 327	1.306.108^A
099 700-114	1.970.457	1 234 332 277	1.406.117R	1 234 332 903	1.406.014R	1 235 522 329	1.306.123
1 046 7543	1.312.075	1 234 332 279	1.406.060R	1 234 332 904	1.406.018R	1 235 522 330	1.306.123^A
1 046 7546	1.412.098	1 234 332 280	1.406.027R	1 234 332 906	1.406.021R	1 235 522 332	1.306.124
1 049 5408	1.412.098	1 234 332 281	1.406.115R	1 234 332 907	1.406.021R	1 235 522 333	1.306.121
1 049 5411	1.412.098	1 234 332 282	1.406.049R	1 234 332 908	1.406.025R	1 235 522 356	1.306.079
1 049 5822	1.312.075	1 234 332 284	1.406.117R	1 234 332 918	1.412.093R	1 235 522 357	1.306.094
1 049 6278	1.312.075	1 234 332 285	1.406.026R	1 234 335 082	1.406.014R	1 235 522 361	1.306.121
1 103 516	1.912.011^N	1 234 332 288	1.406.115R	1 234 335 215	1.406.025R	1 235 522 362	1.306.081^A
1 103 549	1.912.011^N	1 234 332 291	1.406.067R	1 234 335 216	1.406.026R	1 235 522 364	1.306.238
1 212 208	1.412.093	1 234 332 296	1.406.060R	1 234 335 280	1.406.027R	1 235 522 365	1.306.238^A
1 214 140	1.312.066	1 234 332 300	1.406.055R	1 234 335 300	1.406.055R	1 235 522 366	1.306.127

1 235 522 368	1.306.123	1 235 522 930	1.312.066	1 237 013 112	1.206.062	1 237 013 916	1.206.034HVS
1 235 522 369	1.306.231	1 235 522 931	1.306.080	1 237 013 113	1.206.049HVS	1 237 013 917	1.206.034HVS
1 235 522 370	1.306.129	1 235 525 056	1.306.079	1 237 013 114	1.206.034HVS	1 237 013 918	1.212.055HVS
1 235 522 371	1.306.231	1 235 525 059	1.306.076	1 237 013 115	1.206.062	1 237 013 919	1.230.132
1 235 522 372	1.306.261	1 235 525 196	1.306.080	1 237 013 116	1.206.034HVS	1 237 013 920	1.230.139
1 235 522 374	1.306.235	1 235 525 801	1.312.066	1 237 013 117	1.206.034HVS	1 237 013 921	1.230.140
1 235 522 375	1.306.266	1 235 525 803	1.315.049	1 237 013 119	1.206.034HVS	1 237 013 923	1.206.034HVS
1 235 522 380	1.306.234^{FA}	1 235 525 806	1.315.045	1 237 013 121	1.206.049HVS	1 237 013 924	1.212.055HVS
1 235 522 381	1.306.234	1 235 525 812	1.342.043	1 237 013 122	1.206.062	1 237 015 802	1.212.055HVS
1 235 522 382	1.306.127^{FA}	1 237 000 065	1.306.241^{FA}	1 237 013 123	1.206.034HVS	1 237 015 804	1.230.132
1 235 522 384	1.306.237	1 237 010 027	1.906.223	1 237 013 124	1.206.034HVS	1 237 015 805	1.230.139
1 235 522 385	1.306.231^{FA}	1 237 010 033	1.906.233	1 237 013 125	1.206.034HVS	1 237 015 806	1.230.140
1 235 522 387	1.306.236	1 237 010 039	1.906.223	1 237 013 129	1.206.049HVS	1 237 015 808	1.215.055
1 235 522 388	1.306.236^{FA}	1 237 011 073	1.906.159	1 237 013 130	1.206.034HVS	1 237 015 821	1.242.054
1 235 522 390	1.306.233	1 237 011 076	1.906.193	1 237 013 138	1.206.034HVS	1 237 015 848	1.215.103
1 235 522 391	1.306.239	1 237 011 081	1.906.219	1 237 013 139	1.206.062	1 237 031 093	1.906.244
1 235 522 392	1.306.239^{FA}	1 237 011 111	1.906.193	1 237 013 140	1.206.034HVS	1 237 031 123	1.906.153^{FS}
1 235 522 395	1.306.128^{FA}	1 237 011 114	1.906.233	1 237 013 143	1.206.062	1 237 031 180	1.906.233
1 235 522 396	1.306.247^{FA}	1 237 011 119	1.906.234	1 237 013 144	1.206.034HVS	1 237 031 296	1.906.223
1 235 522 397	1.306.247	1 237 011 122	1.906.223	1 237 013 145	1.206.034HVS	1 237 031 339	1.906.244
1 235 522 399	1.306.240	1 237 011 124	1.906.223	1 237 013 146	1.206.049HVS	1 237 330 035	1.106.030
1 235 522 400	1.306.240^{FA}	1 237 013 000	1.206.047	1 237 013 147	1.206.049HVS	1 237 330 036	1.106.030
1 235 522 401	1.306.241	1 237 013 001	1.206.047	1 237 013 150	1.206.034HVS	1 237 330 039	1.106.030
1 235 522 404	1.306.231	1 237 013 002	1.206.034HVS	1 237 013 151	1.206.049HVS	1 237 330 307	1.106.212
1 235 522 405	1.306.231^{FA}	1 237 013 003	1.206.047	1 237 013 152	1.206.049HVS	1 237 330 310	1.106.196
1 235 522 408	1.306.260^{FA}	1 237 013 006	1.206.029HV	1 237 013 157	1.206.049HVS	1 237 330 316	1.106.195
1 235 522 409	1.306.080^{FA}	1 237 013 007	1.206.029HV	1 237 013 158	1.206.049HVS	1 237 330 340	1.106.212
1 235 522 417	1.306.251^{FA}	1 237 013 008	1.206.021	1 237 013 300	1.215.106	1 237 330 348	1.106.257
1 235 522 418	1.306.251	1 237 013 009	1.206.029HV	1 237 013 302	1.215.106	1 237 330 353	1.106.212
1 235 522 419	1.306.248	1 237 013 010	1.206.029HV	1 237 013 305	1.215.105	1 237 330 801	1.115.023
1 235 522 420	1.306.248^{FA}	1 237 013 025	1.206.029HV	1 237 013 307	1.236.045	1 237 330 803	1.115.023
1 235 522 421	1.306.238	1 237 013 027	1.206.021	1 237 013 600	1.222.056HV	1 237 330 805	1.115.034
1 235 522 423	1.306.253	1 237 013 029	1.206.029HV	1 237 013 710	1.206.029HV	1 237 330 806	1.115.034
1 235 522 424	1.306.080	1 237 013 039	1.206.032HV	1 237 013 712	1.206.034HVS	1 237 330 810	1.142.056
1 235 522 426	1.306.233	1 237 013 041	1.206.021	1 237 013 713	1.230.120	1 237 330 811	1.142.056
1 235 522 434	1.306.257	1 237 013 042	1.206.021	1 237 013 714	1.230.132	1 237 330 828	1.130.117
1 235 522 435	1.306.257^{FA}	1 237 013 044	1.206.034HVS	1 237 013 715	1.219.043HV	1 601 0892	1.965.025
1 235 522 436	1.306.249	1 237 013 045	1.206.029HV	1 237 013 717	1.215.061	1 612 229	1.212.055HVS
1 235 522 437	1.306.256	1 237 013 047	1.206.021	1 237 013 718	1.215.064	1 847 291	1.412.090
1 235 522 438	1.306.258	1 237 013 049	1.206.029HV	1 237 013 719	1.228.083MHV	1 849 955	1.412.090
1 235 522 439	1.306.258^{FA}	1 237 013 051	1.206.034HVS	1 237 013 720	1.215.056	1 883 500	1.412.090
1 235 522 442	1.306.252^{FA}	1 237 013 052	1.206.049HVS	1 237 013 724	1.219.044HV	1 905 590	1.412.090
1 235 522 443	1.306.094	1 237 013 053	1.206.029HV	1 237 013 728	1.219.043HV	1 909 590	1.412.090
1 235 522 444	1.306.266	1 237 013 055	1.206.032HV	1 237 013 802	1.212.055HVS	1 936 109	1.412.096
1 235 522 447	1.306.260	1 237 013 056	1.206.029HV	1 237 013 803	1.230.120	1 945 376	1.230.127
1 235 522 449	1.306.233^{FA}	1 237 013 057	1.206.040	1 237 013 804	1.230.132	1 972 927	1.312.073
1 235 522 453	1.306.263	1 237 013 059	1.206.049HVS	1 237 013 805	1.230.139	1 977 958	1.965.025
1 235 522 454	1.306.263^{FA}	1 237 013 060	1.206.047	1 237 013 806	1.230.140	1 979 107	1.965.025
1 235 522 456	1.306.079	1 237 013 061	1.206.049HVS	1 237 013 808	1.215.055	1 985 771	1.312.074
1 235 522 465	1.306.094	1 237 013 062	1.206.049HVS	1 237 013 809	1.215.061	1 986 109	1.412.096
1 235 522 496	1.306.080	1 237 013 063	1.206.034HVS	1 237 013 811	1.215.064	1 987 231 000	1.213.011HV
1 235 522 801	1.312.066	1 237 013 065	1.206.034HVS	1 237 013 812	1.215.067	1 987 231 001	1.213.011HV
1 235 522 803	1.315.049	1 237 013 066	1.206.034HVS	1 237 013 814	1.215.111U	1 987 231 004	1.222.056HV
1 235 522 804	1.315.041	1 237 013 068	1.206.040	1 237 013 819	1.228.083MHV	1 987 231 006	1.231.084
1 235 522 805	1.315.045	1 237 013 074	1.206.034HVS	1 237 013 821	1.242.054	1 987 231 015	1.231.084
1 235 522 806	1.315.045	1 237 013 075	1.206.062	1 237 013 824	1.230.123	1 987 231 020	1.213.022HV
1 235 522 807	1.330.069	1 237 013 077	1.206.034HVS	1 237 013 826	1.213.011HV	1 987 231 032	1.231.084
1 235 522 810	1.330.081	1 237 013 079	1.206.062	1 237 013 827	1.215.076	1 987 231 033	1.231.085
1 235 522 812	1.342.043	1 237 013 081	1.206.034HVS	1 237 013 828	1.215.111U	1 987 231 900	1.213.011HV
1 235 522 816	1.322.003	1 237 013 082	1.206.049HVS	1 237 013 831	1.230.142	1 987 231 904	1.222.056HV
1 235 522 819	1.322.003	1 237 013 083	1.206.034HVS	1 237 013 832	1.222.056HV	1 987 231 915	1.231.084
1 235 522 822	1.319.083	1 237 013 086	1.206.062	1 237 013 835	1.230.127	1 987 231 932	1.231.084
1 235 522 829	1.330.086	1 237 013 087	1.206.034HVS	1 237 013 837	1.246.071	1 987 231 933	1.231.085
1 235 522 831	1.328.075	1 237 013 088	1.206.034HVS	1 237 013 838	1.215.086	1 987 233 003	1.331.003/00
1 235 522 832	1.315.059	1 237 013 090	1.206.034HVS	1 237 013 840	1.215.102	1 987 233 008	1.322.003
1 235 522 835	1.347.025	1 237 013 091	1.206.062	1 237 013 842	1.212.055HVS	1 987 233 012	1.331.003/00
1 235 522 836	1.330.069	1 237 013 094	1.206.034HVS	1 237 013 846	1.212.055HVS	1 987 233 020	1.331.003/00
1 235 522 837	1.317.014	1 237 013 096	1.206.034HVS	1 237 013 848	1.215.103	1 987 233 022	1.313.093
1 235 522 843	1.328.078	1 237 013 098	1.206.034HVS	1 237 013 901	1.206.047	1 987 233 030	1.313.262
1 235 522 844	1.330.090	1 237 013 101	1.206.047	1 237 013 902	1.206.029HV	1 987 233 032	1.313.122
1 235 522 845	1.315.054	1 237 013 102	1.206.029HV	1 237 013 904	1.206.032HV	1 987 233 033	1.313.092
1 235 522 863	1.312.073	1 237 013 103	1.206.029HV	1 237 013 906	1.206.034HVS	1 987 233 036	1.322.011
1 235 522 901	1.306.076	1 237 013 105	1.206.032HV	1 237 013 907	1.206.040	1 987 233 037	1.322.022
1 235 522 902	1.306.072	1 237 013 106	1.206.034HVS	1 237 013 910	1.215.055	1 987 233 043	1.331.118
1 235 522 903	1.306.076	1 237 013 107	1.206.040	1 237 013 911	1.242.054	1 987 233 044	1.331.121
1 235 522 904	1.306.072	1 237 013 108	1.206.062	1 237 013 912	1.206.049HVS	1 987 233 047	1.322.057
1 235 522 905	1.306.079	1 237 013 109	1.206.034HVS	1 237 013 913	1.206.034HVS	1 987 233 051	1.322.040
1 235 522 907	1.306.062	1 237 013 110	1.206.034HVS	1 237 013 914	1.206.034HVS	1 987 233 052	1.322.046
1 235 522 908	1.306.079	1 237 013 111	1.206.034HVS	1 237 013 915	1.206.049HVS	1 987 233 054	1.313.123

1987 233 055	1.313.107	106.005E	1.970.314	111.002	1.970.419	13 3812	1.970.431
1987 233 908	1.322.003	106.006E	1.970.387	111.003	1.970.432	13 3828	1.970.445
1987 233 912	1.331.003/00	1060	1.906.193	111.003E	1.970.432	13 3831	1.970.427
1987 234 001	1.413.014	1061	1.906.231	111.005	1.970.518	13 3832	1.970.450
1987 234 003	1.413.014	1062	1.906.223	111.006	1.970.518	13 3834	1.970.436
1987 234 009	1.431.023	1063	1.906.234	111.010	1.970.613	13 3835	1.970.427
1987 234 015	1.422.052	1064	1.906.233	111.010E	1.970.613	13 3836	1.970.426
1987 234 021	1.413.014	108.001	1.970.316K	11-14 885 0002	1.970.407	13 8001	1.965.005
1987 234 024	1.431.023	108.007	1.970.487	11-14 885 0004	1.970.509	13 8002	1.965.004
1987 234 025	1.413.027	108.007E	1.970.487	11-14 885 0006	1.970.483	13 8004	1.965.007
1987 234 027	1.413.029	108.011E	1.970.626	11-14 885 0007	1.970.408	13 8007	1.990.414
1987 234 031	1.422.073	1087	1.906.159	114 213	1.970.433	13 8012	1.965.034
1987 234 033	1.431.113	109 039	1.970.474	114 885 0005	1.970.425	13 8026	1.965.025
1987 234 038	1.431.110	109 316	1.990.420	114 885 0006	1.970.429	13 8030	1.965.029
1987 234 041	1.413.028	109 540	1.970.445	114 885 0007	1.990.420	13 8034	1.965.036
1987 234 042	1.422.056	109 541	1.970.429	114.001	1.970.474	13 8052	1.965.051
1987 234 901	1.413.014	109.001	1.970.399	114.002	1.970.429	13 8068	1.965.052
1987 234 909	1.431.023	109.001E	1.970.399	114.006	1.970.427	13 8082	1.965.020
1987 948	1.312.075	109.002	1.970.398	114.006E	1.970.427	13 8106	1.906.153
1988 515	1.412.097	109.003	1.970.400	114.007	1.970.426	13 8131	1.915.019
10.509	1.500.747	109.004	1.970.508	114.007E	1.970.426	13 8134	1.915.017
10.510	1.500.748	109.004E	1.970.508	114.008	1.970.445	13 8172	1.930.161/1
10.511	1.500.494	109.005	1.970.507	114.008E	1.970.445	13 8174	1.930.163/1
10.513	1.501.025	109.005E	1.970.507	114.009	1.970.354S	13 8185	1.930.178M
10.515	1.500.494	109.006E	1.970.450	114.009E	1.970.354S	13 8191	1.930.177/1
10.516	1.500.674	109.020	1.970.547	114.010E	1.970.474	13 8192	1.930.180M
10.520	1.501.374	109.020E	1.970.547	114.013	1.970.434	13 8193	1.930.176M
10.521	1.501.374	109.029	1.970.631	114.014	1.970.436	13 8194	1.930.180M
100 885 0001	1.970.354S	109.029E	1.970.631	114.014E	1.970.436	13 8416	1.990.416
100 885 0002	1.970.445	109006	1.970.450	114.015	1.970.431	131.002E	1.970.457
100 885 0007	1.970.436	109007	1.970.400	114.016	1.970.433	131.005	1.970.608
100 885 0012	1.970.431	11.513	1.500.801	114.016E	1.970.433	131.005E	1.970.608
100 885 0020	1.970.437	11.514	1.500.801	114.019	1.970.434	131.006	1.970.529
100 885 0022	1.970.434	11.515	1.500.539	114.020	1.970.599	131.006E	1.970.529
100 885 0023	1.970.427	11.517	1.500.801	114.022	1.970.435	131.008	1.970.522
100 885 0024	1.970.599	11.522	1.500.802	114.022E	1.970.435	131.008E	1.970.522
100 885 0026	1.970.433	11.523	1.501.332	114.024	1.970.425	131.009E	1.970.603
100 885 0027	1.970.354S	11.527	1.500.920	114010	1.970.474	131.012	1.970.527
100 885 0040	1.970.474	11.530	1.501.446	115.002E	1.970.480	132.002	1.970.516
100 905 0007	1.990.414	11.532	1.500.539	115.004	1.970.619	132.002E	1.970.516
100 905 0025	1.970.426	11.534	1.500.417	115.004E	1.970.619	132.003	1.970.514
1002	1.201.005	11.535	1.501.447	116 400	1.970.599	133.001E	1.970.459
1003	1.906.153	11.536	1.500.543	118.001	1.970.448	133.003	1.970.461
101 106	1.970.101D	11.538	1.501.447	118.001E	1.970.448	133.008	1.970.458
101 106 K	1.970.101D	11.539	1.499.244	118.002	1.970.478	133.008E	1.970.458
101 406	1.970.132	11.541	1.500.415	118.002E	1.970.478	133.010	1.970.466
101 407	1.970.127	11.543	1.501.492	12.508	1.500.612	133.010E	1.970.466
101 413	1.970.125	11.545	1.500.801	12.509	1.500.725	133.012	1.970.536
101.001	1.970.386K	11.546	1.499.244	12.512	1.500.725	133.012E	1.970.536
101.002	1.970.387K	11.548	1.499.049	12133- 1	1.417.052	133.015	1.970.537
101.002E	1.970.387	11.560	1.499.230	12133- 4	1.417.052	133009	1.970.461
101.006	1.970.397	11.561	1.499.246	12146- 1	1.230.132	133800	1.970.432
101.006E	1.970.397	11.861	1.499.246	12146- 3	1.230.140	133805	1.970.354S
101.300	1.201.005	110 572	1.970.436	125.003	1.970.591	133806	1.970.429
10230- 2	1.330.069	110 921	1.970.434	125.003E	1.970.591	133806	1.970.429
10230- 4	1.330.069	110.001	1.970.403	1250	1.930.161/1	133807	1.970.474
10230- 7	1.330.069	110.001E	1.970.403	1252	1.930.163/1	133809	1.970.399
10230-12	1.330.069	110.002	1.970.405	126.008	1.970.557	133810	1.970.508
10230-13	1.330.069	110.007E	1.970.408	126.008E	1.970.557	133812	1.970.431
10249-43	1.117.097	110.010E	1.970.407	126.009	1.970.489	133817	1.970.403
10249-43J	1.117.097	110.011	1.970.509	126.009E	1.970.489	133818	1.970.405
10254- 1	1.230.127	110.020	1.970.483	126.012	1.970.602	133819	1.970.407
1029005-6005	1.206.068	110.020E	1.970.483	126.016	1.970.551	133825	1.970.475
103 240	1.970.125	110.022	1.970.620	126.018E	1.970.552	133828	1.970.445
104 033	1.990.414	110.023	1.970.609	1264	1.930.180M	133831	1.970.427
104.001	1.970.413	110.023E	1.970.609	1266	1.930.176M	133832	1.970.450
104.004	1.970.412	110.024	1.970.497	1269	1.930.177/1	133832	1.970.450
104.005	1.970.607	110.024E	1.970.497	1270	1.930.180M	133834	1.970.436
104.005E	1.970.607	110007	1.970.408	1272	1.930.178M	133836	1.970.426
104.008	1.970.162S	110010	1.970.407	129.009E	1.970.638	133841	1.970.397
104.011E	1.970.475	110021	1.970.461	129.010	1.970.611	133842	1.970.476
104.012	1.970.632	1101	1.906.222	129.010E	1.970.611	133843	1.970.509
104003	1.970.475	1104082	1.970.450	129.011E	1.970.492	133845	1.970.433
1057	1.906.219	1104091	1.970.483	129.012	1.970.556	133846	1.970.461
106.002	1.970.442	111 088	1.970.431	129.012E	1.970.556	133846	1.970.461
106.002E	1.970.442	111 310	1.970.354S	13 3805	1.970.354	133847	1.970.434
106.003	1.970.384	111 621	1.970.427	13 3806	1.970.429	133848	1.970.435
106.003E	1.970.384	111 741	1.970.426	13 3807	1.970.474	133852	1.970.480
106.005	1.970.314	111 743	1.970.435	13 3808	1.970.426	133854	1.970.483

133860	1.970.557	134376	1.499.241	14.514	1.500.965	155049	1.970.475
133861	1.970.387	134377	1.499.251	14.515	1.500.737	155050	1.970.365
133863	1.970.489	134431	1.500.674	14.516	1.501.667	155051	1.970.345
133870	1.970.448	134432	1.500.494	14.517	1.501.575	155054	1.970.434
133874	1.970.458	134464	1.501.446	14.521	1.501.580	155056	1.970.108
133875	1.970.475	134467	1.500.616	14.523	1.501.640	155057	1.970.272
133876	1.970.607	134471	1.500.780	14.524	1.501.601	155058	1.970.148
133879	1.970.507	134484	1.500.615	14.525	1.501.601	155059	1.970.155
133883	1.970.408	134497	1.501.025	14.526	1.500.725	155060	1.970.228
133883	1.970.408	134518	1.501.503	14.532	1.501.609	155061	1.970.107
133909	1.970.602	134528	1.501.385	14.534	1.501.489	155062	1.970.341
133910	1.970.529	134534	1.501.363	14.561	1.499.223	155064	1.970.140
133913	1.970.457	134560	1.499.061	1420	1.500.920	155065	1.970.158
133926	1.970.384	134603	1.499.111	1429	1.499.244	155066	1.970.214
133929	1.970.551	134619	1.501.883	1431	1.501.492	155067	1.970.374
133930	1.970.608	134758	1.501.363	1439	1.499.049	155068	1.970.394
133936	1.970.516	134871	1.500.634	1443	1.501.681	155069	1.970.159
133939	1.970.514	134952	1.501.643	145.002	1.970.503	155070	1.970.414
133941	1.970.536	134955	1.499.245	145.002E	1.970.503	155071	1.970.199
133944	1.970.527	134958	1.499.059	15 43 01	1.970.403	155072	1.970.417
133950	1.970.586	134961	1.499.248	15 43 02	1.970.405	155073	1.990.423
133956	1.970.623	1351	1.915.019	15.506	1.501.078	155074	1.970.423
133962	1.970.620	1355	1.915.017	15.508	1.501.281	155074	1.970.423
133963	1.970.591	138.004	1.970.495	15.513	1.501.281	155075	1.970.481
133965	1.970.627	138.004E	1.970.495	15.514	1.500.864	155076	1.970.168
133971	1.970.536	138.005	1.970.543	15.515	1.501.630	155077	1.970.317
133973	1.970.645	138.005E	1.970.543	15.516	1.500.864	155079	1.970.219
133974	1.970.538	138.006	1.970.614	15.520	1.501.630	155082	1.970.105
134003	1.970.603	138.006E	1.970.614	15.527	1.501.619	155083	1.970.106
134006	1.970.492	138415	1.990.414	15.528	1.501.630	155085	1.970.178
134010	1.970.466	138425	1.990.420	15.534	1.501.691	155086	1.970.213
134035	1.970.543	138701	1.970.269	15.536	1.501.634	155088	1.970.448
134038	1.970.537	138704	1.990.420	15.541	1.501.568	155089	1.970.273
134041	1.970.487	138709	1.970.417	15.542	1.501.614	155092	1.970.557
134044	1.970.522	138712	1.970.419	15.543	1.501.624	155093	1.970.585
134045	1.970.495	138713	1.970.518	1514	1.970.419	155095	1.970.313
134048	1.970.547	138716	1.970.178	151401	1.970.419	155100	1.970.1625
134051	1.970.609	138718	1.970.582	151408	1.970.518	155102	1.970.427
134058	1.970.613	138727	1.970.423	1543	1.970.403	155103	1.970.425
134080	1.970.611	138730	1.970.146	154301	1.970.403	155104	1.970.431
134081	1.970.614	138734	1.970.296	154302	1.970.405	155106	1.970.435
134083	1.970.497	138735	1.970.228	154303	1.970.405	155109	1.970.437
134085	1.970.619	138736	1.970.275	155001	1.970.314	155110	1.970.436
134086	1.970.503	138737	1.970.266	155002	1.970.386	155111	1.970.433
134087	1.970.505	138738	1.970.196	155003	1.970.398	155113	1.970.586
134090	1.970.632	138739	1.970.345	155004	1.970.316	155118	1.970.580
134093	1.970.631	138744	1.970.179	155006	1.970.397	155119	1.970.589
134094	1.970.626	138746	1.970.496	155009	1.970.480	155125	1.970.602
134114	1.499.239	138749	1.970.586	155010	1.970.532	155136	1.970.475
134117	1.499.235	138752	1.970.155	155013	1.970.376	155138	1.970.489
134119	1.501.509	138754	1.970.105	155014	1.970.378	155140	1.970.461
134130	1.501.209	138756	1.970.189	155015	1.970.196	155140	1.970.461
134132	1.501.880	138757	1.970.355	155016	1.970.596	155141	1.970.466
134202	1.500.514	138758	1.970.356	155017	1.970.146	155142	1.970.458
134203	1.500.689	138759	1.970.376	155018	1.970.355	155148	1.970.483
134214	1.500.689	138760	1.970.188	155019	1.970.356	155149	1.970.347
134227	1.501.634	138762	1.970.272	155020	1.970.442	155154	1.970.233
134234	1.501.531	138765	1.970.365	155022	1.970.400	155164	1.970.168
134236	1.501.680	138766	1.970.378	155022	1.970.400	155166	1.970.585
134239	1.501.731	138769	1.970.423	155025	1.970.275	155174	1.970.495
134246	1.501.529	138780	1.970.140	155026	1.990.414	155177	1.970.581
134260	1.499.006	138793	1.970.168	155026	1.990.414	155180	1.970.478
134263	1.499.007	138800	1.970.135	155027	1.970.408	155183	1.970.496
134268	1.501.511	138803	1.970.169	155027	1.970.408	155184	1.970.535
134272	1.501.451	138803	1.970.532	155028	1.970.459	155190	1.970.475
134273	1.501.739	138810	1.970.347	155028	1.970.459	155200	1.970.413
134275	1.501.531	138811	1.970.532	155029	1.970.400	155205	1.970.545
134276	1.500.608	138812	1.970.214	155031	1.970.509	155205	1.970.545
134278	1.499.242	138856	1.970.579	155032	1.970.407	155400	1.970.1625
134279	1.501.278	138866	1.970.198	155032	1.970.407	155500	1.970.3545
134280	1.501.411	138868	1.970.203	155033	1.970.188	155700	1.970.1625
134286	1.501.745	14.502	1.500.736	155034	1.970.189	156100	1.990.420
134287	1.501.888	14.503	1.501.549	155038	1.970.508	156200	1.970.432
134296	1.501.237	14.506	1.500.725	155039	1.970.450	156200	1.970.432
134332	1.501.504	14.507	1.500.725	155039	1.970.450	156300	1.970.399
134333	1.501.505	14.508	1.501.364	155040	1.970.476	157100	1.970.384
134337	1.499.236	14.510	1.500.493	155041	1.970.476	157400	1.970.474
134373	1.501.889	14.512	1.501.364	155045	1.970.398	157400	1.970.474
134375	1.499.249	14.513	1.500.737	155046	1.970.507	157400P	1.970.474

157500	1.970.429	2 525 684 A	1.915.019 ^N	2 526 131 A	1.970.509	2 591 820	1.231.084
157500	1.970.429	2 525 687 A	1.915.019 ^N	2 526 151 A	1.970.596	2 591 821	1.230.149M
157600	1.970.445	2 525 693 A	1.915.019 ^N	2 526 180 A	1.970.432	2 591 821	1.230.149M
157700	1.970.427	2 525 696 A	1.915.019 ^N	2 526 182 A	1.970.407	2 591 823	1.230.146M
157900	1.970.426	2 525 698 A	1.915.019 ^N	2 526 182 B	1.970.407	2 591 823	1.230.146M
16-14 885 0001	1.970.596	2 525 708 A	1.915.019 ^N	2 526 208	1.970.405	2 591 824	1.130.127
16-14 885 0002	1.970.432	2 525 711 A	1.915.019 ^N	2 528 001	1.965.029	2 591 824	1.130.127
16-14 885 0003	1.970.419	2 525 712 A	1.915.019 ^N	2 528 001 A	1.965.029	2 591 838	1.406.112R
16-14 885 0004	1.970.518	2 525 713 A	1.915.019 ^N	2 528 001 A	1.965.029	2 595 007	1.965.004
16-14 885 0006	1.970.196	2 525 747 A	1.915.019 ^N	2 528 008	1.965.005	2 595 009	1.965.007
16-14 885 0010	1.970.365	2 525 750 A	1.915.019 ^N	2 528 008 A	1.965.005	2 595 013	1.965.020
16-14 885 0015	1.970.613	2 525 753	1.915.019 ^N	2 528 008 A	1.965.005	2 595 016	1.965.036
1650	1.912.010	2 525 755	1.915.019 ^N	2 537 065	1.315.080	2 595 020	1.990.414
1651	1.912.011	2 525 756 A	1.915.019 ^N	2 537 077	1.315.080	2 595 025	1.965.034
17-5607	1.965.005	2 525 765 A	1.915.019 ^N	2 537 260	1.415.104	2 595 041	1.965.052
18.507	1.500.417	2 526 009	1.970.106	2 537 260	1.415.104	2 783 039 001 Z	1.206.068
18.510	1.500.372	2 526 009	1.970.106	2 537 268	1.315.075	2 790 000	1.970.101D
18.511	1.499.064	2 526 009 A	1.970.106	2 553 495	1.315.081	2001	1.965.005
18.515	1.499.061	2 526 015	1.970.102	2 553 499 0	1.415.101	2002	1.965.005
18.516	1.500.417	2 526 015	1.970.102	2 558 654	1.415.096R	2003	1.965.004
18.519	1.500.372	2 526 015 A	1.970.102	2 558 654	1.415.096R	2007	1.965.007
18.524	1.499.059	2 526 017	1.970.101D	2 558 743	1.415.101	202 515	1.500.514
1801	1.499.013	2 526 017	1.970.101D	2 558 743	1.415.101	202 527	1.500.689
18051-3	1.417.052R	2 526 017 0	1.970.101D	2 559 115	1.415.097	202 530	1.500.634
18603	1.317.016	2 526 023	1.970.107	2 559 115	1.415.097	202 531	1.501.531
18603-1	1.317.014	2 526 023	1.970.107	2 590 166	1.215.126 ^P	205 106	1.501.529
18603-3	1.317.014	2 526 023 A	1.970.107	2 590 166	1.215.126 ^P	2053	1.965.025
18603-5	1.317.014	2 526 026	1.970.155	2 590 251	1.142.056	206 242	1.500.688
18603-6	1.317.016	2 526 026 A	1.970.155	2 590 253	1.215.111U	206 636	1.970.140
18603-8	1.317.016	2 526 026 A	1.970.155	2 590 253	1.215.111U	206 638	1.970.272
18603-9	1.317.016	2 526 030	1.970.108	2 590 254	1.215.112U	206 640	1.970.399
18603-11	1.317.014	2 526 034	1.970.228	2 590 254	1.215.112U	206 641	1.970.398
18603-11J	1.317.014	2 526 035 A	1.970.189	2 590 264	1.915.017	206 643	1.970.508
19005212	1.970.399	2 526 035 A	1.970.189	2 590 832	1.970.101D	206.001E	1.970.146
19005267	1.970.487	2 526 037 A	1.970.188	2 590 841	1.213.022HV	206.002	1.970.345
19005293	1.970.475	2 526 037 A	1.970.188	2 590 843	1.217.026	206.002E	1.970.345
19005316	1.970.607	2 526 039	1.970.189	2 590 846	1.230.149	206.004	1.970.108
19005358	1.970.545	2 526 040 A	1.970.188	2 590 862	1.106.196	206.004E	1.970.108
19005358	1.970.545	2 526 040 A	1.970.188	2 590 871	1.106.257	206.009	1.970.168
19005362	1.970.547	2 526 040 A	1.970.188	2 590 874	1.306.081	206.009E	1.970.168
2 207 013 002	1.206.064	2 526 048	1.970.107	2 590 877	1.306.093	206.010	1.970.103
2 207 013 003	1.206.064	2 526 048 A	1.970.107	2 590 878	1.306.094	206001	1.970.146
2 207 013 004	1.206.071	2 526 048 A	1.970.107	2 590 879	1.306.108	206007	1.970.423
2 207 013 005	1.206.071	2 526 049	1.970.140	2 590 880	1.306.109	207 022	1.970.432
2 207 013 007	1.206.064	2 526 049 A	1.970.140	2 590 881	1.306.121	207 466	1.970.450
2 207 110 007	1.206.071	2 526 050	1.970.341	2 590 882	1.306.124	208 333	1.970.547
2 207 330 011	1.106.030	2 526 050 A	1.970.341	2 590 883	1.306.129	208 441	1.970.545
2 207 330 041	1.106.180	2 526 051	1.970.355	2 590 884	1.306.231	208 441	1.970.545
2 207 330 050	1.106.180	2 526 051 A	1.970.355	2 590 886	1.313.093	208.001	1.970.417
2 524 086	1.315.069	2 526 051 A	1.970.355	2 590 889	1.317.016	208.001E	1.970.417
2 524 128	1.315.070	2 526 052	1.970.356	2 590 892	1.331.109	209.002	1.970.272
2 524 132	1.415.097	2 526 052 A	1.970.356	2 590 893	1.328.096	209.002E	1.970.272
2 524 134	1.315.074	2 526 052 A	1.970.356	2 590 893	1.328.096	209.006	1.970.219
2 524 134	1.315.074	2 526 055	1.970.272	2 590 896	1.330.109	209.006E	1.970.219
2 525 551 B	1.915.019 ^N	2 526 055 A	1.970.272	2 590 897	1.406.012R	209.008	1.970.140
2 525 623 D	1.315.086 ^M	2 526 055 A	1.970.272	2 590 898	1.406.023R	209.008E	1.970.140
2 525 626 B	1.915.017 ^N	2 526 055 A	1.970.272	2 590 899	1.406.025R	209.009E	1.970.341
2 525 626 C	1.915.017 ^N	2 526 060	1.970.103	2 590 900	1.406.055R	209.013	1.970.389
2 525 628	1.315.078 ^M	2 526 062	1.970.111	2 590 901	1.406.056R	209.013E	1.970.389
2 525 628	1.315.078 ^M	2 526 063	1.970.109	2 590 902	1.406.059R	20936100	1.970.475
2 525 628 B	1.315.078 ^M	2 526 071	1.970.125	2 590 904	1.406.024R	20936113	1.970.475
2 525 640 B	1.915.017 ^N	2 526 073	1.970.374	2 590 905	1.406.112R	20945031	1.970.475
2 525 640 C	1.915.017 ^N	2 526 073 A	1.970.374	2 590 906	1.406.114R	20945032	1.970.475
2 525 645 A	1.315.083 ^B	2 526 078 A	1.970.365	2 590 907	1.406.116R	21 940 002	1.215.056
2 525 651 A	1.915.019 ^N	2 526 078 B	1.970.365	2 590 908	1.406.121R	21 940 401	1.115.023
2 525 652 A	1.915.019 ^N	2 526 079	1.970.365	2 590 910	1.413.014	21 943 200	1.330.069
2 525 653 A	1.915.019 ^N	2 526 081	1.970.194	2 590 911	1.430.029	21 943 202	1.330.069
2 525 656 A	1.915.019 ^N	2 526 082	1.970.103	2 590 913	1.430.041	21 945 800	1.406.014R
2 525 657 A	1.915.019 ^N	2 526 110	1.970.355	2 590 914	1.430.051R	21.500	1.500.511
2 525 658 A	1.915.019 ^N	2 526 110 A	1.970.355	2 590 915	1.430.054R	210.001	1.970.155
2 525 659 A	1.915.019 ^N	2 526 110 A	1.970.355	2 590 916	1.430.060	210.001E	1.970.155
2 525 660 A	1.915.019 ^N	2 526 111	1.970.356	2 590 917	1.406.060R	210.002	1.970.105
2 525 661 A	1.915.019 ^N	2 526 111 A	1.970.356	2 590 918	1.428.026R	210.002E	1.970.105
2 525 663 A	1.915.019 ^N	2 526 111 A	1.970.356	2 590 935	1.315.077	210.003	1.970.106
2 525 667 A	1.915.019 ^N	2 526 114 A	1.970.376	2 590 935	1.315.077	210.003E	1.970.106
2 525 680	1.915.019 ^N	2 526 115 A	1.970.378	2 590 938	1.915.017	210.004	1.970.188
2 525 680 A	1.915.019 ^N	2 526 116 A	1.970.508	2 590 945	1.915.019	210.004E	1.970.188
2 525 683 A	1.915.017 ^N	2 526 117 A	1.970.403	2 590 945	1.915.019	210.005	1.970.189
2 525 683 B	1.915.017 ^N	2 526 118 A	1.970.408	2 591 820	1.231.084	2102	1.965.036

211.001	1.970.228	245111	1.970.146	245727	1.970.427	2503973	1.970.645
211.001E	1.970.228	245117	1.970.442	245731	1.970.607	2503974	1.970.538
211.002	1.970.196	245119	1.970.192	245733	1.970.458	2504003	1.970.603
211.002E	1.970.196	245122	1.970.228	245736	1.970.457	2504006	1.970.492
211.003	1.970.365	245124	1.970.108	245738	1.970.483	2504010	1.970.466
211.003E	1.970.365	245129	1.970.275	245744	1.970.589	2504033	1.970.599
211.004	1.970.596	245130	1.970.374	245745	1.970.487	2504035	1.970.543
211.004E	1.970.596	245134	1.970.345	245750	1.990.303	2504038	1.970.537
211.005	1.970.376	245138	1.970.196	245757	1.970.612	2504041	1.970.487
211.005E	1.970.376	245139	1.970.532	2458	1.499.244	2504044	1.970.522
211.006	1.970.378	245141	1.970.474	245817	1.970.552	2504045	1.970.495
211.006E	1.970.378	245142	1.970.429	245818	1.970.533	2504048	1.970.547
211.007	1.970.275	245155	1.970.314	245823	1.970.536	2504051	1.970.609
211.007E	1.970.275	245159	1.990.420	2476	1.500.802	2504058	1.970.613
214 800 0001	1.970.146	245160	1.970.135	2476	1.500.802	2504080	1.970.611
214 885 0000	1.970.345	245163	1.970.431	2497	1.500.415	2504081	1.970.614
214 885 0001	1.970.442	245164	1.970.426	25.501	1.501.417	2504083	1.970.497
214 885 0009	1.970.423	245165	1.970.3545	25.503	1.501.417	2504085	1.970.619
214 885 0010	1.970.168	245166	1.970.168	25.504	1.499.004	2504086	1.970.503
214 885 0012	1.970.148	245168	1.970.399	25.507	1.501.413	2504087	1.970.505
214 885 0015	1.970.549	245170	1.970.219	25.509	1.501.434	2504090	1.970.632
214.001E	1.990.420	245174	1.970.459	25.510	1.501.434	2504093	1.970.631
214.002E	1.990.414	245175	1.970.448	25.514	1.499.013	2504094	1.970.626
214001	1.990.420	245178	1.970.461	25.515	1.501.434	2508415	1.990.414
214002	1.990.414	245182	1.970.433	25.516	1.501.413	2508419	1.990.414
215.002	1.970.135	245187	1.970.417	25.518	1.499.013	2508425	1.990.420
215.004	1.970.170	245188	1.970.347	25.519	1.501.417	2508704	1.990.420
215.007E	1.970.532	245189	1.970.170	2503800	1.970.596	2508709	1.970.417
215.009E	1.970.481	245190	1.970.203	2503801	1.970.442	2508712	1.970.419
2150	1.965.020	245193	1.970.532	2503805	1.970.3545	2508713	1.970.518
215007	1.970.532	245195	1.970.518	2503806	1.970.429	2508716	1.970.178
21595273-2	1.970.432	245203	1.970.478	2503807	1.970.474	2508718	1.970.582
21597716-4	1.970.476	245205	1.970.581	2503809	1.970.399	2508727	1.970.423
21597716-4	1.970.476	245207	1.970.387	2503810	1.970.508	2508730	1.970.146
21603121-9	1.970.432	245215	1.970.492	2503812	1.970.431	2508735	1.970.228
21603800-7	1.970.476	245223	1.970.389	2503817	1.970.403	2508736	1.970.275
21603800-7	1.970.476	245228	1.970.233	2503818	1.970.405	2508737	1.970.266
22.509	1.501.711	245245	1.970.394	2503819	1.970.407	2508738	1.970.196
22.511	1.501.888	245249	1.970.480	2503828	1.970.445	2508739	1.970.345
22.517	1.501.914	245250	1.970.557	2503831	1.970.427	2508744	1.970.179
22.518	1.501.889	245252	1.970.496	2503832	1.970.450	2508749	1.970.586
22.523	1.501.719	245253	1.970.489	2503834	1.970.436	2508752	1.970.155
2200	1.965.029	245262	1.970.582	2503835	1.970.427	2508754	1.970.105
22132- 1	1.430.036R	245265	1.970.586	2503836	1.970.426	2508756	1.970.189
22132- 1J	1.430.036R	245270	1.970.179	2503841	1.970.397	2508757	1.970.355
222.002	1.970.214	245271	1.970.198	2503842	1.970.476	2508758	1.970.356
222.002E	1.970.214	245273	1.970.386	2503843	1.970.509	2508759	1.970.376
222.003	1.970.347	245277	1.970.397	2503845	1.970.433	2508760	1.970.188
222.003E	1.970.347	245280	1.970.450	2503846	1.970.461	2508762	1.970.272
222.004	1.970.213	245283	1.970.591	2503847	1.970.434	2508764	1.970.596
222.004E	1.970.213	245286	1.970.538	2503848	1.970.435	2508765	1.970.365
22431- 1	1.430.041	245303	1.970.466	2503852	1.970.480	2508766	1.970.378
22488- 1	1.417.052	245304	1.970.522	2503854	1.970.483	2508769	1.970.423
229.001	1.970.394	245320	1.970.529	2503860	1.970.557	2508780	1.970.140
229.001E	1.970.394	245321	1.970.608	2503861	1.970.387	2508793	1.970.168
229.002E	1.970.496	245324	1.970.507	2503863	1.970.489	2508800	1.970.135
229.009	1.970.582	245344	1.970.296	2503870	1.970.448	2508810	1.970.347
229.009E	1.970.582	245349	1.970.505	2503874	1.970.458	2508812	1.970.214
232.001	1.970.233	245352	1.970.556	2503876	1.970.607	2508856	1.970.579
232.001E	1.970.233	245358	1.970.516	2503879	1.970.507	2508866	1.970.198
23373- 1	1.217.020	245359	1.970.614	2503883	1.970.408	2508868	1.970.203
23373- 2	1.217.020	245360	1.970.611	2503894	1.970.599	2571	1.501.503
23373- 3	1.217.020	245367	1.970.503	2503902	1.970.533	2576 12.70.01	1.965.004
238.002	1.970.589	245372	1.970.632	2503909	1.970.602	2590	1.500.509
238.006	1.970.586	245374	1.970.620	2503910	1.970.529	26.505	1.501.411
238.006E	1.970.586	245375	1.970.619	2503913	1.970.457	26.506	1.501.411
238.007	1.970.581	245378	1.970.425	2503926	1.970.384	26.508	1.501.658
238.007E	1.970.581	245380	1.970.587	2503929	1.970.551	26.512	1.501.411
24.503	1.501.609	245390	1.970.537	2503930	1.970.608	26.513	1.501.658
24.504	1.501.569	2456	1.500.801	2503936	1.970.516	26951960-3	1.970.405
24431- 1	1.430.041	2457	1.499.244	2503939	1.970.514	26951960-3	1.970.405
245	1.500.725	245701	1.970.545	2503941	1.970.536	27.502	1.501.436
245092	1.990.414	245701	1.970.545	2503944	1.970.527	27.503	1.501.436
245098	1.970.408	245703	1.970.112	2503947	1.970.535	28.503	1.501.278
245104	1.970.432	245707	1.970.2855	2503950	1.970.586	28.506	1.501.401
245106	1.970.376	245709	1.970.445	2503962	1.970.620	28.509	1.501.401
245107	1.970.378	245718	1.970.435	2503963	1.970.591	28.514	1.501.401
245108	1.970.508	245720	1.970.436	2503965	1.970.627	28.516	1.501.401
245109	1.970.403	245723	1.970.602	2503971	1.970.536	28.528	1.501.883

28114820	1.970.475	32.513	1.501.760	36 501 003	1.222.056HV	402 61003	1.419.085
28-14 885 0000	1.970.589	32.514	1.501.231	36 501 025	1.222.056HV	402 61103	1.412.093
28-14 885 0003	1.970.614	32.516	1.501.739	36.501	1.501.433	4020	1.306.079
28211913	1.970.609	32493	1.417.052R	36.503	1.501.731	4020	1.500.386
28276583	1.970.620	32493- 1	1.417.052R	36.504	1.501.680	4021	1.306.081
28326927	1.970.545	32493- 1JGI	1.430.054R	36.505	1.501.677	4022	1.306.080
28326927	1.970.545	33.523	1.501.856	36.506	1.501.634	4024	1.306.240
28372862	1.970.475	33.525	1.501.435	36.507	1.501.942	4025	1.306.081
28400714	1.970.626	33.543	1.501.856	36.508	1.501.731	4026	1.306.081
28994- 1	1.417.058	33-14 885 0003	1.970.591	36.509	1.499.007	4027	1.306.092
28994- 1J	1.417.058	335 622	1.965.004	36.510	1.501.730	4029	1.306.231
29.502	1.501.401	33828- 1	1.115.023	36.511	1.501.677	403 51103	1.342.043
29.505	1.499.119	33829- 7	1.315.058	36.512	1.501.680	403 53803	1.342.043
29.506	1.501.385	33830- 1	1.415.091	36.514	1.501.433	403 53803	1.342.043
29.507	1.499.120	339 109	1.965.004	36.520	1.499.249	403 80603	1.306.079
29.508	1.499.119	339 373	1.965.007	36.820	1.499.249	403 80703	1.306.076
29.509	1.501.401	339 700	1.990.414	36-14 885 0005	1.970.557	403 80903	1.330.069
29.510	1.501.401	33924- 2	1.217.024	36-14 885 0007	1.970.489	403 81503	1.319.083
29.511	1.501.385	33924- 2J	1.217.024	36-14 885 0008	1.970.602	403 81603	1.312.066
29.512	1.499.119	33924- 4	1.217.026	36-14 885 0010	1.970.552	403 81803	1.328.078
29.513	1.501.385	33924- 4J	1.217.026	37-14 885 0004	1.970.492	4032	1.306.099
29.519	1.501.385	3414	1.500.511	37-14 885 0008	1.970.543	4035	1.306.093
2995	1.501.505	346001	1.499.059	37-14 885 0009	1.970.581	4-037-0602-0	1.446.016R
2997	1.500.694	346004	1.499.241	37-14 885 0010	1.970.495	4-037-0650-0	1.347.027
3 470 026	1.212.055HVS	346009	1.501.730	37-14 885 0012	1.970.612	4038	1.306.098
3 470 056	1.412.093	346023	1.501.740	37-14 885 0015	1.970.611	4039	1.306.098
3 474 221	1.970.111	346025	1.499.239	37-14 885 0016	1.970.556	4041	1.306.094
3 474 227	1.970.109	346038	1.501.509	38.501	1.501.398	4042	1.306.108
3 474 232	1.970.341	346040	1.499.006	38.504	1.501.851	4044	1.306.090
3 474 282	1.970.341	346065	1.501.739	400 01503	1.242.054	4047	1.306.123
3 479 003	1.312.066	346076	1.501.732	400 01503	1.242.054	4049	1.306.124
3 486 037	1.412.095R	346080	1.501.883	400 10103	1.215.056	4050	1.306.231
3 489 003	1.312.066	346090	1.501.507	400 10603	1.206.034HVS	4051	1.306.094
300 065	1.970.169	346094	1.499.252	400 10703	1.206.040	4052	1.306.117
30-14 885 0002	1.970.203	346134	1.500.846	400 10803	1.230.132	4053	1.306.233
30-14 885 0004	1.970.461	346135	1.500.780	400 10903	1.230.140	4054	1.306.234
30-14 885 0005	1.970.459	346139	1.500.688	400 11003	1.230.139	4055	1.306.127
30-14 885 0006	1.970.458	346156	1.501.503	400 11103	1.230.120	4056	1.306.235
30-14 885 0010	1.970.466	346167	1.501.511	400 11203	1.219.043HV	4057	1.306.241
30-14 885 0011	1.970.536	346186	1.501.504	400 11303	1.219.044HV	4058	1.306.231
30-14 885 0014	1.970.537	346204	1.500.509	400 11403	1.212.055HVS	4058	1.501.507
302 104	1.970.532	346244	1.499.244	400 11703	1.206.049HVS	4059	1.306.129
302 444	1.970.481	346248	1.501.505	400 11903	1.228.083MHV	4060	1.306.238
302 726	1.970.480	346267	1.501.436	400 12003	1.230.142	4060	1.501.415
3-037-0602-0	1.446.014R	346285	1.501.446	400 12403	1.213.011HV	4061	1.500.815
304 321	1.970.423	346299	1.501.025	400 12603	1.222.056HV	4063	1.306.256
304 553	1.970.478	346316	1.501.753	400 12603	1.222.056HV	4064	1.306.251
305 126	1.970.619	346326	1.499.061	400 20903	1.217.024	4065	1.306.257
30766- 1	1.317.023	346340	1.501.634	400 21203	1.228.089	4066	1.306.258
30766- 1J	1.317.023	346354	1.499.235	400 876	1.970.178	4067	1.306.249
30922038	1.970.474	346355	1.501.731	4002	1.306.062	4068	1.306.094
30927470	1.970.429	346404	1.500.689	4002	1.501.373	4069	1.306.253
31.502	1.501.711	346405	1.500.634	4003	1.306.072	4071	1.306.248
31.505	1.501.686	346418	1.501.209	4004	1.306.072	4072	1.306.247
31.506	1.501.686	346451	1.501.278	4004	1.500.386	4074	1.306.236
31.507	1.501.709	346452	1.501.856	4005	1.306.076	4077	1.306.094
310 481	1.990.416	346481	1.499.120	4005	1.501.373	408 395	1.970.487
311 354	1.990.414	346524	1.500.716	4006	1.500.511	4081	1.500.347
311 740	1.990.420	346558	1.501.880	4008	1.500.511	4086	1.306.112
31-14 885 0002	1.970.457	346574	1.500.597	401 465	1.970.417	4088	1.306.237
31-14 885 0003	1.970.214	346577	1.500.605	4013	1.306.260	4089	1.306.263
31-14 885 0005	1.970.529	346594	1.500.608	40-14 885 0000	1.970.403	409 10015	1.215.056
31-14 885 0006	1.970.608	346595	1.501.745	40-14 885 0001	1.970.155	40928108	1.970.450
31-14 885 0007	1.970.522	346598	1.501.711	40-14 885 0002	1.970.405	41.500	1.500.511
311886	1.965.074	346651	1.500.780	40-14 885 0005	1.970.188	4100	1.500.965
314 139 0000	1.970.162S	346656	1.501.889	40-14 885 0006	1.970.189	4102	1.500.725
314 885 0006	1.970.607	346670	1.500.514	40-14 885 0008	1.970.476	4113	1.500.736
314 885 0009	1.970.632	346675	1.501.411	40-14 885 0011	1.970.620	4120	1.501.415
318 738	1.965.004	346676	1.499.223	40-14 885 0012	1.970.609	413 80403	1.330.090
3186	1.201.006	346679	1.501.643	4015	1.501.634	413 80603	1.330.104
32.502	1.501.745	346681	1.499.007	4016	1.306.076	413 80803	1.317.023
32.503	1.501.398	346691	1.501.681	4018	1.306.079	413 80903	1.330.098
32.504	1.501.231	346692	1.499.230	402 05203	1.242.054	413 81103	1.312.073
32.505	1.500.884	346694	1.499.246	402 60003	1.415.091	414 50303	1.406.026R
32.506	1.501.639	346698	1.501.451	402 60303	1.406.014R	414 50503	1.430.042R
32.507	1.501.231	35.502	1.501.835	402 60403	1.406.021R	414 50803	1.430.047R
32.508	1.501.760	35.507	1.501.835	402 60503	1.406.012R	414 50903	1.412.096
32.509	1.501.760	35-14 885 0002	1.970.516	402 60703	1.430.037	414 51003	1.417.058
32.512	1.501.398	35-14 885 0004	1.970.514	402 60903	1.428.012	414 51103	1.430.055R

4148	1.501.630	4334	1.501.025	4654	1.330.114	48147	1.970.607
4149	1.501.007	4384	1.322.003	4656	1.330.115	48149	1.970.387
4150	1.500.864	4385	1.322.088	4664	1.331.003/00	48158	1.970.233
4153	1.500.616	4391	1.322.003	4668	1.331.003/00	48162	1.970.489
4158	1.500.616	4392	1.322.011	4673	1.331.118	48165	1.970.437
4159	1.500.888	4393	1.322.057	4677	1.331.121	48170	1.970.496
4162	1.501.363	4396	1.322.040	4678	1.331.131	48176	1.970.394
4163	1.501.506	43J83-17001	1.322.048	4713	1.338.242	48179	1.970.457
4167	1.500.884	43S85-16001	1.422.073	4767	1.342.043	48183	1.970.591
4168	1.501.503	43S85-17001	1.322.041	48000	1.990.414	48184	1.970.466
4169	1.500.573	43S86-16001	1.422.073	48001	1.970.532	48188	1.970.2855
4173	1.501.585	4402	1.322.022	48002	1.970.432	48201	1.970.602
4176	1.501.639	4404	1.500.839	48003	1.970.474	48202	1.970.266
4177	1.500.700	4405	1.500.543	48004	1.970.450	48206	1.970.475
4178	1.501.624	4407	1.322.048	48005	1.970.429	48216	1.970.475
4193	1.501.568	4408	1.322.041	48006	1.970.399	4823	1.347.027
4194	1.501.568	441 19102	1.970.101D	48007	1.970.419	48239	1.970.543
42.513	1.501.345	4417	1.322.069	48008	1.970.3545	48245	1.970.495
4201	1.312.066	44229	1.501.345	48010	1.990.420	48257	1.970.538
4204	1.312.075	44248	1.499.049	48011	1.970.508	48266	1.970.522
4205	1.501.575	44263	1.501.209	48013	1.970.146	48269	1.970.537
4206	1.501.504	44265	1.501.411	48014	1.970.407	48274	1.970.492
4207	1.501.575	44278	1.499.246	48015	1.970.431	48278	1.970.458
4221	1.312.073	44317	1.499.251	48019	1.970.376	48287	1.970.586
4222	1.312.074	44330	1.499.230	48020	1.970.378	48290	1.970.589
4272	1.313.099	44331	1.499.007	48021	1.970.135	48292	1.970.529
4274	1.313.093	44334	1.499.236	48023	1.970.403	48293	1.970.608
4276	1.313.094	44337	1.501.385	48024	1.970.417	48306	1.970.194
4277	1.313.117	44338	1.499.229	48025	1.970.168	48308	1.970.126
4279	1.313.092	44341	1.499.249	48028	1.970.275	48337	1.970.487
4284	1.313.102	44344	1.500.605	48030	1.970.188	48339	1.970.180
4286	1.313.107	4451	1.313.123	48032	1.970.408	48340	1.970.169
4290	1.313.262	4456	1.313.119	48033	1.970.475	48341	1.970.132
4291	1.313.113	4458	1.322.063	48035	1.970.435	48342	1.970.101D
4293	1.313.122	4461-13301	1.222.056HV	48040	1.970.436	48344	1.970.127
4295	1.313.240	4461-1700	1.322.003	48041	1.970.427	48346	1.970.192
4298	1.313.254	4461-2700 B	1.322.003	48042	1.970.426	48348	1.970.533
430 00103	1.142.056	4461-3330 A	1.222.056HV	48052	1.970.345	48363	1.970.202
430 01203	1.142.056	4461-3330 AY	1.222.056HV	48054	1.970.214	48395	1.970.536
430 01303	1.142.056	4461-4330 AY	1.222.056HV	48056	1.970.272	48397	1.970.551
430 01403	1.142.056	4486	1.500.539	48057	1.970.140	48404	1.970.547
430 02303	1.142.056	44A2-13301	1.222.056HV	48058	1.970.356	48408	1.970.599
430 02403	1.142.056	44A2-16001	1.422.052	48059	1.970.374	48410	1.970.613
430 02473	1.142.056	44A5-13301	1.222.056HV	48060	1.970.196	48682	1.970.296
430 21203	1.142.056	44AZ-13301	1.222.056HV	48061	1.970.442	49052	1.970.556
430 40603	1.106.212	44P88-16001	1.422.093	48062	1.970.105	49054	1.970.614
430 41003	1.130.117	44P88-17001	1.322.075	48063	1.970.480	49055	1.970.611
430 50803	1.115.023	44R80-17001	1.322.057	48064	1.970.108	49061	1.970.632
430 90703	1.117.097	44R84-16002	1.422.052	48065	1.970.434	49062	1.970.619
430 90903	1.130.127	44R86-16001	1.422.073	48066	1.970.155	49068	1.970.516
4301	1.315.049	44S88-17001	1.322.046	48067	1.970.189	49069	1.970.527
4302	1.315.041	45.501	1.501.643	48068	1.970.355	49073	1.970.603
4303	1.315.058	4502	1.319.083	48071	1.970.476	49086	1.970.423
4303	1.500.747	4519	1.328.075	48072	1.970.509	49097	1.970.609
4304	1.315.058	4525	1.328.078	48078	1.970.365	49099	1.970.631
4304	1.500.491	4526	1.328.083	48079	1.970.170	49100	1.970.620
4305	1.315.062	4533	1.328.085	48082	1.970.445	49133	1.970.549
4306	1.315.065	4536	1.319.092	48088	1.970.433	50 001	1.206.047
4309	1.315.059	4537	1.328.094	48094	1.970.198	50 002	1.206.029HV
4310	1.500.748	4538	1.319.093	48098	1.970.213	50 002 V	1.206.029HV
4315	1.315.054	4540	1.328.091	48099	1.970.215	50 004	1.206.021
4316	1.315.058	4541	1.328.099	48103	1.970.386	50 012	1.206.032HV
4318	1.315.059	4542	1.328.100	48104	1.970.397	50 012 V	1.206.032HV
4319	1.315.062	4623	1.330.111	48105	1.970.203	50 014	1.206.034HVS
4320	1.315.059	4624	1.330.069	48107	1.970.461	50 014 S	1.206.034HVS
4321	1.315.067	4627	1.330.081	48108	1.970.518	50 014 V	1.206.034HVS
4322	1.315.065	4631	1.347.025	48111	1.970.347	50 016	1.206.049HVS
4323	1.315.074	4632	1.330.086	48115	1.970.178	50 016 S	1.206.049HVS
4324	1.315.068	4634	1.330.082	48121	1.970.148	50 016 V	1.206.049HVS
4325	1.315.067	4637	1.330.076	48123	1.970.228	50 017	1.206.040
4326	1.315.075	4638	1.330.090	48124	1.970.483	50 020	1.206.034HVS
4328	1.315.072	4640	1.330.101	48127	1.970.448	50 021	1.206.034HVS
4329	1.315.069	4641	1.317.023	48129	1.970.219	50 026	1.206.029HV
4330	1.315.070	4643	1.330.101	48132	1.970.106	50 027	1.206.049HVS
4331	1.315.080	4646	1.330.093	48135	1.970.507	50 029	1.206.034HVS
4331	1.500.674	4647	1.307.701	48136	1.970.384	50 029 S	1.206.034HVS
4332	1.315.081	4649	1.330.098	48139	1.970.557	50 029 V	1.206.034HVS
4333	1.315.079	4652	1.330.109	48140	1.970.478	50 030	1.206.049HVS
4333	1.500.494	4653	1.317.016	48145	1.970.389	50 030 S	1.206.049HVS

50 031	1.206.034HVS	52 039	1.215.105	54 403 235	1.328.098	5641	1.430.047R
50 032	1.206.049HVS	52 043	1.215.111U	54 403 806	1.328.094	5645	1.430.055R
50 033	1.206.062	52 044	1.215.112U	54 403 880	1.328.093	5651	1.430.051R
50 039	1.206.034HVS	52 045	1.215.076	54 403 899	1.428.025	5652	1.430.060
50 039 S	1.206.034HVS	52 048	1.215.106	54 404 052	1.428.026R	5663	1.431.023
50 040	1.206.062	52 050	1.215.122	54 404 224	1.428.024R	5665	1.431.023
50 045	1.206.034HVS	52 052	1.215.126	54 404 506	1.328.096	5672	1.431.113
50 047	1.206.062	52 053	1.215.127	54 404 778	1.428.027R	5673	1.431.110
50 048	1.206.049HVS	5200	1.412.093	54 405 507	1.428.026R	5676	1.431.119
50 050	1.206.049HVS	5201	1.412.093R	54 405 729	1.428.028R	57 006	1.242.054
500 959	1.970.475	5202	1.412.095R	54 405 782	1.328.099	5723	1.406.014R
500 961	1.970.162S	5203	1.412.098	54 405 821	1.928.202^N	5724	1.406.014R
5011	1.406.012R	5212	1.412.090	54 406 537	1.328.100	581700540000	1.990.303
5012	1.406.018R	5213	1.412.096	54 407 831	1.328.104	581700540010	1.990.303
5015	1.406.012R	5215	1.412.097	54 408 133	1.328.105	581701070000	1.965.020
502 143	1.970.607	5216	1.412.100	54 408 776	1.328.106	5823	1.446.016R
5020	1.406.014R	5247098	1.407.701R	54 413 568	1.228.083MHV	5DA 006 623-951	1.990.414
5021	1.406.014R	5247810	1.207.701	54 414 513	1.328.070	5DA 193 175-061	1.970.314
5022	1.406.055R	5248175	1.306.079	54 414 514	1.328.075	5DA 193 175-331	1.970.450
5023	1.406.121R	5267	1.413.028	54 417 214	1.328.075	5DA 193 175-341	1.970.146
5026	1.406.018R	5270	1.413.014	54 418 661	1.328.091	5DA 193 175-391	1.970.596
5027	1.406.021R	5271	1.413.014	54 419 082	1.428.014	5DA 193 175-401	1.970.135
5028	1.406.021R	5277	1.413.027	54 419 946	1.228.083MHV	5DA 193 175-411	1.970.532
5029	1.406.024R	5283	1.413.029	54 420 877	1.419.085	5DA 193 175-421	1.970.188
5030	1.406.023R	5284	1.413.030	54 420 889	1.319.083	5DA 193 175-431	1.970.403
5032	1.407.701R	5285	1.422.082	54 420 904	1.412.090	5DA 193 175-441	1.970.405
5033	1.406.026R	53 003	1.230.120	54 421 149	1.428.014	5DA 193 175-481	1.970.543
5034	1.406.025R	53 003 V	1.230.120	54 422 043	1.428.014	5DA 193 175-491	1.970.607
5036	1.406.056R	53 006	1.230.123	54 422 044	1.428.014	5DA 193 175-501	1.970.474
5037	1.406.061R	53 007	1.230.127	54 422 803	1.428.012	5DA 193 175-511	1.970.495
5039	1.406.070R	53 009	1.230.132	54 423 546	1.328.078	5DA 193 175-591	1.970.433
5040	1.406.027R	53 009 V	1.230.132	54 424 762	1.428.022	5DA 193 175-681	1.970.557
5041	1.406.067R	53 010	1.230.139	54 427 109	1.328.078	5DA 193 175-691	1.970.168
5047	1.406.034R	53 010 V	1.230.139	54 527 109	1.328.078	5DA 193 175-701	1.970.436
5050	1.406.115R	53 011	1.230.140	54 987 086	1.965.036	5DA 193 175-711	1.970.607
5055	1.406.116R	53 011 V	1.230.140	5400	1.422.069	5DA 193 175-731	1.970.407
5056	1.406.060R	53 013	1.230.142	5402	1.422.066	5DA 193 175-741	1.970.384
5060	1.406.112R	53 013 V	1.230.142	5403	1.422.081	5DA 193 175-761	1.970.442
5062	1.406.059R	53 014	1.246.071	5406	1.422.094	5DA 193 175-781	1.970.480
5065	1.406.115R	53 014 V	1.246.071	5407	1.501.363	5DA 193 175-791	1.970.481
5069	1.406.067R	53 019	1.217.024	55 005	1.228.083MHV	5DA 193 175-801	1.970.478
5070	1.406.117R	53 021	1.207.701	55 005 V	1.228.083MHV	5DA 193 175-821	1.970.419
5071	1.406.115R	53 023	1.217.026	55 006 V	1.219.043HV	5DA 193 175-831	1.970.518
5073	1.406.112R	5301	1.415.091	55 007 V	1.219.044HV	5DA 193 175-881	1.970.275
5074	1.406.049R	5302	1.415.081	55 008	1.228.083MHV	5DA 193 175-901	1.970.431
5075	1.406.112R	5304	1.415.083R	55 008 V	1.228.083MHV	5DA 193 175-911	1.970.429
5075	1.501.411	5307	1.415.088	55 013 V	1.228.089	5DA 193 175-921	1.970.426
5078	1.406.112R	5311	1.415.088	5501	1.428.006	5DA 193 175-931	1.970.459
5080	1.406.117R	5312	1.415.088R	5502	1.419.085	5DA 193 175-951	1.970.599
5081	1.406.127R	5313	1.415.089R	5505	1.428.012	5DA 193 175-961	1.970.612
5087	1.406.114R	5315	1.415.091	5506	1.428.021	5DA 193 175-971	1.970.614
5088	1.406.117R	5316	1.415.091	5509	1.428.029R	5DA 193 175-981	1.970.445
5092	1.406.119R	5317	1.415.094	5517	1.428.007	5DA 193 175-991	1.970.417
50926869	1.970.532	5318	1.415.094	5527	1.428.024R	5DA 230 035-041	1.970.228
5093	1.406.122R	5320	1.415.097	5529	1.428.026R	5DA 230 035-561	1.970.466
50936999	1.970.532	5321	1.415.099R	5530	1.428.025	5DA 230 035-731	1.970.429
5094	1.406.118R	5322	1.415.104	5531	1.419.092	5DA 230 035-781	1.970.433
51 003	1.212.055HVS	5323	1.415.101	5532	1.428.028R	5DA 230 035-861	1.970.436
51 003 S	1.212.055HVS	5355	1.501.880	56 009	1.236.045	5DA 230 035-901	1.970.458
51 003 V	1.212.055HVS	5361	1.501.856	561 811 68	1.130.117	5DA 230 036-001	1.970.425
5101	1.406.140R	5385	1.422.052	561 811 76	1.130.117	5DA 230 036-101	1.970.552
5101	1.501.562	5388	1.422.056	561 811 82	1.130.127	5DA 230 036-191	1.970.522
5108	1.406.125R	5397	1.422.073	561 811 83	1.130.128	5DA 230 036-311	1.970.556
5112	1.406.148R	54 002	1.213.011HV	561 812 02	1.130.117	5DA 230 036-371	1.970.603
5113	1.406.147R	54 002 V	1.213.011HV	561 812 03	1.130.117	5DA 230 036-511	1.970.611
5114	1.406.149R	54 006	1.222.056HV	5618	1.430.029	5DA 230 036-521	1.970.516
514 885 0002	1.970.448	54 006 V	1.222.056HV	5619	1.430.055R	5DA 230 036-541	1.970.551
514 885 0006	1.970.478	54 014	1.231.084	5622	1.430.059	5DA 230 036-611	1.970.527
52 004	1.215.055	54 020	1.213.022HV	5623	1.430.060	5DA 230 036-661	1.970.623
52 006	1.215.056	54 026	1.231.084	5628	1.430.037	5DA 358 000-001	1.970.435
52 006 V	1.215.056	54 400 071	1.228.089	5629	1.430.054R	5DA 358 000-011	1.970.170
52 007	1.215.061	54 401 050	1.428.022	5633	1.430.036R	5DA 358 000-041	1.970.508
52 007 V	1.215.061	54 401 291	1.328.083	5634	1.430.036R	5DA 358 000-051	1.970.354S
52 013	1.215.064	54 401 627	1.328.085	5635	1.430.042R	5DA 358 000-061	1.970.228
52 014	1.215.111U	54 402 059	1.328.078	5636	1.430.042R	5DA 358 000-071	1.970.448
52 016	1.215.067	54 402 069	1.328.091	5637	1.430.041	5DA 358 000-091	1.970.529
52 025	1.215.086	54 402 212	1.328.091	5638	1.430.042R	5DA 358 000-131	1.970.603
52 037	1.215.102	54 402 221	1.228.089	5639	1.446.014R	5DA 358 000-141	1.970.214
52 038	1.215.103	54 402 689	1.428.021	5640	1.417.058	5DA 358 000-171	1.990.420

5DA 358 000-251	1.970.365	607 054 09	1.970.228	701 184 01	1.230.123	712 934 02	1.230.148M
5DA 358 000-271	1.970.423	607 056 01	1.970.102	701 403	1.970.403	7121	1.500.612
5DA 358 000-291	1.970.272	607 056 04	1.970.108	701 724	1.970.489	713 027 01	1.330.109
5DA 358 000-311	1.970.483	607 056 06	1.970.158	701 857	1.970.613	713 053 01	1.430.060
5DA 358 000-331	1.970.507	607 057 01	1.970.106	701 895 01	1.430.029	713 198 01	1.930.161/1
5DA 358 000-341	1.970.547	607 057 38	1.970.106	701 918	1.970.552	713 198 04	1.930.163/1
5DA 358 000-371	1.970.425	607 080 38	1.970.146	703 880 03	1.430.041	713 269 01	1.930.177/1
5DA 358 000-381	1.970.466	607 081 38	1.970.275	705 197 01	1.230.127	713 277 01	1.930.180M
5DA 358 000-411	1.970.432	607 081 54	1.970.276	710 067 01	1.230.120	713 284 01	1.930.176M
5DA 358 000-461	1.970.536	607 120 02	1.970.101D	710 070 01	1.230.123	713 473 01	1.930.176M
5DA 358 000-471	1.970.475	60921666	1.970.432	710 595 01	1.230.127	713 474 01	1.930.180M
5DA 358 000-491	1.970.345	610 453 24	1.930.177/1^{FN}	710 596 01	1.230.127	713 491 01	1.930.176M
5DA 358 000-571	1.970.496	610 800 24	1.930.161/1^{FN}	710 613 03	1.330.081	713 524 01	1.430.058
5DA 358 000-581	1.970.518	6100	1.106.196	710 615 01	1.430.036R	713 528 01	1.330.110
5DA 358 000-631	1.970.427	6102	1.106.195	710 638 01	1.330.069	713 584 01	1.330.111
5DA 358 000-651	1.970.489	6102	1.501.711	710 640 01	1.430.037	713 667 01	1.330.101
5DA 358 000-661	1.970.591	611 100 41	1.930.176M^{FN}	710 640 02	1.430.037	713 667 02	1.330.101
5DA 358 000-671	1.970.487	611 100 55	1.930.176M^{FN}	710 650 01	1.230.132	713 668 01	1.330.098
5DA 358 000-711	1.990.414	611 100 62	1.930.176M^{FN}	710 851 01	1.330.076	713 668 02	1.330.098
5DA 358 000-831	1.970.108	611 100 66	1.930.176M^{FN}	710 861 01	1.430.037R	713 713 01	1.430.060
5DA 358 000-841	1.970.155	611 100 76	1.930.176M^{FN}	710 930 01	1.430.037R	713 756 01	1.330.116
5DA 358 000-861	1.970.341	611 101 03	1.930.180M^{FN}	710 930 02	1.430.037R	713 774 02	1.430.057R
5DA 358 000-871	1.970.399	611 101 26	1.930.180M^{FN}	710 930 03	1.430.054R	71351702	1.430.059
5DA 358 000-891	1.970.408	6115	1.106.212	7103	1.500.623	71374201	1.330.116
5DA 358 000-911	1.970.178	6128	1.106.257	7109	1.501.343	71376201	1.330.098
5DA 358 000-931	1.970.434	614 885 0003	1.970.272	711 016 07	1.430.051R	714 885 0001	1.970.481
5DA 358 000-991	1.970.522	614 885 0004	1.970.508	711 116 01	1.230.139	714 885 0002	1.970.480
5DA 358 057-021	1.970.516	614 885 0006	1.970.399	711 116 02	1.230.139	714 885 0005	1.970.135
5DA 358 057-131	1.970.198	614 885 0007	1.970.450	711 116 03	1.230.139	714 885 0011	1.970.532
5DA 358 057-231	1.970.608	614 885 0017	1.970.507	711 185 01	1.230.140	714 885 0013	1.970.619
5DA 358 057-261	1.970.437	614 885 0022	1.970.547	711 195 01	1.430.036R	714 885 0014	1.970.623
5DA 358 057-321	1.970.611	6209	1.499.239	711 195 02	1.430.036R	7151	1.501.760
5DA 358 057-381	1.970.602	623 901	1.970.632	711 195 03	1.430.042R	7155	1.501.654
5DA 358 057-401	1.970.537	623 903	1.970.516	711 195 04	1.430.036R	7171	1.500.888
5DA 358 057-441	1.970.556	623 904	1.970.614	711 195 05	1.430.042R	7171	1.501.278
5DA 358 057-451	1.970.538	623 905	1.970.459	711 214 01	1.430.037	7172	1.501.401
5DA 358 057-481	1.970.514	623 906	1.970.345	711 215 01	1.430.037R	7175	1.501.446
5DA 358 057-491	1.970.492	623 907	1.970.537	711 215 02	1.430.037R	718 097 01	1.230.126
5DA 358 057-541	1.970.497	623 908	1.970.536	711 275 01	1.330.081	718 098 01	1.230.096
5DA 358 057-591	1.970.627	6257	1.501.529	711 290 01	1.330.082	720 311	1.970.155
5DA 358 057-601	1.970.527	6258	1.501.730	711 299 01	1.430.036R	720 313	1.970.188
5DA 358 057-661	1.970.551	62937080	1.970.408	711 323 01	1.430.037	7200	1.499.244
5DA 358 057-691	1.970.533	6301	1.499.241	711 424 01	1.430.036R	7201	1.500.716
5DA 358 057-811	1.970.505	6302	1.499.236	711 424 02	1.430.042R	7209	1.501.504
5DA 358 057-821	1.970.611	6303	1.115.023	711 476 01	1.230.143	721 404	1.970.408
5DA 358 057-921	1.970.631	6304	1.115.023	711 539 01	1.430.037R	721 501	1.500.780
5DA 358 057-931	1.970.609	6304	1.499.059	711 711 01	1.330.086	721 906	1.970.407
5DA 358 057-941	1.970.589	6305	1.115.023	711 713 01	1.430.040	721 907	1.970.476
5DA 358 168-041	1.970.632	6308	1.115.034	711 743 01	1.330.090	7210	1.501.686
5DA 358 168-131	1.970.503	6310	1.115.034	711 975 01	1.230.142	722 637	1.970.483
5DA 358 168-181	1.970.549	6311	1.115.034	711 975 02	1.230.142	723 459	1.970.497
5DA 358 168-341	1.970.622	6317	1.115.039	711 980 01	1.230.139	7237	1.501.278
5DA 358 168-391	1.970.626	6431	1.500.372	711 985 01	1.230.140	7240	1.500.768
5DA 749 475-101	1.970.355	6462	1.499.061	711 985 02	1.230.132	7246	1.500.493
5DA 749 475-131	1.970.397	6467	1.500.372	711.005.300	1.201.006	7247	1.500.725
5DA 749 475-261	1.970.386	6468	1.499.064	711.101.300	1.201.005	7251	1.500.808
5DA 749 475-601	1.970.476	6469	1.499.064	7116	1.500.432	7255	1.500.386
5DA 749 475-661	1.970.532	648 250 72	1.990.303	7119	1.500.612	7260	1.500.398
5DA 749 475-781	1.970.432	648 330 20	1.965.005	712 155 01	1.330.093	7262	1.500.429
5DA 749 475-851	1.970.475	648 330 40	1.965.020	712 160 01	1.930.161/1	7263	1.501.305
5DA 749 475-891	1.970.461	6522	1.501.138	712 160 03	1.930.163/1	7264	1.500.398
5DA 749 475-901	1.970.466	6625	1.130.117	712 279 01	1.430.042R	7266	1.500.692
5WK 6105	1.965.004	6626	1.117.097	712 372 01	1.430.047R	7267	1.500.471
5WK 90611	1.970.272	6628	1.130.117	712 372 02	1.430.057R	7270	1.500.815
5WK 9397	1.970.545	6629	1.130.128	712 378 01	1.430.047R	7272	1.500.386
5WK 9397	1.970.545	6630	1.130.127	712 437 01	1.330.098	7273	1.500.650
5WK9 3171	1.970.508	6764	1.142.056	712 437 02	1.330.098	7274	1.500.471
60 410 049	1.219.044HV	6794	1.501.681	712 437 04	1.330.098	7275	1.500.507
60 410 050	1.219.043HV	6812	1.500.608	712 437 05	1.330.098	7275	1.500.674
600 567	1.970.466	6980	1.500.507	712 461 04	1.330.101	7276	1.500.471
600 630	1.970.146	7 350 260 2	1.965.029	712 461 05	1.330.101	7282	1.500.354
600 650	1.970.461	7 350 370 2	1.965.005	712 461 06	1.330.101	7285	1.500.808
6005	1.106.030	7 350 370 2	1.965.005	712 461 07	1.330.104	7285	1.501.025
6020	1.499.006	700 055 01	1.330.059	712 462 03	1.330.101	7287	1.500.386
6022	1.501.509	700 121	1.970.196	712 478 02	1.230.146M	7296	1.500.386
606 900 03	1.970.101D	700 123	1.970.596	712 753 01	1.430.055R	7297	1.500.354
607 029 02	1.970.103	700 221	1.970.365	712 779 02	1.230.146M	735 02 602	1.965.029
607 029 03	1.970.103	700 471	1.970.419	712 779 03	1.230.146M	735 03 702	1.965.005
607 054 04	1.970.148	701 049	1.970.518	712 779 05	1.230.149M	7371	1.500.780

7401	1.970.101D	85.30091	1.970.135	85.30255A2	1.970.478	85.30644A2	1.970.645
7412	1.499.111	85.30092	1.970.140	85.30256	1.970.426	8530133	1.970.475
7414	1.501.401	85.30093	1.970.105	85.30256A2	1.970.426	8530154	1.970.475
7418	1.501.619	85.30095	1.970.189	85.30262	1.970.198	8530164	1.970.432
7419	1.501.984	85.30096	1.970.188	85.30267	1.970.591	8530165	1.970.474
7420	1.501.492	85.30097	1.970.168	85.30268	1.970.450	8530171	1.970.429
7421	1.501.585	85.30097A2	1.970.168	85.30268A2	1.970.450	8530184	1.970.408
7700	1.501.753	85.30106	1.990.414	85.30277	1.970.389	8530249	1.970.475
7801100	1.970.432	85.30109	1.970.399	85.30278	1.970.495	8530251	1.970.475
7802200	1.970.459	85.30109A2	1.970.399	85.30284	1.970.296	8530268	1.970.450
7802207	1.970.461	85.30110	1.970.435	85.30285	1.970.203	8530302	1.970.532
7803300	1.970.532	85.30117	1.970.192	85.30286	1.970.266	8530304	1.970.461
78100	1.970.432	85.30119	1.970.496	85.30302	1.970.532	8610	1.501.711
78207	1.970.461	85.30121	1.970.214	85.30303	1.970.483	8655	1.501.699
78300	1.970.532	85.30123	1.970.272	85.30303A2	1.970.483	8735	1.501.278
8 204 45	1.412.090	85.30123A2	1.970.272	85.30304	1.970.461	8839	1.501.740
8010300	1.970.432	85.30126	1.970.355	85.30305	1.970.466	9 011 4106	1.106.212
8010318	1.970.532	85.30127	1.970.356	85.30306	1.970.543	9 220 332 702	1.970.101D
8010328	1.970.429	85.30127A2	1.970.356	85.30306A2	1.970.543	9 230 087 016	1.906.153^{HN}
8010351	1.970.475	85.30128	1.970.374	85.30308	1.970.458	9 230 087 019	1.906.153^{HN}
8010391	1.970.408	85.30133	1.970.475	85.30308A2	1.970.458	9 230 087 030	1.906.153^{HN}
8010444	1.970.461	85.30135	1.970.480	85.30310A2	1.970.549	9 230 087 036	1.906.153^{HN}
8010478	1.970.474	85.30135A2	1.970.480	85.30320	1.970.397	9 230 087 038	1.906.153^{HN}
8010480	1.970.450	85.30144	1.970.419	85.30341	1.970.202	9 230 087 039	1.906.153^{HN}
8010530	1.970.475	85.30144A2	1.970.419	85.30343	1.970.529	9 230 087 044	1.906.153^{HN}
8010551	1.970.408	85.30145	1.970.445	85.30344	1.970.608	9 230 087 046	1.906.153^{HN}
8010564	1.970.475	85.30145A2	1.970.445	85.30349	1.970.2855	9 230 087 056	1.906.153^{HN}
8010628	1.970.532	85.30149	1.970.314	85.30349A2	1.970.2855	9 230 087 062	1.906.153^{HN}
8101	1.501.677	85.30154	1.970.475	85.30351	1.970.265	9 230 087 065	1.906.153^{HN}
8106	1.499.120	85.30160	1.970.448	85.30352	1.970.322	9 231 064 336	1.406.131
81932056	1.970.461	85.30160A2	1.970.448	85.30355A2	1.970.457	9 231 064 346	1.406.131
820 768	1.970.581	85.30161	1.970.489	85.30360	1.970.556	9 231 065 501	1.306.112
820 773	1.970.586	85.30161A2	1.970.489	85.30366	1.970.599	9 231 065 502	1.306.072
820 774	1.970.585	85.30164	1.970.432	85.30373	1.970.487	9 231 065 503	1.306.072
820 780	1.970.496	85.30164A2	1.970.432	85.30373A2	1.970.487	9 231 065 504	1.306.072
8208	1.500.615	85.30165	1.970.474	85.30386	1.970.538	9 231 065 506	1.306.112
821 429	1.970.495	85.30168	1.970.427	85.30392	1.970.492	9 231 065 516	1.306.112
821 495	1.970.556	85.30168A2	1.970.427	85.30405	1.970.547	9 231 065 529	1.306.244
821 669	1.970.543	85.30171	1.970.429	85.30405AS	1.970.547	9 231 067 027	1.206.034HVS
821 670	1.970.611	85.30171A2	1.970.429	85.30408	1.970.536	9 231 081 319	1.306.098
821 719	1.970.612	85.30175	1.970.387	85.30412	1.970.614	9 231 081 413	1.306.098
8275	1.501.731	85.30176	1.970.397	85.30412A2	1.970.614	9 231 081 628	1.406.045R
8300	1.499.120	85.30180A2	1.970.518	85.30413	1.970.611	9 231 081 678	1.306.098
8458	1.501.531	85.30182	1.970.403	85.30421	1.970.533	9 231 086 370	1.306.094
8471	1.500.674	85.30182A2	1.970.403	85.30423	1.970.552	9 231 087 552	1.906.160
8474	1.501.702	85.30183A2	1.970.384	85.30425	1.970.505	9 231 087 677	1.406.121R
8480	1.500.494	85.30184	1.970.408	85.30426	1.970.497	9 231 140 245	1.306.079
8492	1.499.061	85.30184A2	1.970.408	85.30447	1.970.532	9 231 335 584	1.317.029
85.30008	1.970.394	85.30186	1.970.508	85.30456	1.970.613	9 231 337 005	1.217.024
85.30017	1.970.219	85.30186A2	1.970.508	85.30456A2	1.970.613	9 231 337 005	1.217.024
85.30021	1.970.589	85.30187	1.970.407	85.30459	1.970.579	9 231 337 005 706	1.217.024
85.30029	1.970.431	85.30187A2	1.970.407	85.30459S	1.970.579	9 231 337 005 706	1.217.024
85.30029A2	1.970.431	85.30190	1.970.423	85.30461	1.970.551	9 231 337 041	1.230.132
85.30032	1.970.108	85.30190A2	1.970.423	85.30485	1.970.522	9 231 337 041	1.230.132
85.30032A2	1.970.108	85.30194	1.970.434	85.30489	1.970.537	9 231 337 072	1.217.024
85.30034	1.970.345	85.30194A2	1.970.434	85.30490	1.970.503	9 231 337 072	1.217.024
85.30034A2	1.970.345	85.30195	1.970.437	85.30494	1.970.387	9 231 337 072 706	1.217.024
85.30035	1.970.106	85.30196	1.970.433	85.30525	1.970.527	9 231 337 072 706	1.217.024
85.30036	1.970.146	85.30197	1.970.425	85.30526	1.970.603	9 231 337 074	1.217.026
85.30036A2	1.970.146	85.30207	1.970.509	85.30526A2	1.970.603	9 231 337 074	1.217.026
85.30037	1.970.196	85.30212	1.970.602	85.30529	1.970.609	9 232 081 442	1.306.094
85.30038	1.970.155	85.30212A2	1.970.602	85.30529A2	1.970.609	9 232 337 354	1.117.097
85.30040	1.970.148	85.30214	1.970.557	85.30532	1.970.632	9 232 337 354	1.117.097
85.30042	1.970.228	85.30214A2	1.970.557	85.30532A2	1.970.632	9 232 337 354 706	1.117.097
85.30045	1.970.442	85.30217	1.970.170	85.30536	1.970.619	9 232 337 354 706	1.117.097
85.30045A2	1.970.442	85.30218	1.970.347	85.30536A2	1.970.619	9 233 335 511	1.317.014
85.30057	1.970.365	85.30228A2	1.970.459	85.30538A2	1.970.481	9 233 335 511	1.317.014
85.30057A2	1.970.365	85.30234	1.970.112	85.30539	1.970.620	9 233 335 551	1.317.023
85.30058	1.970.596	85.30235	1.970.178	85.30539A2	1.970.620	9 307 913	1.212.055HVS
85.30058A2	1.970.596	85.30236	1.970.178	85.30541	1.970.631	9 460 4446	1.306.098
85.30059	1.970.376	85.30237	1.970.179	85.30573A2	1.970.627	9 575 2	1.215.064
85.30060	1.970.378	85.30243	1.970.507	85.30578	1.970.623	90 034	1.206.034HVS
85.30062	1.990.420	85.30243A2	1.970.507	85.30578A2	1.970.623	90 069	1.406.014R
85.30062A2	1.990.420	85.30245A2	1.970.398	85.30581	1.970.638	90 246 G	1.306.079
85.30072	1.970.436	85.30249	1.970.475	85.30582	1.970.626	92 500	1.206.040
85.30072A2	1.970.436	85.30251	1.970.475	85.30582A2	1.970.626	92 500 X	1.206.040
85.30088	1.970.3545	85.30252	1.970.607	85.30586	1.970.622	92 504	1.206.034HVS
85.30090	1.970.417	85.30252A2	1.970.607	85.30592	1.970.647	92 504 B	1.206.034HVS
85.30090A2	1.970.417	85.30255	1.970.478	85.30592A2	1.970.647	92 712 E	1.206.049HVS

9262	1.501.451	ADR 5008	1.406.014R	B 965/1	1.406.112R	CM1T-228 C	1.970.347
940038500010	1.965.004	ADR 5031	1.413.014	B 967/1	1.406.112R	D 485	1.315.049
941044110501	1.500.716	ADR 5050	1.422.085	B 968/5	1.406.117R	D 487	1.315.041
941085180570	1.500.494	ADR 5052	1.431.119	B 969/1	1.406.122R	D 489	1.315.058
941094040575	1.500.432	ADT31477	1.970.461	B 971/5	1.406.117R	D 490	1.315.058
941094060576	1.500.507	AEI 600 C	1.990.303	B 972/5	1.406.117R	D 492	1.415.091
941095100582	1.501.451	AEI 600 F	1.990.303	B 974/1	1.406.122R	D 494	1.415.081
941095130583	1.500.616	ATA 1722	1.970.101D	B 975/5	1.406.114R	D 495	1.415.083R
941095680607	1.500.615	ATA 00115	1.970.101D	B 1000/5	1.406.045R	D 498	1.415.088
941095700609	1.500.694	B 3	1.306.112	B 1001/1	1.406.070R	D 498 A	1.415.088R
941095780616	1.500.616	B 11	1.306.124	B 1003/1	1.406.121R	D 499	1.415.088
941095790617	1.501.363	B 12	1.306.231	B 1005/1	1.406.119R	D 499 A	1.415.088R
941095800618	1.501.503	B 13	1.306.129	B 1008/1	1.406.118R	D 500	1.315.058
941095870625	1.500.888	B 13K	1.306.266	B 1009/1	1.406.127R	D 553 A	1.415.083R
941095910629	1.501.504	B 14	1.306.117	BAE 209 B	1.970.103	D 554 A	1.415.089R
941095980634	1.501.505	B 15	1.306.234	BAE 209 C	1.970.103	D 556	1.415.094
941125070664	1.500.509	B 16	1.306.235	BAE 403 C	1.970.442	D 556 A	1.415.094
941125120666	1.501.237	B 17	1.306.127	BAE 504 B	1.970.107	D 558	1.415.097
941125180672	1.500.514	B 18	1.306.240	BAE 504 D	1.970.148	D 559/1	1.415.099R
941125190673	1.500.634	B 19	1.306.241	BAE 504 L	1.970.228	D 560/1	1.415.104
941125310683	1.500.688	B 20	1.306.237	BAE 506	1.970.108	D 751	1.315.059
941125360686	1.501.531	B 21K	1.306.231 ^A	BAE 506 A	1.970.102	D 752	1.315.058
941125380688	1.501.529	B 22	1.306.238	BAE 506 D	1.970.108	D 753	1.315.059
941135120700	1.500.780	B 23	1.306.236	BAE 506 F	1.970.158	D 756	1.315.058
941135130701	1.501.025	B 24	1.306.094	BAE 507 AK	1.970.106	D 758	1.315.058
941135160703	1.500.674	B 38	1.306.062	BAE 680 C	1.970.532	D 759	1.315.062
941215240807	1.499.059	B 38 P	1.306.076	BAE 680 D	1.970.312	D 760	1.315.059
941285030866	1.501.278	B 39	1.306.072	BAE 800 AK	1.970.146	D 761	1.315.068
941285120871	1.501.753	B 53	1.306.072	BAE 800 B	1.970.146	D 762	1.315.067
941315020889	1.501.711	B 54	1.306.076	BAE 800 B	1.970.146	D 763	1.315.065
941318111002	1.499.244	B 54 A	1.306.079	BAE 800 DK	1.970.146	D 764	1.315.069
941318111140	1.501.529	B 54 G	1.306.094	BAE 800 EK	1.970.196	D 765	1.315.074
941318111161	1.501.451	B 64	1.406.018R	BAE 801 AK	1.970.275	D 766	1.315.075
941318111274	1.501.209	B 70	1.406.012R	BAE 801 BK	1.970.276	D 767	1.315.054
941318111287	1.501.681	B 73	1.406.018R	BAE 801 EK	1.970.196	D-107 P	1.230.127
941318111313	1.499.013	B 75	1.406.012R	BAE 920 A	1.970.345	D-107P	1.230.127
941318111315	1.499.230	B 76	1.406.014R	BAE 920 A	1.970.345	D-1957	1.965.025
941318111320	1.499.245	B 76 A	1.406.014R	BAE 920 AX	1.970.345	D-1958	1.965.025
941365030926	1.501.680	B 81	1.406.018R	BAE 920 AX	1.970.345	D-1961	1.965.025
94220291	1.413.027	B 82	1.406.021R	BAE 940 A	1.970.423	D-340	1.312.073
94238982	1.413.027	B 84	1.406.024R	BAE 940 A	1.970.423	D-436	1.412.097
949033	1.306.108	B 84/1	1.406.060R	BAE403C245	1.970.442	D-444	1.412.098
949034	1.306.121	B 87	1.406.025R	BAE409A245	1.970.432	DG 435	1.970.135
949035	1.317.016	B 87/1	1.406.061R	BAE800B245	1.970.146	DG 438	1.970.289
949041	1.312.073	B 88	1.406.026R	BAE851AE245	1.990.414	DG 440	1.970.170
949042	1.412.096	B 88/1	1.406.056R	BE 200 B	1.970.101D	DG 449	1.970.312
9616	1.501.209	B 89	1.406.067R	BK 3 A	1.970.101D	DG 458	1.970.2995
983 347	1.206.068	B 89/1	1.406.067R	BKL 2 A	1.965.005	DG 459	1.970.289
9856	1.501.745	B 91/1	1.406.112R	BKL 4 A	1.965.020	DG 460	1.970.312
9985	1.500.608	B 93	1.406.034R	BO100	1.970.432	DG 461	1.970.312
ADH 2	1.306.244	B 93/1	1.406.112R	BO207	1.970.461	DGE-446	1.970.289
ADH 5006	1.306.062	B 97	1.406.027R	BO300	1.970.532	DGE-447	1.970.233
ADH 5007	1.306.072	B 98	1.406.115R	CE 22 B	1.130.117	DGE-456	1.970.170
ADH 5013	1.322.003	B 99	1.406.023R	CE 22 C	1.130.117	DH 390	1.319.092
ADH 5016	1.322.003	B 99/1	1.406.049R	CE 39 A	1.130.117	DH 390B	1.319.092
ADH 5025	1.328.070	B 100	1.406.055R	CE 39 G	1.130.117	DH 390E	1.319.092
ADH 5027	1.328.075	B 100/1	1.406.055R	CE 39 P	1.130.127	DH 433	1.319.093
ADH 5032	1.322.003	B 1009/1	1.406.127R	CE 39 R	1.130.128	DH 434	1.319.093
ADH 5043	1.306.079	B 101	1.306.079	CE10000	1.970.399	DH 444	1.331.121
ADH 5071	1.331.131	B 103	1.306.081	CE20009-12B1	1.970.450	DHE 411	1.319.092
ADP 1	1.228.083MHV	B 105	1.306.081	CE20014-12B1	1.970.432	DHE 439	1.331.122
ADP 12	1.219.043HV	B 106	1.306.080	CE20042-12B1	1.970.532	DHE 440	1.331.125
ADP 92	1.228.083MHV	B 107	1.306.081	CE20044-12B1	1.970.532	DHE 441	1.331.121
ADP 5002	1.206.029HV	B 109	1.306.081	CM11-108	1.970.608	DHE 448	1.331.137
ADP 5007	1.222.056HV	B 110	1.306.081	CM11-109	1.970.529	DIC-0100	1.970.461
ADP 5009	1.213.011HV	B 112	1.306.092	CM11-111	1.970.608	DIC-0102	1.970.466
ADP 5010	1.206.032HV	B 113	1.306.093	CM11-112	1.970.529	DIC-0103	1.970.536
ADP 5011	1.206.029HV	B 116	1.306.092	CM11-116	1.970.603	DIC-0111	1.970.589
ADP 5018	1.219.044HV	B 117	1.306.099	CM11-118	1.970.527	DIC-0115	1.970.586
ADP 5019	1.206.049HVS	B 119	1.306.098	CM11-201	1.970.445	DIC-0116	1.970.219
ADP 5020	1.206.034HVS	B 121	1.306.108	CM11-202	1.970.384	DIC-0134	1.970.458
ADP 5021	1.206.034HVS	B 122	1.306.123	CM11-207A	1.970.457	DIC-0143	1.970.522
ADP 5032	1.206.034HVS	B 124	1.306.090	CM12-100	1.970.265	DIC-0144	1.970.457
ADP 5033	1.206.049HVS	B 125	1.306.233	CM1T-205	1.970.219	DIC-0200	1.990.414
ADP 5034	1.213.011HV	B 955	1.406.116R	CM1T-209B	1.970.216	DIC-0207	1.970.611
ADR 3	1.406.131	B 955/1	1.406.059R	CM1T-217	1.970.216	DIC-0209	1.970.614
ADR 71	1.428.006	B 958/1	1.406.115R	CM1T-228	1.970.347	DIS4-05	1.965.051
ADR 76	1.428.007	B 963	1.406.117R	CM1T-228 A	1.970.347	DIS4-08	1.965.072
ADR 5004	1.412.090	B 964	1.406.115R	CM1T-228 B	1.970.347	DN 192	1.222.056HV

DN 222	1.115.023	EDP 3 D	1.228.083MHV	FM 700	1.347.025	MTR 01	1.965.005
DN 428	1.406.014R	EDP 19	1.206.021	FM 701	1.330.086	P 603	1.338.242
DR 22	1.406.025R	EDP 36	1.206.034HVS	FM 702	1.330.090	P-125-3706-800	1.246.071
DR 195	1.215.056	EDP 36 D	1.206.034HVS	FM 706	1.330.076	P-125-500	1.347.025
DR 214	1.312.066	EDP 38	1.206.049HVS	FM 707	1.330.101	QA 1140	1.206.047
DR 217	1.312.073	EDP 38 D	1.206.049HVS	FM 710	1.330.082	QA 1160	1.206.029HV
DR 218	1.312.074	EDP 50	1.206.034HVS	FM 711	1.330.093	QA 1420	1.206.021
DR 220A	1.419.085	EDP 51	1.228.083MHV	FM 712	1.330.098	QA 1470	1.206.029HV
DR 226	1.412.090	EDP 59	1.222.056HV	FM 713	1.330.098	QA 1570	1.206.032HV
DR 239	1.412.093	EDP 60	1.215.056	FM 714	1.330.098	QA 1610	1.206.034HVS
DR 240	1.412.095R	EDP 75	1.206.034HVS	FM 717	1.330.109	QA 1640	1.206.049HVS
DR 241	1.412.096	EDP 103	1.231.084	FM 725	1.430.042R	QA 1710	1.206.040
DR 242 A	1.412.095R	EDP 109	1.228.089	FM 725 A	1.430.042R	QA 1920	1.206.062
DR 243	1.412.097	EDP 131	1.206.049HVS	FM 726 A	1.446.014R	QA 2990	1.213.022HV
DR 244	1.412.100	EDP 137	1.206.034HVS	FM 727	1.430.042R	QA 3430	1.222.056HV
DR 375A	1.419.092	EDP 198	1.206.021	FM 727 A	1.430.042R	QA 3440	1.213.011HV
DRE 90	1.419.085	EDR 2	1.428.006	FM 728 A	1.430.055R	QA 3520	1.212.055HVS
DRE 381	1.422.073	EDR 2 D	1.428.006	FM 735/5	1.430.051R	QA 4090	1.231.084
DRE 383	1.431.108	EDR 3	1.419.085	FM 736	1.430.060	QA 4400	1.230.123
DRE 385	1.431.113	EDR 3 D	1.419.085	GN10210-12B1	1.970.475	QA 4480	1.230.132
DRE 388	1.431.108	EDR 3 S	1.419.085	GN10236-12B1	1.970.429	QA 4510	1.230.139
DRE 389	1.431.137	EDR 12	1.406.012R	GN10248-11B1	1.970.608	QA 4520	1.230.140
DRE 389 A	1.431.137	EDR 12 D	1.406.012R	GN10314-12B1	1.970.461	QA 4540	1.230.142
DRE 390	1.431.131	EDR 12 S	1.406.012R	GN10337-12B1	1.970.557	QA 5120	1.219.043HV
DRE 390 A	1.431.131	EDR 23	1.406.024R	GN10571-12B1	1.970.475	QA 5130	1.219.044HV
DRE 391	1.431.133	EDR 40	1.406.012R	GN10572-12B1	1.970.475	QA 5400	1.215.086
DRE 394	1.431.132	EDR 40 D	1.406.012R	J 610	1.313.102	QA 5450	1.215.102
DRE 395	1.431.134	EDR 49	1.406.024R	J 611	1.313.094	QA 5480	1.215.105
DT 453 AX	1.930.177/1 ^N	EDR 80	1.431.023	J 617	1.322.057	QA 5670	1.215.055
DT 458 BX	1.930.182 ^N	EDR 85	1.415.091	J 619	1.322.011	QA 5705	1.215.056
EDC 62	1.115.023	EDR 92	1.428.014	J 623	1.313.092	QA 5730	1.242.054
EDC 173	1.115.023	EDR 98	1.406.060R	J 627	1.313.099	QA 6200	1.228.083MHV
EDG 27	1.970.169	EDR 109	1.406.025R	J 633	1.322.003	QB 1030	1.142.056
EDG 43	1.970.135	EDR 113	1.406.024R	J 641	1.331.003/00	QB 1640	1.115.023
EDH 8	1.328.070	EDR 123	1.406.112R	J 644	1.313.093	QB 4010	1.115.034
EDH 10	1.328.075	EDR 130	1.406.121R	J 659	1.413.014	QB 4011	1.115.034
EDH 10D	1.328.075	EDR 135	1.406.112R	J 660	1.431.023	QB 5180	1.130.117
EDH 12	1.319.083	EDR 151	1.406.061R	J 661	1.413.014	QB 5310	1.106.196
EDH 12 D	1.319.083	EDR 157	1.406.061R	J 662	1.406.018R	QB 5390	1.106.195
EDH 12 S	1.319.083	EDR 159	1.428.026R	J 666	1.431.023	QB 6060	1.106.212
EDH 16	1.319.083	EDR 161	1.430.057R	J 667	1.422.052	QC 0720	1.406.018R
EDH 24	1.306.079	EDR 182	1.406.121R	J 670	1.413.027	QC 0750	1.406.012R
EDH 24 D	1.306.079	EDR 183	1.406.121R	J 672	1.422.056	QC 0760	1.406.014R
EDH 25	1.306.076	EDR 187	1.406.061R	J 675	1.413.014	QC 0810	1.406.018R
EDH 25 D	1.306.076	EDR 210	1.430.057R	J 686	1.422.073	QC 0820	1.406.021R
EDH 26	1.306.072	EDR 240	1.406.140R	J 852	1.313.107	QC 0840	1.406.024R
EDH 27	1.306.072	EDR 248	1.406.121R	J 855	1.331.003/00	QC 0841	1.406.060R
EDH 279	1.306.253	EDR 249	1.428.026R	J 856	1.322.022	QC 0880	1.406.026R
EDH 28	1.306.081	EDR 309	1.906.233 ^S	J 858	1.322.040	QC 0930	1.406.034R
EDH 30	1.306.062	F 155 A	1.306.112	J 864	1.313.262	QC 0970	1.406.027R
EDH 31	1.306.072	F 160	1.319.092	J 865	1.313.113	QC 1130	1.431.023
EDH 36	1.306.079	F 161	1.319.093	J 871	1.322.046	QC 2390	1.412.093
EDH 38	1.306.081	F 190	1.419.092	J 873	1.313.117	QC 3770	1.428.006
EDH 42	1.306.081	F 000 99C 602	1.499.246	J 875	1.313.122	QC 3830	1.428.007
EDH 67	1.306.076	F 000 ZSO 001	1.970.192	J 876	1.331.118	QC 3890	1.419.085
EDH 75	1.306.081	F 000 ZSO 111	1.970.140	J 878	1.322.041	QC 3910	1.428.012
EDH 88	1.306.081	F 000 ZSO 206	1.970.416 ^A	J 879	1.322.048	QC 4410	1.430.037
EDH 93	1.330.069	F 000 ZSO 207	1.970.416	JD 633	1.322.003	QC 4440	1.430.036R
EDH 95	1.330.069	F 01R 00A 025	1.970.188	JD 659	1.413.014	QC 4950	1.415.091
EDH 117	1.306.081	FE 900	1.317.014	JD 661	1.413.014	QC 4990	1.415.088
EDH 125	1.306.109	FE 903	1.317.023	JD 662	1.406.018R	QC 5560	1.415.094
EDH 128	1.328.083	FE 926	1.417.058	JP 873	1.313.117	QC 5640	1.430.047R
EDH 130	1.306.079	FM 412	1.330.059	L 330	1.428.025	QC 6590	1.413.014
EDH 142	1.330.069	FM 417	1.330.069	L 330/1	1.428.026R	QC 7250	1.430.042R
EDH 170	1.330.098	FM 420	1.330.081	L 347	1.328.085	QC 9565	1.428.014
EDH 183	1.306.235	FM 431	1.430.029	L 350	1.328.083	QC 9580	1.406.055R
EDH 189	1.331.109	FM 432	1.430.029	L 360	1.328.094	QC 9585	1.413.027
EDH 196	1.330.098	FM 436?	1.430.037	L 366	1.328.070	QC 9590	1.406.112R
EDH 199	1.328.096	FM 437	1.430.037R	L 368	1.319.083	QC 9600	1.406.067R
EDH 201	1.330.098	FM 438	1.430.037	L 371	1.328.075	QC 9605	1.412.096
EDH 208	1.330.098	FM 439	1.430.029	L 373	1.328.078	QD 0380	1.306.062
EDH 216	1.328.094	FM 441	1.430.037R	L 377	1.428.006	QD 0390	1.306.072
EDH 226	1.330.098	FM 442	1.430.037	L 379	1.428.007	QD 0541	1.306.079
EDH 390	1.319.092	FM 443	1.430.037R	L 381	1.428.007	QD 1060	1.306.080
EDP 1	1.219.043HV	FM 444	1.430.036R	L 383	1.428.007	QD 1070	1.306.081
EDP 1 D	1.219.043HV	FM 445	1.430.036R	L 387	1.419.085	QD 1120	1.306.092
EDP 2	1.219.044HV	FM 446	1.430.037R	L 390 A	1.415.088	QD 1130	1.306.093
EDP 2 D	1.219.044HV	FM 447	1.430.040	L 391	1.428.012	QD 1170	1.306.099
EDP 3	1.228.083MHV	FM 449	1.430.041	L 399/1	1.428.024R	QD 2025	1.328.091

QD 2140	1.312.066
QD 3500	1.328.083
QD 3660	1.328.070
QD 3680	1.319.083
QD 3710	1.328.075
QD 3730	1.328.078
QD 4170	1.330.069
QD 4200	1.330.081
QD 4276	1.313.094
QD 4600	1.342.043
QD 4643	1.330.101
QD 4850	1.315.049
QD 5000	1.315.058
QD 6190	1.322.011
QD 6200	1.331.109
QD 6330	1.322.003
QD 6410	1.331.003/00
QD 6440	1.313.093
QD 7020	1.330.090
QD 7530	1.315.059
QD 8550	1.306.121
QD 8555	1.306.081
QD 8570	1.313.092
QD 8590	1.313.114
QD 8595	1.322.003
QD 8600	1.306.108
QD 8610	1.312.073
QD 8615	1.322.022
QD 8625	1.306.123
QD 8630	1.331.003/00
QD 8640	1.313.119
S 57/45	1.430.029
SE 100 AXY	1.930.176M ^{*N}
SE 100 CX	1.930.176M ^{*N}
SE 100 EX	1.930.176M ^{*N}
SE 100 GX	1.930.176M ^{*N}
SE 100 HXY	1.930.176M ^{*N}
SE 101 AB	1.930.180M ^{*N}
SE 101 C	1.930.180M ^{*N}
SM 800 AX	1.930.161/1 ^{*N}
SM 800 BX	1.930.161/1 ^{*N}
SM 803 AX	1.930.161/1 ^{*N}
SM 806 AX	1.930.161/1 ^{*N}
SM 807 AX	1.930.163/1 ^{*N}
SV 460	1.342.043
US 130	1.347.027
US 139/1	1.446.016R



CONDENSERS

CONDENSATORI
CONDENSATEURS
KONDENSATOREN
CONDENSADORES

Code		New code
1.106.180	E	
1.106.195	E	
1.115.023	E	
1.115.034	E	
1.115.039	E	
1.142.056	E	

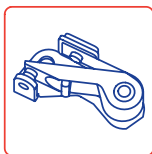

CONTACT SETS

COPPIE CONTATTI
RUPTEURS
KONTAKTSÄTZE
PLATINOS

Code		New code
1.206.040	E	
1.206.047	E	
1.206.064	E	
1.215.056	E	
1.215.056HV	E	
1.215.067	E	
1.215.076	E	
1.215.102	E	
1.215.103	E	
1.215.111U	E	
1.215.112U	E	
1.217.024	E	
1.219.043HV	S	
1.228.089	E	
1.230.126	E	
1.230.140HV	E→	1.230.140
1.230.149	E	

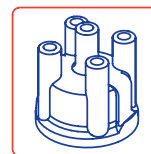

DISTRIBUTOR CAPS

CALOTTE
TÊTES D'ALLUMEUR
VERTEILERKAPPEN
TAPAS DEL DISTRIBUIDOR

Code		New code
1.306.098	E	
1.306.099	E	
1.306.235	E	
1.306.236	S	
1.306.237	S	
1.306.238	S	
1.306.240	S	
1.306.248	S	
1.306.252	S	
1.306.253	S	
1.306.257	S	
1.306.258	E	
1.306.261	E	
1.312.066	S	
1.312.073	S	
1.312.074	E	
1.312.075	S	
1.313.092	S	
1.313.099	S	
1.313.102	S	
1.313.107	S	
1.313.113	S	
1.313.117	S	
1.313.119	S	
1.313.122	S	
1.313.127	E	
1.313.128	E	
1.313.240	E	
1.313.248	S	
1.313.251	E	
1.313.252	S	
1.313.256	S	
1.313.257	S	
1.313.259	E	
1.313.262	S	
1.313.267	S	
1.313.272	E	

E	Dropped	Eliminato	Éliminé	Gestrichen	Eliminado
→	New code	Nuovo codice	Nouvelle reference	Neue Teile-NR.	Nuevo codigo
S	Supplied until depletion	Fornibile fino ad esaurimento	Fourni jusqu'à l'épuisement du stock	Lieferbar solange Vorrat reicht	Suministrado hasta el stock termina



VARIATIONS COMPARED TO PREVIOUS CATALOGUE EDITION

•VARIAZIONI RISPETTO AI PRECEDENTI CATALOGHI •VARIATIONS RAPPORTÉES AUX CATALOGUES PRÉCÉDENTS

•ÄNDERUNGEN IM VERGLEICH ZU FRÜHEREN KATALOGAUSGABEN •VARIACIONES CON RESPECTO A CATALOGOS ANTERIORES

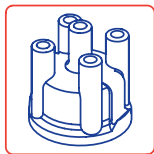

DISTRIBUTOR CAPS

CALOTTE
TÊTES D'ALLUMEUR
VERTEILERKAPPEN
TAPAS DEL DISTRIBUIDOR

Code		New code
1.313.273	E	
1.315.041	E	
1.315.045	S	
1.315.049	S	
1.315.065	S	
1.315.066	S	
1.315.075	S	
1.315.077	E	
1.315.078	E	
1.315.084	S	
1.315.088	S	
1.317.014	E	
1.317.016	S	
1.319.083	S	
1.319.092	S	
1.319.093	S	
1.322.003	S	
1.322.004	E	
1.322.011	E	
1.322.022	S	
1.322.046	S	
1.322.058	E	
1.322.060	S	
1.322.063	E	
1.322.069	S	
1.322.071	S	
1.322.073	S	
1.322.075	S	
1.322.077	S	
1.322.079	S	
1.322.082	S	
1.322.084	E	
1.322.088	S	
1.322.092	E	
1.322.093	S	
1.328.070	S	
1.328.075	S	

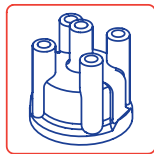

DISTRIBUTOR CAPS

CALOTTE
TÊTES D'ALLUMEUR
VERTEILERKAPPEN
TAPAS DEL DISTRIBUIDOR

Code		New code
1.328.078	S	
1.328.083	S	
1.328.085	S	
1.328.094	E	
1.328.096	E	
1.328.099	E	
1.328.100	S	
1.328.102	S	
1.328.103	S	
1.328.106	S	
1.330.076	E	
1.330.093	S	
1.330.110	S	
1.331.116	S	
1.331.117	S	
1.331.122	S	
1.331.126	S	
1.331.131	S	
1.331.132	S	
1.331.135	E	
1.331.136	E	
1.331.137	S	
1.331.140	S	
1.331.147	E	
1.331.149	S	
1.331.151	S	
1.331.152	S	
1.331.154	E	
1.331.155	S	
1.331.158	S	
1.331.169	E	
1.347.027	S	

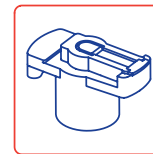

ROTORS

DISTRIBUTORI
DISRUPTEURS
VERTEILERLÄUFER
ROTORES DEL DISTRIBUIDOR

Code		New code
1.406.021R	S	
1.406.034R	E	
1.406.045R	E	
1.406.113R	E	
1.406.117R	E	
1.406.119R	S	
1.406.122R	E	
1.406.125R	S	
1.412.090	S	
1.412.093	E	
1.412.097	E	
1.413.010	E	
1.413.034	S	
1.415.080	E→	1.415.091
1.415.088R	E	
1.415.096R	S	
1.419.092	S	
1.419.094R	E	
1.422.052	S	
1.422.056	S	
1.422.070	S	
1.422.081	E	
1.422.086	S	
1.422.097R	E	
1.428.014	S	
1.428.021	S	
1.428.025	S	
1.430.036R	S	
1.430.041	E	
1.430.042R	S	
1.430.051R	E	
1.430.058	E	
1.431.023	S	
1.431.030	S	
1.431.107	S	
1.431.133	S	
1.431.137	S	

E	Dropped	Eliminato	Éliminé	Gestrichen	Eliminado
→	New code	Nuovo codice	Nouvelle reference	Neue Teile-NR.	Nuevo codigo
S	Supplied until depletion	Fornibile fino ad esaurimento	Fourni jusqu'à l'épuisement du stock	Lieferbar solange Vorrat reicht	Suministrado hasta el stock termina

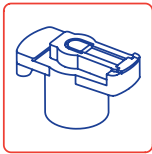

ROTORS

DISTRIBUTORI
DISRUPTEURS
VERTEILERLÄUFER
ROTORES DEL DISTRIBUIDOR

Code	New code
1.446.016R	S

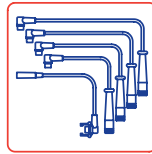

IGNITION CABLE SETS

SERIE CAVI ACCENSIONE COMPLETA
JEUX CABLES D'ALLUMAGE
ZÜNDKABELSÄTZE
JUEGOS DE CABLES DE ENCENDIDO

Code	New code
1.499.004	S
1.499.005	E
1.499.020	S
1.499.028	E
1.499.049	S
1.499.059	S
1.499.061	S
1.499.064	S
1.499.069	E
1.499.100	E
1.499.107	E
1.499.111	S
1.499.120	S
1.499.159	E
1.499.181	E
1.499.195	E
1.499.199	E
1.499.214	S
1.499.231	E
1.499.236	S
1.499.239	S
1.499.241	S
1.499.245	S
1.499.247	S
1.499.251	S
1.500.351	S
1.500.354	S
1.500.372	S
1.500.386	S
1.500.398	S
1.500.415	E
1.500.417	E
1.500.429	E
1.500.432	S
1.500.456	E
1.500.466	S
1.500.471	S

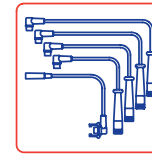

IGNITION CABLE SETS

SERIE CAVI ACCENSIONE COMPLETA
JEUX CABLES D'ALLUMAGE
ZÜNDKABELSÄTZE
JUEGOS DE CABLES DE ENCENDIDO

Code	New code
1.500.491	E
1.500.493	S
1.500.494	S
1.500.507	S
1.500.509	S
1.500.511	E
1.500.513	E
1.500.514	S
1.500.527	E
1.500.539	E
1.500.543	E
1.500.572	E
1.500.573	E
1.500.578	E
1.500.587	E
1.500.608	S
1.500.609	E
1.500.612	E
1.500.613	E
1.500.623	S
1.500.634	S
1.500.650	E
1.500.655	E
1.500.660	E
1.500.666	E
1.500.674	S
1.500.688	S
1.500.689	S
1.500.692	E
1.500.694	S
1.500.700	E
1.500.716	S
1.500.725	S
1.500.727	E
1.500.736	S
1.500.737	S
1.500.747	E

E	Dropped	Eliminato	Éliminé	Gestrichen	Eliminado
→	New code	Nuovo codice	Nouvelle reference	Neue Teile-NR.	Nuevo codigo
S	Supplied until depletion	Fornibile fino ad esaurimento	Fourni jusqu'à l'épuisement du stock	Lieferbar solange Vorrat reicht	Suministrado hasta el stock termina



VARIATIONS COMPARED TO PREVIOUS CATALOGUE EDITION

•VARIAZIONI RISPETTO AI PRECEDENTI CATALOGHI •VARIATIONS RAPPORTÉES AUX CATALOGUES PRÉCÉDENTS
•ÄNDERUNGEN IM VERGLEICH ZU FRÜHEREN KATALOGAUSGABEN •VARIACIONES CON RESPECTO A CATALOGOS ANTERIORES

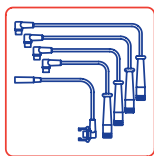

IGNITION CABLE SETS

SERIE CAVI ACCENSIONE COMPLETA
JEUX CABLES D'ALLUMAGE
ZÜNDKABELSÄTZE
JUEGOS DE CABLES DE ENCENDIDO

Code		New code
1.500.748	E	
1.500.768	E	
1.500.801	S	
1.500.802	S	
1.500.808	E	
1.500.815	E	
1.500.839	E	
1.500.864	E	
1.500.884	E	
1.500.887	S	
1.500.888	S	
1.500.889	E	
1.500.900	E	
1.500.956	E	
1.501.007	S	
1.501.025	S	
1.501.078	S	
1.501.138	E	
1.501.140	E	
1.501.145	S	
1.501.209	S	
1.501.231	E	
1.501.237	S	
1.501.278	S	
1.501.281	E	
1.501.300	S	
1.501.323	E	
1.501.332	S	
1.501.343	E	
1.501.344	E	
1.501.345	S	
1.501.353	E	
1.501.356	E	
1.501.363	S	
1.501.364	S	
1.501.373	E	
1.501.374	E	

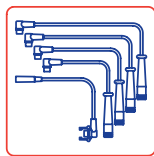

IGNITION CABLE SETS

SERIE CAVI ACCENSIONE COMPLETA
JEUX CABLES D'ALLUMAGE
ZÜNDKABELSÄTZE
JUEGOS DE CABLES DE ENCENDIDO

Code		New code
1.501.376	E	
1.501.385	S	
1.501.393	E	
1.501.398	E	
1.501.399	E	
1.501.401	E	
1.501.411	S	
1.501.413	S	
1.501.415	S	
1.501.417	E	
1.501.420	E	
1.501.433	E	
1.501.434	E	
1.501.435	E	
1.501.443	E	
1.501.446	S	
1.501.447	E	
1.501.479	E	
1.501.484	E	
1.501.489	S	
1.501.491	S	
1.501.492	E	
1.501.497	S	
1.501.499	S	
1.501.501	E	
1.501.506	E	
1.501.508	E	
1.501.509	S	
1.501.511	S	
1.501.518	E	
1.501.529	S	
1.501.531	S	
1.501.549	E	
1.501.551	S	
1.501.559	S	
1.501.562	E	
1.501.580	S	

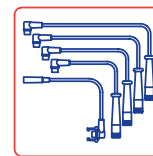

IGNITION CABLE SETS

SERIE CAVI ACCENSIONE COMPLETA
JEUX CABLES D'ALLUMAGE
ZÜNDKABELSÄTZE
JUEGOS DE CABLES DE ENCENDIDO

Code		New code
1.501.595	E	
1.501.607	E	
1.501.608	E	
1.501.609	S	
1.501.614	S	
1.501.619	S	
1.501.624	S	
1.501.630	S	
1.501.634	S	
1.501.639	S	
1.501.640	S	
1.501.641	S	
1.501.643	S	
1.501.649	S	
1.501.654	E	
1.501.657	E	
1.501.658	E	
1.501.660	S	
1.501.667	E	
1.501.671	E	
1.501.677	E	
1.501.680	S	
1.501.682	E	
1.501.686	E	
1.501.691	S	
1.501.699	S	
1.501.702	S	
1.501.709	E	
1.501.711	S	
1.501.719	S	
1.501.723	S	
1.501.729	E	
1.501.730	S	
1.501.731	S	
1.501.732	S	
1.501.738	E	
1.501.739	S	

E	Dropped	Eliminato	Éliminé	Gestrichen	Eliminado
→	New code	Nuovo codice	Nouvelle reference	Neue Teile-NR.	Nuevo codigo
S	Supplied until depletion	Fornibile fino ad esaurimento	Fourni jusqu'à l'épuisement du stock	Lieferbar solange Vorrat reicht	Suministrado hasta el stock termina

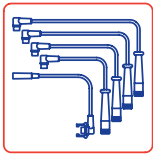

IGNITION CABLE SETS

SERIE CAVI ACCENSIONE COMPLETA
 JEUX CABLES D'ALLUMAGE
 ZÜNDKABELSÄTZE
 JUEGOS DE CABLES DE ENCENDIDO

Code		New code
1.501.740	S	
1.501.741	E	
1.501.745	S	
1.501.753	S	
1.501.760	E	
1.501.764	E	
1.501.767	S	
1.501.789	E	
1.501.792	E	
1.501.793	E	
1.501.813	S	
1.501.817	E	
1.501.819	S	
1.501.823	S	
1.501.835	S	
1.501.841	S	
1.501.851	S	
1.501.856	S	
1.501.878	E	
1.501.879	E	
1.501.880	S	
1.501.882	E	
1.501.883	S	
1.501.887	S	
1.501.888	S	
1.501.900	S	
1.501.904	S	
1.501.914	S	
1.501.921	E	
1.501.932	S	
1.501.933	E	
1.501.937	S	
1.501.942	E	
1.501.947	S	
1.501.954	E	
1.501.955	E	
1.501.962	E	

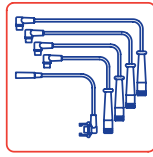

IGNITION CABLE SETS

SERIE CAVI ACCENSIONE COMPLETA
 JEUX CABLES D'ALLUMAGE
 ZÜNDKABELSÄTZE
 JUEGOS DE CABLES DE ENCENDIDO

Code		New code
1.501.963	E	
1.501.976	E	
1.501.984	E	
1.501.990	E	

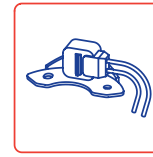

PICK-UPS

IMPULSORI
 CAPTEURS
 IMPULSGEBER
 CAPTADORES

Code		New code
1.906.153	E	
1.906.160	S	
1.930.161/1	S	
1.930.163/1	S	
1.930.176M	S	
1.930.177/1	S	
1.930.180M	S	

E	Dropped	Eliminato	Éliminé	Gestrichen	Eliminado
→	New code	Nuovo codice	Nouvelle reference	Neue Teile-NR.	Nuevo codigo
S	Supplied until depletion	Fornibile fino ad esaurimento	Fourni jusqu'à l'épuisement du stock	Lieferbar solange Vorrat reicht	Suministrado hasta el stock termina

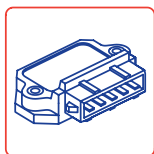

IGNITION MODULES

MODULI DI ACCENSIONE
MODULES D'ALLUMAGE
ZÜNDMODULE
MÓDULOS DE ENCENDIDO

Code		New code
1.965.007	E	
1.965.068	E	
1.965.073	E	

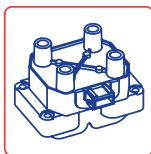

IGNITION COILS

BOBINE DI ACCENSIONE
BOBINES D'ALLUMAGE
ZÜNDSPULEN
BOBINAS DE ENCENDIDO

Code		New code
1.970.107	E	
1.970.109	E	
1.970.110	E→	1.970.341
1.970.155	S	
1.970.159	E	
1.970.191	E	
1.970.197	E	
1.970.199	E	
1.970.201	E	
1.970.211	E	
1.970.212	E	
1.970.216	E	
1.970.252	E	
1.970.273	E	
1.970.276	E	
1.970.283	E	
1.970.284	E	
1.970.285	E→	1.970.285S
1.970.289	E	
1.970.299	E	
1.970.299S	E	
1.970.312	E	
1.970.313	E	
1.970.316	E	
1.970.316K	E	
1.970.317	E	
1.970.344	E	
1.970.352	E	
1.970.364	E	
1.970.366S	E	
1.970.376	S	
1.970.377	E→	1.970.596
1.970.378	S	
1.970.389	S	
1.970.393	E	
1.970.412	E	
1.970.413	E	

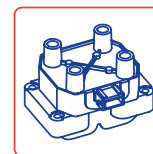

IGNITION COILS

BOBINE DI ACCENSIONE
BOBINES D'ALLUMAGE
ZÜNDSPULEN
BOBINAS DE ENCENDIDO

Code		New code
1.970.414	E	
1.970.416	E	
1.970.507	S	
1.970.557	S	
1.970.583	S	
1.990.307	E	
1.990.416	E	
1.990.423	E	

E	Dropped	Eliminato	Éliminé	Gestrichen	Eliminado
→	New code	Nuovo codice	Nouvelle reference	Neue Teile-NR.	Nuevo codigo
S	Supplied until depletion	Fornibile fino ad esaurimento	Fourni jusqu'à l'épuisement du stock	Lieferbar solange Vorrat reicht	Suministrado hasta el stock termina

GENERAL CONDITIONS OF SALE

1. SCOPE AND EFFECTIVENESS

All supplies of products made by Facet S.r.l. (the «Seller») to a customer (the «Buyer») are governed by these general terms and conditions which shall prevail on purchase conditions of the Buyer, as well as by any special conditions provided for in offers and/or order confirmations by the Seller. In the case of conflict between the general terms and conditions and the special conditions, the latter shall prevail. The data and illustrations relating to products appearing in the Seller's catalogues or brochures are indicative in nature and not binding, unless expressly provided so in the order confirmation by the Seller and may be subject to changes in design and materials without notice. The original product codes indicated in the catalogues and in other documents are mentioned only for the purpose of identifying the spare parts. The Seller supplies only products of its own production identified with its own product codes and not products having OE codes.

2. COMPLETION OF THE CONTRACT

The supply contract is considered being completed only on the Seller's written confirmation accepting the Buyer's order. The Seller reserves the right not to accept orders in cases where there is a dispute with the customer relating to a previous order.

3. PRICES AND PAYMENTS

Unless otherwise agreed, payments of the price must be carried out by the Buyer in accordance with the terms and conditions provided and using the method provided for in the order confirmation at the domicile of the Seller. Payments made by the Buyer to finders and/or agents without a special Power of Attorney will not be enforceable on the Seller. In the event of a delay in payment, the Buyer will be liable for the payment of late payment default interest at the rate of the European Central Bank in force on that date plus 7 (seven) points. In every case, the Seller has the right to ask for compensation for the greater damage suffered. The Buyer will not for any reason, except with written authorisation, be able to off-set or retain sums due to the Seller, nor will he be able to suspend payments. The prices of the products are to be considered in Euros and do not include VAT, packaging, transport and insurance costs. The Seller may change the prices and rates in force at any time and without notice, except for ongoing orders. Price increases are possible for increases in raw materials, labour, transport, insurance premiums, etc.

4. TERMS OF DELIVERY AND PRODUCTION

Unless otherwise stated in the order confirmation, supplies of the products are intended for goods delivered in accordance with Incoterms 2010: FCA Orbassano. The goods always travel on behalf of and at the risk of the Buyer.

The terms of delivery are indicative and in the event of delay the Buyer is not entitled to request termination of the contract and/or compensation for damages.

5. RETENTION OF TITLE

The delivered products remain the property of the Seller until full payment of the price has been received.

The Buyer shall have the right to sell the purchased products, or the new products which incorporate the products supplied by the Seller, on the understanding that in such cases, all the proceeds will be transferred to the Seller right down to the agreed price due from the Buyer to the Seller for the supply of such products.

The right to sell the products shall lapse if the Buyer has failed to comply with payment obligations for a period greater than 20 (twenty) working days after the payment deadline. In such event, it will be the responsibility of the Seller to revoke the right to sell in writing to the Buyer. The Buyer should put in place every measure necessary for the protection of the products subject to the retention of title, and any other measure necessary to not confuse the products of the Seller with products from other suppliers and keep the products of the Seller in well defined areas and easily identifiable.

6. RESPONSIBILITY OF THE SELLER AND LIMITS

The Seller is exclusively responsible for the correct production of products supplied, which will require to have all the features provided by the Seller in the order confirmation. The Seller does not assume any responsibility, however, for possible faulty operation of machines or systems made by the Buyer using products supplied by the Seller.

The products must be properly installed by trained and qualified technicians only, in accordance with the vehicle specifications and complying with the requirements of national regulations.

In such cases, the Buyer will not be able seek damages for lost profits, loss of production, reputational damages, vehicle breakdown.

The liability of the Seller is, however, limited to the value of the goods supplied, unless due to serious negligence or willful misconduct within the meaning of the law.

7. FORCE MAJEURE

Should the Seller be unable to comply with the contract for reasons of force majeure or independent factors outside his control, the deadlines for the supply shall be automatically extended for a period equivalent to the lingering effects of the force majeure event. The following are to be regarded as causes of force majeure (without limitation): lack of energy or raw materials, strikes, public administration measures, impediments to circulation or to production activities.

8. COMPLAINTS and ACCEPTANCE OF PRODUCTS

Any complaint concerning the non-conformity of the goods delivered or for damages caused by transportation or for any missing quantities with respect to the products ordered, must be communicated by registered letter, with receipt acknowledgment, addressed directly to the Seller within 8 (eight) days from the date of delivery of the products in the case of visible defects and within 8 (eight) days from the discovery in the case of hidden defects, and in any case, within a month from delivery, with a detailed explanation of the facts. In the event of non-compliance with the above, the amounts invoiced are considered, to all effects, accepted and no longer contestable by the Buyer.

The return of goods will not be accepted unless previously agreed in writing by the Seller.

9. CONFORMITY TO THE SPECIFICATIONS AND GUARANTEE TERMS

The Seller guarantees that the products will be compliant with the technical specifications declared by the Seller to the Buyer in the order confirmation and the guarantee will be valid for 2 (two) years from the date of delivery of the products and for products or parts replaced, from the day of their replacement.

During the guarantee period, the Seller to whom the Buyer has made a formal notice of the defects, undertakes, at his own discretion, and within a reasonable period of time, to repair or replace the products or the defective parts free of charge. The costs and risks of transportation of the defective products to the Seller's address are borne by the Buyer. The replaced products remain the property of the Seller.

The guarantee is considered lapsed where the end use of the product does not conform with the regular use of such products or not provided for in the catalogues of the Seller or if the products have been modified or repaired without the Seller's authorisation.

10. GUARANTEE OF THE SUITABILITY OF THE PRODUCTS ONLY TO EU RULES

The Seller guarantees that the products will conform to the standards of the European Union (EU) as they may be applicable.

No guarantee is issued by the Seller for the conformity of these products with the rules and regulations, expressly including those rules regarding safety and accident prevention, in force in the Buyer's country, where those reside outside the EU, or more generally, in any country that does not belong to the EU in which the supplied products are used.

11. CONFIDENTIALITY AND DATA PROTECTION

Documents of any kind provided by the Seller shall remain the Seller's property and cannot be transferred to a third party or reproduced. The Buyer undertakes, even after the end of the contract, not to disclose commercial secrets and confidential information that the Buyer has been party to or which has come to his knowledge in the course of his relationship with the Seller.

The Seller herewith declares that he will use the personal data transferred by the Customer in respect of the terms provided under the Italian privacy law (Legislative Decree n. 196/03).

12. TERMINATION OF THE CONTRACT

The contract may be terminated pursuant to art. 1456 of the Italian Civil Code by virtue of a simple written declaration on the part of the Seller, taking advantage of this termination clause if the Buyer:

- omits or delays payments due;

- is placed in liquidation or has been subject to any insolvency proceedings.

13. INTELLECTUAL PROPERTY

The Seller retains the intellectual property of projects, studies, drawings, models and products which are realised or made in his name and on his behalf. The brands under which the products are sold may not be used by the Buyer if they are not identified as such.

14. APPLICABLE LAW AND DISPUTE RESOLUTION CLAUSE

All contracts with the Seller shall be governed by Italian law. Any dispute will be referred to the exclusive jurisdiction of the Court of Turin.

Date: _____ Stamp, Name, Surname and Signature of the Buyer: _____

Pursuant to articles. 1341 and 1342 of the Italian Civil Code, the Buyer declares to have read and specifically approved the terms contained in the following articles of general conditions: art. 3 Set-off Prohibition; art. 5 Retention of title; art. 6 Limitation of Liability; art. 8 Complaints and Acceptance of Products; art. 14 Dispute Resolution Clause.

Date: _____ Stamp, Name, Surname and Signature of the Buyer: _____

CONDIZIONI GENERALI DI VENDITA

1. AMBITO DI APPLICAZIONE E EFFICACIA

Tutte le forniture di prodotti effettuate da Facet S.r.l. (il "Venditore") a un cliente (l'"Acquirente") sono disciplinate dalle presenti condizioni generali che prevalgono sulle condizioni d'acquisto dell'Acquirente, nonché dalle condizioni particolari previste nelle offerte e/o conferme d'ordine del Venditore. In caso di contrasto fra quanto contenuto nelle condizioni generali e nelle condizioni particolari, queste ultime prevorranno.

I dati e le illustrazioni relative ai prodotti risultante dai cataloghi o prospetti del Venditore hanno carattere indicativo e non valore vincolante se non espressamente previsto nella conferma d'ordine del Venditore e possono essere soggetti a modifiche di disegno e materiale senza preavviso.

I numeri originali (OE) indicati nei cataloghi od in altri documenti sono menzionati solamente al fine di identificare le parti di ricambio. Il venditore fornisce unicamente prodotti di propria produzione contrassegnati con il proprio codice articolo e non prodotti con i numeri OE.

2. FORMAZIONE DEL CONTRATTO

Il contratto di fornitura si perfeziona con la conferma scritta del Venditore di accettazione dell'ordine dell'Acquirente. Il Venditore si riserva il diritto di non accettare ordini nel caso in cui vi sia una controversia con il cliente relativa ad un ordine precedente.

3. PREZZI E PAGAMENTI

Salvo diverso accordo, i pagamenti del prezzo devono essere effettuati dall'Acquirente nei termini e con le modalità previsti nella conferma d'ordine presso il domicilio del Venditore. I pagamenti fatti dall'Acquirente a procuratori e/o agenti senza una procura specifica non saranno opponibili al Venditore.

In caso di ritardo nei pagamenti, l'Acquirente sarà tenuto al pagamento degli interessi moratori pari al tasso della Banca Centrale Europea in vigore a quella data, maggiorato di 7 (sette) punti, salvo in ogni caso la facoltà per il Venditore di chiedere il risarcimento del maggior danno subito.

L'Acquirente non potrà per qualunque motivo, salvo autorizzazione scritta, compensare o trattenere somme dovute al venditore, né potrà sospendere i pagamenti.

I prezzi dei prodotti si intendono in Euro e non comprendono IVA, imballo, spese di trasporto e assicurazione. Il Venditore può modificare i prezzi e le tariffe in vigore in ogni momento e senza preavviso, salvo per gli ordini in corso. Ciò se si verificano rincari delle materie prime, della manodopera, dei trasporti, dei premi d'assicurazione, etc.

4. TERMINI DI CONSEGNA E RESA

Se non diversamente stabilito nella conferma d'ordine, le forniture dei prodotti si intendono per merce resa secondo Incoterms 2010: FCA Orbassano. La merce viaggia sempre per conto e rischio dell'Acquirente.

I termini di consegna si intendono indicativi e in caso di ritardo l'Acquirente non ha il diritto di richiedere la risoluzione del contratto e/o il risarcimento dei danni.

5. RISERVA DI PROPRIETÀ

I prodotti consegnati restano di proprietà del Venditore fino al completo pagamento del relativo prezzo.

L'Acquirente avrà il diritto di vendere i prodotti acquistati, o i nuovi prodotti in cui i prodotti fornitigli dal Venditore siano stati incorporati, fermo restando che in tal caso tutti i proventi verranno trasferiti al Venditore fino alla concorrenza del prezzo dovuto dall'Acquirente al Venditore per la fornitura di tali Prodotti.

Tale diritto di vendere i prodotti decade qualora l'Acquirente sia rimasto inadempiente all'obbligo di pagamento per un periodo di tempo superiore a 20 (venti) giorni lavorativi rispetto alla scadenza. A tal fine, sarà onere del Venditore comunicare per iscritto all'Acquirente la revoca del diritto a vendere. L'Acquirente dovrà porre in essere ogni misura necessaria per la protezione dei prodotti oggetto della riserva di proprietà, nonché ogni misura per non confondere i prodotti del Venditore con i prodotti di altri fornitori e conservare i prodotti del Venditore in spazi ben delimitati e facilmente individuabili.

6. RESPONSABILITÀ DEL VENDITORE E LIMITI

Il Venditore è esclusivamente responsabile della corretta produzione dei prodotti forniti, che dovranno avere le caratteristiche previste nella conferma d'ordine del Venditore. Il Venditore non assume, invece, alcuna responsabilità per l'eventuale difettoso funzionamento di macchine o sistemi realizzati dall'Acquirente con i prodotti forniti dal Venditore.

I prodotti devono essere installati in modo appropriato solo da tecnici competenti e qualificati, conformemente alle specifiche del veicolo e rispettando i requisiti delle normative nazionali.

In ogni caso, l'Acquirente non potrà chiedere il risarcimento dei danni per mancato profitto, perdita di produzione, perdita di immagine, fermo dell'autoveicolo.

La responsabilità del Venditore è, comunque, limitata al valore della merce fornita, salvo dolo o colpa grave ai sensi di legge.

7. FORZA MAGGIORE

Qualora il Venditore sia impossibilitato a rispettare il contratto per cause di forza maggiore o comunque indipendenti dalla sua volontà, i termini previsti per l'esecuzione della fornitura sono automaticamente prorogati per un periodo equivalente al perdurare degli effetti dell'evento di forza maggiore. A tal fine, sono da considerarsi cause di forza maggiore, ai fini esplicativi e non esaustivi: carenza di energia o di materie prime, scioperi, provvedimenti della pubblica amministrazione, impedimenti alla circolazione o alle attività produttive.

8. RECLAMI ed ACCETTAZIONE DEI PRODOTTI

Qualsiasi reclamo relativo alla non conformità delle merci consegnate o per danni conseguenti al trasporto o per eventuali quantità mancanti rispetto ai prodotti ordinati dovrà essere comunicato per lettera raccomandata con avviso di ricezione indirizzata direttamente al venditore entro 8 (otto) giorni dalla data di consegna dei Prodotti, in caso di vizi palesi ed entro 8 (otto) giorni dalla scoperta in caso di vizi occulti, e, comunque, entro un mese dalla consegna, con una dettagliata esposizione dei fatti. In difetto, gli importi fatturati si intenderanno, a tutti gli effetti, accettati e non più contestabili dall'Acquirente. Non si accettano rese delle merci se non preventivamente autorizzate per iscritto dal Venditore.

9. CONFORMITÀ ALLE SPECIFICHE E TERMINI DI GARANZIA

Il Venditore garantisce che i prodotti saranno conformi alle specifiche tecniche dichiarate dal Venditore stesso all'Acquirente nella conferma d'ordine e detta garanzia avrà validità per 2 (due) anni decorrenti dalla data di consegna dei prodotti e, per i prodotti o componenti sostituiti, dal giorno della loro sostituzione.

Nel periodo di garanzia, il Venditore al quale l'Acquirente abbia denunciato i difetti, si impegna, a sua scelta, entro un termine ragionevole, a riparare o sostituire gratuitamente i prodotti o le parti di esse che fossero risultati difettosi. Le spese e i rischi per il trasporto dei prodotti risultati difettosi alla sede del Venditore sono a carico dell'Acquirente. I prodotti sostituiti restano di proprietà del Venditore.

La garanzia decade nel caso di utilizzo non conforme alla destinazione finale abituale dei prodotti o non prevista nei cataloghi del venditore oppure se i prodotti sono stati modificati o riparati senza l'autorizzazione del Venditore.

10. GARANZIA PER L'ADEGUATEZZA DEI PRODOTTI ALLE SOLE NORME UE

Il Venditore garantisce che i Prodotti saranno conformi alle norme dell'Unione europea (UE) a essi eventualmente applicabili.

Nessuna garanzia viene rilasciata dal Venditore in merito alla conformità di tali Prodotti con le norme e i regolamenti, ivi espressamente incluse le norme in tema di sicurezza e di antinfortunistica, in vigore nella nazione dell'Acquirente, ove questi risieda al di fuori della UE, o più in generale, in qualsivoglia nazione che non appartenga alla UE in cui i Prodotti forniti vengono utilizzati.

11. RISERVATEZZA E TUTELA DEI DATI

I documenti di qualsiasi natura forniti dal Venditore rimarranno di sua proprietà e non possono essere trasferiti a terzi o riprodotti. L'Acquirente si impegna, anche dopo la fine del contratto a non divulgare i segreti commerciali e le informazioni riservate che siano state al medesimo comunicati o dei quali venga a conoscenza nel corso del suo rapporto con il Venditore.

Il Venditore con le presenti dichiara che utilizzerà i dati personali trasferiti dal Cliente nel rispetto delle previsioni del codice italiano sulla privacy (Decreto Legislativo n. 196/03).

12. RISOLUZIONE DEL CONTRATTO

Il contratto di fornitura potrà essere risolto di diritto ai sensi dell'art. 1456 c.c. per effetto della semplice dichiarazione scritta del Venditore di avvalersi della presente clausola risolutiva espressa qualora l'Acquirente:

- Ometta o ritardi i pagamenti dovuti;
- Venga posto in liquidazione o sia stato assoggettato ad una qualsiasi procedura concorsuale.

13. PROPRIETÀ INTELLETTUALE

Il Venditore conserva la proprietà intellettuale dei progetti, degli studi, dei disegni, dei modelli e dei prodotti che realizza o che vengono realizzati a suo nome e per suo conto. I marchi sotto quali i prodotti sono venduti non possono essere utilizzati dall'Acquirente se non per identificarli.

14. LEGGE APPLICABILE E MODALITÀ DI RISOLUZIONE DELLE CONTROVERSIE

Tutti i contratti con il Venditore saranno disciplinati dalla legge italiana. Qualsiasi controversia sarà devoluta alla competenza esclusiva del Foro di Torino.

Data: _____ Timbro, Nome Cognome e firma dell'Acquirente: _____

Ai sensi degli artt. 1341 e 1342 c.c. l'Acquirente dichiara di avere letto e approvato specificamente le previsioni contenute nei seguenti articoli delle condizioni generali: art. 3 Divieto di compensazione art. 5 Riserva di proprietà; art. 6 Limitazione della responsabilità; art. 8 Reclami ed accettazione dei Prodotti; art. 14 Modalità di risoluzione delle controversie.

Data: _____ Timbro, Nome Cognome e firma dell'Acquirente: _____

CONDITIONS GÉNÉRALES DE VENTES

1. DOMAINE D'APPLICATION ET EFFICACITÉ

Toutes les fournitures de produits effectuées par Facet S.r.l. (le « Vendeur ») à un client (l'« Acheteur ») sont régies par les présentes conditions générales qui l'emportent sur les conditions générales d'achat de l'Acheteur ainsi que sur les conditions particulières établies dans les offres et/ou confirmations de commande du Vendeur. En cas de contraste entre ce qui est exposé dans les conditions générales et dans les conditions particulières, ces dernières l'emporteront.

Les données et les illustrations relatives aux produits telles qu'elles figurent aux catalogues ou brochures du Vendeur ont un caractère indicatif et n'ont aucune valeur contraignante sauf disposition contraire expresse dans la confirmation de commande du Vendeur et elles sont susceptibles de modifications sans préavis concernant le dessin et le matériel.

Les codes originaux (OE) indiqués dans les catalogues ou dans autres documents sont mentionnés uniquement pour identifier les pièces de rechange. Le Vendeur livre seulement produits de propre production et avec propre code article et non produits avec codes OE.

2. FORMATION DU CONTRAT

Le contrat de fourniture sera finalisé par la confirmation écrite du Vendeur d'acceptation de la commande de l'Acheteur. Le Vendeur se réserve le droit de ne pas accepter de commande en cas de litige en cours avec le client concernant une commande précédente.

3. PRIX ET PAIEMENTS

Sauf si les parties n'en conviennent autrement, les paiements du prix doivent être effectués par l'Acheteur dans les délais et aux conditions établis dans la confirmation de commande au domicile du Vendeur. Les paiements effectués par l'Acheteur à des apporteurs d'affaires et/ou agents sans mandat spécifique ne seront pas opposables au Vendeur.

En cas de retard de paiement, l'Acheteur sera tenu de verser des intérêts de retard au taux de la Banque Centrale Européenne en vigueur à la date en question, majoré de 7 (sept) points, sans préjudice de la faculté du Vendeur de demander les dommages intérêts pour tout dommage ultérieur.

L'Acheteur ne pourra pas, pour quelque raison que ce soit, sauf autorisation écrite, compenser ou garder toute somme due au Vendeur et il ne pourra non plus suspendre les paiements.

Les prix des produits s'entendent en Euros et sont hors TVA, emballage, frais de transport et d'assurance. Le Vendeur peut modifier les prix et les tarifs en vigueur à n'importe quel moment et sans préavis, sauf pour les commandes en cours. Cela en cas de renchérissement des matières premières, de la main d'œuvre, des transports, des prix d'assurance, etc.

4. DÉLAIS DE LIVRAISON ET MISE À DISPOSITION

Sauf si les parties n'en conviennent autrement dans la confirmation de commande, les fournitures des produits s'entendent pour mise à disposition de la marchandise selon les Incoterms 2010: FCA Orbassano. La marchandise voyage toujours pour le compte et aux risques et périls de l'Acheteur.

Les délais de livraison sont indicatifs et en cas de retard l'Acheteur n'aura aucun droit de demander la résiliation du contrat et/ou les dommages-intérêts.

5. RÉSERVE DE PROPRIÉTÉ

Les produits livrés restent la propriété du Vendeur jusqu'au complet paiement du prix relatif.

L'Acheteur aura le droit de vendre les produits achetés, ou les nouveaux produits ayant intégré les produits fournis par le Vendeur, étant entendu qu'en ce cas-là tous les revenus seront transférés au Vendeur jusqu'à concurrence du prix dû par l'Acheteur au Vendeur pour la fourniture desdits Produits.

Ce droit de vendre les produits expire dès lors que l'Acheteur n'aurait pas accompli son obligation de paiement pour une période de plus de 20 (vingt) jours ouvrables à partir de l'échéance. À cet effet, il incombe au Vendeur d'informer par écrit l'Acheteur de la révocation du droit de vendre. L'Acheteur devra mettre en œuvre toute mesure nécessaire pour la protection des produits faisant l'objet de la réserve de propriété ainsi que toute mesure permettant de ne pas confondre les produits du Vendeur avec les produits d'autres fournisseurs et de garder les produits du Vendeur dans des espaces bien délimités et facilement identifiables.

6. RESPONSABILITÉ DU VENDEUR ET LIMITATIONS

Le Vendeur ne sera responsable que de la bonne production des produits fournis, qui devront avoir les caractéristiques indiquées dans la confirmation de commande du Vendeur. Par contre, le Vendeur ne prend aucune responsabilité concernant l'éventuel mauvais fonctionnement de machines ou systèmes réalisés par l'Acheteur avec les produits fournis par le Vendeur.

Les produits doivent être correctement installés seulement par des techniciens formés et qualifiés, conformément aux spécifications du véhicule et en respect des réglementations nationales.

De toute manière, l'Acheteur ne pourra pas demander de dommages-intérêts pour manque à gagner, perte de production, perte d'image, immobilisation du véhicule automobile.

La responsabilité du Vendeur est de toute manière limitée à la valeur de la marchandise fournie, sauf en cas de dol ou de faute grave aux termes de la loi.

7. FORCE MAJEURE

Au cas où le Vendeur serait empêché de respecter le contrat pour des raisons de force majeure ou de toute manière indépendantes de sa volonté, les délais prévus pour l'exécution de la fourniture seront automatiquement prorogés d'une période correspondant à la durée des effets de l'événement de force majeure. À cet effet, on entend pour raisons de force majeure, à titre purement explicatif et non exhaustif: pénurie d'énergie ou de matières premières, grèves, mesures de l'administration publique, entraves à la circulation ou aux activités productives.

8. RÉCLAMATIONS et ACCEPTATION DES PRODUITS

Toute réclamation pour la non conformité des marchandises livrées ou pour des dommages découlant du transport ou pour des quantités manquantes par rapport aux produits commandés devra être communiquée par lettre recommandée avec avis de réception adressée directement au Vendeur dans un délai de 8 (huit) jours de la date de livraison des Produits, en cas de vices apparents et dans un délai de 8 (huit) jours de la découverte de vices cachés et, de toute manière, dans le délai d'un mois de la livraison, accompagnée de l'exposition détaillée des faits. À défaut de cela, les montants facturés seront considérés acceptés, à tous les effets, et ne seront plus contestables par l'Acheteur.

Aucun retour de marchandises ne sera accepté sans l'autorisation préalable écrite du Vendeur.

9. CONFORMITÉ AUX SPÉCIFICATIONS ET TERMES DE GARANTIE

Le Vendeur garantit que les produits seront conformes aux spécifications techniques déclarées par le Vendeur même à l'Acheteur dans la confirmation de commande et ladite garantie sera valable pour 2 (deux) ans à partir de la date de livraison des produits et, pour les produits ou les composants remplacés, à partir du jour de leur remplacement.

Pendant la période de garantie, le Vendeur auquel l'Acheteur aurait dénoncé les défauts, s'engage, de son choix, à réparer ou remplacer gratuitement dans un délai raisonnable les produits ou leurs parties résultant défectueux. Les frais et les risques du transport chez le Vendeur des produits résultant défectueux sont à la charge de l'Acheteur. Les produits remplacés restent la propriété du Vendeur.

La garantie expire en cas d'utilisation non conforme à la destination finale habituelle des produits ou non prévue dans les catalogues du vendeur ou bien si les produits ont été modifiés ou réparés sans l'autorisation du Vendeur.

10. GARANTIE DE LA CONFORMITÉ DES PRODUITS AUX SEULES NORMES UE

Le Vendeur garantit que les Produits seront conformes aux normes de l'Union européenne (UE) qui leur seront éventuellement applicables.

Le Vendeur ne délivre aucune garantie concernant la conformité de ces Produits aux normes et règlements, y compris expressément les normes en matière de sécurité et accidents, en vigueur dans la nation de l'Acheteur, si ce dernier est résident en dehors de l'UE ou, plus en général, en quelque nation que ce soit n'appartenant pas à l'UE dans laquelle les Produits fournis sont utilisés.

11. CONFIDENTIALITÉ ET PROTECTION DES DONNÉES

Les documents de quelque nature que ce soit fournis par le Vendeur resteront sa propriété et ne pourront être transférés à des tiers ou reproduits. L'Acheteur s'engage, également après la fin du contrat, à ne pas divulguer à des tiers les secrets commerciaux ou les informations réservées lui ayant été communiqués et dont il viendrait à connaissance au cours de son rapport avec le Vendeur.

Par les présentes le Vendeur déclare qu'il utilisera les données personnelles communiquées par le Client dans le respect des dispositions du code italien en matière de confidentialité (Décret Législatif n. 196/03).

12. RÉSILIATION DU CONTRAT

Le contrat de fourniture pourra être résilié de plein droit aux termes de l'art.1456 du code civil par la simple déclaration écrite du Vendeur de se prévaloir de la présente clause résolutoire expresse dans les cas suivants :

- en cas de défaut ou de retard de paiement de l'Acheteur
- si l'Acheteur est mis en liquidation judiciaire ou a été soumis à une procédure collective.

13. PROPRIÉTÉ INTELLECTUELLE

Le Vendeur garde la propriété intellectuelle des projets, des études, des dessins, des modèles et des produits qu'il réalise ou qui sont réalisés en son nom ou pour son compte. Les marques sous lesquelles les produits sont vendus ne peuvent être utilisées par l'Acheteur que pour les identifier.

14. LOI APPLICABLE ET MODALITÉS DE RÈGLEMENT DES LITIGES

Tous les contrats avec le Vendeur seront régis par le droit italien. Tout litige sera soumis à la compétence exclusive du Tribunal de Turin.

Date: _____ Cachet, Prénom Nom et signature de l'Acheteur: _____

Aux termes des articles 1341 et 1342 du c.v. l'Acheteur déclare avoir lu et approuvé spécifiquement les dispositions des articles suivants des conditions générales : art. 3 Interdiction de compensation art. 5 Réserve de propriété; art. 6 Limitation de la responsabilité; art. 8 Réclamation et Acceptation des Produits; art. 14 Modalités de règlement des litiges.

Date: _____ Cachet, Prénom Nom et signature de l'Acheteur: _____

ALLGEMEINE VERKAUFSBEDINGUNGEN

1. GELTUNGSBEREICH UND WIRKSAMKEIT

Für alle Lieferungen von Produkten durch die Gesellschaft Facet S.r.l. (der "Verkäufer") an einen Kunden (der "Käufer") gelten die vorliegenden allgemeinen Verkaufsbedingungen, die vor den Einkaufsbedingungen des Käufers sowie den besonderen Bedingungen in den Angeboten und/oder Auftragsbestätigungen des Verkäufers Vorrang haben. Sollten Widersprüche zwischen dem Inhalt der allgemeinen Bedingungen und dem Inhalt der besonderen Bedingungen bestehen, sind Letztere vorrangig.

Die Daten und Abbildungen in Bezug auf die Produkte in den Katalogen oder Broschüren des Verkäufers sind Beispiele und haben keinen bindenden Wert, wenn dies in der Auftragsbestätigung des Verkäufers nicht ausdrücklich vorgesehen ist. Zudem können diese Daten und Abbildungen Änderungen am Design und Material unterliegen, ohne dass diese vorher angekündigt werden müssen.

Die angegebenen Originalnummern in Katalogen oder anderen Dokumenten sind nur zum Zwecke der Identifikation angegeben. Der Verkäufer liefert nur Produkte aus eigener Produktion, die mit Facet Artikel-Nrn. und nicht OE P/Nr. identifiziert sind.

2. ZUSTANDEKOMMEN DES VERTRAGS

Der Liefervertrag kommt zustande, wenn der Verkäufer die Auftragsannahme des Käufers schriftlich bestätigt. Der Verkäufer behält sich das Recht vor, Aufträge nicht anzunehmen, wenn Streitigkeiten mit einem Kunden in Bezug auf einen vorhergehenden Auftrag vorliegen.

3. PREISE UND ZAHLUNGEN

Unbeschadet anderslautender Vereinbarungen, sind die Zahlungen vom Käufer innerhalb der in der Auftragsbestätigung vorgesehenen Zahlungsfristen und Modalitäten am Geschäftssitz des Verkäufers zu leisten. Zahlungen, die vom Käufer an Vermittler und/oder Vertreter geleistet werden, können ohne eine Sondervollmacht nicht beim Verkäufer geltend gemacht werden.

Im Fall von verspäteten Zahlungen ist der Käufer verpflichtet, Verzugszinsen in Höhe des von der Europäischen Zentralbank festgelegten und zu jenem Datum geltenden Zinssatzes zu zahlen, die um 7 (sieben) Prozent erhöht werden. Unbeschadet davon bleibt das Recht des Verkäufers, einen größeren Schaden geltend zu machen.

Der Käufer ist nicht befugt, aus welchem Grund auch immer, Summen, die dem Verkäufer zustehen, zu verrechnen oder einzubehalten oder die Zahlungen einzustellen, es sei denn, dies wurde schriftlich genehmigt.

Die Preise für die Produkte sind in Euro und ohne Mehrwertsteuer, Verpackung, Transportkosten und Versicherung angegeben. Der Verkäufer kann jederzeit geltende Preise und Tarife ohne Vorankündigung ändern. Dies gilt nicht für laufende Aufträge. Solche Änderungen können vorkommen, wenn sich die Preise für Rohstoffe, die Löhne, die Transportkosten und Versicherungspolice usw. erhöhen.

4. LIEFERFRISTEN UND WARENRÜCKNAHME

Insofern nicht anders in der Auftragsbestätigung vereinbart, erfolgt die Lieferung der Produkte nach den Incoterms 2010: FCA (frei Frachtführer) Orbassano. Die Ware wird stets im Namen und auf Risiko des Käufers transportiert.

Die Lieferfristen verstehen sich als Richtzeiten. Im Fall von Verspätungen ist der Käufer nicht berechtigt, die Auflösung des Vertrags und Schadensersatz geltend zu machen.

5. EIGENTUMSVORBEHALT

Die gelieferten Produkte bleiben bis zur vollständigen Bezahlung des entsprechenden Preises Eigentum des Verkäufers.

Der Käufer ist berechtigt, die erworbenen Produkte oder neue Produkte, in welche die gelieferten Waren eingefügt werden, weiterzuveräußern, vorausgesetzt, dass alle Erträge in diesem Fall an den Verkäufer gehen, bis diese den Preis erreichen, den der Käufer dem Verkäufer für die Lieferung dieser Produkte schuldig ist.

Sollte der Käufer seiner Zahlungspflicht länger als 20 (Zwanzig) Arbeitstage nach Fälligkeit der Zahlung nicht nachkommen, verfällt dieses Recht auf Weiterveräußerung der Produkte. Diesbezüglich obliegt es dem Verkäufer, dem Käufer den Widerruf des Rechts auf Weiterveräußerung schriftlich mitzuteilen. Der Käufer muss jede notwendige Maßnahme zum Schutz der Produkte, die dem Eigentumsvorbehalt unterliegen, sowie alle Maßnahmen umsetzen, damit die Produkte des Verkäufers nicht mit denen anderer Lieferanten verwechselt werden. Der Käufer muss die Produkte des Verkäufers in abgegrenzten und leicht erkennbaren Bereichen aufbewahren.

6. HAFTUNG DES VERKÄUFERS UND BESCHRÄNKUNGEN

Der Verkäufer ist ausschließlich für die ordnungsgemäße Herstellung der gelieferten Produkte verantwortlich. Die gelieferten Produkte müssen die in der Auftragsbestätigung des Verkäufers vorgesehenen Merkmale aufweisen. Hingegen übernimmt der Verkäufer keinerlei Haftung für den eventuellen mangelhaften Betrieb der Maschinen oder Systeme, die mit den vom Verkäufer gelieferten Produkten realisiert worden sind.

Die Produkte müssen in angemessener Weise nur von zuständigen und qualifizierten Technikern verbunden sein und müssen nach den Bestimmungen der nationalen Vorschriften den Angaben des Fahrzeugs entsprechen.

In jedem Fall kann der Käufer keinen Schadensersatz für Profitausfall, Produktionsausfall, Verlust des Images und Stillstand des Kraftfahrzeugs geltend machen.

Die Haftung des Verkäufers beschränkt sich nur auf den Wert der gelieferten Ware unter Vorbehalt des Vorsatzes und des groben Verschuldens im Sinne des Gesetzes.

7. HÖHERE GEWALT

Sollte es dem Verkäufer unmöglich sein, den Vertrag aufgrund von höherer Gewalt oder von Ereignissen, die nicht von ihm zu vertreten sind, einzuhalten, dann werden die Fristen für die Ausführung der Lieferung automatisch um die Dauer der Ereignisse verlängert. Diesbezüglich sind rein beispielhaft ohne Anspruch auf Vollständigkeit als Gründe für höhere Gewalt anzusehen: Stromausfall, Mangel an Rohstoffen, Streiks, Maßnahmen der öffentlichen Verwaltung, Störungen im Straßenverkehr oder Produktionsstörungen.

8. REKLAMATIONEN und ANNAHME DER PRODUKTE

Alle Reklamationen in Bezug auf die Nichtkonformität der gelieferten Ware, Schäden durch den Transport oder eventuell fehlende Mengen gegenüber der bestellten Produktmenge müssen dem Verkäufer direkt und per Einschreiben mit Rückschein mitgeteilt werden. Diese Mitteilung muss bei offensichtlichen Mängeln innerhalb von 8 (acht) Tagen ab dem Lieferdatum und bei versteckten Mängeln innerhalb von 8 (acht) Tagen ab dem Datum, an dem diese entdeckt worden sind, und in jedem Fall innerhalb eines Monats nach Lieferung der Produkte erfolgen und eine ausführliche Beschreibung der Mängel enthalten. Mangels dieser Mitteilung werden die abgerechneten Beträge mit voller Rechtswirksamkeit als angenommen angesehen und können vom Käufer nicht mehr beanstandet werden. Warenrücknahmen werden nicht angenommen, wenn diese nicht vorher vom Verkäufer genehmigt wurden.

9. ÜBEREINSTIMMUNG MIT DEN SPEZIFIKATIONEN UND GARANTIEBEDINGUNGEN

Der Verkäufer garantiert, dass die Produkte mit den technischen Spezifikationen übereinstimmen, die der Verkäufer in der Auftragsbestätigung für den Käufer angegeben hat. Die genannte Garantie gilt 2 (zwei) Jahre ab dem Datum der Lieferung der Produkte. Für die ersetzten Produkte oder Bestandteile gilt die Garantie ab dem Tag der Auswechslung.

Während der Garantiezeit verpflichtet sich der Verkäufer, die mangelhaften Produkte oder Teile davon innerhalb einer angemessenen Zeit wahlweise kostenlos zu reparieren oder zu ersetzen, wobei der Käufer dem Verkäufer diese Mängel mitzuteilen hat. Die Kosten und Risiken des Transports der mangelhaften Produkte an den Sitz des Verkäufers gehen zulasten des Käufers. Die ersetzten Produkte bleiben Eigentum des Verkäufers.

Die Garantie erlischt, wenn die Verwendung nicht mit dem bestimmungsgemäßen Gebrauch oder mit den in den Katalogen des Verkäufers vorgesehenen Gebrauch der Produkte übereinstimmt. Die Garantie erlischt ebenfalls, wenn die Produkte ohne die Genehmigung des Verkäufers verändert oder repariert wurden.

10. GEWÄHRLEISTUNG IN BEZUG AUF DIE ÜBEREINSTIMMUNG DER PRODUKTE MIT DEN EU-NORMEN

Der Verkäufer garantiert, dass die Produkte mit den eventuell anwendbaren Normen der Europäischen Union (EU) übereinstimmen.

Für die Übereinstimmung dieser Produkte mit Normen und Richtlinien, die im Land des Käufers gelten, sollte dieser seinen Sitz außerhalb der EU haben, oder allgemein die in jedem Land außerhalb der EU gelten, in dem die gelieferten Produkte verwendet werden, übernimmt der Verkäufer keine Garantie. Von der Garantie ausgeschlossen sind ausdrücklich die Normen über Sicherheit und Unfallverhütung.

11. VERTRAULICHKEIT UND DATENSCHUTZ

Dokumente jeder Art, die vom Verkäufer bereitgestellt werden, bleiben in dessen Besitz und dürfen nicht an Dritte weitergegeben oder vervielfältigt werden. Der Käufer verpflichtet sich, auch nach Vertragsende keine Geschäftsgeheimnisse und vertrauliche Informationen weiterzugeben, oder von deren er im Lauf der Beziehungen mit dem Verkäufer Kenntnis erlangt hat. Der Verkäufer erklärt hiermit, die vom Kunden angegebenen sensiblen Daten unter Einhaltung der Bestimmungen im italienischen Datenschutzkodex (Legislativdekret Nr. 196/03) zu behandeln.

12. AUFLÖSUNG DES VERTRAGS

Der Liefervertrag kann im Sinne von Art. 1456 des ital. ZGB („codice civile“) durch die einfache schriftliche Erklärung des Verkäufers, dass er von dieser ausdrücklichen Aufhebungs Klausel Gebrauch machen will, von Rechts wegen aufgehoben werden, wenn der Käufer:

- die fälligen Zahlungen unterlässt oder verspätet leistet;
- der Liquidation oder einem beliebigen Konkursverfahren unterzogen wird.

13. GEISTIGES EIGENTUM

Die Rechte am geistigen Eigentum in Bezug auf Projekte, Forschungen, Zeichnungen, Modelle und Produkte, die der Verkäufer realisiert oder die in seinem Namen und auf seine Rechnung realisiert werden, verbleiben beim Verkäufer. Die Marken, unter denen die Produkte verkauft werden, dürfen vom Käufer nur verwendet werden, um diese erkenntlich zu machen.

14. ANWENDBARES GESETZ UND MODALITÄTEN ZUR BEILEGUNG VON STREITIGKEITEN

Alle Verträge mit dem Verkäufer werden vom italienischen Gesetz geregelt. Alle Streitigkeiten werden der ausschließlichen Zuständigkeit des Gerichtsprengels in Turin zugewiesen.

Datum: _____ Stempel, Vor- und Zuname und Unterschrift des Käufers: _____

Der Käufer erklärt im Sinne der Art. 1341 und 1342 des ital. ZGB („codice civile“), die in den folgenden Artikeln der allgemeinen Verkaufsbedingungen enthaltenen Bedingungen gelesen zu haben und diese ausnahmslos anzunehmen: Art. 3) Verrechnungsverbot, Art. 5) Eigentumsvorbehalt, Art. 6) Haftungsbeschränkung, Art. 8) Reklamationen und Annahme der Produkte, Art. 14) Modalitäten zur Beilegung von Streitigkeiten.

Datum: _____ Stempel, Vor- und Zuname und Unterschrift des Käufers: _____

CONDICIONES GENERALES DE VENTA

1. AMBITO DE APLICACIÓN Y EFICACIA

Todas las entregas de productos efectuadas por Facet S.r.l. (el "Vendedor") a un cliente (el "Comprador") se regirán por las presentes condiciones generales que prevalecerán sobre las condiciones de adquisición del Comprador, así como las condiciones particulares previstas en las licitaciones y/o confirmación de pedido del Vendedor. En caso de conflicto entre lo estipulado en las condiciones generales y en las condiciones particulares, prevalecerán estas últimas.

Los datos y las ilustraciones referidas a los productos resultantes de los catálogos o prospectos del Vendedor tienen carácter indicativo y no valor vinculante, salvo lo dispuesto expresamente en la confirmación del pedido por parte del vendedor y pueden ser sujetos a modificaciones de diseño y material sin previo aviso.

Los números originales (OE) indicados en los catálogos o en otros documentos sólo son mencionados para identificar las partes de repuesto.

El vendedor suministra únicamente los productos de su propia producción contrasignados con su propio código de artículo y no productos con los números OE.

2. FORMALIZACIÓN DEL CONTRATO

El contrato de suministro se perfecciona con la confirmación escrita del Vendedor de aceptación del pedido del Comprador. El Vendedor se reserva el derecho de no aceptar pedidos en el caso que haya una controversia con el cliente relativa a un pedido anterior

3. PRECIOS Y FORMAS DE PAGO

Salvo pacto en contrario, los pagos del precio deben ser efectuados por el Comprador en los términos y con la modalidad prevista en la confirmación del pedido en la dirección del Vendedor. Los pagos realizados por el Comprador a Corredores de Comercio y/o Agentes sin un poder legal específico no tendrán fuerza ejecutiva contra el Vendedor.

En caso de retraso en los pagos, el Comprador deberá abonar los intereses de demora iguales a los establecidos por el Banco Central Europeo en vigor en la fecha, más 7 (siete) puntos, reservándose en cada caso la facultad el Vendedor de pedir daños y perjuicios.

El Comprador no podrá, por ningún motivo, salvo autorización escrita, compensar o retener cantidades adeudadas al Vendedor, ni podrá suspender los pagos.

Los precios de los productos se entienden en Euros y no incluyen el IVA, embalaje, gastos de transporte o seguro. El Vendedor podrá modificar los precios y las tarifas en vigor en cada momento sin previo aviso, salvo en el caso de los pedidos en curso. Es decir, si se verifican recargos en las materias primas, mano de obra, en los transportes, en las primas de seguros, etc.

4. CONDICIONES DE ENTREGA Y DEVOCIONES

A menos que se disponga lo contrario en la confirmación del pedido, el suministro de los productos se entiende realizado conforme a la Incoterms 2010: FCA Orbassano. La mercancía viaja siempre por cuenta y riesgo del Comprador.

Los plazos de entrega se entienden indicativos y en caso de retraso, el Comprador no tiene derecho a solicitar la resolución del contrato y/o el resarcimiento de los daños.

5. RESERVA DE PROPIEDAD

Los productos suministrados permanecerán de propiedad del Vendedor hasta el pago total del precio.

El Comprador tendrá el derecho de vender los productos adquiridos, o nuevos productos en los que los productos suministrados por el Vendedor hayan sido incorporados, salvo que en este caso, todos los ingresos serán transferidos al Vendedor hasta el total del precio debido al Vendedor por el Comprador por el suministro de tales Productos.

Tal derecho de vender los productos decae si el Comprador no ha cumplido la obligación de pago durante un periodo de tiempo superior a 20 (veinte) días laborables desde la fecha límite. A tal fin, será potestad del Vendedor comunicar por escrito al Comprador la revocación del derecho a vender. El Comprador deberá tomar todas las medidas necesarias para la protección de los productos objeto de la reserva de propiedad, así como las medidas para no confundir los productos del Vendedor con los productos de otros proveedores y conservar los productos del Vendedor en espacios bien delimitados y fácilmente individualizables.

6. RESPONSABILIDAD DEL VENDEDOR Y LIMITACIONES

El Vendedor es exclusivamente responsable de la correcta producción de los productos suministrados, que deberán tener las características previstas en la confirmación del pedido por parte del Vendedor. Sin embargo, el Vendedor no asume, ninguna responsabilidad por el eventual mal funcionamiento de equipos o sistemas realizados por el Comprador con los productos suministrados por el Vendedor.

Los productos deben ser instalados solamente por técnicos competentes y cualificados, en conformidad con las especificaciones del vehículo y cumpliendo con los requisitos de las normativas nacionales. En cualquier caso, el Comprador no podrá reclamar el resarcimiento de los daños y perjuicios por el lucro cesante, pérdida de producción, daños de imagen o parada de vehículo.

La responsabilidad del Vendedor es, por lo tanto limitada al valor de la mercancía suministrada, salvo dolo o culpa grave de conformidad con la ley.

7. LA FUERZA MAYOR

Si el Vendedor no puede cumplir el contrato por causa de fuerza mayor o cualquier circunstancia ajena a su voluntad, los plazos previstos para la ejecución de la oferta son automáticamente prorrogados por un periodo equivalente al de los efectos del evento de fuerza mayor. A tal fin, son consideradas causas de fuerza mayor, con fines explicativos y no exhaustivos: ausencia de energía o de materias primas, huelgas, medidas de la Administración Pública, obstáculos en la circulación, o en las actividades productivas.

8. RECLAMACIONES y ACEPTACIÓN DE LOS PRODUCTOS

Toda reclamación relativa a la no conformidad de las mercancías consignadas o por daños debidos al transporte o por eventuales faltas de cantidad respecto a los productos encargados debe ser comunicada por carta registrada con acuse de recibo dirigida directamente al vendedor en los 8 (ocho) días desde la fecha de entrega de los Productos, en el caso de vicios ocultos y dentro de los 8 (ocho) días desde el descubrimiento y dentro del mes siguiente de la entrega, con una exposición detallada de los hechos. En su defecto, los importes facturados se entenderán, a todos los efectos, aceptados y no cuestionables por el Comprador.

No se aceptan productos devueltos si no han sido previamente autorizados por escrito por el Vendedor.

9. CONFORMIDAD DE LAS ESPECIFICACIONES Y CONDICIONES DE GARANTÍA

El Vendedor garantiza que los productos serán conformes a las especificaciones técnicas declaradas por el Vendedor mismo al Comprador en la confirmación del pedido y dicha garantía tendrá validez de 2 (dos) años desde la fecha de la consigna de los productos y para los productos o componentes en sustitución, desde la fecha de sustitución.

Durante el periodo de garantía, el Vendedor al que el Comprador haya denunciado los defectos, se compromete, a su elección, dentro de unos términos razonables, a reparar o sustituir gratuitamente los productos o las partes de los mismos que hubieran resultado defectuosos. Los costes y los riesgos debidos al transporte de los productos defectuosos a la sede del Vendedor, son a cargo del Comprador. Los productos sustituidos quedan de propiedad del Vendedor.

La garantía no es válida en el caso de uso no conforme al destino final habitual de los productos o no prevista en los catálogos del vendedor o incluso si los productos han sido modificados o reparados sin la autorización del Vendedor.

10. GARANTÍA DE ADECUACIÓN DE LOS PRODUCTOS A LAS NORMAS UE

El Vendedor garantiza que los Productos serán conformes a las normas de la Unión Europea (UE) y pueden eventualmente ser aplicables.

No existe ninguna garantía del Vendedor en relación a la conformidad de estos Productos con las normas y regulaciones, fuera de las expresamente incluidas en las normas relativas a la seguridad y prevención de accidentes, en vigor en el país del Comprador, cuando este tenga su residencia fuera de la UE, o más en general, en cualquier nación que no pertenezca a la UE en la que los Productos suministrados vengán siendo utilizados.

11. CONFIDENCIALIDAD Y PROTECCIÓN DE DATOS

Los documentos de cualquier naturaleza facilitados por el Vendedor permanecerán de su propiedad y no podrán ser transferidos a terceros o reproducidos. El Comprador se compromete, incluso después de la finalización del contrato a no divulgar los secretos comerciales y las informaciones confidenciales que le hayan sido comunicadas o de las cuales tenga conocimiento en el transcurso de su relación con el Vendedor.

El Vendedor con la presente declara que usará los datos personales transferidos por el Cliente con el respeto a lo establecido en el Código de Privacidad Italiano (Decreto Legislativo n. 196/03)

12. RESOLUCIÓN DEL CONTRATO

El contrato de suministro podrá ser resuelto conforme a derecho según el art. 1456 C.C. por medio de declaración simple por escrito del Vendedor haciendo uso de la presente cláusula de rescisión si el Comprador:

- Omite o retrasa los pagos adeudados
- Se somete a liquidación o se encuentra sujeto a cualquier procedimiento concursal

13. PROPIEDAD INTELECTUAL

El Vendedor conserva la propiedad intelectual de los proyectos, de los estudios de los diseños, de los modelos y de los productos que realice o sean realizados en su nombre o por su cuenta. Las marcas bajo las cuales los productos son vendidos no pueden ser usadas por el Comprador salvo para identificarlos.

14. LEYES APLICABLES Y MODOS DE RESOLUCIÓN DE LAS CONTROVERSIAS

Todos los contratos con el Vendedor serán sometidos a la legislación italiana. Cualquier controversia será resuelta por la jurisdicción exclusiva del Foro de Turín.

Fecha: _____ Sello, Nombre y Apellido y firma del Comprador: _____

En el sentido de los arts. 1341 y 1342 C.C. el Comprador declara haber leído y aceptado específicamente las previsiones contenidas en los siguientes artículos de las condiciones generales: art. 3 Prohibición de compensación, art. 5 Reserva de la propiedad; art. 6 Limitación de la responsabilidad; art. 8 Reclamaciones y Aceptación de los Productos; art. 14 Modos de resolución de las controversias.

Fecha: _____ Sello, Nombre y Apellido y firma del Comprador: _____

OUR PACKAGING

EPS-IGN22Q1

-LE NOSTRE CONFEZIONI -NOTRE CONDITIONNEMENT -UNSERE VERPACKUNGSTYPEN -NUESTROS ENVASES

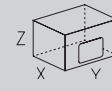

<p>1.970.543</p> <p>IGNITION COILS</p> <p>Adatti per/compatible:</p> <p>HYUNDAI 2.7 901 28010 KIA 2.7 901 28010</p> <p>ITEM NOW AVAILABLE FROM PRODUCTION</p> <p>-ARTICOLI NON DISPONIBILI PER LA VENDITA</p> <p>-ARTICLES DISPONIBLES EN PRODUCTION COURANTE</p> <p>-SETZ FÜR VERKÄUF/VERFÜGBARER ARTIKEL</p> <p>-ARTÍCULO NO DISPONIBLE EN PRODUCCION</p> <p>MARKET DIFFUSION: HIGH</p>  <p>0,81 5,60</p> <p>HYUNDAI ACCENT 1.6 G46C 11/10 -- ACCENT 1.6 G46C 11/10 -- CRETA 1.6 G46C 01/10 --</p>	<p>(A) Packaging size</p> <ul style="list-style-type: none"> • FORMATO CONFEZIONE • FORMAT DU CONDITIONNEMENT • VERPACKUNGSGRÖSSE • TAMAÑO DE ENVASE <p>Illustrated section</p> <ul style="list-style-type: none"> • PARTE FIGURATA • PARTIE ILLUSTRÉE • BILDTEIL BEISPIEL • PARTE ILUSTRADA 	<p>(A)</p>  <p>(mm) X x Y x Z</p>	<p>cm³</p>	<p>(B)</p> <p>Q / P15</p> <p>L589 X W389 X H299MM</p>	<p>(B)</p> <p>Q / P25</p> <p>L389 X W189 X H299MM</p>	<p>(B)</p> <p>Q / P35</p> <p>L389 X W189 X H149MM</p>	
		1	27 X 45 X 62	75	720	200	100
		3	40 X 46 X 98	180	360	90	20
		3,5	74 X 80 X 42	250	252	72	36
		04	77 X 97 X 74	550	120	36	18
		04,5	37 X 126 X 144	815	90	30	15
		05	97 X 128 X 74	920	72	21	9
		05,5	72 X 76 X 194	1060	60	12	-
		07	128 X 148 X 93	1760	36	12	5
		07,5	128 X 185 X 100	2370	27	9	3
		08	128 X 186 X 148	3520	18	6	-
		08,5	194 X 380 X 72	5300	12	-	-
		08,6	180 X 415 X 70	5220	8	-	-
		08,7	120 X 470 X 70	3950	13	-	-
		08,8	170 X 405 X 90	6200	6	-	-
		09	145 X 293 X 127	5400	12	-	-

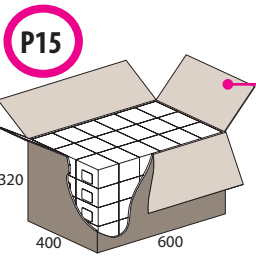

(B) Shipping box

- PACCO SPEDIZIONI
- COLIS D'EXPEDITION
- VERPACKUNG
- BULTO PARA EL DESPACHO



EPS

EPS

EPS

EPS

EPS

192 OBE

EPS

EPS

1.880.314

THERMOSTAT

OBE

8 012510 283509
FIAT
500329622 FIAT DUCATO 2.5 0 01/90
7303615 DUCATO 2.5 0 4x4 0
VALEO DUCATO 2.5 D Combi
819903 DUCATO 2.5 TD 01/90
820432 DUCATO 2.5 TD 4x4

MADE IN ITALY

1.953.344

SENSORS

OBE

1.953.344

SENSORS

OBE

8 012510 206669
BOSCH FIAT
0 232 103 033 DOBL0 1.2 01/01
0 232 103 039 DOBL0 1.6 16V 01/01
0 232 103 040 DOBL0 1.6 Natural 1
0 232 103 041 PANDA 1100 01/95 0
0 281 002 406 PANDA 1100 1.6 4x4

EPS

EPS

1.953.344

SENSORS

OBE

8 012510 206669
BOSCH FIAT
0 232 103 033 DOBL0 1.2 01/01
0 232 103 039 DOBL0 1.6 16V 01/01
0 232 103 040 DOBL0 1.6 Natural 1
0 232 103 041 PANDA 1100 01/95 0
0 281 002 406 PANDA 1100 1.6 4x4

EPS

1.953.344

SENSORS

OBE

8 012510 206669
BOSCH FIAT
0 232 103 033 DOBL0 1.2 01/01
0 232 103 039 DOBL0 1.6 16V 01/01
0 232 103 040 DOBL0 1.6 Natural 1
0 232 103 041 PANDA 1100 01/95 0
0 281 002 406 PANDA 1100 1.6 4x4

EPS

1.953.344

SENSORS

OBE

8 012510 206669
BOSCH FIAT
0 232 103 033 DOBL0 1.2 01/01
0 232 103 039 DOBL0 1.6 16V 01/01
0 232 103 040 DOBL0 1.6 Natural 1
0 232 103 041 PANDA 1100 01/95 0
0 281 002 406 PANDA 1100 1.6 4x4

EPS

1.953.344

SENSORS

OBE

8 012510 206669
BOSCH FIAT
0 232 103 033 DOBL0 1.2 01/01
0 232 103 039 DOBL0 1.6 16V 01/01
0 232 103 040 DOBL0 1.6 Natural 1
0 232 103 041 PANDA 1100 01/95 0
0 281 002 406 PANDA 1100 1.6 4x4

EPS

1.953.344

DISTRIBUTOR CARD

FIAT
DUNA 60 1.1 01/87 01/91
FIAT 70 1.3 01/84 01/91
FIAT 70 1.3 01/84 01/91
FIAT 70 1.3 01/84 01/91
FIAT 70 1.3 01/84 01/91
FIAT 70 1.3 01/84 01/91
FIAT 70 1.3 01/84 01/91
FIAT 70 1.3 01/84 01/91
FIAT 70 1.3 01/84 01/91
FIAT 70 1.3 01/84 01/91

OBE



EPS-TM Thermal management - Gestione Termica - Gestion thermique - ThermoManagement - Gestión térmica



EPS-IGN Ignition - Accensione - Allumage - Zündung - Encendido



EPS-SEN - Sensori - Capteurs - Sensoren - Sensores



EPS-SWI Switches - Interruttori - Interrupteurs - Shalter - Interruptores



EPS-EM Exhaust Management - Gestione Gas di Scarico - Gestion Des Gaz D'echappement - Abgas-Management - Gestión De Gas De Escape